

Technical and Bibliographic Notes / Notes techniques et bibliographiques

The Institute has attempted to obtain the best original copy available for filming. Features of this copy which may be bibliographically unique, which may alter any of the images in the reproduction, or which may significantly change the usual method of filming, are checked below.

L'Institut a microfilmé le meilleur exemplaire qu'il lui a été possible de se procurer. Les détails de cet exemplaire qui sont peut-être uniques du point de vue bibliographique, qui peuvent modifier une image reproduite, ou qui peuvent exiger une modification dans la méthode normale de filmage sont indiqués ci-dessous.

- Coloured covers/
Couverture de couleur
- Covers damaged/
Couverture endommagée
- Covers restored and/or laminated/
Couverture restaurée et/ou pelliculée
- Cover title missing/
Le titre de couverture manque
- Coloured maps/
Cartes géographiques en couleur
- Coloured ink (i.e. other than blue or black)/
Encre de couleur (i.e. autre que bleue ou noire)
- Coloured plates and/or illustrations/
Planches et/ou illustrations en couleur
- Bound with other material/
Relié avec d'autres documents
- Tight binding may cause shadows or distortion along interior margin/
La reliure serrée peut causer de l'ombre ou de la distorsion le long de la marge intérieure
- Blank leaves added during restoration may appear within the text. Whenever possible, these have been omitted from filming/
Il se peut que certaines pages blanches ajoutées lors d'une restauration apparaissent dans le texte, mais, lorsque cela était possible, ces pages n'ont pas été filmées.

- Coloured pages/
Pages de couleur
- Pages damaged/
Pages endommagées
- Pages restored and/or laminated/
Pages restaurées et/ou pelliculées
- Pages discoloured, stained or foxed/
Pages décolorées, tachetées ou piquées
- Pages detached/
Pages détachées
- Showthrough/
Transparence
- Quality of print varies/
Qualité inégale de l'impression
- Continuous pagination/
Pagination continue
- Includes index(es)/
Comprend un (des) index

Title on header taken from: /
Le titre de l'en-tête provient:

- Title page of issue/
Page de titre de la livraison
- Caption of issue/
Titre de départ de la livraison
- Masthead/
Générique (périodiques) de la livraison

Additional comments: /
Commentaires supplémentaires:

This item is filmed at the reduction ratio checked below /
Ce document est filmé au taux de réduction indiqué ci-dessous.

10X	12X	14X	16X	18X	20X	22X	24X	26X	28X	30X	32X
								✓			

THE CANADIAN
PATENT OFFICE RECORD

AND REGISTER OF COPYRIGHTS AND TRADE MARKS.



VOLUME XX.

OTTAWA:
GOVERNMENT PRINTING BUREAU.
1893.



VOLUME XX, 1892.—ANNUAL INDEX.

INDEX OF INVENTIONS.

Account book. Robert R. Barton	39,442	Ammonia engine and apparatus connected therewith. Joseph H. Campbell	38,408
Accumulator for electric light. Karl Kahabka	40,586	Ammunition belt. Frank M. Garland, et al.	40,275
Acid: see Tartaric acid.		Ampere volt potential controller. Henry A. Voelkner	40,033
Acid. Process of manufacturing phosphoric. Charles Glaser	38,335	Animal trap. Elliott Lewis	38,985
Action for piano fortes. James H. Phelps	40,637	Animal trap. George Andrews	39,036
Adding machine. Arthur E. Shattuck, et al.	39,276	Animal trap. John T. T. Kissinger, et al.	40,976
Adding machine. Joseph E. Blackshaw, et al.	38,089	Annunciator. Archibald H. Brintnell	39,081
Adhesive material for use on driving belts. Carl G. Thoenes, et al.	40,439	Anti-friction alloy. Charles B. Miller	38,657
Adjuster: see Switch tongue adjuster.		Anti-friction bearing. Seely W. Ashmead, et al.	39,702
Advertisements, &c. Apparatus for displaying. John S. Yule	39,738	Anti-friction bearings for journals and axles. Henry B. Williams, et al.	38,241
Advertisements. Method and apparatus for displaying. Henry Heath	38,308	Anti-friction bearings for vehicles. William J. Brewer	38,744
Advertising device: see Toy bank.		Anti-rattler: see Shaft support and anti-friction rattler.	
Advertising device. George Mann	41,109	Anti-rattler for thill couplings. Elihu Wilder	40,408
Advertising medium. Edward Harner	40,545	Anti-rattler for thill couplings. Harman Bunker, et al.	39,367
Advertising. Method of. Horace I. Martin	39,564	Anti-septic composition. Emma Farren	40,513
Aerator: see Cooler and aerator.		Anvil vice. George W. Harris	39,114
Aerator for milk. Joseph C. Thibault	39,086	Apple parer. Elmore H. Elliott	39,140
Aerator for milk. Lewis Jefferson Macy	38,090	Apple picker. Richard W. Anderson, et al.	41,257
Aerial navigating machine. Frederick W. Zimmer	39,665	Apple syrup. Conrad Lanz	39,029
Aerial tramway. Alfred H. DeCamp	38,306	Arc lamp. Addison G. Waterhouse	40,982
Affixer: see Stamp affixer.		Arc lamp. Elihu Thompson	39,935
Aging liquors. Process of and apparatus for. Julian A. H. Hasbrouck	38,058	Arc lamp. James J. Wood	41,301
Agitator for mixed paint. Charles J. McLellan	41,248	Arc lamp. LaMotte C. Atwood	39,860
Air and gas compression pump. Edward G. Shortt	39,372	Arc lamp. Luther H. Buchanan	41,241
Air and water. Machinery for compressing and accumulating. George Goodlet	41,159	Arc lamp. Ralph H. Beach	40,625
Air brake. Christopher R. James	41,051	Arc lamp. Samuel P. Parmly	40,026
Air brake. Frank Lansberg	40,652	Arc lamp. Thomas P. C. Crampton, et al.	40,136
Air brake. Herbert McNulta	40,146	Arc lamp. William D. Graves, et al.	40,289
Air brake. Samuel E. St. O. Chapleau	39,014	Arc lamp. William E. Irish	40,524
Air brake. William E. Maher	40,303	Arc lamp. William Hockhausen	39,940
Air cock. Ovide Parent	41,395	Armature: see Ring armature.	
Air compressor. Addison C. Rand, et al.	41,094	Armature for dynamo electric machines. Sidney H. Short	41,218
Air compressor. Arthur O'Brien	41,102	Armature for dynamo electric machines and motors. Frank Bankson Rae, et al.	38,170
Air compressor. William R. Phillips	39,106	Armature for dynamos or electric motors. Barron D. Southard	41,435
Air pump. Allen A. Dittmar, et al.	40,400	Armature for electric motors. James F. McLaughlin	41,258
Air supplying device for gas machines. Edgar B. Badlam	41,254	Arm rest for telephones. Joseph R. Bailey, et al.	40,991
Air valve. Hippolyte J. Laforce	41,285	Arms: see Breech loading small arms.	
Air valve for drain pipes. Ezra S. McClellan	39,957	Arrestor: see Section insulator and lightning arrestor. Smoke arrestor. Spark arrestor.	
Alarm: see Burglar alarm. Electric alarm. Electric boiler alarm. Electric heat alarm. Electric liquid alarm. Electric show case alarm. High and low water alarm. Fire alarm. Low water alarm. Water feed regulator and low water alarm.		Arrestor for lightning. Elihu Thompson	39,815
Alarm. John Vaughan, et al.	38,854	Arrestor for sparks. John Thornton	40,131
Alarm knob. Edward C. Garlick	38,739	Artificial fuel. George Y. Smith	39,799
Alloy: see Aluminium alloy, anti-friction alloy.		Artificial fuel. John A. Scott	40,536
Alloy. William J. Miles	38,514	Artificial fuel. Max Nirdlinger	39,812
Alloys. Method of making. Frederick W. Martino	39,950	Artificial sponge. Walter M. Taylor	41,133
Alphabet of sounds. Thomas Anderson	40,674	Artificial stone. Cranston A. Stark	38,617
Altar: Household altar.		Artificial stone. Edward Gallagher	39,302
Alternate current electric train system. Charles J. Van Depeole	38,558	Artificial stone. George M. Graham	40,518
Alternate current induction motor. Charles J. Van Depeole	38,556	Artificial stone. Joseph E. Keseling, et al.	41,255
Alternate electric current. Michael Von Dolivo Dobrowsky	38,879	Artificial stone. Compound for making. Joseph E. Keseling, et al.	40,576
Alternating electric current motor. William B. Brain, et al.	38,458	Asphaltum. Jesse Adams Dubbs	38,929
Aluminium alloy. John W. Langley	39,402	Asphaltum. Method of making. Jesse A. Dubbs	41,101
		Atomizer. Herley M. Dunlap	40,641
		Auger: see Earth auger.	
		Autographic register. John B. Thies, et al.	38,199
		Autographic register. John Kirby, et al.	39,128
		Autographic telegraph. Harry Etheridge	39,753
		Automatic fastener. Jacob Sterns	41,063
		Automaton: see Coin operated automaton.	38,868
		Axe. Benjamin Beck	38,632
		Axe. Michael Ledue, et al.	
		Axle: see Vehicle axle.	39,009
		Axle. Adolphe Hoefler, et al.	

Axle. James T. Miller, et al.	40,213	Bell: see Door bell.	
Axle. Karl H. Dickmann	40,694	Bell buoy. Jasper Gibson	40,560, 40,561
Axle attachment for carriage wheels. Andrew Folsom	38,967	Belt: see Driving belt. Electric belt. Founcee and belt.	
Axle cutter. John Swegles, et al.	39,732	Belt. Joseph Tynan	40,961
Axle gage. Hector McQuarry, et al.	38,577	Belt. Electro galvanic. Duane P. Andrus	38,987
Axle nut for vehicles. Joseph L. House, et al	41,017	Belt fasteners. Process of and die for making. Gilbert P. Kencham.	39,927
Axle skein. Pierre Dansereau	38,587	Belt tightener. Carl Jernander	39,105
Axles or shafts. Method of making. Charles Lock	39,856	Belting. Adorf L. Lounerberg	41,427
Baby carriage, chair and cradle. Samuel Lazarus, et al.	38,928	Belting. Robert Cowen	40,540
Baby walker. Margaret Hoyer	41,318	Bending electrotype plates. Patrick M. Furlong	40,298
Back: see Pew back.		Bending machinery. Everett L. Booher	39,849
Bag: see Knitted bag. Moth proof bag.		Bicycle. Frederick J. H. Hazard	39,543
Bag. William A. Lorens, et al.	38,707	Bicycle. James H. Mathews	38,044
Bag containing material for poultices. Edward Kent	38,817	Bicycle. Jesse Anthony, et al.	40,554
Bag filler. Thomas Craney	38,635	Bicycle. Robert W. Shannon	41,046
Bag holder. Nelson R. Streeter	40,483	Bicycle. Siegmund Orback	40,034
Bag lock. Hector McKinnon	40,344	Bicycles, etc. Arthur J. Battersby	41,259
Bags, &c. Device for tying. Madison C. Kimball, et al.	38,374	Bicycles. Driving attachments for. Edwin Bradshaw	40,664
Bags. Machine for making paper. Arthur L. Stevens et al.	39,984	Bicycles. Supports for. Frederick H. Kinder	39,221
Bags. Machine for making paper. Frank L. Baker	41,045	Bicycles. Water attachment for. Frank W. Whiteman	40,852
Bags. Machine for making paper. James West	41,135	Bill file. Edwin B. Putney	39,939
Bags. Machine for printing paper. Robert E. Stuart	40,231	Bill file. William O. Gottwals, et al.	40,300
Baggage truck. William M. Gordon	39,448	Bin for street sweepings. Percival W. St. George	38,566
Bail and ear for pails, &c. Lewis Newell Lusk	38,050	Binder: see Grain binder. Harvester binder. Temporary binder.	
Bait: see Spoon bait.		Binder. Abram G. Reuman	40,184
Baker: see Boiler and baker.		Binder. Earl G. Watrous	40,341
Baking pan. Conrad Shifferly, et al	38,855	Binder for loads. Joseph H. Johnson	38,345
Baking powder. Charles A. Catlin	39,962	Biscuits. Composition for their manufacture. Norman Gentle	39,018
Balance: see Sash balance.		Bi-sulphate of lime. Apparatus for making. William H. Howell	39,593
Balance lock for water ways. Chauncey N. Dutton	39,615	Bit: see Bridle bit.	
Bale tie. John Y. Ranklin	39,381	Bit stock. Leonarde McMarsh	39,559
Ball bearings. George F. Simonds	39,245	Bit stock. Oliver R. Alden	41,223
	39,245, 39,246, 39,247, 39,248, 39,249, 39,250,	Blacking. Tank and case for liquid. Arlington I. Farnum	39,220
	39,251	Blank for book cover protectors. William B. Harrison	39,333
Balls: see Ivory balls.		Blanket for horses. Harry W. Sisson	40,005
Balls. Machine for colouring and ornamenting rubber. Gustave L. Hille et al.	40,890	Blanket for horses. Samuel Latham	40,120
Balls. Method of winding. Simon W. Wardwell	41,098	Blasting. Magnetic electric machine for. Arden S. Fitch	40,306
Band and circular sawmill. Hans J. Andersen	39,873	Bleaching by electrolysis. Process and apparatus for. Albert E. Woolf, et al.	39,785
Band cutter. John P. Monnett	40,920	Blind: see Window blind.	
Band cutter and feeder. Andrew Wemple, et al.	41,316	Blind for windows. William Z. Brown, et al.	40,354
Band cutter and feeder. Edmund S. Willite	40,960	Block: see Building block. Ceiling block. Heel block.	
Band cutter and feeder. William Plowright	39,649	Block signal apparatus. Thomas H. Petenall	40,973
Band cutter and feeder for threshing machines. Charles F. Graham	40,573	Blocking and measuring device. F. B. Edmand	41,137
Band saw machine. John Harley	39,903	Blotter: see Penholder and blotter.	
Band saw mill. Albert Cunningham	39,869	Blow gun. William M. Bunsen, et al.	40,659
Band saw mill. Charles M. Emerson	40,167	Blower: see Rotary engine, blower, &c.	
Band saw mill. James T. Milne, et al.	38,375	Blower and injector. Martin R. Ruble, et al.	38,743
Band saw mill. Isaac N. Kendall	38,825	Board: see Drip board. Pattern board. Ironing board.	
Band saw mill. Smith, Myers and Schmier	39,294	Boat raising and lowering device. Joseph Stephens, et al.	40,858
Bandage: see Suspensory bandage.		Boats. Machinery for manufacturing. Wm. Heslop	39,498
Bandages. Method of manufacturing. G. C. W. Breiger	39,664	Boats. Method of propelling and steering boats. John W. Williams	38,672
Bar: see Grate bar.		Bob-sleigh. John H. Weicher, et al.	41,015
Bar for watch chains. Charles Bolt	40,267	Bodies. Apparatus for lifting and lowering heavy. Adolph Prusmann	39,687
Barbwire. John D. Curtis	41,153	Body cooler and supporting frame therefor. Edwin B. Magill	40,446
Barrel. Clement Aitkens, et al.	41,047	Boiler: see Hot water boiler. Multi-tubular boiler. Steam-boiler. Wash boiler.	
Barrel. John J. Magee	41,406	Boiler and baker. George Milner, et al.	38,538
Barrel. Richard P. Blake	38,450	Boiler and furnace. George A. Ayer	39,723
Barrel closure. Clarence Webster Moore	39,027	Boiler and furnace therefor. Rudolph Muller	40,580
Barrel expander. Percy Little, et al.	40,856	Boiler and toaster. James Varley	38,315
Barrels. Machine for setting up. John Parker	38,094	Boiler for locomotives. Lewis W. Lester	41,243
Barrels, &c. Method of manufacturing. Gustave A. Oncken	38,660	Boiler furnace. Earl A. Wheeler	39,659
Base: see Folding base.		Boiler furnace. Earl A. Wheeler	40,621
Basin: see Catch basin.		Boiler. Hot water circulation. Charles A. Sullivan, et al.	39,168
Basket. William Henry Spillman	38,926	Boilers and digesters. Method of lining. Carl Kellner	38,384
Bath tub. George Booth	41,422	Boilers, &c. Apparatus for firing and heating steam. Edwin Marsh	39,756
Bath tub. Kallman Glass, et al.	38,420	Bolt: see Flour bolt.	
Bath tub, &c. Charles H. Moore	40,851	Bolts. Machine for threading. Emil Hulmer	40,155
Battery: see Coil battery. Electric battery. Galvanic battery. Secondary battery.		Bolting reel. Benjamin F. Reinbold	40,967
Beam: see Brake beam.		Book: see Account book. Binding book. Duplicating cheque book. Memorandum book.	
Bearing for pulleys. Charles T. Brandon, et al.	40,256	Book binder's machine. Robert W. Smith, et al.	41,002
Bearings: see Anti-friction bearings. Roller bearings.		Book binding: see Printing.	
Bearings for railway cars. Luther K. Jewett	40,805	Book binding. Adam C. Bausman	39,518
Bed: see Folding bed. Sofa bed.		Book binding. Joseph Henry Workman	38,254
Bed. George A. Garland	40,786	Book case. Fred H. Haley, et al.	40,626
Bed bottom. Stiles Raymond	39,071	Book holder: see Coin freed reference book holder.	
Bed bottom and brace. Walter H. Lightfoot	38,262	Book shelving. George Stikeman	40,347
Bed case. D. Henri Langlois	39,117	Book stapling machine. Joseph Lyman	40,373
Bed pan. Elizabeth Phillips	39,598	Boomerang. Charles H. Emerson	40,014
Bed pan. Willis Augustine Crandall	38,921	Boomerang gum. Charles H. Emerson	40,015
Bedstead. James Massie	38,168	Boot and shoe. Carl A. Riedig	40,581
Bedstead. Thomas Robertson Chambers	38,888	Boot and shoe. George Bryant	40,062
Bedsteads: see Lock for bedsteads.		Boot and shoe. George L. Williams	40,345
Bee hive. John Conser, et al.	40,999		
Beer. August Hummel	39,199		
Beer. August J. Metzler	39,257		
Beer. Apparatus for bottling. John H. Hosenbrock	40,675		
Beer faucet. Frank A. Trumviller	40,842		
Beer. Method of making. Andrew W. Billings	41,190		
Beer. Method of manufacturing. Charles F. Lawton, 39,549	39,550		
Beet roots. Machine for cutting. Franz Stephan	38,700		

Boot and shoe. Joseph Lauzon.....	38,304	Buckle. Albert D. Field.....	39,198
Boot and shoe. Thomas John Hood.....	38,087	Buckle. Charles A. Minehart.....	40,469
Boot and shoe buffing machine. Harold A. Webster.....	40,792	Buckle. George M. Aylsworth.....	41,388
Boots and shoes. George Valiant.....	38,153	Buckle. John H. Smith.....	41,033
Boots and shoes. Machine for lasting. George W. Moulton.....	40,727	Buckle. John Mulcair.....	39,486
Boots and shoes. Method of making. George Willey, et al.....	40,272	Buffer. Andrew W. Rogers.....	39,902
Boots and shoes. Method of manufacturing. Paul Bender.....	39,499	Building block. Eugene H. Lewis.....	40,168
Boot cleaning apparatus. Austin Berry.....	38,291	Building or paving block. George M. Graham.....	40,835
Booth. Charles F. Holdson.....	38,642	Building purposes. Composition for. Charles F. Baker, et al.....	38,723
Boring machine. Charles H. Irwin, et al.....	40,164	Bulletin board. Albert J. Taplin.....	41,407
Bottle: see Electric warming bottle. Varnish bottle.		Bundling machine: see Tag wiring and bundling machine.	
Bottle. Anton Schon.....	38,912	Bung. Theodor Hiller.....	39,682
Bottle for macilage. Wilbur F. Litch.....	38,487	Buoy: see Bell buoy.	
Bottle measure. Ewing Buchan.....	39,312	Burglar alarm. Noah M. Powell.....	39,691
Bottle necks. Tool for threading. Thomas T. McCoy.....	41,384	Burglar protection device for safes. Thomas M. Martin, et al.....	38,575
Bottle snap. Jonathan Filthian.....	40,925	Burner: see Carbon burner. Incandescent burner. Gas burner. Lamp burner.	
Bottles, &c. Method of and apparatus for stopping. Benjamin C. Cross, et al.....	41,116	Burner and furnace for hydro-carbon. Robert Ferguson.....	39,910
Bottling machine. Anahia M. Donally.....	40,640	Burner for crude oil. Theodore Willi, et al.....	38,084
Bottom: see Bed bottom. Spring bottom.		Burner for gas. Cyrus S. Dean, et al.....	41,332
Bowel complaints. Medicine for. Joseph Henry Burkholder.....	38,846	Burner for gas or oil. George S. Sanford, et al.....	40,940
Bower: see Shutter bower.		Burner for hydro-carbon. William Wilson.....	40,649
Bowl for closets. Levi Stanworth.....	39,269	Burner for hydro-carbon oil. Charles Reamon, et al.....	40,196
Bowl for waterclosets. John C. Beckman.....	39,971	Burner for lamps. Richard T. Barton.....	39,298
Box: see Fruit box. Match box. Paper box. Shaft and journal box. Shipping and display box. Waggon box.		Burner for oil. Alonzo Noteman.....	41,099
Box bending machine. Henry Born.....	40,736	Burner for oil. William A. Myers.....	40,657
Box machine. Rollin L. Coons.....	40,558	Burner for oil stoves. Elias M. Wright.....	39,330
Box making machine. George W. Strong, et al.....	38,711	Burner for vapour. Warren M. Abbott, et al.....	40,140
Box making machine. James F. Gilliland.....	38,755	Butter and cream. Method of preparing. Walter Cole.....	39,173
Box making machine. John Howenstine.....	39,032	Butter. Machine for moulding. William Foster.....	39,735
Box nailing machine. William S. Doing.....	39,568	Butter tub. Charles D. Filmore.....	38,753
Boxes from thin scale boards or veneer. Art of making cylindrical. Gilbert W. Bradley.....	39,614	Butter worker. Hans J. Anderson, et al.....	38,303
Boxes. Machine for making paper. Patrick H. Knight, et al	39,985	Butter worker. Samuel H. Waters, et al.....	38,436
Brace: see Bed bottom and brace.		Button hole attachment for sewing machines. Washington Wallick.....	38,526
Brace. Arthur A. Tattersall.....	41,121	Button setting machine. George M. Criswold.....	41,072
Bracket: see Shelf bracket.		Buttons. Machine for boring holes in. Dilman B. Shantz	40,531
Bracket for window shades. Alexander Traill.....	39,085	Buttons. Machine for turning. Dilman B. Shantz.....	39,928
Brake: see Air brake. Car brake. Hemp brake. Power brake.		Buttons to garments. Machine for attaching. Ewald Noelle.....	40,066
Brake. Christopher C. Reynolds, et al.....	40,812	Cabinet: see Flour cabinet.	
Brake. Giles Bowler, et al.....	39,452	Cabinet for bakers. Jesse McLaren Brophy.....	38,317
Brake. Henry Shaw, et al.....	41,238	Cabinet for holding duplicating apparatus. Mark A. Levy..	39,667
Brake. Jacob E. Loughbridge.....	41,343	Cable: see Electric Cable.	
Brake. Rhodes Battye.....	41,269	Cable propeller. Ernest Lotze.....	39,766
Brake beam. William A. Pungó.....	38,634	Cable railway. Samuel D. Root, et al.....	40,591
Brake beam and shoe head for railway cars. Charles T. Schoen, et al.....	40,556	Calculating: see Reading and calculating.	
Brake for cars. Jessie J. Cassidy.....	39,365	Calculator. William J. Clayton, et al.....	40,222
Brake for cars. Phillip Walsh.....	39,774	Calclectric generator. Edward G. Acheson.....	40,165
Brake for railway cars. Howard Hinckley.....	39,228	Calendar. David Ross.....	38,167
Brake for railway cars. Richard Fallis, et al.....	39,709	Calendar and stamp holder. George H. McKee, et al.....	38,564
Brake for sleds. Ezra Crosby.....	39,069	Calk for horse shoes. Alfred J. Blake.....	39,781
Brake for tramways. Friedrich Adler.....	39,675	Calk for horse shoes. Ferdinand Eulanfeld.....	39,538
Brake for vehicles. Luke Roberts, et al.....	39,653	Calk for horse shoes. Joseph C. Higgins, et al.....	38,051
Brake machine for cornices and eave troughs. John M. Brown, et al.....	40,555	Call: see Electric time call.	
Brake mechanism. Edward G. Shortt.....	39,371	Caloric oil generator and heater. David D. Griffiths.....	38,964
Brake mechanism. Walter S. Adams, et al.....	40,906	Calves. Apparatus for feeding. Henry B. Ringford, et al.....	39,180
Bread. Machine for casting, notching and stamping. Jonah J. House.....	39,652	Camera: see convertible camera, &c.	
Breakwater. George H. Henshaw.....	40,870	Camera. Frank L. Estrange, et al.....	39,967
Breast collar. Thomas White Fisher, et al.....	38,201	Camera. Thomas H. Blair, et al.....	40,198
Breast drill and brace. Arthur A. Tattersall.....	39,824	Camera. William F. Greene, et al.....	39,475
Breech loading small arms. Phillip T. Godsal.....	40,092	Camera shutter. Joseph J. Clairmont, et al.....	40,495
Brick. Ambrose S. Baker, et al.....	39,989	Camp stool. George H. Ellis.....	40,336
Brick. Edward Cammiss.....	39,252	Can: see Oil can. Sheet metal can. Tin can.	
Brick. Eugene H. Lewis.....	38,853	Can. George B. Hopper.....	40,284
Brick. James B. West, et al.....	41,228	Can. Herbert S. Cowan.....	40,534
Brick kiln. John T. Cullens, et al.....	38,377	Can. William Pratt.....	38,424
Brick kiln. Walter Paul Grath.....	39,002	Can for holding petroleum. Milton H. Garland.....	38,037
Brick machine. James D. Bain.....	39,503	Can for oil. Abraham J. Tschantz.....	39,188
Brick. Machinery for pressing sand-faced. William Johnson.....	40,074	Can labelling machine. Francis X. Gaudrie.....	40,927
Brick making machine. Frederick L. H. Sims.....	39,337	Can opener. Theobald S. Kuhl.....	39,003
Bricks. Machinery for manufacturing. William Johnson	39,637	Can or jar for packing purposes. Lyman Hatfield.....	39,341
Bricks. Method of drying and burning. John C. Kinzel.....	41,354	Cans. Method of opening. William A. Hungerford.....	39,708
Bricks. Method of making enamelled. Isaac T. Rue.....	40,924	Candy. Method of manufacturing. William P. Kirchhoff..	38,381
Bridge. Richard Boyle.....	38,621	Cane. John Vanes.....	38,979
Bridle: see Towing bridle.		Canning machine. Gains L. Merrell, et al.....	39,986
Bridle bit. Neil Stalker.....	41,335	Cant hook band. Henry Walton, et al.....	38,890
Bridle bit. William VanArsdale, et al.....	38,774	Canting block for saw mill carriages. Patrick C. Roche, et al.....	39,280
Bridle for paint brushes. Charles Boeckh.....	38,819	Canules for tracheotomy. Ernest Hartstein.....	41,215
Brooch. William Wattie.....	38,142	Cap: see night cap.	
Broom: see Street broom.		Cap. For vehicle hubs. Jared Maris.....	40,282
Brush: see Scrubbing brush.		Capsule. William Oppenheimer.....	40,496
Brush holder for dynamo electric machines. Earl P. Wetmore, et al.....	40,930	Capsules. Plant for manufacturing. John Krehbiel.....	39,663
Brushes. Art of making. John Hepner.....	39,265	Car: see Cattle car. Dumping car. Electric car. Parlour sleeping car. Railway car. Sleeping car. Stock car. Street car.	
Buck saw. John Stepler.....	38,260	Car. Leslie D. Farmer.....	41,251
Bucket: see Grab bucket.		Car. Max A. Zucher.....	39,736
Bucket for conveyors. Alexander E. Brown.....	39,289	Car axle. Hiram P. Willard.....	39,604
		Car axle lubricating box. Charles Fergie.....	41,142

Car body. George J. Porter.....	40,907	Car truck. Vertot D. Beach.....	39,395
Carbon burner. John H. LaRue.....	40,417	Car truck for electric motors. George M. Brill.....	40,618, 40,622
Carbon product. Louis S. Langville.....	39,924	Car truck for railways. John A. Brill, et al.....	38,877
Carburettor for gas. Hiram S. Maxim.....	39,286	Car wheel. George W. Cushing.....	41,322
Car brake. Alexander Campbell.....	40,905	Car wheel. John Rees Davies.....	38,675, 38,680
Car brake. Anthony B. Pool, et al.....	38,386	Car wheel. Wolcott J. Parmalee.....	38,301
Car brake. Charles W. Duncan.....	38,186	Car wheel. Benjamin F. Haugh.....	38,852
Car brake. John G. Zimmermann, et al.....	41,162	Card for hotel rooms. Luther Leroy Higby.....	39,078
Car brake. Robert A. Kiskadden.....	39,911	Carpenters' plane. Robert Robinson.....	40,252
Car brake. Chester L. Ames.....	40,180	Carpet stretcher. John Vandyke.....	38,486
Car brake and bumper. Leonard G. Arnold.....	39,534	Carpet sweeper. William H. Pickett.....	48,896
Car coupler. Aaron Loughheed.....	40,209	Carpets. Apparatus for sewing. Franklin Ames.....	39,379
Car coupler. Alfred J. Allen, et al.....	38,769	Carriage: see Lathe carriage. Ventilating railway carriages. Ventilating and heating railway carriages.	
Car coupler. Alfred A. Heath.....	38,997	Carriage. Harlen P. Wells, et al.....	41,216, 41,235
Car coupler. Andrew H. Weir, et al.....	39,083	Carriage gear. Joseph J. Kinsmann.....	38,385
Car coupler. Arthur J. Watts.....	39,021	Carriage top. Daniel Conboy.....	38,925
Car coupler. Austin Hammond, et al.....	40,112	Carrier: see Hay elevator and carrier. Log carrier.	
Car coupler. Benjamin Mayer, et al.....	41,344	Carrier for fruit and eggs. Levi H. Page, et al.....	38,631
Car coupler. Charles A. Kennedy, et al.....	38,287	Cartridge. John C. Butterfield, et al.....	39,939
Car coupler. Charles A. Pooley.....	38,361	Cartridge case. John C. Butterfield, et al.....	39,839, 39,840
Car coupler. Charles E. Seabury.....	40,144	Cartridges. Apparatus for making and charging metallic.	
Car coupler. Charles H. Olds.....	39,143	Paul Giffard.....	39,489
Car coupler. Charles H. Shuttleworth, et al.....	38,406	Cart: see Dumping cart. Road cart.	
Car coupler. Christian H. Gohl, et al.....	38,954	Cart. Mark A. Libbey.....	38,698
Car coupler. Daniel Grant.....	40,433	Cart saddle. Ethelbert O. Blackford, et al.....	40,454
Car coupler. David Stark.....	39,995	Carving machine. James Hay.....	41,082
Car coupler. David U. Graveline.....	38,222	Carving machine. William Loeffler.....	41,380
Car coupler. Edward W. M. Hughes.....	38,765	Case: see Hat case. File case. Pocket tobacco case. Watch case.	
Car coupler. Francis R. Brown, et al.....	40,744	Case for books and blanks. Roy Miller.....	40,484
Car coupler. Frank A. Fox.....	41,149	Case for bottles. Claud E. Marlow, et al.....	38,061
Car coupler. Frank Harvey, et al.....	38,820	Case for cartridges. John Dobie.....	39,281
Car coupler. Frederick L. Wells.....	39,158	Case for eggs. William H. Church, et al.....	39,204
Car coupler. George Cassady.....	40,108	Case for preserving merchandise in a moist condition.	
Car coupler. George P. Jones, et al.....	38,244	Henry D. Streater.....	40,438
Car coupler. George S. Gaines, et al.....	39,700	Cash indicator. Lloyd N. Mills.....	39,230
Car coupler. Granville R. Lewis.....	40,903	Cash register: See Indicator and register.	
Car coupler. Hans B. Ledel.....	38,391	Cash register. Charles J. Pasmore.....	38,678
Car coupler. Harman Bunker, et al.....	38,548	Cash register. Phillip Yoe.....	38,948
Car coupler. Henry Schaeffer, et al.....	38,898	Casing for furnace air injectors. Robert D. Smith.....	39,999
Car coupler. James A. Hinson.....	38,109	Casks. Broaching device for. George Gabb.....	38,864
Car coupler. James A. Wiswald, et al.....	40,886	Casket. Thomas McGovern.....	40,115
Car coupler. James C. Devlin.....	40,945	Caster. Ernest G. Hoffman.....	38,187
Car coupler. James Hoyt Brown.....	38,389	Casting: see Iron pigs. Ingots, &c.	
Car coupler. James Walker, et al.....	40,172	Casting metals in vacuo. Apparatus for. William S. Simpson.....	40,832
Car coupler. Jeremiah W. Kirby, et al.....	38,060	Catch: see Safety catch.	
Car coupler. John H. Eakins.....	40,425	Catch basin for sewers. Joseph W. Hershberger.....	40,042
Car coupler. John Girey.....	39,380	Cattle and stock. Apparatus for watering. John Allis.....	38,207
Car coupler. John T. Jones.....	38,715	Cattle car. Ferdinand E. Canda.....	41,240, 41,250
Car coupler. Joseph Callantine, et al.....	38,782	Cattle guard. James T. Hall.....	40,381
Car coupler. Joseph C. Oakman.....	39,202	Cattle guard. James Whittemore.....	40,396
Car coupler. Joseph H. Coleman.....	38,627	Cattle guard. Kenneth W. Blackwell, et al.....	38,387
Car coupler. Joseph Teel.....	40,113	Cattle guard for railways. Benjamin Welhaupter.....	40,008
Car coupler. Joseph Klingler.....	38,771	Cattle guard for railways. Parker Merrill.....	38,116
Car coupler. Joshua W. Latta.....	39,072	Caustic soda, caustic potash and other products from their salts. Electrolytic, production of. James C. Richardson	38,478
Car coupler. Josias Poffenbarger.....	39,586	Ceiling block. Axel Ekstrom.....	39,825
Car coupler. Marie H. St. Denis.....	38,834	Celluloid to key boards. Method of applying. Augustus Newell.....	38,282
Car coupler. Mark M. Decker.....	40,517	Cellulose and oxalic acid from ligneous material. Process for the simultaneous production of. Isaac Lifschutz.....	38,460
Car coupler. Michael Leduc.....	38,289	Cellulose. Apparatus for sorting. Christian Wandel.....	40,447
Car coupler. Michael Flanagan, et al.....	39,346	Cement. Charles T. Williams.....	40,860
Car coupler. Milo J. Althouse.....	38,818	Cement. Marc Laffont.....	39,148
Car coupler. Milton W. Trexler.....	39,227	Cement. Manufacture of compound slabs of. Emile Dupont.....	38,358
Car coupler. Nicholas J. Hopkins.....	41,029	Centring shafts. Machine for. Simon B. Minnock.....	40,918
Car coupler. Nicholas Sedore.....	38,380	Centre board for boats. Francis M. Eaton.....	40,837
Car coupler. Oliver P. Conley.....	40,118	Centrifugal pulp dryer. Samuel S. Stevens.....	40,557
Car coupler. Osborn Wells, et al.....	41,264	Centrifugal separator. Carl G. P. De Laval.....	40,904
Car coupler. Patrick McEntee.....	39,006	Centrifugal steam injector. Martin R. Ruble.....	38,388
Car coupler. Peter Hoff, et al.....	40,387	Cess pool. Frank L. Union.....	41,350
Car coupler. Richard Chandler.....	39,722	Chain. Harvey E. Kelley.....	39,089
Car coupler. Richard S. Robertson.....	40,676	Chain belt. James B. Ivey, et al.....	39,423
Car coupler. Rosamond Woolf, et al.....	39,004	Chain. Process and apparatus for making solid link. Julius Kinder.....	39,871
Car coupler. Russel M. Woodard.....	39,396	Chain stitch for boots and shoes. Andrew Eppler.....	40,291
Car coupler. Samuel E. Harris.....	38,828	Chair: see Baby carriage chair. Folding rocking chair. Folding chair. Railway rail chair. Rocking chair. Sewing machine chair.	
Car coupler. Samuel G. Trime.....	38,266	Chair. Henry A. Gage, et al.....	38,114
Car coupler. Thomas Baril.....	38,278	Chair. William H. Mitchell.....	39,067
Car coupler. Thomas Dee.....	39,144	Chair for cleaning windows. William M. Reynolds.....	40,122
Car coupler. Thomas Heard.....	41,061	Chair for railroad rails. George W. Wells.....	40,780
Car coupler. Thomas Sweet, et al.....	39,968	Chair for railway rails. Tom Sayers.....	40,434
Car coupler. Urgel Beausejour.....	39,933	Chamfer cutter and lathe. Christen Mattison.....	39,757
Car coupler. William C. Watson.....	40,412	Change maker. Samuel J. Taylor.....	40,816
Car coupler. William H. Starkey, et al.....	39,231	Channelling: see Groove and channel. Rough rounding and channelling.	
Car coupler. William L. De Grace.....	40,660	Characters. Device for interchangably arranging. James Noble.....	38,798
Car coupler. William N. Robinson.....	39,134		
Car heating apparatus. George Westinghouse.....	39,412		
Car heating apparatus. James F. McElroy.....	39,406		
Car heating apparatus. James H. Sewall.....	40,178		
Car heater. James H. Sewall.....	40,051		
Car replacer. John Maxwell Donnelly.....	38,280		
Car roof. John C. Wands.....	40,709		
Car seat. Edwin L. Bushnell, et al.....	39,988		
Car seat. Essington N. Gilfillan.....	40,868		
Car step. Francis W. Jones.....	40,207		
Car truck. George M. Brill.....	40,827		
Car truck. John A. Brill.....	38,873		

Charcoal. Process of making. Leopold Zwillingher.....	40,419	Closet : see Dry closet. Earth closet.	
Charger for gas retorts. Andrew Hickenlooper.....	40,789	Closet. Anne G. Chadbourne.....	38,688
Charging car heating apparatus with a heating medium. System of. James F. McElroy.....	40,257	Cloth finishing machine. William Hebdon.....	38,393
Chase for printers. Elmer Effenfinger.....	40,831	Cloth. Machine for cutting. Henry A. Caldwell.....	40,414
Check : see Door check.		Cloth. Machine for cutting. Morris Grossmann.....	38,194
Check book. Joseph Oldfield.....	39,126	Cloth. Machine for cutting. Richard Schofield.....	41,092
Check controlled lock. James R. Buckingham.....	40,211	Cloth. Machine for sizing and painting. Dustan A. Page, et al.....	39,762
Check hook. Alonzo Lobbell.....	38,053	Cloth. Machinery for measuring, winding and cutting off lengths of. Anton Hahn.....	39,698
Check hook. Harry Eugene Kelley.....	38,339	Cloth measuring machine. John C. Craig, et al.....	39,200
Check puncher. John C. Robinson, et al.....	40,457	Clothes. Composition of liquid matter for washing. Fred- erick H. Nice.....	38,629
Cheese. Method of making. John D. Frederiksen.....	40,520	Clothes drier. Allen G. Ingalls, et al.....	39,422
Cheese. Method of packing. Oswald J. Allen.....	39,483	Clothes drier. Austin V. M. Sprague.....	39,150
Cheese. Process of making. Erik G. N. Salenius.....	40,332	Clothes drier. George W. North.....	41,134
Chemical fire engine. Charles Patton.....	38,100	Clothes drier. John McKimmon.....	38,461
Chemical fire engine. Randall T. Van Valkenburg.....	40,181	Clothes line. Alisa Ann Cox.....	38,550
Cheque book. James Oldfield, et al.....	38,586	Clothes line. Aristide Caron.....	38,480
Chest : see Tea chest.		Clothes line. Solomon Smith, et al.....	38,349
Chimney. Samuel T. H. Holt.....	38,602	Clothes pin. Edmund H. Turner.....	39,842
Chimney cap. William A. Pearce.....	40,874	Clothes pin. John A. Johnson, et al.....	38,768
Chimney cowl. Theodore Faeger.....	40,719	Clothes washer. Alphonse Rousseau, et al.....	38,604
Chloride of sodium and potassium. Electrical decomposi- tions of solutions of. James C. Richardson.....	38,484	Clothes washer. Edward Byron Near.....	38,146
Chocolate. Victor Tobias, et al.....	38,057	Clothes washer. Horace Herbert Miller.....	38,887
Chopper for culinary use. John B. Coe.....	41,003	Clutch : see Friction clutch.	
Chopping knife. J. W. Allen, et al.....	41,225	Clutch. Alexander E. Brown.....	39,288
Chuck for pipe nipples. William O. McFarlane.....	41,066	Clutch connection. Harman Bunker, et al.....	39,051
Churn. Erik G. N. Salenius.....	39,235	Clutch for organ pipes. Frederick W. Hedgeland.....	38,590
Churn. James A. Hamilton.....	41,069	Coal. Apparatus for removing piles of. James M. Dodge.....	39,546
Churn. John T. Mark, et al.....	38,054	Coal elevating and transporting apparatus. Joseph A. Russell.....	39,728
Churn. Matthew L. Hoyt.....	39,858	Coal. Machinery for moving. James M. Dodge.....	39,571
Churn. Nestor Rolland.....	40,230	Coal. Machinery for piling and removing. James M. Dodge.....	39,540
Churn. Norman Chester Lloyd.....	38,991	Coal. Machine for sizing and cleaning. Septimus Thomas.....	39,447
Churn. Oliver Linebarger, et al.....	40,195	Coal screen. Hiram Barton Sackett.....	38,551
Churn. Robert Simpson.....	38,717	Coaster. George Seebick.....	40,844
Churn and butter worker. R. B. Disbrow.....	40,375	Cock : see Stop cock.	
Chute for grain and coal. Thomas W. Emery.....	38,045	Cock. William Roberts.....	39,186
Cigar. Mona Lesser.....	39,658	Cock for gas. Joseph Clark.....	40,031
Cigar blank. Harry N. Anderson.....	40,808	Cocks. Apparatus for opening and closing. Oscar Lowe.....	39,670
Cigar lighting and advertising apparatus. Arnold Nauhaus.....	39,922	Coffin. Ludwig O. Mueller, et al.....	38,035
Cigar tip cutter and advertising device. Frederick R. White.....	40,379	Coffin case. William John Anthistle.....	38,845
Cigar vent. Reuben Cohen.....	38,862	Coffins. Apparatus for securing the lids of. Franz Schmidt et al.....	39,674
Cigars. Means for preventing fraud in the sale of. Sebas- tien Azcan-y-Meana.....	38,111	Cogged wheel. Jacob F. Pfetich.....	40,110
Cigars. Method of branding. Bernard Goldstein.....	41,119	Coil and battery for electro-medical apparatus. Thomas C. Hodgkinson, et al.....	40,049
Cigarette machine. Henry Bohls.....	39,532	Coin actuated device. Patrick Kennedy.....	39,767
Cigarette machine. Jenetta V. Bohannan.....	40,085	Coin controlled apparatus for telephones. William Gray, et al.....	40,139
Cigarette machine. Joseph B. Underwood.....	39,111	Coin freed reference bookholder. Frederick W. Jacob.....	41,073
Cigarette machine. William A. Hulse.....	39,191	Coin operated automaton. Arthur M. Pierce.....	40,314
Cigarette making machine. Edward E. Parsons.....	40,685	Coin operated lock. Henry Caspar.....	40,418
Cigarettes. Machine for making. Anatole E. Decoufle.....	40,330	Coin operated sight testing apparatus. Bruce Green.....	40,821
Cinder sifter. James A. Stovel.....	38,741	Coin vending machine. Archie James Henry.....	38,841
Circuit. Controlling and protecting device. Edwin W. Rice.....	40,761	Coins. Receptacle for. Robert H. Bishop, et al.....	39,369
Circular articles. Apparatus for forging and finishing. Charles Fairbairn.....	41,080	Collapsible ladder. Ansel Leo.....	41,281
Circular knitting machine. John R. Bridges, et al.....	38,150	Collar : see Breast collar. Horse collar.	
Circular knitting machine. Michael J. Dinneen.....	38,721	Collar button. David O. Parks.....	41,381
Circular saw. George Cassidy.....	39,885	Collar fastener : see Stove pipe and collar fastener.	
Cistern. Caleb S. Johnson.....	40,612	Collar for horses. Andrew H. Fletcher, et al.....	39,197
Cistern for closets. David Lancaster Dwinell, et al.....	38,856	Collar for horses. Herman C. Etzkorn.....	39,267
Cisterns. Device for cleaning. Orren I. Searles, et al.....	41,394	Collector : see Dust collector.	
Cisterns. Device for removing debris from. Geo. D. Wilson.....	38,620	Collector for dust. William A. Cockrell.....	39,629
Clamp : see Meter clamp. Sliding clamp.		Collector for fares. Arthur W. Berne.....	40,504
Clamp for bed clothes. Anthony Hamble.....	41,139	Color on glass surfaces. Process for producing. Johann C. Duntze.....	40,910
Clamp for dental flasks. Morgan R. B. Creery.....	40,149	Coloring pictures, &c. Art of. Akois Ophoven.....	38,822
Clamp for drawing together wooden joints. Thomas Doddrell.....	39,389	Combination fence tool. John W. Gallant.....	41,147
Clamp for floors. Alexander Zauner.....	41,140	Combination lock. Henry H. Daniels.....	41,171
Clamp for hose. Frank T. Weidaw.....	38,824	Combustion mechanism. Thomas Brown.....	38,123
Clamp for moulders flasks. William W. Archibald.....	40,251	Compass : see Recording compass.	
Clamp for shirt boards. Richard Schofield, et al.....	40,682	Compensator for signal rods. Edwin Doorey, et al.....	39,582
Clamp for stationery basins. James J. Odonnell.....	38,439	Composition for converting cast iron into steel. William J. Miles.....	39,912
Claw clip. Mackay J. Scobie.....	39,609	Composition for use in heating systems. Martin Wanner.....	39,765
Clay for paving material. Process of burning. Jesse Stubbs.....	38,298	Compound engine. Clifford H. Batchellor.....	39,414
Cleaner : see Hempbrake and cleaner.		Compressor : see Air compressor.	
Cleaner for boiler flues. Ronald McDonald.....	38,504	Compressor. Henry C. Sergeant.....	40,863
Cleaner for boiler tubes. John M. Dunn.....	41,425	Compressor for air. William A. Rohr.....	39,623
Cleaner for boilers. William Polley.....	40,060	Compound : see Explosive compound. Nutritive com- pound.	
Cleaner for combs. Elihu R. Pettit.....	38,475	Compound engine. James S. Parmenter.....	40,578
Cleaner for grain : see Separator and cleaner for grain.		Compound ingots and wire made therefrom. Levi L. Burdon, et al.....	38,720
Cleaner for mucilage brushes. Frederick T. Aitkens.....	41,155	Compound press. Francis B. Deane, et al.....	40,452
Cleaning filtering surfaces. Method of and means for, Marshall McDonald.....	41,244	Compression Joint. Charles S. Bovier.....	39,028
Cleat : see Wire cleat.		Concentrating spent soap lye to recover salt and glycerine therefrom. Apparatus for. Albert Domier, et al.....	40,703
Clevis. Plov and connections. Roger Croft Percival.....	38,990	Concentrator : see Gold concentrator.	
Clincher for horse shoe nails. John Jones.....	38,946	Concentrator. William Legrand Card.....	39,156
Clip : see Claw clip.			
Clip for window blinds. Thomas P. Brown.....	40,855		
Clock : see Electric clock. Electric and stereotype.			
Clock. Fred. L. Gregory.....	39,628		
Clocks. Method of synchronizing and transmitting time signals. William F. Gardner.....	39,463		

Concentrator for ores. William H. H. Bowers, et al.	38,806	Crane and elevator. John E. Walsh.	38,812
Concrete stone gully. Ebenezer North.	38,412	Crate: see Egg crate.	
Condenser: see Steam surface condenser. Water jet condenser.		Cream, see Butter and cream.	
Condenser. Thomas Craney.	41,010	Cream from milk. Centrifugal apparatus for separating, Walter Cole.	39,954
Conductor: see Insulated electric conductor.		Crimper for cartridge shells. George D. Hunter.	38,866
Conductor for electricity. Phillip H. Holmes.	39,352	Crossing for railways. Walter M. Axtell.	39,886
Conductor. Process of treating insulated electric, James B. Williams.	40,530	Crucible for casting dental plates. Frederick Fenner, et al.	39,734
Conduit: see Electric conduit. Power conduit. Underground conduit.		Crushing and grinding mill. Herbert W. Fleury.	38,440
Conduit sections for underground electrical conductors. Process of making. James F. Cummings.	40,564	Crushing mill. James N. Paxman, et al.	40,070
Conduits. Machine for making clay. James J. Powers, et al.	40,202	Cultivator: see Corn cultivator.	
Confections. Method of making. Thomas Robertson.	41,138	Cultivator. Andrew Johnson.	40,759
Consumer: see Smoke consumer. Spark consumer.		Cultivator. Clarence E. Beement.	40,543
Continuous railway rail. Bernhard G. Maercklein.	39,176	Cultivator. Charles C. Hiestand.	40,785
Controller: see Electric controller.		Cultivator. Richard Sylvester.	39,587
Controller for clutches. David R. Steele.	39,726	Cultivator. Sanford Gasser.	39,597
Controlling device for electric motors. Francis O. Blackwell.	39,780	Cultivator. Thomas C. Barby, et al.	41,309
Controlling switch for electric railways. Frank B. Rae, et al.	38,705	Cultivator. Walter Couthard.	39,608
Convertible camera and graphoscope. William V. Esmond, et al.	41,192	Cup: see Lubricating cup.	
Conveying apparatus. Joseph C. Martin.	39,435	Curling iron. Bertha Westervelt.	39,259
Conveying machine: see Hoisting and conveying machine.		Current director. James F. McElroy.	41,266
Conveying ships or heavy bodies overland. Apparatus for. Walter R. Kimpfle.	39,492	Current regulator. James F. McElroy.	41,267
Conveyor: see Grain conveyor, pulverizer and conveyor, waste end conveyor.		Cushion: see Spool holder and needle cushion.	
Conveyor. Ira H. Gaither.	38,664	Cushioned car wheel. Benjamin F. Haugh.	38,275
Conveyor for coal, &c. William Keenan.	39,097	Cushioned tire. Woodburn Langmuir.	39,057
Cooker: see Steam cooker.		Cut off: see Overflow cut off.	
Cooking stove and house heater. Thomas Brooks.	39,343	Cut off engine. John Abell.	40,147
Cooking vessel. Richard C. Anderson.	39,921	Cut off for gas burners. Eli Deme, et al.	39,119
Cooler: see Body cooler. Cover and cooler.		Cut off for gas burners. Francis Walter Merchant.	38,959
Cooler and aerator for milk. Henry Fowell.	38,394	Cut off for pipes. William A. Smith, et al.	41,418
Cooler for milk. Marwin D. Main.	41,088	Cut off valve. William J. Cremer.	39,124
Copper and other metals from solutions of the salts of same. Apparatus for obtaining. Alberto Rovello, et al.	39,633	Cut off valve for steam engines. Gideon V. Putmann, et al.	39,385
Copper. Apparatus for obtaining. John C. Howell.	40,655	Cut out: see Electric cut out.	
Copper. Preparation of. George Wycoff Cummins.	38,980	Cutter: see Axle cutter. Holder and cutter. Meat cutter. Rotary cutter. Wrench and cutter.	
Copy holder for typewriters. William Joseph Still, et al.	38,085	Cutter bar. David Rudd.	38,950
Core attracting solenoids. Wenzel R. Michl.	40,403	Cutter for axles and threads. Frank E. Beardsley.	40,111
Cork composition. Raphael G. de Vasson.	40,772	Cutter for bolts and rivets. John Helwig.	38,259
Corks in bottles. Means for securing. Karl Kirschner.	40,594	Cutter for ensilage. Herbert W. Fleury, et al.	39,062
Corking machine. Albert Siebert.	40,887	Cutter for green bone. Henry A. Hannum.	39,398
Corn cultivator. Calvin H. Hilbert.	38,747	Cutter for railroad rails. Eugene H. Angell.	40,421
Corn off the cob. Machine for cutting. Welcome Sprague.	39,725	Cutter for rods and pipes. Henry Diebel.	38,172
Corn popper. Andrew B. Olson.	41,440	Cutter for sausage meat. Joseph M. Briggs.	40,648
Corner joint for packing boxes. Albert T. Linderman.	40,374	Cutting clothing. System of. James A. Glass, et al.	38,574
Corner piece for travelling bags, boxes, &c. William Roemer.	39,113	Cutting grinding and polishing. Material for. Charles Mortimer.	39,963
Corner shield and protector. David Henry Rockwell.	38,067	Cutting machine: see Stone cutting machine.	
Corset. De Ver H. Warner.	38,488	Cutting machine. Julius Erlenwein.	39,542
Corset. Frank Rotschild.	41,262	Cutting pliers. Sanford O. Root.	39,951
Corset. Lewis Schiele.	41,005	Cyanides. Process of and apparatus for. George T. Beilby.	38,801
Corset. Nancy E. Miles.	39,323	Dampener for envelopes. Elisha L. Kingsley, et al.	39,273
Corset. Reddin W. Parramore.	38,623	Damper: see Damper and ventilator. Stove pipe damper.	
Corset. Wallace W. Gould, et al.	38,803	Damper. Charles A. Couch.	41,132
Cotton droppings. Machine for cleaning. Henry Fernhough.	39,161	Damper. Julius F. T. Schwab.	41,415
Cough syrup. Etienne Germain.	38,041	Damper. William A. Kemp.	38,463
Counter: see Game counter.		Damper. William A. Kemp, et al.	38,462
Counter and display rack for wearing apparel. John W. Morrison.	38,183	Damper regulator. Charles G. Jewett.	40,380
Counter for boots and shoes. James F. Sharpe.	38,163	Damper for stove pipes. John B. Cook.	39,182
Coupler for vehicles. Otto Flohr, et al.	38,430	Damping device for mechanical music boxes. Gustave A. Lrachhausen, et al.	41,009
Coupling: see Car coupling. Hose coupling. Joint coupling. metallic pipe coupling. Pipe coupling. Spring coupling. Thill coupling.		Dash board. Philo M. Barnes, et al.	40,351
Coupling and valve for pipes. William T. Messinger.	38,790	Debits. Means for securing persons from losses by bad. Levy Maybaum.	38,334
Coupling for bell collars. Robert C. Tambs.	39,937	Decoy. Frederick A. Thorn, et al.	40,234
Coupling for electric wires. James F. McElroy.	39,411	Deep well drilling apparatus. Wesley Webber.	41,366
Coupling for hose. James F. McElroy.	41,342	Delhorning instrument. Harry W. Leavitt, et al.	40,058
Coupling for hose. John Baltimore, et al.	41,274	Delinting cotton seed. Jefferson M. Gardner.	41,413
Coupling for pipes. John Suydam.	40,872	Dental engine. Carl H. Seeger.	39,551
Coupling for rods. Louis Buese, et al.	41,320	Denture. John J. Stedman.	39,391
Cove. George S. Mayhew, et al.	38,270	Depurator. John Nixon.	39,427
Cover: see Fruit basket. Tea chest hinge and cover.		Derrick. Augustus Myers.	38,595
Cover and cooler for milk cans. Nicholas Henry Terens.	39,132	Derrick. Foster Milliken.	38,429
Cover for cups, &c. Frederick J. Mockler.	39,878	Desk. Cyrenius S. Barnes.	41,214
Cover for desks. Frank Joseph, et al.	39,845	Desk. Frank Hawken.	39,122
Cover for fruit baskets. George H. Williams.	38,118	Desk and easel. John O. Richmond, et al.	38,793
Cover for milk cans. George L. Flower.	40,911	Detergent. William B. Brittingham.	39,906
Cover for pots. Elizabeth G. Copelin.	40,071	Developing dish for photographic purposes. André Desbottin.	40,866
Cover for sewing machines. Cornelius C. Jenking.	38,256	Die for cutting off and pointing pieces of wire. Charles D. Rogers.	38,321
Cover for the ends of hub bands. Jared Maris.	40,277	Die for forming the threads of screws. John Sheldon.	39,353
Covering for electric cables. John H. Cheever.	40,305	Die for plastic moulding. James Henry Mitchell.	38,651
Cowl, see Chimney cowl.		Die plate. Lewis C. Wetzel.	41,123
Cradle: see Baby carriage, chair and cradle.		Die stock and die. James S. Fletcher.	38,738
Crane. John Graham, et al.	39,638	Die for plastic moulding. James Henry Mitchell.	38,651
		Die plate. Lewis C. Wetzel.	41,123
		Die stock and die. James S. Fletcher.	38,138
		Digester. See Boiler or digester.	
		Digester for paper pulp. Charles Curtis.	41,022
		Digester for pulp. William H. Howell.	39,594
		Digger. William Gibbs, et al.	40,699
		Disconnecter for overhead conductors. Andrew L. Johnston.	41,156

Dish washer. Harriet E. Davis.....	38,036	Drum. Adolph G. Soistmann, et al.....	41,227
Dish washing machine. William C. Nelson.....	39,236	Drum. P. Farnham.....	41,008
Disinfecting and deodorizing apparatus. Albert E. Haver.....	38,683	Dry cell. Dr. Hugo Roller.....	39,773
Disinfecting apparatus. Frederick André.....	39,672	Dry closet. Thomas B. A. Chamberlain.....	38,367
Disintegrator and separator for fibrous material. Berthold Ziegler.....	39,978	Drying apparatus. Charles H. Coyl.....	39,847
Disk harrow. Albert J. Glass.....	39,841	Drying apparatus. Simeon G. Phillips.....	39,025, 39,026
Disk harrow. Caleb Grandmont.....	40,806	Dry kiln furnace. William Ketcham.....	38,353
Disk harrow. Edward Pridmore.....	40,243	Dump bucket. Thomas Cogswell.....	38,863
Disk harrow. Jay Spencer Corbin.....	38,872	Dump car. Jacob Louder.....	38,956, 38,957, 38,958
Disk harrow. Sheldon J. Glass.....	39,846	Dumping car. Jacob J. Souder.....	39,101, 39,109
Display book. George A. Moss.....	40,735	Dumping car. Malachi O'Conner.....	39,413
Display device. Matthew F. Connett.....	39,464	Dumping car. William A. Thacher.....	40,956, 40,957
Distilling. Art of, and apparatus for. Arthur W. Ellis.....	40,416	Dumping car for merchandise. Jacob J. Souder.....	39,102
Distinctive paper. James Macdonough.....	38,190	Dumping car for railways. Jacob J. Souder.....	39,100
Distributor. See fertilizer distributor. Soap holder and distributor.....		Dumping cart. Timothy Flanigan.....	38,211
Distributing liquid poison. Device for. Myron J. Carswell.....	41,287	Dumping wagon. Lewis S. Browning.....	40,565
Diving armour. Arthur Hemenger.....	41,006	Duplicating cheque book. Joseph Oldfield.....	39,947
Diving dress. William Carey.....	40,449	Duplicating machine. Robert Morgeneier, et al.....	40,173
Ditching machine. Leonidas H. Turner.....	40,340	Dust collector. Wright D. Smith.....	38,951
Documents or checks. Machine for perforating. Albert R. Abbott.....	38,676	Dust guard for car axle boxes. Abe. L. Cushman, et al.....	38,354
Doll support. Albert B. Wilcox.....	41,239	Duster. Josiah Taylor Hair.....	38,091
Door. See Fire proof door. Pneumatic door check. Screen door. Spring and check for doors.....		Dyeing or scouring. Apparatus for. Joseph P. Delahunty.....	39,862
Door. William F. Gregg, et al.....	40,153	Dynamite. Process of making. William Y. Rochester, et al.....	40,566
Door for cars. Albert B. Pullman.....	39,636	Dynamo electric machine. Frank Bankson Rae, et al.....	38,068
Door for cars. William F. Lyon, et al.....	39,790	Dynamo electric machine. Justus B. Entz.....	39,796
Door for elevators. William E. Marlett.....	40,813	Dynamo electric machine. Martin Charles Burt.....	38,885
Door for freight cars. William B. Wilson.....	39,931	Dynamo electric machine. William Hockhousen.....	39,271
Door bell. Joseph Allen, et al.....	40,404	Dynamo electric machine. William Stanley.....	39,345
Door check. Charles H. Tims.....	40,833	Dynamometer. Charles A. Barrett.....	41,083
Door closing appliance and check for same. Robert Adams.....	40,316	Ear: see Bail and ear.....	
Door hinge. Hans. Berthold.....	39,816	Ear for vessels. John B. Schneider.....	39,153
Door latch. Cyrille Gagnon, et al.....	38,648	Ear muff. Harvey Hadden.....	41,056
Door mat. George E. Eggert.....	39,837	Earth auger. Bradford Lane, et al.....	40,133
Doors. Machine for manufacturing panel. Alexander McKay, et al.....	38,767	Earth auger. Nicholas Schellenberger.....	38,525
Doors, and means for holding together the various parts of. Felix Carpenter.....	39,474	Earth closet. Hamilton A. Jukes.....	38,325
Dormant warehouse scales. John Milne.....	38,277	Earthenware: see Tile's Porcelaine earthenware, &c.....	
Dough: see Flour and dough.....		Easel: see Desk and easel.....	
Dough mixing machine. John Adair.....	40,684	Easels: see Key wedge for easels.....	
Dovetail joint closing machine. Albert Linderman.....	40,368	Edging machine for shingles. Thomas O. Wilson.....	40,757
Dovetailing machine. Charles E. Parks.....	41,367	Egg beater, masher, &c. Uriah D. Seltzer.....	41,279
Draft: see Soot door, ventilator and check draft.....		Egg carrying package. Robert G. Dale, et al.....	39,715
Draft equalizer. Frank W. Reisinger.....	38,813	Egg cases. Machine for making. James H. Batchelder.....	39,261
Draft regulator. Charles Dezany Howard, et al.....	38,737	Egg crate. Charles C. Tilghman.....	39,426
Draft regulator for stove pipes. Edward Gerred.....	39,852	Egg tester. Arthur W. Webb.....	39,043
Draft regulator. Ira F. Beers, et al.....	38,646	Egg tray machine. William S. Low.....	39,643
Drag for sleighs. Harman Bunker, et al.....	39,366	Eggs. Device for opening hot, boiled. Franklin N. Jewett.....	38,258
Drag saw rail cutting machine. Joseph W. Calif, et al.....	38,804	Electric alarm. Stephen M. Matheys.....	38,536
Drainage trap for steam pipes. Edward E. Gold.....	40,350	Electric alarm for boilers. Thomas G. Lovegrove.....	38,554
Drain trap. Timothy J. Kieley.....	38,966	Electric apparatus for the body. Robert S. Mears.....	39,332
Dramatic effects. Apparatus for producing illusory. James W. Knell.....	39,625	Electric battery. Charles Grimwood, et al.....	39,624
Draw bar. James H. Elliott.....	39,763	Electric battery. Jean Vernhet.....	40,670
Draw gear for railway cars. Alvin Van Dorston.....	40,650	Electric battery. Walter S. Richards, et al.....	38,026
Dredger for the excavation of golden alluvium. Ernest F. Lacour.....	38,735	Electric belt. Christian H. Dorenwend.....	39,223
Drench horn. Frederick Fisher, et al.....	38,689	Electric block signal system. John Laburt, et al.....	41,110
Dress: see Diving dress.....		Electric cable. Theodore Guillaume.....	39,596
Dress fitter. Carrie Shane.....	38,947	Electric cable. William H. Sawyer, et al.....	38,669
Dress form. George R. Sherman.....	41,377	Electric cable. William H. Sawyer.....	38,732
Dress shield. Ella N. Gaillard, et al.....	39,865	Electric car. Archibald H. Brintnell.....	41,016
Dress shield. Isaac B. Klainert.....	38,476	Electric car fender. Edwin Rochester.....	40,949
Dress stay. John S. Crotty.....	40,747	Electric car heater. Willis Mitchell.....	39,308
Dress stay. Morris Plant Bray.....	38,880	Electric car motor. Frank B. Rae, et al.....	38,722
Dresser: see Side dresser.....		Electric cigar lighting lamp. William J. Eastman.....	41,065
Drier: see Clothes drier. Grain drier.....		Electric clock. Frank A. Ellis.....	38,426
Drier. James Bond.....	40,947	Electric clock. Walter J. Dudley, et al.....	38,421
Drier for clothes. Jehiel F. Wynkoop.....	39,563	Electric controller for railway trains. Frank E. Kinsman.....	39,075
Drier for clothes. John Cross.....	38,242	Electric currents: see Subdividing electric currents.....	
Drier for clothes. William Edward Austin.....	38,135	Electric cut out. Henry S. Keating.....	40,482
Drier for lumber. LaFayette C. Van Duzen.....	41,346	Electric cut out. William P. Mashinter.....	41,115
Drier for tobacco. William B. Marks.....	38,205	Electric dynamo and motor. William J. McKee, et al.....	38,588
Drill: see Breast drill. Rock drill.....		Electric elevated railway. Ephraim M. Turner, et al.....	41,424
Drill chuck. The Canadian Band Drill Co.....	38,906	Electric engine. Charles J. Van Depoele.....	38,557
Drilling apparatus: see Deep well drilling apparatus.....		Electric fire indicator. Thomas Ralph Douse.....	38,883
Drilling and boring machine for nuts, etc. Alfred Hugh Tyler, et al.....	38,981	Electric forging machine. John I. Gilbert.....	38,860
Drilling machine. Paul Prybil.....	38,708	Electric flat iron. Thomas Ahearn.....	39,917
Drilling machine. Percy J. Ogle.....	39,782	Electric head light. Richard Pattison, et al.....	39,046
Drilling tool. Alexander E. Brown.....	38,469, 38,470	Electric heat alarm. Morrill S. Pierce, et al.....	38,777
Drip board for sinks. Henry J. Coben.....	39,942	Electric heater. Thomas Ahearn.....	39,506
Driver: see Screw driver.....		Electric heating apparatus. Mark W. Dewey.....	39,326
Driver chain. Samuel L. Venson, et al.....	38,665	Electric heating apparatus for electric railway systems. Mark W. Dewey.....	41,071
Driving belt. Alfred J. Gasking.....	40,926	Electric heating apparatus for railway systems. Mark W. Dewey.....	39,644
Driving belt. Isaac Jackson.....	40,470	Electric heating apparatus for railway trains. Mark W. Dewey.....	39,300
Driving gear for wood planing and moulding machines. Louis T. Pyott.....	41,053	Electric ignitor for gas engines. Mora M. Barrett, et al.....	38,425
Drum: see Hot air drum.....		Electric insulation. Compound for. Ernest Fahrig.....	40,170
		Electric lamp. James W. Easton.....	39,692
		Electric lamps. Method of applying carbon filaments to. Augustus C. Carey.....	38,679
		Electric lighting system for trai s. Henry W. Leonard.....	39,972
		Electric liquid alarm. Frederick C. Skelton.....	39,740
		Electric main. Sebastian Z. de Ferrante.....	40,587

- Electric motor. Charles J. Van Depoele. 41,294
 Electric motor. Ernest M. G. Hewitt. 40,614
 Electric motor. James T. Wilson. 38,821
 Electric motor for wheeled vehicles. Robert S. Dobbie. 38,609
 Electric oven. Thomas Ahearn. 39,916
 Electric piano player. Joseph D. Case, et al. 39,494
 Electric railway. Charles Richter. 40,270
 Electric railway. Mark W. Dewey. 39,325
 Electric railway system. Charles J. Van Depoele. 38,559
 Electric refrigerating apparatus for railway cars. Mark W. Dewey. 39,327
 Electric refrigeration. Mark W. Dewey. 39,324
 Electric refrigeration. Method of. Mark W. Dewey. 40,986
 Electric regulator. James F. McElroy. 40,285
 Electric resistance. Composition for. Frederick W. A. Schneider. 39,030
 Electric semaphore. Frederick Stitzel. 39,445
 Electric semaphore. Frederick Stitzel, et al. 39,430
 Electric show case alarm. Rudolph C. Kruschke. 38,122
 Electric signal box. William E. Deerow. 40,160
 Electric signal for cars. Julius J. Wolf. 40,261
 Electric soldering and cementing. Apparatus for. Elihu Thomson, et al. 38,292
 Electric soldering, cementing, &c. Method of. Elihu Thomson. 38,576
 Electric soldering iron. Charles E. Carpenter. 40,245
 Electric soldering irons. Willard M. Miner. 38,332
 Electric switch. Charles G. Perkins. 40,644
 Electric switch. Francis Broadnax. 39,787
 Electric switch. Francis Davey, et al. 39,048
 Electric switch and cut-out. Charles W. Huntington. 40,448
 Electric time call. Richard Varley, et al. 39,557
 Electric train system : see Alternate current, electric train system.
 Electric transformer. Michael Von Dolivo Dobrowsky. 39,585
 Electric warming bottle. Thomas Ahearn. 39,915
 Electric water heater. Thomas Ahearn. 38,976
 Electric welding apparatus. Herman Lamp, et al. 38,082
 Electric welding. Method of. Elihu Thomson, et al. 38,373
 Electric welding. Process of. Elihu Thomson. 38,662
 Electric welding transformer. Herman Lamp. 38,663
 Electric apparatus for surgical and dental chairs. Cornelius B. Harness. 40,893
 Electric conduit. John Joseph Wright. 38,117
 Electric door bell pull. Lewis W. Cleveland. 38,098
 Electrical cut-out. Frank Bankson Rae, et al. 38,074
 Electrical distribution. System of. Charles G. Young, et al. 41,299
 Electrical elevator. Rudolph C. Smith. 41,037
 Electrical energy. Method of transforming and utilizing. Mark W. Dewey. 40,853
 Electrical heater. Charles C. Rich. 39,639
 Electrical locomotive. William H. Soley, et al. 40,451
 Electrical medical apparatus. Josephus C. Chambers. 40,035
 Electrical surgical instrument. Stephen R. Bradley. 41,020
 Electrical underground system of street car propulsion. Elias Hazelton, et al. 38,442
 Electro heating apparatus. Charles E. Carpenter, et al. 39,730
 Electro magnetic apparatus. Leonidas G. Wooley. 38,451
 Electro motive force regulator. Edward M. Bentley. 39,905
 Electro therapeutic apparatus. William Jas. Herdman. 39,031
 Electrode. Ludwig Epstein. 38,922
 Electrolytic apparatus. Thomas Craney. 40,970
 Electrolytic cell. Ernest A. LeSueur. 41,074
 Electrolytic electrometer. Alexander G. McKenna, et al. 39,929
 Electrotpe and stereotype blocks. Jacob C. Wolfe. 41,148
 Elevated railway. Henry K. Wicksteed. 38,644
 Elevator : see Crane and elevator. Electrical elevator.
 Elevator. Harriet R. Tracy. 38,570
 Elevator door. Wm. N. Anderson. 38,911
 Elevator for straw. James Buchanan. 41,021
 Elevating and transporting apparatus for freight. William H. Russell. 40,047
 Embalming. Method of. Graham H. Hamrick. 41,090
 Embellishing wood. Process of. Silas M. Land, et al. 40,990
 Embossing and ornamenting machine. George Staber, et al. 39,431
 Enamelling sheet iron ware. Process of. Hubert Claus. 40,891
 Endoscopic instrument. John W. Daily, et al. 40,892
 Engine : see Ammonia engine. Chemical engine. Chemical fire engine. Compound engine. Dental engine. Electric engine. Gas engine. Gas or gasoline engine. Hose wagon and chemical engine. Hydro-carbon engine. Liquid hydro-carbon motor engine. Oscillating engine. Rotary engine. Steam and air motive power engine. Steam engine. Water engine.
 Engine. John J. E. H. Payne. 39,794
 Engine to be worked by hot gases. Edward Field. 39,363
 Engineers' valve for automatic brake mechanism. Edward G. Shortt. 39,374
 Envelope. Edward H. Mass. 39,737
 Envelope. James West. 40,828
 Envelope. Peter Harvey Flynn. 38,192
 Envelope machine. Louis P. Bouvier, et al. 41,151
 Envelopes. Machine for making and placing enclosures therein. Timothy Stebbins, et al. 39,575
 Equalizer : see Draft equalizer.
 Eraser. George Washington Prouty. 38,962
 Evaporating and concentrating apparatus. Frank W. Scott, et al. 40,912
 Evaporating and concentrating solutions. Method of, and apparatus for. James A. Morrell. 40,740
 Evaporating apparatus. Theogene E. Richard. 40,666
 Evaporating apparatus. Thomas Craney. 38,565
 Excavator. Frederick W. Vollhering, et al. 39,142
 Excelsior machine. William S. Minor. 38,638
 Exchange : see Telephone and other electrical exchange.
 Exercising machine. Daniel L. Dowd. 39,220
 Exhaust valve for automatic brakes. Edward G. Shortt. 39,373
 Exhibiting apparatus. Charles S. Jenkins. 39,817
 Explosive compound. Addison C. Rand. 38,779
 Explosive compound. Silas R. Divine. 39,802
 Explosive shell. Henry P. Merriam. 40,098
 Explosives. Method of manufacturing. Stephen H. Emmens. 39,647, 39,648
 Extension ladder. John L. Kew. 38,696
 Extension ladder. Isaac T. Cross. 41,245
 Extension ladder. William J. Robertson, et al. 40,569
 Extension step ladder. Andrew J. Myers. 38,520
 Extension table. Clarence M. Herr, et al. 39,420
 Extension table. Frederick P. Cobham. 38,250
 Extension table. Joel Couch, et al. 39,108
 Extension table. Johann F. Wiggers. 39,671
 Extension table. Joseph A. Ethier. 40,241
 Extension table. Warren Williams. 40,392
 Extension table. William H. Pickett. 38,752
 Extinguisher for fires. Henry A. Mansfield. 40,056
 Extinguisher for lamps. Henry J. Clarry. 38,302
 Extinguisher for lamps. James Bernard Dowdall. 38,995
 Extinguisher for lamps. Misael Lajoie. 38,758
 Extractor : see Gold extractor. Honey extractor. Hydraulic stump extractor.
 Eye : see Screw eye.
 Fabric : see Roofing fabric. Woven fabric.
 Fabric cutting apparatus. The Fustian Cutting Machine Company. 38,861
 Fabric. Machine for making netted wire. Theodore McLarran Connor, et al. 40,885
 Fabric. Machine for weaving wire and slate. Marion S. Cadwell. 39,851
 Fabric. Method of and apparatus for weaving coiled wire. Clarence O. White, et al. 39,982
 Fabric for personal underwear. Joseph Raab. 40,474
 Fabrics. Frame for stretching. Samuel Hough. 39,268
 Fabrics. Machine for making. Caroline A. Whipple. 39,731
 Fabrics. Method of and apparatus for shaping tubular. Dewey A. Cobb. 40,787
 Fan : see Foot power fan.
 Fanning mill. Ninian M. Newkirk. 38,409
 Fare and baggage checking system. James P. Martin. 41,181
 Fastener : see Automatic fastener. Key fastener. Sash cord fastener. Spring fastener.
 Fastener for belts. Frederic E. Shant. 40,762
 Fastener for belts. Gilbert P. Kenehan. 39,580
 Fastener for belts. Isaac Jackson. 41,087
 Fastener for boots and shoes. Jacob H. Markle. 39,444
 Fastener for car doors. Frank Hallegan. 39,060
 Fastener for collars. F. H. Keckenapp. 38,028
 Fastener for fuse caps. Nathan W. Moody. 39,970
 Fastener for oven doors. James Thompson. 39,139
 Fastener for shoe ties. John Benton Craig. 38,270
 Fastener for storm sashes and window screens. Lee Hall. 39,162
 Fastener for stove pipes. Martin W. Bloomburg. 40,711
 Fastener for thill loops. Henry R. Schuarr. 41,201
 Fastener for trunks. Joshua L. Jones. 41,178
 Fastening for shoes. Charles A. Harvey. 38,650
 Fastening for stove pipes. John H. Johnston, et al. 39,630
 Faucet : see Beer faucet.
 Faucet. H. Luse. 39,610
 Faucet. Levi Lewis Hall. 38,314
 Faucet for barrels. Mark Anthony. 38,940
 Feed trough. Cora B. Snellenberger, et al. 40,463
 Feed trough. Earl B. French. 39,159
 Feed water heater and purifier. August Krumholz. 38,952
 Feed water heater and purifier. Robert Learmonth. 39,034
 Feed water heater and purifier. Virgil H. McConnell. 41,347
 Feeder : see Band cutter. Band cutter and feeder.
 Feeding machine for carding engines. Luther A. Peckham, et al. 40,633
 Feeding mechanism for carding machines. Luther A. Peckham. 40,651
 Feller : see Hemmer and feller.
 Felting fur bodies. Process of. Howard W. Flagg. 38,096
 Fence : see wire fence.
 Fence. Albert L. Bonnaffon. 39,826
 Fence. Frederick P. Roseback, et al. 39,967

- Fence machine. Henry J. Gebhardt. 40,749
 Fence machine. William P. Shattuck. 39,952
 Fence post. Benjamin F. Randall. 39,183
 Fence post. Hiram Alden Fenner. 38,185
 Fence post. Peter W. Weunnett. 38,108
 Fence tightener. Thomas J. André. 39,079
 Fence tool. James Heard, et al. 41,293
 Fender: see Electric car fender.
 Ferrule. Frank Grant, et al. 38,673
 Fertilizer. Thomas M. Smith. 40,475
 Fertilizer distributor. John Fraser. 40,209
 Fertilizer distributor attachment. John M. Robinson. 38,656
 Fertilizing material. Apparatus for spreading. Warren T. Butler. 40,782
 Fibre: see Vegetable fibre.
 Fibre yarns, etc. Treatment of. George E. Armstrong. 41,222
 Field range. John Marcee. 40,423
 Fifth wheel. Abner B. Bishop. 39,311
 Fifth wheel for vehicles. Lewis S. Browning. 41,007
 Filaments for electric lighting. Art of making. Detlef C. Voss. 40,541
 File: see Bill file. Letter file. Letter and bill file.
 File. Alysius G. Bhoscoe. 39,378
 File case. Major Romeyn Jewell. 38,982
 Files and rasps. Manufacture of. Alfred Weed. 38,157
 Filler: see Bag filler. Grain measure and filler. Oil can filler.
 Filler for blast furnaces. Alexander E. Brown. 39,287
 Filler for cigars. Apparatus for making. Max Van Gulpen. 41,325
 Filter. David Williamson. 38,572
 Filter. Edward M. Knight. 39,548
 Filter. Henry Roeske. 39,438
 Filter and heater for steam boilers. William Dougherty. 40,158
 Filter for water taps. James Mortimer. 38,827
 Filter for water. Tom McKay. 39,344
 Filtering machine. Edgar Martin. 40,752
 Filtering machine. James A. Crocker. 39,661
 Filtering tube for molten glass. Moritz E. Pastein. 41,158
 Filtering. Process of. James A. Crocker. 39,662
 Finger bar for harvesters. Lyman M. Jones, et al. 39,754
 Fire alarm. John P. McMahon. 39,541
 Fire arm. William D. Forbes. 39,154
 Fire escape. Charles E. Sansoucy. 39,914
 Fire escape. George C. Foose. 39,424
 Fire escape. Heinrich Friedlaender. 40,928
 Fire escape. Henry Schwannecke. 38,641
 Fire escape. James H. McPartland. 38,917
 Fire extinguisher. Charles W. Kersteler. 39,701
 Fire extinguisher. George H. Downing. 40,278
 Fire extinguisher. George W. Hoglen. 39,149
 Fire extinguisher. Israel Lewis Carr. 39,138
 Fire extinguisher. Robert Wilkinson Newton. 38,870
 Fire extinguishing compound. Max Elberhardt, et al. 38,107
 Fire lighter. James McDougal. 38,432
 Fire proof buildings. Method of constructing. Mitchell F. McCarthy. 39,530
 Fire proof door. Reuben Haltenstein. 40,091
 Fire proof floors. Thomas A. Lee. 38,346
 Fish hook. Charles A. Haveland. 39,382
 Fish hook. John T. Eichelberger. 38,160
 Fish. Mode of drying. Cathcart Thomson. 39,397
 Fish plate for rails. Otto Umlauf. 40,583
 Fish way. John Bower. 40,020
 Fishing apparatus. Ira Dunham. 40,265
 Fishing device. Charles A. Kuenzel. 41,378
 Fish for food. Method of preparing. Reter W. Schonau. 38,756
 Fishing rods and reels. John Miles Finch. 38,858
 Fitter: see Dress fitter.
 Fixing and washing tank for photographic purposes. Albert R. Ward. 40,527
 Flange for loom beams and warper beams. William Stafford. 38,164
 Flat iron: see Electric flat iron.
 Flat reliefs for wall ornamentation. Method of producing. Paul Klincka. 40,865
 Flax. Machine for preparing. Alexander Morison, et al. 40,076
 Flexible metal tubing. Gotthard Commichan. 40,104
 Floating apparatus. Adolf Prusmann. 39,688
 Flood gate. Joshua Shellaborger, et al. 38,435
 Floor: see Fire proof floor. Malt floor. Pavement.
 Floor. Otto Hetzer. 39,706
 Floor jack. Giles Bowler, et al. 38,776
 Floor joists. Art of and apparatus for crowning. Joseph Fredericks. 41,400
 Floor or roof for buildings. George W. Parker, et al. 40,975
 Flounce and belt. Adolph Newville. 38,263
 Flour and dough. Apparatus for testing and recording the test of. James Hogarth. 39,303
 Flour and dough. Method and means of testing and recording the properties of. James Hogarth. 39,222
 Flour bolt. Benjamin Barter. 38,289
 Flour bolt. Charles A. Schied. 38,403
 Flour cabinet. Albert A. Tinker, et al. 38,778
 Flue for fire places. Kenneth McKenzie, et al. 40,393
 Fluid for generating motive power. William Hawkins, et al. 39,739
 Fluid for primary batteries. Theophilus Coad. 40,325
 Fluid fuel. Device for feeding. Walter B. Wright. 39,994
 Fluids. Method of, and means for measuring. John Thomson. 40,954
 Flushing apparatus for water closets. Arthur O'Brien. 41,103
 Flushing device for sewers. Levi Stanworth. 39,279
 Fly trap. William J. Kayser, et al. 41,044
 Fog signal. Walter R. Cross. 39,516
 Folding base for stands. Samuel E. Reutter. 40,533
 Folding bed. Philip Herbold. 39,055
 Folding bed, billiard table, rack, and setter combined. Robert N. Barger. 40,598
 Folding chair. Allan Loudon. 39,820
 Folding chair. Joseph Coulter. 39,210
 Folding key board for organs. Frederick W. Hedgeland. 38,591
 Folding rocking chair. John Thornbeck. 40,717
 Food compound. Clifford Saville. 39,058
 Foot for dredge anchors. William Pike, et al. 41,211
 Foot power fan. William A. Hart. 40,663
 Foot power for sewing machines. Charles Nicholson. 40,790
 Foot support for telegraph poles. Emma Augusta Streeter. 39,136
 Foot warmer. Albert A. Herser. 38,392
 Force pump. Mott Billings Brooks. 38,184
 Fork: see Spoon and fork.
 Fortification: see Revolving fortification.
 Foundation for structures. Robert Lewis Harris. 38,968
 Fountain flower holder. Ewing Buckham. 38,485
 Fountain pen. Charles E. Browning. 40,741
 Frame: see Umbrella frame.
 Frame for railway cars. Max A. Zurcher. 39,694
 Frame for tiles. Reverius Marsh. 41,188
 Freezer for ice cream. Charles L. Bellamy. 39,077
 Freezer for ice cream. Charles G. Shepard. 39,635
 Freezer for ice cream. Henry W. Atwater. 39,602
 Friction clutch. Arthur W. Robinson. 41,202
 Friction clutch. Henry W. Hill. 39,485
 Friction coupling. August Schroeder. 39,537
 Friction. Method of magnetically reducing. Mark W. Dewey. 40,206
 Frog: see Railway frog.
 Frog and switch for railways. David Harne, et al. 38,836
 Frog for railways. Arel A. Storm. 41,306
 Frog for railways. Perry P. Merriman. 38,512
 Frog for spring rails. Henry Elliot. 40,151
 Fruit basket. William E. Field. 40,539
 Fruit basket and cover. Victor H. Carpenter. 39,059
 Fruit box. Julius F. Hunt, et al. 40,941
 Fruit canning device. John J. Isler. 41,249
 Fruit gatherer. George A. Marsh, et al. 40,134
 Fruit jar. Delmar E. Askly. 38,428
 Fruit. Method of preserving. Charles F. Morris, et al. 38,709
 Frying pan. Emma L. Robertson. 38,686
 Fuel: see Artificial fuel.
 Fuel. Method of and apparatus for making artificial. Geo. Y. Smith. 39,800
 Furnace: see Boiler and furnace. Burner and furnace. Dry kiln furnace. Hot air furnace. Hot water furnace. Muffle furnace. Stove furnace. 40,476
 Furnace. Daniel Perry, et al. 39,440
 Furnace. Ellis F. Edgar. 40,721
 Furnace. Evan W. Jones. 41,236
 Furnace. George R. Scates. 41,356
 Furnace. James S. Ecker, et al. 40,582
 Furnace. Wilhelm Kohler, et al. 40,995
 Furnace and furnace grate. Alfred Wilkinson. 40,647
 Furnace for evaporating and calcining alkaline solutions, &c. Henry Blackman. 39,171
 Furnace for hot water. Thomas Brooks. 41,412
 Furnace for metallurgical operations. John N. Lauth. 39,955
 Furnace for roasting ore. Horace F. Brown. 39,955
 Furnace for roasting ore. Jacob C. Wiswell, et al. 40,297
 Furnace for steam boilers. Melville C. Hawley. 39,439
 Furnace for steam boilers. Michael E. Herbert. 39,439
 Furniture. Device for raising or lowering. John D. Raymond, et al. 38,459
 Fuse. Edwin W. Rice. 39,907
 Gage: see Axle gage. Shingle gage.
 Gage cock. James D. Mitchell. 40,730
 Galley: see Printers galley.
 Galvanic battery. Walter A. Crowlus. 38,352
 Galvanic battery. Exciting fluid for. Doctor L. Weigert. 38,781
 Galvanic batteries. Depolarizing liquid for. Oscar Schlesinger. 41,143
 Game. Branch Harris Colby, et al. 38,899
 Game. Frank C. Hamilton. 38,534
 Game. George F. Devine, et al. 38,248
 Game. James Prendergast. 39,383
 Game. John S. Ellis, et al. 39,006
 Game. Oscar M. Hulner. 40,087
 Game. Samuel W. Clarke. 38,923
 Game counter. Albion Smith. 39,822

Game counter. Phillip Hale.....	41,392	Glycerine from spent soap lye. Method of making. Albert Domeier, et al.....	40,708
Gaming and sawing machine. Joseph F. Berkenfeld.....	39,039	Glycerine for spent soap lye. Method of recovering. Ebenezer K. Mitting.....	40,701, 40,704
Gang plow. Richard L. Penn.....	46,435	Glycerine. Method of purifying. Otto C. Hagemann.....	40,732, 40,733
Gang saw mill. Theodore S. Wilkins.....	40,313	Glycerine recovered from soap lye. Apparatus for distilling. Albert Domeier, et al.....	40,732, 40,733
Gang saw mill. William T. Mackey.....	41,035	Gold concentrator. William H. Hill.....	40,593
Garbage, night soil, &c. Method of, and apparatus for destroying. Andrew Engle, et al.....	38,783	Gold extractor. Louis Sanson.....	38,472, 38,473
Gardening implement. Thomas William Breen.....	38,941	Governor for dynamos. Mohlon Smith Conly.....	39,090
Garment stays. Method of, and machine for making. Frederick Crompton.....	39,322	Governor for gas engines. William S. Sharpneck.....	40,516
Gas apparatus. James W. Tallmadge.....	39,552	Governor for power engines. Arnold Willmer.....	39,806
Gas. Apparatus for making illuminating. Robert Laird.....	40,490	Governor for steam engines. Frank H. Ball.....	39,218
Gas. Apparatus for manufacturing. James R. Kendall.....	39,165	Governor for steam engines. George Fassell.....	38,615
Gas. Apparatus for manufacturing hydrogen. Vivian B. Lewes.....	39,473	Governor for steam engines. George H. Evans.....	41,026
Gas. Apparatus for separating oil and water from. Charles L. Stock.....	38,695	Governor for steam engines. William O. Webber.....	40,654
Gas attachment for cooking stoves. Richard Bigley.....	39,613	Grab bucket. Alexander E. Brown.....	38,471
Gas burners: see Cut off for gas burners.		Grader: see Scalper.	
Gas burner for furnaces. James S. Rogers.....	39,948	Grain binder. Earl G. Watrous.....	39,719
Gas burner for heating purposes. Phillip Lesser.....	39,626	Grain binder. James R. Severence.....	39,174, 39,193
Gas condensing and enriching apparatus. Ernest A. Harris, et al.....	39,755	Grain binder. John S. Davis.....	39,884, 40,738, 40,788
Gas engine. Charles White, et al.....	40,616	Grain binder. Louis H. Grieser.....	40,553
Gas engine. Charles W. Pinkney.....	40,096	Grain binder. Lyman M. Jones, et al.....	39,900, 39,901
Gas engine. Edwin W. Evans.....	40,428	Grain binder. Watson M. Holmes.....	39,714
Gas engine. Henry T. Dawson.....	38,416	Grain binders. Knottter for. Andrew Stark.....	41,059
Gas engine. Herbert Akroyd Stuart, et al.....	38,934	Grain binders. Starting mechanism for. John S. Davis.....	40,900
Gas engine. Mora M. Barrett, et al.....	39,260	Grain cleaning machine. Joab C. Fisher, et al.....	38,610
Gas engine. Paul de Susini.....	39,065	Grain conveyor. Frederick E. Duckham.....	40,088
Gas engine. William Heckert.....	39,759	Grain conveyor for harvesters. John S. Davis.....	40,161
Gas engines. Method of operating. Henry Hoelljes.....	40,169	Grain drier. Frederick H. C. Mey.....	39,607
Gaseous mixtures. Method of obtaining the constituents of. James H. Parkinson.....	41,027	Grain drill. Martin L. Kissell.....	39,689
Gas lamp. Fritz Stellwag.....	39,573	Grain drill. Thomas Renwick.....	39,513
Gas lamp. Thomas C. J. Thomas.....	39,481	Grain. Machine for decorticating and disintegrating. Francois Quenehen, et al.....	39,576
Gas. Lighting and extinguishing apparatus for. Nathaniel Hersey Shaw, et al.....	38,874	Grain. Machine for grinding, crushing or disintegrating. Sydney Straker.....	39,627
Gas making apparatus. George S. Sandford, et al.....	40,939	Grain. Machine for preparing. Charles Lampitt.....	39,949
Gas. Manufacture of illuminating. Charles Bougourd de Lamarre, et al.....	39,063	Grain measurer and bag filler. George Albert Metcalfe.....	38,909
Gas. Manufacture of illuminating. Treat T. Prosser, et al.....	38,329	Grainer for salt. Thomas Craney.....	38,674
Gas. Method of making illuminating. John H. Ferguson.....	39,650	Graining on the surface of wood. Method of producing. Frank A. Waters.....	39,974
Gas. Method of making illuminating. Julius Wiesender.....	40,552	Graphophone. John H. White.....	40,194
Gas. Method of making. Wallace C. Andrews.....	39,760, 39,761	Grapple. Arthur W. Covell.....	39,515
Gas. Method of making oxygen. George Webb, et al.....	39,748	Grass catching attachment for lawn mowers. Jacob L. Bieder.....	39,487
Gas or electric heater for water. Christopher Clift.....	39,319	Grate. Elouzo J. Gordon.....	39,037
Gas or gasoline engine. Benjamin C. Vanduzen, et al.....	39,526	Grate. Thomas Ruddell.....	38,510
Gas. Process of and apparatus for making. James S. Rogers, et al.....	40,810	Grate bar. Etienne Boileau.....	38,419
Gas. Process of, and apparatus for making fuel. Thomas B. Fogarty.....	40,972	Grate bar. George B. Norgrave.....	39,967
Gas. Process of, and apparatus for manufacturing. Burdette Loomis.....	38,151	Grate for furnaces. John L. Mason.....	40,783
Gas. Process of, and apparatus for producing oxygen. Robert D. Bowman.....	40,804	Grater. Alice E. Thomas, et al.....	40,154
Gas. Process of, and means for increasing the flow of natural. James W. Strouse, et al.....	39,621	Grease from textile fabrics. Apparatus for removing. Thomas J. Hutchison.....	41,300
Gas. Process of producing heating. George A. Watson, et al.....	40,974	Grinder: see Sickle grinder.	
Gas stove. Thomas Batty.....	41,404	Grinding and amalgamating pan. William Roberts, et al.....	39,961
Gas tap. Law Heppenstall.....	40,094	Grinding mill. James Jones, et al.....	39,909
Gate: see Floodgate. Safety gate.		Grooves and channels in wood. Apparatus for cutting. Ewald Muller.....	39,697
Gate. George M. Shoebottom.....	38,125	Guard: see Cattle guard. Dust guard.	
Gate. Hiram Duperow.....	38,762	Guard for railway tracks and switches. Michael Riley.....	41,284
Gate. Lewis T. Page.....	40,847	Guard for razors. Peter D. Murphy, et al.....	38,786
Gate. Philander Wood.....	38,703	Guard for vehicle wheels. Henry F. Ganon, et al.....	40,696
Gate. William Chambers.....	40,040	Guard ring. Josephine H. Bullard.....	38,490
Gate. William R. White.....	41,184	Guide: see Key hole guide.	
Gate and hinge. John B. Erwin.....	39,262	Guide rod for the tops of freight cars. Michael Sullivan.....	38,086
Gate for draw bridges. William Goddard.....	40,882	Gully: see Concrete stone gully.	
Gate latch. Henry C. Huffman, et al.....	40,883	Gun moistener. Alfred Gartner, et al.....	39,830
Gates. Hanger and fastener for. James H. Coleman.....	39,225	Guns. Method of treating. Ella T. H. Smith, et al.....	38,757
Gear: see Carriage gear. Draw gear. Driving gear. Reversing gear. Spring gear. Valve gear. Vehicle gear.		Gun: see Blow gun. Boomerang gun. Magazine gun.	
Gear connection for vehicles. Garland B. St. John.....	39,746	Gun. Frank M. Garland, et al.....	40,276
Gear for carriages. Robert McLaughlin.....	38,052	Gun. Robert M. Catlin.....	39,772
Gear for electric railway cars. George R. Baldwin.....	40,442	Gun triggers. Safety catch for. William E. Jenkins, et al.....	38,189
Gear for vehicles. John M. Holler.....	40,784	Hair. Method of making curled. Peter Woll.....	40,822
Generator: see Calelectric generator. Steam generator.		Hair pin. John T. Larkin.....	41,131
Generator for electricity. William Henry.....	39,069	Halter. Robert Bruce.....	40,359
Generator for steam. Darwin Almy.....	40,775	Halter for horses. Thomas Morton.....	38,992
Generator for steam. Emmet Horton, et al.....	40,311	Hamme. Adolphus V. Cronk.....	38,871
Generator for steam. Thomas F. Morrin.....	40,768	Hammer: see Power hammer.	
Gigging and shearing machine. Henry S. Greene, et al.....	40,052	Hammer. William Jacoby.....	39,123
Gill net puller. Robert O'Neil, et al.....	41,328	Hammer and nail puller. Robie Blake.....	40,216
Glass. Method of decorating. George W. Martin.....	38,299	Hammock. Charles Johnston.....	41,189
Glass. Substitute for. Friedrich Eckstein.....	40,022	Hand dating stamp. Henry T. Pritchard.....	40,018
Glassware. Machine for pressing and blowing. Evan Jones et al.....	40,367	Hand rake. Orville E. Knox.....	38,174
Glove. Alois B. Fischl.....	39,685	Hand rake. Peter McMichael.....	38,509
Glove. Simon Frankenbach.....	39,351	Handle for caskets. John D. Ripson, et al.....	39,789
Glove fastening. Friedrich Maisch.....	40,964	Handle for caskets. John McCarthy.....	38,524
		Handle for files. John W. Payler.....	39,443
		Handle for pumps. Charles A. Sellon.....	40,989
		Handle for saws. Edward W. Miller.....	41,411
		Hanger for doors. Albert B. Pullman.....	39,601
		Hanger for lamps. Thomas Hipwell.....	39,892
		Harness. Henry E. King.....	40,800
		Harness. James A. Macrae.....	41,166

Harness. Louis Damhauser.....	39,495	Holder for car tickets. William B. Moore, et al.....	38,134
Harness attachment. Alfred E. Choquette.....	40,269	Holder for check books. James L. McGervey.....	39,110
Harness saddle-trees. Machine for making. William H. Bustin.....	39,818	Holder for check reins. Frederick P. Thompson.....	41,313
Harrow: see Disk harrow. Rotary harrow. Reversible harrow. Sulky spring tooth harrow.....		Holder for copy. Charles E. Burthaver, et al.....	40,152
Harrow. Aaron J. Nellis.....	39,768	Holder for copy. Gustave H. Grabe, et al.....	40,097
Harrow. Andreas Wilfert.....	40,437	Holder for demijohns. Eric W. H. Holme.....	38,452
Harrow. George Herbert Mackey, et al.....	38,898	Holder for electric lamps. James G. Wood.....	41,291
Harrow. Joseph Drader, et al.....	39,531	Holder for horses. John Bell.....	40,119
Harrow. Orrin R. Baldwin.....	40,824	Holder for jewels. Frank R. Cunningham, et al.....	38,059
Harrow. Robert Neville.....	40,406	Holder for pictures. Maurice Wirths.....	38,592
Harrow sulky spring tooth. Thomas G. Cook, et al.....	38,148	Holder for labels. Enory E. Smith.....	41,365
Harrows. Levelling attachment for. Lorenzo D. Corser, et al.....	38,843	Holder for parcels, &c. Daniel W. Long, et al.....	40,254
Hat case. David H. Sanders, et al.....	38,805	Holder for pencils and crayons. William W. Climenson.....	38,216
Hat and coat hook. Thomas Moody.....	39,983	Holder for phones. Jehiel Moore.....	40,661
Hat polishing and cleaning machine. Cesar Simis, et al.....	39,306	Holder for shirt collars. Frank L. Robinson.....	41,372
Harvester. Thomas C. Wilkins.....	40,440	Holder for shoe button fasteners. Alexander G. Wilkins.....	38,360
Harvester binder. Lyman M. Jones, et al.....	38,063	Holder for spools. Oscar J. Israel, et al.....	41,028
Hay elevator and carrier. William Loudon.....	40,411	Holder for tools. Anson Groves Roman.....	38,104
Hay press. Louis Primeau.....	41,319	Holder for twine. John B. Holmes.....	39,880
Hay rack. Eli White.....	41,393	Holder for wool thread, &c. James Dennis, et al.....	41,286
Hay rack. Henry S. Hoy.....	39,605	Holder and cutter for roll paper. Duncan McLachlan, et al.....	39,205
Hay rake. Samuel Buschlen.....	41,278	Holder and cutter for thread. Henry Oakes, et al.....	38,573
Hay, &c. Machine for stacking. Daniel H. Talbot.....	40,468	Holdback. John H. Logan.....	40,993
Head light: see Electric head light.....		Hollow articles. Apparatus for making. Frank Moorfield.....	40,962
Head light for steam threshers. Frank H. Wilson.....	39,056	Honey extractor. William Beyless.....	41,234
Heat into mechanical energy. Method of transforming. Hermann Mehner.....	39,151	Hood: see Vestibule hood.....	
Heater: see Calorific generator and heater. Cooking stove and house heater. Electric heater. Electric water heater. Feed water heater. Filter and heater. Gas or electric heater. Hot water heater. Open fire place heater. Sectional water heater. Ventilating heater. Water heater.....		Hook: see Check hook. Display hook. Fish hook. Hat and coat hook.....	
Heater. Elijah S. Wilber.....	40,389	Hook. Ezra Dederick.....	39,104
Heater. Frank C. Peteler.....	40,176	Hook and holder for check reins. Oliver Kennedy.....	39,163
Heater. George W. Harris.....	39,707	Hook for garments. William Henry Hart.....	39,095
Heater. Harry W. Sisson.....	40,348	Hoop: see Strap and hoop.....	
Heater. John Graves.....	41,323	Hops. Method of treating. Charles H. Frings, et al.....	40,629
Heater. Richard Bigley.....	39,617	Horn: see Drench horn.....	
Heater for cars. Cyrus S. Dean.....	40,659	Horse: see Hobby horse.....	
Heater for feed water. Charles Jacobs.....	40,307	Horse attaching and detaching device. Charles E. Harris.....	41,336
Heater for gas. Arnovitz Wolff.....	40,498	Horse collar. Carl A. R. Ahl, et al.....	40,669
Heater for street cars. James Allingham.....	40,716	Horse collar. John MacGregor.....	40,673
Heater for water. James F. McElroy.....	40,239	Horse detacher. Charles Joseph Walsler.....	38,869
Heater for water. Lucius L. Culver.....	40,613	Horses from cribbing. Apparatus for preventing. John Christensen, et al.....	38,196
Heater for water. Robert F. Walsh.....	40,429	Horse hay rake. Horace A. Alden, et al.....	39,167
Heating: see Electro-heating. Steam heating system.....		Horse hay rake. William J. Risdorph, et al.....	40,857
Heating apparatus. Ellis F. Edgar.....	39,433	Horse poke. John J. Magee.....	38,501
Heating apparatus. John N. Gates, et al.....	39,213	Horse shoe. Charles Hammelmann.....	39,087
Heating apparatus. Mary Roe.....	41,018	Horse shoe. Daniel C. Dwyer, et al.....	40,537
Heating apparatus. Otto Schulze.....	39,776	Horse shoe. Joseph Benfield.....	41,321
Heating apparatus for air. John A. Kirkpatrick.....	40,192	Horse shoe. William H. Moore.....	38,311
Heating apparatus for street cars. James F. McElroy.....	40,055	Horse shoe guard plates. Tool for applying and removing. George T. Chapman.....	40,917
Heating an automatic water supply chemically. Method of and apparatus for. Thomas Ahearn.....	39,508	Horse shoe machine. John E. Bucklin, et al.....	41,375
Heating and lighting. Device for. Lewis T. Wilcox.....	40,677	Horse shoe nails. Machine for forging. David F. Williams.....	41,355
Heating and welding by the electric arc. Henry Howard.....	38,626	Hose clamp. The Syracuse Specialty Manufacturing Co.....	39,012
	40,068	Hose coupler. Henry A. White, et al.....	39,118
Heating apparatus for railway cars. James F. McElroy.....	41,430	Hose coupling. James F. McElroy.....	39,404
Heating apparatus for railway cars. Thomas S. Lapraik.....	41,170	Hose coupling. Frederick W. Wright.....	40,639
Heating system. Joseph H. Griffith, et al.....	40,048	Hose nozzle. Thomas J. Carroll.....	41,135
Heel block. Warren H. Carr, et al.....	38,145	Hose wagon. Chemical engine and hose reel combined. Alexander W. Aitchison.....	39,450
Heel stiffeners. Machine for moulding. William C. Stewart.....	40,432	Hosiery. Thomas West.....	39,996
Hedges: see Trees and hedges.....		Hot air drum. Ezra T. Whiting.....	38,253
Heel trimming machine. Charles W. B. Fuller, et al.....	40,135	Hot air furnace. Henry Cowles.....	39,695
Hemmer and feller. Stephen Laskey.....	40,103	Hot air furnace. Martin Koehler.....	39,657
Hemp brake and cleaner. John D. Shely, et al.....	38,396	Hot air furnace. William Thuener, et al.....	39,512
Hernia pad. Charles Cluth.....	40,919	Hot air furnace. William W. Kelsey.....	39,358
Hides: see Tanning hides.....		Hot air furnace. Enock B. Butterworth.....	38,718
Hides. Process of tanning. William Zahn, et al.....	40,171	Hot air furnace. Robert Tate.....	40,415
High and low water alarm. John M. Williams.....	38,580	Hot air furnace. Dwight S. Richardson.....	38,643
Hinge: see Door hinge. Gate and hinge. Spring hinge.....		Hot air furnace and cooking stove. Frank Moses.....	41,351
Hinge for school seats. Edward M. Dennis.....	38,867	Hot air pipe and air flue. Ernest A. Eversman, et al.....	41,429
Hinges. Means for operating lock. Levi Abbott, et al.....	38,543	Hot blast stove. Charles H. Foote.....	40,072
Hitching strap. Harrison Cole.....	39,745	Hot blast stove. George W. McClure.....	41,269
Hobby horse. Martin Bohlig.....	39,572	Hot water attachment for stoves. Golbert F. Brewer.....	41,310
Hoist and travelling carrier. Wellington C. Wilcox, et al.....	40,603	Hot water boiler. Enock B. Butterworth.....	38,528
Hoisting and conveying machine. Alexander E. Brown.....	38,467	Hot water furnace. Eugene S. Manny.....	40,427
	38,468	Hot water heater. David L. Dwinell, et al.....	38,062
Hoisting and conveying machine. Thomas S. Miller.....	40,259	Hot water heater. Edward Gurney.....	40,567
Hoisting apparatus. James Gibbins.....	40,132	Hot water heating system. Eugene N. Gates, et al.....	40,315
Holder: see Brush holder. Fountain flower holder. Joint holder. Paper holder. Pen holder. Soap holder. Sash holder. Spool holder.....		Household alter for sacramental purposes. Leo C. Beaudet.....	38,479
Holder for air brake hose. Samuel M. Berry.....	38,378	Household utensil. Henry H. Barry, et al.....	38,682
Holder for bags. Frederick S. Hemming, et al.....	38,542	Hub: see Lubricating hub.....	
Holder for ballots. William F. Wilkins, et al.....	39,529	Hub blocks. Process of seasoning. Henry Lex DuBois, et al.....	38,288
Holder for bed clothes and babies. Karl Kanzler.....	38,056	Hub boring machine. Alfred Bonner, et al.....	40,046
Holder for candles. Gustave Gurtler.....	39,315	Hulls of vessels. Method of constructing the. James Frederick Hodgetts.....	8,0393
Holder for cartridges. Albert H. Dean.....	38,693	Hydrant. Adam Schneid.....	40,177

Hydrocarbon. Method of, and apparatus for distilling liquid. Paul Dvorkovitz.	41,275	Journal bearings. Francis B. Torrey.	40,559
Hydrocarbon. Method of treating liquid. John H. W. Stringfellow.	40,073	Journal bearings for railway cars. Charles E. Stanfield.	41,399
Hydrogen. Process of manufacturing. Vivian B. Lewes.	39,497	Journal box. John Z. Nyquist.	41,410
Ice cream freezer. David C. Camp.	41,288	Journal box for steam engines. William Fussell, et al.	38,658
Ice cream freezer. John E. Newhouse.	41,409	Keel for vessels. John Grothgar, et al.	39,461
Ignition in gas engines. Ernest Karting.	39,807	Kettle: see Tea kettle.	
Ignitor: see Electric ignitor. Magnetic electric ignitor.		Kettle. William H. Holden.	38,614
Incandescent burner for hydrocarbon gas. James S. P. Stutley.	39,980	Key board for musical instruments. Frederick J. Stimson, et al.	40,255
Incandescent electric lamp. Elihu Thomson.	39,814	Key boards. Method of making. William C. Zeidler, et al.	38,397
Incandescent electric lamp. Ephraim E. Weaver, et al.	40,095	Key fastener. John J. Travis, et al.	38,328
Incandescent electric lamp. Method of repairing. Casimir Panthomer.	41,308	Key hole guide. Charles Norman Holdenby.	38,930
Incrustation from steam boilers. Apparatus for removing. James P. Karr.	40,958	Key wedge for easels. Richard H. Graves.	38,961
Incubator. Earl Barney.	41,385	Kiln: see Brick kiln.	
Index. Henry S. Bacon.	41,237	Kiln. John H. Thissen, et al.	40,764
Indicating electric switch and current reverser. Almon B. Strowger.	39,964	Kiln. Henry Warrington.	40,820
Indicator: see Electric fire indicator. Night light and time indicator. Station indicator. Street indicator. Water indicator.		Kiln. William A. Eudaly.	40,794
Indicator and register for cash. Edward B. Parkhurst.	40,193	Kiln. William Johnson.	41,390
Indicator and register for cash. Frederick L. Fuller, et al.	40,985	Kiln floor for drying cement. Henry Faiga.	39,758
Indicator for laundries. Charles W. Turner.	38,257	Kiln for brick. Michael J. Hynes.	39,192
Indicator for liquid measures. Thomas Hipwell.	39,893	Kitchen utensil. Horace B. Wiley, et al.	38,246
Indicator for stations. Irene N. Soly, et al.	38,444	Kite. Thomas Ansboro, et al.	39,196
Induction discharge protector for welding apparatus. Elihu Thompson.	38,294	Kneading board. Mary M. Everhard.	38,984
Induction motor. Charles L. Van Depeole.	38,555	Knee for bob-sleighs. Parker Waite.	39,181
Ingot: see Compound ingot.		Knife: see Chopping knife.	
Inhaler. Roland E. Woodward.	38,264	Knife for binders, &c. Thomas K. McQueen.	38,235
Inhaler and indicator. John J. Senunbaugh.	41,177	Knives. Apparatus for cleaning. Albert A. Storey.	38,584
Injector: see Blower and injector. Centrifugal steam injector. Steam and air injector.		Knives for mowers and reapers. Machine for grinding. Alexander M. Caron.	38,993
Injector. Louis Schutte.	39,208	Knitted bags. Frank Clewby, et al.	38,033
Injector. Robert G. Brooke.	39,496	Knitting machine: see Circular knitting machine.	
Injector for steam and air. Frederick Leadbeater.	40,032	Knitting machine. Arthur Wrightson, et al.	39,868
Ink bottle. William Fremont Hall.	38,875	Knitting machine. Ashley J. Gulick, et al.	41,298
Ink bottle. William G. Collins.	40,430	Knitting machine. Hiram P. Ballou, et al.	39,809
Inkstand. Emory Davis.	39,088	Knitting machine. John Bradley.	40,619
Inkstand. William J. Sawyer.	41,293	Knitting machine. Robert King.	40,078
Inkstands. Attachments for. Barclay M. Everson.	38,221	Knitting machine. Robert W. Scott, et al.	39,490
Inkstands. Fountain attachment for. James V. Bergen.	41,062	Knitting machines. Tufting attachments for. Joseph D. Partello, et al.	40,546
Ink well cover. Almerin R. Sprague.	41,289	Knotted for harvester binders. John F. Seiberling, et al.	38,129
Inking attachment for job printing presses. William A. Thompson, et al.	38,197		38,130
Inscription and motto plate. Charles M. Underwood.	38,787	Ladder: see Collapsible ladder. Extension ladder. Roof ladder. Safety rolling step ladder. Sectional extension step ladder.	
Insecticide. William Lyle Watson.	38,102	Ladder, Morris C. Wilson, et al.	38,727
Insects. Device for destroying. Henry, Count of Puckler Instrument: see Endoscopic instrument. Surveyors instrument.	40,547	Lamp: see Arc lamp. Electric cigar lighting lamp. Electric lamp. Gas lamp. Incandescent lamp. Pocket lamp. signal lamp.	
Insulated electric conductor. James B. Williams.	40,528	Lamp. Alfred E. Harris.	38,370
Insulating and waterproof material. Ernest Bivnath.	41,104	Lamp. James Thorne.	40,263
Insulator: see Section insulator.		Lamp. Joseph Knapper.	39,376
Insulator. Frank A. Ross.	40,913	Lamp. Robert Reid, et al.	39,680
Insulator. Lewis McCarthy.	38,754	Lamp. Thomas Hipwell.	39,896
Insulator pin. Fred M. Locke.	41,315	Lamp burner. Edward McDowell.	40,714
Invalids. Appliance for handling. James G. Thrower.	39,908	Lamp socket: see Incandescent lamp socket.	
Iron: see Electric soldering irons. Smoothing iron. Steel or ingot iron.		Lamps. Apparatus for automatically lighting and extinguishing gas. Percival Everitt.	40,692
Iron globules. Method of making chilled. Benjamin C. Tilghman, et al.	41,173	Lamps. Apparatus for exhausting incandescent. Henry S. Kaliske.	39,206
Iron pipes, ingots, etc. Method of casting. James W. Cole.	39,164	Lamps, &c. Apparatus for regulating the supply of liquid hydrocarbon to. Henri Galopin.	39,678
Iron sand. Method of treating. Alfred S. Minett.	41,305	Land roller. David A. Grant.	41,185
Ironing and polishing machine. Clarence O. White, et al.	40,913	Landing net. Charles S. Hebard.	38,267
Ironing board. James Gates.	38,809	Lantern. James H. Ferns.	40,604
Ironing machine: see Shirt ironing machine.		Lantern, &c. John T. and James Paul.	40,215
Ironing machine. Charles L. Bartels.	40,850	Lantern. Wolfred Nelson.	40,781
Ironing machines. Reversing mechanism bar for. John Joseph Daley.	38,226	Lanterns. Device for holding the globe in tubular. George L. Flower.	40,343
Ivory balls, blocks, &c. Method of making. Alexander de Pont, et al.	40,592	Lasting machine. Charles S. Gooding, et al.	38,105
Jack: see Floor jack. Lifting jack. Track jack. Vehicle jack. Window jack.		Lasting machine. John T. Avery, et al.	39,859
Jack. Hiram J. Garbutt.	40,994	Lasts and patterns therefor. Method of and means for making. George W. Willey, et al.	41,226
Jack for waggons. Charles J. Shireff.	40,570	Latch: see Door latch.	
Jar: see Fruit jar.		Latch for gates. Charles F. Bettmann.	40,334
Joint: see Compression joint. Rail joint.		Latch for gates. George Mallory.	39,166
Joint closing machine: see Dovetail joint closing machine.		Lathe: see Chamfer cutter and lathe.	
Joint coupling. Cornelius A. Folly, et al.	39,307	Lathe. Henry C. Abbee, et al.	40,054
Joint coupling. Thomas W. Moran.	38,281	Lathe. Michael Brochu.	39,887
Joint for flexible shafting. John Howard.	39,741	Lathe carriage. Peter G. Simpson.	40,280
Joint for pipes. George A. Bidwell.	38,127	Lathing machine for producing metal. Walter W. Bostwick.	38,356
Joint for pipes. William Sykes.	40,224	Lawn mower. Simon P. Graham.	40,296
Joint for railway rails. Joseph A. Eno.	38,031	Lawn mower and trimmer. Alexander Hanton, et al.	40,859
Joint for railway rails. Robert J. Colvin.	40,901	Lead carbonate. Method of and apparatus for producing. Norman K. Morris, et al.	41,221
Joint for railway rails. Urban H. Hane.	40,571	Lead fibre. Apparatus for making. Norman K. Morris.	41,246
Joint for rotary pipes. John B. Morgan, et al.	40,221	Leather. Machine for shaping and moulding. Wilhelm Krone.	40,599
Joint for spectacle frames. Benjamin I. Price.	40,610	Leather. Machine for treating. Matthew N. Howard.	40,779
Joint holder. Pierre E. Bowrassa.	38,495	Leather. Process of and apparatus for degreasing. Frederick N. Turney.	40,549
		Leather. Process of manufacturing lacing. William T. O. Lewis.	38,593

Leather. Process of stuffing and finishing. Vincent Bros-seau.....	39,581	Lubricant. Charles H. Risdale, et al.....	39,175
Leather skiving machine. Napoleon Dufresne, et al.....	41,333	Lubricant. Robert Hutchison.....	38,307
Ledger, sales book and billing book combined. James E. Deque.....	40,979	Lubricant and steam packing. Wilson H. Stickler.....	40,473
Leggins. Louis W. Groat, et al.....	40,317	Lubricating cup. Ira J. Briggs.....	40,745
Letter file. Carl F. Lomb.....	38,671	Lubricating device. James E. Totman, et al.....	38,144
Letter file. Office Speciality Manufacturing Co.....	39,010	Lubricating hub. Frederick W. Randolph.....	40,728
Letter file. William O. Gotwals.....	38,687	Lubricating the journals of car axles. Method of. Butler Edgar, et al.....	41,203
Letter or bill file. Charles H. Ahrens, et al.....	41,441	Lubricator. James Nicholson Elliott.....	38,963
Letters. Apparatus for copying and duplicating. Max Sommer.....	39,519	Lubricator. Robinson W. Green.....	38,799
Level: see Plumb and level.		Lubricator. William Mielding, et al.....	38,784
Level tube for surveying instruments. John A. Brown, et al.....	40,862	Magazine gun. Frank M. Garland.....	40,217
Lever for railway switches. Henry Mohle, et al.....	39,350	Magnetic separators. Apparatus for feeding to. Jonas Wenstrom, et al.....	41,231
Lid for car axle boxes. Robert Soutter, et al.....	38,166	Magneto-electric ignitor for combustible vapour engines. Leonidas G. Woolley.....	39,592
Life preserver. Alois Zadak.....	38,362	Magneto-electric machine. Lamotte C. Atwood.....	40,501
Life preserver. Christian Paulsen.....	41,039	Magnetic separator. Jones Wenstrom.....	41,165
Life preserver. Frederick Garner Beckett.....	38,994	Magnetic separator. William D. Hoffman.....	40,509
Life preservers. Method of making. Frederick P. Warren.....	41,081	Mail bag. Charles Weltner.....	38,847
Lifter and lock for sky lights. William Trebilcock.....	39,599	Mailing case. Gustavus J. Johnson.....	39,606
Lifter for halter weights. James W. McHenry, et al.....	40,505	Mains. Device for tapping. Mark P. Madden.....	38,243
Lifting jack. Charles A. Hooker, et al.....	40,029	Malt floor. Johann Jungbluth.....	38,731
Lifting jack. Louis J. Crecelius, et al.....	40,273	Malt. Method of drying. George Portz.....	39,979
Lifting jack. Melchoir Chumard.....	38,561	Maple sugar. Device for preparing. John W. Currier.....	38,515
Light: see Night light. Oxycalcium light.		Mat: see Door mat.	
Lighter: see Stove lighter.		Mat. James E. Emerson, et al.....	40,521
Lightning arrester. Frank Mansfield, et al.....	39,329	Mat and matting. Thomas C. McPherson.....	39,103
Lightning arrester. James W. Easton.....	40,246	Mats and rugs. Resilient frame for. Arthur J. Worrall, et al.....	39,219
Lime slacking machine. Alonzo R. Miller.....	39,611	Match box. Gerald M. Dunne, et al.....	39,421
Limestone. Process of preparing and hardening. George J. Randall.....	39,883	Match box. T. Bohuslau Fiedler.....	39,000
Limit switch for electricity. Frank Bankson Rae, et al.....	38,075	Matches. Machine for making. Augustus E. Ellinwood.....	40,988
Line: see Clothes line.			41,001
Lining: see Tea chest lining.		Mats. Method of treating. Jules Garnier.....	40,053
Link for drive chains. Charles E. Hart.....	38,750	Mattress: see Spring mattress.	
Link motion. John Lunz.....	39,041	Mattress. Machine for weaving wire. Charles H. Hard, et al.....	40,809
Linotype machine. Philip T. Dodge.....	39,813	Measure: see Recording liquid measure. Sifter and measure.	
Lint package. James Wood Johnson.....	38,417	Meat cutter. Amos Shepard.....	40,312
Liquid hydro carbon motor engine. Herbert Lindley, et al.....	39,479	Meat cutter. Tillmon P. Ricks, et al.....	38,516
Liquid fuel. Apparatus for burning. Warren M. Abbot, et al.....	40,353	Meat, &c. Apparatus for pickling. Johann Fey.....	39,539
Liquid gauge and tap. John Sharp, et al.....	40,371	Meats, &c. Receptacle for preserved. Dan Rylands.....	41,075
Liquids. Apparatus for dispensing. William M. Fowler.....	40,017	Mechanical movement. Alfred B. Willcox, et al.....	39,711
	40,264, 40,288,	Mechanical movement. Franklin P. Hummel, et al.....	39,791
Liquids. Apparatus for drawing off aerated. Robert Panchand, et al.....	40,601	Mechanical movement. Jesse Morningstar, et al.....	41,417
Liquids. Apparatus for evaporating. Charles W. Cooper.....	41,130	Mechanical movement. John M. Morris.....	40,624
Liquids. Apparatus for manufacturing and bottling aerated. Luther G. Chimmery, et al.....	39,523	Mechanism for driving machines by foot powers. Gaston Hervien, et al.....	41,089
Liquids. Apparatus for raising. Otto Schulze.....	39,954	Medicator: see Inhaler and medicator.	
Liquids and substances. Apparatus for testing. Thomas Clement.....	39,724	Medicinal apparatus. Carl Harald Liedbeck.....	39,094
Liquids or substances. Process of testing. Thomas Clement.....	40,422	Medicinal compound. Alfred Bouillon.....	39,045
Liquids. Process of purifying. Samuel H. Milliken, et al.....	41,273	Medicinal compound. Ann Brenner.....	40,841
Liquors: See Ageing liquors.		Medicinal compound. Francis M. Webb.....	40,535
Liquors containing salts. Apparatus for evaporating. Sigismund Pick.....	38,553	Medicinal compound. Henry Mullin.....	41,019
Lithographic stippling. Method of producing. Charles H. Gordon.....	38,395	Medicinal compound. William P. Duncalfe.....	39,258
Loader for cartridges. Frank R. Baldwin.....	40,223	Medicinal plaster. Joseph H. Osgood.....	38,647
Loader for cartridges. George B. Jacobs.....	38,364	Memorandum book. Marcus A. Miller, et al.....	38,295
Loader for hay. Charles C. Jewett.....	39,588	Memorandum book or sale slip. Wilson Morton.....	38,351
Loading bricks from machines. Method of. Edward New Lock: see Bag lock. Balance lock. Check controlled lock. Coin operated lock. Combination lock. Lifter and lock. Nut lock. Permutation lock. Sash balance and lock. Sash lock.	38,448	Merry-go-round. Joseph C. Fowler.....	40,443
Lock. Franz Meinke.....	40,572	Metal balls. Machine for grinding. Edward A. Jones.....	40,365
Lock. Frederick P. Cobham, et al.....	41,423	Metal balls. Machine for making. Edward A. Jones.....	40,364
Lock. Henry Elliott.....	41,122	Metal bodies. Machinery for shaping, finishing and flanging. Thomas C. Barraclough.....	39,566
Lock. John Francis Shea.....	39,275	Metal. Machine for cutting. William Smith.....	40,262
Lock. Sanford K. Weymouth.....	39,017	Metal. Method of welding. Mark M. Dewey.....	41,164
Lock. Warren H. Taylor, et al.....	38,245	Metal screw machine. Samuel L. Worsley.....	39,470
Lock for bedsteads. William B. Darby.....	38,960	Metal tube. John Earle, et al.....	39,560
Lock for bicycles. Cornelius J. Brosnan.....	38,342	Metal tubes, &c. Apparatus for the manufacture of, by electro deposition. Richard D. Sanders.....	39,347
Lock for tills. Hugo Brav.....	39,654	Metals. Art of, and means for recovering and amalgamating. Jacob C. Wiswell, et al.....	39,958
Locomotive: see Electrical locomotive. Road locomotive.		Metals. Art of casting. Walton Haydon.....	40,084
Locomotive driver brakes. Joseph E. Normand.....	39,386	Metals by electricity. Method of working. Elihu Thomson, et al.....	38,293
Locomotive. Exhaust pipe for. James B. Hartigan.....	41,175	Metals by electricity. Method of working. Mark W. Dewey.....	40,205
Log carrier. Daniel S. Stomps.....	39,141	Metals by electricity. Process of, and apparatus for forming and welding. Elihu Thomson.....	38,661
Log loader. Frederick O. Kilgore, et al.....	40,946	Metals from ores. Process of extracting. Jabez Thurton.....	40,329
Log turner. Theodore S. Wilkin.....	40,617	Metals. Process of, and apparatus for coating and cleaning. Richard Heathfield.....	40,584
Logging boom section. Richard G. Peters.....	41,340	Metals. Process of annealing. Samuel H. Brown, et al.....	38,517
Loom. Clarence S. Strobridge.....	38,589	Metals. Process of hardening. Joseph S. Durning.....	40,338
Loom for weaving cane, &c. Archibald Hay.....	38,413	Metals. Process of spinning and welding. James Hall Bevington, et al.....	38,322
Loom for weaving slat and wire fabric. Charles E. Parks.....	41,368	Metallic packing. William H. Bodfish.....	40,691
Looms: see Picking motion for looms.		Metallic coupling. Frederick W. Wait.....	40,538
Looms. Attachment for. William O'Brien, et al.....	39,120	Metallurgical process. Jasper Henry Selwin.....	38,101
Loop for harnesses. Thomas G. Nelson, et al.....	39,125	Meter: see Rotary engine blowers, pumps and water meters.	
Lounge. Charles Mee.....	40,081	Meter for electricity. Addison G. Waterhouse.....	40,983
Low water alarm. Ira A. Fuller.....	40,849	Meter for electricity. C. P. Eliason.....	39,981
Low water alarm and steam gauge. Isaac Willan.....	40,826	Meter for electricity. Francis Teague.....	40,750
		Meter for electricity. Herbert M. Pilkington, et al.....	

- Meter for fluid. Fred W. Holt. 40,187
 Meter for gas. James B. Knickerbocker, et al. 41,280
 Meter for grain. John Henry. 41,144
 Meter for grain. John Henry, et al. 39,520
 Meter for water. John Thomson, et al. 40,992
 Meter for water. John Thomson, et al. 40,992
 Meter for water. Lewis H. Nash. 40,643
 Meter for water. Richard J. Rogers. 40,376
 Mile board for advertising. Austin Demons Cable. 38,988
 Mill: see Band and circular saw mill. Band saw mill. Crushing mill. Fanning mill. Grinding mill. Roller mill. Saw mill. Wind mill.
 Mill. John H. Pendleton. 39,561
 Milling machine. Charles H. Trask. 39,870
 Mining machine. Henry Dierdorff. 40,771
 Mining machine. Samuel S. Brown, et al. 39,387
 Miter box. Jesse E. Bundeley. 40,758
 Miter clamp. Frederick W. Hedgeland. 40,743
 Mitring machine. Solomon Phillips. 38,198
 Mitten. Ferdinand J. Kahn. 40,595
 Mixing machine. Joseph T. L. Randle. 40,511
 Moistener and opener for stamps and envelopes. William J. Dyas, et al. 39,718
 Mould: see Revolving mould.
 Mould for closed cylinders. Frank X. Black. 40,846
 Mould for coffin shells. William J. Anthistle. 39,042
 Moulding machine. Frank H. VanHousten. 40,977
 Moulding machine. The Tabor Manufacturing Co. 38,832
 Money changer. John Adams. 41,253
 Money changer. Horone R. Loranger, et al. 40,114
 Mortises. Machine for bushing. Franklin H. Wright. 41,817
 Mortises. Method of bushing key board. Augustus Newell. 38,654
 Mortising machine. Louis A. Belmont, et al. 40,717
 Moth proof bag. Frederick O. Page. 39,823
 Motion. Apparatus for intermittent. Arnold Willmer. 39,805
 Motion. Means for electrically giving reciprocating. Henry S. McKay. 40,510
 Motive power. Apparatus for producing. Albert Krank. 40,691
 Motive power. Apparatus for producing. Charles Tellier. 38,537
 Motor: see Alternate current induction motor. Alternate electric current motor. Hydraulic motor. Induction motor. Multiplex current electric motor. Pump motor. Spring motor. Self-reascending motor. Traction motor. Water motor. Vehicle motor.
 Motor. Daniel R. Sheen. 40,107
 Motor. Frank B. Rae, et al. 38,630
 Motor. George Coehins. 40,301
 Motor. James Ansley Adams. 38,920
 Motor. James T. Dew. 39,938
 Motor. Willard C. Carpenter. 39,264
 Motor. William Crook. 41,220
 Motor. William G. MacLaughlin. 40,166
 Motor. William H. Cheer. 38,850
 Motor for vehicles and boats. William H. Minnix. 40,003
 Motor for water currents. Lemuel C. Neal, et al. 39,274
 Motor truck for cars. George M. Brill. 40,623
 Motor truck for electrically propelled vehicles. Frank Bankson Rae, et al. 38,069
 Mould filling apparatus. Telsord C. Batchelor. 39,673
 Mould for ingots. Charles Hodgson, et al. 39,990
 Mould for metallic wheels. Clinton Cannon, et al. 38,549
 Moulds for casting. Apparatus for making. Stephen Alley, et al. 38,427
 Moulding machine. Ellis Keenan. 38,191
 Moulding machine. Napoleon Lewis, et al. 39,393
 Mouldings. Machine for turning. Julius F. Gebhardt. 38,154
 Mouth piece for speaking tubes. William H. Ross, et al. 38,802
 Movable seat for vehicles. William H. Lingle. 40,765
 Mower: see Lawn mower.
 Mower. Henry E. Pridmore, et al. 41,049
 Mower. James Wad-el-Ward, et al. 40,937
 Mower. John Stephani. 40,480
 Mowers. Foot attachment, for raising the cutter bar of. David Maxwell. 40,175
 Mowers and reapers. Sickle bar movement for. Alvin W. Lamphere. 40,726
 Mowing machine. Edward Bartlett. 38,583
 Mowing machine. Jacob Phillips. 39,416
 Muff: see Ear muff.
 Muff bed. Edward Goldman, et al. 40,695
 Muffle furnace. Charles H. Land. 40,007
 Muffler for steam. Edwin S. Hildebrandt. 39,429
 Multi-tubular boiler. Max Seipp. 40,600
 Multiplex circuit electric motor. Charles J. Van Depoele. 38,560
 Multiplex stamping machine. Henry Howard, et al. 38,541
 Muscular power testing machine. Charles A. Barrett, et al. 39,419
 Music box: see Damping device for.
 Musical instrument. Charles A. Gregory. 39,238
 Musical instrument. Ira F. Gilmore. 39,189
 Musical instrument. Herman S. Saroni. 38,772
 Musical instrument. Electrically operated stringed. Willard H. Gilman. 39,432
 Musical instruments having key-boards. Attachment for. George P. O. Heroux. 38,171
 Mute for musical instruments. David Genese. 40,219
 Nail making machine. Lewis Goddu. 38,390
 Nail puller: see Hammer and nail puller.
 Nail puller. Melville Loftin. 38,796
 Nails. Apparatus for sorting. William M. Stone. 38,789
 Nails. Machine for forging horse shoe. Charles E. Moore, et al. 40,143
 Nails. Machine for making. John B. Hastings, et al. 40,503
 Nails. Machine for making. Howard Greer. 40,268
 Nails. Machine for making. Per Adolf Nilsson. 39,855
 Nails. Method of, and apparatus for making. Per Adolf Nilsson. 40,236
 Nailing machine. Stillman W. Robinson, et al. 39,285
 Nailing machine. William S. Doig. 39,562
 Nailing machine for footwear. Stillman W. Robinson. 39,284
 Neck yoke: see Whiffletree and neck yoke.
 Neck yoke. Lewis W. Rothrock. 41,014
 Neck yoke. Merrel Gadberry. 38,159
 Needle for sewing machines. William Pigott. 39,244
 Needles of embroidering machines. Machines for threading. Adolph Sawyer, et al. 38,581
 Naptha. Apparatus for evaporating. John W. Evans. 38,704
 Net: see Landing net.
 Net. Charles Leiding. 41,031
 Nets for fishing. Machinery for making. William Stuart. 40,093
 Nets. Machine for making. William J. Hooper. 41,379
 Nickel and copper ores. Treatment of without cobalt. Henri L. Herrenscheidt. 38,710
 Nickel from ores. Process of extracting. Thomas McFarlane. 40,628
 Night cap. Adelaide S. Turner. 38,508
 Night light and time indicator. Henry Bennett. 41,038
 Number device. John F. Everett. 41,125
 Numbering machine. Hoyte C. Hodstate, et al. 41,256
 Nut lock. Balthaser S. Baybuck. 38,749
 Nut lock. Benjamin F. Grom, et al. 38,613
 Nut lock. Charles P. Sherman. 39,135
 Nut lock. Charlie H. Miles, et al. 39,832
 Nut lock. David B. Daniels. 39,147
 Nut lock. David C. Ferry, et al. 39,121
 Nut lock. Daniel Rhodes, et al. 39,157
 Nut lock. James C. Grimes, et al. 38,785
 Nut lock. John C. Nichol. 38,690
 Nut lock. John W. B. Cook, et al. 38,233
 Nut lock. Joseph Broadley. 38,402
 Nut lock. Julius Evinoff. 40,671
 Nut lock. Theodore Martin. 39,784
 Nut lock. Thomas C. Harris. 39,783
 Nut lock. Thomas J. Kennedy. 40,797
 Nut lock. William Cokayne. 40,909
 Nut lock. William J. Walker. 38,030
 Nut lock. William Timmis. 38,748
 Nut lock washer. Frederick W. Schroeder. 39,394
 Nut making machine. Justin H. Burdick. 40,760
 Nut shearing and punching machine. Julius Altman, et al. 41,230
 Nut tapping machine. Clarence L. Chapman, et al. 40,854
 Nut tapping machine. Frank S. Cook, et al. 41,048
 Nuts: see Drilling and boring machine for nuts.
 Nuts for screwed bolts, &c. Improvements relating to. John R. Peacock, et al. 38,519
 Nuts. Method of making. Justin H. Burdick. 40,778
 Nutritive compound. John L. Johnston, et al. 38,740
 Obliterating sound records from record tablets. Art of. David W. Brown. 40,179
 Oscillating engine. Julian Moss, et al. 38,326
 Odometer. Edwin J. Merry. 39,705
 Off set for saw-mill carriages. William Gowen. 39,742, 39,743, 39,744
 Oil. Robert R. Graf, et al. 38,133
 Oil. Apparatus for distilling mineral. John Laing. 41,311
 Oil can. Harriet A. Hart. 38,726
 Oil can. James B. Melloy. 40,966
 Oil can. Steward Dunlop. 41,146
 Oil can and filler. Edwin W. Luce. 38,826
 Oil for general painting. Joel C. Decker. 40,689
 Oil gas. Apparatus for making. William B. Frink. 40,755
 Oil painting. Louis Magar. 38,910
 Oil. Process of, and apparatus for distilling. Allan Mason. 41,276
 Oil. Process of manufacturing cod liver. Peter M. Heyerdahl, et al. 38,234
 Oil. Process of refining hydro-carbon. John Gardner, et al. 40,801
 Oils. Apparatus for burning. George Rose, et al. 39,584
 Oils. Apparatus for distilling. Evans A. Edwards. 40,814
 Oils. Apparatus for distilling mineral. John Laing. 40,899
 Oils. Method of desulphurizing. Jesse A. Dubbs, et al. 41,114
 Oils. Method of preparing medicinal. Adalbert Gauvreau. 38,625
 Oiler. John T. Smith. 38,585
 Ointment. Paul F. Briere. 39,116
 Open fire place heater. George R. Scates, et al. 40,606
 Opener: see Moistener and opener.
 Opener for envelopes. William J. Puckett. 39,282

Opener for pulp. Carl Kellner.....	40,116	Paper. Method of making waterproof. Walter L. Jamieson, et al.....	40,057
Operator for transoms. George W. Hamilton.....	39,403	Paper. Method of manufacturing. Amasa N. Kidder.....	38,815
Ore: see Nickel and copper ore.		Paper rack for telephones. John F. Bullock.....	41,161
Ore. Concentrating machine. Calvin M. Fitch.....	38,494	Papers or documents. Means for preventing the alteration of the amount of negotiable. George D. Edwards.....	39,619
Ore concentrator. Charles Brent.....	40,441	Parer: see Apple parer.	
Ore concentrator. Charles E. Seymour, et al.....	40,377	Parlour and sleeping car. Montgomery H. Shroop, et al.....	38,176
Ore concentrator. Jean Deloppet.....	39,240	Partition. Arthur J. Wells.....	39,356
Ore concentrator. Flora L. H. Brown.....	39,965	Parturition. Apparatus for assisting. Peter McCahey.....	40,811
Ore concentrator. Ryerson D. Gates.....	39,050	Pasting machine for wall paper. Peter McQueney.....	38,702
Ore concentrator. Walter J. Dammond, et al.....	40,004	Pattern board. James W. Wright, et al.....	39,836
Ore. Method of extracting gold and silver from. Henry Parkes, et al.....	41,402	Pavement. John A. Chanler.....	40,550
Ore. Process of reducing. Jacob T. Wainwright.....	40,459	Pavement, flooring, &c. William Brenner.....	39,084
Ore pulverizer. Charles Raleigh.....	39,471	Pea sheller. Edward C. Moulton.....	40,302
Ore sampling device. Robert C. Hawley.....	39,717	Peat. Desiccation of. Jean M. A. Gerard.....	39,569
Ores and matts. Process of treating. Louis A. Pelatan.....	38,766	Pedal for pianos. Stephen Seeley.....	39,044
Ores. Furnace and apparatus for extracting metals from. Jove B. Alzugaray.....	39,591	Pen: see Fountain pen.	
Ores. Furnace and method for the treatment of refractory ores. Charles J. Fauvel.....	39,595	Pen. John Phillips.....	41,127
Ores. Method of treating. Arthur L. Grant, et al.....	38,745	Pencil. Frederick E. Blaisdell.....	38,338
Ores. Method of treating sulphuretted. Stephen H. Emmins.....	39,500	Pencil sharpener. John Siegel.....	38,916
Ores. Process of roasting sulphur bearing. Charles W. Stickney.....	39,944	Pen extractor. William Marcus Morton.....	38,886
Ores. Process of treating metalleferous. Francis H. Molesworth, et al.....	40,453	Pendulum scales. John B. Martin.....	40,491
Organ. Charles Wason Small.....	38,892	Pen holder. Henry J. Kennedy.....	39,943
Organ. Jacob R. Hessler.....	39,170	Pen holder. John Oliphant.....	38,831
Organ. Melville Clark.....	39,314	Pen holder and blotter. Ferdinand Von Eulenfeld.....	40,036
Organ. Richard W. Jackson.....	40,830	Pepsin. John B. Russell.....	40,488
Organ. Robert H. Jones.....	41,235	Permanganate to produce a porous spongy mass. Treatment of. James Howarth Parkinson.....	38,139
Organ stop action. Alexander Marcy, et al.....	38,839	Permutation lock. Leopold E. Schneider, et al.....	39,454
Organ stop action. Newell M. Boynton.....	38,229	Persons buried in trance. Apparatus for the rescue of. Adalbert Kwiatkowski.....	39,472
Ornaments or profile borders, &c. Method and apparatus for producing plastic. Jean Wries, et al.....	39,578	Perspectograph. Justin H. S. Jechoux.....	41,120
Ornaments on wooden blocks and process of manufacturing. Otto Graetzer, et al.....	39,579	Pessaries. Jason S. McCants.....	39,553
Oven: see Electric oven.		Petroleum for removing sulphur compounds. Method of treating. Herman Frasch.....	41,043
Oven. Edward A. C. Peterson.....	41,012	Petroleum. Method of distilling. Herman Frasch.....	41,042
Oven. Otto Schulze.....	40,712	Petroleum. Process of refining. Herman Frasch.....	38,070
Oven. William Morton.....	39,491	Pew back. John D. Pennington.....	40,339
Oven and tray therefor. John Odair.....	40,607	Phonogram blank. Thomas A. Edison.....	40,100
Ovens and oven doors. John A. Armstrong.....	38,482	Phonogram blank. Process of treating. Thomas A. Edison.....	40,102
Overall. Samuel Latham.....	41,260	Phonograph. Thomas A. Edison.....	40,099, 40,101, 40,130,
Overflow cut off. Andrew W. Knox.....	41,207	Phonographs. Determining device for. Thomas A. Edison.....	40,125
Over stocking. Joseph John Westgate, et al.....	38,851	Phonographic attachment. Louis Glass.....	40,128
Oxy-calcium light. George Roger Prouse.....	38,223	Phototype. Arthur C. Ferguson.....	41,150
Oxygen. Method of, and apparatus for obtaining. James Howarth Parkinson.....	38,140	Piano player: see Electric piano player.	40,803
Package for shipping and preserving butter, &c. Remus A. Kneeland.....	38,095	Piano action. Augustus De Foe Dimick.....	39,073
Package making and filling machine. Henry E. Smyser.....	40,310	Piano fortes. Mechanism for stringing. William H. Ivers.....	38,521
Packing: see Lubricant and steam packing. Metallic packing. Piston packing.		Pianos: see Resonance chamber for pianos.	
Packing case. Jesse A. Jones, et al.....	40,512	Pianos. Pedal movement for. John B. Mitchel.....	41,106
Packing for rods, valves stems, &c. Francis P. Martin, et al.....	39,457	Pick. Charles B. Van Arsdale.....	38,983
Packing for stuffing boxes. Hamlet E. Forrest.....	38,344	Pick. Joseph Mitchell, et al.....	39,212
Pad: see Hernia pad.		Picker for looms. Louis Tweles, et al.....	40,658
Pad for electric cells. Lewis Hopkins Rogers.....	38,042	Picker stick. Louis Bredannaz.....	38,881
Pad for horse collars. Herman Doering.....	40,877	Picking motion for looms. James Moss, et al.....	40,894
Paddle wheel. Concave Paddle Wheel Co.....	38,974	Pigeon hole case. David C. Meehan.....	38,998
Paddle wheel. Maurice Richter.....	40,489	Pigments. Process of and apparatus for making. George D. Coleman.....	40,876
Padlock. John F. Shea.....	39,277	Pill machine. Chester A. Weller, et al.....	40,502
Pail and strainer for milk. Frank Ansley, et al.....	39,456	Pill machine. Joseph R. Witzel.....	39,360
Paint. Edwin W. Grafton.....	38,562	Pilot for cars. John M. Sparrow, et al.....	40,931
Paint pot. William B. Deming, et al.....	40,843	Pin: see Cloth pin. Insulator pin. Safety pin. Tuning pin.	
Painting. Method of. Friedrich A. Laesecke, et al.....	39,054	Pipe: see Sheet iron stove, water and other pipe. Socket pipe. Stove pipe.	
Painting machine. Edwin Armitage, et al.....	38,077	Pipe. Damase M. Poulin.....	38,761
Pan: see Bed pan. Frying pan. Grinding and amalgamating pan.		Pipe. Joseph Lanhaff.....	38,795
Pan for boiling vegetables. William Wyndham.....	41,331	Pipe coupling. Consolidated car heating Co.....	38,971
Paper: see Distinctive paper.		Pipe coupling. Edward F. Roberts.....	40,293
Paper. Thomas Beecham.....	39,716	Pipe coupling. Joseph S. List.....	39,283
Paper. Apparatus for feeding and separating sheets of. Thomas R. Johnston.....	39,510	Pipe coupling. John Suydam.....	40,872
Paper. Apparatus for producing indented type impressions upon. William J. Howell.....	41,327	Pipe coupling. William Carey.....	40,323
Paper box. E. B. Eddy Company.....	38,938	Pipe coupling and check valve. William T. Missinger, et al.....	39,233
Paper box. George H. Millan.....	39,528	Pipe coupling and tube rest. Isaac N. Kindall.....	41,024
Paper box. James E. Baker.....	40,848	Pipe S-traps. Apparatus for making lead. William W. Bosenfield.....	38,578
Paper boxes. Machine for manufacturing. James W. Hutt, et al.....	39,368	Pipe threading machine: see Tapping and pipe threading machine.	
Paper feeding machine. Robert Burnet.....	41,387	Pipe wrench. George S. Hiltz, et al.....	41,224
Paper from rolls. Apparatus for cutting. John Brooks Young.....	39,098	Pipe. Machine for cutting iron. Alcide Clarest.....	38,152
Paper hanging machine. Adam H. Lohker.....	40,258	Piston packing. Isaac H. Clup.....	38,365
Paper holder. Doctor F. Oliver.....	39,916	Pitman. David Henderson.....	38,640
Paper. Machine for ruling, perforating, printing, numbering and severing web. James Lilly, et al.....	39,536	Plane: see Carpenter's plane.	
Paper and method of embossing. Hudson M. Kitchell, et al.....	38,271	Planter for corn. George S. Shiffield, et al.....	41,108
		Plants. Method of treating. Ivar A. F. Bang, et al.....	40,061
		Plaster: see Medicinal plaster.	
		Plaster. Arthur L. Grant.....	39,256
		Plaster board. James Day Baker.....	38,939
		Plaster. Galvanic electric. David Ross & William Innes.....	38,973
		Plate: see Die plate. Fish plate. Inscription and motto plate. Screw cutting plate. Surface printing plate.	

- Plate for baking purposes. Charles L. Wagandt. 39,357
 Plate glass polishing machine. William Smith. 39,316
 Plate printing press. Samuel P. Steen. 39,362
 Plates. Method of producing fancy figured wooden. Robert Himmel. 39,690
 Plated ware. William E. Pleadwell. 39,778
 Plating clay with glass. Process of. Arthur A. Houghton, et al. 40,869
 Pliers: see Cutting pliers.
 Plough: see Gang plough. Snow plough. Rotary plough.
 Plough. Asa M. Fitch. 39,214
 Plough. George M. Clark. 40,577
 Plough. Oscar Marth. 39,684
 Plough. Samuel Irwin, et al. 38,165
 Plough point. George C. Westerwell. 39,266
 Plug for blasting timber. Martin L. Findlay. 39,388
 Plumb and level. Newel H. Spencer. 38,760
 Pneumatic door check and closer. John S. Shrawder. 40,228
 Pneumatic pump. Frederick A. Halsey. 40,398
 Pneumatic transfer and storage stations for food products. Lyman Smith. 41,055
 Pneumatic tyre. Edward H. Seddon. 46,724
 Pneumatic tyre. George W. Rowe, et al. 41,296
 Pneumatic tyre. Hypolite J. LaForce. 40,935
 Pneumatic tyre. Rudolph W. Huss. 41,352
 Pneumatic tyre. Thomas B. Jeffery. 39,035
 Pneumatic tyre. Thomas Dunn. 40,823
 Pneumatic tyre. William R. Foster. 41,297
 Pneumatic wheel tyre. Karl Lehmann. 39,679
 Pocket lamp. Jacob H. Fawkes. 39,453
 Pocket tobacco case. James Potter, et al. 39,732
 Poke: see Horse poke.
 Pole: see Vehicle pole.
 Pole. William Pitt. 39,831
 Pole for electric lights. Oliver Spanner. 39,655
 Polishing: see Ironing and polishing.
 Polishing machine. Henry Frost. 41,434
 Polishing wheel. Alvin Colburn, et al. 39,863
 Porous bodies. Process of impregnating. Edwin T. Greenfield, et al. 38,764
 Portelectric. John T. Williams. 39,502
 Portfolio for collars and cuffs. Louis D. Dozier, et al. 39,061
 Post: see Fence post.
 Post. John H. Huntress. 39,400
 Post hole digger. Albert E. Dowsell, et al. 40,936
 Potash: see Caustic soda. Caustic potash.
 Potato digger. Alfred P. Goodell. 39,270
 Potato digger. George B. Irwin. 39,066
 Potato digger. Wesley Morrow. 38,943
 Potato digger. William A. Martin. 38,699
 Potato planting machine. Gustav Hoffman. 40,825
 Potato separator and cleaner. James Waldbrook. 40,845
 Pottery dipping tube. Cassius C. Thompson. 39,801
 Pouch for tobacco. William J. Cussen, et al. 38,097
 Poultry. Apparatus for killing. August Schonemann. 39,693
 Power: see Propelling power.
 Power brake for railway cars. John Joseph Hooker. 39,092
 Power conduit for railways. Carl T. B. Brain. 40,588
 Power hammer. William H. Law. 39,771
 Power. Means of translating. Alexander E. Brown. 39,292
 Power transmitter. Wesley E. Laird. 39,879
 Power transmitter. William Main. 39,293
 Press: see Compound press. Printing press. Veneering press.
 Press. Wolcott A. Hull. 38,540
 Press for cheese. Charles Richardson, et al. 38,359
 Press shoe for grain drills. John M. Szarkowski. 38,309
 Presses. Apparatus for feeding paper to printing. Randal Cresswell, et al. 39,960
 Price ticket. Edgar Macklin. 39,115
 Printers' stick. Elbert R. Johnston. 38,742
 Printing galley. Chester Horne, et al. 40,506
 Printing and book binding machinery. Thomas Gibson. 39,091
 Printing and numbering machine for cheques. William E. Smith. 41,174
 Printing device. James S. Foley. 39,466
 Printing for the use of the blind. Apparatus for the production of. Frederick W. Smith. 39,554
 Printing machine. Calvert B. Cottrell. 40,086
 Printing oil cloth. Machine for. George F. Eisenhardt. 40,723
 Printing plates. Art of making. Charles S. Partridge. 38,842
 Printing press. Joseph L. Cox. 40,281
 Printing press. William B. Lawrence. 40,079
 Printing telegraphs. William W. Taylor, et al. 40,190
 Projectile. Philip H. Holmes. 38,746
 Propeller: see Cable propeller. Screw propeller.
 Propeller. Charles S. Merritt. 41,247
 Propeller for ships. William H. Wigmore. 38,124
 Propeller of a boat. Apparatus for revolving and elevating. W. H. Thompson, et al. 40,142
 Propelling power. James B. Hall, et al. 39,295
 Propelling power. Thomas Henry Allen, et al. 38,177
 Propelling vessels. Method of. Thomas Mills. 41,067
 Protector: see Corner shield and protector. Induction discharge protector.
 Protector and cell for queen bees. Noah Diebble West. 38,404
 Protector for beds. Jennie P. Duval. 39,377
 Protector for boots and shoes. James P. Martin. 40,532
 Protector for closet seats. Thomas A. Swann. 38,398
 Protector for cow udders. Henry H. Chase. 38,645
 Protector for garments. Otto F. Ostergren, et al. 38,505
 Protector from smoke, cinders, cold air and water. John W. Boice. 40,952
 Pug mill. Alonzo R. Miller. 40,756
 Pug mill. William A. Parry. 40,938
 Puller: see Gill net puller.
 Pulley: see Split pulley.
 Pulley. Bernard Maurer. 40,401
 Pulley. George Campbell, et al. 38,955
 Pulley. Henry J. Gilbert. 41,060
 Pulley. Isaac N. Kendall. 41,209
 Pulley. William H. Standish, et al. 38,149
 Pulley wheel. Hugh McColl. 41,186
 Pulleys to shafts. Method of securing. Milton O. Reeves. 40,456
 Pulp. Art of producing hardwood. Edward F. Millard. 39,232
 Pulp dryer: see Centrifugal pulp dryer.
 Pulp. Machine for forming hollow ware from. George D. King. 40,159
 Pulp screening machine. Charles J. Foster. 41,200
 Pulsating steam pump. William P. Thurmman, et al. 38,418
 Pulverizer and conveyor for clay. James Evans. 39,436
 Pump: see Air and gas compression pump. Air pump. Force pump. Pneumatic pump. Pulsating steam pump. Rotary pump. Rotary engines, blowers, pumps, &c. Steam pump. Steam and vacuum pump. Vacuum pump.
 Pump. Albert F. Hall. 40,235
 Pump. Donald Noble, et al. 41,191
 Pump. Edward Seitz. 40,795
 Pump. George E. Nye. 39,517
 Pump. Hiram Field. 39,361
 Pump. Horace F. Hodges. 40,802
 Pump. Hugh J. Dykes. 41,141
 Pump. John F. Kuvell, et al. 40,335
 Pump. John W. Fraser, et al. 39,177
 Pump. Millage M. Smith. 41,206
 Pump. Stephen G. Mills. 40,596
 Pump motor. George F. Wightman, et al. 40,405
 Puncher: see Check puncher.
 Puncher for bank use. Alvin V. Lane. 39,666
 Purifier for feed water. James B. Edmiston. 39,217
 Puzzle. Ernest H. E. Eddis. 39,434
 Puzzle. John Clouston. 40,233
 Rack: see Counter and display rack.
 Rack for hay. William T. Wallace. 40,163
 Rack for wagons. Mathew C. Craig. 40,218
 Radiator. Timothy Holland. 39,897
 Radiator. William G. Cannon. 39,998
 Radiator attachment: see Steam radiator attachment.
 Rail cutting machine: see Drag saw rail cutting machine.
 Rail fastening. Thornton E. W. Fav. 41,040
 Rail for railways. Maxamelian M. Supps. 39,130
 Rail for street railways. William T. Jennings. 38,694
 Rail joint. August Klein. 40,271
 Rail joint. Frederick H. Heath. 40,189
 Rail joint. George Gould Stacy. 38,945
 Rail joint. Richard Roxby. 40,162
 Rails in place. Device for securing guard. George David Smith, et al. 38,046
 Rails. Means of securing. Hiram Hart Sponenburg, et al. 38,953
 Rails. Method of and apparatus for making. Toussaint Bicheroux. 40,214
 Railway: see Cable Railway. Continuous railway rail. Electric elevated railway. Electric railway. Elevated railway.
 Railway. Whitecomb L. Judson. 39,808
 Railway car. John A. Brill. 38,876
 Railway car. Walter R. Kimpfle. 40,526
 Railway car construction. Frank L. Joy. 38,653
 Railway construction machine. John W. Close, et al. 40,290
 Railway frog. Nicholas Ratchford, et al. 38,666
 Railway rail chair. Thomas Davies. 38,219
 Railway rails to nail plates. Roll for reducing. John H. Poole. 38,513
 Railway time signal. Eugene Fontaine. 40,450
 Railways. Electric traction increasing system for. Mark W. Dewey. 39,888
 Raiser: see Wick raiser.
 Raising sunken vessels. Device for. Charles H. Brown. 40,021
 Rake: see Hay rake. Hand rake. Horse rake.
 Rake. John H. Sohren. 41,070
 Ramié. Machine for decorticating. Pierre Faure. 40,077
 Range: see Field range.
 Range. John F. Myers. 40,279
 Rasps: see Files and rasps.
 Rasps. Method of making. Alfred Weed. 40,953, 40,981

Ratchet brace: see Self-feeding ratchet brace.	
Reading and calculating. Device for instruction in. William W. Hallett.	38,532
Reamer. John M. Chestnut.	38,619
Reamer. Nathaniel E. Smith, et al.	39,129
Receiver: see Telephone receiver.	
Receiver for exhaust steam. Thomas Foulds, et al.	39,864
Receiver for milk. Edward Batters.	38,136
Receiver for printing telegraph instruments. John Edward Wright.	39,052
Receiver for telephones. Edwin C. Hess.	39,956
Receiver for telephones. Ferdinand Gross.	38,043
Receptacle for feeding grain to live stock. Charles A. Smith, et al.	39,838
Receptacle for preserved meats, &c. Dan Rylands.	39,612
Recorder for cash. Charles E. Stone.	39,795
Recorder for cash. William H. Thompson.	39,340
Recorder for payments. Thomas Pink.	39,299
Recorder for time. Charles J. Barnett, et al.	39,253
Recording compass. John J. Townsend.	41,433
Recording liquid measures. Method of. William M. Fowler.	38,527
Recovering refractory substances from solutions. Art of. Henry Blackman.	40,646
Rectal and vaginal syringe. Henry G. Leisenring.	38,438
Rectal speculum. Talton T. Davis.	38,936
Reducing metals by electricity. Thomas L. Willson.	40,638
Reel: see Bolting reel. Engine and hose reel. Hose wagon.	
Reel. Alexander Dobson.	39,425
Reel for winding and unwinding yarn. Napoleon Tourangeau, et al.	39,296
Reels. Machine for holding. Samuel H. Boone, et al.	40,697
Refrigeration: see Electric refrigeration.	
Refrigerator. Avelyn I. Dexter.	40,773
Refrigerator. Dennis P. Edgar, et al.	38,545
Refrigerator. Everard Hesketh.	41,196
Refrigerator. Robert A. Wilson.	40,742
Refrigerator. Ross C. Simmons.	39,779
Refrigerator and elevating cupboard. John T. Westwood, et al.	41,334
Refrigerator and gas generator. Harry B. Cornish.	38,909
Refrigerator car and building. Joseph F. Hanrahan.	38,132
Refrigerating compound. Wilbert C. Trussell.	39,195
Register: see Autographic register. Indicator and register.	
Register and indicator for cash. Frederick L. Fuller, et al.	40,985
Register for cash. Henry A. Bieley.	39,349
Register for cash. Joseph A. Treat.	39,829
Register for hotels. James Murray.	38,454
Registering photographing apparatus. Ellis E. Moore.	38,622
Regulative hot blast stove. George W. McClure, et al.	41,382
Regulator: see Draft regulator. Electric regulator. Electric motive force regulator. Speed regulator. Temperature regulator. Water feed regulator. Water regulator.	
Regulator for dynamo electric machines. Ernest P. Clark.	39,882
Regulator for dynamo electric machines. James J. Wood.	41,303
Regulator for dynamo electric machines. William H. Elkins.	40,242
Regulator for furnace dampers. Levi F. Smith.	40,065
Regulator for gas. Myron J. Amick.	38,290
Regulator for gas. Andrew Church, et al.	38,305
Regulator for hydraulic windmills. Frederick W. Mount.	41,030
Regulator for steam engines. Frederick W. Mount.	39,918
Regulator for steam furnaces. John Levey.	39,355
Regulator for temperatures. James F. McElroy.	38,131
Regulator for temperatures. James Love.	40,240
Regulator or governor for gas. Lewis Boore, et al.	41,183
Regulator or governor for gas. Lewis Boore, et al.	38,188
Relief valve. Friedrich Wurfler.	40,585
Repeating mechanism for watches. August W. Matthi.	39,616
Replacer: see Car replacer.	
Reporting events. Apparatus for electrically. William B. Luce.	39,827
Resistance: see Electric resistance.	
Resonance chamber for pianos. John B. Mitchell.	38,840
Respiration. Device for inducing full. Charles Cassat Davis.	38,112
Rest for arms and wrists. Rebecca Kirk.	41,157
Return bends for steam radiators. Henry E. Stager, et al.	38,667
Reverser: see Indicating electric switch and current reverser.	
Reversible disk harrow. Jay Spencer Corbin.	38,330
Reversing gear for steam engines. Daniel A. Frazer.	38,058
Revolving fortifications for coast defence. Andrew D. Huff, et al.	41,416
Revolving moulds for glassware. Asa G. Neville, et al.	38,411
Ribbon. Method of manufacturing. Wilhelm Remy.	39,668
Ribbon roller. Frederick O. Clarke.	38,808
Kicker for hay. Doctor F. Oliver.	40,466
Ring: see Guard ring.	
Ring armature. John G. Pool.	41,000
Rivet slotting machine. Judson L. Thomson.	40,287
Rivetters. Joseph J. Kropack.	40,799
Rivetting machine. Judson L. Thomson.	40,286
Road cart. David A. Maxwell.	39,390
Road cart. James Woods.	38,113
Road cart. John B. Armstrong.	40,410
Road cart. Robert Day Scott.	38,282
Road locomotive. Jeddiah F. Hanscom.	38,844
Road sweeper. Mary S. Kjellstrom.	38,713
Roads. Machine for making, repairing and clearing. Geo. W. Taft, et al.	40,361
Roaster. Smelter and operator for ore. John L. Hopper.	38,535
Rock crusher. William Meaken.	38,276
Rock drill. Addison C. Rand.	41,093
Rock drill. Horace G. Williams.	40,897
Rock drill. Joseph C. Githens.	41,096
Rock drill and channelling machine. Joseph C. Githens.	41,095
Rocket. Patrick Cunningham.	40,818
Rocking chair. John Thornbeck.	38,312
Rod: see Guide rod.	
Rod packing. Charles L. Cook.	40,968
Roll holding photographic apparatus. David H. Houston.	39,339
Rolls for making table cutlery. Isaac Keisch.	38,210
Roller bearings. Charles D. Meneely.	38,202
Roller: see Land roller. Steam roller. Trawl roller.	
Roller mill. Joseph L. Willford.	39,977
Roof: see Car roof.	
Roof. James J. McCarthy.	40,574
Roof ladder. Alexander N. Cameron.	40,769
Roofing. John Joseph Gieger, et al.	39,224
Roofing composition. Edward W. Rathbun.	40,024
Roofing fabric. Henry Ward Johns.	38,156
Roofing fabric. Rudolph Graf Westphalen.	39,099
Rooms. Method of ventilating. John le Marchant Bishop.	38,823
Root cutter. David Maxwell.	40,687
Rotary cutter for veneer or lumber. Herman S. Smith, et al.	40,388
Rotary engine. Arnold Kuback.	38,261
Rotary engine. Charles Ward.	40,010
Rotary engine. Gordon C. Hollar.	38,410
Rotary engine. Henry Sewrey.	39,704
Rotary engine. Philippe F. Oddie.	41,290
Rotary engine. Samuel Grenville Brosius.	39,023
Rotary engines, blowers, pumps, and water meters. Robert Johnson.	38,064
Rotary harrow. Robert King.	38,204
Rotary plow. Milton T. Hancock, et al.	39,255
Rotary pump. Benjamin F. Taber.	40,384
Rotary pump. Joseph Menge.	39,699
Rough-rounding and channelling machine. Henry Briggs.	39,925
Round-about. Louis P. Perew.	40,479
Rubber tyres and metal rims for vehicle wheels. Charles K. Welch.	40,630
Rug: see Mats and rugs.	
Rule: see Combination rule.	
Rule. Square and compass combined. Marshall G. Flick.	40,185
Ruler. William S. McKecher.	40,486
Runner: see Sleigh runner.	
Runners for wheeled vehicles. Charles Gladman.	41,317
Saccharine matter. Constantin Fahlberg.	38,918
Saccharine solutions. Method of making and purifying. George A. Drummond.	41,363
Sad iron. Albert Carman, et al.	40,137
Sad iron. Heinrich Koepf.	41,282
Saddle: see Cart saddle.	
Saddle. Cyrus W. Saladee.	39,190
Saddle for velocipedes. George S. Karr.	40,878
Saddle support for bicycles. George R. Perry, et al.	39,309
Safe. Henry J. Moyer.	38,507
Safety attachment for street cars. Louis E. Dubois.	40,589
Safety gate for bridges. Humphrey H. Reynolds, et al.	41,041
Safety pin. Clarence E. Noyes.	40,645
Safety rolling step ladder. Charles H. D. Sincennes.	38,228
Safety trap for discharge pipes. Edward E. Scott.	38,138
Salt and crude glycerine from spent soap-lye. Apparatus for obtaining. Albert Domeier, et al.	40,706
Salt. Apparatus for drying. Sigismund Pick.	39,505
Salt. Apparatus for manufacturing. John Runciman.	39,646
Salt container and sprinkler. Frederick N. Dixon.	40,208
Salt. Process and apparatus for making. Cassius C. Peck.	39,721
Salt recovered from spent soap-lye. Apparatus for purifying. Albert Domeier, et al.	40,705
Salt. Apparatus for obtaining and separating. Sigismund Pick.	39,509
Sand blast in engraving and etching. Process of applying the. Jesse Mills, et al.	40,385
Sap spout. John W. Currier.	38,636
Sash and sash-frame for windows. Geo. R. Williams, et al.	39,476
Sash balance. Byron H. Rose.	40,050
Sash balance. Frank P. Johnson.	38,896
Sash balance. James J. O'Connor, et al.	38,706
Sash balance. John Sharp, et al.	40,370
Sash balance. Joseph T. C. Cole.	39,331
Sash balance and lock. Benjamin Marshall.	38,156
Sash cord fastener. James Patterson Gardner.	38,914
Sash cord machine. Walter H. Avis, et al.	38,733
Sash fastener. Charles Spicer Apple.	38,770
Sash fastener. Lewis C. Walker.	39,446

- Sash holder. Samuel Collins. 40,722
- Sash lock. Charles Altman, et al. 38,249
- Sash lock. Gerolt Gibson. 38,893, 38,894, 38,905
- Sash lock. James Ezra Rose, et al. 38,797
- Sash lock. Joseph DeMars, et al. 39,973
- Sash lock. William Koenen. 40,609
- Sash weights. Flask for making seamless. Addison S. Hodges. 41,064
- Saw: see Buck saw. Circular saw. 38,493
- Saw. Isaac S. Wilson. 38,237
- Saw. William Dumbar. 39,872
- Saw dressing machine. Milo Covell. 40,597
- Saw filing machine. Isaac M. House. 38,128
- Saw guide. Aldus A. Mowry. 41,145
- Saw mill. Francois E. Nadon. 41,023
- Saw mill dog. Michael Hanna. 40,328
- Saw mill set works. Isaac N. Kendall. 38,348
- Saw set. Clark Baker. 40,725
- Saw set. John McIntosh, et al. 40,590
- Saw set. Robert Dillon. 38,319
- Saw sharpening machine. Benjamin F. Sheets. 40,834
- Saw sharpening machine. Milo Covell. 38,357
- Saw straining device. Melvin Jincek. 38,333
- Saw swage. John Hanchett. 39,082
- Saw swage. Peter Payette. 41,242
- Saws. Tool for dressing. George C. Ferguson. 39,769
- Sawing: see Gunning. 39,854
- Sawing machine. Ole Olsen. 39,194
- Scales: see Dormant warehouse scales. Pendulum scales. Weighing scales. 38,915
- Scales. Julius Henning. 39,074
- Scales for weighing grain. John H. Forsythe. 41,217
- Scalper and grader for grain. Hiram Snyder, et al. 40,908
- Scissors for cutting buttonholes. Martin Carmody. 39,040
- Scrap. William Wells, et al. 40,477
- Scraper. Peter M. Broadfoot. 38,065
- Scraper for band saw pulleys. Joseph H. Wentz. 38,927
- Scraper for soil working implements. Richard J. Edwards. 38,652
- Screen: see Coal screen. Window or door screen. 40,477
- Screen door. Charles J. Shirreff. 38,065
- Screen door. William R. Lyle. 38,927
- Screen for doors. Mary Josephine Tenney. 38,652
- Screen for doors and windows. Charles J. Shirreff. 40,477
- Screw: see Wood screw. 38,780
- Screw. Charles C. Holt, et al. 38,837
- Screw cutting and pointing machine. Louis Sevigne, et al. 38,897
- Screw cutting plate. Henry Brimser Keiper. 38,324
- Screw driver. Walter A. Church, et al. 38,147
- Screw eye. Charles D. Rogers, et al. 39,527
- Screw propeller. Charles Myers, et al. 39,504
- Screw stoppers. Method of making. John J. Varley. 41,126
- Screws. Machine for cutting. William S. Dorman. 40,753
- Screws by rolling. Apparatus for forging. Charles Fairbairn, et al. 41,212
- Scrubbing brush. Horace Blanchard. 41,136
- Scrubbing machine. Hector Prud'homme. 40,980
- Scrubbing machine. James Meehan. 40,145
- Seal for cars. Benjamin Johnson. 38,208
- Seal for envelopes. Henry Denis. 40,226
- Seal stopper for bottles. Ernest V. Clemens. 40,888
- Sealing device. Charles Cutriss. 38,986
- Seat: see Car seat. Shifting seat. Vehicle seat. Window seat. 41,398
- Seat for stools. George J. Waldvogel. 38,637
- Seat for vehicles. John P. Huber. 39,881
- Secondary battery: see Storage battery. 38,530
- Section insulator and lightning arrester for electric railways. Elihu Thomson. 41,219
- Sectional dust guard for car axle journals. Frank B. Harrison. 40,579
- Sectional extension ladder. John D. Strumbert. 41,111
- Sectional water heater. David E. Howatt. 40,668
- Secondary batteries. Method of charging. Desmond G. Fitzgerald. 40,631
- Seed planter. Ebenezer R. Knight. 39,676
- Seeding machine. Andrew Johnson. 40,632
- Seeding machine. James Noxon. 40,686
- Seeding machine. Cultivator, &c. Walter Coulthard, et al. 41,091
- Seeding machines. Feed operating gear for. Andrew Johnson. 38,049
- Seeds. Shipping and display box for. Sherman R. Miller. 41,283
- Seine for fishing. Maggie E. Jones. 40,089
- Self-feeding ratchet brace. William H. Heeson. 41,283
- Self-reascending motor. Philippe Baldensperger. 40,089
- Semaphore: see Electric semaphore. 40,420
- Separating flour middlings, semolinax, &c. Machinery for. Robert Creaser. 39,318
- Separator: see Centrifugal separator. Disintegrator and separator. Magnetic separator. Roaster smelter, and separator for ore. 39,465
- Separator. James Higginbottom. 38,511
- Separator. James M. Bradshaw, et al. 40,436
- Separator and cleaner for grain. Charles Closs. 40,575
- Separator for flax seed. David E. Leger. 38,236
- Separator for grain. James M. King. 39,317
- Separator for granular material. Herman Pape, et al. 38,833
- Separator for granular materials. James Higginbottom. 39,133
- Separator for yeast. Fleischmann & Co. 40,602
- Sewer ventilator and electric wire support. James Jolliffe, et al. 40,360
- Sewing machines: see Foot power for sewing machines. 39,467
- Sewing machine. Albert Legg, et al. 41,310
- Sewing machine. Anthony B. McDowell. 39,015
- Sewing machine. Charles B. Hunt. 40,426
- Sewing machine. Edward Kohler. 40,485
- Sewing machine. Eli Williams Broadbent. 40,683
- Sewing machine. Harriet R. Tracy. 40,229
- Sewing machine. Johannes Haas, et al. 39,359
- Sewing machine. Thomas Gaquin, et al. 40,320
- Sewing machine. Vaclav Tomsa. 39,511
- Sewing machine for sewing with wax thread. Edwin J. Peirce. 38,212
- Sewing machines. Trimming attachment for. Adelbert L. Traver. 38,025
- Shade for lamps. Henry Schoerb. 38,055
- Shade holder. Horace Leonard Hall. 38,935
- Shaft and journal box. Amos Clinton Stilson. 41,168
- Shaft support and anti-rattler. Charles Bishop, et al. 38,670
- Shaft tug. Joseph Warner Janney, et al. 38,274
- Shafts through rock. Process of excavating. John D. Long. 41,113
- Shaping plastic and similar material. Machine for. Wolcott A. Hull, et al. 38,499
- Sharpener for bush hammers. Louis Mayer. 38,830
- Sharpener for knives. Charles F. Foster, et al. 40,248
- Sharpener for lawn mowers. Alfred M. Bachelder, et al. 39,953
- Shawls trap. Earl G. Wheeler. 39,899
- Sheaf carrier for harvesters. Benjamin F. Stewart. 39,645
- Sheaf carrier for harvesters. Joseph H. Feeny. 39,107
- Sheaf carrier for harvesters. Lyman M. Jones, et al. 40,156
- Shears: see Gigging and shearing. Sheep shears. 39,749
- Shears. Martin L. Tolbert. 39,803
- Shears for cutting hot metal. William T. Cleveland. 39,850
- Sheep shearing machine. George W. Blanks, et al. 40,044
- Sheep shears. John Howard, et al. 40,492
- Sheet iron pipe. Joel H. Hallowell, et al. 40,331
- Sheet metal can. Frank H. Palmer. 41,408
- Sheet metal can. Thomas B. Hidden. 40,399
- Shelf bracket. William McShane. 40,634
- Shell: see Explosive shell. 38,137
- Sheller: see Pea sheller. 41,118
- Shelving: see Book shelving. 40,382
- Shield: see Dress shield. Vest shield. 40,001
- Shield for carriage wheels. Dutee S. Paine. 40,636
- Shield for trousers. John H. Prutzman. 40,331
- Shifting rail for carriages. James C. Parker, et al. 41,408
- Shifting seat for vehicles. John B. Armstrong, et al. 38,137
- Shingle. George Henry Pedlar. 41,118
- Shingle gauge. John W. Bacon. 40,382
- Ships. Apparatus for unloading. Michel J. Paul. 40,001
- Ships. Method of constructing. Sinclair Stuart. 40,636
- Shirt ironing machine. Clarence O. White. 38,563
- Shoe: see Horse shoe. 40,481
- Shoe. Henry Newcomb. 40,210
- Shoe lacing device. Joseph E. Bertrand, et al. 39,660
- Shoe sewing machine. Andrew Eppler. 38,908
- Shoe slugging machine. Solomon M. Cutter. 41,261
- Shovel: see Wooden shovel. 41,172
- Shovel. Daniel A. Daly. 38,814
- Shovel. Peter Caldwell. 38,734
- Shovel. Victor Lemieux. 38,313
- Shutter: see Camera shutter. Window shutter. 38,477
- Shutter bower. Harvey B. Demarest. 40,460
- Shutter slat tenon. Albert M. Clay, et al. 39,215
- Sickle grinder. George J. Cline. 39,798
- Side dresser for swaged saw teeth. Dempsey B. Hanson. 39,913
- Sieve. Otto Shonelle. 40,686
- Sifter and measure for flower bins. Elisha A. Gill. 41,091
- Sifter for ashes. George Colgate. 39,215
- Sifter for ashes. Robert Magee. 39,798
- Sifter for cinders. John H. Hunt. 39,913
- Sight testing apparatus: see Coin operated. 40,686
- Signal: see Block signal apparatus. Electric block signal system. Electric signal. Electric time signal. Fog signal. Time signal. 41,091
- Signal box: see Electric signal box. 40,089
- Signal for railways. Edward Spencer Piper. 38,919
- Signal for electric railways. William H. Waddell. 40,734
- Signal for electric railways. William J. Smith, et al. 40,109
- Signal for railroads. James S. Parmenter. 41,077
- Signal for railroads. William E. Sevin. 41,079
- Signal for railways. Byron Shoecraft, et al. 38,268
- Signal for railways. Frank Robinson. 38,368
- Signal for railways. Jacob W. Lattig, et al. 41,357
- Signal for railway crossings. Henry Y. Read, et al. 38,775
- Signal for telephone pay stations. William Gray. 39,093

- Signal for vessels. Thomas W. Hand, et al. 40,082
- Signal lamp. William H. Brady. 39,145
- Signal system. Mahlon S. Conly. 40,864
- Signals. Actuating device for railway. Eugene Fontaine. 40,688
- Signals. System of operating railway. Abraham C. Scarr. 38,422
- Signaling apparatus for railways. John H. A. Child, et al. 39,482
- Silicate compound. Marc W. Beylikgy. 41,420
- Silk filaments. Method of and apparatus for making artificial. Hilaire de Chardonnet. 40,117
- Sink. John P. Putnam. 39,793
- Sink trap. John Ballard Carroll. 39,019
- Sink trap. Samuel C. Perkins. 39,112
- Siphon. Henry N. Ruttan. 38,158
- Siphon. Sylvanus Bowser, et al. 38,215
- Siphon discharge flush tank and analogous apparatus. Sidney Walker Miller. 38,179
- Skate. Berthold Hatschek. 39,583
- Skate. Thomas H. McQuown. 39,641
- Skein for axles. Pierre Dansereau. 40,522
- Skeleton wagon and sulky thill. Edward Borland. 39,016
- Skiving machine. Jacob R. Scott. 41,117
- Slab sawing machine. Albert T. Linderman. 40,321
- Slate dressing apparatus. Justus H. Rudolph. 40,971
- Slates. Device for repairing. Iram Z. Merriam. 40,523
- Sled. George B. Paquette. 41,371
- Sleeping car. Samuel M. Charles. 40,943
- Sleigh: see Bobsleigh.
- Sleigh. Arthur F. Pine, et al. 40,884
- Sleigh. Mederic Desaulets. 41,341
- Sleigh. William C. Powell. 40,751
- Sleigh runner for vehicles. John Blankart. 38,115
- Sleigh truck. Carl M. Spencer. 38,464
- Slide rule for engineers. William Cox. 39,468
- Sliding clamp for electrical welding apparatus. Hermann Lemp, et al. 38,081
- Slip: see Memorandum book or sale slip.
- Smelter: see Roaster, smelter, &c.
- Smelting process. William Laurence Austin. 39,007
- Smoke consumer. Edward E. Dubier. 40,080
- Smoke consumer. Frank L. Bates. 40,335
- Smoother iron. Leander D. Good. 38,502
- Snoring. Apparatus for preventing. Anton Morterts. 39,525
- Snow plow. Joseph Kobb. 40,407
- Snow plow. Max. Szarbinowski. 39,535
- Snow plow and flanger for railroads. Richard J. McKeone, et al. 40,798
- Snow shoe. Carl O. Stone. 40,965
- Soap. Sarah E. Ireland. 40,635
- Soap and cheese. Machine for cutting. John T. Thomson. 38,316
- Soap. Apparatus for making. Milton J. Palmer. 40,605
- Soap holder and distributor. William Wilcklow. 38,969
- Soap lye. Method of treating. Ebenezer K. Mitting. 40,028
- Sock: see Sole or sock for footwear.
- Socket for incandescent lamps. Charles Tellier. 38,539
- Socket pipe for drainage. Henry Knowles. 40,247
- Soda: see Caustic soda.
- Soda. Apparatus for manufacturing chlorine and caustic. James Greenwood. 39,524
- Sofa and bed. Daniel L. Oulton. 40,895
- Soldering and cementing: see Electric soldering and cementing.
- Soldering irons: see Electric soldering irons.
- Soldering machine. Jaques Wehrin. 39,556
- Sole or sock for footwear. Paul Max. Hoffmann. 38,975
- Soles and other forms. Machine for cutting. Allison M. Stickney. 38,423
- Soles for footwear. Art of and mechanism for channelling. Albert E. Johnson, et al. 39,263
- Solvent for gums. William Read. 39,656
- Soot door, ventilator and check draft for chimney apertures. William O. McRobie. 38,363
- Sound arrester for smoke preventers. Robert D. Smith. 39,203
- Sounding board for pianos. Frederick Kaiser. 39,544
- Spacer for type matrices. Joseph C. Fowler, et al. 39,305
- Spark arrester. Henry C. Smith. 40,064
- Spark arrester. James W. Ramsey. 41,312
- Spark arrester and smoke consumer. David Anderson, et al. 39,992
- Speaking tube. John William Black. 38,880
- Speed regulator for governors. Freeman N. Saylor. 40,333
- Spike. Alexander C. Trotter, et al. 38,337
- Spinning wheel. Henry Lotz. 40,739
- Split pulley. Daniel G. Reitz. 40,996
- Spokes. Machine for manufacturing metal. Robert Alpe. 39,681
- Sponge: see Artificial sponge.
- Sponging iron. Lewis H. Tarrant. 39,211
- Spongy substance. Machinery for squeezing. Charles Aretas Clark. 38,977
- Spool. Richard Haynes, et al. 38,034
- Spool holder and needle cushion. Arthur J. Bowslaugh. 38,099
- Spoon. George A. Gray. 38,027
- Spoon. Isaac N. Plotts. 38,701
- Spoon and fork. Hubert C. Hart. 38,040
- Spoon bait. Ernest F. Plueger. 41,129
- Spoon bait. Gardiner M. Skinner. 38,685
- Spout: see Sap spout.
- Spring and check for doors. Robert Adams. 40,942
- Spring bed. Arthur H. Viel. 39,334
- Spring bed bottom. Daniel Edgar. 38,600
- Spring bottom for bedsteads, &c. Elias Dimant. 39,677
- Spring coupling for vehicles. James Warnock & Co. 38,902
- Spring fastener. Olinthus G. Alderman. 38,497
- Spring for vehicles. William Atkinson. 38,032
- Spring gear for vehicles. George E. Bartholomew. 38,433
- Spring hinge. Andrew J. McCauley. 41,277
- Spring mattress. George W. Murray. 38,213
- Spring mattress. Ozello R. Hunt. 38,214
- Spring motor. Columbus A. Moore. 39,207
- Spring motor. Eli S. Reed. 41,160
- Spring motor. Swan Peterson. 40,203
- Spring motor for screw propellers. Abel G. Heath, et al. 40,069
- Spring motor for sewing machines. Bruno Reichelt, et al. 40,861
- Spring motor for sewing machines. Daniel M. Pfaultz. 39,480
- Spring support for upholstery. John A. Staples. 40,963
- Spring tooth harrow. James A. Publow. 40,394
- Sprinkler for lawns. Daniel C. Wilgus. 40,542
- Sprinkler for lawns. Jerome B. Fellows, et al. 39,622
- Sprinkler for potato vines. Edward McEvoy, et al. 40,679
- Sprocket wheel. Daniel M. Maxon, et al. 40,763
- Square. Frederick F. Poole. 38,944
- Squeezer for floor cloths. William Keane. 38,794
- Stage apparatus. Neilson Burgess. 40,731
- Staging. Charles A. Dodge. 40,037
- Stamp: see Hand dating stamp. Time stamp.
- Stamp. Taylor S. Buck. 38,692
- Stamp affixer. Joseph Coyle, et al. 41,112
- Stamps. Apparatus for making rubber. Josiah C. Barton. 40,680
- Stamping machine: see Multiplex stamping machine.
- Stand for holding bottles containing poison. George L. Rands. 39,449
- Stanchion. Philander Avery. 40,793
- Staple driving machine. Peter A. Coupal, et al. 40,455
- Starter for cars. Elias Vernon, et al. 39,819
- State room for sleeping cars. Charles L. Lockwood. 41,329
- Station and street indicator. Gerald de Courcy O'Grady, et al. 41,034
- Station indicator. George W. Robertson. 40,424
- Station indicator. Sabin Soly. 38,639
- Stave making machine. James Pleukharp. 39,764
- Stave sawing machine. William Merrill. 41,414
- Staves. Machine for cutting. J. W. Chapman. 40,362
- Stay: see Dress stay. Garment stay.
- Steam and air injector for boiler furnaces. Salyer R. Earle. 39,392
- Steam and air motive power engine. Edward Field. 39,469
- Steam and vacuum pump. Ernest Korting. 38,218
- Steam boiler. Robert R. Zell, et al. 38,807
- Steam boilers, &c. Method of and means for removing and preventing scales and incrustation in. John Draper. 38,596
- Steam boilers. Process of protecting. Frank G. Fowler. 40,737
- Steam cooker. Charles Kruschia. 38,949
- Steam engine. Anselme H. Larochele. 40,372
- Steam engine. Charles D. Mosher. 31,271
- Steam engine. Dexter D. Hardy, et al. 40,212
- Steam engine. Edward W. Curtis. 39,934
- Steam engine. Elmer S. Smith. 40,369
- Steam engine. Henry Monk. 40,969
- Steam engine. John A. Gresham. 39,336
- Steam engine. Joseph A. Dumford. 41,076
- Steam engine. Ransford W. Basson. 38,400
- Steam engine. Richardson Engine and Steam-ship Company. 38,978
- Steam engine. Robert McCandless Beck. 40,326
- Steam generator. Charles D. Mosher. 39,589
- Steam generator. Charles W. Foster. 38,491
- Steam generator. John J. Thornycroft. 39,547
- Steam generator. Richard Cumliffe. 41,324
- Steam generator. William Burling. 39,342
- Steam generator. William J. Ranton. 41,383
- Steam generator. William Snee, et al. 39,577
- Steam generators. Sectional casing for. Thomas F. Morin. 40,715
- Steam heating system. William P. Skiffington, et al. 39,792
- Steam pump. Laigi d'Auria, et al. 40,012
- Steam pumping engine. Frank Landsberg. 40,653
- Steam radiator attachment. Henry E. Stager, et al. 38,606
- Steam road roller. Edward T. Wright. 38,547
- Steam surface condenser. Gustave Horner. 39,545
- Steam trap. Alvin P. Clark. 41,229
- Steam trap. Frank A. Littlefield. 40,774
- Steam trap. Franz Funke. 38,763
- Steam trap. John Morehead. 40,000
- Steam vehicle. Anderson C. Marshall. 41,198
- Steel and iron. Method of making. James H. Lancaster, et al. 39,867
- Steel direct from the ore. Method of and apparatus for making. William F. C. M. McCarthy. 39,975
- Steel or ingot iron. Joseph Colley. 39,160
- Steel or iron. Method of treating waste tinned. William L. Brockway. 38,178

Steel. Process of treating. William B. Middleton.....	40,777	Substances. Machine for sorting and separating. John M. Rishworth, et al.....	40,471
Step. See Car step.		Sugar. Apparatus for refining. George A. Drummond.....	41,358
Step ladder. Andrew Barr.....	40,548	Sugar. Art of cleaning and washing raw. George A. Drummond.....	41,364
Step ladder. Martin Croissant.....	39,770	Sugar by lixiviation. Apparatus for obtaining pure white. George A. Drummond.....	41,361
Sterilizing and drawing of liquids. Machine for. Gustave H. Neuhass, et al.....	38,567	Sugar by lixiviation. Process of refining. George A. Drummond.....	41,362
Sterilizing apparatus. Arthur Regel.....	39,533	Sugar from molasses. Process of making. Carl Steffen.....	39,853
Sterilizing apparatus. Johann F. H. Gronwald, et al.....	38,568	Sugar. Process of washing and boiling. Juice for obtaining grain. George A. Drummond.....	41,360
Sterilizing milk. Apparatus for. Johann F. H. Gronwald, et al.....	38,569	Sugar juice into grain sugar. Process of working up. George A. Drummond.....	41,359
Stick: see Printer's stick.		Sulky. Sterling Elliott.....	41,396
Stitches: see Chain stitches.		Sulky spring tooth harrow. Thomas G. Cook, et al.....	38,148
Stitching horse. Hermann Doering.....	39,493	Sulky thill: see Skeleton wagon.	
Stock car. William J. Avery.....	40,499	Sulphur from sulphurous pig iron. Method of separating. Gustav Helgenstock.....	39,155
Stock tether. Michael Rooney.....	38,736	Sulphuric acid. Apparatus for the manufacture of. Emile and Jules Delplace.....	38,608
Stocking. Leonidas M. Preston.....	39,874	Support: see Foot support. Saddle support. Sewer ventilator and electric wire support. Table leaf support.	
Stocking. William H. Howard.....	40,875	Support for bicycles. James W. Snyder.....	40,295
Stoker. R. H. Williamson.....	40,356	Support for upholstery springs. John A. Staples.....	39,301
Stoker for steam boilers. James Proctor.....	40,294	Support for corsets. Eugene Pearl.....	39,919
Stone: see Artificial stone.		Support for garments. Lena A. Topp.....	40,948
Stone crusher. Ryerson Dudley Gates.....	38,848	Surface printing plate. John Mullaby, et al.....	40,346
Stone cutting and stone dressing machine. William Errington.....	40,106	Surgical appliance. Frederick L. Barnum.....	38,697
Stone cutting machine. David Rettiger.....	38,169	Surgical instrument: see Electrical surgical instrument.	
Stone. Method of making artificial. Charles W. Stevens.....	39,932	Surveyor's instrument. John R. Hamlon.....	40,244
Stone. Process of laying artificial. Otto E. C. Guelich.....	38,232	Suspender. Charles R. Harris.....	38,810
Stone. Process of manufacturing artificial. Otto E. C. Guelich.....	38,437	Suspender. Elias H. Lieberthal.....	38,066
Stool: see Campstool.		Suspender. Joseph L. Fredlihp.....	40,519
Stop action: see Organ stop action.		Suspender bandage. Josephus C. Chambers.....	38,286
Stop cock. Cyrus F. Logan.....	40,186	Swage: see Saw swage.	
Stop for engines, &c. Josiah Nesbitt, et al.....	38,659	Swath turner. Edward C. Blackstone.....	40,121
Stopper: see Screw stopper.		Sweeper: See Road sweeper.	
Stopper for bottles. Carl Hanish.....	41,401	Sweeper. Joseph O. Boggs, et al.....	40,352
Stopper for bottles. George F. Atwood.....	40,038	Sweeper for streets. John Jones, et al.....	40,260
Stopper for bottles. Joseph A. Stukey.....	39,941	Swimming equipment. Patrick Curran.....	38,279
Stopper for bottles, &c. William P. Benwick.....	39,428	Swing. George Washington Smith.....	38,838
Stopper for bottles and jars. Hugo Gerike, et al.....	38,443	Swinging chair. Julius M. Eller.....	38,173
Stopping mechanism for knitting machines. George J. Manderfield.....	40,431	Switch: see Controlling switch. Electric switch. Frog and switch. Indicating electric switch. Limit switch.	
Storage battery. Charles F. Winkler, et al.....	39,234	Switch for electric lights. Andreas Lundberg.....	39,172
Storage battery. Charles H. Logan, et al.....	38,376	Switch for electric lights. Charles Green.....	41,176
Storage battery. Charles J. Hartmann.....	41,169	Switch for electric locomotives. Frank B. Rae.....	39,720
Storage battery. Charles Sorley.....	39,828	Switch for railways. Axel A. Strom.....	38,434
Storage battery. James H. Gerry, et al.....	40,386	Switch for railways. James P. Kelly, et al.....	41,105
Storage battery. Justus B. Entz et al.....	40,318	Switch for railways. Joseph R. Matthews.....	38,350
Storage battery. Nathan H. Edgerton.....	39,875	Switch for railways. Martin Hynes.....	38,773
Storage batteries. Method of making plates for. Anthony Reckenzaun.....	41,307	Switch for stationary motors. Frank Bankson Rae, et al.....	38,076
Store service apparatus. Seldon A. Baily.....	38,251	Switch tongue adjuster. Isaac Mador, et al.....	38,903
Store service apparatus. William R. Cole.....	39,558	Switches and signals. Actuating gear for railway. Henry Beser, et al.....	40,464
Stove: see Gas stove. Hot blast stove. Regulative hot blast stove.		Syringe: see Rectal and vaginal syringe. Vaginal syringe.	
Stove. Albert Lundstrom.....	40,815	Syringe. Joseph Lalonde.....	40,016
Stove. Ferdinand T. Schneider.....	41,336	Syringe. William B. Spencer.....	39,514
Stove. Joseph T. Robbins.....	40,839	Syrup: see Cough syrup.	
Stove. Lewis T. Wilcox.....	40,045	Table: see Extension table. Veterinary operating table.	
Stove. Margaret A. Wilcox.....	40,915	Table. Edwin Hinkel, et al.....	39,038
Stove. Sarah L. Walker.....	41,004	Table attachment for bedsteads. Charles C. Elston.....	41,057
Stove. Victor E. Randall.....	40,955	Table leaf support. Charles K. Olsen.....	38,220
Stove. William Forbes.....	40,525	Table. Prie-Dieu and confessional. Hector Lavigne.....	39,226
Stove and furnace. Carl Brandt.....	40,902	Tablet for post boxes, &c. Jean Pape, et al.....	39,567
Stove leg attachment. John B. Morse.....	38,907	Tablet for recording sales. Henry Victor Piolet.....	39,024
Stove lighter. Pierre Morency, et al.....	38,724	Tack driving machine. Michael G. Mains.....	39,187
Stove pipe. Cleophas LeBel.....	38,296	Tackle block. Frank X. Rousseau.....	39,459
Stove pipe. John F. Ross.....	39,458	Tag wiring and bundling machine. Albert R. Tiffany, et al.....	38,320
Stove pipe. John W. Littlewood.....	38,318	Tank: see fixing and washing tank. Syphon discharge flush tank.	
Stove pipe. William A. Kemp.....	41,389	Tanning hides. Process of. Tilmon L. Grafton.....	38,371
Stove pipe and collar fastener. John J. Travis, et al.....	38,328	Tap: see Gas tap. Liquid gauge and tap.	
Stove pipe damper. John B. Cook.....	38,449	Tap socket for barrels. C. J. Mayhew.....	40,402
Stove pipe elbows. Machine for making. Alfred N. Fairman.....	41,252	Taper attachment for lathes. Daniel Currie.....	39,976
Stoves. Auxiliary base for. John D. Rassey, et al.....	40,932	Tapping and pipe threading machine. Horace C. Bradford.....	40,253
Strainer: See Pail and strainer.		Tapping cock and valve. Benjamin J. Bacon.....	41,193
Strainer for tea. Frank J. Wills.....	39,278	Tapping device for stay bolt holes. James T. Connelly.....	38,162
Strap: see Hitching strap. Shawl strap.		Tapping pipes, drain sewers, &c. Method of and apparatus for. David G. Hoey.....	40,157
Strap and hoop for boxes and packages. Spencer C. Cary.....	39,857	Tapping water and other mains. Apparatus for. Anthony P. Smith.....	40,770
Street broom. John Brown, et al.....	40,672	Target. Edwin W. Ely.....	38,729
Street car. John A. Brill.....	38,878	Target. Joseph Belet.....	39,590
Street car. John A. Mehling, et al.....	40,889	Tartaric acid. Benoit G. Talbot.....	39,131
Street indicator for street cars. George Spoelstra et al.....	40,324	Tea blending machine. Thomas Crompton.....	39,185
Street sweeping Machine. Ephraim Choquette.....	38,594	Tea chest. Paschal Buford.....	38,618
Stretcher: see Carpet stretcher.		Tea chest linings and covers. Construction of. August Schilling.....	38,415
Stretcher. Herman J. Rohr.....	39,603	Tea kettle. John Black, et al.....	39,620
Stretcher and fastener for wire. George Chamberlain.....	41,339	Tea kettle. Volney C. Baker.....	40,879
Stretcher for boots. Watkin L. Faire.....	39,179	Tedder for hay. Edmund D. Reynolds.....	38,582
Stretcher for trousers. Clarence Albertus Evans.....	38,932		
Stretcher for wire. Remi Beaupre.....	39,157		
String for musical instrument. Lawrence A. Subers, et al.....	38,297		
Strip: see Weather strip.			
Structures: see Foundation for structures.			
Subdividing electric currents. Walter Simpson.....	40,123		

- Telegraph : see Autographic telegraph.
 Telegraphs : see Printing telegraphs.
 Telegraphic apparatus. Samuel Van Buren Essick 38,455
 Telegraphic transmitter. Samuel W. Smith 39,713
 Telephone. William C. Lockwood 38,506
 Telephone and electrical exchange. Almon B. Strowger, et al 38,372
 Telephone and other electrical exchanges. Almon B. Strowger 39,866
 Telephone receiver. S. Lloyd Wiegand 38,598
 Telephone receiver and transmitter. Arthur T. Collier 41,084
 Telephone toll box and connection register. Charles E. McCluer 40,819
 Telephones : see Arm rest for.
 Telescope. Alfred Rudall 38,571
 Temperature regulator. James F. McElroy 39,405, 39,409
 Temperature regulator. The Consolidated Car Heating Co. 38,972
 Temporary binder. Henry W. Scattergood 41,370
 Tenderer for meat. Oscar M. Arnold, et al 40,507
 Tenon : see Shutter slat tenon.
 Tenoning machine. Abraham Giddens 40,250
 Terrett for harnesses. George Mallory 39,169
 Tester : see Egg tester.
 Testing strength. Machine for. Franklin W. Kremer 40,461
 Testing machine : see Muscular power testing machine.
 Tether : see Stock tether.
 Thermometer. George H. S. O. Moller 38,924
 Thermometer and indicator. Harvey Murdock 41,085
 Thermostat. Archibald H. Brintnell 39,080
 Thill coupler. Archibald Paul 38,401
 Thill coupler. Dillon S. Brown 38,483
 Thill coupler. James O. Ferguson, et al 38,240
 Thill coupler. Lewis A. Batty 40,041
 Thill coupling. Austin Futz, et al 39,455
 Thill coupling. George L. Blackman 39,384
 Thill support. Andrew Henry Fletcher 38,048
 Thill tug. Daniel R. Porter 41,167
 Thimble. William Bramley, et al 41,097
 Thimble for stove pipes. Michael J. Fahey 38,265
 Thimble for stove pipes. Stephen Cheney, et al 38,247
 Thread separator for ring spinning frames. Wm. Robert Graveley 38,889
 Threshing machine. Absalom Merner 40,951
 Threshing machine. James Buchanan 41,032
 Threshing machine. John Abell 39,375
 Threshing machine. John Edward Ball 38,882
 Threshing machine. Wilhelm Alpert 40,191
 Threshing machines. Attachment for. Jacob Spaetzel 38,791
 Threshing machines. Straw separator for. Joseph E. Cook, et al 38,667
 Ticket : see Price ticket. Transfer ticket.
 Ticket system. John A. Milliken 41,086
 Tidal motive power. William Porter, et al 41,205
 Tie bar and side plate for railway tracks. Axel A. Strom 38,446
 Tie bars and connecting rods for railways. Method of manufacturing. Axel A. Strom 38,445
 Tie for railroads. Amos K. Hoffmeyer 39,521
 Tie plate for railroads. James S. Fox 40,873
 Tightener : see Belt tightener.
 Tile fastening for roofing. Mark A. and John H. Jackson 38,989
 Tiles. Porcelain, earthenware, &c. Method of manufacturing. Henry Baggaley 38,245
 Time record book. Henry W. Scattergood 41,202
 Time safe-bolt retracting device. Francis M. Williams 38,759
 Time signal for railways. Adalbert H. Thorp 40,776
 Time signal for railways. Eugene Fontaine 40,199
 Time stamp. Charles H. Shaw 38,347
 Tin can. William Pratt 38,093
 Tinsmith's machine. Enos E. Stow 41,050
 Tinware. Corrosive preventive for. Isaac J. Lawrence, et al 38,904
 Tinware vessel. Irving Dudley King, et al 38,106
 Tip for vehicle poles. William J. Austin 38,300
 Tire : see Tyre. Cushioned tire. Pneumatic tire.
 Toaster : see Boiler and toaster.
 Tobacco. Apparatus for ordering. Samuel P. Mayo, et al 40,201
 Tobacco. Machine for treating. John C. Frost 40,922
 Tobacco. Machine for treating leaf. Charles A. Snyder 41,376
 Tobacco. Machine for treating leaf. Richard E. Ellis, et al 38,603
 Tobacco rolling machine. John E. Richards 39,313
 Toe weight for horses. Charles Taro 39,184
 Toilet paper fixture. Seth Wheeler, et al 38,180
 Toilet paper roll. Seth Wheeler, et al 38,181
 Toilet soap tablet. Daniel Richards 41,374
 Tongs for lifting and handling ice, &c. John E. Goodman 39,821
 Top for buggies. Daniel Conboy 38,655
 Top joint for vehicles. Amos M. Hess 41,078
 Tool : see Combination fence tool. Drilling tool. Fence tool.
 Tool. John N. M. Shimer 39,304
 Tool for clamping timber. John J. B. Lillington 40,124
 Tool for joining wire fence strands. Aldarilla C. Jewett 39,991
 Tool for making cocks, valves, &c. Frederick Taylor 40,075
 Tool for masons' use. James G. Faulds 40,308
 Tool for watch makers' use. George W. Cameron 41,386
 Tool grinding machine. Chauncy Wing, et al 38,498
 Tool holder. Antoine Fleurent 39,254
 Tools to handles. Device for securing. Frank H. Thompson, et al 38,546
 Tooth. David B. McHenry 40,002
 Tooth for cultivators. John Muir 40,266
 Towing bridle. George W. Briggs 40,487
 Toy. Charles M. Crandall 40,138
 Toy. Maximilian Thiele, et al 41,011
 Toy. Waldo V. Snyder 40,366
 Toy. William A. Gay 40,544
 Toy bank advertising device. John W. Camvin, et al 41,128
 Tracing wheel. Samuel Newman 40,840
 Track for railways. Plimmon H. Dudley 40,304
 Track for railways. Walter J. Hough 39,146
 Track jack. Philip A. Harding 39,049
 Track laying machine. Robert E. Hurley 40,023
 Tracks. Method of constructing street railway. Catherine L. Gibbon 38,599
 Traction apparatus. Roger W. Wallace 39,335
 Traction engine. George T. Glover 39,877
 Traction motor. James S. Baldwin 40,984
 Tractor for obstetric forceps. Albert B. Lyman 38,110
 Tramway : see Aerial tramway.
 Tramway. Levi Meredith Brock 38,489
 Transfer : see Pneumatic transfer.
 Transfer ticket. Arthur White 40,188
 Transfer ticket. Emil C. Boehk 41,182
 Transfer ticket. William E. Whitehead 40,458
 Transfer ticket. Wallace Maclean 41,124
 Transformer : see Electric transformer. Electric welding transformer.
 Transformer for heavy currents. Herman Lamp, et al 38,079
 Transmission of currents through conduits. Method of and apparatus for the. John W. Grantland 40,283
 Transmitter : see Telegraphic transmitter.
 Transmitter for telephones. Arthur T. Collier 40,083
 Transmitting power. Apparatus for. Theodore Kreig 40,720
 Transportation. Method of. Wallace C. Andrews 38,719
 Transporting : see Elevating and transporting.
 Transposing key board. Martin Philipps 39,001
 Transposing piano action. Carl Gustav George 38,441
 Trap : see Animal trap. Drain trap. Fly trap. Safety trap. Steam trap. Sink trap.
 Trap for animals. Chancy Roberts Jenne 38,088
 Trap for animals. Chauncey B. Trumble 38,273
 Trap for animals and birds. George Andrews 41,345
 Trap for animals. Martin S. Miller 40,987
 Trap for gophers. Gordon Gilchrist 38,182
 Trap for plumbers' use. Frederick N. Dubois 39,945
 Trap for water pipes. John H. King, et al 38,835
 Trawl roller. John B. J. D'Entremont 39,338
 Treadle for sewing machines. Russel Frisby 40,748
 Trees and hedges. Machine for cutting, trimming and pruning. Nelson Goodwin 39,703
 Tricycle. Waldo V. Snyder 39,348
 Trimmer for wicks. Herbert H. Pearce 38,310
 Trolley wheel. John C. Mullin, et al 39,773
 Trolley for electrical railway cars. Edgar M. Tousey 39,930
 Trough : see Feed trough. Water trough.
 Trousers stretcher. George S. MacDonald 40,916
 Truck : see Baggage truck. Car truck. Motor truck. Sleigh truck.
 Truck. John F. Lemaitre, et al 39,242
 Truck. Thomas H. Gemmell, et al 38,942
 Truck. William Voss 40,807
 Truck for lumber kilns. Albert F. Bemis 39,237
 Truck for motors. John A. Brill 40,978
 Trueing circular bodies. Machine for. Jacob Neff Barr 38,633
 Truss. Alexander Dallas 39,008
 Truss. Charles Cluth 40,472
 Truss. John H. Brownlow, et al 38,579
 Tub : see Bath tub.
 Tube : see Metal tube. Pottery dipping tube.
 Tube. Edwin Walker, et al 39,993
 Tubes by electrolysis. Apparatus for manufacturing. Francis E. Elmore, et al 38,323
 Tubes. Machinery for rolling and expanding metal. Thomas C. Barraclough 39,565
 Tubes. Machine for swaging the ends of metal. John Patterson Kennedy 38,119
 Tubing : see Flexible metal tubing.
 Tufting machine. Henry T. Shipley 38,816
 Tug for harnesses. Joseph W. Roberts 38,812
 Tuning pin for pianofortes. William H. Ivers, et al 38,355
 Turbine. William H. Elmer 38,341
 Turbine. George Munro 39,712
 Turbines. Apparatus for regulating the power and speed of. Johann L. Furiakovic 40,009
 Turner : see Swath turner.

Turner for music leaves. Martin A. McMartin, et al.	38,518	Vehicle pole. William L. Pike.	41,180
Turpentine and means of producing the same. Thomas Drake	38,414	Vehicle runner. Charles L. Pierce.	38,500
Twine holder cup and take up. William Bentley, et al.	40,867	Vehicle running gear. Edward Strom.	41,338
Twine. Machine for making. George A. Lowry.	39,501	Vehicle running gear. George B. Caldwell.	39,460
Two wheeled vehicle. Derry Snyder.	39,415	Vehicle. Running gear for. Clarence E. Holley.	39,209
Type bar. Boswell H. St. John.	40,568	Vehicle springs. Mode of attaching. Malcolm E. Robb.	41,154
Type bars, matrices, &c. Machine for forming. Ottmar Mergenthaler.	39,920	Vehicle wheel. Herbert Horton.	38,533
Type composing machine. John Gustafson.	41,436	Vehicles. Apparatus for starting and stopping. Joseph W. Lee, et al.	39,786
Type setting machine. John B. Odell.	39,462	Vehicles. Apparatus for supplying electricity to electrical. Frank Wynne.	39,555
Type setting machine. John B. Odell, et al.	41,204	Vehicles. Apparatus for weighing. Wanamaker International Car Scale Company.	38,970
Type writer. Algernon Granville, et al.	39,152	Vehicles. Device for propelling. DeWitt C. Bouton.	40,710
Type writer. Audley E. Harnsberger.	41,439	Vehicles. Machine for driving. Fredrich Rùhs.	41,272
Type writer. Austin Lowe.	39,096	Vehicles. Mechanism for stopping and starting. William Giffard.	39,642
Type writer. George C. Blickensterfer.	40,997	Velocipede. Daniel I. Lybe.	38,691
Type writer. George W. N. Yost.	40,309	Velocipede. James C. Belyea, et al.	39,836
Type writer. Godfrey H. Lasar.	40,390	Velocipede. Peter Gendron.	41,265
Type writer. Jacob Föbel, et al.	38,083	Velocipede. Thomas Fane, et al.	39,777
Type writer. Samuel C. Hurlbut.	40,829	Velveteen binding. Marcus Merritt Beeman.	38,913
Type writer. Seward A. Dean.	39,441	Vending apparatus. John A. Williams.	39,484
Type writer. Theodore W. Searing.	40,791	Vending apparatus. Thomas C. Kirkham.	40,039
Type writer. Wellington P. Kidder.	39,417	Vending machine. Robert Moran.	40,615
Type writer and matrix making machine. Edward P. Sherwood.	39,669	Vending machine. William G. Latimer.	40,746
Type writer for the blind. Elizabeth Shresley.	38,447	Veneer and board cutting machine. Gustav A. Oncken.	38,628
Typograph. Fred. E. Bright.	40,327	Veneer box. Jeffery T. Ferres.	40,836
Typograph. John Raphael Rogers.	38,379	Veneer. Machine for corrugating. William Turreff.	40,718
Typographic machine. Thomas T. Heath, et al.	41,263	Veneer. Method of and means for cutting. Gustav A. Oncken.	38,583
Tyre: see Pneumatic tyre. Rubber tyre.		Veneering press. Augustus Newell.	38,397
Tyre. Peter Gendron.	41,432	Ventilating and heating apparatus. Charles DeZang Howard.	38,552
Tyre for road vehicles. Walter Swain, et al.	40,225	Ventilating and heating railway carriages. Method of. Samuel Hughes.	38,523
Tyre for vehicles. Henry Rohrer.	40,667	Ventilating apparatus. William T. Sugg.	40,494
Tyre for bicycles. Thomas Fane, et al.	38,284	Ventilating heater. Riverius Marsh.	40,220
Tyre heater. William B. Neville, et al.	40,397	Ventilating railway carriages. Method of. Samuel Hughes.	38,522
Tyre set. James B. Curbertson, et al.	39,370	Ventilator: see Sewer ventilator. Soot door ventilator and check draft.	
Tyres. Method of repairing pneumatic. Robert Cowen.	40,729	Ventilator. August Riedinger.	39,686
Umbrella frame. William H. Rodden.	41,419	Ventilator. George W. Greig.	41,403
Underground conduit for electrical conductors. James F. Cummings.	40,563	Ventilator. Peter Abrahamson.	39,178
Underground conduit for electric wires, &c. Charles C. Gilman.	40,025	Ventilator. William McFarlam, et al.	40,608
Underwaist. George D. McKay.	40,462	Ventilator. William S. Laycock.	39,477
Uneven surfaces. Process of and apparatus for electrically reproducing. Noah S. Amstutz.	41,438	Ventilator and damper. John Henry Stone.	38,849
Utensil: see Household utensil. Kitchen utensil.		Ventilator for stovepipes. Charles James Kettyle, et al.	38,937
Vacuum pump. Adolph Berrenberg.	39,997	Vessel: see Cooking vessel. Tinware vessel.	
Vaginal syringe. John R. Trott.	38,225	Vessel for containing liquids. John D. Sprunt.	40,921
Vaginal syringe. Loren E. Hendrickson.	40,249	Vessel for cooking, smelting and evaporating. Theodore Frederking, et al.	39,651
Valve: see Air valve. Coupling and valve. Cut-off valve. Engineer's valve. Exhaust valve. Relief valve. Tapping cock and valve.		Vessels. Apparatus for loading and unloading. John Abbott.	40,444
Valve. Albert W. Daw, et al.	38,681	Vessels in fogs. Means for distinguishing. Wolfred Nelson.	41,426
Valve. Cornelius Birkery.	39,710	Vessels. Method of making glass. William K. Elson.	41,391
Valve. Edward Mortyn.	39,020	Vessels. Method of propelling. John S. Morton.	41,326
Valve. George B. Moore.	40,174	Vest shield. John F. Bullock.	41,197
Valve. George H. Chappell, et al.	40,914	Vestibule hood for cars. Thomas A. Bissell.	38,481
Valve. George K. Tower.	41,187	Veterinary operating table. Monroe M. Copp, et al.	40,467
Valve. Henry C. Sergeant.	41,421	Vignettes. Machine for stamping and printing. Hermann Schwarz.	39,696
Valve. Henry Giessenbier.	39,047	Vice: see Anvil vice.	
Valve. John King.	38,456	Vice. Arthur Wise Cash, et al.	38,200
Valve. Tronson Draper.	39,843	Vice. David Sabourin, et al.	40,183
Valve. William M. Mackay.	38,283	Violin. James A. Close.	38,684
Valve. William Thomson.	40,662	Voltaic effects. Device for obtaining. Peter Heskier.	36,618
Valve and valve chest for steam engines. George Fussell.	38,616	Wagon: see Dumping wagon. Hose wagon.	
Valve for elevators. Cofrau J. Hall.	39,022	Wagon. Hornisdas Quenville.	38,343
Valve for pumps. Frederick A. Halsey.	39,401	Wagon. James T. Dougine, et al.	38,728
Valve for train pipes. James F. McElroy.	39,810	Wagon. John Wigand.	40,150
Valve gear. Bruno V. Nordberg.	40,204	Wagon box. William McCubbin.	40,358
Valve gear for engines. Ellis J. Woolf, et al.	38,269	Wagon for advertising. William W. McCull.	40,838
Valve gear for fluid rams and pistons. John Parkin.	38,227	Wagon spring. John H. Smale.	41,431
Vapor lamp. Harry A. Kerslake.	39,076	Wallet. George K. Morton.	40,237
Vapors or gases. Apparatus for condensing or liquifying. John Gangee.	38,209	Wardrobe. William T. Cottier.	38,224
Varnish, etc. Thomas B. Osborne.	39,747	Warmer: see Foot warmer.	
Varnish bottle. Thomas G. Watson.	38,405	Warming cars by means of electrically heated water. System of. Thomas Ahearn.	39,507
Varnish, Process of and apparatus for making. Heinrich Pfame.	40,445	Warp operating mechanism for cross weaving. William Tallot.	40,232
Vegetable fibre. Machine for breaking and cleaning. Alexander Morison.	40,515	Washboard. Charles E. Williams.	39,321
Vehicle: see Top joint vehicle. Two wheeled vehicle. Steam vehicle.		Washboard. Mary C. Burke.	40,349
Vehicle. Amédé Houle.	38,330	Wash boiler. Alonzo F. Kempton.	38,601
Vehicle. Henry Seeman.	40,357	Wash stand. Nathan O. Bond, et al.	39,634
Vehicle. William E. Stevens.	40,182	Washer: see Clothes washer.	
Vehicle. William Farguhar.	38,073	Washer for vehicle wheels. Ambrose W. Woodward.	40,944
Vehicle axle. James Lewis.	40,950	Washing boiler. Susan A. Mackie.	39,216
Vehicle box. Daniel R. Couch.	40,413	Washing machine. A. Leroy Burke.	38,788
Vehicle cleaning device. John H. Cook.	40,006	Washing machine. Alonzo A. Casler.	38,231
Vehicle gear. Thomas R. Capwell, et al.	40,562	Washing machine. Benjamin Brobst.	40,148
Vehicle jack. John Bell.	41,232	Washing machine. Charles F. Lane.	41,013
Vehicle motor. William H. Thompson, et al.	38,792	Washing machine. Calvin Flanders.	38,529

Washing machine. Elizabeth L. Malce	39,522	Window blind. Andrew J. Avery	40,871
Washing machine. Elzéar Doré	38,965	Window blind. Harvey Murdock	41,068
Washing machine. François X. Thérien	38,544	Window fastener. James Gaffield, et al.	38,901
Washing machine. George W. Smith	39,844	Window jack. Douglas A. Thurston	38,369
Washing machine. Hercule Fauteux	40,063	Window or door screen. Charles J. Shirreff	40,478
Washing machine. Homer K. Williams	40,929	Window sash. Stina C. Young	39,068
Washing machine. James H. Taylor	40,342	Window screen. Alexander McKerlie	38,474
Washing machine. John Dowling, et al.	38,195	Window seat. William Engler	41,337
Washing machine. John H. Carriger	39,437	Window shutter. Henry Raith	39,070
Washing machine. John Kinleyside, et al.	38,884	Wine. Process and apparatus for producing sparkling.	
Washing machine. John Vandyke	38,503	Alexander Bruns	39,683
Washing machine. Leonard Stapleton	38,366	Wiping rod. Henry C. Patterson, et al.	38,725
Washing machine. L. Emilien Biscornet, et al.	38,496	Wire: see Barbed wire	
Washing machine. Richard Nash, et al.	39,640	Wire. Théodore Guillaume	40,337
Washing machine. Thomas McCrossan	38,103	Wire. Apparatus for making. Alphonse E. Tavernier, et al.	39,729
Washing machine. William Champion	38,029	Wire. Apparatus for treating. Will Linton Hayes, et al.	39,011
Washing machine. William L. Dearth	38,716	Wire cleat. Robert Gorton	38,453
Waste-end conveyor for carding machines. Benjamin J. Craggy, et al.	40,620	Wire fence. Isaac K. Hollinger	38,217
Watch case. François Borgel	41,179	Wire fence rail. Othneil Preston	41,397
Watches: see Repeating mechanism for watches.		Wire fence strands. Machine for manufacturing. Edgar F. Hathaway	39,241
Water and oil. Process of producing ozone. Carl F. W. Stelzer, et al.	38,407	Wire for electrical insulation. Herman H. Brown	39,320
Water elevator and purifier. David J. Burkholder	38,891	Wire lacing hook. Harry B. Baker	40,678
Water engine. Henry Jerger	38,331	Wire. Machine for covering. John Scott, et al.	39,750
Water falls. Method of and apparatus for utilizing the force of. Mamian Hamilton	39,926	Wire. Method of manufacturing barbed. John D. Curtis	38,714
Water feed regulator and low water alarm. James Murrie	39,797	Wire. Method of producing seamless compound. Levi L. Burdon	40,050
Water heater. Edwin Rund	40,642	Wire nail machine. George W. McKim	38,906
Water heater. George Lloyd	38,730	Wire plating machine. Othneil Preston	40,665
Water heater. John Duncan Moutat	38,126	Wire strands. Mechanism for forming. George P. Rishell	38,203
Water indicator for boilers. William H. Rodgers	41,208	Wire fences. Machine for weaving. Haggart S. and Grace Cochrane	39,328
Water jet condenser. Ernest Korting	38,206	Wood and iron imbedded in the earth. Method of preserving. Robert A. Chesebrough	41,428
Water motor. Albert W. Brash	38,865	Wood distilling apparatus. Charles J. T. Burcey	40,500
Water motor. James G. Kerr	38,829	Wood. Machine for bending and embossing. Bernhard Ludwig	39,890
Water motor. John H. Hagerty	39,574	Wood. Method of drying and vulcanizing. Charles Howard	38,238
Water motor wheel. Samuel Wade	38,255	Wood. Process of preserving. Paul Grassen	41,270
Water regulator for boilers. William M. Copeland, et al.	39,833	Wood screws and method of making the same. Horace K. Jones	40,011
Water trough for horses and cattle. William Fraser	38,624	Wood surfaces, &c. Method of finishing. Victor Victorson	39,243
Water wheels, &c. Method of constructing arms for. John Williamson	41,054	Wood trimming machine. Charles Meracher	41,213
Weather strip. Harvey W. Ogg	38,336	Wood working machine. Stephen Hurteau	41,405
Weather strip for the bottom of doors. William Beers	38,121	Wooden shovel. James Henry Still	38,047
Weed extermiator. Warren Vreeland	40,707	Wood and other fibrous substances. Method of, and apparatus for treating. Isaac Smith, et al.	38,677
Weighing apparatus for vehicles. Charles B. Wanamaker, et al.	38,431	Wool carding machines. Attachment for. James Harley	41,199
Weighing machine. Frederick J. Lancaster, et al.	39,804	Work holder and safety guard for wood cutting and similar machines. John C. Thom, et al.	40,514
Weighing machine. John Jackson, et al.	40,497	Worker: see Butter worker	
Weighing machine. Luther C. Farmer, et al.	41,058	Wort. Method of producing clear. Fleischmann & Co.	38,900
Weighing scales, recorder and register. Robert McFarlane, et al.	41,152	Woven fabric. John Hilton, et al.	38,859
Weighing travelling loads. Machine for. Alexander E. Brown	38,466	Woven fabric. William Talbot	40,881
Weight: see Toe weight.		Woven fabric. Machinery for preparing and dyeing. Arthur T. Clay	40,923
Welding: see Electric welding. Heating and welding.		Woven fabric. Method of and apparatus for making. William Talbot	40,880
Welding rings by electricity. Method of. Hermann Lemp, et al.	38,078	Wrapper for butter. Frederick Cudney	38,811
Welding rings. Electrical apparatus for. Hermann Lemp, et al.	38,080	Wrecking machine and stump extractor. John Cornelius, et al.	40,465
Wets to uppers. Machine for sewing. Andrew Eppler	40,292	Wrench: see Pipe wrench	
Wheel: see Axle attachment for carriage wheels. Car wheel. Cogged wheel. Cushioned wheel. Paddle wheel. Polishing wheel. Vehicle wheel. Water motor wheel.		Wrench. Albert K. Lonell	39,848
Wheel. Franklin Pierce Circle, et al.	39,013	Wrench. Alexander E. Gundlack, et al.	36,605
Wheel. James Stothers	40,551	Wrench. Braxton B. Lowe	40,227
Wheel. Marcus W. Lowinsky	40,690	Wrench. Campbell A. McIntosh	40,796
Wheel. William Sheridan	38,712	Wrench. Daniel H. Carpenter	38,340
Wheel for cars. Josiah A. Webber	39,775	Wrench. Daniel R. Porter, et al.	41,437
Wheel for road vehicles. Harry Moore	40,090	Wrench. Henry D. Fisk, et al.	39,201
Wheel for the propulsion of vessels. Thomas Dunlap	38,649	Wrench. Silvanus Hussey	38,492
Wheel for vehicles. Harry J. Swindley	39,660	Wrench. Thomas Sherk	39,259
Wheel for water and wind. Narcisse Duval, et al.	38,143	Wrench. William Forgie	41,194
Wheel on its axle. Device for holding a. Oscar Jacob, et al.	39,631	Wrench. William F. Custer	39,297
Wheels. Machinery for operating jerker. John McKee, et al.	41,373	Wrench and cutter for pipes. George W. Gorsuch, et al.	39,064
Whiffletree. John H. Irion	39,451	Wrench for pipes. George McKercher, et al.	39,272
Whiffletree. Nicholas N. VanPelt	38,252	Wrench for pipes and nuts. Henry Bornstein	40,508
Whiffletree. William Lohr	40,378	Wringer for mops. Arthur McCausland Burnham, et al.	38,611
Whiffletree and neck yoke. John Connolly	38,175	Wringer for mops. Cassius A. White, et al.	40,197
Whip socket support. Alexander E. Tullock	40,611	Wringer for mops. William Graham, et al.	40,698
Whisk holder. John F. O'Brien	39,033	Wrist turning machine. Octave Morel	40,754
Whist. Apparatus for playing duplicate. Cassius M. Paine, et al.	38,399	Yarn. Machine for scouring and dyeing. William Blackburn, et al.	40,067
Wick raisers for central draft lanps. William M. Hoerle	39,894	Yarn. Process of and apparatus for drying and steaming dyed cotton. Carl Schunrch	40,019
Winch. Franz Uhlig	39,923	Yarns and fabrics. Treatment of vegetable textile fabrics for the manufacture of. Max Raabe	38,072
Winch for ship masts. Franz Uhlig	40,043	Yeast. Process of making and preserving pure. Gaston Guignard	40,493
Winder for main springs. Alden R. Vaughan	38,092	Zein. Process of extracting. Thomas B. Osborne	40,322
Windmill. Joseph McKnight	38,931	Zinc. Art of producing metallic. Parker C. Choate	41,100
Windmill. Milo J. Althouse	40,105		
Window. Annie F. M. Youlton	40,959		
Window. François V. Greene, et al.	39,053		

INDEX OF PATENTEES.

Abbee, Henry C. Lathe	40,054	American Screw Co. Die for cutting off and pointing pieces of wire	38,321
Abbey, Hartwell, et al. Embossing and ornamenting machine	39,431	American Screw Company. Screw eye	38,147
Abbott, Albert R. Machine for perforating documents or checks	38,676	Ames, Chester L. Car brake	40,180
Abbott, John. Apparatus for loading and unloading vessels	40,444	Ames, Franklin. Apparatus for sewing carpets	39,379
Abbott, Levi, et al. Means for operating lock hinges	38,543	Amick, Myron J. Regulator for gas	38,290
Abbott, Warren M., et al. Apparatus for burning liquid fuel	40,353	Amstutz, Noah S. Process of, and apparatus for electrically reproducing uneven surfaces	41,438
Abbott, Warren M., et al. Burner for vapour	40,140	Anderson, Richard C. Cooking vessel	39,921
Abell, John. Cut off engine	40,147	Anderson, David, et al. Spark arrester and smoke consumer	39,992
Abell, John. Threshing machine	39,375	Anderson, Gilbert R. Flue for fire places	40,393
Abrahamson, Peter. Ventilator	39,178	Anderson, Hans J. Band and circular saw-mill	39,873
Acheson, Edward G. Calelectric generator	40,165	Anderson, Hans J., et al. Butter worker	38,303
Acme Liquid Fuel Company. Process of and apparatus for making gas	40,810	Anderson, Harry N. Cigar blank	40,808
Adair, John. Dough mixing machine	40,684	Anderson, Isaac, et al. Pilot for cars	40,931
Adair, John. Oven and tray therefor	40,607	Anderson, James D., et al. Tyre set	39,370
Adair Syndicate. Dough mixing machine	40,684	Anderson, Richard W., et al. Apple picker	41,257
Adair Syndicate. Oven and tray therefor	40,607	Anderson, Stephen. Night light and time indicator	41,038
Adam Manufacturing Company. Plaster	39,258	Anderson, Thomas. Sound alphabet	40,674
Adams, Horatio, et al. Joint for rotary pipes	40,221	Anderson, Wm. N. Elevator door	38,911
Adams, James Ansley. Motor	38,920	André, Frederick. Disinfecting apparatus	39,672
Adams, John. Money changer	41,253	André, Thomas J. Fence tightener	39,079
Adams, Robert. Door closing appliance and check for same	40,316	Andrews, George. Animal trap	39,036, 41,345
Adams, Robert. Spring and check for doors	40,942	Andrews, Wallace C. Method of making gas	39,760, 39,761
Adams, Walter S., et al. Brake mechanism	40,906	Andrews, Wallace C. Method of transportation	38,719
Adjustable Metallic Lug Co. Thill tug	41,167	Andrews, Walter Y., et al. Cutter for ensilage	39,062
Adler, Friedrich. Brake for tramways	39,675	Andrews, William S., et al. Electro-heating apparatus	39,730
Acme Harvester Company. Ricker for hay	40,466	Andrews, Duane P. Electro-galvanic belt	38,987
Acme Heel Trimmer Co. Heel trimming machine	40,135	Angell, Eugene H. Cutter for railroad rails	40,421
Agar, Albert A., et al. Cant Hook Band	38,890	Ansboro, Thomas, et al. Kite	39,196
Agricola, William H., et al. Electric block signal system	41,110	Ansler, Carl, et al. Regulation hot blast stove	41,382
Ahearn, Thomas. Electric flat iron	39,917	Ansler, Frank and George W. Pail and strainer for milk	39,456
Ahearn, Thomas. Electric heater	39,506	Anthistle, Wm. John. Coffin case	38,845
Ahearn, Thomas. Electric oven	39,916	Anthistle, William J. Coffin shell mould	39,042
Ahearn, Thomas. Electric warming bottle	39,915	Anthony, Jesse, et al. Bicycle	40,554
Ahearn, Thomas. Electric water heater	38,976	Anthony, Mark. Faucet for barrels	38,940
Ahearn, Thomas. Method of Heating an automatic water supply electrically	39,508	Apple, Charles Spicer. Sash fastener	38,770
Ahearn, Thomas. System of warming cars by means of electrically heated water	39,507	Archibald, William W. Clamp for moulders' flasks	40,251
Ahl, Carl A. R., et al. Horse collar	40,669	Armitage, Edwin, et al. Painting machine	38,077
Ahrens, Charles H., et al. Letter or bill file	41,441	Armstrong, George E. Composition for the treatment of fibre, yarns, &c	41,222
Aikens, Frederick, T. Cleaner for mucilage brushes	41,155	Armstrong, John A. Oven and oven door	38,482
Aitchison, Alexander W. Horse wagon, chemical engine, and hose reel, combined	39,450	Armstrong, John B., et al. Shifting seat for vehicles	40,634
Aitkens, Clement, et al. Barrel	41,047	Armstrong, John B. Road cart	40,410
Allany Horse Nail Company. Machine for forging horse-shoe nails	41,355	Armstrong Manufacturing Company. Vice	38,200
Albert, Albert Pierre, et al. Nut lock	39,157	Arnold, Horace L., et al. Bookbinders' machine	41,002
Alden, Horace A., et al. Horse hay rake	39,167	Arnold, Leonard G. Car brake and bumper	39,534
Alden, Oliver R. Bit stock	41,223	Arnold, Oscar M., et al. Tenderer for meat	40,507
Alderman, Olinthus, G. Spring fastener	38,497	Arnot, Arthur J., et al. Alternate electric current motor	38,458
Alexander, Thomson H. Multiplex stamping machine	38,541	Ashbaugh, William F., et al. Wringer for mops	40,698
Allan, William A. Clothes drier	39,422	Ashby, Delmar E. Fruit jar	38,428
Allen, Alfred J. Car coupler	38,769	Ashmead, Seely W., et al. Anti-friction bearing	39,702
Allen, Hugh, et al. Bill file	40,300	Atkinson, Frederick B. Car door fastener	39,060
Allen, Jay W., et al. Holder and cutter for roll paper	39,205	Atkinson, William. Spring for vehicles	38,032
Allen, Joseph, et al. Door bell	40,404	Atwater, Henry W. Freezer for ice cream	39,602
Allen, J. W., et al. Chopping knife	41,225	Atwood Electric Company. Arc Lamp	39,861
Allen, J. W., et al. Pipe wrench	41,224	Atwood, George F. Stopper for bottles	40,038
Allen, Oswald J. Method of packing cheese	39,483	Atwood, LaMotte C. Arc lamp	39,860, 39,861
Allen, Samuel N., et al. Compensator for signal rods	39,582	Atwood, LaMotte C. Magneto-electric machine	40,501
Allen, Thomas Henry. Propelling power	38,177	Aubertin, Nicholas A., et al. Mechanism for driving machines by foot power	41,089
Alley, Stephen, et al. Apparatus for making moulds for castings	38,427	Audsley, George A. and Maurice A., et al. Machine for colouring and ornamenting india rubber balls	40,890
Allingham, James. Heater for street cars	40,716	Austin, William Edward. Drier for clothes	38,135
Allis, (Edward P.) Company. Collector for dust	39,629	Austin, William J. Tip for vehicle poles	38,300
Allis, John. Apparatus for watering cattle and stock	38,207	Austin, William Laurence. Smelting process	39,007
Almy, Darwin. Steam generator	40,775	Automatic Interchangeable Car Coupling Company. Car coupler	39,158
Alpe, Robert. Machine for manufacturing metal spokes	39,681	Avery, Andrew J. Window blind	40,871
Alpert, Wilhelm. Threshing machine	40,191	Avery, John T. Lasting machine	39,859
Altman, Charles, et al. Sash lock	38,249	Avery, Philander. Stanchion	40,793
Althouse, Milo J. Car coupler	38,818	Avery, William G. Stock car	40,499
Althouse, Milo J. Wind mill	40,105	Avis, Walter H. Sash cord machine	38,733
Althouse, Milo J., et al. Car coupler	38,548	Axtell, Walter M. Crossing for railways	39,886
Altmann, Julius, et al. Nut shearing and punching machine	41,230	Ayer, George A. Boiler and furnace	39,723
Alzugaray, Jose B. Furnace and apparatus for extracting metals from ores	39,591	Ayers, Henry Clay, et al. Tool grinding machine	38,498
Ambler, William S., et al. Incandescent electric lamp	40,095	Aylsworth, George M. Buckle	41,388
American Button Fastener Co. Button setting machine	41,072	Azcan-Y-Meana, Sebastian. Means for preventing fraud in the sale of cigars	38,111
American Graphophone Co. Graphophone	40,194	Bachelor, Alfred, M. et al. Sharpener for lawn mowers	38,499
American Mechanical Construction Co. Coupler for vehicles	38,430	Bacon, Benjamin J. Tapping cock and valve	41,193
		Bacon, Henry S. Index	41,237
		Bacon, John W. Shingle gage	41,118
		Badlam, Edgar B. Air supplying device for gas machines	41,254
		Baer, John D., et al. Car coupler	38,782
		Baggaley, Henry. Method of manufacturing tiles, porcelain, earthenware, &c	38,285
		Bailey, John W., et al. Method of and apparatus for producing lead carbonate	41,221
		Bailey, Joseph R., et al. Arm rest for telephones	40,991
		Bailey, Seldon A. Store service apparatus	38,251
		Baillie, Henry, et al. Cant hook band	38,890

Bain, James D. Brick machine.....	39,503	Beals, Joseph J., et al. Car brake.....	38,386
Baird, Archibald and Matthew B., et al. Apparatus for burning oil.....	39,584	Beardsley, Frank E. Cutter for axles and threads.....	40,111
Baker, Ambrose S., et al. Brick.....	39,989	Beardsley, J. S., et al. Nut lock.....	39,121
Baker, Charles F., et al. Cove.....	38,270	Beath, John G., et al. Sharpener for lawn mowers.....	38,499
Baker, Charles F., et al. Composition for building purposes.....	38,723	Beatty, Herbert A., et al. Device for holding a wheel on its axle.....	39,631
Baker, Clark. Saw set.....	40,328	Beaudet, Leo C. Household altar for sacramental purposes.....	38,479
Baker, Frank L. Machine for making paper bags.....	41,045	Beaupré, Rémi. Stretcher for wire.....	39,137
Baker, Harry B. Wire lacing hook.....	40,678	Beausejour, Urgel. Car coupler.....	39,933
Baker, James Day. Plaster board.....	38,939	Beck, Benjamin. Axe.....	38,868
Baker, James H., et al. Process of and apparatus for making gas.....	40,810	Beck, Robert McCandless. Steam engine.....	40,326
Baker, James E. Paper box.....	40,848	Beckett, Frederick G. Life preserver.....	38,994
Baker, John A., et al. Rotary plow.....	39,255	Beecham, Thomas. Paper.....	39,716
Baker, Volney C. Tea Kettle.....	40,879	Beecher, Ebenezer B., et al. Ammunition belt.....	40,275
Baldensperger, Philippe. Self re-ascending motor.....	40,089	Beecher, Ebenezer B., et al. Gun.....	40,276
Baldwin, A. Van Nest, et al. Calk for horse-shoes.....	38,951	Beekman, John C. Bowl for water closets.....	39,971
Baldwin, Frank R. Loader for cartridges.....	40,223	Beeman, Marcus M. Velveteen binding.....	38,913
Baldwin, George R. Gear for electric railway cars.....	40,442	Beers, Ira F. and Frederick C. Draft regulator.....	38,646
Baldwin, James S. Traction motor.....	40,984	Beers, William. Weather strip for doors.....	38,121
Baldwin, Orrin R. Harrow.....	40,824	Bery, Samuel M. Holder for air brake hose.....	38,378
Ball, Frank H. Governor for steam engines.....	39,218	Beery Valve Company. Holder for air brake hose.....	38,378
Ball, John Edward. Threshing machine.....	38,882	Beilby, George T. Process of and apparatus for manufacturing cyanides.....	38,801
Ball, Thomas, et al. Resilient frame for mats and rugs.....	39,219	Beilby, James H., et al. Typewriter.....	39,152
Ballard, Charles, et al. Process of treating metalliferous ores.....	40,453	Belanger, Theodore. Wheel for water and wind.....	38,143
Ballou, Hiram P. Knitting machine.....	39,809	Belden, Howard R., et al. Grinding and amalgamating pan.....	39,961
Baltimore, John, et al. Coupling for hose.....	41,274	Belet, Joseph. Target.....	39,590
Band, Henry F., et al. Fence.....	39,966	Bell, H. Seeley, et al. Car coupler.....	38,244
Bang, Ivar A. F., et al. Method of treating plants.....	40,061	Bell, John. Holder for horses.....	40,119
Bankier, Patrick M., et al. Barrel.....	41,047	Bell, John. Vehicle jack.....	41,232
Bard, William, et al. Nut lock.....	38,613	Bellamy, Charles. Freezer for ice cream.....	39,077
Bardwell, Francis M., et al. Wrench.....	41,437	Belmont, Louis A., et al. Mortising machine.....	40,713
Barger, Robert N. Folding bed, billiard table, rack and settee, combined.....	40,598	Belyea, James C., et al. Velocipede.....	39,836
Baril, Thomas. Car coupler.....	38,278	Bement, Clarence E. Cultivator.....	40,543
Barker, Valentine S., et al. Levelling attachment for harrows.....	38,843	Bemis, Albert T. Truck for lumber kilns.....	39,237
Barnes, Cyrenius S. Desk.....	41,214	Bender, Paul. Method of making boots and shoes.....	39,499
Barnes, G. H., et al. Car coupler.....	40,387	Benfield, Joseph. Horse-shoe.....	41,321
Barnes, Philo M., et al. Desk board.....	40,351	Bennett, Henry. Night light and time indicator.....	41,038
Barney, Earl. Incubator.....	41,385	Bentley, Edward M. Electro-motive force regulator for electric generators and motors.....	39,905
Barnum, Frederick L. Surgical appliance.....	38,697	Bentley, Edward M. Regulator for dynamo electric machines.....	40,242
Barr, Andrew. Step ladder.....	40,548	Bentley, William, et al. Twine holder cup and take up.....	40,867
Barr, Jacob Neff. Machine for trueing circular bodies.....	38,633	Bergen, James V. Fountain attachment for inkstands.....	41,062
Barr, Marshall D., et al. Electric switch.....	39,048	Bergeron, Jasmin P., et al. Duplicating machine.....	40,173
Barraclough, Thomas C. Machinery for rolling and expanding metal tubes.....	39,565	Berkenfeld, Joseph F. Combined ganing and sawing machine.....	39,039
Barraclough, Thomas C. Machinery for shaping, finishing and flanging metal bodies.....	39,566	Berne, Arthur W. Collector for fares.....	40,504
Barrett, Charles A. Dynamometer.....	41,083	Bernhardt, Carl, et al. Excavator.....	39,142
Barrett, Charles A. and Alfred. Muscular power testing machine.....	39,419	Berrenberg, Adolph. Vacuum pump.....	39,997
Barrett, Mora M., et al. Electric ignitor for gas engines.....	38,425	Berry, Albert Warren, et al. Siphon discharge flush tank and analogous apparatus.....	38,179
Barrett, Mora M., et al. Gas engine.....	39,260	Berry, Austin. Boot cleaning apparatus.....	38,291
Barrett, Richard, et al. Permutation lock.....	39,454	Berthold, Hans. Door hinge.....	39,816
Barrows, Albert. Method of, and means for making lasts and patterns therefor.....	41,226	Bertrand, Joseph E., et al. Shoe lacing device.....	40,481
Barry, Henry H., et al. Household utensil.....	38,682	Best, Thomas J., et al. Boiler.....	39,168
Bartels, Charles L. Ironing machine.....	40,850	Bettman, Charles F. Latch for gates.....	40,334
Barter, Benjamin. Flour bolt.....	38,289	Beveridge, Thomas. Woven fabric.....	38,859
Bartholomew, Anson C., et al. Mechanical movement.....	39,791	Bevington, James Hall. Process of spinning and welding metals.....	38,322
Bartholomew, George E. Spring gear for vehicles.....	38,433	Beylikgy, Marc W. Silicate compound.....	41,420
Bartlett, Edward. Mowing machine.....	38,583	Bicheroux, Toussaint. Method of and apparatus for making rails &c.....	40,214
Bartlett, Sarah J. Apparatus for making soap.....	40,605	Bidwell, George A. Joint for pipes.....	38,127
Barton, Josiah C. Apparatus for making rubber stamps.....	40,680	Bieder, Jacob L. Glass catching attachment for lawn mowers.....	39,487
Barton, Richard T. Lampburner.....	39,298	Bierdon, Levi L. Method of producing seamless compound wire.....	40,050
Barton, Robert R. Account book.....	39,442	Bierley, Henry A. Register for cash.....	39,349
Basom, Ransford W. Steam engine.....	38,400	Biernath, Ernest. Insulating and waterproofing material.....	41,104
Bastable Frederick, et al. Machine for treating leaf tobacco.....	38,603	Bigley, Richard. Gas attachment for cooking stoves.....	39,613
Batchelder, James H. Machine for making egg cases.....	39,261	Bigley, Richard. Heater.....	39,617
Batchellor, Clifford H. Compound engine.....	39,414	Billings, Andrew W. Method of making beer.....	41,190
Batchelor, Telford C., et al. Cartridge.....	39,399	Binney, Charles Richard, et al. Gas engine.....	38,933
Batchelor, Telford C., et al. Cartridge case.....	39,839	Bird, Frederick J., et al. Sheep shearing machine.....	40,156
Batchelor, Telford C. Mould filling apparatus.....	39,673	Bird, Richard C., et al. Machine for sizing and painting cloth.....	39,762
Bates, Frank L. Smoke consumer.....	40,355	Birkenshaw, William K., et al. Pick.....	39,212
Bates, George E., et al. Adding machine.....	39,276	Birkery, Cornelius. Valve.....	39,710
Batters, Edward. Receiver for milk.....	38,136	Birkery Manufacturing Co. Valve.....	39,710
Battersby, Arthur J. Bicycle, &c.....	41,259	Birley, Frank P. Machine for manufacturing paper boxes.....	39,368
Battle, Joseph, et al. Handle for caskets.....	39,789	Biscoe, Henry L., et al. Rotary plough.....	39,255
Batty, Lewis A. Thill coupler.....	40,041	Biscornet, L. Emilien. Washing machine.....	38,496
Batty, Thomas. Gas stove.....	41,404	Bishop, Abner B. Fifth wheel.....	39,311
Battye, Rhodes. Brake.....	41,269	Bishop, Charles, et al. Shaft support and anti-rattler.....	38,055
Bauer, Albert W., and Edward H. Thill coupling.....	39,455	Bishop, John Le Marchant. Method of ventilating rooms.....	38,823
Bausman, Adam C. Bookbinding.....	39,518	Bishop, Robert H., et al. Receptacle for coins.....	39,369
Bavier, Charles S. Compression joint.....	39,028	Bissell, Thomas A. Vestibule hood for cars.....	38,481
Bayless, William. Honey extractor.....	41,234	Black, Frank X. Mold for closed cylinders.....	40,846
Bazer, Henry, et al. Mechanism for actuating interlocking gear for railway switches and signals.....	40,464	Black, John, et al. Tea kettle.....	39,620
Beach, Ralph H. Arc lamp.....	40,625	Black, John William. Speaking tube.....	38,880
Beach, Vertot D. Car truck.....	39,395	Blackburn, William, et al. Machine for scouring and dyeing yarn.....	40,067

Blackford, Ethelbert O., et al. Cart saddle.....	40,454	Bradley, Stephen R. Electrical surgical instruments.....	41,020
Blackman, George L. and Frank S. Thill coupling.....	39,384	Bradshaw, Edwin. Driving attachments for bicycles.....	40,664
Blackman, Henry. Art of recovering refractory substances from solutions.....	40,646	Bradshaw, James M., et al. Separator.....	39,465
Blackman, Henry. Furnace for evaporating and calcining alkaline solutions, &c.....	40,647	Brady, William H. Signal lamp.....	39,145
Blackshaw, Joseph E., et al. Adding machine.....	38,089	Brain, Carl T. B. Power conduit for railways.....	40,588
Blackstock, George T., et al. Car coupler.....	38,548	Brain, William B., et al. Alternating electric current motor.....	38,458
Blackstone, Edward C. Swath turner.....	40,121	Bramley, William, et al. Thimble.....	41,097
Blackwell, Francis O. Controlling device for electric motors.....	39,780	Brandon, Charles T., et al. Bearing for pulleys.....	40,256
Blackwell, Kenneth W., et al. Cattle guard.....	38,387	Brandt, Carl. Stove and furnace.....	40,902
Blackwell, Kenneth W., et al. Device for securing guard rails in place.....	38,046	Brash, Albert W. Water motor.....	38,865
Blair Camera Company. Camera.....	40,198	Brav, Hugo. Lock for tills.....	39,654
Blair, Thomas H., et al. Camera.....	40,198	Bray, Morris Plant. Dress stay.....	38,800
Blaisdell, Frederick E. Pencil.....	38,338	Bray, Ralph E., et al. Machine for scouring and dyeing yarn.....	40,067
Blake, Alfred J. Calk for horse-shoes.....	39,781	Brayton, George B. Hydro carbon engine.....	40,363
Blake, Richard P. Barrel.....	38,450	Bredannaz, Louis. Picker stick.....	38,881
Blake, Robie. Hammer and nail puller.....	40,216	Breen, Thomas William. Gardening implement.....	38,941
Blanchard, Edward R., et al. Oscillating engine.....	38,326	Breiger, G. C. W. Method of manufacturing badges.....	39,664
Blanchard, Horace. Scrubbing brush.....	41,136	Bremner, Ann. Medicinal compound.....	40,841
Blankart, John. Sleigh runner for vehicles.....	38,115	Bremner, William. Pavement, flooring, &c.....	39,084
Blanks, George W., et al. Sheep shearing machine.....	40,156	Brent, Charles. Ore concentrator.....	40,441
Blickensderfer, George C. Type writer.....	40,933, 40,934, 40,997	Brewer, Gilbert F. Hot water attachment for stoves.....	41,210
Blickensderfer Manufacturing Co. Type writer.....	40,933, 40,997, 40,998	Brewer, William J. Anti-friction bearings for vehicles.....	38,744
Bliscoe, Aloysius G. File.....	39,378	Brewing Improvement Company. Method of treating hops.....	40,629
Bloomburg, Martin W. Fastener for stove pipes.....	40,711	Brice, Roseman E., et al. Tyre heater.....	40,395
Bodfish, William H. Metallic packing.....	40,681	Bricker, Moses, et al. Saw set.....	38,348
Boeckh, Charles. Bridle for paint brushes.....	38,819	Bridges, John R. Circular knitting machine.....	38,150
Boeckh, Emil C. Transfer ticket.....	41,182	Brier, Paul T. Ointment.....	39,116
Boggs, Joseph O. Sweeper.....	40,352	Briggs, George W. Tourney bridle.....	40,487
Boggs, Nathan G., et al. Brake mechanism for cornices and eavetroughs.....	40,555	Briggs, Henry. Rough rounding and channelling machine.....	39,925
Bohannan, Jenetta V. Cigarette machine.....	40,085	Briggs, Ira J., et al. Lubricating cup.....	40,745
Bohlig, Martin. Hobby horse.....	39,572	Briggs, Joseph M. Cutter for sausage meat.....	40,648
Bohls Cigarette Machine Co. Cigarette machine.....	39,532	Bright, Fred E. Typograph.....	40,327
Bohls, Henry. Cigarette machine.....	39,532	Brill, George M. Car truck.....	38,877, 40,827
Boice, John W. Protector from smoke, cinders, cold air and water.....	40,952	Brill, George M. Car truck for electric motors.....	40,618, 40,622
Boileau, Etienne. Grate bar.....	38,419	Brill, George M. Motor truck for cars.....	40,623
Bolt, Charles. Bar for watch chains.....	40,267	Brill, John A., et al. Brake mechanism.....	40,906
Bond, James. Drier.....	40,947	Brill, John A. Car truck.....	38,873
Bond, Nathan O., et al. Wash stand.....	39,634	Brill, John A. Cars for railways.....	38,876
Boniface, George, et al. Compensator for signal rods.....	39,582	Brill, John A., et al. Car truck for railways.....	38,877
Bonnaffon, Albert L. Fence.....	39,826	Brill, John A. Street car.....	38,878
Bonner, Alfred, et al. Hub boring machine.....	40,046	Brill, John A. Truck for motors.....	40,978
Bonwick, William P. Stopper for bottles, &c.....	39,428	Brintnell, Archibald H. Annunciator.....	39,081
Booher, Everett L. Bending machinery.....	39,849	Brintnell, Archibald H. Electric car.....	41,016
Boone, Samuel H., et al. Machine for holding reels.....	40,697	Brintnell, Archibald H. Thermostat.....	39,080
Boore, Lewis and Lewis A., et al. Regulator or governor for gas.....	38,188	Brittingham, William B. Detergent.....	39,906
Booril Limited, et al. Nutritive compound.....	38,740	Broadbent, Eli William. Sewing machine.....	39,015
Booth, George. Bath tub.....	38,668	Broadfoot, Peter M. Scraper.....	41,217
Booth, George. Bath tub.....	41,422	Broadly, Joseph. Nut lock.....	38,402
Borgel, Francois. Watch case.....	41,179	Broadnax, Francis. Electric switch.....	39,787
Borland, Edward. Skeleton wagon and sulkey thill.....	39,016	Brobst, Benjamin. Washing machine.....	40,148
Born, Henry. Box bending machine.....	40,736	Brock, Levi Meredith. Tramway.....	38,489
Bornstein, Henry. Wrench for pipes and nuts.....	40,508	Brochu, Michael. Lathe.....	39,887
Bostwick, Walter W. Machine for producing metal lathing.....	38,356	Brockway, William L. Method of treating waste tinned steel or iron.....	38,178
Bougourd de Lamarre, Charles, et al. Method of making illuminating gas.....	39,063	Brooke, Robert G. Injector.....	39,496
Bouillon, Alfred. Medicinal compound.....	39,045	Brooks, Mott Billings. Force pump.....	38,184
Bourassa, Pierre E. Joint holder.....	38,495	Brooks, Thomas. Cooking stove and house heater.....	39,343
Bourne, George, et al. Metal tube.....	39,560	Brooks, Thomas. Furnace for hot water.....	39,171
Bouton, DeWitt C. Device for propelling vehicles.....	40,710	Bronson, Courtland W., et al. Process of purifying liquids.....	41,273
Bouvier, Louis P., et al. Envelope machine.....	41,151	Brophy, Jessie McLaren. Cabinet for bakers.....	38,317
Bower, John. Fish way.....	40,020	Brosius, Samuel Grenville. Rotary engine.....	39,023
Bowers, William H. H., et al. Concentrator for ores.....	38,806	Brosman, Cornelius J. Lock for bicycles.....	38,342
Bowler, Giles, et al. Brake.....	39,452	Brosseau, Vincent. Process of stuffing and finishing leather.....	39,581
Bowler, Giles, et al. Floor jack.....	38,776	Browett, Thomas, et al. Liquid hydro carbon motor engine.....	39,479
Bowman, Robert D. Process of and apparatus for producing oxygen gas.....	40,804	Brown, Alexander E. Bucket for conveyors.....	39,299, 39,290
Bowser, Augustus, et al. Siphon.....	38,215	Brown, Alexander E. Clutch.....	39,288, 39,291
Bowser, Sylvanus, et al. Siphon.....	38,215	Brown, Alexander E. Drilling tool.....	38,469, 38,470
Bowslough, Arthur J. Spool holder and needle cushion.....	38,099	Brown, Alexander E. Filler for blast furnaces.....	39,287
Boyd, Charles U. Railway frog.....	38,666	Brown, Alexander E. Grab bucket.....	38,471
Boyd, Samuel M. Method of desulpherizing oils.....	41,194	Brown, Alexander E. Hoisting and conveying machine.....	38,467, 38,468
Boyle, Richard. Bridge.....	38,621	Brown, Alexander E. Machine for weighing travelling loads.....	38,465, 38,466
Boynton, Newell M. Organ stop action.....	38,229	Brown, Alexander E. Means for translating power.....	39,292
Brachkansen, Gustav A., et al. Damping device for mechanical musical boxes.....	41,009	Brown, Charles H. Device for raising sunken vessels.....	40,021
Bradbury, F. C., et al. Lock.....	39,017	Brown, David W. Art of obliterating sound records from record tablets.....	40,179
Bradbury, James O., et al. Lock.....	39,017	Brown Dillon S. Thill coupler.....	38,483
Bradford, Horace C. Tapping and pipe threading machine.....	40,253	Brown, Flora L. H. Ore concentrator.....	39,965
Bradley, Alfred, et al. Burner for crude oil.....	38,084	Brown, Francis R., et al. Car coupler.....	40,744
Bradley, Gilbert W. Art of making cylindrical boxes from thin scale board or veneer.....	39,614	Brown, Herman H. Wire for electrical insulation.....	39,320
Bradley, James. Bicycle.....	41,046	Brown, Horace F. Furnace for roasting ore.....	39,955
Bradley, John. Knitting machine.....	40,619	Brown, James A., et al. Level tube for surveying instruments.....	40,862
		Brown, James Hoyt. Car coupler.....	38,389
		Brown, John A., et al. Pump.....	41,191
		Brown, John M., et al. Brake machine for cornices and eavetroughs.....	40,555
		Brown, Lewis A., et al. Electric elevated railway.....	41,424
		Brown, Samuel H., et al. Process of annealing metals.....	38,517
		Brown, Samuel S., et al. Mining machine.....	39,387
		Brown, Thomas. Combustion mechanism.....	38,123

Brown, Thomas, et al. Window fastener.....	38,901	Cammiss, Edward. Brick.....	39,252
Brown, Thomas P. Clip for window blinds.....	40,855	Camp, David C. Ice cream freezer.....	41,288
Brown, William Z., et al. Blind for windows.....	40,354	Campbell, Alexander. Car brake.....	40,905
Browning, Charles E. Fountain pen.....	40,741	Campbell, George, et al. Pulley.....	38,955
Browning, Lewis S. Dumping wagon.....	40,565	Campbell, Joseph H. Ammonia engine and apparatus connected therewith.....	38,408
Browning, Lewis S. Fifth wheel for vehicles.....	41,007	Campbell, Martin, et al. Work holder and safety guard for wood cutting and similar machines.....	40,514
Brownlow, John H., et al. Truss.....	38,579	Campbell, Ralph S., et al. Electric dynamo and motor.....	38,588
Bruce, Robert. Hatter.....	40,359	Campbell, Septimus Robert, et al. Pulley.....	38,955
Bruno, Nordberg Co. Valve gear.....	40,204	Campbell, William, et al. Case for eggs.....	39,204
Bruno, Alexander. Process and apparatus for producing sparkling wine.....	39,683	Campbell and Zell Company. Steam boiler.....	38,807
Brunthaver, Charles E., et al. Holder for copy.....	40,152	Camvin, John W., et al. Toy bank advertising device.....	41,128
Bryant, Edward E., et al. Car coupler.....	40,387	Canadian Rand Drill Company. Drill chuck.....	38,906
Bryant Electric Co. Incandescent lamp socket.....	38,539	Canadian Rand Drill Company. Pneumatic pump.....	40,398
Bryant, George. Boot & shoe.....	40,062	Canadian Rand Drill Company. Valve for pumps.....	39,401
Bryant, Walde C. Incandescent lamp socket.....	38,539	Canadian Copper Company. Method of treating matts.....	40,053
Bryant, William, et al. Mouth piece for speaking tubes.....	38,802	Canadian Switch Manufacturing Co. Frog for railway rails.....	41,306
Buchan, Ewing. Bottle measure.....	39,312	Canda, Ferdinand E. Cattle car.....	41,240, 41,250
Buchan, Ewing. Fountain flower holder.....	38,485	Candler, William L. Art of and means for recovering and amalgamating metals.....	39,958
Buchanan, James. Elevator for straw.....	41,021	Candler, William L. Furnace for roasting ore.....	39,959
Buchanan, James. Threshing machine.....	41,032	Canfield, James H., et al. Steam generator.....	39,577
Buchanan, Luther H. Arc lamp.....	41,241	Cannon, Clinton, Coradon S., Alexander and Florence. Mould for metallic wheels.....	38,549
Bucher, Frank, et al. Churn.....	38,054	Cannon, William G. Radiator.....	39,998
Buck, Taylor S. Stamp.....	38,692	Cant, Bros. Co. Pulley.....	40,401
Buckingham, James R. Check controlled lock.....	40,211	Canten, Layton, et al. Cut off valve for steam engines.....	39,385
Bucklin, John E., et al. Horse-shoe machine.....	41,375	Capitol Manufacturing Company. Nut tapping machine.....	41,048
Buere, Louis, et al. Coupling for rods.....	41,320	Capwell, Thomas R., et al. Vehicle gear.....	40,562
Buford, Paschal. Tea chest.....	38,618	Card, William Legrand. Concentrator.....	39,156
Bullard, Josephine H. Guard ring.....	38,490	Cary, Augustus C. Method of applying carbon filaments to electric lamps.....	38,679
Bullock, John F. Paper rack for telephones.....	41,161	Carey, William. Diving dress.....	40,449
Bullock, John F. Vest shield.....	41,197	Carey, William. Pipe coupling.....	40,323
Bullock, Lathrop L., et al. Surface printing plate.....	40,346	Cary, Spencer C. Strap and hoop for boxes and packages.....	39,857
Bundy, Jesse E. Miter box.....	40,758	Carlin, Charles C., et al. Wash stand.....	39,634
Bunker, Harman, et al. Anti rattler for thill coupling.....	39,367	Carman, Albert, et al. Sad iron.....	40,137
Bunker, Harman, et al. Car coupler.....	38,548	Carmody, Martin. Clissors for button-holes.....	38,915
Bunker, Harman, et al. Clutch connection.....	39,051	Caron, Arrestide. Clothes line.....	38,480
Bunker, Harman, et al. Dray for sleighs.....	39,366	Carpenter, Charles E. Electric soldering iron.....	40,245
Bunsen, William M., et al. Blow gun.....	40,059	Carpenter, Charles E., et al. Electro-heating apparatus.....	39,730
Burcey, Charles J. F. Wood distilling apparatus.....	40,500	Carpenter, Daniel H. Wrench.....	38,340
Burdick, Justin H. Method of making nuts.....	40,778	Carpenter, Willard C. Motor.....	39,264
Burdick, Justin H. Nut making machine.....	40,760	Carpenter, Victor H. Fruit basket and cover.....	39,059
Burdon, Levi L. Compound ingots and wire made therefrom.....	38,720	Carpenter, Felix. Means for holding together the various parts of doors, &c.....	39,474
Burdon Seamless Filled Wire Company. Compound ingots and wire made therefrom.....	38,720	Carr, Israel Lewis. Fire extinguisher.....	39,138
Burdon Seamless Wire Company. Method of producing seamless compound wire.....	40,050	Carr, Warren H. et al. Heel block.....	38,145
Burgess, Neilson. Stage apparatus.....	40,731	Carriger, John H. Washing machine.....	39,436
Burke, A. Leroy. Washing machine.....	38,788	Carrington, Campbell, et al. Horse shoe machines.....	41,375
Burke, Mary C. Wash board.....	40,349	Carrol, Robert, et al. Hoist and travelling carrier.....	40,603
Burkholder, Joseph Henry. Medicine for bowel complaint.....	38,846	Carroll, John Ballard. Sink trap.....	39,019
Burkholder, David J. Water elevator and purifier.....	38,891	Carroll, Thomas J. Hose nozzle.....	41,135
Burley, Thomas W., et al. Mechanism for actuating interlocking gear for railway switches and signals.....	40,414	Carter & Company. Numbering machine.....	41,256
Burling, William. Steam generator.....	39,342	Case, Joseph D., et al. Electric piano player.....	39,494
Burlingham, Samuel. Apparatus for starting and stopping vehicles.....	39,786	Cash, Arthur Wise. Vise.....	38,200
Burnet, Robert. Paper feeding machine.....	41,387	Casler, Alonzo A. Washing machine.....	38,231
Burnham, Arthur McCausland. Wringer for mops.....	38,611	Caspar, Henry. Coin operated lock.....	40,418
Burt, Martin Charles. Dynamo electric machine.....	38,885	Casper, Edward, et al. Apparatus for obtaining copper and other metals from solutions of the salts of same.....	39,633
Burton, George F. Advertising device.....	41,109	Cassady, George. Car coupler.....	40,108
Burt, Elwood, et al. Machine for holding reels.....	40,697	Cassady, George. Circular saw.....	39,885
Busby, Matilda M., et al. Brake.....	40,812	Cassidy, Jesse J. Brake for cars.....	39,365
Buschlen, Samuel. Hay rake.....	41,278	Caswell, Myron J. Device for distributing liquid poison.....	41,287
Bushnell, Edwin L., et al. Car seat.....	39,988	Catlin, Charles A. Baking powder.....	39,962
Bushnell (E.L.) Spring Company. Car seat.....	39,988	Catlin, Robert M. Gun.....	39,772
Bustin, William H. Machine for making harness saddle trees.....	39,818	Caustic Soda and Chlorine Syndicate. Apparatus for manufacturing chlorine and caustic soda.....	39,524
Butler, Warren T. Apparatus for spreading fertilizing material.....	40,782	Central Cyclone Company. Machine for grinding, crushing or disintegrating grain.....	39,627
Butter, Joseph, et al. Refrigerator.....	38,545	Chadbourne, Anne G. Closet.....	38,688
Butterfield, John C., et al. Cartridge.....	39,399	Chambers, Josephus C. Electrical medical apparatus.....	40,035
Butterfield, John C., et al. Cartridge case.....	39,840	Chambers, Josephus C. Suspensory bandage.....	38,286
Butterfield, Mitchell Electric Heating Company. Electric car heater.....	39,308	Chambers, Thomas Robertson. Bedstead.....	38,888
Butterworth, Enoch B. Hot water boiler.....	38,528	Chambers, William. Gate.....	40,040
Butterworth, Enoch B. Warm air furnace.....	38,718	Chamberlain, George. Stretcher and fastener for wire.....	41,339
Buttrey, Leonard H., et al. Steam trap.....	41,229	Chamberlain, Thomas B. A. Dry closet.....	38,367
Byfield Manufacturing Company. Knitting machine.....	40,619	Chamberlain, Walter H. Vending machine.....	40,746
Cable, Austin Demons. Advertising mile board.....	38,988	Champion, Thomas J., et al. Hub boring machine.....	40,046
Cadwell, Marvin S. Machine for weaving wire and slat fabrics.....	39,851	Champion, William. Washing machine.....	38,029
Cagwell, Thomas. Dump bucket.....	38,863	Champney, William R. Door for cars.....	39,790
Caldwell, George B. Vehicle running gear.....	39,460	Chandler, Richard. Car coupler.....	39,722
Caldwell, Henry A. Machine for cutting cloth.....	40,414	Chanler, John A. Pavement.....	40,550
Caldwell, Peter. Shovel.....	41,261	Chapleau, Samuel E. St. O. Air brake.....	39,014
Calef, Joseph W. Drag saw rail cutting machine.....	38,804	Chaplin, Charles O., et al. Guard for razors.....	38,786
Calkins, Gary G. Burner for oil.....	41,099	Chaplin, William. Cover for the ends of hub bands.....	40,277
Callantine, Joseph, et al. Car coupler.....	38,782	Chaplin, William. Cap for vehicle hubs.....	40,282
Cameron, Alexander M. Machine for grinding knives for mowers and reapers.....	38,993	Chapman, Clarence L., et al. Nut tapping machine.....	40,854
Cameron, Alexander N. Roof ladder.....	40,769	Chapman, Frank L. G., et al. Axle.....	39,009
Cameron, George W. Tool for watchmakers' use.....	41,386	Chapman, George T., et al. Tool for applying and removing horse-shoe guard plates.....	40,917
		Chapman, J. W. Machine for cutting staves.....	40,363

Chappell, George H., et al. Valve.....	40,914	Colclough, Charles, et al. Canting block for saw mill carriages.....	39,280
Charest, Alcide. Machine for cutting iron pipes.....	38,152	Cole, Alexander G., et al. Painting machine.....	38,077
Charles, Samuel M. Sleeping car.....	40,943	Cole, Harrison. Hitching strap.....	39,745
Chase, Henry H. Protector for cow udders.....	38,645	Cole, James W. Method of casting iron pigs, ingots, &c..	39,164
Chase, Henry H. Saddle support for bicycles.....	39,309	Cole, Joseph T. C. Sash balance.....	39,331
Cheever, John H. Covering for electric cables.....	40,305	Cole, Walter. Centrifugal apparatus for separating cream from milk.....	39,954
Chenevert, Thomas, et al. Method of preserving fruit.....	38,709	Cole, Walter. Method of preparing butter and cream.....	39,173
Cheney, Stephen, et al. Thimble for stove pipes.....	38,247	Cole, William R. Store service apparatus.....	39,558
Cheney, Walter W., et al. Thimble for stove pipes.....	38,247	Coleman, George D. Process of and apparatus for making pigments.....	40,876
Chesebrough, Robert A. Method of preserving wood and iron imbedded in the earth.....	41,428	Coleman, James H. Hanger and fastener for gates.....	39,225
Chesnut, John M. Reamer.....	38,619	Coleman, Joseph H. Car coupler.....	38,627
Child, John H. A., et al. Signalling apparatus for railways.....	39,482	Colgate, George. Sifter for ashes.....	39,215
Chimney & Co. Apparatus for manufacturing and bottling aerated liquids.....	39,523	Colley, Joseph. Steel or ingot iron.....	39,160
Chinnery, Luther G., and Swartz M. Apparatus for manu- facturing and bottling aerated liquids.....	39,523	Collier, Arthur T. Telephone receiver and transmitter.....	41,084
Choate, Parker C. Art of producing metallic zinc.....	41,100	Collier, Arthur T. Transmitter for telephones.....	40,183
Choquette, Alfred E. Harness attachment.....	40,269	Collins, Charles, et al. Fruit gatherer.....	40,134
Choquette, Ephraim. Street sweeping machine.....	38,594	Collins, Edward L., et al. Wringer for mops.....	38,611
Christian, Peter B., et al. Axle nut for vehicles.....	41,017	Collins, John R., et al. Mower.....	40,937
Christensen, John. Apparatus for preventing horses from cribbing.....	38,196	Collins, John R., et al. Station and street indicator.....	41,034
Chumard, Melchoir. Lifting jack.....	38,561	Collins, Samuel. Sash holder.....	40,722
Church, Addison C., et al. Washing machine.....	38,195	Collins, William G. Ink bottle.....	40,430
Church, Andrew and Charles Augustus. Regulator for hydraulic wind mills.....	38,305	Colorado Iron Works. Concentrator for ores.....	38,806
Church, Walter A., et al. Screw driver.....	38,324	Columbia Electric Company. Arc lamp.....	40,625
Church, William H., et al. Case for eggs.....	39,204	Colvin, Robert J. Joint for railway rails.....	40,901
Circle, Franklin Pierce, et al. Wheel.....	39,013	Comfort, John W., et al. Incandescent electric lamp.....	40,095
Clairmont, Joseph J. Camera.....	39,967	Comnichau, Gotthard. Flexible metal tubing.....	40,104
Clairmont, Joseph J., et al. Camera shutter.....	40,495	Conboy, Daniel. Carriage top.....	38,925
Clark, Alexander and John H., et al. Dash board.....	40,351	Conboy, Daniel. Top for buggies.....	38,655
Clark, Alvin P., et al. Steam trap.....	41,229	Concave Paddle Wheel Company. Paddle wheel.....	38,974
Clark, Charles Aretas. Machinery for squeezing water out of moss or other spongy substances.....	38,977	Conley, Oliver P. Car coupler.....	40,118
Clark, Ernest P. Regulator for dynamo electric machines.....	39,882	Conly, Mahlon S. Signal system.....	40,864
Clark, Frederick O. Ribbon roller.....	38,808	Conly, Mahlon Smith. Governor for dynamos.....	39,090
Clark, George M. Plough.....	40,577	Conner, Theodore McLarran. Machine for making netted wire fabric.....	40,885
Clark, George W., et al. Bob sleigh.....	41,015	Connelly, James T. Tapping device for stay bolt holes.....	38,162
Clark, Joseph. Cock for gas.....	40,031	Connett, Matthew F. Display device.....	39,464
Clark, Joshua A., et al. Floor or roof for buildings.....	40,975	Connolly, John. Whiffletree and neck yoke.....	38,175
Clark, Melville. Organ.....	39,314	Conser, John, et al. Bee hive.....	40,999
Clark, Samuel W. Game.....	38,923	Consolidated Car Heating Company. Car heating appara- tus 39,406, 39,407, 39,408, 39,412, 39,811, 39,835, 40,051,	41,178
Clarry, Henry J. Extinguisher for lamps.....	38,302	Consolidated Car Heating Company. Coupling for hose.....	41,342
Claus, Hubert. Process of enamelling sheet iron ware.....	40,891	Consolidated Car Heating Company. Current director.....	41,266
Clausen, Emil, et al. Table.....	40,892	Consolidated Car Heating Company. Current regulator.....	41,267
Clay, Albert M., et al. Shutter slat tenon.....	39,038	Consolidated Car Heating Company. Electric regulator.....	40,285
Clay, Arthur T. Machinery for preparing and dyeing woven fabrics.....	41,036	Consolidated Car Heating Company. Heater for water.....	40,239
Clay Glass Tile Company. Process of plating clay with glass.....	40,923	Consolidated Car Heating Company. Heating apparatus for railway cars.....	41,430
Clayton, Lemuel, et al. Machine for scouring and dyeing yarn.....	40,869	Consolidated Car Heating Company. Hose coupling.....	39,404
Clayton, William J., and Edward, et al. Calculator.....	40,067	Consolidated Car Heating Company. System of charging car heating apparatus with a heating medium.....	40,257
Clemens, Ernest V. Seal stopper for bottles.....	40,222	Consolidated Car Heating Company. Pipe coupling.....	38,971
Clement, Thomas. Apparatus for testing liquids and sub- stances.....	40,888	Consolidated Car Heating Company. Temperature regula- tor 38,131, 39,355, 39,405, 39,409, 39,410, 38,972, 40,240,	40,397
Clement, Thomas. Process of testing liquids or substances.....	39,724	Consolidated Car Heating Company. Valve for train pipes.....	39,810
Cleveland, Lewis W. Electrical door bell pull.....	40,422	Cook, Charles L. Rod packing.....	40,968
Cleveland Fire Company. Pneumatic tyre.....	38,098	Cook, John B. Damper for stove pipes.....	38,449
Cleveland, William T. Shears for cutting hot metal.....	41,353	Cook, John H. Vehicle cleaning device.....	40,006
Clewley, Frank, et al. Knitted bag.....	39,107	Cook, John W. B., et al. Nut lock.....	38,233
Clift, Christopher. Gas or electric heater for water.....	38,033	Cook, Joseph E., et al. Straw separator for threshing ma- chines.....	38,667
Cline, Robert H., et al. Collar for horses.....	39,319	Cook, Frank S. Nut tapping machine.....	41,048
Climenson, William W. Holder for pencils and crayons.....	39,197	Cook, Thomas J. Sulky spring tooth harrow.....	38,148
Cline, George J. Sickle grinder.....	38,216	Coons, Rollin L. Box making machine.....	40,558
Cload, Alfred C., et al. Mortising machine.....	38,734	Cooper, Charles W. Apparatus for evaporating liquids.....	41,130
Close, Walter R. Fog signal.....	40,713	Copeland, William M. and Rufus I. Water regulator for boilers.....	39,833
Close, James A. Violin.....	40,656	Copelin, Elizabeth G. Cover for pots.....	40,071
Close, John W., et al. Railway construction machine.....	38,684	Copp, Monroe M. Veterinary operating table.....	40,467
Closz, Charles. Separator and cleaner for grain.....	40,290	Corbin, Jay Spencer. Disk harrow.....	38,872
Clouston, John. Puzzle.....	38,511	Corbin, Jay Spencer. Reversible disk harrow.....	38,330
Cluth, Charles. Hernia pad.....	40,233	Cornelius, John, et al. Wrecking machine and stump ex- tractor.....	40,465
Cluth, Charles. Truss.....	40,919	Cornish, Harry B. Refrigerator and gas generator.....	38,999
Coad, Theophilus. Fluid for primary batteries.....	40,472	Corser, Lorenzo D., et al. Levelling attachment for har- rows.....	38,843
Cobb, Dewey A. Method of and apparatus for shaping tubular fabrics.....	40,325	Costello, Thomas M., et al. Brick.....	39,989
Coben, Henry J. Drip-board for sinks.....	40,787	Cottier, William T. Wardrobe.....	38,224
Cobham, Frederick P. Extension table.....	39,942	Cottrell, Calvert B. Printing machine.....	40,086
Cobham, Frederick P., et al. Lock.....	38,250	Couch, Charles A. Damper.....	41,132
Cochins, George. Motor.....	41,423	Couch, Daniel R. Vehicle box.....	40,413
Cochrane, Haggert S., and Grace. Wire weaving fence machine.....	40,301	Couch, Joel, et al. Extension table.....	39,108
Cockrell, William A. Collector for dust.....	39,328	Coughlin, Samuel B., et al. String for musical instru- ments.....	38,297
Coe, John B. Chopper for culinary use.....	39,629	Coulter, John J., et al. Stop for engines, &c.....	38,659
Coffey, John, et al. Gill net puller.....	41,003	Coulter, Joseph. Folding chair.....	39,210
Gogan, William P., et al. Attachment for raising or lower- ing furniture.....	41,328	Coulter, William, et al. Pulley.....	38,955
Cohen, Reuben. Cigar vent.....	38,459	Coulthard, Walter. Cultivator.....	39,608
Cokayne, William. Nut lock.....	38,862	Coulthard, Walter, et al. Horse hay rake.....	40,857
Colburn, Alvin, et al. Polishing wheel.....	40,909	Coulthard, Walter, et al. Seeding machine, cultivator, &c.....	40,632
Colby, Branch Harris, et al. Game.....	39,863	Coupal, Peter A., et al. Staple driving machine.....	40,455
	38,899		

Covel, Milo. Saw dressing machine.....	38,237	Cushman, Abe L. Dust guard for car axle boxes.....	38,354
Covel, Milo. Saw sharpening machine.....	38,319	Custer, William F. Wrench.....	39,297
Covell, Arthur W. Grapple.....	39,515	Cuthbertson, James W., et al. Tyre set.....	39,370
Cowan, Herbert S. Can.....	40,534	Cutter, Solomon M. Shoe slugging machine.....	39,600
Cowan, Robert C., et al. Drag saw rail cutting machine.....	38,804	Cuttris, Charles. Sealing device.....	38,986
Cowen, Robert. Belting.....	40,540	Daily, John W., et al. Endoscopic instrument.....	39,632
Cowen, Robert. Method of repairing pneumatic tyres.....	40,729	Dallas, Alexander. Truss.....	39,008
Cowles, Henry. Hot air furnace.....	39,695	Dale, Robert G., et al. Egg carrying package.....	39,715
Cowling, John, et al. Coupling for rods.....	41,320	Daley, John Joseph. Reversing mechanism for ironing machines.....	38,226
Cox, Alisa Ann. Clothes line.....	38,550	Daly, John F., et al. Electric ignitor for gas engines.....	38,425
Cox, Joseph L. Printing press.....	40,281	Daly, John F., et al. Gas engine.....	39,260
Cox, William. Glide rule for engineers.....	39,468	Daly, Daniel A. Shovel.....	38,908
Coyle, Joseph, et al. Stamp affixer.....	41,112	Dana, Douglas W., et al. Boat raising and lowering device.....	40,858
Crafton, Tilmon L. Process of tanning hides.....	38,371	Daniels, David B. Nut lock.....	39,147
Craggy, Benjamin J., et al. Waste end conveyors for carding machines.....	40,620	Daniels, Henry H. Combination lock.....	41,171
Craig, John Benton. Fastener for shoe-ties.....	38,272	Dannhauser, Lewis. Harness.....	39,495
Craig, John C., et al. Cloth measuring machine.....	39,200	Dansereau, Pierre. Axle skein.....	38,587
Craig, Matthew C. Rack for wagons.....	40,218	Darby, Thomas C., et al. Cultivator.....	41,309
Crampton, Thomas P. C., et al. Arc lamp.....	40,136	Darby, William B. Lock for bedsteads.....	38,960
Crandall, Charles M. Toy.....	40,138	Darrow, Charles E., et al. Book case.....	40,626
Crandall, Willis Augustine. Bed pan.....	38,921	D'Auria, Luigi, et al. Steam pump.....	40,012
Crane, Charles, et al. Brake.....	39,452	Davey, Francis, et al. Electric switch.....	39,048
Craney, Thomas. Bag filler.....	38,635	Davis, Charles Cassat. Device for inducing full respiration.....	38,112
Craney, Thomas. Condenser.....	41,010	Davis, Emry. Inkstand.....	39,088
Craney, Thomas. Electrolytic apparatus.....	40,970	Davis, Frank E., et al. Machine for covering wire, &c.....	39,750
Craney, Thomas. Evaporating apparatus.....	38,505	Davis, Harriet E. Dish washer.....	38,036
Craney, Thomas. Grainer for salt.....	38,674	Davies, John Rees. Car wheel.....	38,675
Cray, Abel. Scoop.....	39,074	Davies, Joseph J., et al. Printers galley.....	40,506
Creaser, Robert. Machinery for separating flour middlings, semolina, &c.....	40,420	Davies, Thomas. Railway rail chair.....	38,219
Crececius, Louis J. Lifting jack.....	40,273	Davies, John, et al. Screw propeller.....	39,504
Creery, Morgan R. B. Clamp for dental flasks.....	40,149	Davis, John S. Grain binder.....	39,884, 40,738
Cremer, William J., et al. Cut off valve and gear.....	39,124	Davis, John S. Grain conveyor for harvesters.....	40,161
Crenshaw, Thomas C., et al. Loop for harnesses.....	39,125	Davis, John S. Starting mechanism for grain binders.....	40,900
Cremer, Peter D., et al. Barrel.....	41,047	Davis, Talton T. Rectal speculum.....	38,936
Cresswell, Randal, et al. Apparatus for feeding paper to printing presses.....	39,960	Daw, Albert W. and Zacharias W. Valve.....	38,681
Crews, Thomas B., et al. Anti-friction bearing.....	39,702	Dawson, George Frederick, et al. Compound for use in extinguishing fires.....	38,107
Criswell, Charles E., and Joseph L., et al. Car coupler.....	39,898	Dawson, Henry T. Gas engine.....	38,416
Crocker, James A. Filtering machine.....	39,661	Dayton Autographic Register Company. Autographic register.....	38,199
Crocker, James A. Process of filtering water.....	39,662	Dean, Albert H. Holder for cartridges.....	38,693
Crocker Filtering Co. Filtering machine.....	39,662	Dean, Cyrus S. Heater for cars.....	40,659
Crocker Filtering Co. Process of filtering water.....	39,770	Dean, Cyrus S., et al. Burner for gas.....	41,332
Croissant, Martin. Step ladder.....	38,803	Dean, Seward A. Typewriter.....	39,441
Crompton, Frederick. Corset.....	40,747	Dean, William B. Lasting machine.....	39,859
Crompton, Frederick. Dress stay.....	39,322	Deane, Francis B., et al. Compound press.....	40,452
Crompton, Frederick. Method of and machine for making garment stays.....	39,185	Dearth, William L. Washing machine.....	38,716
Crompton, Thomas. Tea blending machine.....	38,871	De Camp, Alfred H. Aerial tramway.....	38,306
Cronk, Adolphus F. Hame.....	41,220	De Chardonnet, Hilaire. Method of and apparatus for making artificial silk filaments.....	40,117
Crook, William. Motor.....	39,069	Decker, Joel C. Oil for general painting purposes.....	40,689
Crosby, Ezra. Brake for sleds.....	41,116	Decker, Mark M. Car coupler.....	40,517
Cross, Benjamin C., and Daniel. Method of and apparatus for corking bottles, &c.....	38,543	DeCoppet, Jean. Ore concentrator.....	39,240
Cross, George J., et al. Means for operating lock hinges.....	41,245	Decouffe, Anatole E. Machine for making cigarettes.....	40,330
Cross, Isaac T. Extension ladder.....	38,242	Decrow, William E. Electric signal box.....	40,160
Cross, John. Drier for clothes.....	40,747	Dee, Thomas. Car coupler.....	39,144
Crotty, John S. Dress stay.....	39,478	Dederick, Ezra. Hook.....	39,104
Crowdus, Walter A. Galvanic battery.....	40,198	De Ferranti, Sebasten Z. Electric main.....	40,587
Crowell, John H., et al. Camera.....	38,811	DeGrace, William L. Car coupler.....	40,660
Cudney, Frederick. Wrapper for butter.....	38,377	Delahunty, Joseph P. Apparatus for dyeing or scouring.....	39,862
Cullens, John T., et al. Brick kiln.....	38,365	Delplace, Emile and Jules. Apparatus for making sulphuric acid.....	38,608
Culver, Lucius L. Heater for water.....	40,613	De Laval, Carl G. P. Centrifugal separator.....	40,904
Cummings James F. Process of making conduit sections for underground electrical conductors.....	40,564	De La Vergne Bottle and Seal Company. Corking machine.....	40,887
Cummings, James F. Underground conduit for electrical conductors.....	40,563	De La Vergne Bottle and Seal Company. Seal stopper for bottles.....	40,888
Cummins, George Wyckoff. Process for preventing the oxidation and deoxidation of copper and its alloys when heated or being annealed.....	38,980	Demarest, Harvey V. Shutter bower.....	38,814
Cunningham, Albert. Band saw-mill.....	39,869	De Mars, Joseph. Sash lock.....	38,797
Cunningham, Frank R. Jewel holder.....	38,059	De Mars Sash Lock Company. Sash lock.....	38,798
Cunningham, John, et al. Incandescent electric lamp.....	40,095	Deming, William B., et al. Paint pot.....	40,843
Cunningham, Patrick. Rocket.....	40,818	Denis, Henry. Seal for envelopes.....	40,226
Cunliffe, Richard. Steam generator.....	41,324	Denne, Eli and Frederick A. Cut off for gas burners.....	39,119
Cupples, Samuel. Envelope.....	40,828	Dennis, Edward M. Hinge for school seats.....	38,867
Cupples, Samuel. Machine for making paper bags.....	41,195	Dennis, James, et al. Holder for wool, thread, &c.....	41,286
Curio Company. Pocket tobacco case.....	39,732	Dentremont, John B. J. Trawl roller.....	39,338
Curran, Patrick. Swimming equipment.....	38,279	De Pont, Alexander and Silvius. Method of making ivory balls, blocks, &c.....	40,592
Currie, Daniel. Taper attachment for lathes.....	39,976	Depue, James E. Ledger, sales book and billing book combined.....	40,979
Currier, John W. Device for preparing maple sugar.....	38,515	Desautels, Médéric. Sleigh.....	41,341
Currier, John W. Sap spout.....	38,636	Desboubin, André. Developing dish for photographic purposes.....	40,866
Curtis, Charles, et al. Digester for paper pulp.....	41,022	Desisles, Leonard H., et al. Electric heat alarm.....	38,777
Curtis, John D. Barbed wire.....	41,153	Desmond, Dennis G., et al. Electric head light.....	39,046
Curtis, John D. Method of manufacturing barbed wire.....	38,714	DeSusini, Paul. Gas engine.....	39,065
Curtis, Edward W. Steam engine.....	39,934	DeVasson, Raphael. Cork composition.....	40,772
Curved Electro-Type Plate Co. Method of blending electro-type plates.....	41,298	Devine, George F., et al. Game.....	38,248
Cussen, William James. Pouch for tobacco.....	38,097	Devlin, James C. Car coupler.....	40,945
Cussen, William J., et al. Pouch for tobacco.....	41,107	Dewey, Mark W. Electric heating apparatus.....	39,326
Cushing, George W. Car wheel.....	41,322	Dewey, Mark W. Electric heating apparatus for railway systems.....	39,300, 39,644

Dewey, Mark W. Electric railway	39,325	Drummond, George A. Art of cleaning and washing raw sugar	41,364
Dewey, Mark W. Electric refrigerating apparatus for railway cars	39,327	Drummond, George A. Method of making and purifying saccharine solutions	41,363
Dewey, Mark W. Electric traction increasing system for railways	39,889	Drummond, George A. Process of refining sugar by lixiviation	41,362
Dewey, Mark W. Electro-magnetic traction increasing system for railways	39,888	Drummond, George A. Process of washing and boiling sugar juice for obtaining grain sugar	41,360
Dewey, Mark W. Method of electric refrigeration	40,986	Drummond, George A. Process of working up sugar juice into grain sugar	41,359
Dewey, Mark W. Method of electrically welding metals	41,164	Dryer, George W., et al. Car seat	39,988
Dewey, Mark W. Method of magnetically reducing friction	40,206	Du Bois, Frederick N. Trap for plumber's use	39,944
Dewey, Mark W. Method of transforming and utilizing electrical energy	40,853	Du Bois, Henry Lex. Process of seasoning hub blocks	38,288
Dewey, Mark W. Method of working metals by electricity	40,205	Dubois, Louis E. Safety attachment for street cars	40,589
Dexter, Avelyn J. Refrigerator	40,773	Dubbs, Jesse Adams. Asphaltum	38,929
Diamond Paper Bag Company. Machine for making paper bags	41,045	Dubbs, Jesse A., et al. Method of disulphurizing oils	41,114
Dickinson, Austin Ray. Hose clamp	39,012	Dubbs, Jesse A. Method of making asphaltum	41,101
Dickmann, Karl H. Axle	40,694	Duckham, Frederick E. Conveyor for grain	40,088
Diebel, Henry. Cutter for rods and pipes	38,172	Duclos, George A., et al. Money changer	40,114
Diehl, John F., et al. Regulator or governor for gas	38,188	Dudley, Plimmon H. Track for railways	40,304
Dierdorff, Henry. Mining machine	40,771	Dudley, Walter J. Electric clock	38,421
Dill, Thomas, et al. Painting machine	38,077	Dufresne, Napoléon, et al. Leather skiving machine	41,333
Dillon, Robert. Saw set	40,725	Dulier, Edward E. Consumer for smoke	40,080
Dimant, Elias. Spring bottom for bedsteads, &c	39,677	Dunbar, William. Saw	38,493
Dimick, Augustus DeFoe. Piano action	39,073	Duncafe, William P. Medicinal compound	39,258
Dimick, Charles, et al. Holder for parcels	40,254	Duncan, Charles, et al. Shoe lacing device	40,481
Dimneen, Michael J., et al. Circular knitting machine	38,721	Duncan, Charles W. Brake for cars	38,186
Disbrow, R. B. and L. A., et al. Churn and butter worker	40,375	Dunham, Ira. Fishing apparatus	40,265
Dittmar, Allen A., et al. Air pump	40,400	Dunlap, Harley M. Atomizer	49,641
Divine, Silas R. Explosive compound	39,802	Dunlap, Steward. Oil car	41,146
Dixon, Frederick N. Salt container and sprinkler	40,208	Dunlap, Thomas. Wheel for the propulsion of vessels	38,649
Dobbie, Robert S. Electric motor for wheeled vehicles	38,609	Dunn, Thomas. Pneumatic tyre	40,823
Dobie, John. Case for cartridges	39,281	Dunn, John M. Cleaner for boiler tubes	41,425
Dobrowsky, Michael Von Dolivo. Alternating current electric machine	38,879	Dunne, Gerald M., et al. Match box	39,421
Dobson, Alexander. Reel	39,425	Duntze, Johann C. Process for producing colour on glass surfaces	40,910
Doddrell, Thomas. Clamp for drawing together wooden joints	39,389	Duperow, Hiram. Gate	38,762
Dodge, Charles A. Staging	40,037	Duplex Printing Press Co. Printing press	40,281
Dodge, James M. Apparatus for removing piles of coal	39,546	Dupont, Emile. Method of making compound slabs of cement	38,358
Dodge, James M. Machinery for moving coal	39,571	Durant, Fayette B., et al. Trap for waste water pipes	38,835
Dodge, Philip T. Lenotype machine	39,813	Durning, Joseph S. Process of hardening metals	40,338
Dodge, Samuel D., et al. Street car	40,889	Dutton, Chouncey N. Balance lock water ways	39,615
Doering, Hermann. Pad for horse collars	40,877	Dutton, William W., et al. Cut off for pipes	41,418
Doering, Hermann. Stitching horse	39,493	Duval, Jennie P. Protector for beds	39,377
Doig, William S. Box nailing machine	39,568	Duval, Narcisse, et al. Wheel for water and wind	38,143
Doig, William S. Nailing machine	39,562	Dvorkovitz, Paul. Method of and apparatus for distilling liquid hydrocarbon	41,275
Domeier, Albert, et al. Apparatus for concentrating spent soap lye to recover salt and glycerine therefrom	40,703	Dwinnell, David L. Hot water heater	38,062
Domeier, Albert, et al. Apparatus for distilling glycerine recovered from soap lye	40,732	Dwinnell, David L., et al. Cistern for closets	38,856
Domeier, Albert, et al. Method of making glycerine from spent soap lye	40,708	Dwyer, Daniel C., et al. Horse-shoe	40,537
Domeier, Albert, et al. Apparatus for obtaining salt and crude glycerine from spent soap lye	40,706	Dyas, William J., et al. Moister for stamps and opener for envelopes	39,718
Domeier, Albert, et al. Apparatus for purifying salt recovered from spent soap lye	40,705	Dykes, Hugh J. Pump	41,141
Dominion Sanitary and Cremation Company. Method of, and apparatus for destroying garbage, night soil, &c	38,783	Dyrenforth, Douglas. Method of casting iron pigs, ingots, &c	39,164
Dominion Tubular Lamp Co. Lantern	40,604	Eakins, John H. Car coupler	40,425
Donally, Amelia M. Bottling apparatus	40,640	Earle, John, et al. Metal tubes	39,560
Donecken, Augustus H., et al. Kilm	40,764	Earle, Salyer R. Steam and air injector for boiler furnaces	39,392
Donnelly, John Maxwell. Car replacer	38,280	Eastman, William J. Electric cigar lighting lamp	41,065
Dooley, Joseph, et al. Truck	38,942	Easton, James W. Electric lamp	39,692
Doorey, Edwud, et al. Compensator for signal rods	39,582	Easton, James W. Lightning arrester	40,246
Doré, Elzéar. Washing machine	38,965	Easton, Francis M. Centre-board for boats	40,837
Dorenweud, Christian H. Electric belt	39,223	Eaves, John L., et al. Thimble	41,097
Dorman, William S. Machine for cutting screws	40,753	Eberhardt, Max. Compound for use in extinguishing fires	38,107
Dougherty, William. Filter and heater for steam boilers	40,158	Ecker, James S., et al. Furnace	41,356
Doungie, James T., et al. Wagon	38,728	Eckstein, Friedrich. Substitute for glass	40,022
Douse, Thomas Ralph. Electric fire indicator	38,883	Eclipse Patent Nut Lock Washer Company. Nut lock washer	39,394
Dovercourt Twine Mills Company. Sash cord machine	38,733	Eddis, Ernest H. E. Puzzle	39,434
Dowd, Daniel L. Exercising machine	39,220	Eddy, E. B., Company. Paper box	39,528
Dowdall, James Bernard. Extinguisher for lamps	38,995	Eddy, E. B., Company. Toilet paper fixtures	38,180
Dowling, John, et al. Washing machine	38,195	Eddy, E. B., Company. Toilet paper rolls	38,181
Down, William, et al. Receptacle for coins	39,369	Edgar, Butler, et al. Method of lubricating the journals of car axles	41,203
Downing, George H. Fire extinguisher	40,278	Edgar, Daniel. Spring bed bottom	38,600
Dowswell, Albert E., et al. Post hole digger	40,936	Edgar, Dennis P. et al. Refrigerator	38,545
Doyle, William, et al. Car coupler	39,346	Edgar, Ellis F. Furnace	39,440
Dozier, Louis David, et al. Portfolio for collars and cuffs	39,061	Edgar, Ellis F. Heating apparatus	39,433
Drader, Joseph, et al. Harrow	39,531	Edgerton, Nathan H. Secondary battery	39,875
Drake, Thomas. Turpentine and means of producing the same	38,414	Edison, Thomas A. Determining device for phonographs	40,125, 40,126, 40,127
Draper, John. Method of and means for removing and preventing scales or incrustations in steam boilers, &c	38,596	Edison, Thomas A. Phonograph	40,099, 40,101, 40,130
Draper, Tronson. Valve	39,843	Edison, Thomas A. Phonogram blank	40,100
Draper, William R. Machine for making paper boxes	39,368	Edison, Thomas A. Process of treating phonogram blanks	40,102
Drew, James T. Motor	39,938	Edmand, Fred B. Blocking and measuring device	41,137
Drummer, John, et al. Tidal motive power	41,205	Edmiston, James B. Purifier for feed water	39,217
Drummond, George A. Apparatus for obtaining pure white sugar by lixiviation	41,361	Edmunds, Henry V., et al. Machine for manufacturing panel doors	38,767
Drummond, George A. Apparatus for refining sugar	41,358	Edward, Evan A. Apparatus for distilling oils	40,814
		Edwards, George D. Means for preventing alteration of the amounts of negotiable papers	39,619
		Edwards, Richard J. Scraper for soil working implements	39,040

Eggert, Edward O., et al. Screw driver	38,324	Evans Gas Engine Company. Gas engine	40,428
Eggert, George E. Door mat	39,827	Evans, George H. Governor for steam engines	41,026
Eichelberger, John T. Fish-hook	38,160	Evans, Howell E. Bridle bit	38,774
Einstein, Elias, et al. Device for securing tools to handles	38,546	Evans, James. Pulverizer and conveyer for clay	39,436
Eisenhardt, George T. Machine for printing oil cloth	40,723	Evans, John W. Apparatus for evaporating naphtha	38,704
Ekstrom, Axle. Ceiling block	39,825	Evans, John D., et al. Hose coupler	39,118
Elastic Nut Company. Nut making machine	40,760	Evans, Mortimer, et al. Camera	39,475
Elastic Nut Company. Method of making nuts	40,778	Everhard, Mary M. Kneading board	38,984
Eldridge, Henry, et al. Machine for making nails	40,503	Everett, John F. Number device	41,125
Electric Heat Alarm Company. Electric heat alarm	38,777	Everitt, Arthur, et al. Bicycle	40,554
Electrical Machine Company. Machine for cutting cloth	40,414	Everitt, Percival. Apparatus for automatically lighting and extinguishing gas lamps	40,692
Elieson, C. P. Meter for electricity	39,488	Eversman Ernest A., et al. Hot air pipe and air flue	41,429
Elkins, William H. Regulator for dynamo-electric machines	40,242	Everson, Barclay M. Attachment for inkstands	38,221
Eller, Julius M. Swinging chair	38,173	Everson, Carrie J., et al. Ore concentrator	39,965
Ellinwood, Augustus E. Machine for making matches	40,988	Evinof, Julius. Nut lock	40,671
	41,001	Ewin, John B. Gate and hinge	39,262
Ellis, Arthur W. Art of and apparatus for distilling	40,416	Faber, Peter, et al. Axle nut for vehicles	41,017
Ellis, Frank A. Electric clock	38,426	Faeger, Theodore. Chimney cowl	40,719
Ellis, George H. Camp stool	40,336	Fahey, Michael J. Thimble for stove pipes	38,265
Ellis, John Stuart. Machine for drilling or boring holes for nuts, &c.	38,981	Fahlberg, Constantin. Saccharine matter	38,918
Ellis, John S., et al. Game	39,005	Fahrig, Ernest. Compound for electric insulation	40,170
Ellis, Joseph W., et al. Revolving fortifications for coast defence	41,416	Faiga, Henry. Kiln floor for drying cement	39,758
Ellis, Richard E., et al. Machine for treating leaf tobacco	38,603	Fairbairn, Charles. Apparatus for forging and finishing circular articles	41,080
Ellison, Joseph C., et al. Car coupler	39,968	Fairbairn, Charles, et al. Apparatus for forging screws by rolling	41,212
Elliott, Elmore H. Apple parer	39,140	Fairbank Canning Company. Can	40,284
Elliott, Henry. Frog for spring rails	40,151	Fairchild, Frank H., et al. Attachment for raising or lowering furniture	38,459
Elliott, Henry. Lock	41,122	Faire, Watkin L. Stretcher for boots	39,179
Elliott, James H. Draw bar	39,763	Fairman, Alfred N. Machine for making stove pipe elbows	41,252
Elliott, James Nicholas. Lubricator	38,963	Falkenhause, Hugo. Air pump	40,400
Elliott, Sterling. Sulkie	41,306	Fallis, Richard, et al. Brake gear for railroad cars	39,709
Elmer, William H. Turbine	38,341	Fane, Thomas, et al. Tyre for bicycles	38,284
Elmore, Francis E. and Alexander S. Apparatus for manufacturing tubes by electrolysis	38,323	Fane, Thomas, et al. Velocipede	39,777
Elmore's American and Canadian Patent Copper Depositing Company. Apparatus for manufacturing tubes by electrolysis	38,323	Fargo, Frank B., et al. Butter worker	38,303
Elson, William K. Method of making glass vessels	41,391	Farguhar, William. Vehicle	38,073
Elston, Charles C. Table attachment to bedsteads	41,057	Farmer, Leslie P. Car	41,251
Elwood, Byron H. Burner for hydro-carbon oil	40,196	Farmer, Luther C., et al. Weighing machine	41,058
Ely, Edwin W. Target	38,729	Farnam, Arlington, J. Tank and case for liquid blacking	39,229
Emerson, Charles H. Boomerang	40,014	Farnham, Moses P. Drum	41,008
Emerson, Charles H. Boomerang gun	40,015	Farr, Edwin and Levi, et al. Nut lock	39,832
Emerson, Charles M. Band saw mill	40,167	Farren, Emma. Antiseptic composition	40,513
Emerson, James E., et al. Mat	40,521	Faulds, James G. Tool for masons' use	40,308
Emery, Charles G. Air and gas compression pump	39,372	Faure, Pierre. Machine for decorticating ramie	40,077
Emery, Charles G. Engineers valve for automatic brake mechanism	39,374	Fauteux, Hercule. Washing machine	40,063
Emmens, Stephen H. Method of manufacturing explosives	39,647	Fauvel, Charles J. Furnace and method for the treatment of refractory ores	39,595
	39,648	Fawkes, Jacob H. Pocket lamp	39,453
Emmens, Stephen H. Method of treating sulphuretted ores	39,500	Fay, Thornton, E. W. Rail fastening	41,040
Emry, Charles G. Exhaust valve for automatic brakes	39,373	Febbel, Jacob, et al. Type writing machine	38,083
Emry, Charles G. Brake mechanism	39,371	Feeny, Joseph H. Sheaf carrier for harvesters	39,953
Emry, Thomas W. Chute for grain and coal	38,045	Feller, Fritz, et al. Method of painting	39,054
Emry, Charles G. Locomotive drive brakes	39,386	Fellows, Jerome B., et al. Sprinkler for lawns	39,622
Emery, James, et al. Signalling apparatus for railways	39,482	Felt, Charles A., et al. Guard for vehicle wheels	40,696
Endemann, Hermann. Process of tanning hides	40,171	Fenner, Frederick, et al. Crucible for casting dental plates	39,734
England, Frederick, et al. Holder for ballots	39,529	Fenner, Hiram Alden. Fence post	38,185
Engle, Andrew. Method of and apparatus for destroying garbage, night soil, etc.	38,783	Fergie, Charles. Car axle lubricating box	41,142
	41,337	Fergusson, John H. Method of manufacturing illuminating gas	39,650
Engler, William. Window seat	38,745	Ferguson, Arthur C. Prototype	40,803
English, Arthur B., et al. Method of treating ores	38,031	Ferguson, George, et al. Tool for dressing saws	39,082
Eno, Joseph A. Joint for railway rails	39,796	Ferguson, James O., et al. Thill coupler	38,240
Entz, Justus B. Dynamo electric machine	40,319	Ferguson, Robert. Burner and furnace for hydro carbon	39,910
Entz, Justus B., et al. Secondary battery	40,318	Ferguson, Thomas, Eugene C. and Albert L. Pump motor	40,405
Eppler, Andrew. Chain stitches for boots and shoes	40,291	Fernihough, Henry. Machine for cleaning cotton droppings	39,161
Eppler, Andrew. Machine for sewing welts to uppers	40,292	Ferns, James H. Lantern	40,604
Eppler, Andrew. Shoe sewing machine	40,210	Ferres, Jeffery T. Veneer box	40,836
Epstein, Ludwig. Electrode	38,922	Fey, Johann. Apparatus for pickling meat, &c	39,539
Epstein, Moritz. Filtering tube for molten glass	41,158	Field, Albert D. Buckle	39,198
Eriksen, Martin, et al. Lubricating device	38,144	Field, Edward. Engine to be worked by hot gases	39,363
Erlenwein, Julius. Cutting machine	39,542	Field, Edward. Steam and air motive power engine	39,469
Errington, William. Stone cutting and stone dressing machine	40,106	Field, Hiram. Pump	39,361
Esmond, William V., et al. Convertible camera and graphoscope	41,192	Field, William E. Fruit basket	40,539
Espy, James T., et al. Heating system	40,048	Fiedler, H. Bohuslov. Match box	39,000
Essick, Samuel Van Buren. Telegraphic apparatus	38,455	Fillmore, Charles D. Butter tube	38,753
Essinger, Albert, et al. Arc lamp	40,136	Finch, John Miles. Fishing rod and reel	38,858
Estey, David M., et al. Movable seat for vehicles	40,766	Fink, Elizabeth E., et al. Carrier for fruit and eggs	38,631
Etheridge, Harry. Autographic telegraph	39,753	Finley, Martin L. Plug for blasting timber	39,388
Ethier, Joseph A. Extension table	40,241	Finn, George H., et al. Electric heating apparatus	39,730
Etzkorn, Herman C. Collar for horses	39,267	Fischel, Alois B. Glove	39,685
Euchenhofer, Edward E., et al. Autographic register	38,199	Fischer, Heinrich, et al. Chocolate	38,057
Eudaly, William A. Kiln	40,794	Fischer, Frederick, et al. Drench horn	38,689
Eulanfeld, Ferdinand. Calk for horse-shoes	39,538	Fisher, Henry D., et al. Wrench	39,201
Eureka Wood pulley Company. Split pulley	40,906	Fisher, Joab C. Grain cleaning machine	38,610
Evans, Albert D., et al. Kitchen utensil	38,246	Fisher, Thomas White, et al. Breast collar	38,201
Evans, Caphas M., et al. Flour cabinet	38,778	Fitch, Arden S. Magnet electric machine for blasting	40,306
Evans, Clarence Albertus. Stretcher for trousers	38,932	Fitch, Asa M. Plow	39,214
Evans, Clark W., et al. Electric piano player	39,494	Fitch, Calvin M. Ore concentrating machine	38,494
Evans, Edwin W. Gas engine	40,428	Fitch, Francis E., et al. Generator for steam	40,311
		Fithian, Jonathan. Bottle snap	40,925

Fitz, Gerald Desmond G. Method of charging secondary batteries.....	41,111	Freeman, Richard A., et al. Sprinkler for potato vines ...	40,679
Flagg, George H. P. Boot and shoe buffing machine.....	40,792	French, Alexander B., et al. Manufacture of illuminating gas.....	39,063
Flagg, Howard W. Process of felting fur bodies.....	38,006	French, Earl B. Feed trough.....	39,159
Flagler, Harvey K., et al. Apparatus for burning liquid fuel.....	40,353	French, John McLean. Kiln for brick.....	39,192
Flagler, Harvey K., et al. Burner for vapour.....	40,140, 40,141	Fretz, Nelson, et al. Alarm.....	38,854
Flanagan, Michael, et al. Car coupler.....	39,346	Friedlaender, Heinrich. Fire escape.....	40,928
Flanders, Calvin. Washing machine.....	38,529	Friedrichs, Joseph. Art of and apparatus for crowning floor joists.....	41,400
Flanigan, Timothy. Dumping cart.....	38,211	Frings, Charles H. and Bertha O. Method of treating hops.....	40,629
Flanigan, William M., et al. Joint coupling.....	39,307	Frink, William B. Apparatus for making oil gas.....	40,755
Fleck, Marshall G. Combination rule, square and compass.....	40,185	Frisbey, Russel. Treadle for sewing machines.....	40,748
Fleischmann & Co. Separator for yeast.....	38,833	Frost, Henry. Polishing machine.....	41,434
Fleischmann & Co. Method of producing clear wort.....	38,900	Frost, John C. Machine for treating tobacco.....	40,922
Fleming, Sanford H. Clothes drier.....	39,422	Fuchs, Charles, et al. Artificial stone.....	41,255
Fletcher, Andrew Henry. Thill support.....	38,048	Fuchs, Charles, et al. Compound for making artificial stone.....	40,576
Fletcher, Andrew H., et al. Collar for horses.....	39,197	Fuller, Charles W. B., et al. Heel trimming machine.....	40,135
Fletcher, Charles, et al. Feeding mechanism for carding machines.....	40,633, 40,651	Fuller, Henry C., et al. Paint pot.....	40,848
Fletcher, George, N., et al. Machine for forging horse-shoe nails.....	40,143	Fuller, Frederick L., et al. Cash register and indicator.....	40,985
Fletcher, James S. Die stock and die.....	38,738	Fuller, Ira A. Low water alarm.....	40,840
Fleurent, Antoine. Tool holder.....	39,254	Fuller, James D., et al. Twine holder cup and take up.....	40,867
Fleury, Herbert W. Crushing and grinding mill.....	38,440	Fuller, William C., et al. Vehicle gear.....	40,562
Fleury, Herbert W., et al. Cutter for ensilage.....	39,062	Fultz, Austin, et al. Thill coupling.....	39,455
Flohr, Otto. Coupler for vehicles.....	38,430	Funk, Franz. Steam trap.....	38,763
Flower, George L. Cover for milk cans.....	40,911	Furlong, Patrick M. Method of bending electrotype plates.....	40,298
Flower, George L. Device for holding the globe in tubular lanterns.....	40,343	Furakoviec, Johann L. Apparatus for regulating the power and speed of turbines.....	40,009
Flynn, Peter Harvey. Envelope.....	38,192	Fussell, George. Governor for steam engines.....	38,615
Fogarty, Thomas B. Process of and apparatus for making fuel gas.....	40,972	Fussell, George. Valve and valve chest for steam engines.....	38,616
Foley, James S. Printing device.....	39,466	Fussell, William and George. Journal box for steam engines.....	38,658
Folsom, Andrew. Carriage wheel axle attachment.....	38,967	Fustian Cutting Machine Company. Fibre cutting apparatus.....	38,861
Folly, Cornelius A., et al. Joint coupling.....	39,307	Gabb, George. Broaching device for casks.....	38,864
Fontaine, Eugene. Actuating device for railway signals.....	40,688	Gadberry, Merrel. Neck yoke.....	38,159
Fontaine, Eugene. Time signal for railways. 40,199, 40,200, 40,200, 40,200	40,688	Gage, Henry A., et al. Chair.....	38,114
Fontaine Safety Signal Company. Actuating device for railway signals.....	40,688	Gagnon, Cyrille, et al. Door latch.....	38,648
Fontaine Safety Signal Company. Time signal for railways.....	40,199, 40,200	Gagnon, Henry F., et al. Guard for vehicle wheels.....	40,696
Foose, George C. Fire escape.....	39,424	Gaillard, Ella N., et al. Dress shield.....	39,865
Foote, Charles H. Hot blast stove.....	40,072	Gaines, George S. and Sylvester J. Car coupler.....	39,700
Forbes William. Stove.....	40,525	Gaither, Ira H., et al. Conveyor.....	38,664
Forbes, William D. Fire arm.....	39,154	Gallaher, Edward. Artificial stone.....	39,302
Forbrich, Otto, et al. Horse collar.....	40,669	Gallant, John W. Combination fence tool.....	41,147
Foreign and Colonial Arc Accumulation Company. Method of making plates for secondary batteries.....	41,307	Galopin, Henri. Apparatus for regulating the supply of liquid hydro-carbon to lamps, &c.....	39,678
Forgie, William. Wrench.....	41,194	Galpin, William Adams, et al. Harrow.....	38,898
Forrest, Hamlet E. Packing for stuffing boxes.....	38,344	Gangee, John. Apparatus for condensing or liquefying vapours or gases.....	38,209
Forsythe, John H. Scale for weighing grain.....	39,854	Gaquin, Thomas, et al. Sewing machine.....	40,683
Fosket, William A., et al. Ammunition belt.....	40,275	Garbutt, Hiram J., et al. Jack.....	40,994
Fosket, William A., et al. Gun.....	40,276	Gardner, James Patterson. Sash cord fastener.....	38,914
Foster, Charles F., John M. and Langdon C. Sharpener for knives.....	41,113	Gardner, Jefferson M. Delinting cotton seed.....	41,413
Foster, Charles J. Pulp screening machine.....	41,200	Gardner, John, et al. Process of refining hydro-carbon oil.....	40,801
Foster, Charles W. Steam generator.....	38,491	Gardner, William F. Method of synchronizing clocks and transmitting time signals.....	39,463
Foster, Frank, et al. Nut lock.....	39,121	Garfield, John M., et al. Keel for vessels.....	39,461
Foster, William. Machine for moulding butter.....	39,735	Garland, Frank M., et al. Ammunition belt.....	40,275
Foster, William R. Pneumatic tyre.....	41,297	Garland, Frank M., et al. Gun.....	40,276
Foulds, Thomas, et al. Receiver for exhaust steam.....	39,864	Garland, Frank M. Magazine gun.....	40,217
Fowell, Henry. Cooler and aerator for milk.....	38,394	Garland, George A. Bed.....	40,786
Fowler, Frank G. Process of protecting steam boilers.....	40,737	Garland, Milton H. Can for holding petroleum.....	38,037
Fowler, Joseph C. Merry-go-round.....	40,443	Garlick, Edward C. Alarm knob.....	38,739
Fowler, Joseph C., et al. Spacer for type matrices.....	39,305	Garnett, Charles J., et al. Time recorder.....	39,253
Fowler, William M. Apparatus for dispensing liquids.....	40,017, 40,264, 40,288	Garnier, Jules. Method of treating mats.....	40,053
Fowler, William M. Method of recording liquid measures.....	38,527	Gartner, Alfred. Gum moistener.....	39,830
Fox, Frank A. Car coupler.....	41,149	Garrett, John W. and George P. Hydraulic motor.....	39,891
Fox, James S. Tie plate for railroads.....	40,873	Garrett, Lincoln B., et al. Sharpener for lawn mowers.....	38,409
Fox, James W., et al. Signal for electric railways.....	40,109	Gasking, Alfred J. Driving belt.....	40,926
Fox Solid Pressed Steel Company. Truck.....	40,807	Gassaway, John H., et al. Rotary plough.....	39,255
Fox, William A., et al. Meter for grain.....	39,520	Gassen, Paul. Process of preserving wood.....	41,270
Foxwell, John B., et al. Pulsating steam pump.....	38,418	Gassen, Paul, et al. Method and apparatus for producing plastic ornaments on profile borders, &c.....	39,578
Francis, Albert L., et al. Sheet iron pipe for stoves and water.....	39,803	Gasser, Sanford. Cultivator.....	39,597
Frankenback, Simon. Glove.....	39,351	Gates, Fannie A. and Eugene N. Hot water heating system.....	40,315
Franklin, John J., et al. Handle for caskets.....	39,789	Gates Iron Works. Ore concentrator.....	39,050, 38,809
Franks, Orrin G., et al. Machine for weaving wire mattresses.....	40,809	Gates James. Ironing board.....	38,809
Frasch, Herman. Method of distilling petroleum.....	41,042	Gates, John N. and Eugene N. Heating apparatus.....	39,213
Frasch, Herman. Method of treating petroleum for removing sulphur compounds.....	41,043	Gates, Ryerson Dudley. Ore concentrator.....	39,050
Frasch, Herman. Process of refining petroleum.....	38,071	Gates, Ryerson Dudley. Stone crusher.....	38,848
Fraser, John. Fertilizer distributor.....	40,299	Gasfield, James, et al. Window fastener.....	38,901
Fraser, John W., et al. Pump.....	39,177	Gaudrie, Francis X. Can labelling machine.....	40,927
Fraser, Rena A., et al. Machine for preparing flax, &c.....	40,076	Gauvreau, Adalbert. Method of preparing medicinal oils.....	38,625
Fraser, William. Water trough for horses and cattle.....	38,624	Gay, William A. Toy.....	40,544
Fraser, Daniel A., et al. Reversing gear for steam engines.....	38,058	Gebhardt, Henry J. Fence machine.....	40,749
Frederking, Theodor, et al. Vessel for cooking, smelting and evaporating.....	39,651	Gebhardt, Julius F. Machine for turning mouldings.....	38,154
Frederksen, John D. Method of making cheese.....	40,520	Geddes, John H., et al. Sheep shears.....	39,749
Fredlipp, Joseph L. Suspender.....	40,519	Gelabert, William P., et al. Loop for harnesses.....	39,125

General Patents Company. Receptacle for coins.....	39,369	Gottwals, William O., et al. Letter or bill file 38,687, 40,300,	41,441
Genese, David. Mute for musical instruments.....	40,219	Gould, Charles A. Car coupler.....	38,769
Genin, John B., et al. Extension ladder.....	40,569	Gould, Wallace W. Corset.....	38,803
Gentle, Norman. Composition for biscuits.....	39,018	Gouden, Samuel, et al. Door bell.....	40,404
George, Carl Gustave. Transposing piano action.....	38,441	Gowen, William. Offset for saw-mill carriages.....	39,743
George, Charles J., et al. Machine for ruling, perforating,			39,744
printing, numbering and severing web paper.....	39,536	Grabe, Gustave H., et al. Holder for copy.....	40,097
George, Kurtis K., et al. Saddle support for bicycles.....	39,309	Graeber, William, et al. Receiver for exhaust steam.....	39,864
Gerard, Jean M. A. Desiccation of peat.....	39,569	Graetzer, Otto, et al. Process of manufacturing ornaments	
Gerike, Franz, et al. Stopper for bottles and jars.....	38,443	on wooden blocks, &c.....	39,579
Gerike, Hugo, et al. Stopper for bottles and jars.....	38,443	Graf, Bernhard, et al. Process of producing ozone water	
Germain, Etienne. Cough syrup.....	38,041	and oil.....	38,407
Gerred, Edward. Draft regulator for stove pipes.....	39,852	Graf, Robert R., et al. Oil.....	38,133
Gerry, James H., et al. Secondary battery.....	40,386	Grafton, Edwin W. Paint.....	38,562
Gerry, Long, Manufacturing Company. Secondary battery		Graham, Charles F. Band cutter and feeder for threshing	
Gese, Max. J., et al. Screw driver.....	40,386	machines.....	40,573
Getz, William R., et al. Car coupler.....	38,960	Graham, George M. Artificial stone.....	40,518
Gibbins, James. Hoisting apparatus.....	40,132	Graham, George M. Building or paving block.....	40,835
Gibbon, Catherine L. Method of constructing street rail-		Graham, John, et al. Crane.....	39,638
way tracks.....	38,599	Graham, Simon P. Lawn mower.....	40,296
Gibbs, William, et al. Digger.....	40,699	Graham, William, et al. Wringer for mops.....	40,698
Gibney, John, et al. Pill machine.....	40,502	Gram, Benjamin F., et al. Nut lock.....	38,613
Gibson, Gerolt. Sash lock.....	38,893 38,894	Grandmont, Caleb. Disk harrow.....	40,806
Gibson, Jasper. Bell buoy.....	40,510	Granville, Algernon, et al. Spike.....	38,337
Gibson, Thomas. Printing and book binding machinery.....	39,091	Granville, Algernon, et al. Type writer.....	39,152
Giddens, Abraham. Tenoning machine.....	40,250	Grant, Arthur L., et al. Method of treating ores.....	38,745
Gieger, John Joseph, et al. Roofing.....	39,224	Grant, Arthur L. Plaster.....	39,256
Giessenbier, Henry. Valve.....	39,047	Grant, Daniel. Car coupler.....	40,433
Giffard, Paul. Apparatus for charging metallic cartridge		Grant, David A. Land roller.....	41,185
cases with gas, and for making said cartridges.....	39,489	Grant, Frank, et al. Ferrule.....	38,673
Giffard, William. Mechanism for stopping and starting		Grant, James, et al. Sash lock.....	38,249
vehicles.....	39,642	Grantland, John W. Method of and apparatus for the	
Gifford, Charles, et al. Wringer for mops.....	38,611	transmission of currents through conduits.....	40,283
Gilbert, Edward T., et al. Screw cutting and pointing		Grath, Walter Paul. Brick kiln.....	39,002
machine.....	38,837	Graveley, Wm. Robert. Thread separator for ring spinning	
Gilbert, Henry J. Pulley.....	41,060	frames.....	38,889
Gilbert, John I. Electric forging machine.....	38,860	Graveline, David U. Car coupler.....	38,222
Gilchrist, Gordon. Trap for Gophers.....	38,182	Graves, Erwin, et al. Crane.....	39,638
Gillilan, Essington N. Car seat.....	40,868	Graves, John. Heater.....	41,323
Gill, Elisha A. Sifter and measure for flour bins.....	40,460	Graves, John C., et al. Railway construction machine.....	40,290
Gillies, Alexander, et al. Street broom.....	40,672	Graves, Richard H. Key wedge for easels.....	38,961
Gillies, Alexander, et al. Sweeper for streets.....	40,260	Graves, William D., et al. Arc lamp.....	40,289
Gilliland, James F. Box making machine.....	38,755	Gray, George A. Spoon.....	38,027
Gillman, Ed. H., et al. Car coupler.....	40,387	Gray, William. Coin controlled apparatus for telephones.....	40,139
Gilman, Charles C. Underground conduit for electric		Gray, William. Signal for telephone pay stations.....	39,093
wires, &c.....	40,025	Green, Alem J., et al. Tyre set.....	39,370
Gilman, William H. Electrically operated stringed musical		Green, Bruce. Coin operated sight testing apparatus.....	40,821
instruments.....	39,432	Green, Charles. Switch for electric lights.....	41,176
Gilmore, Ira F. Musical instruments.....	39,189	Green, George E., et al. Memorandum book.....	38,295
Girey, John. Car coupler.....	39,380	Green, Robinson W. Lubricator.....	38,799
Githens, Joseph C. Rock drill.....	41,096	Greene, Francis V., and Mary A. Window.....	39,053
Githens, Joseph C. Rock drill and channeling machine.....	41,095	Greene, Henry S., and Thomas H. Gigging and shearing	
Givens, James R., et al. Turner for music leaves.....	38,518	machine.....	40,052
Gladman, Charles. Runners for wheeled vehicles.....	41,317	Greene, William F., et al. Camera.....	39,475
Glaser, Charles. Process of manufacturing phosphoric acid		Greenfield, Edwin T., et al. Process of impregnating porous	
glass, Albert J. Disk harrow.....	38,335	bodies.....	38,764
Glass, James A. and Ida. System of cutting clothing.....	39,841	Greenwood, James. Apparatus for manufacturing chlorine	
Glass, Kallmann, et al. Bath tub.....	38,574	and caustic soda.....	39,524
Glass, Louis. Phonographic attachment.....	38,420	Greer, Howard. Machine for making spikes and nails.....	40,268
Glass, Shelden J. Disk harrow.....	41,150	Gregg, John Allen. Hydrant.....	38,141
Glover, George T. Traction engine.....	39,846	Gregg, William T., et al. Door.....	40,153
Goddard, William. Gate for draw bridges.....	39,877	Gregory, Charles A. Musical instrument.....	39,238
Goddou, Louis. Nail making machine.....	40,882	Gregory, Fred. L. Block.....	39,628
Godsal, Philip T. Breech loading small arms.....	38,390	Gregory, Thomas, et al. Sash and sash frame, for windows.....	39,476
Goehring, Charles L. Moulding machine.....	40,092	Greig, George W. Ventilator.....	41,403
Gohl, Christian H., et al. Car coupler.....	40,977	Grieser, Louis H. Grain binder.....	40,553
Gold, Edward E., et al. Coupling for hose.....	38,954	Griffith, David D. Oil generator and heater.....	38,964
Gold, Edward E. Drainage trap for steam pipes.....	41,274	Griffith, Joseph H., et al. Heating system.....	40,048
Goldman, Edward, et al. Muff bed.....	40,350	Grimes, James C., and Reuben H. Nut lock.....	38,785
Goldstein, Adolph, Bernard and Jacob. Cigarette making		Grimwood, Charles, et al. Electric battery.....	39,624
machine.....	40,695	Griswold, George M. Button setting machine.....	41,072
Goldstein, Bernard. Method of branding cigars.....	40,685	Griswold, George H., et al. Cash register and indicator.....	40,985
Good, Leander D. Smoothing iron.....	41,119	Groat, Louis W., et al. Leggings.....	40,317
Goodell, Alfred P. Potato digger.....	38,502	Gronwald, Johann F. H., et al. Apparatus for sterilizing	
Gooding, Charles S., et al. Lasting machine.....	39,270	milk.....	38,569
Goodlet, George. Machinery for compressing and accumu-		Gronwald, Johann F. H., et al. Machine for sterilizing	
lating air and water.....	38,105	and drawing off liquids.....	38,567
Goodman, John E. Tongs for lifting and handling ice, &c.		Gronwald, Johann F., et al. Sterilizing apparatus.....	38,568
Goodnight, Charles, et al. Tyre heater.....	41,159	Groshon, John A. Steam engine.....	39,336
Goodwin, Nelson. Machine for cutting, trimming and prun-		Gross, Ferdinand. Receiver for telephones.....	38,043
ing trees and hedges.....	39,821	Grossmann, Morris. Machine for cutting cloth.....	38,194
Goold (E.L.) & Co. Honey extractor.....	49,395	Grothgar, John, et al. Keel for vessels.....	39,461
Gordon, Charles H. Method of producing lithographic		Groat, Charles H., et al. Clothes pin.....	38,768
stippling.....	41,234	GuckertWilliam, et al. Steam generator.....	39,577
Gordon, Alonzo J. Grate.....	38,395	Guelich, Otto E. C. Process of laying artificial stone.....	38,232
Gorden, Harry B., et al. Match box.....	39,037	Guelich, Otto E. C. Process of manufacturing artificial	
Gordon, John, et al. Ore concentrator.....	39,421	stone.....	38,437
Gordon, William M. Baggage truck.....	40,004	Guignard, Gaston. Process of making and preserving pure	
Gorham, Jennie, et al. Cut off valve and gear.....	39,448	yeast.....	40,493
Gorsuch, George W., et al. Wrench and cutter for pipes.....	39,124	Guilbert, John Murray. Hook for garments.....	39,095
Gorton, Robert. Wire cleat.....	39,064	Guillaume, Theodore. Electric cable.....	39,696
Gosselin, Honoré, et al. Moulding machine.....	38,453	Guillaume, Theodore. Wire.....	40,537
Gosselin, Pierre O. Hydraulic motor.....	39,393	Guilick, Ashley J., et al. Knitting machine.....	41,298
	38,193		

Gundlack, Alexander E., et al. Wrench.....	38,605	Harris, Alanson. Lawn mower.....	40,296
Gurney, Edward. Hot water heater.....	40,567	Harris, Alfred E. Lamp.....	38,370
Gurthar, Gustav. Holder for candles.....	39,315	Harris, Charles E. Horse attaching and detaching device.....	41,336
Gustafson, John. Type composing machine.....	41,436	Harris, Charles R. Suspender.....	38,810
Gustin, Frank M., et al. Device for cleaning cisterns.....	41,394	Harris, Edwin E., et al. Collar for horse.....	39,197
Haas, Johannes, et al. Sewing machine.....	40,485	Harris, Ernest A., et al. Gas condensing and enriching apparatus.....	39,755
Haas, John E., et al. Regulator or governor for gas.....	38,188	Harris, Fred., et al. System of electrical distribution.....	41,299
Haas, Samuel Henry. Shaft tug.....	38,935	Harris, George W. Anvil vise.....	39,114
Hadden, Harvey. Ear muff.....	41,056	Harris, George W. Heater.....	39,707
Hadstate, Hoyte C., et al. Numbering machine.....	41,256	Harris, James F., et al. Process of refining hydro-carbon oil.....	40,801
Hagerty, John H., et al. Circular knitting machine.....	38,721	Harris, Robert Lewis. Foundations.....	38,968
Hagerty, John H. Water motor.....	39,574	Harris, Samuel E. Car coupler.....	38,828
Hagemann, Otto C., et al. Apparatus for concentrating spent soap lye to recover salt and glycerine therefrom.....	40,703	Harris, (A.) Son & Co. Harvester binder.....	38,063
Hagemann, Otto C., et al. Apparatus for distilling glycerine recovered from soap lye.....	40,732	Harris, Thomas C. Nut lock.....	39,783
Hagemann, Otto C., et al. Apparatus for obtaining salt and crude glycerine from spent soap lye.....	40,706	Harrison, Frank B. Sectional dust guard for car axle journals.....	38,530
Hagemann, Otto C., et al. Apparatus for purifying salt recovered from spent soap lye.....	40,705	Hart, Charles E. Link for drive chains.....	38,750, 38,751
Hagemann, Otto C., et al. Method of making glycerine from spent soap lye.....	40,708	Hart, Harriet A. Oil can.....	38,726
Hagemann, Otto C. Method of purifying glycerine.....	40,704	Hart, Hulbert C. Spoon and fork.....	38,040
Hahn, Anton. Machine for measuring, winding and cutting off lengths of cloth.....	39,698	Hart, William A. Foot power fan.....	40,663
Haines, Fred A. Lid for car axle boxes.....	38,166	Hart, William Henry. Hook for garments.....	39,095
Haines, Robert D., et al. Process of plating clay with glass.....	40,869	Hartigan, James B. Exhaust pipe for locomotives.....	41,175
Hair, Josiah Taylor. Duster.....	38,091	Hartman, Charles J. Storage battery.....	41,169
Hall, Albert F. Pump.....	40,235	Harty, William, et al. Envelope machine.....	41,151
Hall, Confran I. Valve for elevators.....	39,022	Hartstein, Ernest. Canules for tracheotomy.....	41,215
Hall, Horace Leonard. Shade holder.....	38,212	Harvey, Charles A. Fastening for shoes.....	38,650
Hall, James B., et al. Propelling power.....	39,295	Harvey, Frank, et al. Car coupler.....	38,820
Hall, James T. Cattle guard.....	40,381	Hasbronck, Frank M., et al. Auxiliary base for stoves.....	40,932
Hall, Lee. Fastener for storm sashes and window screens.....	39,162	Hasbronck, Julian A. H. Process and apparatus for ageing liquors.....	38,038
Hall, Levi Lewis. Faucet.....	38,314	Hastings, John B., et al. Machine for making nails.....	40,503
Hall, Thomas, et al. Screw.....	38,780	Hatch, Willis, et al. Lifting jack.....	40,029
Hall, William Fremont. Ink bottle.....	38,875	Hathaway, Edgar F. Machine for manufacturing wire fence strands.....	39,241
Hallenstein, Reuben. Fire-proof door.....	40,091	Hatfield, Lyman. Can or jar for packing purposes.....	39,341
Hallett, William W. Device for instructing in reading and calculating.....	38,532	Hatschek, Berthold. Skate.....	39,583
Halley, Eugene W., et al. Portfolio for collars and cuffs.....	39,061	Hattenbach, Michael, et al. Revolving fortification for coast defence.....	41,416
Halligan, Frank. Car door fastener.....	39,060	Haugh, Benjamin F. Cushioned car wheel.....	38,275
Hallowell, Joel H., et al. Sheet iron pipes.....	39,803	Haultain, Terrick G., et al. Drag saw rail cutting machine.....	38,804
Hale, Philip. Game counter.....	41,392	Haven, Albert C. Disinfecting and deodorizing apparatus.....	38,683
Halsey, Frederic A., et al. Air compressor.....	41,094	Haviland, Charles A. Fish hook.....	39,382
Haley, Fred H., et al. Book case.....	40,626	Hawken, Frank. Desk.....	39,122
Halsey, Frederick Arthur. Drill chuck.....	40,627	Hawkins, William and Thomas. Fluid for generating motive power.....	39,739
Halsey, Frederick A. Pneumatic pump.....	40,398	Hawley Furnace Company. Furnace for steam boilers.....	40,297
Halsey, Frederick A. Valve for pumps.....	39,401	Hawley, Melville C. Furnace for steam boilers.....	40,297
Hamble, Anthony. Clamp for bed clothes.....	41,139	Hawley, Robert C. Ore sampling device.....	39,717
Hamilton, James A. and Bethnel R. Churn.....	41,069	Hay, Archibald. Loom for weaving cane, &c.....	38,413
Hamilton, Frank C. Game.....	38,533	Hay, James. Carving machine.....	41,082
Hamilton, George W. Operator for transoms.....	39,404	Haydon, Walton. Art of casting metals.....	40,084
Hamilton, Silas H. and Manian. Method of and apparatus for utilizing the force of waterfalls.....	39,926	Hayes, Will Linton, et al. Apparatus for treating wire.....	39,011
Hammelmann, Charles. Horse-shoe.....	39,087	Haynes, Richard, et al. Spool.....	38,034
Hammond, Austin, William R. and Oliver S. Car coupler.....	40,112	Hazard, Frederick J. H. Bicycle.....	39,543
Hammond, William L., et al. Conveyor.....	38,664	Hazelton, Elias, et al. Electrical underground systems of street car propulsion.....	38,442
Hammond, Walter J., et al. Ore concentrator.....	40,004	Heard, James, et al. Fence tool.....	41,233
Hamrick, Graham H. Method of embalming.....	41,090	Heard, Thomas. Car coupler.....	41,061
Hanchett, John. Saw swage.....	38,357	Heath, Abel G., et al. Spring motor for screw propellers.....	40,069
Hance, Milton T., et al. Rotary plough.....	39,55	Heath, Alfred R. Car coupler.....	38,997
Hand, Thomas W., et al. Signal for vessels.....	40,082	Heath, Edwin, et al. Parlour and sleeping car.....	38,176
Hane, Urban H. Joint for railway rails.....	40,571	Heath, Henry. Method of and apparatus for displaying advertisements.....	38,308
Hangsterfer, John W., et al. Safety gate for bridges.....	41,041	Heath, Frederick H. Rail joint.....	40,189
Hanisch, Carl. Stopper for bottles.....	41,401	Heath, Thomas T., et al. Typographic machine.....	41,263
Hanlon, John R. Surveyors' instrument.....	40,244	Heathfield, Richard. Process of and apparatus for coating and cleaning metals.....	40,584
Hanna, Michael. Saw mill dog.....	41,145	Heaton, E. S., et al. Shifting rail for carriages.....	40,399
Hanna, Robert, et al. Lamp.....	39,680	Heckert, William. Gas engine.....	39,759
Hannum, Henry A. Cutter for green bone.....	39,398	Heckhausen and Weies. Method of and apparatus for producing plastic ornaments or profile borders, &c.....	39,578
Hanrahan, Joseph F. Refrigerator building.....	38,132	Heekenlooper, Andrew. Charger for gas retorts.....	40,789
Hanrahan, Joseph F. Road locomotive.....	38,844	Hees, (George) Son & Co. Clip for window blinds.....	40,855
Hanson, Dempsey B. Side dresser for swage saw teeth.....	38,313	Heeson, William H. Self-feeding ratchet brace.....	41,283
Hanton, Alexander, et al. Lawn mower and trimmer.....	40,859	Hein, John, et al. Cover for desks.....	39,845
Hard Bros. & Company. Machine for weaving wire mattresses.....	40,809	Hebard, Charles S. Landing net.....	38,267
Hard, Charles H., et al. Machine for weaving wire mattresses.....	40,809	Hebdon, William. Cloth finishing machine.....	38,393
Hardesty, Frank M., et al. Flood gate.....	38,435	Hebron, Charles B., et al. Ore concentrator.....	39,965
Harding, Philip A. Lever track jack.....	39,049	Hedgeland, Frederick W. Clutch for organ pipes.....	38,590
Hardy, Dexter D., et al. Steam engine.....	40,212	Hedgeland, Frederick W. Folding key boards for organs.....	38,591
Hardy, Franklin D., et al. Steam engine.....	40,212	Hedgeland, Frederick W. Mitre clamp.....	40,743
Hardley, John. Band saw machine.....	39,903	Heffelfinger, Elmer. Chase for printers.....	40,831
Harrison, William B. Blank for book cover protectors.....	39,333	Helgenstock, Gustav. Method of separating sulphur from sulphurous pig iron.....	39,155
Harley, James. Attachment for wool carding machines.....	41,199	Helwig, John. Butter for bolts and rivets.....	38,259
Harlow, Michael B., et al. Washstand.....	39,634	Hemenger, Arthur. Diving armour.....	41,006
Harmer, Edward. Advertising medium.....	40,545	Hemming, Frederic S., et al. Holder for bags.....	38,542
Harmon, Charles S. Lathe.....	40,054	Henderson, David S. Pitman.....	38,640
Harness, Cornelius B. Electrical apparatus for surgical and dental chairs.....	40,893	Hendrickson, Loren E. Vaginal syringe.....	40,249
Harnsberger, Audley E. Type writer.....	41,439	Henneberg, Wilhelm, et al. Separator for granular material.....	38,236
Harrell, Albert S., et al. Calendar and stamp holder.....	38,564		

Henning, Julius. Scales.....	39,769	Hoff, Peter, et al. Car coupler.....	40,387
Henry, Archie James. Coin vending machine.....	38,841	Hoffmann, Ernest G. Caster.....	38,187
Henry, Jesse L., et al. Car coupler.....	38,060	Huffman, Gustav. Potato planting machine.....	43,825
Henry, John. Lever track jack.....	39,049	Huffman, Paul Max. Sole or sock for boots.....	38,975
Henry, John. Meter for grain.....	39,520, 41,144	Hoffman, William D. Magnetic separator.....	40,509
Henry, William. Generator for electricity.....	39,969	Hoffmeier, Amos R. Tie for railroads.....	39,521
Henshaw, George H. Breakwater.....	40,870	Hogan, Daniel, et al. Gate latch.....	40,883
Hepner, John. Art of making brushes.....	39,265	Hogarth, James. Apparatus for testing and recording the test of flour and dough.....	39,303
Heppenstall, Law. Gas tap.....	40,094	Hogarth, James. Method and means of testing and recording the properties of flour and dough.....	39,222
Herbert, Michael E. Furnace for steam boilers.....	39,439	Hoglen, George W. Fire extinguisher.....	39,149
Herbold, Philip. Folding bed.....	39,055	Holden, William H. Kettle.....	38,614
Herchenbach, Paul, et al. Hot air furnace.....	39,512	Holdenby, Charles Norman. Key hole guide.....	38,930
Herdman, Wm. James. Electro-therapeutic apparatus.....	39,037	Holler, John M. Gear for vehicles.....	40,784
Heroux, George P. O. Attachment for musical instruments having key boards.....	38,171	Holley, Clarence E. Vehicle running gear.....	39,209
Herr, Clarence M., et al. Extension table.....	39,420	Holland Radiator Manufacturing Company. Radiator.....	39,897
Herrenschmit, Henry L. Treatment of nickel and copper ores without cobalt.....	38,710	Holland, Timothy. Radiator.....	39,897
Herrick, Harrison E., et al. Chain.....	38,114	Hollar, Gordon C. Rotary engine.....	38,410
Hersey, Charles, et al. Lock.....	39,017	Hollinger, Isaac K. Wire fence.....	38,217
Hershberger, Joseph W. Catch basin for sewers.....	40,042	Holme, Eric W. H. Holder for demijohns.....	38,452
Hervien, Gaston, et al. Mechanism for driving machines by foot power.....	41,089	Holmes, John B. Holder for twine.....	39,880
Hesketh, Everard, et al. Refrigerator.....	41,196	Holmes, Philip H. Conductor for electricity.....	39,352
Heskier, Peter. Device for obtaining voltaic effects.....	39,618	Holmes, Philip H. Projectile.....	38,746
Heslop, Matthew. Apparatus for feeding paper to printing presses.....	39,960	Holmes, Waldo E., et al. Weighing scales and register.....	41,152
Heslop, William. Machine for manufacturing boats.....	39,498	Holmes, Watson M. Grain binder.....	39,714
Hess, Amos M. Top joint for vehicles.....	41,078	Holroyd, Thomas, et al. Lamp.....	39,680
Hess, Edwin C. Receiver for telephones.....	39,956	Holt, Benjamin, et al. Knitting machine.....	39,868
Hesser, Albert A. Foot warmer.....	38,392	Holt, Charles C., et al. Screw.....	38,780
Hessler, Jacob R. Organ.....	39,170	Holt, Fred W. Meter for fluid.....	40,187
Hetzler, Otto. Floor.....	39,706	Holt, Samuel T. H. Chimney.....	38,602
Hewitt, Ernest M. G. Electric motor.....	40,614	Honiss, William H., et al. Bag.....	38,707
Heyerdahl, Peter M., et al. Process of manufacturing cod liver oil.....	38,234	Hood, Thomas John. Boot and shoe.....	38,087
Heys, William G., et al. Pneumatic tyre.....	41,296	Hooker, Charles A., et al. Lifting jack.....	40,029
Hidden, Thomas B. Sheet metal can.....	40,044	Hooker, John Joseph. Power brake for railway cars.....	39,092
Hiestand, Charles C. Cultivator.....	40,785	Hooper, William J. Machine for making nets.....	41,379
Higby, Luther Leroy. Card for hotel rooms.....	39,078	Hooton, Henry W., et al. Brake.....	40,812
Higginbottom, James. Separator.....	39,318	Hopkins, Nicholas J. Car coupler.....	41,029
Higginbottom, James. Separator for granular materials.....	39,317	Hopper, George B. Can.....	40,284
Higgins, Chas. L., et al. Overstocking.....	38,851	Hopper, John L. Roaster, smelter and separator for ore.....	38,535
Higgins, Joseph C., et al. Calk for horse-shoes.....	39,354, 38,051	Horne, Chester, et al. Printer's galley.....	40,506
Hilbert, Calvin H. Corn cultivator.....	38,747	Horne, Samuel E., et al. Printer's galley.....	40,506
Hildebrandt, Edwin S. Muffler for steam.....	39,429	Horner, Gustav. Steam surface condenser.....	39,545
Hill, George, et al. Meter for grain.....	39,520	Horrie, David, et al. Frog and switch for railways.....	38,836
Hill, Harry W. Friction clutch.....	39,485	Horton, Emmet, et al. Generator for steam.....	40,311
Hill, Henry W., et al. Improvements relating to nuts for screwed bolts, &c.....	38,519	Horton, Herbert. Vehicle wheel.....	38,533
Hill, John, et al. Method of constructing ingot moulds.....	39,990	Hough, Samuel. Frame for stretching fabrics.....	39,268
Hill, Lydia B. B. Desk and easel.....	38,793	Hough, Walter J. Track for railways.....	39,146
Hill, William H. Gold concentrator.....	40,593	Houle, Amedée. Vehicle.....	38,230
Hill, William H., et al. Burner for gas or oil.....	40,940	Housam, John, et al. Bee hive.....	40,999
Hill, William H., et al. Gas-making apparatus.....	40,939	House, Isaac M. Saw-filing machine.....	39,872
Hill, Gustave L., et al. Machine for colouring and ornamenting india rubber balls.....	40,890	House, Jonah J. Machine for basking, notching and stamping bread.....	39,652
Hiller, Theodor. Bung.....	39,682	House, Joseph L., et al. Axle nut for vehicles.....	41,017
Hilton, John, et al. Woven fabric.....	38,859	Houston, David H. Roll holding photographic apparatus.....	39,339
Hilts, George S. Pipe wrench.....	41,224	Howard, Charles. Method of drying and vulcanizing wood.....	38,238
Hirnebaugh, Adelbert C., et al. Planter for corn.....	41,108	Howard, Charles DeZang. Draft regulator.....	38,737
Himmel, Robert. Method of producing fancy figured wooden plates.....	39,690	Howard, Charles DeZang. Ventilating and heating apparatus.....	38,552
Hinckley, Howard. Brake for railway cars.....	39,228	Howard, Henry. Heating and welding by the electric arc.....	38,626
Hine, Lemon G., et al. Spacer for type matrices.....	39,305	Howard, Henry, et al. Multiplex stamping machine.....	38,541
Hinkel, Edwin, et al. Table.....	39,038	Howard, John. Joint for flexible shafting.....	39,741
Hinson, James A. Car coupler.....	38,109	Howard, John. Paddle wheel.....	38,974
Hipwill, Thomas. Hanger for lamps.....	39,892	Howard, John, et al. Sheep shears.....	39,749
Hipwill, Thomas. Indicator for liquid measures.....	39,893	Howard, Matthew N. Machine for treating leather.....	40,779
Hipwill, Thomas. Lamp.....	39,896	Howard Thermostat Company. Draft regulator.....	38,737
Hirsche, Edward, et al. Stopper for bottles and jars.....	38,443	Howard, William H. Stocking.....	40,875
Hirsh, Sampson, et al. Pouch for tobacco.....	41,107	Howatt, David E. Sectional water heater.....	40,579
Hitch, John E., et al. Boring machine.....	40,164	Howcutt, John. Car coupler.....	40,744
Hoad, Edwin A., et al. Weighing machine.....	40,497	Howe, William A. Earth auger.....	40,133
Hockhausen, William. Arc lamp.....	39,940	Howell, John C. Apparatus for use in obtaining copper.....	40,655
Hockhausen, William. Dynamo electric machine.....	39,271	Howell, John C., et al. Apparatus for making wire.....	39,729
Hocken, Richard, et al. Cheque book.....	38,586	Howell, William H. Apparatus for making bi-sulphide of lime.....	39,593
Hodges, Addison S. Flask for making seamless sash weights.....	40,609	Howell, William H. Digester for pulp.....	39,594
Hodges, Horace F. Pump.....	40,802	Howell, William J. Apparatus for producing indented type impressions upon paper.....	41,327
Hodgetts, James Frederick. Method of constructing the hulls of vessels.....	38,039	Howenstine, John. Box and box making machine.....	39,032
Hodgkinson, Thomas C., et al. Coil and battery for electro medical apparatus.....	40,049	Howle, George B., et al. Calendar and stamp holder.....	38,564
Hodgson, Charles, et al. Method of constructing ingot moulds.....	39,990	Hoyer, Frank F. Car coupler.....	38,406
Hodsdon, Charles F. Booth.....	38,642	Hoyer, Margaret. Baby walker.....	41,318
Hoefler, Adolph, et al. Axle.....	39,009	Hoy, Henry S. Hay rack.....	39,605
Hoeltzes, Henry. Method of operating gas engines.....	40,169	Hoyt, Matthew L. Churn.....	39,858
Hoerle, William M. Wick raisers for central draft lamps.....	39,895	Hubbard, Frederick J., et al. Pocket tobacco case.....	39,732
Hoey, David G. Method of and apparatus for tapping pipes, drain sewers, &c.....	40,157	Huber, John P. Seat for vehicles.....	38,637
		Hubner, Emil. Machine for threading bolts.....	40,155
		Hubner, Oscar M. Game.....	40,067
		Hudson, John C., et al. Axle gauge.....	38,577
		Huff, Andrew D., et al. Revolving fortifications for coast defence.....	41,416
		Huffmann, Henry C., et al. Gate catch.....	40,883
		Hughes, Edward W. M. Car coupler.....	38,765

- Hughes, Samuel. Method of ventilating and heating railway carriages. 38,522
- Hughes, Samuel. Method of ventilating railway carriages. 38,523
- Hughton, Arthur A., et al. Process of plating clay with glass. 40,869
- Hull, Wolcott A. Machine for shaping plastic and similar material. 38,670
- Hull, Wolcott A. Press. 38,540
- Hulse, William A. Cigarette machine. 39,191
- Hummel, August. Manufacture of beer. 39,199
- Hummel, Franklin P., et al. Mechanical movement. 39,791
- Humphrey, William, et al. Knitting machine. 41,298
- Hungerford, William A. Method of opening cans. 39,708
- Hunt, Charles B. Sewing machine. 39,467
- Hunt, Charles F. Car coupler. 40,172
- Hunt, John H. Sifter for cinders. 39,913
- Hunt, Julius F., et al. Fruit box. 40,941
- Hunt, Ozello R. Spring mattress. 38,214
- Hunter, Alexander G., et al. Plow. 38,165
- Hunter, George D. Crimper for cartridge shells. 38,866
- Huntington, Charles W. Electric switch and cutout. 40,448
- Huntress, John H. Metal post. 39,400
- Hurlbut, Samuel C. Typewriter. 40,829
- Hurley, Robert E. Track laying machine. 40,023
- Hurteau, Stephen. Wood working machine. 41,405
- Huss, Rudolph W. Pneumatic tyre. 41,352, 41,353
- Hussey, Silvanus. Wrench. 38,492
- Hutchison, Robert. Lubricant. 38,307
- Hutchison, Thomas J. Apparatus for removing grease from textile fabric. 41,300
- Hutt, James W., et al. Machine for manufacturing paper boxes. 39,368
- Hynes, Martin. Switch for railways. 38,773
- Hynes, Michael, J. Kiln. 39,192
- Ide, Henri G., et al. Key fastener. 38,328
- Ide, Henri G., et al. Stove pipe and collar fastener. 38,327
- Improved Zigzag Grate Bar Company. Grate bar. 38,419
- Ingalls, Allen G., et al. Clothes drier. 39,422
- Ingalls, Mason B., et al. Crucible for casting dental plates. 39,734
- Ingalls, Allen G., et al. Game. 38,248
- Ingersoll, Charles Francis, et al. Switch tongue adjuster. 38,903
- Ingersoll, Harley, et al. Electrical underground system of street car propulsion. 38,442
- Ingham, Stephen, et al. Machine for sorting and separating substances. 40,471
- Ingraham, Arthur Joseph, et al. Shaft tug. 38,935
- International Type Telegraph Company. Printing telegraph receiving instrument. 39,052
- Ireland, Sarah E. Soap. 40,635
- Irion Adjustable Whiffletree Co. Whiffletree. 39,451
- Irion, John H. Whiffletree. 39,451
- Irish, William E. Arc lamp. 40,524
- Irvin and Kepner. Velocipede. 39,836
- Irwin, Charles H., et al. Boring machine. 40,164
- Irwin, George B. Potato digger. 39,066
- Irwin, Samuel, et al. Plow. 38,165
- Isler, John J. Fruit canning device. 41,249
- Israel, Oscar J., et al. Holder for spools. 41,028
- Ivers and Pond Piano Company. Tuning pin for piano fortes. 38,355
- Ivers, William H. Mechanism for stringing piano fortes. 38,521
- Ivers, William H. Tuning pin for piano fortes. 38,355
- Ivey, James B., et al. Chain belt. 39,423
- Jackson, George F., et al. Device for cleaning cisterns. 41,394
- Jackson, Isaac. Driving belt. 40,470
- Jackson, Isaac. Fastener for belts. 41,087
- Jackson, John, et al. Weighing machine. 40,497
- Jackson, John F., et al. Tufting attachment for knitting machines. 40,546
- Jackson, Mark A. and John H. Roofing tile fastening. 38,989
- Jackson Pipe Organ Company. Organ. 40,830
- Jackson, Richard W. Organ. 40,830
- Jacob, Frederick W. Coin feed reference bookholder. 41,073
- Jacob, Oscar, et al. Device for holding a wheel on its axle. 39,631
- Jacobs, Charles. Heater for feed water. 40,307
- Jacobs, George B. Loader for cartridges. 38,364
- Jacoby, William. Hammer. 39,123
- James, Christopher R. Air brake. 41,051
- James, George Barker, et al. Electric battery. 38,026
- James, William, et al. Household utensil. 38,682
- James, William. Grate bar. 38,419
- Jamieson, Arthur P., et al. Apple picker. 41,257
- Jamieson, Walter L. and Frederic C. Method of making waterproof paper. 40,057
- Jamieson, William, et al. Clothes drier. 38,461
- Janney, Joseph Warner, et al. Shaft tug. 38,935
- Jechoux, Justin H. S. Perspectograph. 41,120
- Jeffery, Thomas B. Pneumatic tyre. 40,898
- Jeffery, Thomas B. Pneumatic tyre. 39,035
- Jefferys, Lemuel A. Anti-friction bearings for journals and axles. 38,241
- Jenking, Cornelius C. Cover for sewing machines. 38,256
- Jenkins, Charles S. Exhibiting apparatus. 39,817
- Jenkins, Philip A. Electric clock. 38,421
- Jenkins, Safety Catch Gun Company. Safety catch for gun triggers. 38,189
- Jenkins, William E. Safety catch for gun triggers. 38,189
- Jenne, Chancy Robert. Trap for animals. 38,088
- Jenner, William J., et al. Check punch. 40,457
- Jennings, William T. Rail for street railways. 38,694
- Jerger, Henry. Water engine. 38,331
- Jernander, Carl. Belt lightener. 39,105
- Jewell, Major Romeyn. File case. 38,982
- Jewell, Major Romeyn. Letter file. 39,010
- Jewett, Aldarilla C. and James D. Tools for joining wire fence strands. 39,991
- Jewett, Charles C. Loader for hay. 39,588
- Jewett, Charles G. Damper regulator. 40,380
- Jewett, Franklin N. Device for opening hot boiled eggs. 38,258
- Jewett, Luther K. Bearings for railway cars. 40,805
- Jincks, Melvin. Saw straining device. 40,834
- Johnson, Albert E., et al. Art of and mechanism for channelling soles for foot ware. 39,263
- Johnson, Benjamin. Seal for cars. 38,208
- Johnson, Caleb S. Cistern. 40,612
- Johnson Company. Rail for railways. 39,130
- Johnson, Frank P. Sash balance. 38,896
- Johnson, James Wood. Lint package. 38,417
- Johnson, John A., et al. Clothes pin. 38,768
- Johnson, Joseph H. Binder for loads. 38,345
- Johnson, Robert. Rotary engines, blowers, pumps and water meters. 38,064
- Johnson, William. Kiln. 41,390
- Johnson, William. Machine for manufacturing bricks. 39,637
- Johnson, William. Machinery for pressing sand-faced bricks. 40,074
- Johns, Henry Ward. Roofing fabric. 38,156
- Johnston, Andrew. Cultivator. 40,759
- Johnston, Andrew L. Disconnecter for overhead conductors. 41,156
- Johnston, Andrew. Feed operating gear for seeding machines. 40,686
- Johnston, Andrew. Seeding machine. 40,631
- Johnston, Charles. Hammock. 41,189
- Johnston, Elbert R. Printer's stick. 38,742
- Johnston, Gustavus J. Mailing case. 39,606
- Johnston Harvester Company. Disk harrow. 40,243
- Johnston, John H., et al. Fastening for stove pipes. 39,630
- Johnston, John L., et al. Nutritive compound. 38,740
- Johnston, Thomas R. Apparatus for feeding and separating sheets of paper. 39,510
- Jolliffe, James, et al. Sewer ventilator and electric wire support. 39,133
- Jones, Alfred, et al. Lubricant. 39,175
- Jones, Benjamin F., et al. Brick kiln. 38,377
- Jones, Edward A. Machine for grinding metal balls. 40,365
- Jones, Edward A. Machine for making metal balls. 40,364
- Jones, Evan and J. A. Machine for pressing and blowing glassware. 40,367
- Jones, Evan W. Furnace. 40,700, 40,721
- Jones, Francis W. Car step. 40,207
- Joseph, Frank, et al. Cover for desks. 39,845
- Jones, George P., et al. Car coupler. 38,244
- Jones, Horace K. Wood screw, and method of making the same. 40,011
- Jones, James and Aldred James. Grinding mill. 39,909
- Jones, James and James jr., et al. Electric time call. 39,557
- Jones, Jessie A., et al. Packing case. 40,512
- Jones, John, et al. Street broom. 40,672
- Jones, John, et al. Sweeper for streets. 40,260
- Jones, John T. Car coupler. 38,715
- Jones, John. Clincher for horse-shoe nails. 38,946
- Jones, Joshua L. Fastener for trunks. 41,178
- Jones, Lewis. Knitting machine. 39,809
- Jones, Lyman M., et al. Finger bar for harvesters. 39,754
- Jones, Lyman M., et al. Grain binder. 39,900, 39,901
- Jones, Lyman M., et al. Harvester binder. 38,063
- Jones, Lyman M., et al. Sheaf carrier for harvester binders. 39,899
- Jones, Maggie E. Seine for fishing. 38,049
- Jones, Nathaniel M., et al. Digester for paper pulp. 41,022
- Jones National Fence Company. Tools for joining wire fence strands. 39,991
- Jones, Nathaniel S., et al. Type setting machine. 41,204
- Jones, Samuel Evans. Alarm. 38,854
- Jones, Robert H. Organ. 40,238, 41,295
- Jones, Samuel Evans. Alarm. 38,854
- Jordan, Rishworth, et al. Lock. 39,017
- Joy, Frank L. Railway car construction. 38,653
- Judson, Whitcomb L. Railway. 39,808
- Jukes, Hamilton A. Earth closet. 38,325
- Junes, William, et al. Galvanic electric plasters. 38,973
- Jungbluth, Johann. Malt floor. 38,731
- Kahabka, Karl. Accumulator for electric light. 40,586
- Kahn, Ferdinand J. Mitten. 40,595
- Kaiser, Frederick. Sounding board for pianos. 39,544

Kaliske, Henry S. Apparatus for exhausting incandescent lamps.....	39,206	Kirby (A.D.) & Co. Extension table.....	40,392
Kane, John, et al. Car coupler.....	38,820	Kirby, Jeremiah W., et al. Car coupler.....	38,960
Kanzler, Karl. Holder for bed clothes and babies.....	38,056	Kirby, John, et al. Autographic register.....	39,128
Karr, James P. Apparatus for removing incrustation from steam boilers.....	40,958	Kirchhoff, William P. and James W. Method of manufacturing candy.....	38,581
Kar, George S. Saddle for velocipedes.....	40,878	Kirk, James S. and Company. Apparatus for concentrating spent soap lye to recover salt and glycerine therefrom.....	40,703
Kayler, Raymond S., et al. Wrecking machine and stump extractor.....	40,465	Kirk, James S. & Company. Apparatus for distilling glycerine recovered from soap lye.....	40,732
Kayser, William J., et al. Fly trap.....	41,044	Kirk, James S. and Company. Apparatus for obtaining salt and crude glycerine from spent soap lye.....	40,706
Keane, William. Squeezer for floor-cloths.....	38,794	Kirk, James S. and Company. Apparatus for purifying salt recovered from spent soap lye.....	40,705
Keating, Henry S. Electric cutout.....	40,482	Kirk, James S. and Company. Method of making glycerine from spent soap lye.....	40,708
Kegler, Daniel, et al. Furnace.....	40,582	Kirk, James S. and Company. Method of purifying glycerine.....	40,704
Keighley, Sidney L., et al. Trolley wheel.....	39,733	Kirk, James S. and Company. Method of recovering glycerine from spent soap lye.....	40,701
Keil, Adam, et al. Mining machine.....	39,387	Kirk, James S. and Company. Method of treating soap lye.....	40,027
Keiper, Henry Brinser. Screw cutting plate.....	38,897	Kirk, John E., et al. Horse hay rake.....	39,167
Kelsey Furnace Company. Hot air furnace.....	39,358	Kirk, Rebecca. Arm and wrist rest.....	41,157
Kelsey, William W. Hot air furnace.....	39,358	Kirkham, Thomas C. Vending apparatus.....	40,039
Kellner, Carl. Opener for pulp.....	40,116	Kirkpatrick, Edward, et al. Meter for gas.....	41,280
Kellner, Carl. Method of lining boilers or digesters.....	38,384	Kirkpatrick, John A. Heating apparatus for air.....	40,192
Kelley, Harvey E. Chain.....	39,089	Kirsch, Isaac. Rolls for making table cutlery.....	38,210
Kelley, Harry Eugene. Check hook.....	38,339	Kirschner, Karl. Means for securing corks in bottles.....	40,594
Kelly, Barnabas F., et al. Furnace.....	40,476	Kiskadden, Robert A. Car brake.....	39,911
Kelly (O. S.) Company. Steam road roller.....	38,547	Kissel, Martin L. Grain drill.....	39,689
Kelly, James P., et al. Switch for railways.....	41,105	Kissingner, John T. T., et al. Animal trap.....	40,976
Kelly, Melville H., et al. Lock.....	39,017	Kitchell Embossing Company. Method of embossing papers, &c.....	38,271
Kemp, William A. Damper.....	38,463	Kitchell, Hudson M. Method of embossing paper, &c.....	38,271
Kemp, William A. and Albert E. Damper.....	38,462	Kitselman, Alva LaSalle and Davis M. Machine for making netted wire fabric.....	40,885
Kemp, William A. Stove pipe.....	41,389	Kiviattkowski, Adalbert. Apparatus for the rescue of persons buried in trance.....	39,472
Kemper, Alfred C., et al., Convertible camera and graphoscope.....	41,192	Kjellstrom, Mary S. Road sweeper.....	38,713
Kempton, Alonzo F., et al. Wash boiler.....	38,601	Klein, August. Rail joint.....	40,271
Kendall, Isaac N. Band saw mill.....	38,825	Kleinert, Isaac B. Dress shield.....	38,476
Kendall, Isaac N. Pipe coupling and tube rest.....	41,024	Kleimetschek, Adolph. Method of producing clear Wort.....	38,900
Kendall, Isaac N. Pulley.....	38,149	Klingler, Joseph W. Car coupler.....	38,771
Kendall, Isaac N. Saw mill set works.....	41,024	Klinka, Paul. Method of producing flat reliefs for wall ornamentation.....	40,865
Kendall, James R. Apparatus for manufacturing gas.....	39,165	Klotz, Daniel, et al. Baking pans.....	38,855
Kenehan, Gilbert P. Fastener for belts.....	39,580	Klumpp, Lewis Rudolph, et al. Sash lock.....	38,905
Kenehan, Gilbert P. Process of and die for making belt fasteners.....	39,927	Knapp, Lyman, et al. Roofing.....	39,224
Keekenapp, F. H. Fastener for collars.....	38,028	Knapper, Joseph, et al. Lamp.....	39,376
Keen & Hagerty. Plate for baking purposes.....	39,357	Kneeland, Remus A. Package for shipping and preserving butter, &c.....	38,995
Keenan, Ellis. Molding machine.....	38,191	Knell, James W. Apparatus for producing illusory dramatic effects.....	39,625
Keenan, William. Conveyor for coal, &c.....	39,097	Knickerbocker, James B., et al. Meter for gas.....	41,280
Kennedy, Charles A. and George A. Car coupler.....	38,287	Knight, Ebenezer R. Seed planter.....	40,668
Kennedy, Colin. Spring coupling for vehicles.....	38,902	Knight, Edward M. Filter.....	39,548
Kennedy, Henry J. Penholder.....	39,943	Knight, Patrick H. and Willie A. Machine for making paper boxes.....	39,985
Kennedy, John Patterson. Machine for swaging the ends of metal tubes.....	38,119	Knowles, Henry. Socket pipe for drainage.....	40,247
Kennedy, Oliver. Hook and holder for check reins.....	39,163	Knox, Andrew W. Overflow cut off.....	41,207
Kennedy, Patrick. Coin actuated device.....	39,767	Knox, Orville E. Hand rake.....	38,174
Kennedy, Thomas J. Nut lock.....	40,797	Kobb, Joseph. Snow plow.....	40,407
Kent, Edward. Bag containing material for poultices.....	38,817	Kobler, Victor, et al. Machine for threading needles of embroidering machines.....	38,581
Kent, Henry A., et al. Brick kiln.....	38,377	Koehler, Martin. Hot air furnace.....	39,657
Kerr, James G. Water motor.....	38,829	Koenen, William. Sash lock.....	39,973
Kersbrock, John H. Apparatus for bottling beer.....	40,675	Koepp, Heinrich. Sad iron.....	41,282
Kerslake, Harry A. Vapor lamp.....	39,076	Kohler, Edwards. Sewing machine.....	41,310
Kersteter, Charles W., et al. Fire extinguisher.....	39,701	Kohler, Wilhelm, et al. Furnace.....	40,582
Keseling, Joseph E., et al. Artificial stone.....	41,255	Koller, Hugo. Dry cell.....	39,773
Keseling, Joseph E., et al. Compound for making artificial stone.....	40,576	Konig, John Henry, et al. Apparatus for treating wire.....	34,011
Ketcham, William. Dry kiln furnace.....	38,353	Korting, Ernest. Ignition in gas engines.....	38,206
Kettle, Charles James, et al. Ventilator for stove pipes.....	38,937	Korting, Ernest. Water jet condenser.....	38,218
Kew, John L. Extension ladder.....	38,696	Korting, Ernest. Steam and vacuum pump.....	38,218
Kidder, Amasa N. Method of manufacturing paper.....	38,815	Korting Gas Engine Company. Apparatus for intermittent motion.....	39,806
Kidder, Willington P. Type writing machine.....	39,417	Korting Gas Engine Company. Governor for power engines.....	39,806
Kieley, Timothy J. Drain trap.....	38,966	Korting Gas Engine Company. Means for producing ignition in gas engines.....	39,807
Kievel, John F., et al. Pump.....	40,335	Koyl, Charles H. Drying apparatus.....	39,847
Kilgore, Frederick O., et al. Log loader.....	40,946	Kramer, Martin. Sewing machine.....	39,015
Kimball, Madison C., et al. Device for tying logs, &c.....	38,374	Krank, Albert. Apparatus for producing motive power.....	40,691
Kimball, Stephen S. Dehorning instrument.....	40,058	Krehb el Capsule Co. Plant for manufacturing capsules.....	39,663
Kinder, Frederick H. Support for bicycles.....	39,221	Krehbiel, John. Plant for manufacturing capsules.....	39,663
Kinder, Julius. Process and apparatus for making solid link chains.....	39,871	Kremer, Franklin W. Machine for testing muscular strength.....	40,461
King, George D. Machine for forming hollow ware from pulp.....	40,159	Krieg, Theodore. Apparatus for transmitting power.....	40,720
King, Henry E. Harness.....	40,800	Krone, Wilhelm. Machine for shaping and moulding leather.....	40,599
King, Irving Dudley. Tinware vessel.....	38,106	Kropacek, Joseph J. Rivitter.....	40,799
King, James M. Separator of grain.....	40,575	Krunholz, August. Water heater and purifier.....	38,952
King, John. Valve.....	38,457	Kruschina, Charles. Steam cooker.....	38,949
King, John H., et al. Trap for waste water pipes.....	38,835		
King, Robert. Rotary harrow.....	38,204		
King, Robert W. Knitting machine.....	40,078		
King, Warden and James C. Boiler.....	39,168		
Kingsley, Elisha L., et al. Damper for envelopes.....	39,273		
Kimppel, Walter R. Apparatus for conveying ships or heavy bodies overland.....	39,492		
Kinipple, Walter R. Railway car.....	40,526		
Kinleyside, John, et al. Washing machine.....	38,884		
Kinnard, Will. McCoy, et al. Autographic register.....	38,199		
Kinsman, Frank E. Electric controller for trains.....	39,075		
Kinsman, Joseph J. Gear for carriages.....	38,385		
Kinzel, John C. Method of drying and burning bricks.....	41,354		

Kruschke, Rudolph C. Electric show case alarm	38,122	Lemieux, Victor. Shovel	41,172
Kuback, Arnold. Rotary engine	38,261	Lefebvre, Louis, et al. Door latch	38,648
Kuenzel, Charles A. Fishing device	41,378	Lefebvre, Bernard, et al. Sheep shearing machine	40,156
Kuhl, Theobald S. Can opener	39,003	Legg, Albert, et al. Sewing machine	40,602
Kupferling, Carl, et al. Toy	41,011	Leggett, Wells W., et al. Nut tapping machine	41,048
LaBurt, John, et al. Electric block signal system	41,110	Lehman, Karl. Pneumatic wheel tyre	39,679
Lacour, Ernest F. Dredger for the excavation of golden alluvium	38,735	Leiding, Charles. Net	41,031
Ladd, Sherman W., et al. Lasting machine	38,105	Leisenring, Henry G. Rectal and vaginal syringe	38,438
Laesecke, Friedrich A., et al. Method of painting	39,054	Leiser, Jacob J., et al. Breast collar	38,201
Laffont, Marc. Cement	39,148	Lemaitre, John F., et al. Truck	39,242
Laffeur, Honoré, et al. Stove lighter	38,724	Lemp, Hermann. Electrical apparatus, for welding rings	38,080
LaForce, Hippolyte J. Air valve	41,285	Lemp, Hermann. Electric welding apparatus	38,082
LaForce, Hippolyte J., and Permalie. Pneumatic tyre	40,935	Lemp, Hermann. Electric welding transformer	38,663
Lajoie, Misael. Extinguisher for lamps	38,758	Lemp, Hermann. Method of welding rings by electricity	38,078
Laidlaw, James and John S., et al. Furnace	41,356	Lemp, Hermann. Sliding clamp for electrical welding apparatus	38,081
Laing, John. Apparatus for distilling mineral oil	41,311	Lemp, Hermann. Transformer for heavy currents	38,079
Laing, John. Apparatus for distilling mineral oils	40,899	Leo, Ansel. Collapsible ladder	41,281
Laird, Robert. Apparatus for making illuminating gas	40,490	Leonard, Frank E., and Charles W. Governor for steam engines	39,218
Laird, Wesley E. Power transmitter	39,879	Leonard, Henry W. Electric lighting system for trains	39,972
Laird, William H., et al. Process of producing heating gas	40,974	Leonard, Mark T., et al. Steam engine	40,212
Lalonde, Joseph. Syringe	40,016	Leroy, Henry W., et al. Fence tool	41,233
Lambert, Frank, et al. Meter for water	40,992	Leslie, Joseph, et al. Switch for railways	41,105
Lamphere, Alvin W. Sickle bar movement, for mowers and reapers	40,726	Lesser, Mona. Cigar	39,658
Lampitt, Charles. Machine for preparing grain	39,949	Lesser, Philip. Gas burner for heating purposes	39,626
Lancaster, Frederick J., and Joseph H., et al. Weighing machine	39,804	Lester, Lewis, W. Boiler for locomotives	41,243
Lancaster, James H., and Michael R. Method of making steel and iron	39,867	Lester Manufacturing Co. Pocket lamp	39,453
Landback, William O., et al. Barrel expander	40,856	L'Esrange, Frank N. Camera	39,967
Land, Charles H. Muffle furnace	40,007	Lesueur, Ernest A. Electrolytic cell	41,074
Land, Silas M., et al. Process of embellishing wood	40,990	Levey, John. Regulator for steam furnaces	39,918
Lane, Alvin V. Puncher for banks	39,666	Levy, Marc A. Cabinet for holding duplicating apparatus	39,667
Lane, Bradford. Earth auger	40,133	Lewes, Vivian B. Apparatus for the manufacture of hydrogen gas	39,473
Lane, Charles F. Washing machine	41,013	Lewes, Vivian B. Process of manufacturing hydrogen	39,497
Lane, Frank S., et al. Log loader	40,946	Lewis, Don. E., et al. Holder for spools	41,028
Langley, John W. Aluminium alloy	39,402	Lewis, Elliott, L. Kneading board	38,985
Langlois, D. Henri. Bed case	39,117	Lewis, Eugene H. Building block	40,168
Langmuir, Woodburn. Cushioned tire	39,057	Lewis, Eugene H. Brick	38,853
Langville, Louis S. Carbon product	39,924	Lewis, Granville R. Car coupler	40,903
Lanhoff, Joseph. Pipe	38,795	Lewis, James. Vehicle axle	40,950
Lansberg Brake Company. Air brake	40,652	Lewis, James, et al. Lawn mower and trimmer	40,859
Lansberg Brake Company. Steam pumping engine	40,653	Lewis, Napoleon, et al. Moulding machine	39,393
Lansberg, Frank. Air brake	40,652	Lewis, William, T. O. Process of manufacturing lacing leather	38,593
Lansberg, Frank. Steam pumping engine	40,653	Libbey, Mark A. Cart	38,698
Lanth, John N. Furnace for metallurgical operations	41,412	Liddle, John, et al. Kite	39,196
Lanz, Conrad. Apple syrup	39,029	Lieber, Henry, et al. Sleigh	40,884
Lapraik, Thomas S. Heating apparatus for railway cars	41,170	Lieberthal, Elias H. Suspender	38,066
Larkin, John T. Hair pin	41,131	Liedbeck, Carl Harold. Medicinal apparatus	39,094
Larochelle, Anselme H. Steam engine	40,372	Lifschutz, Isaac. Process for the simultaneous production of cellulose and oxalic acid from ligneous material	38,460
La Rue, John H. Carbon burner	40,417	Lightfoot, Walter H. Bed bottom and brace	38,262
Lasar, Godfrey H. Typewriter	40,391	Lillington, John J. B. Tool for clamping timber	40,124
Lasee, Alonzo H., et al. Wrench	39,201	Lilly, James, et al. Machine for ruling, perforating, printing, numbering and severing web paper	39,536
Laskey, Stephen. Hammer and feller	40,103	Lincoln, Levi C., et al. Arm rest for telephones	40,991
Latham, Samuel. Blanket for horses	40,120	Linderman, Albert T. Corner joint for packing boxes	40,374
Latham, Samuel. Overall	41,260	Linderman, Albert T. Dovetail joint closing machine	40,368
Lathrop, Elias L., et al. Machine for making, repairing and clearing roads	40,361	Linderman, Albert T. Slab sawing machine	40,321
Latimer, William G. Vending machine	40,746	Lindley, Herbert, et al. Liquid hydrocarbon motor engine	39,479
Latta, Joshua W. Car coupler	39,072	Linebarger, Oliver, et al. Churn	40,195
Lattig, Jacob W., et al. Signal for railways	41,357	Lingford, Henry B., and Edward. Apparatus for feeding calves	39,180
Lauzon, Joseph. Boot and shoe	38,304	Lingle, William H. Movable seat for vehicles	40,765
Lavender, Charles F., et al. Tire for bicycles	38,284	Lintz, Richard, et al. Sewing machine	40,485
Lavender, Charles F., et al. Velocipede	39,777	List, Joseph J. S. Pipe coupling	39,283
Lavigne, Hector. Table, prie-dieu and confessional	39,226	Litch, Wilbur F. Bottle for mucilage	38,487
Law, William H. Power hammer	39,771	Little, Piercy, et al. Barrel expander	40,856
Law, William H., et al. Burglar protection device for safes	38,575	Littlefield, Frank A. Steam trap	40,774
Lawrence, Henry E., et al. Corrosion preventive for tinware	38,904	Littlewood, John W. Stove pipe	38,318
Lawrence, Isaac J., et al. Machine for making nails	40,503	Lloyd, George. Water heater	38,730
Lawrence, Isaac J., et al. Corrosion preventive for tinware	38,904	Lloyd, Marshall B., et al. Ironing and polishing machine	40,013
Lawrence, William B. Printing press	40,079	Lloyd, Marshall B., et al. Method of and apparatus for weaving coiled wire fabric	39,982
Lawton, Charles F. Method of manufacturing beer	39,550	Lloyd, Norman Chester. Churn	38,991
Laycock, William S. Ventilator	39,477	Lobdell, Alonzo. Check hook	38,053
Lazarus, Samuel, et al. Baby carriage, chair and cradle	38,928	Lock, Charles. Method of making axles or shafts	39,856
Lazarus, Theresa, et al. Baby carriage, chair and cradle	38,928	Locke, Fred. M. Insulator pin	41,315
Lea, Thomas, et al. Calk for horse-shoes	39,354	Lockwood, Charles L. State room for sleeping cars	41,329
Lea, Thomas, et al. Calk for horse-shoes	38,051	Lockwood, William C. Telephone	38,506
Leadbeater, Frederick. Injector for steam and air	40,032	Lodge, Charles, et al. Compensator for signal rods	39,582
Learnmouth, Robert. Feed, water heater and purifier	39,034	Loeffler, William. Carving machine	41,380
Leavitt, Harry W. Dehorning instrument	40,058	Loftin, Melville. Nail puller	38,796
Leavens, Ellen M., et al. Printing telegraphs	40,190	Logan, Charles H. Secondary battery	38,376
LeBel, Cleophas. Stove pipe	38,296	Logan, Cyrus F. Stop Cock	40,186
Ledel, Hans B. Car coupler	38,391	Logan, John H. Holdback	40,993
Leduc, Michael. Car coupler	38,239	Loger, David E. Separator for flax seed	40,436
Leduc, Michael, et al. Axe	38,632	Lohlker, Adam H. Paper hanging machine	40,258
Lee, Ashbury W., et al. Knitting machine	41,298	Lohr, William J. Whiffletree	40,378
Lee, James F., et al. Wagon	38,728	Lomb, Carl F. Letter file	38,671
Lee, Joseph W. Apparatus for stopping and starting vehicles	39,786	Lomis, Burdett. Process of and apparatus for manufacturing gas	38,151
Lee, Thomas A. Fire proof floor	38,346		
Leeson, Joseph R. Method of winding balls	41,098		

Long, Charles E., et al. Secondary battery	40,486	Mansfield, Henry A. Fire extinguisher	40,056
Long, David N. Process of excavating shafts through rock	41,168	Manypenny, Gustavus B., et al. Incandescent electric lamp	40,095
Long, Daniel, W., et al. Holder for parcels, &c.	40,254	Marceau, Joseph O., et al. Reel for winding and unwinding yarn	39,296
Long, John D. Process of excavating shafts through rock	41,168	Marce, John. Field range	40,423
Lonnerberg, Adolph L. Belting	41,427	Marcet, Alexander, et al. Refrigerator	41,196
Loomis, Albert E., et al. Machine for weaving wire mattresses	40,809	Marcey, Alexander, et al. Organ stop actions	38,839
Loranger, Horone R., et al. Money changer	40,114	Marcey, Herman Byron, et al. Organ stop action	38,839
Lorenz, William A., et al. Bag	38,707	Maris, Jared. Cap for vehicle hubs	40,282
Lotze, Ernest. Propeller for cables	39,766	Maris, Jared. Cover for the ends of hub bands	40,277
Lotz, Henry. Spinning wheel	40,739	Mark, John T., et al. Churn	39,054
Loudon, Allan. Folding chair	39,820	Markle, Jacob H. Fastener for boots and shoes	39,444
Louden, William. Hay elevator and carrier	40,411	Marks, William B. Tobacco drier	38,205
Loughed, Aaron. Car coupler	40,209	Marlett, William E. Door for elevators	40,813
Loughridge Brake and Car Company. Brake	41,343	Marlow, Claud E., et al. Case for bottles	38,061
Loughridge, Jacob E. Brake	41,343	Marsh, Edwin. Apparatus for firing and heating steam boilers, &c.	39,756
Love, James. Regulator for gas	41,183	Marsh, George A. Fruit gatherer	40,134
Lovegrove, Thomas G. Electric boiler alarm	38,554	Marsh, Nathan, et al. Spring motor for sewing machines	40,861
Lovell, Albert K. Wrench	39,848	Marsh, Riverius. Frame for tiles	41,188
Lowe, Austin. Typewriter	39,096	Marsh, Riverius. Ventilating heater	40,220
Lowe, Braxton B. Wrench	40,227	Marshall, Anderson C. Steam vehicle	41,198
Lowe, Oscar. Apparatus for opening and closing cocks	39,670	Marshall, Benjamin. Sash balance and lock	38,155
Lowe, William S. Egg tray machine	39,643	Marshall, Edwin M., et al. Moistener for stamps and opener for envelopes	39,718
Lowe, William W., et al. Kiln	40,764	Marshall, George, et al. Process of treating metalliferous ores	40,453
Lowenthal, Isidore, et al. Muff bed	40,695	Marshall, John W., et al. Compound press	40,452
Lowinsky, Marcus W. Wheel	40,690	Marth, Oscar. Plough	39,684
Lowry, George A. Machine for making twine	39,501	Martin, Archer. Sad iron	40,137
Luce, Edwin W. Oil can and filler	38,826	Martin, Edgar. Filtering machinery	40,752
Luce, William B. Apparatus for electrically reporting events	39,827	Martin, Francis P. and John T. Packing for rods, valve stems, &c.	39,457
Ludwig, Bernhard. Machine for bending and embossing wood	39,890	Martin, George W. Method of decorating glass	38,299
Lumell, Herbert M., et al. Electric cutout	41,115	Martin, Horace I. Method of advertising	39,564
Lundberg, Andreas. Switch for electric lights	39,172	Martin, James P. Fare and baggage checking system	41,181
Lundstrom, Albert. Stove	40,815	Martin, James P. Protector for boots and shoes	40,532
Lunz, John. Link motion	39,041	Martin, John B. Pendulum scales	40,491
Luse, Henry H. Filtering faucet	39,610	Martin, Joseph C. Conveying apparatus	39,435
Lusk, Lewis Newell, et al. Bail and ear for pails, &c.	38,050	Martin, Stephen J., et al. Numbering machine	41,256
Lybe, Daniel I. Velocipede	38,691	Martin, Theodore. Nut lock	39,784
Lyle, William R. Screen door	38,065	Martin, Thomas M., et al. Burglar protection device for safes	38,575
Lyman, Albert B. Tractor for obstetric forceps	38,110	Martin, William A. Potato digger	38,699
Lyman, Joseph. Book stapling machine	40,373	Martino, Frederick W. Method of making alloys	39,950
Lyman, Moses. Toy	40,138	Martyn, Edward. Valve	39,020
Lyon, William F., et al. Door for cars	39,790	Marwick, Robert, et al. Machinery for operating jerker wheels	41,373
Mabee, Elizabeth L. Washing machine	39,522	Mashinter, William P., et al. Electric cut out	41,115
Macdonald, Duncan C. C., et al. Sash lock	38,249	Massey-Harris Company. Finger bar for harvesters	39,754
Macdonald, George S. Trousers stretcher	40,916	Massey-Harris Company. Gram binder	39,901
Macdonald, James. Distinctive paper	38,190	Massey-Harris Company. Sheaf carrier for harvester binders	39,899
Macfarlane, Thomas. Process of extracting nickel from ores	40,628	Mast, (P. P.) and Company. Grain drill	39,689
MacGregor, John. Horse collar	40,673	Mason, Allan. Process and apparatus for distilling oil	41,276
Mack, William, et al. Kiln	40,764	Mason, John L. Grate for furnaces	40,783
Mackay, William M. Valve	38,283	Massie, James. Bedstead	38,168
Mackey, William T. Gang saw mill	41,035	Mathews, James H. Bicycle	38,044
Mackey, George Herbert, et al. Harrow	38,898	Mathews, Joseph B. Railway switch	38,350
Mackie, Susan A. Washing boiler	39,216	Mathews, Stephen M. Electric alarm	38,536
Macklin, Edgar. Price ticket	39,115	Matthaei, August W. Repeating mechanism for watches	39,616
MacLaughlin, William G. Motor	40,166	Mattison, Christen. Chamfer cutter and lathe	39,757
Maclean, Wallace. Transfer ticket	41,124	Matzeliger, Jean E. Machine for lasting boots and shoes	40,727
MacLellan, John A., et al. Apparatus for making moulds for casting	38,427	Matuk, Calvin S., et al. Floodgate	38,435
Macrae, James A. Harness	41,166	Maurer, Barnard. Pulley	40,401
Macy, Lewis Jefferson. Aerator for milk	38,090	Maxim, Hiram S. Carburetter for gas	39,286
Madden, Mark P. Device for tapping mains	38,243	Maxon, Daniel M., et al. Sprocket wheel	40,763
Maercklein, Bernard G. Continuous railway rail	39,176	Maxwell, David. Foot attachment for raising the cutter bar of a mower	40,175
Magee, John J. Horse poke	38,501	Maxwell, David A. Road cart	39,390
Magee, John J. Barrel	41,406	Maxwell, David and Sons. Root cutter	40,687
Magee, Robert. Sifter for ashes	39,798	Maxwell, David. Root cutter	40,687
Magurn, John B., et al. Packing case	40,512	Maxwell, William. Nut shearing and punching machine	41,290
Magill, Edwin B. Body cooler and supporting frame therefor	40,446	May, Horatio N., et al. Type setting machine	41,204
Maher, William E. Air brake	40,303	Maybaum, Levy. Means for securing persons from losses by bad debts	38,334
Main, Marwin D. Cooler for milk	41,088	Mayar, Louis. Process of reproducing Oil paintings	38,910
Main, William. Power transmitter	39,310	Mayer, August, et al. Siphon discharge flush tank and analogous apparatus	38,179
Main, William. Power transmitting machine	39,293	Mayer, Benjamin, et al. Car coupler	41,344
Main, Michael G. Tack driving machine	39,187	Meyer, Louis. Sharpener for bush hammers	38,274
Maisch, Frederick. Glove fastening	40,964	Mayhew, C. J. Tap socket for barrels	40,402
Mallory, George. Latch for gates	39,166	Mayhew, George, et al. Composition for building purposes	38,723
Mallory, George. Terrett for harnesses	39,169	Mayhew, George S., et al. Cove	38,270
Manderfield, George J. Stopping apparatus for knitting machines	40,431	Mayo, Samuel P., et al. Apparatus for ordering tobacco	40,201
Manewall, George, et al. Blind for windows	40,354	McAllister, Archibald, et al. Car coupler	38,548
Mann, George. Advertising device	41,109	McArthur, John, et al. Process of making dynamite	40,566
Mann (J. W.) Manufacturing Company Sulky tooth harrow	38,148	McAvity, T. and Sons. Shelf bracket	40,492
Mann (J. W.) Manufacturing Company. Spring tooth harrow	40,394	McBaron, Michael. Process of annealing metals	38,517
Manning, William W., et al. Apparatus for feeding to magnetic separators	41,231	McCahey, Peter. Apparatus for assisting parturition	40,838
Manning, William W., et al. Magnetic separator	41,165	McCall, William W. Wagon for advertising	41,112
Manny, Eugene S. Hot water furnace	40,427	McCallum, Alexander, et al. Stamp affixer	39,563
Mansbach, Abe, et al. Turner for music leaves	38,518	McCants, Jason S. Pessaries	
Mansfield, Frank, et al. Lightning arrester	39,329		

McCarthy, James J. Roof.....	40,574	McKesson & Robbins. Capsule.....	40,496
McCarthy, John. Handle for caskets.....	38,524	McKim, George W. Wire nail making attachment for cut-nail machines.....	38,996
McCarthy, Louis. Insulator.....	38,754	McKinnon, John, et al. Clothes drier.....	38,461
McCarthy, Mitchell F. Method of constructing fire proof buildings.....	39,530	McKnight, Joseph. Windmill.....	38,931
McCarthy, William F.C.M. Method of and apparatus for making steel direct from the ore.....	39,975	McIntire, David F., et al. Door.....	40,153
McCauley, Andrew J. Spring hinge.....	41,277	McIntosh, Campbell A. Wrench.....	40,796
McClellan, Ezra S. Air valve for drain pipes.....	39,957	McIntosh, John, et al. Saw set.....	38,348
McCluer, Charles E. Telephone toll box and connection register.....	40,819	McLachlan, Duncan, et al. Chopping knife.....	41,225
McClure, George W. Hot blast stove.....	41,369	McLachlan, Duncan, et al. Holder and cutter for roll paper.....	39,205
McClure, George W., et al. Regulative hot blast stove.....	41,382	McLachlan, et al. Pipe wrench.....	41,224
McCull, Hugh. Pulley wheel.....	40,456	McLaughlin, James F. Armature for electric motors.....	41,258
McCull, Hugh. Pulley wheel.....	41,347	McLaughlin, Robert. Gear for carriages.....	38,052
McCormell, Virgil H. Feed water heater and purifier.....	41,348	McLellan, Charles J. Agitator for mixed paint.....	41,248
McCormick Harvesting Machine Company. Grain binder.....	39,193	McMahon, John P. Fire alarm.....	39,541
McCormick Harvesting Machine Company. Mower.....	41,049	McMarsh, Leonardo. Bit-stock.....	39,559
McCormick, James, et al. Ventilator for stove pipes.....	38,937	McMartin, Martin A., et al. Turner for music leaves.....	38,518
McCoy, Thomas T. Tool for threading bottle necks.....	41,384	McMichael, Peter. Hand rake.....	38,509
McCrossan, Thomas. Washing machine.....	38,103	McNulta, Herbert. Air brake.....	40,146
McCubbin, William. Wagon box.....	40,358	McPartland, James H. Fire escape.....	38,917
McDairmid, Norman, et al. Foot for dredge anchors.....	41,211	McPhail, Richard S. Bearing for pulleys.....	40,256
McDonald, James R., et al. Machine for making envelopes and placing enclosures therein.....	39,575	McPherson, John R., et al. Reamer.....	39,129
McDonald, Marshall. Method of and means for cleansing filtering surfaces.....	41,244	McPherson, Thomas C. Wire mat and matting.....	39,103
McDelvey, Thomas, et al. Axe.....	38,632	McQuarry, Hector, et al. Axle gage.....	38,577
McDermott, John J. Sash balance.....	38,706	McQueen, Thomas K. Knife for binders, &c.....	38,235
McDonald, Ronald. Cleaner for boiler flues.....	38,504	McQueney, Peter. Pasting machine for wall paper.....	38,702
McDonald, Thomas. Ear for vessels.....	39,153	McQuown, Thomas H. Skate.....	39,641
McDougall, James. Fire lighter.....	38,432	McRae, John B., et al. Trolley wheel.....	39,733
McDowell, Anthony B. Sewing machine.....	40,360	McRobie, William O. Soot door, ventilator and check draft for chimney apertures.....	38,363
McDowell, Edward. Lamp burner.....	40,714	McShane, William. Shelf bracket.....	46,492
McElroy, James F. Car heater.....	40,178	Meacham, William H., et al. Revolving mold for glass-ware.....	38,411
McElroy, James F. Car heating apparatus.....	39,406, 39,407, 39,408	Meakin, William. Rock crusher.....	38,276
McElroy, James F. Car heating apparatus.....	39,835	Mears, Robert S. Electric apparatus for the human body.....	39,332
McElroy, James F. Coupler for electric wires.....	39,411	Mee, Charles. Lounge.....	40,081
McElroy, James F. Coupling for hose.....	41,342	Meehan, David C. Pigeon hole case.....	38,998
McElroy, James F. Current director.....	41,266	Meehan, James. Scrubbing machine.....	40,145
McElroy, James F. Current regulator.....	41,267	Meek, William E., et al. Separator.....	39,465
McElroy, James F. Electric regulator.....	40,285	Mehling, John A., et al. Street car.....	40,889
McElroy, James F. Heating apparatus for railway cars.....	41,430	Mehner, Hermann. Method of transforming heat into mechanical energy.....	39,151
McElroy, James F. Heating apparatus for street cars.....	40,055	Meinke, Frank. Lock.....	40,572
McElroy, James F. Heater for water.....	40,239	Melloy, James B. Oil can.....	40,966
McElroy, James F. Hose coupling.....	39,404	Meneely, Charles D. Roller bearings.....	38,202
McElroy, James F. Pipe coupling.....	38,971	Menge, Joseph. Rotary pump.....	39,699
McElroy, James F. Regulator for temperature.....	38,131	Meracher, Charles. Wood trimming machine.....	41,213
McElroy, James F. Regulator for temperature.....	39,355	Merchant, Francis Walter. Cut off for gas burners.....	38,959
McElroy, James F. Regulator for temperature.....	40,397, 40,240	Mergenthaler, Ottmar. Machine for forming type bars matrices, &c.....	39,920
McElroy, James F. System of charging car-heating apparatus with a heating medium.....	40,257	Merner, Absalom. Threshing machine.....	40,951
McElroy, James F. Temperature regulator.....	39,405, 39,409, 39,410	Merrill, Gaius L., et al. Canning machine.....	39,986
McElroy, James Finney. Temperature regulator.....	38,972	Merriam, Henry P. Explosive shell.....	40,098
McElroy, James F. Valve for train-pipes.....	39,810	Merriam, Iram Z. Device for repairing broken slats.....	40,523
McEntee, Frank J., et al. Wrench for pipes.....	39,272	Merrill, Parker. Cattle guard for railways.....	38,116
McEntee, Patrick. Car coupler.....	39,006	Merrill, William. Stave sawing machine.....	41,414
McEvoy, Edward, et al. Sprinkler for potato vines.....	40,679	Merriam, Perry P. Frog for railways.....	38,512
McFarlane, William O. Chuck for pipe nipples.....	41,066	Merritt, Charles S. Propellor.....	41,247
McFarlane, Robert, et al. Weighing scales, recorder and register.....	41,152	Merritt, Wm. H., et al. Tool for applying and removing horse-shoe guard plates.....	40,917
McFarlane, William, et al. Ventilator.....	40,608	Merry, Elwin J. Odometer.....	39,705
McGarvey, James L. Holder for check books.....	39,110	Messenger, Frank L. and William T. Pipe coupler and check valve.....	39,233
McGill, Hugh, et al. Knitted bag.....	38,033	Messenger, William T. Coupling and valve for pipes.....	38,790
McGovern, Thomas. Casket.....	40,115	Metal Goods Manufacturing Company. Buckle.....	39,198
McGuire, Charles T., et al. Car coupler.....	39,083	Metcalf, George Albert. Grain measurer and bag filler.....	38,909
McHenry, David B. Tooth.....	40,002	Mettlen, Henry S., et al. Brick kiln.....	38,377
McHenry, James W. Lifter for halter weights.....	40,505	Metzler, August J. Beer.....	39,257
McKay, Alexander, et al. Machine for manufacturing panel doors.....	38,767	Mey, Frederick H. C. Grain drier.....	39,607
McKay, Andrew B., et al. Harrow.....	39,531	Mich, Wenzel R. Core attracting solenoids.....	40,403
McKay, George D. Underwaist.....	40,462	Middleton, Arthur R., et al. Gas engine.....	40,616
McKay, Henry S. Means for electrically giving reciprocating motion.....	40,510	Middleton, William B. Process of treating steel.....	40,777
McKay, Tom. Filter for water.....	39,344	Midgley, Thomas, et al. Mat.....	40,521
McKee, George H., et al. Calendar and stamp holder.....	38,564	Mieding, William and Joseph. Lubricator.....	38,784
McKee, John, et al. Machinery for operating jerker wheels.....	41,373	Miles, Charlie H., et al. Nut lock.....	39,832
McKee, William J., et al. Electric dynamo and motor.....	38,538	Miles, Nancy. Corset.....	39,323
McKeggie, James H., et al. Anti-rattler for thill couplings.....	39,367	Miles, William J. Alloy.....	38,514
McKeggie, James H., et al. Clutch connection.....	39,051	Miles, William J. Composition for converting cast-iron into steel.....	39,912
McKeggie, John C. and James H., et al. Car coupler.....	38,548	Mill, Friedrich, et al. Boring machine.....	40,164
McKeggie, James H., et al. Drag for sleighs.....	39,366	Millard, Edward F. Art of producing ground wood pulp.....	39,876
McKinnon, Hector. Bag lock.....	40,344	Millen, George H. Paper box.....	38,938, 39,528
McKenna, Alexander G., et al. Electrolytical electro meter.....	39,929	Miller, Alonzo R. Lime slacking machine.....	39,611
McKenzie, Kenneth. Flue for fire places.....	40,393	Miller, Alonzo R. Pug mill.....	40,756
McKeon, James, et al. Sprocket wheel.....	40,763	Miller Bros. and Toms, et al. Cistern for closets.....	38,857, 38,857
McKeone, Richard J., et al. Snow plough and flanger for railroads.....	40,798	Miller Bros. and Toms. Hot water heater.....	38,062
McKerlie, Alexander. Window screen.....	38,474	Miller, Charles B. Anti-friction alloy.....	38,657
McKercher, George, et al. Wrench for pipes.....	39,272	Miller, Edward W. Handle for saws.....	41,411
McKercher, William S. Ruler.....	40,486	Miller, Horace Herbert. Clothes washer.....	38,887
		Miller, James T., et al. Axle.....	40,213
		Miller, John S., et al. Rotary plough.....	39,255
		Miller, Marcus A., et al. Memorandum book.....	38,295

- Miller, Martin B., et al. Wrench and cutter for pipes. 39,064
 Miller, Martin S. Animal trap. 40,987
 Miller, Oliver D., et al. Shaft support and anti-rattler. 68,055
 Miller, Roy. Case for books and blanks. 40,484
 Miller, Sherman R. Shipping and display box for seeds. 41,091
 Miller, Sidney Walker, et al. Siphon discharge flush tank and analogous apparatus. 38,179
 Miller, Thomas S. Hoisting and conveying machine. 40,259
 Millhiser, Moses, Gustavus and Emanuel, et al. Pouch for tobacco. 41,107
 Milliken, Foster. Derrick. 38,429
 Milliken, John A. Ticket system. 41,086
 Milliken, Samuel H., et al. Process of purifying liquids. 41,273
 Mills, Jessie and Joseph L. Process of applying the sand blast in engraving and etching. 40,385
 Mills, Lloyd N. Indicator for cash. 39,230
 Mills, Stephen G. Pump. 40,596
 Mills, Thomas. Method of propelling vessels. 41,067
 Milner, George, et al. Boiler and baker. 38,538
 Milne, James T. Band saw mill. 38,375
 Milne, John. Dormant warehouse scales. 38,277
 Minehart, Charles A. Buckle. 40,469
 Minekan, Peter, et al. Compensator for signal rods. 39,582
 Miner, Stephen H. C. Spring for vehicles. 38,032
 Miner, Willard M. Electric soldering irons. 38,332
 Minett, Alfred S. Method of treating iron sand. 41,305
 Mining and General Electric Lamp Company. Method of charging storage batteries. 41,111
 Minnick, Simon B. Machine for centering shafts. 40,918
 Minnix, William H. Motor for vehicles and boats. 40,003
 Minor, William S. Excelsior machine. 38,638
 Mitchel, John B. Pedal movement for pianos. 41,106
 Mitchel, John B. Resonance chamber for pianos. 38,840
 Mitchell, James D. Gage cock. 40,730
 Mitchell, James Henry. Die for plastic molding. 38,651
 Mitchell, Joseph, et al. Pick. 39,212
 Mitchell, Sidney Z., et al. Brush holder for dynamo-electric machines. 40,930
 Mitchell, Walter H., et al. Car coupler. 40,930
 Mitchell, William H. Chair. 41,344
 Mitchell, Willis. Electric car heater. 39,067
 Mitting, Ebenezer K. Method for recovering glycerine from spent soap lye. 39,308
 Mitting, Ebenezer K. Method of treating soap lye. 40,702
 Mockler, Frederick J. Cover for cups, &c. 40,028
 Moeller, Peter, et al. Process of manufacturing cod liver oil. 39,878
 Mohle, Henry, et al. Lever for railway switches. 38,234
 Mollsworth, Francis H. Process of treating metalliferous ores. 39,350
 Moller, George H. S. O. Thermometer. 40,453
 Monk, Henry. Steam engine. 38,924
 Monnett, John P. Band cutter. 40,969
 Montgomery, George W., et al. Extension table. 40,920
 Montgomery, John C., et al. Method of extracting gold and silver from ore. 39,420
 Montgomery, Thomas J., et al. Car coupler. 41,402
 Montgomery, Thomas J., et al. Process and apparatus for bleaching by electrolysis. 39,004
 Moody, Nathan W. Fastener for fuse caps. 39,785
 Moody, Thomas. Hat and coat hook. 39,970
 Moore, Alfred, et al. Time recorder. 39,983
 Moore, Charles E. Machine for forging horse-shoe nails. 39,253
 Moore, Charles H. Bath tub, &c. 40,143
 Moore, Clarence Webster. Barrel closure. 40,851
 Moore, Columbus A. Spring motor. 39,027
 Moore, Ellis E. Registering photographic apparatus. 39,207
 Moore, George B. Valve. 38,622
 Moore, Harry. Wheel for road vehicles. 40,174
 Moore, Jehiel. Holder for 'phones. 40,090
 Moore, Samuel John, et al. Copy holder for typewriters. 40,661
 Moore, William B., et al. Holder for car tickets. 38,085
 Moore, William H. Horse-shoe. 38,134
 Moore, William W., et al. Electric battery. 38,311
 Moorfield, Frank. Apparatus for making hollow articles. 39,624
 Moran, John P., et al. Snow plough and flanger for railroad. 40,962
 Moran, Robert. Coin actuated vending machine. 40,798
 Moran, Thomas W. Joint coupling. 40,615
 Morehead, John. Steam trap. 38,281
 Morel, Octave. Wrist turning machine. 40,000
 Morency, Pierre, et al. Stove lighter. 40,754
 Morgan, John B., et al. Joint for rotary pipes. 38,724
 Morgan, John H., et al. Nut lock. 40,221
 Morgemier, Robert, et al. Duplicating machine. 38,233
 Morier, Hormidas, et al. Stove lighter. 40,173
 Morison, Alexander. Machine for breaking and cleaning vegetable fibre. 38,724
 Morison, Alexander. Machine for preparing flax, &c. 40,515
 Morningstar, Jesse, et al. Mechanical movement. 40,076
 Morrell, James A. Method of and apparatus for evaporating and concentrating solutions. 41,417
 Morrill, George C., et al. Wringer for mops. 40,740
 Morrill, Osgood, et al. Carriage. 41,216
 Morrin, Thomas F. Generator for steam. 41,235
 Morrin, Thomas F. Sectional casing for steam generators. 40,768
 Morris, Charles F., et al. Method of preserving fruit. 40,715
 Morris, George, et al. Apparatus for revolving and elevating the screw propeller of boats. 38,709
 Morris, George, et al. Vehicle motor. 40,142
 Morris, John M. Mechanical movement. 38,792
 Morris, Norman K. Apparatus for making lead fibre. 40,624
 Morris, Norman K., et al. Method of and apparatus for producing lead carbonate. 41,246
 Morris, Robert E., et al. Horse-shoe machine. 41,221
 Morrison, John W. Counter and display rack for wearing apparel. 41,375
 Morrison, William. Hose wagon, chemical engine and hose reel combined. 38,183
 Morrow, Wesley. Potato digger. 39,450
 Morse, John B. Stove leg. 38,943
 Mortimer, Charles. Material for cutting, grinding and polishing. 38,907
 Mortimer, James. Filter for water taps. 39,963
 Morton, Charles, et al. Electric cut out. 38,827
 Morton, Charles S., et al. Wagon. 41,115
 Morton, George K. Wallet. 38,728
 Morton, John S. Method of propelling vessels. 40,237
 Morton, Thos. Horse halter. 41,326
 Morton, Wilson. Memorandum book or sale slip. 38,992
 Morton, William. Oven. 38,351
 Morton, William Marcus. Pen extractor. 39,491
 Moses, Frank. Hot air furnace and cooking stove. 38,886
 Moses, Frank, et al. Sewer ventilator and electric wire support. 41,351
 Mosher, Charles D. Steam engine. 39,133
 Mosher, Charles D. Steam generator. 42,271
 Mosher, George A., et al. Secondary battery. 39,589
 Moss, Edward H. Envelope. 39,234
 Moss, George A. Display hook. 39,737
 Moss, James, et al. Picking motion for looms. 40,735
 Moss, Julian, et al. Oscillating engine. 40,894
 Mosterts, Anton. Apparatus for preventing snoring. 38,326
 Motley, Fred. A., et al. Fruit gatherer. 39,525
 Mouat, John Duncan. Water heater. 40,134
 Moulton, Edward C. Pea sheller. 38,126
 Moulton, George W. Machine for lasting boots and shoes. 40,302
 Mount, Frederick W. Regulator for steam engines. 40,727
 Mowder, Isaac, et al. Switch tongue adjuster. 41,030
 Mowry, Aldus A. Saw guide. 38,903
 Moyer, Henry J. Safe. 40,597
 Mueller, Ludwig O., et al. Coffin. 38,507
 Muir, John. Tooth for cultivators. 38,035
 Mulcair, John. Buckle. 40,266
 Mullaby, John, et al. Surface printing plate. 39,486
 Muller, Ewald. Apparatus for cutting grooves and channels in wood. 40,346
 Muller, Rudolph. Boiler and furnace. 39,697
 Mullin, Henry. Medicinal compound. 40,580
 Mullin, John C., et al. Trolley wheel. 41,019
 Mumford, Joseph A. Steam engine. 39,733
 Munro, George. Turbine. 41,076
 Murdoch, Kenneth. Vending machine. 39,712
 Murdoch, Harvey. Thermostat and indicator. 40,746
 Murdoch, Harvey. Window blind. 41,085
 Murphy, Peter D., et al. Guard for razors. 41,068
 Murray, George W. Spring mattress. 38,786
 Murray, James. Register for hotels. 38,213
 Murrie, James. Water-feed regulator and low water alarm. 38,454
 Muskegon Chemical Fire Engine Co. Chemical fire engine. 39,797
 Myers, Andrew J. Extension step-ladder. 40,181
 Myers, Augustus. Derrick. 38,520
 Myers, Charles, et al. Screw propeller. 38,595
 Myers, Charles and Elizabeth, et al. Screw propeller. 39,527
 Myers, John F. Range. 39,504
 Myers, William A. Burner for oil. 40,279
 Nadon, François E. Saw mill. 40,657
 Nagel, Julius, et al. Process of impregnating porous bodies. 38,128
 Nash, Lewis H. Meter for water. 38,764
 Nash, Richard and John. Washing machine. 40,643
 National Cash Register Co. Indicator and register for cash. 40,643
 National Laundry Machine Co. Ironing machine. 39,640
 National Mailing Machine Co. Machine for making envelopes and placing enclosures therein. 40,193
 National Surface Guard Company. Cattle guard. 40,850
 National Unicycle Elevated Railway Company. Electric elevated railway. 39,575
 National Weighing Machine Co. Weighing machine. 40,396
 Natus, Fred. C. A., et al. Tea kettle. 41,424
 Nauhaus, Arnold. Cigar lighting and advertising apparatus. 39,804
 Naylor, John, et al. Spark arrester and smoke consumer. 39,620
 Neal, Lemuel C., et al. Motor for water currents. 39,922
 Near, Edward Byron. Washer for clothes. 39,274
 Neithercut, Robert J., et al. Wash Boiler. 38,146
 Nellis, Aaron J. Harrow. 38,601
 39,768

Nelson, Andrew L. Lamp	39,376	Oldfield, Rosa J., et al. Cheque book	39,126, 39,127
Nelson, Thomas G., et al. Loop for harnesses	39,125	Olds, Charles H. Car coupler	39,143
Nelson, William C. Dish washing machine	39,236	Oliphant, John. Penholder	38,831
Nelson, Wolfred. Lantern	40,781	Oliver, Doctor F. Paper holder	39,946
Nelson, Wolfred. Means for distinguishing vessels in fogs	41,426	Oliver, Doctor F. Ricker for hay	40,466
Nesbitt, Josiah, et al. Stop for engines, &c.	38,659	Oliver, Orville C., et al. Electric heat alarm	38,777
Nettlefolds Limited. Die for forming the threads of screws	39,353	Olsen, Ole. Sewing machine	41,242
Neuhauss, Gustav H., et al. Machine for sterilizing and drawing off liquids	38,567	Olson, Andrew B. Corn popper	41,440
Neumann, Hermann, et al. Compound for use in extinguishing fires	38,107	Olson, Charles K. Table leaf support	38,220
Neuville, Adolph. Flour and belt	38,263	Olzendam, Gustavus A., et al. Waste and conveyor for carding machines	40,620
Neville, Robert. Harrow	40,406	Oncken, Gustav A. Method of, and means for cutting veneer	38,597
Nevill, William B. Tyre heater	40,395	Oncken, Gustav A. Method of manufacturing barrels, &c.	38,660
Neville, Asa G., et al. Revolving mold for glassware	38,411	Oncken, Gustav A. Veneer and board cutting machine	38,628
New, Edward. Method of loading bricks from machines	38,448	Ornderkirk, George, et al. Churn	40,195
Newcomb, Henry. Shoe	38,563	O'Neil, Robert, et al. Gill-net puller	41,328
Newell, Augustus. Method of applying celluloid to key-boards	38,382	O'Neil, William, et al. Electrical locomotive	40,451
Newell, Augustus. Method of bushing keyboard mortises	38,654	Ophoven, Alois. Art of colouring pictures, &c.	38,822
Newell, Augustus, et al. Method of making keyboards	38,397	Oppenheimer, William. Capsule	40,496
Newell, Augustus. Veneering press	38,383	Orbach, Siegmund. Bicycle	40,034
Newell, Frank P., et al. Lever for railway switches	39,350	Osborne, Thomas B. Composition to be used as varnish, &c.	39,747
Newhouse, John E. Ice cream freezer	41,409	Osborne, Thomas B. Process of extracting zein	40,322
Newkirk, Nimiam M. Fanning mill	38,409	Osgood, Frederick B., et al. Sprinkler for lawns	39,622
Newman, Samuel. Tracing wheel	40,840	Osgood, Joseph H. Medicinal plaster	38,647
Newport, John J., et al. Kitchen utensil	38,246	O'Shea, Joseph M., et al. Anti-friction bearing	39,702
New Process Welding and Spinning Co. Process of spinning and welding metals	38,322	Ostergren, Otto F., et al. Protector for garments	38,505
Newton, Frederick P., et al. Ammunition belt	40,275	Oswald, Mathias, et al. Tool for dressing saws	39,082
Newton, Frederick P., et al. Gun	40,276	Otis Brothers and Company. Electrical elevator	41,037
Newton, Lewis W. et al. Brake beam and shoe head for railway cars	40,556	Uulton, Daniel L. Sofa and bed	40,895
Newton, Robert Wilkinson. Fire extinguisher	38,870	Owen, Ernest D. et al. Steam engine	40,212
Nice, Frederick H. Liquid for washing clothes	38,629	Page, Distan A., et al. Machine for sizing and painting cloth	39,762
Nichol, John C. Nut lock	38,650	Page, Levi H., et al. Carrier for fruit and eggs	38,631
Nicholas, Myron A., et al. Sewing machine	40,683	Page, Lewis T. Gate	40,847
Nicholson, Charles. Foot power for sewing machines	40,790	Paige, Frederick O. Moth proof bag	39,823
Nil, Jacob P., et al. Steam generator	39,577	Paine, Dutee S. Shield for carriage wheels	40,331
Nilsson, Per Adolf. Machine for making nails	39,855	Paine, Cassius M., et al. Apparatus for playing duplicate whist	38,399
Nilsson, Per Adolf. Method of and apparatus for making nails	40,236	Palmer, Bambergh, et al. Car coupler	40,886
Nirdlinger, Max. Artificial fuel	39,812	Palmer, Frank H. Sheet metal can	39,850
Nixon, John. Depurator	39,427	Palmer, Milton J. Apparatus for making soap	40,605
Noble, Frank, et al. Scalper and grader for grain	39,194	Pauchaud, Robert A., et al. Apparatus for drawing off aerated liquids	40,601
Noble, Donald, et al. Pump	41,191	Pape, Hermann, et al. Separator for granular material	38,236
Noble, James. Device for interchangeably arranging characters	38,798	Pape, Jean, et al. Changing tablets for post boxes, &c.	39,567
Noelle, Ewald. Machine for attaching buttons to garments	40,066	Paquette, George B. Sled	41,371
Nordberg, Bruno V. Valve gear	40,204	Parent, Ovide. Air cock	41,395
Norgrave, George B. Grate bar	39,987	Park, Daniel S., et al. Case for bottles	38,061
Normand, Joseph E. Locomotive driver brake	39,386	Parker, Frank L. Index	41,237
Norris, Henry D., et al. Time stamp	38,347	Parker, George W., et al. Floor or roof for buildings	40,975
North, Ebenezer. Concrete stone gully	38,412	Parker, Gilbert L. Method of and apparatus for the transmission of currents through conduits	40,283
North, George W. Clothes drier	41,134	Parker, James C., et al. Shifting rail for carriages	40,339
Noteman, Alonzo. Burner for oil	41,069	Parker, John. Machine for setting up barrels	38,094
Noxon Bros. Manufacturing Co. Knotter for harvester binders	38,130	Parker, John, et al. Improvements relating to nuts for screwed bolts, &c.	38,519
Noxon, James. Seeding machine	39,676	Parker, Robert, et al. Shifting seat for vehicles	40,634
Nowrse, Franklin, et al. Lock	39,017	Parkes, Henry, et al. Method of extracting gold and silver from ore	41,402
Noyes, Clarence E. Safety pin	40,645	Parkhurst, Augustus, et al. Wheel	39,013
Nutter, Charles W. Apparatus for preventing horses from cribbing	38,196	Parkhurst, Edward B. Indicator and register for cash	40,193
Nye, George E. Pump	39,517	Parkin, John. Valve gear for fluid rams and pistons	38,227
Nyquist, John Z. Journal box	41,410	Parkinson, James H. Method of obtaining the constituents of gaseous mixtures	41,027
Oakes, Henry and Ben. Holder and cutter for thread	38,573	Parkinson, James Howarth. Method of and apparatus for obtaining oxygen	38,140
Oakman, Joseph C. Car coupler	39,202	Parkinson, James Howarth. Method of treating permanganate to produce a spongy mass	38,139
O'Bannon, James, et al. Car coupler	39,083	Parks, Charles E. Dovetailing machine	41,367
O'Brien, Arthur. Air compressor	41,102	Parks, Charles E. Loom for weaving slat and wire fabric	41,368
O'Brien, Arthur. Flushing apparatus for water closets	41,103	Parks, David O. Collar button	41,381
O'Brien, John F. Whisk holder	39,033	Parks, James H., et al. Tyre heater	40,365
O'Brien, William, et al. Attachment for looms	39,120	Parmly, Samuel P. Arc lamp	40,026
O'Connell, John J., et al. Holder for copy	40,152	Parnelee, Wolcott J. Car wheel	38,301
O'Conner, James J., et al. Sash balance	38,706	Parmenter, James S. Compound engine	40,578
O'Conner, Malachi. Dumping car	39,413	Parmenter, James S. Signal for railroads	41,077
Oddie, Philip F. Rotary engine	41,200	Parramore, Reddin W. Corset	38,623
Odell, John J. P. Type-setting machine	39,462	Parry, Daniel, et al. Furnace	40,476
Odell, John B., et al. Type-setting machine	41,204	Parry, William A. Pug mill	40,938
Odell, John B. Type-setting machine	49,462	Parsons, Almond C. Axle cutter	39,752
Odonnell, James J. Clamp for stationery basins	38,439	Parsons, Edward E. Cigarette making machine	40,685
Oehlmann, Emil H. C., et al. Apparatus for sterilizing milk	38,569	Partello, Joseph D., et al. Tufting attachment for knitting machines	40,546
Oehlmann, Emil H. C., et al. Machine for sterilizing and drawing off liquids	38,567	Partridge, Charles S. Art of making printing plates	38,842
Oehlmann, Emil H. C., et al. Sterilizing apparatus	38,568	Pascoe, William F. D., et al. Signal for railways	41,357
Office Specialty Manufacturing Co. Letter file	39,010	Pasmore, Charles J. Cash register	38,678
Ogg, Harvey W. Weather strip	38,336	Patenall, Thomas H. Block signal apparatus	40,973
Ogle, Percy J. Drilling machine	39,782	Patterson, Henry C. and Charles G. Wiping rod	38,725
O'Grady, Gerald de Courcy, et al. Station and street indicator	41,034	Patterson, John G. Lawn mower	40,296
Oldfield, James and Rosa J., et al. Cheque book	38,586	Pattison, Charles L., et al. Device for tying bags, &c.	38,374
Oldfield, Joseph, et al. Cheque book	39,127	Pattison, Richard, et al. Electric head light	39,046
Oldfield, Joseph. Duplicating cheque book	39,947		

Patton, Charles. Chemical fire engine	38,100	Pike, Duncan. Umbrella frame	41,419
Paul, Andrew G., et al. Steam heating system	39,792	Pike, William, et al. Foot for dredge anchors	41,211
Paul, Archibald. Thill coupler	33,401	Pike, William L. Vehicle pole	41,180
Paul, John T. and James. Lantern, &c.	40,215	Pilkington, Herbert M., et al. Meter for electricity	40,750
Paul, Michael J. Apparatus for unloading ships	40,382	Pine, Arthur F., et al. Sleigh	40,884
Paulsen, Christian. Life preserver	41,039	Pink, Thomas. Recorder for payments	39,299
Pauthonier, Casimir. Method of repairing incandescent lamps	41,308	Pinkney, Charles W. Gas engine	40,096
Paxman, James N. and William. Crushing mill	40,070	Piper, Edward Spencer. Signal flag for railways	38,919
Payette, Peter. Swedge for saws	38,333	Pitt, William. Pole	39,831
Payler, John W. Handle for files, &c.	39,443	Pittsburg Brass Company. Hanger for lamps	39,892
Payne, D. W., et al. Churn and butter worker	40,375	Pittsburg Brass Company. Indicator for fluid measures	39,893
Payne, John J. E. H. Engine	39,794	Pittsburg Brass Company. Lamp	39,896
Peacock, John R., et al. Improvements relating to nuts for screwed bolts	38,519	Pittsburg Brass Company. Wick raisers for central draft lamps	39,894 39,895
Pearce, Herbert H. Trimmer for wicks	38,310	Pittsburg Crushed Steel Company. Material for cutting, grinding and polishing	39,963
Pearce, Robert W., et al. Lifter for halter weights	40,505	Pleadwell, William E. Plated ware	39,778
Pearce, William A. Chimney cap	40,874	Plenkharp, James. Stave making machine	39,764
Pearl, Eugene. Supporter for corsets	39,919	Plowright, William. Band cutter and feeder	39,649
Pearl Type Writer Co. Type writer	40,791	Plumb, John F., et al. Rotary cutter for veneer or lumber	40,388
Peck, Arthur, et al. Machine for preparing flax, &c.	40,076	Plummer, John W., et al. Heel trimming machine	40,135
Peck, Cassius C. Process and apparatus for making salt	39,721	Pneumatic Press Company. Machine for shaping plastic and similar materials	38,670
Peck Stow and Wilcox Company. Tinsmith's machine	41,050	Pneumatic Press Company. Press	38,540
Peckham, Luther A., et al. Feeding machine for carding engines	40,633	Pneumatic Street Railway Company. Railway	39,808
Peckham, Luther A., et al. Feeding mechanism for carding machines	40,651	Pneumatic Tyre and Booth's Cycle Agency. Rubber tyre and metal rim for vehicle wheels	40,630 39,586
Pedlar, George Henry. Shingle	38,137	Poffenbarger, Josias. Car coupler	40,060
Peebles, John, et al. Valve gear for engines	38,269	Polley, William. Cleaner for boilers	38,386
Peirce, Charles L. Vehicle runner	38,500	Pool, Anthony B., et al. Car brake	41,000
Peirce, Edwin J. Wax thread sewing machine	39,359	Pool, John G. Ring armature	38,944
Peletan, Louis A. Process of treating ores and matts	38,766	Poole, Frederick F. Square	
Pendleton, John H. Mill	39,561	Poole, John H. Roll for reducing railway rails to nail plates	38,513
Penman, John, et al. Clamp for shirt boards	40,682	Pooley, Charles A. Car coupler	38,361
Penn, Richard L. Gang plow	40,435	Porter, Cyrus H., et al. Art of, and mechanism for channeling soles for foot ware	39,263
Pennington, John D. Pew back	40,339	Porter, Daniel R. Thill tug	41,167
Peple, Gustavus A., et al. Apparatus for ordering tobacco	40,201	Porter, Daniel R., et al. Wrench	41,437
Pepper, James W., et al. Drum	41,227	Porter, George J. Car body	40,907
Percival, Roger Croft. Plow clevis and connections	38,990	Porter, William, et al. Tidal motive power	41,205
Pereu, Louis P. Round-about	40,479	Portz, George. Method of drying malt	39,979
Perkins, Charles G. Electric switch	40,644	Post, Frederick Howard, et al. Siphon discharge flush tank and analogous apparatus	38,179
Perkins, Samuel C. Sink trap	39,112	Potter, James, et al. Pocket tobacco case	39,732
Perkins, William W., et al. Electrical locomotive	40,451	Potts, Isaac N. Spoon	38,701
Perry, George R. and William H., et al. Saddle support for bicycles	39,309	Poulin, Damase M. Pipe	38,761
Petaluma Fruit Packing Company. Fruit jar	38,428	Poulton, William B., et al. Wrench	38,605
Peteler, Frank C. Heater	40,176	Powell, Noah M. Burglar alarm	39,691
Peter Hamilton Manufacturing Company. Cultivator	40,759	Powell, William C. Sleigh	40,751
Peter Hamilton Manufacturing Company. Feed operated gear for seeding machines	40,686	Powers, James J., et al. Machine for making clay conduits	40,202
Peter Hamilton Manufacturing Company. Seeding machine	40,631	Pratt, William. Can	38,093
Peters, Richard G. Logging boom section	41,340	Prendergast, James. Game	38,424
Petersen, Edward A. C. Oven	41,012	Preston, Leonidas M. Stocking	39,383
Peterson, Hans, et al. Car coupler	38,060	Preston, Othnel. Wire fence rail	39,874
Peterson, Swan. Spring motor	40,203	Preston, Othnel. Wire plating machine	41,397
Petrie, Henry L., et al. Nut tapping machine	40,854	Price, Benjamin I. Joint for spectacle frames	40,665
Pettit, Elihu R. Cleaner for combs	38,475	Price, R. M., et al. Nut lock	40,610
Pfanne, Heinrich. Process of and apparatus for making varnish	40,445	Price, William H. Lock	39,121
Pfaudler Vacuum Fermentation Company. Beer	39,257	Price, William H. Padlock	39,275
Pfautz, Daniel M. Spring motor for sewing machines	39,480	Pridmore, Edward. Disk harrow	39,277
Pfetsch, Jacob F. Cogged wheel	40,110	Pridmore, Henry E., et al. Mower	40,243
Pfueger, Ernest F. Spoon bait	41,129	Primeau, Louis. Hay press	41,049
Phelps, James H. Action for piano fortes	40,637	Pritchard, Henry T. Hand dating stamp	41,319
Phillips, Martin. Transposing key board	39,001	Proctor, James. Stoker for steam boilers	40,018
Phillips, Arthur J., et al. Machines for making paper boxes	39,368	Prosser, Treat T., et al. Method of making gas	40,294
Phillips, Edward. Screw cutting and pointing machine	38,837	Prouty, George Washington. Eraser	38,329
Phillips (Eugene F.) Electrical works. Electric cable	38,669	Prowse, George Roger. Oxycalcium light	34,962
Phillips, Elizabeth. Bed pan	38,732	Prud'homme, Hector. Scrubbing machine	38,223
Phillips, Jacob. Mowing machine	39,598	Prussman, Adolf. Apparatus for lifting and lowering heavy bodies	40,980
Phillips, John. Pen	39,416	Prussman, Adolf. Floating apparatus	39,687
Phillips, Simon G. Drying apparatus	41,127	Pruzman, John H. Shield for trousers	39,688
Phillips, Solomon. Mitting machine	39,026	Prybil, Paul. Drilling machine	41,408
Phillips, William A. et al. Secondary battery	39,198	Publow, James A. Spring tooth harrow	38,708
Phillips, William R. Air compressor	40,319	Puckett, William J. Opener for envelopes	40,394
Phillipson, William, et al. Tyre for road vehicles	39,106	Puckler, Henry, Count of. Device for destroying insects	39,282
Piaget, Henry Victor. Tablet for recording sales	40,225	Pullman, Albert B. Car door	40,547
Pick, Sigismund. Apparatus for drying salt	39,024	Pullman, Albert B. Hanger for doors	39,636
Pick, Sigismund. Apparatus for evaporating liquors containing salts	39,505	Pungo, William A. Brake beam	39,601
Pick, Sigismund. Apparatus for obtaining and separating salt	38,553	Purves, George, et al. Fastening for stove pipes	38,634
Pickens, James D., et al. Car coupler	39,509	Putman, Gideon V., et al. Cut off valve for steam engines	39,630
Pickett, William H. Carpet sweeper	39,700	Putnam, Ann M., et al. Machine for forging horse-shoe nails	39,386
Pickett, William H. Extension table	40,896	Putnam, John P. Sink	40,143
Pickenbrock, Fritz. Process of producing ozone water and oil	38,752	Putney, Edwin B. Bill file	39,793
Pierce, Arthur M. Coin operated automaton	38,407	Pyott, Louis T. Driving gear for wood planing and moulding machines	39,939
Pierce, Morrill S., et al. Electric heat alarm	40,314	Quenehen, Francois, et al. Machinery for decorticating and disintegrating grain	41,503
Pigott, William. Needle for sewing machines	38,777	Quenville, Hermidas. Wagon	39,576
Piggott, William, et al. Holder for bags	39,244	Raab, Joseph. Fabric for underwear	38,343
	38,542		40,474

Raabe, Max. Treatment of vegetable textile fibres for the manufacture of yarns and fabrics.....	38,072	Reutter, Samuel E. Folding base for stands.....	40,533
Radiator, A. Churn.....	39,235	Reynoldes, Christopher C., et al. Brake.....	40,812
Rae, Frank B. Controlling switch for electric railways.....	38,705	Reynolds, Edmund D. and Oliver B. Tedder for hay.....	38,582
Rae, Frank B. Electric car motor.....	38,722	Reynoldes, Humphrey H., et al. Safety gate for bridges.....	41,041
Rae, Frank B. Motor.....	38,630	Reynolds, William M. Chair for cleaning windows.....	40,122
Rae, Frank B. Switch for electric locomotives.....	39,720	Rhodes, Daniel, et al. Nut lock.....	39,157
Rae, Frank Bankson. Armature for dynamo electric machines and motors.....	38,170	Rice, Edward T., et al. Dampener for envelopes.....	39,273
Rae, Frank Bankson. Dynamo electric machines.....	38,068	Rice, Edwin W. Circuit controlling and protecting device.....	40,761
Rae, Frank Bankson. Electrical cut-out.....	38,074	Rice, Edwin W. Fuse.....	39,907
Rae, Frank Bankson. Limit switch for electricity.....	38,075	Richardson, Charles. Grate bar.....	39,987
Rae, Frank Bankson. Motor truck for electrically propelled vehicles.....	38,069	Rich, Charles C. Electrical heater.....	39,639
Rae, Frank Bankson. Switch for stationary motors.....	38,076	Rich, Jacob A., et al. Thill coupler.....	38,240
Raith, Henry. Window shutter.....	39,070	Richard, Theogene E. Evaporating apparatus.....	40,666
Raleigh, Charles. Ore pulverizer.....	39,471	Richards, Daniel. Toilet soap tablet.....	41,374
Ramsey, James W. Spark arrester.....	41,312	Richards, John E. Tobacco rolling machine.....	39,313
Rand, Addison C. Explosive compound.....	38,779	Richards, Walter S., et al. Electric battery.....	38,026
Rand, Addison C. Rock drill.....	41,093	Richardson, Almer F. Jewel holder.....	38,059
Rand, Addison C., et al. Air compressor.....	41,094	Richardson, Charles, et al. Press for cheese.....	38,359
Rand Drill Com; any. Air compressor.....	41,094	Richardson, Charles G., et al. Method of treating ores.....	38,745
Rand Drill Company. Rock drill.....	41,096	Richardson, Dwight S. Hot air furnace.....	38,643
Rand Drill Company. Rock drill and channeling machine.....	41,095	Richardson Engine and Steam-ship Co. Steam engine.....	38,978
Rands, George C. Stand for holding bottles containing poison.....	39,449	Richardson, James C. Electrical decomposition of solutions of chloride of sodium and potassium.....	38,484
Randall, Benjamin F. Fence post.....	39,183	Richardson, James C. Electrolytic production of caustic soda, caustic potash and other products from their salts.....	38,478
Randall, George J. Process of preparing and hardening lime stone.....	39,883	Richardson, Samuel Thompson. Steam engine.....	38,978
Randall, John, et al. Composition for building purposes.....	38,723	Richmond, John O. Desk and easel.....	38,793
Randall, John H., et al. Cove.....	38,270	Richter, Charles. Electric railway.....	40,270
Randall, Victor E. Stove.....	40,955	Richter, Maurice. Paddle wheel.....	40,489
Randle, Joseph T. L. Mixing machine.....	40,511	Ricks, Tillmon P., et al. Meat cutter.....	38,516
Randolph, Frederic W. Lubricating hub.....	40,728	Ridsdale, Charles H., et al. Lubricant.....	39,175
Rano, Charles O., et al. Burner for gas.....	41,332	Riedig, Carl A. Boot and shoe.....	40,581
Ranklin, John Y. Bale tie.....	39,381	Riedinger, August. Ventilator.....	39,686
Ranton, William J. Steam generator.....	41,383	Rieser, Julius M., et al. Device for securing tools to handles.....	38,546
Rappleye, Frank A., et al. Fruit box.....	40,941	Riesner, Paul, et al. Damping device for mechanical music boxes.....	41,009
Rasey, John D., et al. Auxiliary base for stoves.....	40,932	Riley, Michael. Guard for railway tracks and switches.....	41,284
Ratchford, Nicholas. Railway frog.....	38,666	Rippon, John D., et al. Handle for caskets.....	39,789
Rathbun, Edward W. Roofing composition.....	40,024	Risedorph, William J., et al. Horse hay rake.....	40,857
Rattier, Franz A., et al. Spring motor for sewing machines.....	40,861	Rishell, George P. Mechanism for forming wire strands.....	38,203
Rawdon, Lucien, et al. Clothes line.....	38,349	Rishworth, John M., et al. Machine for sorting and separating substances.....	40,471
Rayback, Balthaser S. Nut lock.....	38,749	Ritchie, Walter S., et al. Lifter for halter weights.....	40,505
Raymond, John D., et al. Attachment for raising or lowering furniture.....	38,459	Robb, Andrew F., et al. Clamp for shirt boards.....	40,682
Raymond, Stiles. Bed bottom.....	39,071	Robb, Malcolm E. Mode of attaching vehicle springs.....	41,154
Rayner, George H., et al. Method of making oxygen gas.....	39,748	Robbins, Joseph T. Stove.....	40,839
Read, Henry Y. and James G. Signal for railway crossings.....	38,775	Robert, Henry M., et al. Steam pump.....	40,012
Read, William. Solvent for gums.....	39,656	Roberts, Austin J., et al. Check puncher.....	40,457
Reaman, Abram G. Binder.....	40,184	Roberts, Edwards F. Pipe coupling.....	40,293
Reaman, Charles. Burner for hydro-carbon oil.....	40,196	Roberts, Joseph W. Tug for harness.....	38,612
Reckenzaun, Anthony. Method of making plates for secondary batteries.....	41,307	Roberts, Luke, et al. Brake mechanism for vehicles.....	39,653
Reed, Eli S. Spring motor.....	41,160	Roberts, William. Lock.....	39,186
Reed, George W. Cement.....	40,860	Roberts, William, et al. Grinding and amalgamating pan.....	39,961
Reeves, Milton O. Method of securing pulleys to shafts.....	39,232	Robertson, Emma L. T. Frying pan.....	38,686
Reeves Pulley Company. Method of securing pulleys to shafts.....	39,233	Robertson, George W. Station indicator.....	40,424
Regel, Arthur. Steilizing apparatus.....	39,533	Robertson, Richard S. Car coupler.....	40,676
Reichelt, Bruno, et al. Spring motor for sewing machines.....	40,861	Robertson, Thomas. Method of making confections.....	41,138
Reid, R. H., et al. Sash balance.....	40,370	Robertson, William J., et al. Extension ladder.....	40,569
Reid, Robert, et al. Lamp.....	39,688	Robinett, William H. Hydraulic motor.....	39,364
Reid, Robert H., et al. Liquid gauge and tap.....	40,371	Robinson, Arthur W. Friction clutch.....	41,292
Reid, Wesley G., et al. Machine for making nails.....	40,503	Robinson, Frank. Signal for railways.....	38,368
Reid, William T., et al. Pulley.....	41,186	Robinson, Frank L. Holder for shirt collars.....	41,372
Reimbold, Benjamin F. Bolting reel.....	40,967	Robinson, James D., et al. Heel block.....	38,145
Reimann, Albert L., et al. Air pump.....	40,400	Robinson, John C. Check puncher.....	40,457
Reisinger, Frank W. Draft equalizer.....	38,813	Robinson, John M. Fertilizer distributor.....	38,656
Rennison, John. Bed.....	40,786	Robinson, Robert. Carpenter's plane.....	40,252
Reitz, Daniel G. Split pulley.....	40,996	Robinson, Stillman W. Nailing machine for foot ware.....	39,284
Reliance Electric Manufacturing Company. Armature for dynamo-electric machines and motors.....	38,170	Robinson, Stillman W., et al. Nailing machine.....	39,285
Reliance Electric Manufacturing Company. Controlling switch for electric railways.....	38,705	Robinson, Thomas A., et al. Picker for looms.....	40,658
Reliance Electric Manufacturing Company. Dynamo electric machine.....	38,068	Robinson, William N. Car coupler.....	39,134
Reliance Electric Manufacturing Company. Electric car motor.....	38,722	Roche, Patrick C., et al. Canting block for saw mill carriages.....	39,280
Reliance Electric Manufacturing Company. Electric cut out.....	38,074	Rochester, Edwin. Electric car fender.....	40,949
Reliance Electric Manufacturing Company. Limit switch.....	38,075	Rochester, William Y., et al. Process of making dynamite.....	40,566
Reliance Electric Manufacturing Company. Motor.....	38,630	Rockwell, David Henry. Corner shield and protector.....	38,067
Reliance Electric Manufacturing Company. Motor truck for electrically propelled vehicles.....	38,069	Rodden, William H. Umbrella frame.....	41,419
Reliance Electric Manufacturing Company. Switch for stationary motors.....	38,076	Rodgers, Elbert S. Furnace.....	41,236
Remington Machine Company. Machine for making paper bags.....	39,984	Roe, Mary. Heating apparatus.....	41,018
Remington, William H., et al. Brake.....	39,452	Roemer, William. Corner piece for travelling bags, boxes, &c.....	39,113
Remy, Wilhelm. Method of manufacturing ribbon.....	39,668	Roeske, Henry. Filter.....	39,438
Renwick, Thomas. Grain drill.....	39,513	Rogers, Andrew W. Buffer.....	39,902
Rettiger, David. Stone cutting machine.....	38,169	Rogers, Charles D. Die for cutting off and pointing pieces of wire.....	38,321
		Rogers, Charles D. Screw eye.....	38,147
		Rogers, Elbert S., et al. Open fire place heater.....	40,606
		Rogers, George H., et al. Adding machine.....	38,089
		Rogers, James S. Gas burner for furnaces.....	39,948
		Rogers, James S., et al. Process and apparatus for making gas.....	40,810
		Rogers, John Raphael. Typograph.....	38,379
		Rogers, Lewis Hopkins. Pad for electric cells.....	38,042

- Rogers Liquid Meter Company. Meter for water. 40,376
- Rogers, Richard J. Meter for water. 40,376
- Rodgers, William H. Water indicator for boilers. 41,208
- Rohr, Herman J. Stretcher. 39,603
- Rohr, William A. Compressor for air. 39,623
- Rohrer, Henry. Tyre for vehicles. 40,667
- Rolland, Nestor. Churn. 40,230
- Ronan, Anson Groves. Holder for tools. 38,104
- Rooney, Michael. Stock tether. 38,736
- Roop, Jacob W. Sweeper. 40,352
- Root, Samuel D., et al. Cable railway. 40,591
- Root, Sandford O. Cutting pliers. 39,951
- Rosback, Frederick P., et al. Fence. 39,966
- Rose, Byron, H. Sash balance. 40,030
- Rose, George, et al. Apparatus for burning oils. 39,584
- Rose, James Ezra, et al. Sash lock. 38,905
- Rosenfeld, Ignatz H., et al. Bath tub. 38,420
- Rosenfield, William W. Apparatus for making lead pipe S-traps. 38,587
- Ross, David. Calendar. 38,167
- Ross, David, et al. Galvanic electric plasters. 38,973
- Ross, Frank A. Insulator. 40,913
- Ross, William H., et al. Mouth piece for speaking tubes. 38,802
- Ross, John F. Stove pipe. 39,458
- Ross, Oliver Perry. Fishing rod and reel. 38,858
- Ross, Robert. Electric forging machine. 38,860
- Rothrock, Lewis W. Neck yoke. 41,014
- Rothschild, Frank. Corset. 41,262
- Rousseau, Alphonse, et al. Clothes washer. 38,604
- Rousseau, Frank X. Tackle-block. 39,459
- Rousseau, Marie L., et al. Clothes washer. 38,604
- Rovello, Albert. Apparatus for obtaining copper and other metals from solutions of the salts of same. 39,633
- Rowe, George W., et al. Pneumatic tyre. 41,296
- Rowe, William S. Cigar blank. 40,808
- Roxby, Richard. Rail joint. 40,162
- Ruble American Blower and Injector Company. Blower and injector. 38,743
- Ruble, Martin R. Blower and injector. 38,743
- Ruble, Martin R. Centrifugal steam injector. 38,388
- Ruddall, Alfred. Telescope. 38,571
- Rudd, David Luther. Bar. 38,950
- Ruddell, Thomas. Grate. 38,510
- Rudolph, Justus H. Slate dressing apparatus. 40,971
- Rue, Isaac T. Method of making enamelled brick. 40,924
- Ruffin, Marie C. A., et al. Method of treating plants. 40,061
- Ruhs, Frederick. Mechanism for driving vehicles. 41,272
- Rumford Chemical Works. Baking powder. 39,962
- Runciman, John. Apparatus for manufacturing salt. 39,646
- Rund, Edwin. Water heater. 40,642
- Russell, Charles T., et al. Steam generator. 39,577
- Russell, John B. Pepsin. 40,488
- Russell, Joseph A. Coal elevating and transporting apparatus. 39,728
- Russell, William H. Elevating and transporting apparatus for freight. 40,047
- Russell and Erwin Manufacturing Company. Wood screw and method of making the same. 40,011
- Rust, Ezra, et al. Car coupler. 38,954
- Rutland, Henry N. Siphon. 38,158
- Rylands, Dan. Receptacle for preserved meats, &c. 41,075
- Sackett, Hiram B. Coal screen. 38,551
- Sabourin, David C., et al. Vise. 40,185
- Sabourin, Joseph, et al. Vise. 40,183
- Saladee, Cyrus W. Saddle for cycle vehicles. 39,190
- Salenius, Erik G. N. Churn. 39,235
- Salenius, Erik, G. N. Process of making cheese. 40,332
- Samson, Louis. Gold extractors. 38,472
- Sanborn, Alden W., et al. Lubricating cup. 40,745
- Sanders, David H., et al. Hat case. 38,805
- Sanders, Jacob, et al. Turner for music leaves. 38,518
- Sanders, Richard D. Apparatus for the manufacture of metal tubes, wire, &c., by electro deposition. 39,347
- Sanford, George S., et al. Burner for gas or oil. 40,940
- Sanford, George S., et al. Gas making apparatus. 40,939
- Sanford, William M., et al. Spring motor for screw propellers. 40,069
- Sansoucy, Charles E. Fire escape. 39,914
- Sargant, James, et al. Game. 39,005
- Saroni, Herrman S. Musical instrument. 38,772
- Saville, Clifford. Food compound. 39,058
- Sawrer, Adolph, et al. Machine for threading needles of embroidering machines. 38,581
- Sawyer, William H. Electric cable. 38,732
- Sawyer, William J. Inkstand. 41,293
- Sayers, Tom. Chair for railway rails. 40,434
- Saylor, Freeman N. Speed regulator for governors. 40,333
- Scarr, Abraham C. System of operating railway signals. 38,422
- Scarr Railway Signal Company. System of operating railway signals. 38,422
- Scates, George R. Furnace. 41,236
- Scates, George R., et al. Open fireplace heater. 40,606
- Scattergood, Henry W. Temporary binder. 41,370
- Scattergood, Henry W. Time record book. 41,202
- Shaaap, Alexander K., et al. Protector for garments. 38,505
- Schaeffer, Henry, et al. Car coupler. 39,898
- Scheer, Wm. H. Motor. 38,850
- Scheid, Adam. Hydrant. 40,177
- Schellenberger, Nicholas. Earth auger. 38,525
- Schied, Charles A. Flour bolt. 38,403
- Schiele, Lewis. Corset. 41,005
- Schifferly, Conrad, et al. Baking pan. 38,855
- Schilling, August. Construction of tea chest, hinge and cover. 38,415
- Schlesinger, Oscar. Depolarizing liquid for galvanic batteries. 41,143
- Schloerb, Henry. Shade for lamps. 39,511
- Schmahl, Edward, et al. Method of painting. 39,054
- Schmidt, Franz, et al. Apparatus for securing the lids of coffins. 39,674
- Schnarr, Henry R. Fastener for thill loops. 41,201
- Schneider, Ferdinand T. Stove. 41,330
- Schneider, Frederick W. A. Composition for electric resistance. 39,030
- Schneider, John B. Ear for vessels. 39,153
- Schneider, Leopold E. Permutation lock. 39,454
- Schnurch, Carl. Process of and apparatus for drying and steaming dyed cotton yarn. 40,019
- Schoen, Charles T., et al. Brake beam and shoe head for railway cars. 40,556
- Schofield, Richard, et al. Clamp for shirt boards. 40,682
- Schofield, Richard. Machine for cutting cloth. 41,092
- Schon, Anton. Bottle. 38,912
- Schonau, Peter W. Method of preparing fish for food. 38,756
- Schonemann, August. Apparatus for killing poultry. 39,693
- Schroeder, August. Friction coupling. 39,537
- Schroeder, Frederick W. Nut lock washer. 39,394
- Schubert, William, et al. Vessel for cooking, smelting and evaporating. 39,651
- Schulze, Otto. Apparatus for raising liquids. 39,904
- Schulze, Otto. Heating apparatus. 39,776
- Schulze, Otto. Oven. 40,712
- Schuman, John. Game. 39,005
- Schumpert, Frederick A., et al. Car coupler. 41,264
- Schutte, Louis. Injector. 39,208
- Schwalb, Jules F. T. Damper. 41,415
- Schwannecke, Henry. Fire escape. 38,641
- Schwarz, Hermann. Machine for printing and stamping vignettes. 39,696
- Schwarz, Hermann, et al. Process of manufacturing ornaments on wooden blocks, &c. 39,579
- Scobie, Mackay J. Claw clip. 39,609
- Scott, Charles W., et al. Seeding machine, cultivator, &c. 40,632
- Scott, Edward E. Safety trap for discharge pipes. 38,138
- Scott, Jacob R. Skiving machine. 41,117
- Scott, John A. Artificial fuel. 40,536
- Scott, Frank W., Ernest G. and Frank W., jr. Evaporating and concentrating apparatus. 40,912
- Scott, John, et al. Machine for covering wire, &c. 39,750
- Scott, Robert Day. Road cart. 38,282
- Scott, Robert W., et al. Knitting machine. 39,490
- Seabury, Charles E. Car coupler. 40,144
- Searing, Theodore W. Type writer. 40,791
- Searles, Orren I., et al. Device for cleaning cisterns. 41,394
- Sebring, Jame L., et al. Apparatus for playing duplicate whist. 38,399
- Sectional Standards. Pole. 39,831
- Secretan, James, H. E., et al. Clothes drier. 39,422
- Seddon, Edward H. Pneumatic tyre. 40,724
- Sedore, Nicholas. Car coupler. 38,380
- Seebeck, George. Coaster. 40,844
- Seeger, Carl H. Dental engine. 39,551
- Seeley, Stephen. Pedal of pianos. 39,044
- Seeman, Henry. Vehicle. 40,357
- Self-Threading Sewing Machine Co. Sewing machine. 40,602
- Seiberling, John F. Knotter for harvester binder. 38,129
- Seipp, Max. Multi tubular boiler. 40,600
- Seitz, Edward. Pump. 40,795
- Sellon, Charles A. Handle for pumps. 40,989
- Seltzer, Uriah D. Egg beater, masher, &c. 41,279
- Selwyn, Jasper Henry. Metallurgical process. 38,101
- Sencenbaugh, John J. Inhaler and medicator. 41,177
- Sergeant, Henry C. Compressor. 40,863
- Sergent, Henry C. Valve. 41,421
- Severance, James R. Grain binder. 39,174
- Sevigne, Lewis, et al. Screw cutting and pointing machine. 39,193
- Sewall, James H. Car heating apparatus. 38,887
- Seymour, Charles E., et al. Ore concentrator. 40,061
- Sewrey, Henry. Rotary engine. 40,377
- Shane, Carrie. Dress fitter. 39,704
- Shannon, Robert W. Bicycle. 38,947
- Shantz, Dilman B. Machine for boring holes in buttons. 41,046
- Shantz, Dilman-B. Machine for turning buttons. 40,531
- Sharp, John, et al. Liquid gauge and tap. 39,928
- Sharp, John, et al. Sash balance. 40,377
- Sharp, Joseph P. Veterinary operating table. 40,370

Sharpe, James F. Counter for boots and shoes.....	38,163	Smith, George Y. Artificial fuel.....	39,799
Sharpneck, William S. Governor for gas engines.....	40,517	Smith, George Y. Method of and apparatus for making artificial fuel.....	39,800
Shattuck, Arthur E., et al. Adding machine.....	39,276	Smith, Henry C. Spark arrester.....	40,064
Shattuck, William P. Fence machine.....	39,952	Smith, Herman S., et al. Rotary cutter for veneer or lumber.....	40,388
Shaut, Frederic E. Fastener for belts.....	40,762	Smith, Isaac and Joseph. Method of and apparatus for treating wool and other fibrous substances.....	38,677
Shaw, A. B., et al. Lighting and extinguishing apparatus for gas.....	38,874	Smith, James A., et al. Meat cutter.....	38,516
Shaw, Charles H., et al. Time stamp.....	38,347	Smith, James L., et al. Car coupler.....	39,898
Shaw, Henry and Edward. Brake.....	41,238	Smith, John H. Buckle.....	41,033
Shaw, Joseph, et al. Tube.....	39,993	Smith, John T. Oiler.....	38,585
Shaw, Nathaniel Hersey, et al. Lighting and extinguishing apparatus for gas.....	38,874	Smith, Levi F. Regulator for furnace dampers.....	40,065
Shea, John Francis. Padlock.....	39,277	Smith, Lyman. Pneumatic transfer and storage stations for food products.....	41,055
Shea, John Francis. Lock.....	39,275	Smith, Millage M. Pump.....	41,206
Sheen, Daniel R. Motor.....	46,107	Smith, Myers and Sehniar. Band saw mill.....	39,294
Sheets, Benjamin F. Saw sharpening machine.....	40,590	Smith, Nathaniel E., et al. Reamer.....	39,129
Sheffield, George S., et al. Planter for corn.....	41,108	Smith, Robert D. Casing for furnace air injector.....	39,999
Sheldon, John. Die for forming the threads of screws.....	39,353	Smith, Robert D. Sound arrester for smoke preventers.....	39,203
Shellabarger, Joshua, et al. Flood gate.....	38,435	Smith, Robert W., et al. Bookbinder's machine.....	41,002
Shely, John D. and John H. Hemp brake and cleaner.....	38,396	Smith, Rudolph C. Electrical elevator.....	41,037
Shepard, Amos. Meat cutter.....	40,312	Smith, Samuel R. Band saw mill.....	39,294
Shepard, Charles G. and Walter J. Freezer for ice cream.....	39,635	Smith, Samuel W. Telegraphic transmitter.....	39,713
Sheridan, Kitten L. Sharpener for knives.....	41,113	Smith, Solomon, et al. Clothes line.....	38,349
Sheridan, William. Wheel.....	38,712	Smith, Thomas M. Fertilizer.....	40,475
Sherk, Thomas. Wrench.....	39,239	Smith, William. Machine for cutting metal.....	40,262
Sherman, Charles P. Nut lock.....	39,135	Smith, William. Plate glass polishing machine.....	39,316
Sherman, George R. Dress form.....	41,377	Smith, William A., et al. Cut-off for pipes.....	41,418
Sherman, Thomas H., et al. Ammunition belt.....	40,275	Smith, William E. Printing and numbering machine for cheques.....	41,174
Sherman, Thomas H., et al. Gun.....	40,276	Smith, William E., et al. Fire extinguisher.....	39,701
Sherwood, Edward P. Typewriter and matrix-making machine.....	39,669	Smith, William J., et al. Signal for electric railways.....	40,109
Shimer, John N. M. Tool.....	39,304	Smith, Wright D. Dust collector.....	38,951
Shipley, Henry T. Tufting machine.....	38,816	Snuyser, Henry E. Package making and filling machine.....	40,310
Sheriff, Charles J. Jack for wagons.....	40,570	Snee, William, et al. Steam generator.....	39,577
Shirreff, Charles J. Screen door.....	40,477	Snellenberger, Cara B. and Jonathan B. Feed trough.....	40,493
Shirreff, Charles J. Screen for doors and windows.....	38,652	Snyder, Charles A. Machine for treating leaf tobacco.....	41,376
Shirreff, Charles J. Window or door screen.....	40,478	Snyder, Derry. Two-wheeled vehicle.....	39,415
Shoebottom, George M. Gate.....	38,125	Snyder, Hiram, et al. Scalper and grader for grain.....	39,194
Shoecraft, Byron and Judson. Signal for railways.....	38,268	Snyder, James W., et al. Holder for copy.....	40,097
Short, Sidney H. Armature for dynamo electric machines.....	41,218	Snyder, James W. Support for bicycles.....	40,295
Shortt, Edward G. Air and gas compression pump.....	39,372	Snyder, Waldo V. Toy.....	41,163
Shortt, Edward G. Brake mechanism.....	39,371	Snyder, Waldo V. Tricycle.....	39,348
Shortt, Edward G. Engineer's valve for automatic brake mechanism.....	39,374	Sobotka, Gustave. Separator for yeast.....	38,833
Shortt, Edward G. Exhaust valve for automatic brakes.....	39,373	Sobotka, Gustave. Method of producing clear wort.....	38,900
Shrawder, John S. Pneumatic door check and closer.....	40,228	Soby, Charles. Coin controlled apparatus for telephones.....	40,139
Shults, John Ward. Galvanic electric plaster.....	38,973	Soehnen, John H. Rake.....	41,070
Shuttleworth, Charles H., et al. Car coupler.....	38,406	Sohnelle, Otto. Sieve.....	38,477
Sichtermann, Fritz, et al. Toy.....	41,011	Soistmann, Adolph G., et al. Drum.....	41,227
Siebert, Albert. Corking machine.....	40,887	Solar Refining Company. Method of distilling petroleum.....	41,042
Siegel, John. Pencil sharpener.....	38,916	Solar Refining Company. Method of treating petroleum for removing sulphur compound.....	41,043
Sinus, Cesar, et al. Hat polishing and cleaning machine.....	39,306	Soley, Irene H. and Sabine. Indicator for stations.....	38,444
Simmons, Ross C. Refrigerator.....	39,779	Soley, Sabine. Station indicator.....	38,639
Simonds, George F. Ball bearing.....	39,248	Soley, William H., et al. Electrical locomotive.....	40,451
	39,245, 39,246, 39,247, 39,249, 39,250,	Sommer, Max. Apparatus for copying and duplicating letters.....	39,519
Simpson, Peter G. Lathe carriage.....	40,280	Sorley, Charles. Storage battery.....	39,828
Simpson, Robert. Churn.....	38,717	Sonder, Jacob J. Dump car.....	38,956, 38,957, 38,958
Simpson, Thomas H., et al. Nut tapping machine.....	41,048	Souder, Jacob J. Dumping car.....	39,101, 39,102
Simpson, Walter. Subdividing electric current.....	40,123	Souder, Jacob J. Dumping car for merchandise.....	39,102
Simpson, William S. Apparatus for casting metals in vacuo.....	40,832	Souder, Jacob J. Dumping car for railways.....	39,100
Sims, Frederick, L. H. Brick making machine.....	39,337	Soule, Oscar F. and Frank C., et al. Canning machine.....	39,986
Sincennes, Charles H. D. Safety rolling step ladder.....	38,228	Southard, Barron D. Armature for dynamos or electric motors.....	41,435
Sinclair, Edwin C., et al. Match box.....	39,421	Soutter, Robert, et al. Lid for car axle boxes.....	38,166
Singer, Jacob E. Sad iron.....	41,282	Spaetzel, Jacob. Attachment for threshing machines.....	38,791
Sisson, Hardy W. Blanket for horses.....	40,005	Spanner, Oliver. Pole for electric lights.....	39,655
Sisson, Hardy W. Heater.....	40,348	Sparrow, John M., et al. Pilot for cars.....	40,931
Skelton, Frederic C. Electric liquid alarm.....	39,740	Specht, Fred., et al. Spring motor for sewing machines.....	40,861
Skiffington, William P., et al. Steam heating system.....	39,792	Spencer, Carl M. Sleigh truck.....	38,464
Skinner, Gardiner M. Spoon bait.....	38,685	Spencer, Newel H. Plumb and level.....	38,760
Skinner, Joseph W., et al. Blow gun.....	40,059	Spencer, William B. Syringe.....	39,514
Sleicher, William, et al. Secondary battery.....	39,234	Spillman, Wm. Henry. Basket.....	38,926
Smale, John H. Wagon spring.....	41,431	Spoelstra, George, et al. Street indicator for street cars.....	40,324
Small, Charles Wasson. Organ.....	38,892	Sponenburgh, Hiram Hart, et al. Means of securing rails.....	38,953
Smith, Albin. Game counter.....	39,822	Sponenburgh, Norman B., et al. Means of securing rails.....	38,953
Smith, Anthony P. Apparatus for tapping water or other mains.....	40,770	Sprague, Almerin R. Ink well cover.....	41,289
Smith, Charles A., et al. Receptacle for feeding grain to live stock.....	39,838	Sprague, Austin V. M. Clothes drier.....	39,150
Smith, Ella T. H., et al. Method of treating gums.....	38,757	Sprague, Welcome. Machine for cutting green corn off the cob.....	39,725
Smith, Elmer S. Steam engine.....	40,383	Sprague Thos. S. & Son. Band saw machine.....	39,903
Smith, Enory E. Holder for labels.....	41,365	Springfield Foundry Company. Hoisting apparatus.....	40,132
Smith, Frederick W. Apparatus for the production of printing for the use of the blind.....	39,554	Sprunt, John D. Vessel for containing liquids.....	40,921
Smith, George D., et al. Cattle guard.....	38,387	Staber, George, et al. Embossing and ornamenting machine.....	39,431
Smith, George David, et al. Device for securing guard rails in place.....	38,046	Stacy, George Gould. Rail joint.....	38,945, 40,409
Smith, George J., et al. Digger.....	40,699	Stader, Lambert, et al. Coffin.....	38,035
Smith, George, et al. Jack.....	40,994	Stafford, Frank J. Arc lamp.....	40,289
Smith, George H., et al. Method of treating gums.....	38,757	Stafford, William. Flange for loom beams and warper beams.....	38,164
Smith, George W. Washing machine.....	39,844	Stager, Henry E. Return bends for steam radiators.....	38,607
Smith, George Washington. Swing.....	38,838	Stager, Henry E. Steam radiator attachment.....	38,606
Smith, George W., et al. Band cutter and feeder.....	41,316		

Stalker, Neil. Bridle bit.....	41,335	Story, Robert, et al. Car coupler.....	38,548
Stamford, James L., et al. Gas condensing and enriching apparatus.....	39,755	Stothers, James. Wheel.....	40,551
Standard Electric Company. Secondary battery.....	38,376	Stoughton, Homer R., et al. Cart saddle.....	40,454
Standard Hub Company. Process of seasoning hub blocks.....	38,288	Stovel, James A. Sifter for cinders.....	38,741
Standish, William H., et al. Pulley.....	41,186	Stow, Enos E. Tinsmith's machine.....	41,050
Stanfield, Charles E. Journal bearing for railway cars.....	41,399	Stowell, Henry F. Soap holder and distributor.....	38,969
Stanford, Robert, et al. Calculator.....	40,222	Streeter, Emma Augusta. Foot support for telegraph poles.....	39,136
Stanley, William. Dynamo electric machine.....	39,345	Streeter, Nelson R. Bag holder.....	40,483
Stanworth, Levi. Bowl for closets.....	39,269	Stringfellow, John H. W. Method of treating liquid hydrocarbon.....	40,073
Stanworth, Levi. Flushing device for sewers.....	39,279	Strobridge, Clarence S. Loom.....	38,589
Staples, John A. Spring support for upholstery.....	40,963	Strom, Axel A. Frog for railway rails.....	41,306
Staples, John A. Support for upholstery springs.....	39,301	Strom, Axel A. Method of manufacturing tie bars and connecting rods for railways.....	38,445
Staples, Rossell H., et al. Brake gear for railroad cars.....	39,709	Strom, Axel A. Tie bar and side plate for railway tracks.....	38,446
Stapleton, Leonard. Washing machine.....	38,366	Strom, Axel A. Switch for railways.....	38,434
Stark, Andrew. Knotter for grain binders.....	41,059	Strom, Edward. Vehicle running gear.....	41,338
Stark, Cranston A. Artificial stone.....	38,617	Strong, George W., et al. Box-making machine.....	38,711
Stark, David. Car coupler.....	39,995	Strother, George B., et al. Animal trap.....	40,976
Starker, Sidney. Machine for grinding, crushing or disintegrating grain.....	39,627	Strouse, James W. and Albert B. Process of and means for increasing the flow of natural gas.....	39,621
Starkey, William H. and James. Car coupler.....	39,231	Strowger, Almon B. Indicating electric switch and current reverser.....	39,964
Staver, Charles F., et al. Ore concentrator.....	40,377	Strowger, Almon B. Telephone and electrical exchange.....	38,372
Steator, Henry D. Case for preserving merchandise in a moist condition.....	40,438	Strowger, Almon B. Telephone and other electrical exchanges.....	39,866
Stebbins, Timothy, et al. Machine for making envelopes and placing enclosures therein.....	39,575	Strowger Automatic Telephone Exchange. Indicating electric switch and current reverser.....	39,964
Stedman, John J. Artificial denture.....	39,391	Strowger Automatic Telephone Exchange. Telephone and electrical exchange.....	38,372
Steel Belt Fastener Company. Fastener for belts.....	39,580	Strowger Automatic Telephone Exchange. Telephone and other electrical exchanges.....	36,866
Steel Belt Fastener Company. Process of and die for making belt fasteners.....	39,927	Strumbert, John D. Sectional extension ladder.....	41,219
Steele, David R. Controller for clutches.....	39,726	Struthers, Gaven. Step ladder.....	40,548
Steen, Samuel P. Plate printing press.....	39,362	Stuart, Herbert Akroyd, et al. Gas engine.....	38,935
Steffen, Carl. Apparatus for obtaining pure white sugar by lixiviation.....	41,361	Stuart, Sinclair. Method of constructing ships.....	40,001
Steffen, Carl. Apparatus for refining sugar.....	41,358	Stuart, William. Machine for making nets for fishing.....	40,093
Steffen, Carl. Process of making sugar from molasses.....	39,853	Stubbs, Jesse. Process of burning clay for paving material.....	38,298
Steffen, Carl. Process of refining sugar by lixiviation.....	41,362	Stuckey, Joseph A. Stopper for bottles.....	39,941
Steffen, Carl. Process of washing and boiling sugar for obtaining grain sugar.....	41,360	Stutley, James S. P. Incandescent burner for hydrocarbon gas.....	39,980
Steffen, Carl. Process of working up sugar juice into grain sugar.....	41,359	Subers, Lawrence A., et al. String for musical instruments.....	38,297
Stellway, Fritz. Gas lamp.....	39,573	Sugg, William T. Ventilating apparatus.....	40,494
Stelzer, Carl F. W., et al. Process of producing ozone water and oil.....	38,407	Sullivan, Charles A., et al. Boiler.....	39,168
Stephan, Franz. Machine for cutting beet roots.....	38,700	Sullivan, Michael. Guide rods for tops of freight cars.....	38,066
Stephani, John. Mower.....	40,480	Suppas, Maximilian M. Rail for railways.....	39,130
Stepler, John. Buck-saw.....	38,260	Suydam, John. Pipe coupling.....	40,872
Steger, Andrew Welton, et al. Typewriting machine.....	38,083	Swain, Walter, et al. Tyre for road vehicles.....	40,225
Sterns, Jacob. Automatic fastener.....	41,063	Swann, Thomas A. Protector for closet seats.....	38,308
Stevens, Arthur L., et al. Machine for making paper bags.....	39,984	Sweet, Thomas, et al. Car coupler.....	39,968
Stevens, Charles W. Method of making artificial stone.....	39,932	Swegles John. Axle cutter.....	39,752
Stevens, Gerrit, et al. Street indicators for street cars.....	40,324	Swin, William E. Signal for railroads.....	41,079
Stevens, Joseph, et al. Boat raising and lowering device.....	40,858	Swindley, Harry J. Wheel for vehicles.....	39,660
Stevens, William E. Vehicle.....	40,182	Sykes, William. Joints for pipes.....	40,224
Stevens, Samuel S. Centrifugal pulp dryer.....	40,557	Sylvester, Richard. Cultivator.....	39,587
Stevens, William X., et al. Dress shield.....	39,865	Syracuse Specialty Manufacturing Co. Hose clamp.....	39,012
Stevenson, John E., et al. Cultivator.....	41,309	Szarbinowski, Max. Snow plough.....	39,535
Stewart, Benjamin F. Sheaf carrier for harvesters.....	40,248	Szarkowski, John M. Press shoe for grain drills.....	38,309
Stewart, John J., et al. Post hole digger.....	40,936	Taber, Benjamin F. Rotary pump.....	40,384
Stewart, Richard C. and Wallace A., et al. Horse-shoe.....	40,537	Tabor, Harris. Moulding machine.....	38,832
Stewart, Robert E. Machine for printing paper bags.....	40,231	Tabor Manufacturing Company. Moulding machine.....	38,832
Stewart, William C. Machine for moulding heel stiffeners.....	40,432	Taft, George W., et al. Machine for making, repairing and clearing roads.....	40,361
Sthresley, Elizabeth. Typewriting machine for the blind.....	38,447	Tait, Joseph. Propelling power.....	38,177
Stickeman, George. Book shelving.....	40,347	Talbot, Benoit G. Tartaric acid.....	39,131
Stickler, Wilson H. Lubricant and steam packing.....	40,473	Talbot, Daniel H. Machine for stacking hay, &c.....	40,468
Stickney, Allison M. Machine for cutting soles and other forms.....	38,423	Talbot, William. Method of and apparatus for making woven fabric.....	40,880
Stickney, Charles W. Process of roasting sulphur-bearing ores.....	39,944	Talbot, William. Warp operating mechanism for cross weaving.....	40,232
Stiles, Clifford A., et al. Axle.....	40,213	Talbot, William. Woven fabric.....	40,881
Stiles, Rivington A., et al. Car brake.....	41,162	Talkington, James M., et al. Tenderer for meat.....	40,507
Still, William Joseph, et al. Copy holder for typewriters.....	38,085	Tallmadge, James W. Gas apparatus.....	39,552
Still, James Henry. Wooden shovel.....	38,047	Tambo, Robert C. Coupling for breast collars.....	39,937
Stilson, Amos Clinton. Shaft and journal box.....	38,025	Taplin, Albert J. Bulletin board.....	41,007
Stimson, Frederick J. Key board for musical instruments.....	40,255	Taro, Charles. Toe weight.....	39,184
Stinson, Edward and Alexander A., et al. Holder for bags.....	38,542	Tarrant, Louis H. Sponging iron.....	39,211
Stitzel, Frederick. Electric semaphore.....	39,445	Tate, Robert. Hot air furnace.....	40,415
Stitzel, Frederick, et al. Electric semaphore.....	39,430	Tattersall, Arthur A. Brace.....	41,121
St. Denis, Marie H. Car coupler.....	38,834	Tattersall, Arthur A. Breast drill and brace.....	39,824
St. George, Percival W. Bin for street sweeping.....	38,566	Tavernier, Alphonse E., et al. Apparatus for making wire.....	39,729
St. John, Boswell H. Type bar.....	40,568	Taylor, Alfred. Hydraulic stump extractor.....	38,161
St. John, Garland B. Gear connection vehicles.....	39,746	Taylor Bros. Brick.....	41,228
Stock, Charles L. Apparatus for separating oil and water from gas.....	38,695	Taylor, Brownlee W. Collector for fares.....	40,504
Stocking, Jerome D., et al. Fire heater.....	40,395	Taylor, David H., et al. Refrigerator and elevating cupboard.....	41,334
Stombs, Daniel S. Log carrier.....	39,141	Taylor, Frederick. Tool for making cocks, valves, &c.....	40,075
Stone, Carl O. Snow shoe.....	40,965	Taylor, Isaac. Lamp.....	39,376
Stone, Charles E. Recorder for cash.....	39,795	Taylor, James H. Washing machine.....	40,342
Stone, Harry B., et al. Fruit gatherer.....	40,134	Taylor, James McDowell, et al. Cloth measuring machine.....	39,200
Stone, John Henry. Ventilator and damper.....	38,849	Taylor, John D., et al. Drench horn.....	38,689
Stone, Parley A., et al. Method of making boots and shoes.....	40,272	Taylor, Warren H. Lock.....	38,245
Stone, William M. Apparatus for sorting nails.....	38,789	Taylor, William W., et al. Printing telegraphs.....	40,190
Storey, Albert H. Apparatus for cleaning knives.....	38,584		

Taylor, Samuel J. Change maker	40,816	Thomson, Judson L. Rivet slotting machine	40,287
Taylor, Walter M. Artificial sponge	41,133	Thomson, John. Method of and means for measuring fluids	40,954
Teague, Francis. Meter for electricity	39,981	Thomson, John, et al. Meter for water	40,992
Teague, Richard H., et al. Endoscopic instrument	39,632	Thomson Meter Company. Meter for water	40,992
Teale, Walter, et al. Signal for vessels	40,082	Thomson, William. Valve	40,662
Teel, Joseph. Car coupler	40,113	Thomson, William, et al. Apparatus for forging screws by rolling	41,212
Tellier, Charles. Apparatus for producing motive power	38,537	Thorn, Frederick A. and George. Decoy	40,234
Temple, Benjamin, et al. Starter for cars	39,819	Thornbeck, John. Folding rocking chair	40,717
Temple, William G., et al. Apparatus for drawing off aerated liquids	40,601	Thornbeck, John. Rocking chair	38,312
Tenney, Mary Josephine. Screen for doors	38,927	Thorne, James. Lamp	40,263
Terens, Nicholas Henry. Cover and cooler for milk cans	39,132	Thornton, John. Arrester for sparks	40,131
Terry, David C., et al. Nut lock	39,121	Thornycroft, John I. Steam generator	39,547
Thacher, William A. Dumping car	40,956	Thornycroft, John I. Steam generator	39,570
Theermann, William P., et al. Pulsating steam pump	38,418	Thorp, Adelbert H. Time signal for railways	40,776
Therien, François X. Washing machine	38,544	Throop, Montgomery H., et al. Parlour and sleeping car	38,176
Thibault, Joseph C. Aerator for milk	39,086	Thrower, James G. Appliance for handling invalids	39,908
Thiele, Maximilian, et al. Toy	41,011	Thuener, William, et al. Hot air furnace	39,512
Thies, John B., et al. Autographic register	38,199	Thurston, Douglas A. Window jack	38,369
Thissen, John H., et al. Kiln	40,764	Tiffany, Albert R., et al. Tag wiring and bundling machine	38,320
Thoenes, Carl G. and Friedrich A. Adhesive material for use on driving belts	40,439	Tilghman, Benjamin C. and Richard A. Method of making chilled iron globules	41,173
Thom, John C., et al. Work holder and safety guard for wood cutting and similar machines	40,514	Tilghman, Charles C. Egg crate	39,426
Thomas, Alice E. and George. Grater	40,154	Timmis, William. Nut lock	38,748
Thomas, Robert J., et al. Method of lubricating the journals of car axles	41,203	Timms, Charles H. Door check	40,833
Thomas, Septimus. Machine for sizing and cleaning coal	39,447	Tinker, Albert A., et al. Flour cabinet	38,778
Thomas, Sylvanus M., et al. Attachment for looms	39,120	Tobias, Victor, et al. Chocolate	38,057
Thomas, Thomas C. J. Gas lamp	39,481	Tolbert, Martin L. Shears	39,645
Thompson, Cassius C. Pottery dipping tube	39,801	Tompsett, Henry T., et al. Coil and battery for electro-medical apparatus	40,049
Thompson, George A., et al. Floor jack	38,776	Tomsa, Vaclav. Sewing machine	40,229
Thompson, James. Fastener for oven doors	39,139	Toomey, Samuel. Skeleton wagon and sulky thill	39,016
Thompson Manufacturing Company. Inking attachment for job printing presses	38,197	Topp, Lena A. Support for garments	40,948
Thompson, Robert H., et al. Time stamp	38,347	Torney, George P., et al. Device for securing tools to handles	38,546
Thompson, William A. Inking attachment for job printing presses	38,197	Torrey, Francis B. Journal bearings	40,559
Thompson, William H. Recorder for cash	39,340	Totman, James E., et al. Lubricating device	38,144
Thompson, William H., et al. Apparatus for revolving and elevating the screw propeller of a boat	40,142	Tourangeau, Napoleon, et al. Reel for winding and unwinding yarn	39,296
Thompson, William H., et al. Vehicle motor	38,792	Tousley, Edgar M. Trolley for electric railway cars	39,930
Thomson, Cathcart. Mode of drying fish	39,397	Towne, Alfred E., et al. Staple driving machine	40,455
Thomson, Frank H., et al. Device for securing tools to handles	38,546	Tower, George K. Valve	41,187
Thomson Electric Welding Company. Electric welding apparatus	38,082	Townsend, John J. Recording compass	41,433
Thomson Electric Welding Company. Electric welding transformer	38,663	Townsend Marine Invention Co. Recording compass	41,433
Thomson Electric Welding Company. Electrical apparatus for welding rings	38,080	Tracy, Harriet R. Elevator	38,570
Thomson Electric Welding Company. Method of welding rings by electricity	38,078	Tracy, Harriet R. Sewing machine	40,426
Thomson Electric Welding Company. Sliding clamp for electrical welding apparatus	38,081	Traill, Alexander. Bracket for window shades	39,085
Thomson Electric Welding Company. Transformer for currents	38,079	Trask, Charles H. Milling machine	39,870
Thomson, Elihu. Arc lamp	39,935	Traveler's Portfolio Company. Portfolio for collars and cuffs	39,061
Thomson, Elihu. Arrester for lightning	39,815	Traver, Adelbert L. Trimming attachment for sewing machines	40,320
Thomson, Elihu. Incandescent lamp	39,814	Travis, John J., et al. Key fastener	38,328
Thomson, Elihu. Induction discharge protector for welding apparatus	38,294	Travis, John J., et al. Stove pipe and collar fastener	38,327
Thomson, Elihu. Apparatus for electric soldering and cementing	38,292	Treat, Harvey W., et al. Hat polishing and cleaning machine	39,306
Thomson, Elihu. Method of electric soldering, cementing, &c.	38,576	Treat, Joseph A. Register for cash	39,829
Thomson, Elihu. Method of electric welding	38,373	Treblecock, William. Lifter and lock for skylights	39,599
Thomson, Elihu. Method of working metals by electricity	38,293	Trexler, Milton W. Car coupler	39,227
Thomson, Elihu. Process and apparatus for forming and welding metals by electricity	38,661	Trine, Samuel G. Car coupler	38,266
Thomson, Elihu. Process of electric welding	38,662	Trott, John R. Vaginal syringe	38,225
Thomson, Elihu. Section insulator and lightning arrester for electric railways	39,881	Trotter, Alexander C., et al. Spike	38,337
Thomson, Frederic P. Holder for check reins	41,313	Trousers Stretcher Company. Trouser stretcher	40,916
Thomson, John T. Machine for cutting soap and cheese	38,316	Trumble, Chauncey B. Trap for animals	38,273
Thomson-Houston International Electric Company. Circuit controlling and protecting device	40,761	Trumviller, Frank A. Beer faucet	40,842
Thomson International Electric Welding Company. Apparatus for soldering and cementing	38,293	Trussel Automatic Freezing Company. Refrigerating compound	39,195
Thomson International Electric Welding Company. Induction discharge protector for welding apparatus	38,294	Trussell, Wilbert C. Refrigerating compound	39,195
Thomson International Electric Welding Company. Method of electric soldering, cementing, &c.	38,576	Tschantz, Abraham J. Oil can	39,188
Thomson International Electric Welding Company. Method of electric welding	38,373	Tulloch, Alexander E. Whip socket support	40,611
Thomson International Electric Welding Company. Method of working metals by electricity	38,293	Turner, Adelaide S. Night cap	38,508
Thomson International Electric Welding Company. Process of and apparatus for forming and welding metals by electricity	38,661	Turner, Charles W. Indicator for laundries	38,257
Thomson, Judson L. Rivetting machine	40,286	Turner, Edmund H. Clothes pin	39,842
		Turner, Ephraim M., et al. Electric elevated railway	41,424
		Tryon, Frank, et al. Valve	40,914
		Turner, Harry T., et al. Oil	38,133
		Turner, Leonidas H. Ditching machine	40,340
		Tweles, Louis, et al. Picker for looms	40,658
		Turney, Frederick N. Process and apparatus for degreasing leather	40,549
		Turreff, William J. Machine for corrugating veneer	40,718
		Turton, Jabez. Process of extracting metals from ores	40,329
		Tyler, Alfred Hugh. Machine for drilling or boring holes, for nuts, &c.	38,981
		Tyman, Joseph. Belt	40,961
		Typewriting Machine Company. Typewriter	40,829
		Uhlig, Franz. Winch	39,923
		Uhlig, Franz. Winch for ship masts	40,043
		Unlauf, Otto. Fish plate for rails	40,583
		Unbehend, Jacob J. Rivetting machine	40,286
		Unbehend, Jacob J. Rivet slotting machine	40,287
		Underwood, Charles M. Inscription and motto plate	38,787
		Underwood, Joseph B. Cigarette making machine	39,111

Union Construction Company. Cess pool.....	41,350	Walker, Lewis C. Sash fastener.....	39,446
Union, Frank L. Cess pool.....	41,350	Walker, Sarah L. Stove.....	41,004
United States Fire Roofing Company. Method of construct- ing fire proof buildings.....	39,530	Walker, William J. Nut lock.....	38,030
Universal Sewing Machine Motor Attachment Company. Spring motor.....	41,160	Wallace, Roger W. Traction apparatus.....	39,335
Val D'Aosta Syndicate. Apparatus for making wire.....	39,729	Wallace, William T. Rack for hay.....	40,163
Val D'Aosta Syndicate. Apparatus for use in obtaining copper.....	40,655	Wallich, Washington. Buttonhole attachment for sewing machines.....	38,526
Van Arsdale, Charles B. Pick.....	38,983	Walser, Charles Joseph. Horse detacher.....	38,869
Van Arsdale, William. Bridle bit.....	38,774	Walters, Frank A. Method of producing artificial gramin- g on the surface of wood.....	39,974
Van Beck, George L., et al. Electric elevated railway.....	41,424	Walsh, John E. Crane and elevator.....	38,812
Van Buren, Robert, et al. Machine for making clay con- duits.....	40,292	Walsh, Robert F. Heater for water.....	40,429
Van Buskirk, Samuel A., et al. Process of embellishing wood.....	40,990	Walsh, Philip. Brake for cars.....	39,774
Van Depoele, Charles J. Alternate current electric train system.....	38,558	Walton, Henry, et al. Cant hook band.....	38,890
Van Depoele, J. Alternate current induction motor.....	38,556	Wanamaker, Charles B. Weighing apparatus for vehicles.....	38,431
Van Depoele, Charles J. Electric engine.....	34,557	Wanamaker, Charles Benjamin. Weighing apparatus for vehicles.....	38,970
Van Depoele, Charles J. Electric motor.....	41,294	Wanamaker International Car Scale Company. Weighing apparatus for vehicles.....	38,431
Van Depoele, Charles J. Electric railway system.....	38,559	Wanamaker International Car Scale Company. Weighing apparatus for vehicles.....	38,970
Van Depoele, Charles J. Induction motor.....	38,555	Wandel, Christian. Apparatus for sorting cellulose.....	40,447
Van Depoele, Charles J. Multiplex circuit electric motor.....	38,569	Wands, John C. Car roof.....	40,709
Van Depoele, Charles J. Draw gear for railway cars.....	40,650	Wanner, Martin. Composition for use in heating systems.....	39,765
Van Dorsten, Alvin. Fruit box.....	40,941	Ward, Alfred R. Fixing and washing tank for photogra- phic purposes.....	40,527
Van Dusen, Harlan P., et al. Drier for lumber.....	41,346	Ward, Charles. Rotary engine.....	40,010
Van Duzen, L. Fayette C. Drier for cigars.....	41,325	Ward, DeWitt C., et al. Joint coupling.....	39,307
Van Gulpen, Max. Apparatus for making fillers for cigars.....	49,977	Ward Motor Company. Rotary engine.....	40,010
Van Houten, Frank H. Moulding machine.....	38,252	Wardell Sewing Machine Company. Wax thread sewing machine.....	39,359
Van Pelt, Nicholas N. Whiffletree.....	40,181	Wardell, Olin N. Wringer for mops.....	40,197
Van Valkenburg, Randall T. Chemical fire engine.....	40,317	Wardell, Simon W. Method of winding balls.....	41,098
Van Vleck, William J., et al. Leggins.....	38,153	Warner, De Ver H. Corset.....	38,488
Valiant, George. Boots and shoes.....	40,324	Warner, Joel S., et al. Truss.....	38,579
Vandermeer, John, et al. Street indicator for street cars.....	40,495	Warnock, (James) and Co. Vehicle spring coupler.....	38,902
Vanderweay, Maurice A., et al. Camera shutter.....	39,526	Warren, Andrew. Lifting jack.....	40,274
Vanduzen, Benjamin C. and Ezra W. Gas or gasoline engine.....	38,979	Warren, Frederick P. Method of making life-preservers.....	41,081
Vanes, John. Crane.....	39,576	Warren, Jean C., et al. Truck.....	39,242
Vansteenkiste, Achille, et al. Machine for decorticating and disintegrating grain.....	38,486	Warrington, Henry. Kilm.....	40,820
Vandyke, John. Carpet stretcher.....	38,503	Wason, Charles W., et al. Lightning arrester.....	39,329
Vandyke, John. Washing machine.....	39,295	Waterhouse, Addison G. Arc lamp.....	40,982
Varden, Maurice M., et al. Propelling power.....	38,315	Waterhouse, Addison G. Meter for electricity.....	40,983
Varley, James A. Boiler and toaster.....	41,126	Waterlin, Joseph H., et al. Frog and switch for railways.....	38,836
Varley, John J. Method of making screw stoppers.....	39,557	Waterloo, Joseph H., et al. Frog and switch for railways.....	38,375
Varley, Richard, et al. Electric time call.....	38,092	Waterous, Samuel H. Butter worker.....	38,436
Vaughan, Alden R. Winder for main springs.....	38,854	Waters, Samuel H. Binder.....	40,341
Vaughan, John David, et al. Alarm.....	38,673	Watrous, Earl G. Grain binder.....	39,719
Velten, Ludwig, et al. Ferrule.....	41,203	Watson, Benjamin F., et al. Screw driver.....	38,324
Verdin, Alvis N., et al. Typographic machine.....	49,670	Watson, George A., et al. Process of producing heating gas.....	40,974
Vernest, Jean. Electric battery.....	40,634	Watson, Thomas G. Varnish bottle.....	38,405
Vernon, Charles W., et al. Shifting seat for vehicles.....	39,819	Watson, William C. Car coupler.....	40,412
Vernon, Elias, et al. Starter for cars.....	39,729	Watson, William Lyle. Insecticide.....	38,102
Viarengo, Emile, et al. Apparatus for making wire.....	39,633	Watt, Sem P., et al. Nailing machine.....	39,285
Viarengo, Emile, et al. Apparatus for obtaining copper and other metals from solutions of the salts of same.....	40,603	Wattie, William. Brooch.....	38,142
Vick, John B., et al. Hoist and travelling carrier.....	40,471	Watts, Arthur J. Car coupler.....	39,021
Vickers, Joseph, et al. Machine for sorting and separating substances.....	39,243	Watts, Arthur J. Car coupler.....	40,095
Victorson, Victor. Method of finishing wood surfaces.....	39,334	Weaver, Ephraim E., et al. Incandescent electric lamp.....	39,043
Viel, Arthur H. Spring bed.....	39,423	Webb, Arthur W. Egg tester.....	40,535
Vegal, Clifford L., et al. Chain belt.....	38,727	Webb, Francis M. Medicinal compound.....	39,748
Vincent, Byron C., et al. Ladder.....	40,591	Webb, George, et al. Method of making oxygen gas.....	39,775
Vinegarl, Gordon C., et al. Cable railway.....	38,665	Webber, Josiah A. Wheel for cars.....	41,366
Vinson, Samuel L., et al. Drive chain.....	40,033	Webber, Wesley. Deep well drilling apparatus.....	39,775
Voelkner, Henry A. Ampere volt potential controller.....	39,142	Webber, William O. Governor for steam engines.....	40,792
Vollinger, Frederick W., et al. Excavator.....	39,585	Webster, Harold A. Boot and shoe buffing machine.....	38,359
Von Dolivo Dobrowsky, Michel. Electric transformer.....	40,036	Webster, William, et al. Press for cheese.....	39,754
Von Eulenfeld, Ferdinand. Penholder and blotter.....	40,255	Wedlake, James K., et al. Finger bar for harvesters.....	39,901
Von Janko, Paul. Key board for musical instruments.....	40,541	Wedlake, James K., et al. Grain binder.....	39,900
Voss, Dettob C. Art of making filaments for electric light- ing.....	40,807	Wedlake, James K., et al. Grain binder.....	38,963
Voss, William. Truck.....	38,607	Wedlake, James K., et al. Harvester binder.....	39,899
Vradenburg, Elijah, et al. Straw separator for threshing machines.....	39,870	Wedlake, James K., et al. Sheaf carrier for harvester binders.....	38,157
Vreeland, Jeremiah. Gum moistner.....	40,767	Weed, Alfred. Manufacture of files and rasps.....	40,981
Vreeland, Warren. Weed exterminator.....	40,937	Weed, Alfred. Method of making rasps.....	40,953
Wad-El-Ward, James, et al. Mower.....	40,318	Weed, Henry T., et al. Electrolytical electrometer.....	39,929
Waddell, Montgomery, et al. Secondary battery.....	40,734	Wehrin, Jacques. Soldering machine.....	39,556
Waddell, William H. Signal for electric railways.....	40,255	Weicher, John H., et al. Bob sleigh.....	41,015
Wade, Samuel. Water motor wheel.....	38,610	Weidaw, Frank T. Clamp for hose.....	38,824
Wadleigh, Harvey M. Grain cleaning machine.....	33,099	Weinnett, Peter W. Fence post.....	38,108
Wadleigh, Harvey M., et al. Axle.....	39,357	Weises, Jean, et al. Method and apparatus for producing plastic ornaments on profile borders.....	39,578
Wagandt, Charles L. Plate for baking purposes.....	41,429	Wigert, Doctor L. Exciting fluid for galvanic batteries.....	38,781
Wagner, Daniel, et al. Hot air pipe and air flue.....	40,459	Weightman, Walter S., et al. Egg-carrying package.....	39,715
Wainwright, Jacob T. Process of reducing ore.....	49,538	Weineland, Charles, et al. Electric semaphore.....	39,430
Wait, Frederick W. Metallic pipe coupling.....	38,106	Weinman, Christian J., et al. Autographic register.....	38,199
Wait, Winfield Scott. Tinware vessels.....	39,181	Weinrich, Moriz. Art of cleaning and washing raw sugar.....	41,364
Waite, Parker. Knee for bob-sleighs.....	40,845	Weinrich, Moriz. Method of making and purifying sac- charine solutions.....	41,363
Waldbrook, James. Potato separator and cleaner.....	41,398	Weir, Andrew H., et al. Car coupler.....	39,083
Waldvogel, George J. Seat for stools, &c.....	39,993	Welch, Charles K. Rubber tyre and metal rims for vehicle wheels.....	40,630
Walker, Edwin, et al. Tube.....	40,172	Weller, Chester A., et al. Pill machine.....	40,502
Walker, James, et al. Car coupler.....	40,172	Wells, Arthur J. and Helen A. Partition.....	38,356
		Wells, Frederick L. Car coupler.....	38,158

Wells, George W. Chair for railway rails.....	40,780	Wilcox, Wellington C., et al. Hoist and travelling carrier.....	40,603
Wells, Harlan P., et al. Carriage.....	41,216	Wilcox, Alfred B. Doll support.....	41,239
Wells, Matthew, et al. Apparatus for forging screws by rolling.....	41,212	Wilder, Elihu. Anti-rattler for thill couplings.....	40,408
Wells, Matthew. Screw propeller.....	39,527	Wiley, Horace B. and Thomas W., et al. Kitchen utensil.....	38,246
Wells, Osbern, et al. Car coupler.....	41,264	Wilfert, Andreas. Harrow.....	40,437
Wells, William, et al. Scoop.....	39,074	Wilgus, Daniel C. Sprinkler for lawns.....	40,542
Weltner, Charles. Nail bag.....	38,847	Wilder, Charles H. and Luke A., et al. Method of manufacturing gas.....	38,329
Weltz, Fedor G., et al. Level tube for surveying instruments.....	40,862	Wilhite, Edmund S. Band cutter and feeder.....	40,960
Wemple, Andrew, et al. Band cutter and feeder.....	41,316	Wilkin, Charles F., et al. Pump.....	40,335
Wenstrom, Jonas and Olaf, et al. Apparatus for feeding to magnetic separators.....	41,231	Wilkin, Theodore S. Log turner.....	40,617
Wenstrom, Jonas and Olaf. Magnetic separator.....	41,165	Wilkins, Alexander G. Holder for shoe button fasteners.....	38,360
Wentworth, William H., et al. Gatherer for fruit.....	40,134	Wilkins, Theodore S. Gang saw mill.....	40,313
Wentz, Joseph H. Scraper for band saw pulleys.....	40,908	Wilkins, Thomas C. Harvester.....	40,440
Wernan, Max, et al. Changing tablet for post boxes.....	39,567	Wilkins, S. B. and Co. Circular knitting machine.....	38,150
West, James. Envelope.....	40,828	Wilkinson, William F., et al. Holder for ballots.....	39,529
West, James. Machine for making paper bags.....	41,195	Wilkinson, Alfred. Furnace and furnace grate.....	40,995
West, James B. Brick.....	41,228	Wilkinson Manufacturing Company. Furnace and furnace grate.....	40,995
West, Noah Dieble. Protector and cell for queen bees.....	38,404	Willan, Isaac. Low water alarm and steam gauge.....	40,826
West, Thomas. Hosiery.....	39,996	Willard, Hiram P. Car axle.....	39,604
Westerdahl, Anton R., et al. Mining machine.....	39,387	Willcox, Alfred B., et al. Mechanical movement.....	39,727
Westgate, Joseph John, et al. Over stocking.....	38,851	Willett, George B., et al. Holder for car tickets.....	38,134
Western Burnt Clay Ballast and Paving Company. Process of burning clay for paving material.....	38,298	Willey, George W., et al. Method of and means for making lasts and patterns therefor.....	41,226
Western Smoke Preventer Company. Casing for furnace air injectors.....	39,999	Willey, George, et al. Method of making boots and shoes.....	40,272
Western Smoke Preventer Company. Sound arrester for smoke preventers.....	39,203	Willford, Joseph L. Roller mill.....	39,977
Westervelt, Bertha. Curling iron.....	39,259	Willi, Theodore, et al. Burner for crude oil.....	38,084
Westervelt, George C. Plow point.....	39,266	Williams, Charles E. Washboard.....	39,321
Westinghouse Electric Company. Dynamo-electric machine.....	39,345	Williams, Charles J., et al. Trap for waste water pipes.....	38,835
Westinghouse, George. Car heating apparatus.....	39,412	Williams, Charles T. Cement.....	40,860
Weston, Charles W., et al. Sewing machine.....	40,602	Williams, David F. Machine for forging horse-shoe nails.....	41,355
Westphalen, Rudolph Graf. Roofing fabrics.....	39,099	Williams, Francis M. Time safe-bolt retracting device.....	38,759
Westwood, John T., et al. Refrigerator and elevating cupboards.....	41,334	Williams, George H. Cover for fruit baskets.....	38,118
Wetmore, Earl P., et al. Brush holder for dynamo-electric machines.....	40,930	Williams, George L. Boot and shoe.....	40,345
Wetzel, Lewis C. Die plate.....	41,123	Williams, George R., et al. Sash and sash-frame for windows.....	39,476
Weymouth, Sanford K., et al. Lock.....	40,123	Williams, George Wellington, et al. Extension table.....	39,108
Wheat, Henry A., et al. Lamp.....	39,680	Williams, Gideon A., et al. Box-making machine.....	38,711
Wheater, James, et al. Brake mechanism for vehicles.....	39,633	Williams, Henry B. Anti-friction bearings for journals and axles.....	38,241
Wheeler, Earl A. Boiler furnace.....	40,621	Williams, Homer K. Washing machine.....	40,929
Wheeler, Earl G. Shawl strap.....	38,830	Williams, Horace G. Rock drill.....	40,897
Wheeler, Harris A. Car seat.....	40,868	Williams, James B. Insulated electric conductor.....	40,529
Wheeler, Seth. Toilet paper fixture.....	38,180	Williams, James B. Process of treating insulated electric conductors.....	40,530
Wheeler, Seth. Toilet paper rolls.....	38,181	Williams, John O. Vending apparatus.....	39,484
Whipple, Caroline A. Machine for making fabrics.....	39,731	Williams, John M. High and low water alarm.....	38,580
White, Arthur. Transfer ticket.....	40,188	Williams, John T. Portelectric.....	39,502
White, Cassius A. Wringer for mops.....	40,197	Williams, John W. Method of propelling and steering boats.....	38,672
White, Charles, et al. Gas engine.....	40,616	Williams, Louis N. D. Knitting machine.....	39,490
White, Charles L., et al. Toy bank advertising device.....	41,128	Williams, Richard Christopher, et al. Washing machine.....	38,884
White, Clarence O. Shirt ironing machine.....	40,636	Williams, Warren. Extension table.....	40,392
White, Clarence O., et al. Ironing and polishing machine.....	40,013	Williams, William V. Machine for making fabrics.....	39,731
White, Clarence O., et al. Method of and apparatus for weaving coiled wire fabric.....	39,982	Williamson, David. Filter.....	38,572
White, Eli. Hay rack.....	41,393	Williamson, John. Method of constructing arms for water wheels, &c.....	41,054
White, Frederick R. Cigar tip cutter and advertising device.....	40,379	Williamson, R. H. Stoker.....	40,356
White, Henry A., et al. Hose coupler.....	39,118	Willmer, Arnold. Apparatus for intermitting motion.....	39,805
White, Holden B., et al. Oscillating engine.....	38,326	Willmer, Arnold. Governor for power engines.....	39,806
White, James H., et al. Weighing machine.....	41,058	Wills, Frank J. Strainer for tea.....	39,278
White, John A. Dust guard for car axle boxes.....	38,354	Wilson, Thomas L. Process of reducing metals by electricity.....	40,638
White, John H. Graphophone.....	40,194	Wilson, Edwin O., et al. Waste and conveyors for carding machines.....	40,620
White, John Sibley, et al. Game.....	38,899	Wilson, Frank H. Headlight for steam threshers.....	39,056
White, Luther T., et al. Crucible for casting dental plates.....	39,734	Wilson, George D. Device for removing debris from cisterns.....	38,620
White, Robert, et al. Leather skiving machine.....	41,333	Wilson, James T. Electric motor.....	38,821
White, Roger S., et al. Meter for electricity.....	40,750	Wilson, John D., et al. Pump.....	39,177
White, William R. Gate.....	41,184	Wilson, Isaac S. Saw.....	41,064
Whitehead, William E. Street railway transfer ticket.....	40,458	Wilson, Morris C., et al. Ladder.....	38,727
Whiteman, Frank W. Winter attachment for bicycles.....	40,852	Wilson, Robert A. Refrigerator.....	40,742
Whiteside, William J., et al. Lawn mower and trimmer.....	40,859	Wilson, Thomas O. Edging machine for shingles.....	40,757
Whiting, Ezra T. Hot air drum.....	38,253	Wilson, William. Burner for hydro-carbon.....	40,649
Whiting, Fred. C. Butter worker.....	38,436	Wilson, William B. Door for freight cars.....	39,931
Whittemore, Edward L., et al. Mechanical movement.....	39,727	Wilton, Joseph, et al. Holder for wool, thread, &c.....	41,286
Whittemore, James. Cattle guard.....	40,396	Windsor, Fred E., et al. Lock.....	41,423
Wiegand, S. Lloyd. Telephone receiver.....	38,598	Wing, Chauncey, et al. Tool grinding machine.....	38,498
Wierick, Augusta, et al. Permutation lock.....	39,454	Winkler, Charles F. Secondary battery.....	39,234
Wiesender, Julius. Method of making illuminating gas.....	40,552	Winzler, John W., et al. Mechanical movement.....	41,417
Wilcklow, William. Soap holder and distributor.....	38,969	Wirths, Maurice. Holder for pictures.....	38,592
Wicksteed, Henry K. Elevated railway.....	38,644	Wiswall, James A., et al. Car coupler.....	40,886
Wigand, John. Wagon.....	40,150	Wiswell, Jacob C. Art of and means for re-covering and amalgamating metals.....	39,958
Wiggers, Johann F. Extension table.....	39,671	Wiswell, Jacob C. Furnace for roasting ore.....	39,959
Wightman, George F. Pump motor.....	40,405	Witzel, Joseph R. Pill machine.....	39,360
Wignore, William H. Propeller for ships.....	38,124	Wolfe, Jacob C. Electrotype and stereotype blocks.....	41,148
Wilber, Elijah S. Heater.....	40,389	Wolf, Julius J. Electric signal for cars.....	40,261
Wilcox, John, et al. Spool.....	38,034	Wolf, Arnovitz. Heater for gas.....	40,498
Wilcox, Lewis T. Device for heating and lighting.....	40,677	Wolf, Hermann, et al. Apparatus for securing the lids of coffins.....	39,674
Wilcox, Lewis T. Stove.....	40,045		
Wilcox, Margaret A. Stove.....	40,915		
Wilcox Water Heater Company. Stove.....	40,915		

Wolhaupter, Benjamin. Cattle guard for railways.....	40,008	Wright, James, et al. Ventilator.....	40,608
Woll, Peter. Method of making curled hair.....	40,822	Wright, James W. and John. Pattern board.....	39,834
Woller, Frank E., et al. Table.....	39,038	Wright, John Edward. Printing telegraph receiving instrument.....	39,052
Wolstencroft, James, et al. Electrical locomotive.....	40,451	Wright, John Joseph. Electrical conduit.....	38,117
Wood, Edwin O., et al. Hat case.....	38,805	Wright, Walter B. Device for feeding fluid fuel.....	39,994
Wood, George H., et al. Boiler and baker.....	38,538	Wrightson, Arthur, et al. Knitting machine.....	39,868
Wood, James J. Arc lamp.....	41,302	Writing Telegraph Co. Autographic telegraph.....	39,753
Wood, James J. Holder for electric lamps.....	41,291	Wurfler, Friedrich. Relief valve.....	40,585
Wood, James J. Regulator for dynamo-electric machines.....	41,303	Wyndham, William. Pan for boiling vegetables.....	41,331
Wood, Philander. Gate.....	38,703	Wynkoop, Jehiel F. Drier for clothes.....	39,563
Woods, James. Road cart.....	38,113	Wynne, Frank. Apparatus for supplying electricity to electrical vehicles.....	39,555
Woodard, Russel M. Car coupler.....	39,396	Yale and Towne Manufacturing Company. Lock.....	38,245
Woodward, Ambrose W. Washer for vehicle wheels.....	40,944	Yates Bros, Shattuck & Co., et al. Polishing wheel.....	39,863
Woodward, Roland E. Inhaler.....	38,264	Yelland, William H., et al. Electrical locomotive.....	40,451
Woodworth, James E., et al. Return bends for steam radiators.....	38,607	Yoe, Philip. Cash register.....	38,948
Woodworth, James E., et al. Steam radiator attachment.....	38,606	Yost, George W. N. Typewriting machine.....	40,369
Wool, Albert E. Process and apparatus for bleaching by electrolysis.....	39,785	Youten, Annie F. M. Window.....	40,959
Wool, Albert E., et al. Car coupler.....	39,004	Young, Charles G., et al. System of electrical distribution.....	41,299
Woolf, Ellis J., et al. Valve gear for engines.....	38,269	Young, John Brooks. Apparatus for cutting paper from rolls.....	39,098
Woolf, Rosamond, et al. Car coupler.....	39,004	Young, Wesley, et al. Tag wiring and bundling machine.....	38,320
Woolf Valve Gear Company. Valve gear for engines.....	38,269	Young, Stina C. Window sash.....	39,068
Wooley, Leonidas G. Electro magnetic apparatus.....	38,451	Yule, John S. Apparatus for displaying advertisements, &c.....	39,738
Wooley, Leonidas G. Magneto electric ignitor for combustible vapour engines.....	39,592	Zadak, Alois. Life preserver.....	38,362
Woonsocket Edge Tool Company. Arm rest for telephones.....	40,991	Zahn, William. Process of tanning hides.....	40,171
Workman, Joseph Henry. Method of binding books.....	38,254	Zauner, Alexander. Floor clamp.....	41,140
Worrall, Arthur J., et al. Resilient frames for mats and rugs.....	39,219	Zeidler, William C., et al. Method of making key boards.....	38,397
Worsley, Samuel L. Metal screw machine.....	39,470	Zell, Robert R. Steam boiler.....	38,807
Worts, George, et al. Receptacle for feeding grain to live stock.....	39,838	Ziegler, Berthold. Disintegrator and separator for fibrous material.....	39,978
Wright, Edward T. Steam road roller.....	38,547	Zimmerman, John, John G. and John J., et al. Car brake.....	41,162
Wright, Elias M. Burner for oil stoves.....	39,330	Zinner, Frederick W. Aerial navigating machine.....	39,665
Wright, Frederick W. Hose coupling.....	40,639	Zurcher, Max A. Car for railways.....	39,736
Wright, Franklin H. Machine for bushing mortices.....	41,817	Zurcher, Max A. Frame for railway cars.....	39,694
Wright, George S., et al. Process of treating metalliferous ores.....	40,453	Zwilling, Leopold. Process of making charcoal.....	40,419



Vol. XX.—No. 1.

JANUARY, 1892.

Price free by post in Canada and the United States, \$2.00.

INVENTIONS PATENTED.

NOTE.—Patents are granted for 15 years. The term of years for which the fee has been paid, is given after the date of the patent.

No. 38,025. Shaft and Journal Boxes or Bearings. (*Boîte à graisse ou coussinet de tourillon.*)

Amos Clinton Stilson, Bradford, Pennsylvania, U.S.A., 2nd January, 1892; 5 years.

Claim.—1st. In a shaft bearing or journal box, the combination of a box having teeth or cogs around its edges, the rollers having teeth upon their outer ends, and the adjusting rings having an opening larger than the shaft or journal, and having teeth meshing with the teeth on the ends of the rollers. 2nd. In a shaft bearing or journal box, the combination of a box having a recess and teeth arranged upon the outer ends, rollers fitting in said recess and having reduced journals provided with teeth at each end, and the adjusting rings having teeth which mesh with the teeth upon the ends of the rollers.

No. 38,026. Electric Battery. (*Batterie électrique.*)

Walter Steadman Richards, Natick, and George Barker James, both of Boston, Massachusetts, U.S.A., 2nd January, 1892; 5 years.

Claim.—1st. In a primary electric battery a negative and a positive element disposed in an excitant, said positive element being formed from a negative metal, substantially as described. 2nd. In a battery of the character described, a negative element and two positive elements disposed in an excitant, said positive elements being connected in multiple, substantially as described. 3rd. In a battery of the character described, a negative element, and two positive elements connected in multiple, and immersed in an excitant, one of said positive elements comprising a negative metal, substantially as described. 4th. In an electric battery, a negative element and a positive element immersed in a common excitant, a second positive element in a distinct excitant, said positive elements being connected in multiple, substantially as described. 5th. In an electric battery, a containing jar and a porous cup therein, in combination with an excitant solution surrounding said cup; a negative and a positive element in said solution; an excitant in said cup, and a positive element in said excitant, said positive elements being connected in multiple. 6th. A primary electric battery comprising a containing jar, an excitant solution therein; a zinc pole and an iron pole in said solution; an excitant in said cup, and a carbon pole in said cup connected in multiple with said iron pole, substantially as described. 7th. A primary electric battery comprising a negative pole; a positive pole consisting of a negative metal, and an excitant comprising a solution of potash surrounding said poles, substantially as described. 8th. A primary electric battery comprising a jar containing a solution of potash, a zinc plate and an iron plate immersed therein; a porous cup in said jar; a solution of bi-chromate of soda or equivalent excitant in said cup, and a carbon plate in said cup connected in multiple with said iron plate, substantially as specified. 9th. In a primary electric battery a negative electrode and two positive electrodes of different substances immersed in an excitant. 10th. In a primary electric battery, a negative electrode and two positive electrodes immersed in an excitant, said positive electrodes being connected with different circuits to which the negative electrode is common.

No. 38,027. Spoon. (*Cuiller.*)

Geo. A. Gray, Montreal, Quebec, Canada, 2nd January, 1892; 5 years.

Claim.—1st. A spoon constructed with two lips opposite each other, having a handle at one side thereof, placed at or about midway between said lips, substantially as described. 2nd. As a new article of manufacture, a spoon having the lips A, A', opposite each other, and a handle B, placed at or about midway between said lips, substantially as and for the purpose set forth.

No. 38,028. Fastener for Collars. (*Attache de col.*)

Frederick H. Kiekenapp, Faribault, Minnesota, U.S.A., 2nd January, 1892; 5 years.

Claim.—1st. The combination, in a device of the class described, of parts 4 and 5, having straight and slotted lugs 9 and 10 respectively, wide notches provided between the parts of said lugs, and adapted to receive the hame-strap, a projection 11 on the part 5, adapted to engage the back of the part 4, and a stop whereby the lugs 9 are prevented from slipping out of engagement with the lugs 10 after being secured in place, substantially as set forth. 2nd. A collar fastener, consisting in the parts 4 and 5, having straight and slotted lugs 9 and 10 arranged with notches between them, a projection 11 on the part 5 adapted to engage the part 4, and one of said parts having the loop or eye provided with the inclined slot 15, through which to insert the martingale, substantially as described. 3rd. The combination, in a device of the class described, with the parts 4 and 5, having straight and slotted lugs 9 and 10 arranged with notches between them, of a projection 11 on the part 5, adapted to engage a projection on the part 4, and a loop or eye provided on one of said parts, and having the inclined slots 15 through which to insert the martingale, as described.

No. 38,029. Washing Machine. (*Machine à blanchir.*)

William Champion, St. Marys, Ontario, Canada, 2nd January, 1892; 5 years.

Claim.—1st. The combination of a wooden stool suspended in a wooden tub, and receiving an oscillating circular motion by means of bevel gear and pinion wheel with handle, substantially as and for the purpose set forth. 2nd. The combination of a wooden stool suspended in a wooden tub, with a grooved or slotted iron shaft fitting loosely in a bevel pinion, and thereby allowing the stool to accommodate itself to the quantity of clothes in the tub, substantially as and for the purpose set forth. 3rd. The combination of stool with slotted or grooved iron shaft, moved by bevel gear wheel and pinion with hinged door, so that when the door is open all the machinery is removed from the entrance to the tub, substantially as and for the purpose set forth.

No. 38,030. Nut Lock. (*Arrête écrou.*)

William J. Walker, St. Louis, Missouri, U.S.A., 2nd January, 1892; 5 years.

Claim.—1st. A nut lock, consisting of a bolt and nut, and a longitudinal slot formed in said bolt; the said bolt adapted to be expanded adjacent to the nut, substantially as set forth. 2nd. A nut lock, consisting of a bolt and nut, a longitudinal slot formed in said bolt, and a slit such as 8 also formed in the bolt adjacent to the said slot, substantially as set forth. 3rd. A nut lock, consisting of a bolt having a head, a longitudinal slot formed in the screw threaded portion of said bolt, beveled surfaces such as described formed on the screw threaded ends of the bolt, and a nut adapted to be screwed on

said bolt, substantially as set forth. 4th. A nut lock, consisting of a bolt and nut, a longitudinal slot such as 7 formed in said bolt at the screw threaded end thereof, beveled faces such as 10 formed at the openings of said slot, and a slit such as 8 leading from the said slot, substantially as set forth. 5th. A nut lock, consisting of a bolt and nut, a slot formed in the screw threaded end of said bolt forming prongs 9, beveled faces such as 10 formed on the said prongs adjacent to the said slot, and a slit such as 8 formed in the said bolt adjacent to the said slot, substantially as set forth.

No. 38,031. Joint for Railway Rails.

(*Joint de rail de chemin de fer.*)

Joseph A. Eno, Newark, New Jersey, U.S.A., 2nd January, 1892; 5 years.

Claim.—1st. In a railway joint, fish plates provided with teeth or projections adapted to enter openings in a supporting rail chair, as described and set forth. 2nd. In a railway joint, a supporting rail chair provided with teeth or projections adapted to enter openings in fish plates, as described and set forth. 3rd. In a railway joint, the combination with the rails of fish plates provided with teeth or projections, a supporting chair extending under the ends of the rails, and provided with openings adapted to receive the teeth or projections on the fish plates, and means for securing said parts to the rails, all said parts being adapted to operate as described and set forth. 4th. In a railway joint, the combination with the rails of a supporting chair extending under the ends of the rails and provided with teeth or projections, fish plates provided with openings adapted to receive the teeth or projections on the chair, and means for securing said parts to the rails, all said parts being adapted to operate as described and set forth.

No. 38,032. Spring for Vehicles. (*Ressort pour voitures.*)

Stephen Henderson Campbell Miner, Montreal, assignee of William Atkinson, Granby, Quebec, Canada, 2nd January, 1892; 5 years.

Claim.—1st. In a vehicle spring, the knuckle pieces D, rigidly secured to the slide plates of the spring, and having the lugs, the said knuckle piece prolonged into a loop to enclose the end of the spring and to act with its stop T, the bolt G, passing through the said lugs and pivoting them to the blocks F, and the clips K, binder L, and nuts M, substantially as herein shewn and described. 2nd. The combination in a vehicle spring of the cylindrical terminals of the tension plate O, suitably secured to the spring and the bottom plate Q, said terminals being bushed substantially as shewn and described, and acting through the shackle arms with the bushing of the cylindrical terminals of the rub plates B; with the stop or protuberance T, or the lowest leaf of the spring and the looped terminal of the knuckle piece D, forming a chair rest with the said spring leaf and the rub plate, by passing across the top and down the sides of the said spring leaf and rub plates, as set forth. 3rd. In a vehicle spring, the combination with the knuckle piece D, suitably secured to the relatively adjacent parts of the vehicle, having its looped terminal N¹, to clasp the rub plate B, and the lowest leaf of the spring bearing the protuberance T, and to produce with said protuberance of the spring an effectual stop, substantially as and for the purposes set forth. 4th. The combination in a vehicle spring of the stop T, of the spring leaf, with the looped terminal N¹, of the knuckle piece, as set forth. 5th. In a vehicle spring, the combination of the loop N¹, of the knuckle piece D, with the stop T, of the lowest spring leaf, and the plate Q, as set forth. 6th. In a vehicle spring, the combination with the stop T, of the spring leaf resting upon the rub plate B, and into the loop N¹, of the knuckle piece D; of plate O, acted upon by said stop T, and loop N, through the shackle R, and prevents the body of the vehicle from shifting forward, substantially as set forth. 7th. In a vehicle spring, the combination of the loop N¹, of the knuckle piece with the stop T, the shackle N, the top plate O, and the bottom plate Q, arranged to act functionally together, as set forth. 8th. As an article of manufacture, the herein described spring leaf having the protuberance T, swedged into each of its ends, substantially as set forth. 9th. In a carriage spring, the combination of the bushing, substantially as hereinbefore shewn and described, with the cylindrical terminals of the top tension plate O, the bottom tension plate Q, and the bolt G, whereby a more delicate and exact functional action of the spring is produced as set forth.

No. 38,033. Knitted Bags and Process of Making the Same. (*Sac tricoté et procédé de fabrication.*)

Frank Clewley and Hugh McGill, both of Philadelphia, Pennsylvania, U.S.A., 2nd January, 1892; 5 years.

Claim.—1st. The method of knitting bags, consisting of simultaneously knitting two sides thereof, and interknitting their selvages and at intervals in the formation of the tube so formed transversely joining the two sides thereof by interknitting the same, and then continuing the tubular construction, substantially as described. 2nd. A tube for the formation of bags, consisting of two flat knitted sides H H, interknitted at their selvages and transversely inter-

knitted at intervals, one with the other, and adapted to be cut at or about the transverse joints thus formed to make bags, substantially as set forth. 3rd. A tube for the formation of bags, consisting of two flat knitted sides H H, interknitted at their selvages, said two flat sides being cross seamed at intervals one with the other, and adapted to be cut at or about the said transverse seams to form bags.

No. 38,034. Bobbins or Spools for Yarn Thread. (*Cord, etc.*) (*Bobine ou fuseau pour le fil, la corde, etc.*)

Richard Haynes, Birmingham, and John Wilcock, Manchester, England, 2nd January, 1892; 5 years.

Claim.—1st. A bobbin or spool, upon which yarn, thread, twine, or the like, is wound or held constructed in two separable parts divided transversely across the barrel or tube to provide for the material being removed therefrom or placed thereon without unwinding or rewinding. 2nd. A bobbin or spool, divided transversely across the barrel or tube, provided with a connecting joint which securely attaches the two parts together, substantially as and for the purposes described. 3rd. A bobbin or spool, transversely divided across the barrel, provided with truncated cone-shaped ends, having the apex of each at or near the centre, substantially as described. 4th. In a bobbin, divided transversely across the tube or barrel, the combination with the barrel *a*, of the joint *a*¹, substantially as described. 5th. The combination with the divided bobbin A, and roll or ball of material C, of the paper tube B¹, and loose flanges D, provided with central cores *d*, substantially as described. 6th. The combination with the divided bobbin A, and roll or ball of material C, and paper tube B¹, of the loose flanges D, having central cores *d*, and the spindle D¹, substantially as described.

No. 38,035. Coffin. (*Cercueil.*)

Ludwig Otto Mueller and Lambert Stader, both of Munich, Kingdom of Bavaria, Empire of Germany, 2nd January, 1892; 5 years.

Claim.—1st. A coffin composed of a skeleton consisting of frames stiffened with light, open latticework, coated with moisture-resisting and adhesion increasing solutions, and said lattice frame being the carrier or support of a skin or crust cast upon it externally, consisting of a plastic combination having the quality of setting hard in the open air, but becoming porous when subjected to the influence of air and moisture in the ground, substantially as set forth. 2nd. A coffin composed of a frame stiffened with light open latticework, coated with a moisture-resisting substance, a skin or crust cast upon said frame, said skin cast in a mold, and having a fabric embedded therein, said skeleton and fabric impregnated with a solution adapted to increase the adhesion between the same, and the composition of which the skin is composed, substantially as set forth. 3rd. In the production of coffins, a casting composition consisting of plaster of Paris, chalk, dextrine silicate, with the addition of salts of carbonic oxide and of sulphur, substantially as set forth.

No. 38,036. Dish Washer. (*Laveuse de vaisselle.*)

Harriet Ellen Davis, Topeka, Kansas, U.S.A., 2nd January, 1892; 5 years.

Third copy of the claims in the matter of the application of Harriet Ellen Davis, dish washer.

Claim.—1st. The hereinbefore described dish washer, composed of the suds box, the perforated cylinder journaled at its ends in the said suds box, and the loose partitions of graduated sizes placed within the said cylinder to space the dishes and hold them from movement, substantially as described. 2nd. The hereinbefore specified dish washer, comprising the suds box having flat bottom and curved sides, and having the cover symmetrically curved and provided with an outer flange *d*¹, the perforated splasher plates F, secured to the suds box at their lower ends and embracing the lower edge of the cover between its sides and the sides of the suds box, the perforated cylinder journaled at its ends in the suds box, and the loose partitions of graduated sizes placed within the said cylinder to space the dishes and hold them from movement, one of the said partitions being a box to receive the cutlery, substantially as set forth.

No. 38,037. Can for Filling Lamps.

(*Machine à emplir les bidons.*)

Milton H. Garland, Chicago, Illinois, U.S.A., 2nd January, 1892; 5 years.

Claim.—1st. A sink top for a filling can, provided with a screw capped thimble opening, a thimble to which a blow-tube is adapted to be fastened, both of said thimbles extending above the surface of the sink top, and a combination supply and drain pipe ending at its upper end flush with the surface of the sink top, as and for the purpose specified. 2nd. In the filling can, the combination, with a sink top, of a tube united to it extending downwardly therefrom to the bottom of the can, having its upper end flush with the surface of the sink top and the interior of its upper end fitted to receive a detachable spout W, whereby it is adapted to act both as a supply pipe and a drain pipe, substantially as set forth.

No. 30,038. Process and Apparatus for Ageing Liquors. (*Procédé et appareil pour vieillir les liqueurs.*)

Julian A. H. Hasbrouck, Plainfield, New Jersey, U.S.A., 2nd January, 1892; 5 years.

Claim.—1st. In the treatment of liquors for the purpose of ageing them, the process herein described, the same consisting in confining the liquor to prevent the vapors from escaping, protecting the liquor against injury from chemical action, by contact with the walls of the containing vessel, by means of a layer of carbon or carbonized wood interposed between the liquor and the surface of the tank and its arms, said carbon also serving as the purifying and coloring agent, heating the confined liquor, spraying, vaporizing or otherwise finely dividing it, and subjecting the liquor so confined, heated and divided, to the action of oxygen gas, substantially as herein described. 2nd. The apparatus herein described for carrying out the above specified process, the same consisting of a wooden tank T, provided with gudgeons journaled in supports on which the tank rotates, the said tank having interior wooden arms A, A', and an interior pipe P, made of tin or other metal not corrodably by the liquor, the inside surface of the tank and also the arms being carbonized or charred so that the liquor cannot come in contact with the natural wood, and the pipe P, having its ends carried through and secured in apertures in the heads of the tank, and stationary tubes t, t, connected one with hot air or steam supply pipe, and the other with an exhaust pipe, and also passed through stuffing boxes in the gudgeons so that they communicate with the ends of the pipe P, substantially as herein described.

No. 38,039. Construction of the Hulls of Vessels.

(*Construction de coque de navire.*)

James Frederick Hodgetts, London, England, 2nd January, 1892; 5 years.

Claim.—1st. The construction of the hull of a vessel with the bottom and bilge formed by a pair of curves, such as reverse catenarian curves, concave to the water and springing from a central keel with a curve of small curvature, and dipping at their outer extremities with curves of much greater curvatures to side keels parallel to the centre keel, substantially as described. 2nd. The construction of the hull of a vessel so that its general conformation and sections will correspond substantially with those shown in Figures 1 and 2.

No. 38,040. Manufacture of Spoons and Forks.

(*Fabrication de cuillers et fourchettes.*)

Hubert C. Hart, Unionville Connecticut, U.S.A., 2nd January, 1892; 5 years.

Claim.—1st. A blank for spoons and forks consisting of a wide portion D, having a handle portion of the length it is to be when finished, and which interlocks as shown, substantially as shown. 2nd. A blank for forks and spoons consisting of a wide portion having straight edges and a handle portion of about the length it is to be when finished, the said handle portions having the edges of their ends intersect the edges of the converging lines of the wide portion, substantially as set forth. 3rd. A blank for spoons and forks, consisting of a wide portion having straight edges, a handle portion of about the length it is to be when finished, the shank of the handle of about a finished width, and the handles interlocking, as shown, substantially as subscribed. 4th. A blank for spoons consisting of a wide portion having its outer end rounded, its edges straight, and the handle portion of about the length it is to be when finished, substantially as shown. 5th. A spoon blank having a handle portion and a bowl portion of about a finished length, the bowl portion being narrower than the finished width, and having straight edges, substantially as described. 6th. A method of making spoons and forks consisting in cutting a blank of a thickness corresponding to the thickest part of the finished article and of about a finished length, and then widening the handle and bowl, respectively to the desired width, substantially as described. 7th. A method of producing spoons and forks consisting in cutting a blank having a shank of about the finished width, a handle and a bowl portion of a finished length, and then widening the handle and bowl portion to the desired width, substantially as described. 8th. A process of producing spoons, consisting in cutting a blank having a handle portion of about a finished length, a bowl portion of about a finished length, but narrower than when finished, then rolling the bowl portion crosswise to get the desired width, and flattening the handle portion to get the desired width, substantially as described. 9th. A method of producing spoons and forks consisting in cutting from the material a series of interlocking blanks, rolling said blanks crosswise to obtain the desired width, and lengthwise to obtain the desired length, and cutting from said blank after the rolling process is completed the contour of the finished article, substantially as described. 10th. A method of producing spoons and forks consisting in cutting from the material a series of interlocking blanks, each blank being about two-thirds the length required for the finished article, rolling said blank crosswise to obtain the desired width and lengthwise to obtain the desired length, and cutting from said blank after the rolling process is completed the contour of the finished article, substantially as described.

No. 38,041. Cough Sirup.

(*Sirup pour la toux.*)

Etienne Germain, Quebec, Que., Can, 2nd January, 1892; 5 years.

Resumé.—Une composition formée d'eau, de goudron americain, de miel, de sucre d'érable, d'alcool et de residue de racines de sang de dragon dans les proportions ci-dessus données.

No. 38,042. Packets or Pads for Electric Cells.

(*Garniture ou coussinet pour piles electriques.*)

Lewis Hopkins Rogers, Brookline, Massachusetts, U.S.A., 2nd January, 1892; 5 years.

Claim.—1st. The herein described packet or pad for an electric cell, consisting of an electrolytic chemical, and a casing or envelope of absorbent or porous material containing said chemical, adapted to be moistened to form the active material of the cell, substantially as set forth and described. 2nd. The herein described packet or pad for an electric cell, consisting of a casing or envelope of absorbent material adapted to be placed between, and to rest against, both the positive and negative elements of the cell, said casing containing a charge of electrolytic chemical, which chemical dissolves and forms the active material of the cell when the pad is moistened, substantially as set forth and described. 3rd. The herein described packet or pad for an electric cell, consisting of sheets of blotting paper joined together at their edges, forming an envelope or casing, and a charge of an electrolytic chemical contained between said sheets of blotting paper, said pad being adapted to be placed between and to rest against both the positive and the negative elements of the cell, to form the active material when said pad is moistened, as set forth and described. 4th. A packet or pad for an electric cell, consisting of an electrolytic chemical and a casing or envelope of absorbent or porous material, containing said chemical, substantially as described, having a portion of said casing made of increased thickness to retard the polarization of the cell, as set forth. 5th. A packet or pad for an electric cell, consisting of an electrolytic chemical, a casing or envelope of absorbent or porous material containing said chemical, and a perforation in said packet, having an eyelet or other binding for the purpose, as set forth. 6th. An electric cell, consisting of a positive element, a negative element and a packet or pad consisting of an electrolytic chemical, a casing or envelope of absorbent or porous material encasing said chemical, placed between the elements of the cell and adapted to form the electrolyte by moistening said packet, as set forth and described. 7th. An electric cell, consisting of a positive element, a negative element and a packet or pad introduced between the two elements, consisting of an electrolytic chemical encased within a casing or envelope of absorbent or porous material, said casing being of an increased thickness on one side to retard polarization of the cell, as set forth and described. 8th. A packet or pad for an electric cell, consisting of an electrolytic chemical, a casing or envelope, containing said chemical, made of absorbent or porous material, said casing having been previously saturated with a solution of the resulting chemical produced by the electrolysis of the enclosed chemical, whereby the starting of the action of the cell is accelerated, as set forth and described.

No. 38,043. Receiver for Telephones.

(*Récepteur téléphonique.*)

Ferdinand Gross, Montreal, Quebec, Canada, 2nd January, 1892; 5 years.

Claim.—1st. The combination with a telephone receiver of a compressible cushion, for the purpose set forth. 2nd. The combination with a telephone receiver of a compressible cushion, and means for attaching same to said receiver. 3rd. The combination with a telephone receiver of a compressible cushion and an elastic hood C, as shown, and for the purpose set forth. 4th. The combination with a telephone receiver of an air cushion for the purpose set forth. 5th. The combination with a telephone receiver of an air cushion with means for inflating same, for the purpose set forth. 6th. The combination with a telephone receiver of a soft rubber air cushion, for the purpose set forth. 7th. The combination with a telephone receiver of soft rubber air cushion, with means for inflating same, for the purpose set forth. 8th. The combination with a telephone receiver of a soft rubber hollow annulus, inflated with air. 9th. The combination with a telephone receiver of a soft rubber hollow inflated annulus, with means for inflating same. 10th. The combination with a telephone receiver of a soft rubber, hollow, inflated annulus, with means for attaching same to such receiver. 11th. The combination with a telephone receiver of a soft rubber, hollow, inflated annulus, with means for inflating and attaching same to such receiver. 12th. The combination with a telephone receiver of a soft rubber, hollow, inflated annulus A, inflating tube B, and elastic hood C, as shown, and for the purpose set forth.

No. 38,044. Bicycle. (*Bicycle.*)

James H. Mathews, Ludington, Michigan, U.S.A., 2nd January, 1892; 5 years.

Claim.—1st. In a safety bicycle, the combination with the front fork, the rearwardly and downwardly curved backbone, the hanger depending from the end of the same and terminating in a hook, a horizontal

disposed reach bifurcated to embrace and pivoted to the lower end of the backbone, and a hange rhaving an eye depending from the reach in rear of its bifurcation, of a barrel, a threaded plug mounted in the rear end of the barrel and having an eye, a suspension link connecting the same with the eye of the rear hanger, a perforated plug mounted in the front end of the barrel, a plunger rod terminating at its inner end in a head, and having at its outer end an eye mounted in the perforation of the front plug, a coiled spring mounted upon the rod between its head and the front plug, said head being adjustable, and the suspension link connected to the eye of the plunger and removably engaging the hooked end of the front hanger, substantially as specified. 2nd. In a safety bicycle, the combination with the front fork, the rearwardly curved and downwardly disposed backbone loosely connected with the fork, the hanger depending from the backbone, the horizontally disposed straight reach bifurcated at its front end and pivoted to the backbone above the hanger, the rear hanger depending from the reach in rear of the bifurcation, of the seat standard extending rearwardly and upwardly from the backbone above and between the two hangers, and the spring connection between said hangers, substantially as specified.

No. 38,045. Chute for Coal and Grain.

(*Auget à charbon et grain.*)

Thomas William Emery, Minneapolis, Minnesota, U.S.A., 2nd January, 1892; 5 years.

Claim.—1st. In a device of the class described, the combination with the metallic pipe-sections, with ribs or slats movably secured upon the outside of said sections longitudinally thereof, a hopper connected to one of said sections, and an angle iron frame secured upon the outside of said hopper at its upper edge, substantially as and for the purpose set forth. 2nd. In a chute, the combination of the hopper, the upper section or round pipe, the lower section or sections, slip-joints between said sections, means for coupling said sections together, and wooden slats secured longitudinally upon the said section by suitable staples, substantially as and for the purpose specified. 3rd. The combination, in a chute, of the hopper 4, provided with the angle iron frame 7, with the portion 5, connecting said hopper with the round pipe 6, the wooden slats 9, provided at convenient distances around said pipe 6, and the staples 10, substantially as described. 4th. The combination, with the hopper, of the round sheet metal pipe 6, the angle-iron 7, the lower section 12, connected with said pipe 6 by a slip-joint and a coupler 10, the lock 13, and the wooden slats 9, movably secured upon the several sections of the chute, substantially as described. 5th. A chute comprising in combination, a thin sheet metal pipe, loops for staples upon the exterior of said pipe, slats inserted through said loops longitudinally of said pipe, and shoulders or collars upon said pipe, against which the ends of the slats abut, and by means of which they are held in position, substantially as described. 6th. The combination with the pipe of the funnel or hopper arranged on the upper end thereof, and the angle iron 7 arranged about the edge of said hopper to strengthen the same and whereby the chute may be secured upon the edge of the wagon or bin, substantially as described. 7th. The combination in a chute of two or more sections of pipe, with the funnel or hopper arranged on the upper end thereof, said hopper being composed of the abrupt portion 11 and the less abrupt portion 5, substantially as and for the purpose specified. 8th. The combination with the round pipe of the hopper forming the upper end thereof, and hooks provided on said hopper for securing the same on the wagon or bin, and slats arranged at equal distances about and longitudinally upon said parts to strengthen the same, substantially as described.

No. 38,046. Device for Securing Guard Rails in Place. (*Appareil pour tenir en place les contre-rails.*)

George David Smith and Kennet William Blackwell, both of Montreal, Quebec, Canada, 2nd January, 1892; 5 years.

Claim.—The combination with a section of line rail and a length of guard rail, of metal clamps set on edge and clipping closely the under sides and outside faces of such rails, substantially as herein described and for the purposes set forth.

No. 38,047. Wooden Shovel.

(*Pelle de bois.*)

James Henry Still, St. Thomas, Ontario, Canada, 2nd January, 1892; 5 years.

Claim.—The fork shaped metal connection B, B, which connects the handle A, A of the shovel with the blade C, C, substantially as and for the purpose hereinbefore set forth.

38,048. Thill Support.

(*Arnon de limonière.*)

Andrew Henry Fletcher, Kingsville, Ontario, Canada, 2nd January, 1892; 5 years.

Claim.—As an article of manufacture, a thill-supporting spring, made of a piece of wire bent at the middle to form a tongue G, a spiral coil H, at one side of said tongue, and a spiral coil H¹ at the opposite side, the spiral H, having an arm J, and the spiral H¹ an

arm J¹, both arms converging towards the end and extending tangentially from the spiral coils in a somewhat straight direction, the ends of said arms J J¹, connected together, substantially as and for the purpose set forth. 2nd. The combination with the thill coupling C of a bent wire thill-supporting spring, having a tongue G, inserted between the thill coupling and thill iron, said springs having spiral coils H H¹, surrounding the vehicle axle B, and arms J J¹, connected together at the end and extending forwardly of the coupling, and supporting the thill A, as set forth.

No. 38,049. Seine for Fishing.

(*Seine pour la pêche.*)

Maggie E. Jones, Little Rock, Arkansas, U.S.A., 2nd January, 1892; 5 years.

Claim.—1st. In a fishing seine, the combination, with a net having a surrounding rope and provided with exit-openings at the centers of the halves of its body and removable cords closing said openings, of poles seated in the river bottom and having pulleys at their upper ends, a division rope leading over the pulleys on opposite poles and extending between said exit openings to the shore, a windlass on the shore, and ropes leading therefrom over said pulleys to the surrounding rope, as and for the purpose set forth. 2nd. In a fishing-seine, the combination, with a net having exit-openings at points in its body, removable cords closing the same, and supports for said net, of poles having pulleys at their upper ends and a division-rope passing over said pulleys woven through the net between said exit-openings and extending to the shore, as and for the purposes hereinbefore set forth.

No. 38,050. Detachable Bail and Ear.

(*Cercle et oreille mobiles.*)

Lewis Newell Lusk, Kalamazoo, Michigan, U.S.A., 2nd January, 1892; 5 years.

Claim.—1st. The combination of the ears having the central holes, the chambered portions on the back, the passages through which the ends of the bail pass in attaching it and detaching it from the vessel, stop-springs in said passages, and a bail having the angled ends and heads, substantially as set forth. 2nd. The combination of the ears having the central holes, chambered portions on the back, the passages, the springs in said passages, and the bail having the ends turned at right angles and provided with the heads, the said right angled portions passing through the said central holes, substantially as set forth.

No. 38,051. Calk for Horse-Shoes.

(*Crampon de fer à cheval.*)

Joseph C. Higgins, A VanNest Baldwin and Thomas Lea, all of New Brunswick, New Jersey, U.S.A., 4th January, 1892; 5 years.

Claim.—1st. A horse-shoe calk composed of longitudinal sections, in combination with means, such as a wedge for securing the calk by spreading the sections within the aperture of the shoe. 2nd. A horse-shoe having an aperture, in combination with a calk fitted in such aperture and formed of longitudinal sections, means substantially as described to secure the calk by spreading such sections within the aperture. 3rd. A horse-shoe having an aperture, in combination with a calk formed in sections and a wedge entering said calk from its contact or wearing end, and forcing the sections apart within the shoe. 4th. A shoe having an aperture, in combination with a calk composed of two similar longitudinal sections having corresponding registering grooves in their inner faces, and a wedge or pin forced into such grooves to force the sections of the calk within the shoe. 5th. In combination, a horse-shoe having the aperture, the calk composed of the shank to enter said aperture, and the tapered outer portion having a shoulder to bear against the shoe, said calk being split centrally and longitudinally and the fastening wedge inserted between the sections of the calk at the lower wearing point thereof, as and for the purposes set forth.

No. 38,052. Carriage Gear. (*Train de voiture.*)

Robert McLaughlin, Oshawa, Ontario, Canada, 4th January, 1892; 5 years.

Claim.—1st. A side spring connected at one end to a box fixed to the rear axle, substantially over its centre, and at its other end to a box fixed substantially over the centre of the front bolster, substantially as and for the purpose specified. 2nd. A side spring connected at one end to a box fixed to the rear axle substantially over its centre, and at its other end to a box fixed substantially over the centre of the front bolster, the roll or eye at each end of the spring having a bushing of rubber or other elastic material with a metal lining in the hole through the said bushing, substantially as and for the purpose specified.

No. 38,053. Check Hook. (*Crochet de selle.*)

Alonzo Iobdell, Racine, Wisconsin, U.S.A., 4th January, 1892; 5 years.

Claim.—An improved check hook, comprising an upright member and a hook member, the latter extending forward toward and then curved to extend laterally across in front of and approximately transversely to the axial line of the upright member, substantially as set forth.

No. 38,054. Churn. (Baratte.)

John T. Mark, Straun, and Frank Bucher, Hartford, both of Kansas, U.S.A., 4th January, 1892; 5 years.

Claim.—1st. A hollow churn dasher, formed of a series of spaced, concentric rings, and increasing in diameter from its centre to its ends, substantially as described. 2nd. A tubular, barrel churn ends, substantially as described. 3rd. A tubular, barrel churn dasher, open at both ends, and comprising a series of spaced, concentric handlike rings of varying diameter, said rings being one above the other edgewise, substantially as described.

No. 38,055. Combined Shaft Supporter and Anti-Rattler. (Tuteur de limoniere et compensateur combinés.)

Charles Bishop, Cleveland, and Oliver D. Miller, Brooklyn, both of Ohio, U.S.A., 4th January, 1892; 5 years.

Claim.—1st. The pivotal washer P, having its axis in the side of the bracket concentric to the segmental slot *a*, provided with teeth for engagement with the teeth of the bracket, in combination with spring T, screw bolt and nut, connected with the bracket, substantially as and for the purpose set forth. 2nd. In a vehicle shaft supporter, the pivotal washer having its axis or pivot concentric with the segmental slot *a*, in combination with the bracket and spring, with means for securing the coiled terminal of said spring to the said washer, and the other terminal of the spring extending out in support of said shaft, substantially as described. 3rd. In a shaft spring supporter, the curved arm K, forming an integral part of the bracket, the coil I', of the spring circumscribing the said arm, and the terminal of the coil secured to the pivotal washer by means of screw bolt and nut in combination with the arm G, of the bracket and spring I, with means at outer terminal thereof for holding and supporting the vehicle shaft arranged, substantially as and for the purpose set forth.

No. 38,056. Combined Bed Clothes and Baby Holder.

(Couvertures de lit et appareil combinés pour tenir les enfants.)

Karl Kanzler, Saginaw, Michigan, U.S.A., 4th January, 1892; 5 years.

Claim.—1st. In a bed clothes fastener, the combination of an endless band having adjustable straps loosely secured to it on opposite sides thereof, and the adjustable straps and staples securing the straps to opposite sides of the bed, with loops secured to the endless band at equal distances thereon and on opposite sides of the band, as divided by the adjustable straps and clamps secured to the respective ends of the loops, substantially as described. 2nd. In a bed clothes holder, the combination of the endless band A and the adjustable straps C, C, secured loosely to the opposite sides of the endless band, and notched staples D, D, to which the straps C, C are secured, with the loops A', A' secured to the endless band A at equal distances and on the opposite sides of the band A, as divided by the straps C, C, and the clamps B, B, secured to the ends of A', A', for engaging the bed clothing, as and for the purpose set forth. 3rd. In a bed clothes holder, an endless band adapted to be loosely secured to each side of a bedstead, in combination with two clamps for engaging the bed clothing, secured to the endless band at equal distances and on opposite sides of the band, as divided by the bedstead attachment, whereby in turning the band to the right or left the clamp attachment may be adjusted to a large or small body, as the case may be, substantially as described.

No. 38,057. Chocolate. (Chocolat)

Victor Tobias and Heinrich Fischer, both of Berlin, Kingdom of Prussia, German Empire, 4th January, 1892; 5 years.

Claim.—As a new industrial product, a thoroughly liquid and preservable chocolate, free from fat, prepared by means of whey or poor milk, which is mixed after boiling with a mass composed of cocoa and sugar in the proportions specified, heated under pressure at a temperature of about 102° C, subsequently cooled and passed through a sieve having fine meshes by which the cocoa butter is separated from the chocolate, and whereby the latter is thoroughly freed from fat, substantially as described.

No. 38,058. Reversing Gear for Steam Engines.

(Mecanisme de relevage pour machines à vapeur.)

Daniel Avery Frazer and John Wesley Cosford, both of Mancelona, Michigan, U.S.A., 4th January, 1892; 5 years.

Claim.—1st. In combination with a steam engine having a double acting cylinder, a D valve, ports from said valve to the respective ends of said cylinder, an exhaust port beneath said valve, a rotary valve, as G, passing through all said ports, having a permanently open exhaust passage, and openings permanently connecting with said live steam ports adjacent to the D valve, having also an integral portion opposite one live steam port adapted to alternately open ports beneath the same leading to opposite ends of said cylinder and having two integral portions opposite the other live steam port, each adapted to alternately open a steam port leading to the respective ends of the cylinder, substantially as set forth. 2nd. In a steam engine, a double acting cylinder, a D-valve, live steam and exhaust

ports, a rotary valve having an annular chamber H, openings H¹, and H¹¹, chambers I at each side of said valve, each having an opening into one end of the cylinder, and ports from the openings H¹, H¹¹, to said chambers I, I, and the air vent J, substantially as described.

No. 38,059. Holder for Jewels. (Porte-bijou.)

Almer T. Richardson and Frank Russell Cunningham, both of Ware, Massachusetts, U.S.A., 4th January, 1892; 5 years.

Claim.—1st. A jewel holder consisting in the flat bar A, having transverse aperture *b* and a longitudinal slot forming spring jaws *c c'* a strap *e*, pivoted flatwise to the side of one jaw and having an eye *f*, a lever B, pivoted to the same side of the opposite jaw, and having an eccentric *g*, encircled by said eye *f*, substantially as set forth. 2nd. A jewel-holder consisting in the flat bar A, slotted longitudinally to form jaws *c c'*, having notches to receive the jewel, a transverse aperture *b* at the inner end of the slot and a second aperture *a* in rear thereof, the link or strap *e* pivoted flatwise to the side of the jaw *c* and having an eye *f*, and the lever B, pivoted to the same side of the jaw *c'* and having an eccentric encircled by the said eye, substantially as set forth.

No. 38,060. Car Coupler. (Attelage de chars.)

Jeremiah William Kirby, Hans Peterson, Jesse L. Henry and William R. Getz, all of Great Falls, Montana, U.S.A., 4th January, 1892; 5 years.

Claim.—1st. In a car coupler, the combination with the drawhead, of the uncoupling rock-shaft, the crank-arm attached thereto and the vertical operating rod having an aperture or slotted end adapted to receive the rear end of the crank-arm, substantially as shown and described. 2nd. In a car coupler, the combination with the drawhead having longitudinal recesses in its upper face, a hooked link pivoted in one of the recesses, the catch bar arranged in the other recess, and the uncoupling arms arranged in each recess and adapted to be operated, substantially as shown and described. 3rd. In a car coupler, the combination with a drawhead having longitudinal recesses in its upper face, the pivoted hook or link, the transverse catch bar, the rock-shaft and lifting arms arranged in each recess, substantially as and for the purpose described. 4th. In a car coupler, the combination with a drawhead having longitudinal recesses in its upper face, one of said recesses being wider than the other and flaring at its front and rear end, the transverse catch bar arranged in the wider recess, and the hooked link pivoted in the narrow recess, all arranged, substantially as shown and described. 5th. In a car coupler, the combination with a drawhead having longitudinal recesses in its upper face, one of which is wider than the other, the transverse catch bar, the transverse rock-shaft, the lifting arms attached to the rock-shaft and resting in the longitudinal recesses, and the pivoted hook or link pivoted in the narrow recess above the lifting arm in said recess, substantially as shown and described.

No. 38,061. Case for Bottles. (Caisse pour bouteilles.)

Claud Estelle Marlow and Daniel Shultz Park, both of Colorado, Texas, U.S.A., 4th January, 1892; 5 years.

Claim.—In a bottle-holding case or box, the combination, with inner encircling horizontal wires, of body and neck holding diaphragms constructed of metal bands or wires woven around the encircling wires and woven or twisted together to form circular supports for the bodies and necks of the bottles, substantially as described and set forth.

No. 38,062. Hot Water Heater. (Calorifere à eau.)

David Lancaster Dwinell, the firm of Miller Bros. & Toms, all of Montreal, Quebec, Canada, 4th January, 1892; 5 years.

Claim.—1st. In a hot water heater, the water space sub-divided to prevent commingling of the streams from the return pipes at the base thereof, for the purpose set forth. 2nd. In a hot water heater, the water space of the fire-pot section, alone or together with the remaining section of the heater, sub-divided by partitions into compartments of varying sizes possessing different areas of heating surface, for the purpose set forth.

No. 38,063. Binder for Harvesters.

(Moissonneuse-tieuse.)

A. Harris, Son & Co., assignees of Lyman Melvin Jones and James Wedlake, all of Brantford, Ontario, Canada, 4th January, 1892; 5 years.

Claim.—In a harvester binder, an upper elevating canvas frame, loosely supported in such a manner that it will move vertically to suit the thickness of the grain being elevated, substantially as hereinbefore specified. 2nd. In a harvester binder, an upper elevating canvas frame, free at one end, but flexibly connected at its other end to the front of the elevator, the rear side piece of the said elevator being removed, substantially as hereinbefore specified. 3rd. In a harvester binder, an upper elevating canvas frame, free at one end, but flexibly connected at its other end to the front of the elevator, the rear side piece of the said elevator being removed, in combination with a spring or springs, arranged to act upon the rear side of the upper elevating canvas frame, substantially as hereinbefore

specified. 4th. A diagonal support K, bolted to the sill L, and resting on the extension N, of the wheel-frame extending obliquely to a point outside of the elevator frame, where it is turned upwardly to form a support for the rear of the seat-board E, substantially as hereinbefore specified.

No. 38,064. Rotary Engine, Blower, Pump, and Water Meter. (*Machine rotatoire, machine soufflante, pompe et compteur à eau.*)

Robert Johnson, Bradford, York, England, 4th January, 1892; 5 years.

Claim.—In a rotary engine, blower, pump, or water meter, the combination with a vane cylinder having projecting vanes, of a valve cylinder geared thereto in such a manner that the cylindrical portions of said valve cylinder revolve at a greater surface speed than the cylindrical portions of said vane cylinder, substantially as herein shown and described, and for the purpose specified.

No. 38,065. Screen Door. (*Ecran de porte.*)

William R. Lyle, Ripon, Wisconsin, U.S.A., 4th January, 1892; 5 years.

Claim.—1st. The combination, with a screen door frame provided with detachable cross strips and vertical strips, and adapted to receive storm panels upon one side, of the rails and mullions upon the opposite side corresponding with the strips, said strips interlocking with each other and with the door frame, substantially as and for the purpose set forth. 2nd. The combination, with a screen door frame and panels, of the cross strip 7, having lugs 9, the vertical strips 8, 8, and fastening device 11, for removably securing said strip to the screen frames, substantially as described.

No. 38,066. Suspender. (*Bretelles.*)

Elias H. Lieberthal, Bay City, Michigan, U.S.A., 4th January, 1892; 5 years.

Claim.—1st. The flexible junction piece C carrying the suspender ends, formed with a transverse slot and having combined with it a slotted plate, provided with downward projecting teeth *s*, on the upper wall of the slot in the plate, essentially as described. 2nd. The flexible junction piece formed of superposed layers of leather or other suitable flexible material and having a transverse slot there-through, a plate secured between said layers and having a transverse slot registering with the slot in said junction piece, the upper wall of the slot in the plate being provided with downward projecting teeth, and the suspender ends B, B, secured between the lower ends of said layers, substantially as set forth.

No. 38,067. Corner Shield. (*Cornure.*)

David Henry Rockwell, Binghamton, New York, U.S.A., 4th January, 1892; 5 years.

Claim.—1st. The herein described spring metal plate for the purpose set forth, provided with the closely arranged, fine, continuous, biting serrations, having ragged edges on their inner sides, as and for the purpose set forth. 2nd. The herein described triangular spring metal plate for the purpose set forth, having its edges provided with the fine, closely arranged, biting serrations arranged and formed to operate as set forth. 3rd. In combination, triangular spring metal plates E, E and D, all of said plates having their engaging edges provided with closely arranged biting serrations, substantially as shown and described. 4th. In a shield or protector for the purpose described, consisting of a plate having serrations on its edges and recesses formed in opposite edges for the reception of screws, substantially as specified.

No. 38,068. Compound Dynamo Electric Machine.

(*Machine dynamo-électrique composée.*)

Reliance Electric Manufacturing Company, Waterford, Ontario, Canada, assignees of Frank Bankson Rae, Detroit, Michigan, U.S.A., 4th January, 1892; 5 years.

Claim.—In a dynamo-electric generator, the combination, with a series coil and shunt-coil, of vertical cores and two horizontal pole-pieces, each of the latter having a circular groove formed therein, bounding the base and top of the core, and of the desired shape and dimensions to accommodate and hold the said series coil in a position independent of the shunt-winding, substantially as described.

No. 38,069. Motor Truck for Electrically Propelled Vehicles. (*Châssis de moteur pour voitures à propulsion électrique.*)

Reliance Electric Manufacturing Company, Waterford, Ontario, Canada, assignees of Frank Bankson Rae, Detroit, Michigan, U.S.A., 4th January, 1892; 5 years.

Claim.—1st. A motor truck consisting of a rectangular frame rigidly mounted on the axles, cross-bars connected to the frame supporting the motor, a counter-shaft also connected to the frame, and gears connecting the armature and axle through the medium of the counter-shaft and operating the wheels upon the axles, substantially as described. 2nd. A motor truck consisting of a rectangular frame rigidly supported upon the axles, cross-pieces mounted on the frame

to which the field magnets of the motor are connected, a counter-shaft also connected to the frame, gearing connecting the armature and one of the axles, and connecting rods connecting the wheels together, substantially as described.

No. 38,070. Process and Apparatus for Refining and Purifying Petroleum. (*Procédé et appareil pour raffiner et purifier le pétrole.*)

Herman Frash, Cleveland, Ohio, U.S.A., 4th January, 1892; 5 years.

Claim.—1st. The process hereinbefore described of desulphurizing and refining sulphur-bearing petroleum or petroleum distillate, by vaporizing the same in a still, passing the vapor through a vessel or vessels partially filled with a solution or mixture of metallic oxide or other substance having a strong affinity for sulphur, which is carried in film or spray through the vapor by means of one or more brushes or equivalent device, substantially as and for the purposes described. 2nd. The process of desulphurizing hydrocarbon liquids by means of a solution of metallic oxide, by causing the vapor of the liquids to pass over and in contact with moving surfaces wet with the oxide solution, substantially as described. 3rd. The combination of a still for vaporizing petroleum, a vapor chamber containing one or more cylinders, each having a revolving brush, suitably connected together; substantially as and for the purposes described. 4th. The combination of the still A, the casing D, connected therewith, the cylinders B and C within the casing, a revoluble brush H within each cylinder, and the pipes E, *a*, *b*, and *c*, and condenser F, constructed and arranged substantially as described. 5th. The combination with a vaporizing still of a cylinder or cylinders connected with the vapor space of the still, and each having a revolving brush, and a refrigerating or condensing apparatus, substantially as and for the purposes described. 6th. As a device for treating hydrocarbon liquids with desulphurizing liquids, a cylinder containing a revolving brush constructed substantially as described.

No. 38,071. Art or Process of Refining Petroleum.

(*Art ou procédé pour raffiner le pétrole.*)

Herman Frash, Cleveland, Ohio, U.S.A., 4th January, 1892; 5 years.

Claim.—1st. The process of purifying petroleum from sulphur compounds, consisting in subjecting crude sulphur bearing petroleum to the action of nitrous acid during the process of distillation, for the oxidation and separation from the oil of such sulphur compound, substantially as described. 2nd. The process of purifying petroleum from sulphur compounds, consisting in mixing together nitrate of potash and sulphuric acid which has been previously used in the ordinary sulphuric acid treatment of petroleum, placing said mixture in a still, charging crude sulphur-bearing petroleum into the still, heating the still, first to produce nitrous acid, and then to distill over the petroleum, then re-distilling over lime the distillate thus produced, and subjecting the final distillate to the ordinary sulphuric acid treatment, substantially as described. 3rd. The process of purifying sulphur-bearing petroleum, consisting of first distilling crude petroleum in the ordinary way; second, agitating the distillate in an agitator into which nitrous acid fumes are introduced during the agitation; third, washing the distillate thus treated with water and alkali to remove the sulphuric acid formed therein by the preceding operation; fourth, treating the distillate with sulphuric acid; and finally redistilling the treated distillate over lime, once or oftener substantially as and for the purposes hereinbefore described. 4th. In the process of purifying sulphur-bearing petroleum or its distillate, treating the same with nitrous acid, for the purpose of oxidizing the sulphur compounds, and afterwards distilling the oil or distillate, substantially as and for the purposes hereinbefore described.

No. 38,072. Treatment of Vegetable Textile Fabrics for the Manufacture of Yarns and Fabrics. (*Traitement de la fibre végétale pour la fabrication des fils et étoffes.*)

Felix Victor Max Raabe, London, England, 5th January, 1892; 5 years.

Claim.—1st. In the treatment of vegetable textile fibres for the manufacture of yarns and fabrics, subjecting said fibres to the action of a solution of an alkali and urine mixed together, substantially as herein set forth, preparatory to opening, cleaning and dividing said fibres. 2nd. The process of treating vegetable textile fibres for the purpose set forth, which consists in subjecting said fibres to the action of a solution of an alkali and urine mixed together, rinsing the fibres so treated, removing the rinsing liquid therefrom, drying the said fibres, and finally opening, cleaning and dividing said fibres, substantially as herein described. 3rd. The herein described process of treating vegetable textile fibres, for the purpose set forth, which consists in boiling said fibres in a solution of an alkali and urine mixed together, rinsing the fibres so treated, treating the fibres in a hydro-extractor, drying the fibres, treating them in a "shake-wiley," and opening, dividing and cleaning said fibres in a compound machine, comprising an opener of the Garnett type, and a carding engine having two or more "swifts" suitably clothed, as set forth.

No. 38,073. Wheeled Vehicle. (Voiture à roue.)

William Farquhar, Montreal, Quebec, Canada, 5th January, 1892; 5 years.

Claim.—1st. The application of straight wheels to ordinary road carts, turning around their axles, for the purpose hereinabove described. 2nd. The application, to road vehicles, of revolving axles independently of the revolving wheel, substantially as described hereinabove.

No. 38,074. Safety Cut-Out. (Interrupteur de sûreté.)

Reliance Electric Manufacturing Company, Waterford, Ontario, Canada, assignees of Frank Bankson Rae, Detroit, Michigan, U.S.A., 9th January, 1892; 5 years.

Claim.—1st. The combination, with a circuit controller included in an electric circuit, consisting of a bridge having two terminal points adapted to make and break contact with terminals of said circuit, of a system of levers placed in operative relation to said circuit controller, an electro-magnet and armature for operating said system of levers, said electro-magnet being included in the main circuit, a branch electric circuit, including a dielectric, and extending from the working circuit to the ground, and including a coil co-operating with the aforesaid electro-magnet, all arranged to operate substantially as described.

No. 38,075. Limit Switch. (Commutateur limité.)

Reliance Electric Manufacturing Company, Waterford, Ontario, Canada, assignees of Frank Bankson Rae, Detroit, Michigan, U.S.A., 9th January, 1892; 5 years.

Claim.—1st. In a limit switch, a circuit-breaker normally held within the field of force of a magnet, the poles of which are included in the circuit, substantially as described. 2nd. In a limit switch, the combination with the poles of a magnet included in the circuit, of a circuit-breaker normally in electric contact with the poles within their field of force, mechanism controlling the movement of the circuit-breaker, the arrangement being such that when the circuit is broken the field of force is at its maximum, substantially as described. 3rd. In a limit switch, the combination with the magnets having pole pieces included in the electric circuit, of a circuit-breaker in electric connection with the pole pieces and within their field, and an armature lever controlling the circuit-breaker and controlled by the magnets, substantially as described. 4th. In a limit switch, the combination with the magnets having pole pieces included in the electric circuit, of a circuit-breaker in electric connection with said pole pieces and in their field of force, a lever carrying said contact-piece, an armature lever normally engaging said contact-piece, the armature of which is operated by the magnets, and a spring for regulating the operation of the armature lever, substantially as described. 5th. In a limit switch, the combination with the magnets, the coils of which are included in the circuit, the said magnets being provided with pole pieces also included in the circuit, of a circuit-breaker connecting the pole pieces, and an armature lever controlling the circuit-breaker, and an insulated armature carried by said armature lever, substantially as described. 6th. In a limit switch, the combination with the magnets, the coils of which are included in the circuit, the said magnets being provided with pole pieces also in the circuit, of a contact-breaker connecting the pole pieces and an armature controlling the contact-breaker, arranged to be operated by said magnets when the current is excessive, whereby at the movement of breaking the circuit the field of force of the extended pole pieces is at its maximum, substantially as described. 7th. In a limit switch, the combination with the magnets having extended pole pieces included in the circuit, of a contact piece connecting the pole pieces, non-magnetic plates between the pole pieces and the contact piece, an armature lever controlling the circuit-breaker, and an armature connected therewith and surrounded by an insulating material and operated by the magnets, the thickness of the insulating material being less than the thickness of said non-magnetic pieces, substantially as described. 8th. In a limit switch, the combination with the magnets having pole pieces included in the circuit, of a circuit-breaker connecting the pole pieces, a lever carrying the circuit-breaker, adjustable springs normally holding said lever under tension, an armature lever controlling said circuit-breaker, and a lever, the armature of which is controlled by the magnets, substantially as described. 9th. In a limit switch, the combination of the magnets, the coils of which are included in the circuit, the said magnets being provided with polar extensions also included in the circuit, non-magnetic plates secured to said pole pieces, springs secured to the plates, and a circuit-breaker connecting said poles and fitted in space between said springs and plates, substantially as described. 10th. In a limit switch, the combination with the magnets, of a circuit-breaker constituting the neutral part of the magnetic system, substantially as described. 11th. In a limit switch, the combination with the magnets, of a circuit-breaker constituting the neutral part of the magnets under normal conditions, and an armature constituting the neutral part of the magnets when the circuit is broken, substantially as described. 12th. In a limit switch, the combination with the magnets, and circuit-breaker constituting the neutral portion of the magnetic system under normal conditions, of an armature controlled by the magnets, the arrangements being substantially as described, whereby the approach of the armature to the free poles of the magnets increases the field of force

at the circuit-breaking portions of the magnetic system, substantially as described. 13th. In a limit switch, the combination with the magnets, of a circuit-breaker closing the poles of the magnets, and an armature controlled by the magnets and operating to close the magnetic circuit at the other end when it is broken by the operation of the circuit-breaker under abnormal conditions, substantially as described.

No. 38,076. Automatic Switch for Stationary Motors.

(Commutateur automatique pour moteurs stationnaires.)

Reliance Electric Manufacturing Company, Waterford, Ontario, Canada, assignees of Frank Bankson Rae, Detroit, Michigan, U.S.A., 9th January, 1892; 5 years.

Claim.—1st. A switch for electric motors, consisting of a lever and circuits and connections substantially as described, whereby the circuit is first closed directly through the shunt of the motor and through a resistance in the armature shunt of the motor, which resistance is gradually cut out as the switch lever is moved, until the circuit is direct through the shunt armature of the motor, substantially as described. 2nd. In a switch device for electric motors, the combination with a break switch in the main circuit, of a direct circuit including the field coils of the motor, a shunt for the armature including a series of resistances, and a switch lever in said circuit to gradually cut out the resistance as it is moved to start the motor, substantially as described. 3rd. In a switch device for electric motors, the combination with a break switch in the main circuit, of a connection therefrom including the field coils of the motor, a shunt including the armature of the motor, resistance devices in said shunt, and switch arm controlling the resistance devices and controlling the break switch, substantially as described. 4th. In a switch device for electric motors, the combination with a break switch in the main line, of a switch arm in the armature shunt, said arm provided with connections for automatically operating the break switch as it is moved to open or close the circuit of the motor, substantially as described. 5th. In an automatic switch device for electric motors, the combination with a break switch consisting of an arm having extensions, of a switch lever provided with an extension to engage the extensions on the break switch, whereby the break switch is automatically moved on the movement of the switch, substantially as described. 6th. In an automatic switch device for electric motors, the combination of a break switch having extensions, a switch lever, a series of resistances in the armature circuit controlled by said lever, and an extension on said lever for operating the break switch as the resistance devices are cut in or out of the circuit, substantially as described. 7th. In an automatic switch device for electric motors, the combination of the break switch in the main circuit, a circuit therefrom including the fields of the motor, a shunt circuit including the armature of the motor, resistance devices in said armature circuit, a switch lever controlling said resistance devices, and an electric magnet controlling said switch lever, substantially as described. 8th. In an automatic switch device for electric motors, the combination with a break switch in the main circuit, of a switch lever in the armature circuit controlling the resistance therein, an extension on said lever operating the break switch, and an electric magnet and armature controlling the switch lever, substantially as described. 9th. In an automatic switch device for electric motors, the combination with a pivoted break switch having extensions, of a pivoted switch lever having an extension engaging the extensions of the break switch, an electro magnet controlling the movement of said switch lever, and a spring for retracting it to its normal position, substantially as described. 10th. In an automatic switch device, the combination with the pivoted break switch having extensions, the pivoted switch lever having an extension engaging the break switch, a shunt armature-circuit for the motor, including a series of resistances, an electro magnet included in said circuit, an armature for the magnet provided with a catch engaging the switch lever, and a spring for retracting the switch lever, substantially as described.

No. 38,077. Painting Machine. (Machine pour peindre.)

Edwin Armitage, Toronto, Alexander Grant Cole, Ottawa, Thomas Dill, Toronto, all of Ontario, Canada, 9th January, 1892; 5 years.

Claim.—In a machine for painting fabric materials, the combination of a frame consisting of standards united at their upper ends by side bars, said bars being each provided or formed with two projecting threaded standards or lugs, and having their upper ends grooved; grooved guide bars, located above the connecting side bars, a roll mounted in boxes fitting the grooved guide and side bars, screws passing through the standards and bearing against said boxes, rolls also mounted between the guide and side bars in a line with the first named roll, and connected by an endless apron, the roll nearest the first named roll being mounted in adjustable boxes, screws passing through the other standards of the side bars and adjusting the last named boxes, mechanism located above said endless apron or table, for automatically distributing a coat of paint upon the material as it passes over the table, and means for rotating the rolls, substantially as described. 2nd. In a machine for painting fabric material, the combination of a frame, consisting of standards united by upper and central side bars, said upper side bars being formed or provided each with two projecting threaded standards or

lugs, and having their upper edge grooved, a web roll journaled in bearings at one end of the frame, a roll journaled in the central side bars, a roll journaled above the web roll, grooved guide bars located above the upper side bars of the frame, a roll mounted in the boxes fitting the grooved guide and side bars, screws passing through the standards and bearing against said boxes, rolls also mounted between the guide and side bars in a line with the first named roll and connected by an endless apron, the roll nearest the first named roll being mounted in adjustable boxes, screws passing through the other standards of the side bars and adjusting the last named boxes, a roll at the forward end of the frame, means for rotating the several rolls, and mechanism located above the endless apron or table for automatically distributing a coat of paint upon the material as it passes over the table, substantially as set forth. 3rd. In a machine for painting material, the combination of a frame, standards located at the forward end thereof and provided with guides, a collar secured to the standards and having a threaded aperture, a movable block sliding in the guides formed in the standards, an adjusting screw passing through the collar and having its lower end passing into a threaded aperture in the movable block, a paint distributing plate journaled in the movable block, and a paint tank provided with a faucet for directing the paint upon the distributor from which it is fed to the material operated upon, substantially as set forth. 4th. The combination of the web roll 4, rolls 7 and 8, journaled in the framework of the machine, a standard 9, extending upwardly from the upper side bar and having an aperture through which passes an adjusting screw 10, the movable roll 16, the table formed by a continuous jacket passing over the periphery of the two rolls 17 and 21, the roll 21 giving a rotary motion to the said jacket and roll 17, the paint distributor 21, adjustably connected to the standard 38, of the paint tank frame, the paint tank 34, provided with a faucet and an agitator, substantially as and for the purpose specified. 5th. In a painting machine, the web roll 4, journaled in the framework 1, the roll 7, journaled in bearings 6, formed on the side bar 5, the roll 8, journaled in bearings formed on the upper corner of the machine, the roll 16, journaled in movable bearings 14, sliding in guides formed between the guide bar 11, and upper side bar of the framework, the roll 17, journaled in movable bearings 15, sliding in guides formed between the said guide bar 11, and the side bar of the machine, adjusting screws 10 and 19, for moving respectively, the bearings 14 and 15, the roll 21, journaled in stationary bearings 23, a continuous rubber jacket 20, passing over the periphery of the said rolls 17 and 21, the roll 23, journaled in suitable bearings 24, formed on the extension of the said side bar 5, a paint distributor 51, journaled in bearings adjustably attached to the standard 32, and operated by means of an adjusting screw 49, passing through a collar 48, rigidly secured to said standard 32, a removable tank 34, inserted in the frame work and provided with a faucet to supply the paint to the distributor 51, midway between the toe and the journal, an agitator 40, rigidly secured to a spindle 38, journaled in the said paint tank 34, and fitted on its upper end with a bevelled gear 39, a bevelled gear 41, fitted to the end of the spindle 42, journaled in bearings formed on the upper side of the framework supporting the paint tank, a sprocket wheel on the end of the said spindle 42, and driven from the roll 21, by means of a sprocket chain passing over the sprocket wheel on the end of the said spindle and on the end of the said roll, substantially as and for the purpose specified.

No. 38,078. Method of Welding Rings by Electricity.

(Méthode de souder les anneaux par l'électricité.)

The Thomson Electric Welding Company, Boston, assignees of Hermann Lemp, Lynn, both of Massachusetts, U.S.A., 9th January, 1892; 5 years.

Claim.—1st. The herein described improvement in welding metal rings or other curved metal objects, which consists in causing the electric current to pass through the continuous portion of the blank in amount sufficient to soften the same, and moulding or conforming such continuous portion to the curve required simultaneously with the welding operation. 2nd. The herein described method of forming rings or other endless metal objects having an open centre, consisting in bending a bar of metal of a length greater than the circumferential length of the desired finished article until its ends overlap, springing the ends apart and abutting them, and then electrically welding said ends together, while at the same time moulding the continuous portion of the bar to the exact conformation desired. 3rd. The herein described improvement in making electrically welded rings, which consists in forming a curved blank from a continuous piece of metal of somewhat greater length than the circumferential length of the finished ring, placing the free ends of the blank in abutment in an electrical welding apparatus and then forcing them toward one another to effect the weld, while at the same time shaping or moulding the other portions of the blank to the desired curve or form. 4th. The herein described improvement in forming rings or other curved metal objects by the electric welding process, consisting in moulding or shaping the continuous parts of the object to the finished form in the operation of forcing the parts to be welded toward one another. 5th. The herein described method of forming electrically welded rings, consisting in bending a bar or piece of metal into a curve with its ends overlapping to the extent required for the weld, springing the ends apart and abutting them against one another, and then forcing such ends toward one another while

heated by the electric current, and at the same time moulding the metal to the shape of the finished ring. 6th. The herein described method of electrically welding rings or other curved objects, consisting in bending a rod or bar of metal into the general shape required, abutting the ends against one another, passing an electric current across the joint and then forcing the ends toward one another, while at the same time moulding the metal to the shape of the finished article desired.

No. 38,079. Transformer for Heavy Currents.

(Transformateur pour courants.)

The Thomson Electric Welding Company, Boston, assignees of Hermann Lemp, Lynn, both of Massachusetts, U.S.A., 9th January, 1892; 5 years.

Claim. 1st. A secondary conductor consisting of a copper bar conformed to the primary circumferentially, and having one or more grooves or depressions in its face to receive such primary. 2nd. In a transformer, a secondary consisting of a bar of copper cast in one piece with a groove or depression adapted to receive the primary conductor. 3rd. In a transformer, a secondary formed of a solid bar or mass of copper, having an opening through it adapted to receive the core or magnetic mass of the transformer, and provided with a groove or depression for the primary conductor. 4th. In a transformer, the combination, with a primary conductor, of a secondary conductor formed as a solid bar or mass of copper, having an opening through it, and provided on one or both its faces with a groove or depression adapted to receive the primary wire or conductor. 5th. In a transformer, a secondary consisting of a bar of copper cast in one piece with a groove or depression adapted to receive the primary conductor cut in two, and provided at either side of the cut with suitable clamps to transmit the current to translating devices.

No. 38,080. Electrical Apparatus for Welding Rings.

(Appareil électrique pour souder les anneaux.)

The Thomson Electric Welding Company, Boston, assignees of Hermann Lemp, Lynn, both of Massachusetts, U.S.A., 9th January, 1892; 5 years.

Claim.—1st. In an electric metal-working apparatus, the combination of two clamps or clamping jaws having a conducting-bearing on the outside of the curve of the ring or other curved object, and adapted to be moved toward one another on a line intersecting such curve, as and for the purpose described. 2nd. In an electric metal working apparatus, the combination, substantially as described, of two curved clamping jaws pivoted eccentrically to the curve on which their clamping faces are pivoted. 3rd. In an electric welding apparatus for welding rings and other curved pieces, the combination of two semi-circular jaws, one or both pivoted to move on a line intersecting the circumference of their circle, of which their curved clamping faces form a part. 4th. In an electric welding apparatus, the combination, substantially as described, of two semi-circular jaws pivoted to one side of the circumference of a circle formed by the ring or other curved object which is to be welded or worked electrically between them. 5th. In an electric welding apparatus, the combination of the semi-circular clamping jaws, each provided with a block of some good conducting material, like copper, and adapted to bear against the outside of the ring or other object to be welded when the jaws are forced toward one another.

No. 38,081. Sliding Clamp for Electric Welding Apparatus. (Crampon mobile pour soudage électrique.)

The Thompson Electric Welding Company, Boston, assignees of Hermann Lemp, Lynn, both of Massachusetts, U.S.A., 9th January, 1892; 5 years.

Claim.—1st. In an electric welding or metal working apparatus, a slide supported on its rest or bed by a V-shaped bearing, said slide and bed being included in an electric circuit to the work, so that the electric current will pass through the bearing. 2nd. The combination, in an electric welding or metal working apparatus, with a clamp-slide having a V-shaped bearing or bearings, of a downward pressure spring, as and for the purpose described. 3rd. The combination, in an electric welding or metal-working apparatus, of a clamp slide, a fixed bearing therefor, and interposed conducting rolls of copper or other good conducting material, as and for the purpose described. 4th. The combination, with the movable slide, in an electric welding or metal working apparatus, of a downward pressure spring carried beneath the slide and interposed rolls between such spring and the bed or table. 5th. In an electric welding apparatus, a conducting slide having a mechanical bearing and electrical contact or connection through V-shaped bearing surfaces, as and for the purpose described. 6th. The combination, in an electric welding or metal working apparatus, with a V-shaped conducting slide or depending rod or rods and springs carried thereby for imparting a downward pressure. 7th. The combination, in an electric welding and metal working apparatus, of a conducting slide supported on a seat or bed by a V-shaped bearing, and having a rod or rods extending through such rest or bed for connection with springs for holding the slide in contact with the bed. 8th. The com-

mination, with the conducting slide, in an electric welding or metal working apparatus, of a conducting slide rest on which the slide bears by a V-shaped bearing and interposed conducting cylindrical rods of copper, as and for the purpose described. 9th. The combination, with a conducting slide, in an electric welding or metal-working apparatus, of a V-shaped bearing for said slide and interposed roller-contacts, as and for the purpose described.

No. 38,082. Electric Welding Machine.

(Appareil de soudage électrique.)

The Thomson Electric Welding Company, Boston, assignees of Hermann Lemp, Lynn, both of Massachusetts, U.S.A., 9th January, 1892; 5 years.

Claim. 1st. The combination, in an electric metal working apparatus of a plurality of transformer secondaries, arranged parallel to one another and in contact with the work holding devices, so as to apply current to the same in multiple arc. 2nd. The combination, in an electric metal working apparatus, of two secondary bars or conductors having separate cores and arranged at angles to one another, in combination with a clamp slide working in the angular bearing formed by the outer surfaces of the secondary bars or conductors, as and for the purpose described. 3rd. The combination, in an electric metal working apparatus, of a plurality of secondary bars or conductors, disposed circumferentially around the work holding devices, and in contact therewith, as and for the purpose described. 4th. The combination, in an electric metal working apparatus, of work holding devices divided into sections insulated from one another, and secondary bars or conductors disposed symmetrically around the same at different angular positions and in contact respectively, with the parts of said work holding devices. 5th. The combination, in an electric metal working apparatus, of a four part work holding clamp, sections of which are insulated from one another, and four secondary bars or conductors disposed symmetrically around the same, as and for the purpose described. 6th. The combination, with the divided work holder, of separate transformer secondaries, each having a separate core, and means for regulating the current in the primaries of the transformers, as and for the purpose described. 7th. The combination, in an electric metal working apparatus, of different secondary bars or conductors, supplying different parts or portions of the work and each having a separate core, and means for varying the current in the primaries of said secondary conductors. 8th. In an electric metal working apparatus, the work holder having two or more clamp jaws working on converging lines, and insulated from one another. 9th. In an electric metal working apparatus, a clamp side or base divided into sections insulated from one another, and provided with separate clamp jaws working toward a common centre. 10th. In an electric metal working apparatus, the combination, with a work holder, of a plurality of clamping jaws, a separate pressure cylinder for each jaw, and means for controlling the pressure in said cylinders simultaneously. 11th. The combination, with a plurality of clamp jaws *d*, working in converging lines, of a pressure cylinder for each, a source of pressure common to said cylinders, and a valve for controlling the pressure.

No. 38,083. Type-writer. (Clavigraphie.)

Jacob Felbel, New York, N.Y., Assignee of Andrew Wilson Steiger, Bridgeport, Connecticut, all in the U.S.A., 9th January, 1892; 5 years.

Claim.—1st. In a type-writing machine, the combination of a guided rod and a type carrier, pivotally connected thereto at two points. 2nd. In a type-writing machine, the combination of a guided rod, and a type carrier pivotally connected thereto at two points by means of two pivoted links, substantially as described. 3rd. In a type-writing machine, the combination of links 10 and 17, pivotally connected each to a type carrier and to a rod arranged between the links 10 and 17 and adapted to move therewith, substantially as described. 4th. In a type-writing machine, the combination of links 10 and 17, pivotally connected at their inner ends to a type carrier, a rod 8, pivotally connected at 12 to the link 10, and at 16 to the outer end of the link 17, and a guide for the rod 8, substantially as described. 5th. In a type-writing machine, the combination of links 10 and 17, pivotally connected to a type carrier, a rod 8, pivotally connected to said links, and a guide for said rod, substantially as described. 6th. In a type-writing machine, the combination of links 10 and 17, pivotally connected to a type carrier, a rod 8, pivotally connected to said links, and a guide lever for said rod, substantially as described. 7th. In a type-writing machine, the combination of links 10 and 17, pivotally connected to a type carrier, a rod 8, pivotally connected to said links and having an extension, and a guide for said rod, substantially as described. 8th. In a type-writing machine, the combination of links 10 and 17, pivotally connected to a type carrier, a rod 8, pivotally connected to said links and having an extension, and a guide lever connected to said extension, substantially as described. 9th. In a type-writing machine, the combination of links 10 and 17, pivotally connected to a type carrier, a rod 8, pivotally connected to said links, a guide lever, a letter and a key lever, substantially as described. 10th. In a type-writing machine, the combination of a downwardly and inwardly extending link 10, a substantially horizontal link 17, a type carrier connected to the inner ends of said links at the points 13 and 18, and a guided rod 8, connected at 9 to the link 10, and at 16 to the outer end of the link 17, substantially as described.

No. 38,084. Burner for Crude Oil or other Liquid Fuel. (Foyer à combustible liquide.)

Theodore Willi and Alfred Bradley, both of Dayton, Ohio, U.S.A., 9th January, 1892; 5 years.

Claim.—1st. The combination, with the cup-shaped burner provided with a central conical or tapering recess in its floor and the oil supply pipe opening into the bottom of said recess, of a solid metallic vaporizer having its lower or base part fitted into said recess in such manner that an oil chamber is formed below it therein, and provided with a surrounding annular recess in said lower part to form a heating chamber with the burner, and suitable ducts extending from the oil chamber below the burner to the said recess and from the recess to the floor of the burner, substantially as specified. 2nd. The combination, with the burner A, having the recess *a* and the supply pipe *g* opening into the bottom of said recess, of the solid metallic vaporizer B, having the lower portion *b* provided with the surrounding annular recess D and the sets of ducts C and E, the upper portion *b'* extending above the floor of the burner and forming the shoulder *b''* with the lower portion, substantially as specified.

No. 38,085. Copy Holder for Type-writers.

(Porte-manuscrit pour clavigraphes.)

William Joseph Still and Samuel John Moore, both of Toronto, Ontario, Canada, 9th January, 1892; 5 years.

Claim. 1st. A desk having a clamp pivoted on it and actuated by springs, in combination with a light frame pivoted on the said clamp and set so that its sides are held clear of the desk by its upper end, substantially as and for the purpose specified. 2nd. A desk having a clamp pivoted on it and actuated by springs, in combination with a light frame pivoted on the said clamp and set so that its sides are held clear of the desk by its upper end, and a bar or rod movably connected to the said plate, substantially as and for the purpose specified. 3rd. A desk A, pivoted at *a*, on the legs D, to which the legs C are pivoted at *b*, in combination with the metal plate D, pivotally supported by the posts E, and actuated by a suitable spring, in combination with the wire frame G, pivoted at *f* in the plate D, and set so that its upper end *g*, only shall be held in contact with the face of the desk A, by the action of the springs H, substantially as and for the purpose specified.

No. 38,086. Guide Rod for Tops of Freight Cars.

(Barre conductrice pour couvertures de chars à marchandises.)

Michael Sullivan, Royalton, Wisconsin, U.S.A., 9th January, 1892; 5 years.

Claim.—The combination of a railway freight car with three rows of railing and posts arranged at intervals upon the top of said car, so as to provide hand supports and two distinct passage ways for brakemen in passing from one car to the other, substantially as described.

No. 38,087. Boot and Shoe. (Chaussure.)

Thomas John Hood, Newtown Road, Sydney, New South Wales, Australia, 9th January, 1892; 5 years.

Claim.—1st. A boot or shoe for foot wear, wherein the inner edge of the sole is formed un bent or approximately so, and approximately in line with the heel, whether or not the outer corner of the toe is curved or cut away, substantially as described. 2nd. A boot or shoe for foot wear having an elastic webbing fixed in the forward part of the vamp, and extending from the leg to the root of the toes, or thereabouts, substantially as described. 3rd. The combination with a boot or shoe upper of an elastic web fixed centrally or approximately so in one or more sections, and extending to a point at the root of the great toe, or thereabouts, substantially as described. 4th. The combination with a boot or shoe upper or vamp having an elastic web extending from the leg to the root of the toes, or thereabouts, of a covering flap or tongue rigidly secured along one edge to said vamp, and at the other edge held down against said upper or vamp by buttons, clips, or laces, substantially as described. 5th. The combination of a boot or shoe upper having an elastic web extending from the leg to the root of the toes, or thereabouts, of a covering flap or tongue rigidly secured along one edge to said vamp and at the other edge held down against such upper or vamp by buttons or equivalent contrivances, and a bellows piece between the free edge of such flap or tongue, and the part of the upper or vamp lying below same, substantially as described. 6th. The combination with a boot or shoe upper or vamp of the general form illustrated, of a flap or tongue covering the elastic webbing, such flap or tongue being secured centrally to the said webbing and at the edges held down by buttons or equivalent contrivances, substantially as described. 7th. The combination with a boot or shoe upper or vamp of an elastic web extending from the legs to the toes, or thereabouts, and provided with an interior tongue sewn to or integral with the upper or vamp at the one edge and free at the other edge, substantially as described with reference to Figure 4 of the drawings.

No. 38,088. Animal Trap. (Piège.)

Chancy Robert Jenne, Fort Wayne, Indiana, U.S.A., 9th January, 1892; 5 years.

Claim.—An animal trap having vertical sides, an elongated tapering platform pivoted therein, a rear inclosed end, a bait receptacle within the same, a magnet secured to the under side of the outer enlarged end of the platform, a sill having a keeper on its inner side for engaging the magnet, an offset or projection on said platform to rest upon the upper face of said sill, a stop on one of the sides to arrest the revolution of the platform when in operation, and a detachable base having a central opening, into which the sides of the trap project for engagement therewith, said base adapting the structure for support upon and access to a suitable vessel.

No. 38,089. Adding Machine. (Machine pour additionner.)

Joseph Edward Blackshaw, Pittsburgh, Pennsylvania, and George Henry Rogers, Birmingham, Alabama, both in the U.S.A., 9th January, 1892; 5 years.

Claim.—1st. The combination in an adding machine, of a ring graduated upon its outer side with subdivisions and numbers representing hundreds, and upon the inner side with units extending throughout the circumference up to one hundred, a central toothed disk having graduations and teeth corresponding in number and progression to those on the inner side of the ring, means for rotating the disk, an index hand at the outer circumference of the ring and gears for connecting the disk to said index hand, substantially as shown and described. 2nd. The combination in an adding machine, of a ring C, graduated as described, the central toothed disk E, having a cam and actuating lug on its inner side, a spring clutch *i*, pinions *g* and *h*, the gear wheel G, bearing arm G', and index hand *e*, and the friction spring, substantially as shown and described. 3rd. The combination with the toothed disk, and central pin, of the loose collar F', and the adjusting arm F, connected thereto so as to rock as described, and bent up to form a handle, and then outwardly to engage the teeth of the disk, substantially as shown and described. 4th. The combination in an adding machine, of the central disk E, the ring C, graduated as described and provided with a slot in the face, a train of gears connecting the disk with an index hand moving over the ring, a detant arranged in said train of gears, and an arm *m*, connected to the detant and extending through the slot, substantially as shown and described. 5th. The combination of the base plate A, having pivotal pin *a*, the containing case B, the ring C, graduated as described, and provided with radial arms C', and hub C'', the central toothed disk E, and the swinging adjusting arm F, substantially as described.

No. 38,090. Milk Erator. (Garde-lait.)

Lewis Jefferson Macy, Pulaski, New York, U.S.A., 9th January, 1892; 5 years.

Claim.—1st. A cooler and erator for milk cans, consisting essentially of a receptacle provided with a perforated bottom, and having secured to its outer surface a series or set of legs or supports, their lower ends provided with a series of notches of seats adapted to engage and be supported upon milk cans of different diameters or sizes, substantially as specified. 2nd. A cooler and erator for milk cans, consisting essentially of a receptacle provided with a perforated bottom, and having secured to its outer surface a series or set of legs or supports, their lower ends provided with a series of notches or seats adapted to engage milk cans of different sizes, and a second dish or receptacle having a perforated bottom placed beneath the first receptacle, and held in position by supporting notches formed in said legs or supports, substantially as described. 3rd. The cooler and erator for milk cans, having the receptacle provided with a perforated bottom, the legs or supports secured to said receptacle, said legs being formed of parts having different lengths, each series of corresponding parts being adapted to engage milk cans of different diameters, and a second receptacle or pan provided with a perforated bottom placed beneath the first receptacle and engaging supporting notches in the said legs, substantially as described.

No. 38,091. Feather-Duster. (Plumeau.)

Josiah Taylor Hair, Chicago, Illinois, U.S.A., 9th January, 1892; 5 years.

Claim.—1st. The combination in a feather-duster of down or feather cloth, with a handle extending up between the folds of the feather cloth and secured near its upper and lower ends, substantially as shown and described. 2nd. In a feather-duster, the combination of a down or feather cloth, with a handle provided with a frame, substantially as shown and described. 3rd. In a feather-duster, a pocket located between the folds of the down and feather cloth, in combination with a frame, substantially as shown and described. 4th. In a feather-duster, the combination of the down or feather cloth A, the handle G, having hole *d*, the frame F, pocket D and wire H, substantially as described. 5th. In a feather-duster, a pocket located between the folds of the down or feather cloth, substantially as shown. 6th. In a feather-duster, a pocket located between the down or feather cloth, in combination with a frame and handle, substantially as shown and described. 7th. In a feather-duster, the combination of feathers with or without the bones, secured upon fabric by an adhesive substance, with a handle provided with a frame, substantially as shown and described.

No. 38,092. Mainspring Winder.

(*Dévidoir pour grand ressort.*)

Alden R. Vaughan, Pawtucket, Rhode Island, U.S.A., 9th January, 1892; 5 years.

Claim.—1st. A spring winder consisting of two plates of metal, connected together by posts, a ratchet wheel mounted in the centre between the plates, an adjustable winding arbor passing through the ratchet wheel, a two armed pawl and means for operating the same, a clamping device for holding the outer end of the spring and arms for holding the barrel, substantially as set forth. 2nd. In combination with a spring winder means for holding the barrel, consisting of two bent arms S, sleeves P having cams Q at their lower ends, caps R, screw T, collar V and clamping bar U, arranged and operated substantially as shown and described. 3rd. In combination with a spring winder, an adjustable clamp for holding the outer end of the spring, consisting of the sliding block J, clamp K and screw L, substantially as shown and described. 4th. In a spring winder, the combination of the frame A, B, C, ratchet wheel D, and adjustable winding arbor E, handle F and collar G, with the pawl H, pawl lever I and spring *i*, substantially as set forth. 5th. In a spring winder, the combination of the frame A, B, C, ratchet wheel D and adjustable winding arbor E, handle F, collar G, pawl H, pawl lever I and spring *i*, with the adjustable block J, clamp K and screw L, substantially as shown and described. 6th. In a spring winder, the frame A, B, C, bent arms S, sleeves P, cams Q, caps R, screw T, collar V and clamping bar U, in combination with the ratchet wheel D and adjustable winding arbor E, handle F, collar G, pawl H, pawl lever I, spring *i* and adjustable block J, clamp K and screw L, substantially as shown and described.

No. 38,093. Tin Can or Receptacle.

(*Boite en fer blanc.*)

William Pratt, Montreal, Quebec, Canada, 9th January, 1892; 5 years.

Claim.—1st. A tin can or receptacle, the cover of which, after being soldered to the body, is removable therefrom and capable of reuse by the removal, from cover and body of a connecting strip which forms the portion of the body to which said cover is soldered and is an integral part of such body as set forth. 2nd. A tin can or receptacle, the cover of which is formed with a peripheral rim shaped in part to fit within the body and rest upon the edge of same, and the body having an integral detachable connecting strip to which the inserted portion of such cover is soldered, and means for detaching said strip, as set forth. 3rd. A tin can or receptacle, the body of which contains a beading or depression near its upper edge serving to weaken the metal at such point and thereby provide a detachable connecting strip between such body and the cover of the can and to which strip said cover is soldered. 4th. A tin can or receptacle, the cover of which is formed with a peripheral rim shaped in part to fit within the body and rest upon the edge of same, the body having an integral detachable connecting strip to which the inserted portion of such cover is soldered, and said strip having an extended free end to furnish a holdfast for its removal. 5th. A tin can or receptacle, the body of which is weakened upon a line near its upper edge to provide an integral detachable connecting strip between such body and the cover of the can, to which strip said cover is soldered. 6th. A tin can or receptacle, the cover of which is formed with a peripheral rim shaped in part to fit within the body and rest upon the edge of same, and after being soldered to the body is removable therefrom and capable of reuse by the removal, from cover and body, of a detachable connecting strip provided by an outwardly pressed V-shaped beading or depression in such body near its upper edge adapted to be severed at its apex to allow the removal of said strip and present an outwardly flaring edge for the easy reinsertion of said cover, as set forth.

No. 38,094. Barrel Setting-up Machine.

(*Chantier de baril.*)

John Parker, Philadelphia, Pennsylvania, U.S.A., 9th January, 1892; 5 years.

Claim.—1st. The combination in a barrel setting-up machine, of the stave receiving heads, grooved segments thereon, adapted to receive the staves as they are fed into the machine, radial guides for said segments, and mechanism for simultaneously moving said segments towards and from the centre of the heads, substantially as and for the purpose specified. 2nd. The combination, in a barrel setting-up machine, of the hoop driving arms, and a stave receiving head composed of a number of rapidly movable segments, grooved for the reception of the ends of the barrel staves, with a split ring adapted to said grooves, and by which the end thrust of the staves is taken, substantially as specified. 3rd. The combination of the hoop driving arms, and a stave receiving head composed of a number of radially movable segments grooved for the reception of the staves, with a central hub, bars connecting the hub and the said segments, whereby said segments may be moved radially, substantially as specified. 4th. The combination of the stave receiving heads, and hoop driving mechanism, with a transverse shaft, toggle levers connecting the shaft with the stave receiving head, a parol bar secured to said shaft and adapted to be acted upon by the hoop driving head

on its rearward movement, substantially as specified. 5th. The combination of the stave receiving head, and hoop driving head, the transverse shaft in the rear of said stave receiving head and connected thereto and to the hoop driving head, bearing blocks for said shafts longitudinally movable on the frame of the machines with devices for adjusting said bearing block, substantially as specified. 6th. The combination of the stave receiving head with a hoop driving head carrying a number of rigid arms, each of said arms terminating in a driving block and springs carried thereby for folding the hoop in position against said block, substantially as specified. 7th. The combination in a barrel setting-up machine, of the hoop driving head, with a stave receiving head composed of a number of radially movable segments, the centre hub and its shaft, radial arms extending from said hub to the said segments, a rock shaft mounted on the frame and connected to the central hub and carrying a toe, and tapered block on the hoop driving head adapted to act upon said toe, substantially as and for the purpose set forth.

No. 38,095. Package for Shipping and Preserving Butter. Prepared Meats. Fruits. &c.
(*Enveloppe pour transporter et préserver le beurre, les viandes, fruits, &c.*)

Remus A. Kneeland, Benton Harbor, Michigan, U.S.A., 9th January, 1892; 5 years.

Claim.—1st. In a butter package, substantially as described, the combination of a glass jar, a pail designed to receive the said jar, a belt and sling in which the said jar is supported in the said pail, a cover adapted to close air-tight on the said pail, substantially as and for the purpose set forth. 2nd. In a butter package, the combination of a pail having a bead formed near its upper edge, an annular belt of a smaller diameter than the pail, wire legs supporting the said belt, a sling supported on opposite sides of the said belt, a tapering glass jar deeper than the said pail, adapted to be suspended in the said belt, a packing secured on said bead, cover having pins on its opposite sides, pivoted hooks on the pail, adapted to engage the said pins, substantially as and for the purpose set forth. 3rd. In a butter package, the combination with an air-tight casing of a glass jar, suspended in the said casing and an air space, completely surrounding the said jar, substantially as and for the purpose set forth.

No. 38,096. Art or Process of Felting Fur Bodies.

(*Art ou procédé de feutrage.*)

Howard W. Flagg, Yonkers, New York, U.S.A., 9th January, 1892; 5 years.

Claim.—1st. A method of felting fur or similar bodies, which consists in protecting them while being felted, by a suitable elastic material employed in sufficient quantity to form a padding for them and prevent them from being injured or torn, substantially as described. 2nd. A method of felting fur or similar bodies, which consists in protecting them while being felted, by a suitable elastic fibrous material, employed in sufficient quantity to form a padding for them and prevent them from being injured or torn, substantially as described. 3rd. A method of felting fur or similar bodies, which consists in protecting them while being felted, by a suitable fibrous material employed in sufficient quantity to form a padding for them and prevent them from being injured or torn, substantially as described. 4th. A method of felting fur or similar bodies, consisting in protecting them while being felted by wool, employed in sufficient quantity to form a padding and prevent them from being torn or injured, substantially as described. 5th. A method of felting fur or similar bodies, consisting in working them together with other bodies of suitable fibrous material, employed in sufficient quantities to form a padding and to prevent them from being torn or injured, substantially as described. 6th. A method of felting fur or similar bodies, consisting in working them together with other bodies of elastic fibrous material, employed in sufficient quantities to form a padding and prevent them from being torn or injured, substantially as described. 7th. A method of felting fur or similar bodies, consisting in working them together with wool bodies, employed in sufficient quantities to form a padding and prevent them from being torn or injured, substantially as described. 8th. A method of felting fur or similar h.t. bodies, consisting in working them in a fulling mill simultaneously with wool hat-bodies, employed in sufficient quantities to form a padding for the fur hat-bodies and prevent them from being injured or torn by the hammers of the fulling-mill, substantially as described.

No. 38,097. Tobacco Pouch. (*Sac à tabac.*)

William James Cussen, Richmond, Virginia, U.S.A., 9th January, 1892; 5 years.

Claim. 1st. The combination of a pouch, a draw string looped around its mouth and having its ends free, and an extension b^1 , connected to the loop in the draw string at one side of the pouch, substantially as described. 2nd. The combination of a pouch, a draw string looped around the mouth thereof within the hem, and having its ends extending from the hem at suitable points beyond their intersection, and an extra string b^1 , connected to the draw string at a point between its ends substantially as described. 3rd. The combination of a pouch, a draw string passed loosely around and

secured to the mouth of the same, the ends of this string intersecting each other on one side of the pouch and remaining free, and provided with stops on their ends, substantially as described. 4th. The pouch or bag provided with a draw string looped around its mouth, the ends of the string being formed into loops on opposite sides of the mouth, by having their ends turned back and attached to the pouch, whereby a single string may be employed to both open and close the pouch, substantially as described.

No. 38,098. Electrical Door Bell Pull.

(*Poignée de timbre de porte électrique.*)

Lewis W. Cleveland, Portland, Maine, U.S.A., 9th January, 1892; 5 years.

Claim.—1st. In an electrical door bell pull, the combination of the handle and spring about its spindle, whereby it is normally held in place, with a second spring actuated spindle and the insulating material through which said spindle is movable, and the binding posts in said material, whereby when the handle and its spindle are drawn out said second spindle is insulated by its spring action and makes connection between said binding posts, substantially as described. 2nd. In combination with a door escutcheon, and a metal cylinder C, fixed thereto at one end, the handle A and its spindle, and the hard rubber G fixed in the opposite end of the cylinder and projecting beyond said cylinder, and the binding posts and spring actuated and headed spindle E, substantially as and for the purposes set forth. 3rd. In an electric door bell pull, the combination of the spring actuated handle and the insulating material and binding posts therein with the second spring actuated spindle in alignment with the first spindle, movable through said insulating material, and all in the manner and for the purposes described. 4th. In an electrical door bell pull, substantially as described, the combination of the door escutcheon and sleeves or cylinders attached thereto, the hard rubber or insulating material secured in and to the outer end of said sleeve or cylinder, and the binding posts secured to said material, and the headed and spring actuated metal spindle movable within said sleeve or cylinder and also through said insulating material, and the handle and its connections normally holding said headed spindle out of contact with the binding posts, substantially as and for the purposes set forth.

No. 38,099. Combined Spool Holder and Needle Cushion. (*Porte-bobine et coussin à aiguilles combinés.*)

Arthur J. Bowslaugh, Centralia, Ontario, Canada, 9th January, 1892; 5 years.

Claim.—As a new article of manufacture, a combined spool stand or holder and needle cushion, consisting of standard A, formed with the shoulders A^1 , A^2 , in combination with the trays B, B^1 , in each of which sockets b^2 , and recess or receptacles C are formed, the spindles D, the base e^3 , the cover e^2 and the fibrous filling e^1 , substantially as shown and described, and for the purpose specified.

No. 38,100. Chemical Fire Engine.

(*Extincteur d'incendie chimique.*)

Charles Patton, Collingwood, Ontario, Canada, 11th January, 1892; 5 years.

Claim.—1st. The glass lining b , b in combination with a chemical fire engine, substantially as and for the purpose hereinbefore set forth. 2nd. The combination of the handle F, head E, rod d , arms h , h^1 , tube C, C, bars S, S, screens P and V, metal band X, substantially as and for the purpose hereinbefore set forth.

No. 38,101. Metallurgical Process.

(*Procédé métallurgique.*)

Jasper Henry Selwyn, Gloucester Crescent, Hyde Park, County of Middlesex, England, 11th January, 1892; 5 years.

Claim.—1st. For the purpose of recovering metals or metalloids, or both, from their ores or combinations, the use of di-chloride of sulphur in combination with a nitrate or nitrite in a bath of chloride of sodium or other suitable solvent as set forth. 2nd. The use of any of the well known solvents of metal, such as hydro-sulphite of soda, hy-drochloric acid or cupric sulphate in combination with the chloride of sulphur, and the nitrate or nitrite referred to in the preceding claim in a bath as above. 3rd. The manufacture of sulphur from pyritous ores in the manner set forth. 4th. The use for the purposes specified, and in combination with nitrates or nitrites in solution of substances such as $S^2 Cl^2$, which will present nascent chlorine. 5th. The method or process of recovering metals or metalloids, or both, from refractory ores without roasting, as described. 6th. In the treatment of refractory ores by the humid process, completely oxidising and chloridising the otherwise refractory metals and liberating the excess of sulphur, thereby dispensing with preliminary roasting by causing nitric hy-drochloric and sulphuric acids to be evolved in a nascent state as set forth.

No. 38,102. Insecticide. (Insecticide.)

William Lyle Watson, of Montreal, Quebec, Canada, 11th January, 1892; 5 years.

Claim.—1st. As a new article of manufacture, Paris Green or like substance incorporated with a solution of an adhesive substance and formed into shape. 2nd. As a new article of manufacture, cakes or shapes of Paris Green or like substance in powder incorporated with a matrix of an adhesive soluble substance. 3. A soluble and adhesive insecticide consisting of an admixture of Paris Green and gum senegal for application to plants in thin soluble form.

No. 38,103. Washing Machine. (Machine à blanchir.)

Thomas McCrossan, Winnipeg, Manitoba, Canada, 12th January, 1892; 10 years.

Claim.—1st. The herein described system of washing clothes in a tall and narrow wheel turning through hot water contained in a trough or tank at a level, but a little above the lowest part of the said wheel which, revolving through the water by reason of motion imparted to its horizontal shaft, causes the clothes by their gravity and that of the accessory washers folded and enclosed in them, as described, to fall successively from one shelf to the next in the said wheel into the washing water and through it, to be scrubbed and cleaned by the vertical, centrifugal and other imparted motions of said accessory washers acting with the other detergent agencies then at work upon the clothes thus brought into contact with the adjacent interior parts of the periphery of the wheel and its herein described shelves, all substantially as set forth. 2nd. In a washing machine, the combination with the tank D, having the splasher I, and outlet D, the hollow wheel B, horizontally mounted upon the shaft G, and a driving mechanism of the furnace C, having the slide H, the air holes f, door E, and smoke flue F, whereby the wheel B is rotated horizontally through the water in the tank containing the washing water heated and kept hot by means of the said furnace as set forth. 3rd. In a washing machine, the combination with the clothes receiving wheel B, having the cleats or slats b, to form its periphery and the cleats or slats c to form its shelves, of the frame A, the tank or trough D, and the furnace C, all substantially as set forth.

No. 38,104. Tool Holder. (Porte-outil.)

Anson Groves Roman, Toronto, Ontario, Canada, 12th January, 1892; 5 years.

Claim.—1st. A tool post or tool holder having a joint therein as a means whereby the upper portion may be inclined at various angles of inclination to the lower portion, substantially as shown and described. 2nd. In a tool post or tool holder, the bed ring encircling the post and having its lower plane oblique to the circumference and its upper plane marginal around an inner circular curved surface forming a bearing to support the bolster ring thereon, said upper plane being at right angles to said circumference, substantially as shown and described. 3rd. In a tool post or tool holder, the bolster ring encircling the post and supported on the bed ring, and having an inner circular curved surface to fit an adapted curved surface on said bed ring, substantially as shown and described. 4th. In combination, the tool post having a joint therein, as a means whereby it can be inclined, with a bed ring encircling said post and having its lower plane oblique to the circumference, its upper plane marginal around an inner circular curved surface, forming a bearing to support the bolster ring thereon, said upper plane being at right angles to said circumference, substantially as shown and described. 5th. In combination, the tool post having a joint therein as a means whereby it can be inclined, a bed ring encircling said tool post and having the form hereinbefore specified, and a bolster ring encircling said post, and having an inner circular curved surface to fit an adapted curved surface on said bed ring, substantially as shown and described. 6th. In combination, the tool post or tool holder having a joint therein for the purpose specified, a bed ring encircling said post and having the form hereinbefore set forth, a bolster ring also encircling said post and having the tool channel formed in the top thereof, and the caulks formed on the lower side of the bolster ring, substantially as shown and described.

No. 38,105. Lasting Machine.

(Machine à enformer.)

Charles S. Gooding, Brookline, and Sherman W. Ladd, Somerville, both of Massachusetts, U.S.A., 12th January, 1892; 5 years.

Claim.—1st. In a lasting machine, the combination with a lever, composed of two pivoted members, each member adapted to engage with the other member, intermediate the pivotal point, and the outer end of said other member, of a pincers mechanism, secured to the outer end of one of the members and an operating device secured to the outer end of the other member, substantially as described. 2nd. In a lasting machine, the combination with a lever composed of two pivoted members, each member adapted to engage with the other member, intermediate the pivotal point and the outer end of

said other member, of a spring interposed between the contact point of one of the members with the other member, a pincers mechanism secured to the outer end of one of said members and an operating device secured to the outer end of the other member, substantially as described. 3rd. In a lasting machine, a pivoted lever, as 26, means for lifting and depressing the same, a lever 13, arranged to have positive engagement with the lever 26, during the uplifting movement thereof, a pincers mechanism jointed to and supported by the lever 18, and a yielding device interposed between the levers against which the lever 18, and pincers mechanism are lifted, substantially as described. 4th. The combination in the pincers of a lasting machine and with the fixed jaw thereof, of a movable jaw and spring actuated levers mounted on the fixed jaw and engaging with the movable jaw, the whole arranged as described, so that the power of the levers decreases as the movable jaw moves from and increases as it moves towards the fixed jaw, substantially as described. 5th. The combination in the pincers of a lasting machine and with the fixed jaw thereof, of a movable jaw and spring actuated levers engaging therewith, said levers being substantially at right angles to the line of movement when the pincers are closed, substantially as described. 6th. In a lasting machine, the combination of a pincers mechanism and a pivotally connected supporting carrier therefor, a rod 51 supported movably in the carrier, and springs 53, 53, interposed between the rod and carrier, and means for moving the rod, substantially as described. 7th. In a lasting machine and in combination, the carrier 30, a pincers mechanism supported thereby, a rod 32, connected with and supporting the carrier, and means for giving thereto a rocking movement, substantially as described. 8th. In a lasting machine and in combination, the rod 32, a pincers mechanism pivotally supported thereon, a cam for advancing the rod in one direction and a spring for moving the rod in the opposite direction, substantially as described. 9th. In a lasting machine and in combination, the driver 57, means for giving said driver a rocking movement, a pin supported movably in the driver and a connecting rod, attached to said pin and communicating with a pivotally supported pincers mechanism, substantially as described. 10th. In a lasting machine and in combination, the driver 57, having groove 62, as slide, as 63, movable in said groove, a rod pivotally connected with the slide at one end and with a pivotally supported pincers mechanism at its opposite end and means for giving the driver a rocking movement, substantially as described. 11th. The combination with the suspended shank carrying pincers at the lower end, of a rod connected therewith below the upper end, a driver vibrating on a fulcrum between its ends and a slide connected with said rod and movable on the driver across the fulcrum thereof, substantially as set forth. 12th. In a lasting machine and in combination with the driver 57, means for giving said driver a rocking movement, a pin supported to slide across the fulcrum of the driver, a treadle device connected with the pin and a rod connected with said pin at one end and at the other end with a pincers mechanism pivoted at the upper end, substantially as described. 13th. In a lasting machine and in combination, the driver 57, mounted on the sleeve 56, as shown, means for rocking the sleeve, a groove 62 in the driver, and a slide 63 arranged to travel therein, a shaft located in the sleeve 56, and connected by a suitable gear mechanism with the slide 63, and the described treadle and intermediate connecting mechanisms for giving a rocking movement to the shaft, substantially as described. 14th. In combination in a lasting machine with a movable rod, as 13, the springs 53, 53, means for moving the rod against the tension of said springs and means for supporting the rod and springs, substantially as described. 15th. In a lasting machine, the combination with a stationary tack receptacle, of a carriage movable laterally relatively thereto and having a driving mechanism, secured to and moving with the carriage above the tack receptacle, and a tack carrier block secured to and moving with the carriage below the tack receptacle, substantially as described. 16th. In combination in a lasting machine, a receptacle for tacks, singly, a sliding block or carriage N, a hammer mechanism supported in said block, a tack carrier S, secured to and movable with the block below said receptacle, and means for advancing and withdrawing the block, substantially as described. 17th. In a lasting machine, the combination with a stationary tack receptacle, of a carriage movable laterally relatively thereto and a hammer or driving mechanism attached to the carriage, the lower portion of which is movable relatively to the operating line of movement of the upper portion. 18th. In a lasting machine, the combination with the tack receptacle of a reciprocating, jointed hammer, the lower portion of which is adapted to swing out of the line of vertical movement, and means for operating it, substantially as described. 19th. In a lasting machine, the tack carrier block S, having a tack receiving tube 83, the pivotally connected parts f, f, and spring devices 95, 95, substantially as described. 20th. The combination of the tack chute, a shaft, a tripper arm and a spring engaging with the shaft and with the tripper arm, substantially as described. 21st. The combination of the tack chute, a shaft and an adjustable tripper arm arranged to swing over and above the chute, substantially as described. 22nd. The combination of the tack chute, a rock-shaft having a positive motion in one direction and a yielding motion in the opposite direction, and a tripper arm operated thereby above and along the chute, substantially as described. 23rd. The combination of the tack chute, a spring actuated shaft, a tripper arm and mechanism for rocking the shaft positively in one direction, substantially as described.

No. 38,106. Manufacture of Tinware Vessels for Holding Liquids. (*Fabrication de vaisseaux en fer blanc pour contenir les liquides.*)

Winfield Scott Wait, assignee of Irving Dudley King, both of Orleans, New York, U.S.A., 13th January, 1892; 5 years.

Claim.—1st. The combination in each tin vessel or utensil of a groove C formed in the bottom thereof by indentation thereon, without injury to the surface, and a piece of zinc B corresponding in size with the dent or groove C formed in the tin bottom A having its surrounding edges dished down and soldered all around in said grooves, all operating substantially as and for the purposes herein set forth.

No. 38,107. Fire Extinguishing Compound.

(*Composé pour extincteur d'incendie.*)

George Frederick Dawson and Hermann Newman, both of Bradford, England, assignees of Max Eberhardt, Lucerne, Republic of Switzerland, 13th January, 1892; 5 years.

Claim.—1st. A compound for extinguishing fires composed of chloride of soda, burnt alum, bi-carbonate of soda, liquid silicate of soda and water, substantially as described. 2nd. A compound for extinguishing fires composed of three kilogramme of soda, one-half a kilogramme of burnt alum, one-half a kilogramme of bi-carbonate of soda, five and a half kilogrammes of liquid silicate of soda and two hundred litres of water, substantially as described.

No. 38,108. Fence Post. (*Pieux de clôture.*)

Peter W. Weienette, Saline, Michigan, U.S.A., 14th January, 1892; 5 years.

Claim.—1st. In a fence, the combination, with the end posts and wires connecting the same, of an intermediate post consisting of a socketed base having tapering wings extending below the socket and inclined teeth formed on the upper edge of the socket, a standard having its lower end encased in the socket and movably secured therein, lateral pins on opposite sides of the standard engaging the teeth of the socket, and means for rotating the standard in the socket, substantially as described. 2nd. In a fence, a tightening post consist of a base formed with a socket in its upper end, teeth on the upper edge of said socket, having inclined upper faces and vertical side edges, a rotary standard having its lower end in cases in the socket and having a series of horizontal apertures through its upper portion, and lateral pins on opposite sides of the standard engaging the teeth of the socket, substantially as described.

No. 38,109. Car Coupler. (*Attelage de chars.*)

James A. Hinson, Des Moines, Iowa, U.S.A., 14th January, 1892; 5 years.

Claim.—1st. The combination in an automatic car coupler, with the draw head B, having a hollow buffer *a*, formed with an opening *b*, in its top, and a swinging knuckle D, of a pivoted latch G, having a horizontal slot *g*, at one end, and a longitudinal slot *h*, in its body, substantially as described. 2nd. The combination in an automatic car coupler, with a draw head B, having a hollow buffer *a*, formed with an opening *b*, in its top, and a swinging knuckle, of a latch G, having a horizontal slot *g*, at one end and a longitudinal slot *h*, in its body, and a trigger H, for supporting said latch in said buffer, substantially as described. 3rd. The combination, in an automatic car coupler, with a draw head B, having a hollow buffer *a*, formed with an opening *b*, in its top, of a latch G, having a horizontal slot *g*, at one end, a longitudinal slot *h*, in its body, and a shoulder *m*, on one side thereof, and a pivoted trigger H, having a lateral projection I, adapted to engage said shoulder and support said latch, substantially as described. 4th. The combination in an automatic car coupler, with a draw head B, having a shoulder *f*, projecting from its interior wall at one side and curved shoulders *c*, formed on its upper and lower sides at the end, of a knuckle D, having a tail-piece F, formed with a shoulder *e*, adapted to engage the first named shoulder, and rounded shoulders *d*, adapted to engage said curved shoulders, substantially as described. 5th. The combination, in an automatic car coupler, with a draw head B, having a hollow buffer *a*, formed with an opening *b*, in its top, of a latch G, having an elongated horizontal slot *g*, at one end, and a horizontal slot *h*, in its body, a lever M, having an arm *u*, formed with a slot *v*, at its end, and a chain *l*, connecting said latch and arm, substantially as described. 6th. The combination in an automatic car coupler, with a draw head B, having an opening *b*, in its top, of a latch G, having an elongated horizontal slot *g*, at its top, a longitudinal slot *h*, in its body, an inclined shoulder *v*, at its front edge, a vertical shoulder *n*, and a horizontal shoulder *m*, and a trigger H, having a projection I, adapted to support said latch, substantially as described.

No. 38,110. Tractor for Obstetric Forceps.

(*Instrument de traction pour forceps obstétriques.*)

Albert B. Lyman, Baltimore, Maryland, U.S.A., 14th January, 1892; 5 years.

Claim.—1st. In combination with a pair of obstetric forceps, a tractor which consists of a hooked shank adapted for connection with the lock of the forceps, having a threaded stem which is at

practically a right angle with the shank, a nut on the threaded stem, and a handle attached to the said stem, substantially as and for the purpose specified. 2nd. A tractor for a pair of obstetric forceps, which consists of a hooked shank with a stem projecting from it at practically a right angle, and a handle on the said stem, substantially as and for the purpose specified. 4th. A tractor for a pair of obstetric forceps, which consists of a hooked shank having a jointed threaded stem projecting therefrom with a nut thereon, and an adjustable handle dependent from said nut, substantially as and for the purpose specified. 5th. A tractor for a pair of obstetric forceps, which consists of a hooked shank with a stem projecting at practically a right angle therefrom, and a handle connected to the said stem, and lugs on the said shank, which, as the tractor is drawn down, bear against the handles of the forceps and communicate the inward movement of the tractor to the handles of the forceps, substantially as and for the purpose specified.

No. 38,111. Means for Preventing Fraud in the sale of Cigars. (*Moyen d'empêcher la fraude dans la vente des cigares.*)

Sebastien Azcano-Y-Meana, of Havana, Cuba, 14th January, 1892; 5 years.

Claim.—1st. The improved means for preventing fraud in the sale of cigars which consists in placing beneath the outer wrapper of cigars, countersigns of a distinct colour from the wrapper thereof, and arranging for such countersigns to appear at a point or points upon the surface of the same. 2nd. The improved means for preventing fraud in the sale of cigars which consists in a perforation in the outer wrapper thereof, and a countersign of a distinct colour from such wrapper arranged between same and the body of the cigar, and appearing through such perforation in the surface of the same. 3rd. The improved means for preventing fraud in the sale of cigars which consists in a coloured depression in the surface of the same.

No. 38,112. Device for Inducing Full Respiration.

(*Appareil pour aider la respiration.*)

Charles Cassat Davis, Los Angeles, California, U. S. A., 14th January, 1892; 5 years.

Claim.—1st. A device for using full respiration, comprising the combination of a chest compressor brace, and speed-regulated take-up mechanism adapted to contract such brace. 2nd. The combination of a case, the take-up mechanism in such case, and a chest compressor brace secured by one end to the case, and by the other end to the take up mechanism. 3rd. The combination of a case, a spring, a spring actuated barrel, a train of wheels and escapement pallet in said case, and a compressor brace attached by one end to the case, and attached by the other end to the spring actuated barrel reverse to the spring. 4th. The combination of a case, a spring actuated barrel, a spring, a spur wheel fixed upon such barrel, escapement mechanism, and ratchet mechanism connecting the spur wheel with the escapement mechanism. 5th. The combination of the spur wheel of the take-up barrel, a slip pinion meshing therewith and provided on its lower end with ratchet teeth, a spur wheel coaxial with the slip pinion, and having a notched face arranged to engage such ratchet teeth, a spring arranged to hold the slip pinion in operative contact with its spur wheel, and escapement mechanism engaging with said spur wheel.

No. 38,113. Road Cart. (*Désobligeante.*)

James Woods, Strathroy, Ontario, Canada, 14th January, 1892; 5 years.

Claim.—1st. A draw brace, H, in combination with a shaft, F, pivoted thereon, at a point between its ends, which are perfectly free, and an axle, A, or other suitable support to which the draw brace, H, is secured, substantially as shown and described and for the purpose specified. 2nd. The draw brace, H, secured to the axle, A, or other suitable support, and the shaft, F, pivoted thereon, at a point between its ends, in combination with the spring, D, secured to the shaft, F, at one end, and pivotally secured to the jack, B, or other suitable support, substantially as shown and described, and for the purpose specified. 3rd. The straps, J, and K, and clevis or link couplings, L, L, and in combination therewith, the spring bar, E, and body, I, substantially as shown and described and for the purpose specified.

No. 38,114. Chair. (*Chaise.*)

Henry Augustus Gage, Manchester, and Harrison Eaton Herrick, Merrimac, all in New Hampshire, U.S.A., 14th January, 1892; 5 years.

Claim. 1st. In a chair, the combination of the seat having sockets, the rocker shaft, the hinge rods pivoted to said shaft, the rockers E, and the rods pivoted to the ends of the rockers and having their forward ends entering the sockets, together with the springs coiled around said rods, substantially as described. 2nd. The combination of the seat having sockets near the front edge, the rockers, the rocker shaft, the hinge rods pivoted to said shaft and having flat bearing faces adapted to rest on similar flat faces on the rocker arms, the rods pivoted to the rear ends of the rockers and having their forward ends entering loosely the sockets, and the spring

coiled around the rods, all operating substantially as described. 3rd. The combination with the chair seat A and screw D, of shaft C, having rockers E, F, with seats *e*, the rods F, secured to the under side of seat pivoted to shaft C, and having seats *f*, the sockets H, and the pivoted rods G, with springs *g*, substantially as described.

No. 38,115. Sleigh Runner for Vehicles.

(*Patin de traîneau pour voitures à roues.*)

John Blankart, Detroit, Michigan, U.S.A., 14th January, 1892; 5 years.

Claim.—1st. In a sleigh runner adapted to be attached beneath the wheels of a vehicle, the combination with a runner having an upwardly projecting forward end, of a clamp screw therein, a U-shaped hook adapted to bear against the inner rim of the wheel, and with its hooked end to engage over a pin K, substantially as described. 2nd. In a sleigh runner adapted to be attached to vehicles, the combination, with the runner having an upwardly projecting part B, of a clamp screw J, the U-shaped hook L, the bearing M, a series of hooks or notches O, and the pin K, substantially as described. 3rd. In a sleigh runner adapted to be attached to vehicles, the combination with the runner having an upwardly projecting part B, of a clamp-screw J, the U-shaped hook L, the bearing M, a series of hooks or notches O, the pin K, a loop P in the clamp screw, and the strap adapted to be connected to the shafts and the wheel, the parts being arranged to operate substantially as described. 4th. The combination, with a sleigh runner adapted to be attached to four-wheeled vehicles, of a running connection between the two parts thereof consisting of a flexible strap secured to the front wheels and passing over a roller connected to the rear wheels, substantially as and for the purpose described. 5th. A sleigh runner having a clamp adapted to secure it to a wheel of a vehicle, and a connection between the runner and the vehicle frame, substantially as described.

No. 38,116. Railway Surface Cattle Guard.

(*Garde bétail de chemin de fer.*)

Parker Merrill, St. Louis, Michigan, U.S.A., 14th January, 1892; 5 years.

Claim.—1st. A railway surface cattle guard composed of a series of bars arranged substantially parallel with the rails, each bar arched or raised between its ends, substantially as and for the purpose specified. 2nd. A railway surface cattle guard composed of a series of bars arranged substantially parallel with the rails, each bar arched or raised between its ends, in combination with one or more transverse beams designed to support the arched or raised portion of the bars, substantially as and for the purpose specified. 3rd. A railway surface cattle guard comprising sections between and outside the rails of the track, said sections being composed of transverse beams that have their tops oval or round, and separated longitudinal bars strained across said beams, with a space between the upper surface of the ties and said bars, substantially as set forth. 4th. A railway surface cattle guard comprising one or more transverse beams secured to the ties, and a series of longitudinal bars provided with hooks at each end strained across said beams, and cross-bars passing beneath the rails and through the hooks at one end of the longitudinal bars, and a series of short hooks into hooks of longitudinal bars at opposite end from said cross-bars, and a series of short hooks on said cross bars, the said series of short hooks being spiked to the outer faces of the ties supporting the terminal beams, substantially as set forth.

No. 38,117. Method of Laying Electrical Conduits.

(*Méthode de poser les conduits électriques.*)

John Joseph Wright, Toronto, Ontario, Canada, 16th January, 1892; 5 years.

Claim.—1st. As an improved method of laying electrical conduits, the placing of junction boxes between each length of pipe substantially in alignment with the pipe, and so placed as to depth below the pavement that the top of the junction box is located in the asphalt layer, as specified. 2nd. The junction box D, threaded as shown, to receive pipes E and nipple G, and having a lid J, having a projection *k*, extending to the top surface of the pavement, as and for the purpose specified. 3rd. The junction box D, provided with a lid J, having a tongue *j*, fitting into a groove *i*, formed around the opening I of the junction box, as specified. 4th. The junction box D, provided with a lid J, having a tongue *j*, fitting into a groove *i*, formed around the opening I, of the junction box, in combination with the projection *k*, arranged as and for the purpose specified. 5th. The junction box D, provided with interior raised rounded ends formed in proximity to the internal thread made to receive the pipes as specified.

No. 38,118. Cover for Fruit Baskets.

(*Couvert de panier à fruits.*)

George H. Williams, Thorold, Ontario, Canada, 16th January, 1892; 5 years.

Claim.—The grooved end and centre cross pieces B of the frame into which the sides A are inserted, thus forming a strong and secure frame.

No. 38,119. Machine for Swaging the Ends of Metal Tubes. (*Machine à étamper les bouts des tubes métalliques.*)

John Patterson Kennedy, New York, N. Y., U.S.A., 16th January, 1892; 5 years.

Claim.—1st. In a machine for swaging the ends of metal tubes, the feed mechanism composed of a fixed cross-bar having a screw threaded bushing, a feed screw working through such bushing, and carrying at its inner end a clutch plug adapted for receiving and holding one end of the tube to be swaged, and a handle secured to the feed screw for operating it, as described. 2nd. In a machine for swaging the ends of metal tubes, the feed screw having a tapered shank, in combination with a reciprocating expansible clutch plug, composed of two or more sections, adapted to hold a tube when forced back and expanded on the tapered shank, and to release such tube when forced forward and collapsed. 3rd. In a machine for swaging the ends of metal tubes, the feed screw having a tapered shank, shoulder *j*, and an elongated bolt end, in combination with a reciprocating expansible clutch plug, composed of two or more sections, and having at its rear end a flange *k*¹, operating, substantially as and for the purpose described. 4th. In combination with the feeding mechanism of a machine for swaging the ends of tubes, the extended side bars, means for adjusting them out or in for different length tubes to be swaged, and connections to the cross-bar, which supports the feed screw, substantially as described. 5th. In combination with the feed mechanism of a machine for swaging the ends of tubes, the side bars and the detachable extension pieces connecting them with the cross-bar, which supports the feed screw, substantially as described. 6th. In combination with the feeding mechanism of a machine for swaging the ends of tubes, the side bars C, having shoulders *c*, projecting screw threaded ends *b*, and the detachable extension pieces C¹, having screw threaded sockets *c*, and screw-threaded ends for connection with the cross-bar F, carrying the feed screw H, substantially as described. 7th. In combination with the feeding mechanism of a machine for swaging the ends of tubes, the side bars C, having shoulders *c*, and projecting screw threaded ends *b*, for connection with the cross-bar F, carrying the feed screw H, the braces D, and the tube rest E, as and for the purpose described.

No. 38,120. Power machine for swaging the ends of metal Tubes. (*Appareil pour étamper les bouts des barres métalliques.*)

John Patterson Kennedy, New York, N. Y., U. S. A., 16th January, 1892; 5 years.

Claim. 1st. In a machine for swaging the ends of metal tubes, the feed screw provided with a clutch plug and mounted in the screw threaded opening in a fixed standard or bridge in combination with a spur wheel connected by a key or feather with the feed screw, a pinion meshing with such wheel and a belt pulley secured to the shaft of the pinion as and for the purpose described. 2nd. In a machine for swaging the ends of metal tubes an adjustable head or carriage, provided with means for supporting the feeding mechanism, in combination with the feed screw and a clutch plug and operating gearing, substantially as described. 3rd. In a machine for swaging the ends of metal tubes the extended bed plate having lateral guide ways, in combination with an adjustable carriage or head, supporting the tube feeding mechanism and having flanges fitted to the guide ways, and bolts for securing said carriage in any desired position to the bed plate as described. 4th. In a machine for swaging the ends of metal tubes the extended base or bed plate having a longitudinal slot with guide-ways, in combination with an adjustable head or carriage supporting the feeding mechanism and power gearing, and headed bolts passing through the bottom plate of said carriage, and through the slot in the bed plate for securing said carriage in any desired position. 5th. In a machine for swaging the ends of metal tubes the combination of the feed screw working through a screw threaded opening in a fixed support and having a tapered end of square or other angular cross section, in combination with a clutch plug of tapered or conoidal form externally and having a socket adapted to loosely fit on the tapered end of the feed screw as and for the purpose described. 6th. In a machine for swaging the ends of metal tubes the feed screw working through a screw threaded opening in a fixed support and having secured to its inner end a tapered or conoidal plug in combination with a reciprocating collar loosely connected to the feed screw and having an enlarged portion overlapping the rear end of the plug, and adapted to automatically release the tube from the plug as described. 7th. In combination with the feed screw having a longitudinal slot near its inner end, and carrying a tapered or conoidal plug adapted to receive and hold a tube to be swaged, the reciprocating collar having an enlarged portion overlapping the plug and loosely connected to the shank of the feed screw by a bolt passing through the slot for automatically releasing the tube from the plug as described.

No. 38,121. Weather Strip for Doors.

(*Bourrelet pour le bas des portes.*)

William Beers, Toronto, Ontario, Canada, 16th January, 1892; 5 years.

Claim.—1st. As an improved weather strip for the bottom of doors, a strip of rubber or other flexible material fixed to a rail flex-

ibly connected to the bottom of the door and actuated by a spring in such a manner that the end of the rail shall project beyond the door, substantially as and for the purpose specified. 2nd. A flexible weather strip A, connected to a rail B, fitted into a recess formed in the piece C, so that its end shall project slightly beyond the end of the said piece in combination with the links D, and spring E arranged to connect the said rail to the said piece, which latter is secured to the bottom of the door, substantially as and for the purpose specified.

No. 38,122. Electric Show Case Alarm.

(*Montre d'étalage à avertisseur électrique.*)

Rudolph Charles Krusche, Duluth, Minnesota, U.S.A., 16th January, 1892; 5 years.

Claim.—1st. The combination with a show case tray, of two similar spring clips oppositely arranged with respect to each other, and supports adapted to hold articles for display and constructed to form an electrical contact with each other when the articles are removed from the clips, substantially as specified. 2nd. The combination with a show case of an electric alarm, a battery, and a removable tray provided with circuit closing devices adapted to be operated automatically when articles are removed from the tray, and electrical connections with the tray whereby the alarm is given when the tray is replaced in the show case, substantially as specified. 3rd. The combination, with the show case A and tray E, of the alarm bell B, the metallic strips *a, b*, the battery C, the clips F, contained by the tray and adapted to hold articles for display, and the wires connecting the strips *a, b* with the battery C, substantially as specified.

No. 38,123. Complete Combustion Mechanism.

(*Mécanisme complet pour combustible.*)

Thomas Brown, Des Moines, Iowa, U.S.A., 16th January, 1892; 5 years.

Claim.—1st. In a stove or furnace, a conoidal grate having an opening at its apex, a conductor or boxing having at its lower end an opening to admit the fuel, its upper end terminating at the apex opening of the grate, an annular ring at said apex opening, and an extension or extensions on the upper end of said conductor, whereby the grate is rotally and detachably mounted upon said conductor, together with a screw conveyor operated within said conductor, as set forth. 2nd. In a stove or furnace, the combination of a rotatably mounted conoidal grate pivotally mounted upon the upper end of the fuel conductor, an opening at its apex through which the fuel is fed upon the said grate, the grate bars of which latter radiate and incline outwardly and downwardly from said opening, and a stationary dead plate located at and disposed about the lower portion of the grate bars, said dead plate having a circular opening and serrations forming teeth, said teeth being in juxtaposition to the ends of the grate bars, together with means for rotating the grate, as set forth. 3rd. In a stove or furnace, the combination of a conductor having an opening at its lower portion for the admission of the fuel, a screw conveyor within said conductor rotated by suitable driving mechanism, a conical grate rotally mounted upon the upper open end of the conductor, said open end coinciding with an opening in the apex of the said grate, through which the fuel is fed, the bars of the grate radiating and inclining downwardly from said opening in the grate, and a fixed dead plate having an opening provided with teeth disposed about the lower portion or at the ends of the grate bars, so that said teeth act conjunctively with the ends of said grate bars, together with means for rotating the grate, as set forth.

No. 38,124. Propeller for Ships.

(*Appareil de propulsion pour voissence.*)

William Henry Wigmore, Philadelphia, Pennsylvania, U.S.A., 16th January, 1892; 5 years.

Claim.—1st. A ship's hull having a cylindrical shaped wheel case B, a propeller or paddle-wheel C, and a mouth or entrance of the casing of a diameter approximately that of the wheel C, and an interior larger diameter to give clearance or space between the casing wall and wheel blades, substantially as hereinbefore set forth and described. 2nd. A ship's hull having an air tight cylindrical casing, the mouth and interior diameter of which are of different concentric diameters, substantially as hereinbefore set forth and described. 3rd. In a ship's hull, an air tight wheel casing B, having a mouth *b*, of one diameter, abutments *b¹, b²*, at each end of the said mouth, and an interior diameter larger than that of its mouth, substantially as hereinbefore set forth and described. 4th. In a ship's hull, an air tight wheel casing B, having mouth *b*, and abutments *b¹, b²*, at the ends of said mouth, substantially as hereinbefore set forth and described. 5th. In a vessel, an air tight wheel case B, having a mouth *b*, in combination with a paddle-wheel C, and abutments *b¹, b²*, at each end of the mouth *b*, substantially as hereinbefore set forth and described.

No. 38,125. Gate. (Barrière.)

George M. Shoebottom, Parkhill, Ontario, Canada, 16th January, 1892; 5 years.

Claim.—1st. The gate stanchion constructed of three pieces of suitable length, breadth and thickness, held together by bolts of sufficient length to allow open spaces or divisions of similar width on either side of the middle stanchion piece, substantially as above described. 2nd. The alternate arrangement of the section bars in the open spaces in the gate stanchion as above described, permitting a complete folding of the gate section.

No. 38,126. Water Heater. (Calorifère à eau.)

John Duncan Mouat, Detroit Michigan, U.S.A., 16th January, 1892; 5 years.

Claim.—1st. A steam or water heater, the same consisting of the combination, with an open manifold at the base and a chamber extending across the top, of interposed circulating pipes C, extending from the base of the manifold to the top about the combustion chamber, a series of manifolds D, extending from front to rear, arranged across the furnace above the grate, and a series of circulating pipes C¹, extending in a continuous unbroken series from front to rear, and connecting each said manifold with the chamber A¹, at the top of the furnace, substantially as and for the purposes described. 2nd. The combination, with a manifold extending around the base of the furnace, and having an open space within its confines for the grate, of a chamber extending over the entire top of the furnace, circulating pipes C, uniting the manifold with the said chamber, a series of manifolds D, arranged parallel with each other from front to rear of the furnace, and each provided with a series of circulating pipes C¹, extending in a continuous unbroken series from front to rear, and connecting it with the said chamber, and out-flow conduits leading into the manifold at the base, all substantially as and for the purposes described. 3rd. The combination, with the manifold A, and chamber A¹, of the circulating pipes C, C¹, the latter extending in a continuous unbroken series across the furnace from front to rear, and manifolds D, each of said manifolds provided at its rear end with a circulating pipe D¹, substantially as and for the purposes described.

No. 38,127. Pipe Joint. (Joint de tuyau.)

George Alvin Bidwell, Pittsfield, Massachusetts, U.S.A., 16th January, 1892; 5 years.

Claim.—In combination, the pipe sections, each integrally formed with inclined thin circular flanges, said flanges having holes near their edges adapted to register for the reception of the retaining bolts, the leaden washer 4, of a greater diameter than said flanges, adapted to be compressed between said flanges and reaching under the contiguous shingles, slats, or other roofing, and the retaining bolts having the nuts on their threaded ends passing through said flanges and the leaden washer between the same, as set forth.

No. 38,128. Saw-Mill. (Scierie.)

Francois Exavier Nadon, River Desert, Quebec, Canada, 16th January, 1892; 5 years.

Claim.—1st. In a saw-mill, the combination with a vertical saw, in a suitable frame, of the balanced beam P, the slot *p* in one end of said beam, suitably lined with metal plates, the pitman P² connecting the other end of the said beam with the said vertical saw, a driven shaft M carrying the wheel N carrying the sliding block *n*, the said block being adapted to slide in the slot *p* and reciprocate the beam P, as the said wheel revolves, substantially as set forth. 2nd. In a saw-mill, the combination with a vertical saw frame, of the beam P, means for reciprocating the said beam, the vertical arm Q, brace rods *q*, the arm 17 carrying the horizontal saw 16, the guide block 14 sliding in the slotted vertical standard 12, the guide arm 15 carried by said standard, the rack 11 held by the distance piece 10 to the said vertical saw frame, substantially as set forth. 3rd. In a saw-mill, the combination with a beam pivoted in the main frame suitably reciprocated, a pitman for imparting vertical motion to the vertical saw, of a braced arm secured at right angles to the said beam for imparting motion to a horizontal saw, substantially as set forth.

No. 38,129. Knotter for Harvester Binders.

(*Machine à nouer pour moissonneuses-lieuses.*)

The Noxon Bros. Manufacturing Co., Ingersoll, Ontario, Canada, assignees of John F. Seiberling, Akron, Ohio, U. S. A., 16th January, 1892; 5 years.

Claim.—1st. In a grain binder, the knotter shaft made in one piece, in combination with a laterally swinging sleeve like frame D, pivoted on the knotter frame above the knotter actuating shaft, the knotter pinion and gear wheel A, provided with a segmental gear and cam groove on its inner face for swinging said sleeve like frame substantially as described. 2nd. The combination of the cam wheel A¹ and its shaft A, mounted in the frame B, and the knotter supporting sleeve like frame D, with its rocking arm and

cam roller c^2 , pivoted above the knotter shaft on the knotter frame said cam wheel being provided with a segmental gear and cam for imparting to said knotter its rotary and vibratory or swinging movement, substantially as described. 3rd. The combination with the knotter shaft F, its pinion f , and delay shoe f^1 , mounted on the swinging sleeve like frame D, which is pivoted on the knotter frame, above the knotter operating shaft A, the segmental gear a^2 , for revolving the knotter shaft pinion f , the cam track and for swinging the sleeve like frame, the side retaining flange a^3 , and the depression of its face at the end of the segment on the knotter operating wheel, to admit of the swinging of the knotter pinion as the frame D, rocks on its pivot as described. 4th. In a grain binder, the knotter shaft F, its supporting sleeve like frame D, and its projecting arm D, adjustably secured to its rocking arm B, for adjusting the angle of the knotter shaft, its cam roller c , and means for rocking arm E, as and for the purpose set forth. 5th. The combination of the knotter mounted in a sleeve like rocking frame, its pinion and delay shoe, the retaining flange a^3 , the rotating cord-holder wheel, its pinion h , and delay surfaces h^1 , with the cam wheel A¹, and its segmental gear a^1 , inclined retaining flange a , and cam groove or track a^2 , operating as and for the purposes described. 6th. The notched annular flanged or crown disk cord-holder h , the peripheral rib h^1 , on the outer edge thereof, in combination with the cord-holder shoe, provided with a corresponding groove to receive said rib, said cord-holder wheel and its pinion mounted on a stud secured to the breast plate and revolving in a plane oblique to the main cam and gear wheel, to receive the cord from the binder arm and deliver it to the knotter, substantially as shown and described. 7th. The peripheral rib h^1 , on the notched cord-holder and crown disk h^2 , in combination with the cord-holder shoe, provided with a corresponding groove to receive said rib, and the cord guide fingers i^3 and i^4 , on the inner side of said shoe, as, and for the purposes stated. 8th. The combination with the knotter actuating cam or gear wheel A¹, of the cord-holder wheel and its pinion set to revolve in a plane oblique to the plane of the knotter actuating wheel to receive the cord from the binder arm, and the shoe extension i^2 , on the outer end of the cord-holder shoe, to guide the cord and prevent its catching on the rim and dropping in the notch of the cord-holder nearest the knotter, as the cord-holder intermittently rotates, substantially as described. 9th. The cord-holder wheel and the grooved cord-holder shoe I, provided on the end next the knotter, with the projecting horn or extension finger i^2 , in combination with the pivoted knotter frame and the knife rigidly secured to and swinging with said frame, substantially as described. 10th. The annular rib h^1 , on the cord-holder crown disk, in combination with the longitudinally grooved shoe I, to prevent lateral displacement of the shoe by the strain of the cord substantially as shown and described. 11th. The rotary cord-holder wheel, its toothed pinion and delay cam all cast in one piece and mounted upon a stud secured to a stationary lug located directly upon the breast plate, in combination with the cam wheel having a segmental rack and retaining flange arranged to turn and hold the cord-holder wheel intermittently substantially as described. 12th. In combination with the cam wheel A¹, having the inclined retaining rim a , of the segmental gear a^1 , and the inclined and obliquely arranged rotary cord-holder wheel h , arranged on the face side of said cam wheel, substantially as described. 13th. The combination of the knotter and the cord-holder with the breast plate C, and the curved rib or projection c^1 , rigid on said breast plate, the latter having its inner end elevated and inclined downwardly to deflect and hold the cord on the knotter as shown and described.

No. 38,130. Knotter for Harvester Binders.

(*Machine à nouer pour moissonneuses-lieuses.*)

The Noxon Bros. Manufacturing Co., Ingersoll, Ontario, Canada, assignees of John E. Seiberling, Akron, Ohio, U.S.A., 16th January, 1892; 5 years.

Claim.—1st. In a knotter for binding grain, a rotary cord-holder disc, having a series of notches to hold the cord, in combination with a cord clamp or shoe to hold the end of the cord in a disc, said shoe and disc being arranged in respect to each other, so that the notch carrying the end of the cord will pass beyond the clamping face of the shoe at each movement of the disc, substantially as and for the purpose set forth. 2nd. In a grain binding knotter, a rotary cord-holder disc having a series of notches to receive the cord, a cord clamp or shoe to hold the end of the cord on the disc, said disc and shoe being arranged in respect to each other, so that the notch carrying the cord will pass beyond the clamping face of the shoe at each movement of the disc, said disc and shoe being also provided with a groove and a rib engaging each other and extending in the direction of the travel of the disc, to hold the shoe on the disc, substantially as set described. 3rd. The combination with a crown disc cord-holder having a series of cord notches, of a clamp or shoe having a clamping surface bearing against the disc between two of the said notches only, and a guard for preventing the cord from entering the notch, in the disc at the end of the shoe nearest the knife, while the needle lays the cord in the notch at the opposite end of the shoe, whereby the end of the cord extending round the bundle is released in advance of the action of the knife on the cord, substantially as described. 4th. The combination of a crown disc cord-holder having a series of notches to receive the cord, a cord clamp or shoe

having a clamping surface bearing against the face of said disc between two of said notches only, said disc and shoe being provided, one with a groove and the other with a retaining flange, and a guard at the inner end of said shoe for preventing the cord from entering the notch nearest the knotter, while the needle lays the cord in the open notch in the opposite side of said disc, substantially as described. 5th. The combination of the crown disc cord-holder having a series of notches, the clamp or shoe E, having a clamping surface extending only between two of the said notches, the guard c^3 , at the inner end of said shoe for preventing the cord from entering the notch nearest the knotter, while the needle lays the cord in the open notch in the opposite side of said disc, a supporting spring, the knotter k , and the knife h , substantially as described.

No. 38,131. Temperature Regulator.

(*Régulateur de température.*)

The Consolidated Car Heating Company, assignees of James Finney McElroy, all of Albany, New York, U.S.A., 16th January, 1892; 5 years.

Claim.—1st. In a temperature regulator, the combination of the frame plate, a lever hinged thereto, connections between the lever and the valve to be operated, an expansion chamber between the frame plate and lever, and an expansible fluid in the expansion chamber, substantially as described. 2nd. In a temperature regulator the combination of the frame plate, a lever hinged thereto, connections between the lever and the valve to be operated, an expansion chamber between the frame plate and lever, formed of two diaphragms and containing an expansive fluid, substantially as described. 3rd. In a temperature regulator, the combination of the frame plate, a lever hinged thereto, connections between the lever and the valve to be operated, an expansion chamber between containing an expansive fluid, a spring against which the expansion acts and means for adjusting the tension of said spring, substantially as described. 4th. In a temperature regulator, the combination of the frame plate, the lever hinged thereto, the diaphragms between, the steam valve adapted to be closed by fluid pressure, the auxiliary valve operated by the expansion chamber, to open and close the supply and exhaust ports alternately, substantially as described. 5th. In a temperature regulator, the combination of a fluid pressure apparatus, a steam supply valve connected with and adapted to be operated by the fluid pressure, an auxiliary valve for controlling the fluid pressure, and a thermostat and connecting levers for operating said auxiliary valve, substantially as described. 6th. In a temperature regulator, the combination of a fluid pressure apparatus, a steam supply valve, connected with and adapted to be operated by the fluid pressure, an auxiliary valve for controlling the fluid pressure, and an exhaust port and a thermostat and connecting levers for operating said auxiliary valve, substantially as described. 7th. In a temperature regulator, the combination of a fluid pressure apparatus, a steam supply valve, connected with and adapted to be operated by said fluid pressure, an auxiliary valve, the thermostat for opening said auxiliary valve against the tension of a spring, which holds the auxiliary valve normally closed, substantially as described. 8th. In a temperature regulator, an expansion chamber formed by two diaphragms secured together at the edges, substantially as described. 9th. In a temperature regulator, an expansion chamber formed by two metallic diaphragms secured together at the edges, and means for adjusting the size of said chamber, substantially as described. 10th. In a temperature regulator, an expansion chamber, a volatile fluid therein, vaporizing at or near 70°, F., and means for increasing or decreasing the size of said chamber, substantially as described. 11th. In a temperature regulator, an expansion chamber formed of two diaphragms secured together at the edges, a frame to which one of said diaphragms is secured, a lever to which the opposite diaphragm is secured, and connecting mechanism to the valve, substantially as described. 12th. In a temperature regulator, the combination of the plate A, lever D hinged thereto, an expansion chamber formed of diaphragms a , b , connected respectively to the frame and lever, the bell crank lever E¹, rod G, spring J² and adjusting nut I², substantially as described. 13th. In a temperature regulator, the combination of the plate A, lever D hinged thereto, expansion chamber formed of diaphragms a , b , bell crank lever E¹, rod G, spring J² clamped at one end to the rod and at the other end to the adjoining nut, substantially as described. 14th. In a temperature regulator, the combination with the expansion chamber and connecting levers, of a spring against which the expansion acts to move the valve, and means for adjusting the tension of said spring, substantially as described.

No. 38,132. Refrigerator Car and Building.

(*Char ou bâtiment frigorifiques.*)

Joseph Francis Hanrahan, Chicago, Illinois, U.S.A., 20th January, 1892; 5 years.

Claim.—In a refrigerator or like structure, the combination with the sheathing A, B, and timbers C, dividing the wall into dead air spaces, of the layers of paper or like material applied to the sheathings, and the cords or strings interposed between the timbers and the sheathing, and adapted to imbed themselves into the latter and into the paper.

No. 38,133. Lubricating Oil. (*Huile lubrifiante.*)

Robert Rudolf Graf and Harry Fowler Turner, Baltimore, Maryland, U.S.A., 20th January, 1892; 5 years.

Claim.—A fire proof lubricating oil, consisting of a mixture of an ordinary lubricating oil, with sodium tungstate, sulphate of ammonia, phosphate of ammonia, sal-ammonia, and mono-carbonate of soda, in about the proportions substantially as specified.

No. 38,134. Car Ticket Holder.

(*Porte-billets de chemin de fer.*)

William B. Moore and George B. Willett, both of Moncton, New Brunswick, Canada, 21st January, 1892; 5 years.

Claim.—1st. The combination of the board or stand *a*, and the spring loop *B*, substantially as and for the purpose hereinbefore set forth. 2nd. The combination of the bar *c*, and the spring loop *B*, substantially as and for the purpose hereinbefore set forth. 3rd. The combination of the spiral or coiled springs *d*¹, *d*², and the bar *g*¹, substantially as and for the purpose hereinbefore set forth.

No. 38,135. Clothes Drier. (*Séchoir à lignes.*)

William Edward Austin, Toronto, Ontario, Canada, 21st January, 1892; 5 years.

Claim.—1st. In a clothes drier, the combination with an extensible support adapted to be held vertically by contact with the floor and ceiling of a room, of the sleeve *F*, the block by having sockets *H*, and slots *h*, the wire band *K*, arms *M*, adapted to fit in said sockets, the said arms having loops *m*, engaging the said band *K*, and means for raising and lowering the said block and arms, substantially as set forth. 2nd. In a clothes drier, the combination with a vertical support having a block to which are secured a series of radial arms sliding on said support of the cord *N*, pulley block *O*, and pulley *P*, substantially as set forth.

No. 38,136. Milk Receiver. (*Vaisselle à lait.*)

Edward Batters, Toronto, Ontario, Canada, 21st January, 1892; 5 years.

Claim.—1st. A milk receiver comprised of a vessel or milk tin with a flat side secured to the inner side of the door and connecting to the outside by a slanting spout arranged, as and for the purpose specified. 2nd. A milk receiver comprised of a vessel or milk tin with a flat side secured to the inner side of the door, and connecting to the outside by a slanting spout, and having a hinged flap *B* at the outer end of the spout which is secured in position by the catch or hook *b*, as and for the purpose specified. 3rd. The milk receiver *C*, secured to the door by the slotted lugs *D*, and screw eyes *F*, and having a spout *I*, closed by the flap *B*, arranged as and for the purpose specified. 4th. The milk receiver *C*, secured to the door and having a slanting spout *I*, connecting it to the door, in combination with the adjustable supplemental spout *M*, provided with the hinged flap *B*, arranged as and for the purpose specified. 5th. The milk receiver *C*, secured to the door as specified, in combination with the spout *T*, supplemented spout *M*, and hole *p*, made in the top of the supplemental spout, as and for the purpose specified. 6th. In a milk receiver, the laterally adjustable supplemental spout *M*, provided with the opening *P*, to permit the milk to be poured into the spout, in combination with the sieves *N* and *O*, arranged as and for the purpose specified. 7th. In a milk receiver, the supplemental spout *t*, arranged as specified, in combination with the ticket pocket *Q*, formed in the top of the supplemental spout, and arranged as and for the purpose specified. 8th. In a milk receiver, the supplemental spout *M* having a lip *n*, secured at its outer end, as and for the purpose specified. 9th. In a milk receiver the supplemental spout *M*, provided with guide-ways *o*, which forms stops as and for the purpose specified. 10th. In a milk receiver, the supplemental spout *M*, provided with a supplemental stop *g*, arranged as specified.

No. 38,137. Shingle. (*Bardeau.*)

George Henry Pedlar, Oshawa, Ontario, Canada, 21st January, 1892; 5 years.

Claim.—In metallic shingles the mode of fashioning one edge of each shingle with the open loop *G* and double curve to receive the edge of the next shingle at the opening at *a*, and forming a spring substantially as and for the purposes described.

No. 38,138. Safety Trap for Discharge Pipes.

(*Trappe de sûreté pour tuyaux de décharge.*)

Edward E. Scott, East Saginaw, Michigan, U.S.A., 21st January, 1892; 5 years.

Claim.—1st. A safety trap of circular form, the upper and lower outer edges forming an arc of a small circle with sides convex, the inlet *a*, entering well toward the top of the trap, and the outer edge of the trap from the point of its entry at *r*, to the mouth of the outlet at *m*, being in form and appearance a continuance of the lower part of the discharge pipe, the pipe *o*, extending on the arc of a circle from well toward the bottom of the trap, and being sealed at the top by the ball *E*, all substantially as and for the intents and purposes hereinbefore described. 2nd. A safety trap of circular form, having its greatest diameter in a vertical plane drawn through

the centre thereof from *r* to *m*, its sides convex, forming over the water trap *S*, the air chamber *d*, the inlet pipe *a*, entering near the top of the trap at *r*, and from thence to the outlet at *m*, the ends and bottom of the trap being in effect a continuance of the lower part of the discharge pipe on the arc of a small circle, the lip *h*, forming the inner part of the pipe *o*, projecting toward the bottom of the trap, its top forming the seat of the ball *E*, and the outer half thereof forming the lip *l*, and having the ball chamber *g*, with ball *E*, and oblong mouth *m*, of outlet *b*, all substantially as and for the intents and purposes set forth.

No. 38,139. Treatment of Permanganate.

(*Traitement de permanganate.*)

James Howarth Parkinson, Manchester, England, 22nd January, 1892; 5 years.

Claim.—1st. The process of forming a spongy or porous mass from permanganate of potash or soda, or lower oxide of the same, which consists in mixing the permanganate into a pasty mass with kaolin, porcelain clay, or similar material, and baking hard and dry in a retort or stove in a partial vacuum, substantially as described. 2nd. A spongy porous mass produced from permanganate of potash or soda, or lower oxide thereof, which can be readily permeated by air produced in the manner, substantially as described.

No. 38,140. Process for Separating or Obtaining Oxygen from Atmospheric Air. (*Procédé pour séparer ou obtenir de l'oxygène de l'air atmosphérique.*)

James Howarth Parkinson, Manchester, England, 22nd January, 1892; 5 years.

Claim.—1st. The process of manufacturing or separating oxygen from atmospheric air, which consists in heating a porous or spongy mass of permanganate, passing purified air therethrough under pressure when oxygen is absorbed, and subsequently drawing off the oxygen under a reduced pressure, substantially as described. 2nd. The process of manufacturing or separating oxygen from atmospheric air, which consists in forcing or drawing purified air under pressure through heated permanganate until the oxygen is absorbed, and then liberating or drawing off the oxygen thus absorbed by reducing the pressure, substantially as described. 3rd. The process of separating oxygen from atmospheric air, consisting in forcing purified air into a retort wherein oxygen is absorbed, and at the same time drawing off oxygen from another retort, and subsequently changing the direction of flow of the air and gas without stopping the apparatus, thereby maintaining a continuous process, substantially as described. 4th. A continuous process for separating oxygen from atmospheric air, which consists in forcing air into one retort while oxygen is being withdrawn from another in connection therewith, and then reversing the apparatus and flow of the air and gas whereby the oxygen is withdrawn from the second retort and the air forced into the first without stopping the apparatus, substantially as described. 5th. In the manufacture or separation of oxygen from atmospheric air, the use of a permanganate in a porous or spongy condition to absorb the oxygen, and subsequently to liberate the same, substantially as described. 6th. In apparatus for separating oxygen from atmospheric air, the combination with a retort of the central diaphragm or division plate *F*, to divert the current of air through the material in the retort and the flues *f*, to carry the heated products and increase the heating surface, substantially as described. 7th. In apparatus for separating oxygen from atmospheric air, the combination with a retort of a central division plate *F*, flues *f*, conducting pieces *f*¹, both inside and outside the flues, substantially as described. 8th. The combination with apparatus for separating oxygen from atmospheric air, of a retort constructed with a central division plate *F*, and internal flues *f*, substantially as described. 9th. In apparatus for separating oxygen from atmospheric air, the combination with the retorts *B* and *C*, and pipe *Q*, of the valve *t*, and piston *t*¹, on one spindle, spring *t*¹, and inlet pipe *t*¹, substantially as described. 10th. In apparatus for separating oxygen from atmospheric air, the combination with the retorts and delivery pipes *r*, *r*¹, of the two valves *U*¹, *U*², opening in opposite directions, piston *u*¹, spring *u*¹, pipe *u*¹, and nozzle *u*¹, substantially as described. 11th. In apparatus for separating oxygen from atmospheric air, the combination with the retorts and furnace chamber *D*, of the annular chamber *W*¹, perforated pipe *w*, placed therein, through which the gaseous fuel passes with a water seal at the bottom, the chamber *w*¹, retort *w*¹, in which air or other fluid is heated and allowed to expand and contract, and the connecting pipes *w*¹, which regulates the supply of gaseous fuel in accordance with the heat of the furnace, substantially as described. 12th. In apparatus for separating oxygen from atmospheric air, the combination with the retort *A*, inlet pipe *a*, and outlet pipe *a*¹, of the retorts *B* and *C*, the connecting pipes *b* and *c*, and the three-way valve *M*, substantially as described. 13th. In apparatus for separating oxygen from atmospheric air, the combination with the retort *A*, inlet pipe *a*, and outlet pipe *a*¹, of the retorts *B* and *C*, connecting pipes *b* and *c*, three-way valve *M*, cylinder and piston *O*, and connecting rod *o*, substantially as described. 14th. In apparatus for separating oxygen from atmospheric air, the combination with the retort *A*, inlet pipe *a*, and outlet pipe *a*¹, of the retorts *B*, *C*, connecting pipes *b*, *c*, three-way inlet valve *M*, cylinder and piston

O, connecting rods a , a' , valve rod r , stop washers r^1 , r^2 , connecting rod V, and disc V¹, substantially as described. 15th. In apparatus for separating oxygen from atmospheric air, the combination with the retorts B and C, of the inlet pipes b , c , three-way inlet valve M, and outlet pipes P and Q, substantially as described. 16th. In apparatus for separating oxygen from atmospheric air, the combination with the retorts B, C, inlet pipes b , c , and three-way inlet valve M, of the pipe P, back pressure valves S, S¹, pipe Q, and delivery valves T, T¹, substantially as described. 17th. In apparatus for separating oxygen from atmospheric air, the combination with the retorts B and C, of the outlet pipes P and Q, the valves S, S¹, T, T¹, and air or vacuum pump R, substantially as described. 18th. In apparatus for separating oxygen from atmospheric air, the combination with the retorts B and C, pipes P and Q, and valves S, S¹, T, T¹, of the air or vacuum pump R, pipes r , r^1 , and valve U, substantially as described. 19th. In apparatus for separating oxygen from atmospheric air, the combination with the retorts B and C, of the pipe Q, the air or vacuum pump R, pipe r , and valve U, substantially as described. 20th. In apparatus for separating oxygen from atmospheric air, the combination with the retort A, inlet pipes a , a' , three-way valve M, cylinder and piston and connecting rod o , of the pipes b , c , retorts B and C, and delivery pipes P and Q, substantially as described. 21st. In apparatus for separating oxygen from atmospheric air, the combination with the retort A, inlet pipes a , a' , three-way valve M, pipes b and c , cylinder and piston O, piston rod o , valve rod r , and connecting rod V, of the retorts B and C, pipes P and Q, delivery valves S, S¹, T, T¹, air or vacuum pump R, valve U, and pipes r , r^1 , substantially as described. 22nd. In apparatus for separating oxygen from atmospheric air, the combination with the retorts A, B and C, of the air purifiers J and K, and three air pumps H, I and R, working together, two forcing in air while the third is withdrawing oxygen, substantially as described. 23rd. In apparatus for separating oxygen from atmospheric air, the combination with retorts A, B and C, and air purifiers J and K, of the pumps H, I, R, and gas heater P¹, substantially as described. 24th. In apparatus for separating oxygen from atmospheric air, the combination with the retorts A, B and C, and air purifiers J and K, of the pumps H, I, R, gas heater P¹, and thermo regulator W, substantially as described. 25th. In apparatus for separating oxygen from atmospheric air, the combination with the retort A, inlet pipe a , and outlet pipe a' , connecting pipes b and c , three-way valve M, cylinder and piston O, and connecting rod o , of the retorts B and C, pipes P and Q, the valves S, S¹, T, T¹, and air or vacuum pump R, substantially as described. 26th. In apparatus for separating oxygen from atmospheric air, the combination with the retort A, inlet pipe a , and outlet pipe a' , connecting pipes b and c , three-way valve M, cylinder and piston O, and connecting rod o , of the retorts B and C, pipes P and Q, and valves S, S¹, T, T¹, air or vacuum pump R, pipes r , r^1 , and valve U, substantially as described. 27th. In apparatus for separating oxygen from atmospheric air, the combination with the retort A, inlet pipe a , and outlet pipe a' , connecting pipes b , c , three-way inlet valve M, cylinder and piston O, connecting rods o , o' , valve rod r , stop washers r^1 , r^2 , connecting rod V, and disc V¹, of the retorts B and C, outlet pipes P and Q, and valves S, S¹, T, T¹, and air or vacuum pump R, substantially as described. 28th. In apparatus for separating oxygen from atmospheric air, the combination with the retort A, inlet pipe a , and outlet pipe a' , connecting pipes b , c , three-way inlet valve M, cylinder and piston O, connecting rods o , o' , valve rod r , stop washers r^1 , r^2 , connecting rod V, and disc V¹, of the retorts B and C, pipe Q, the air or vacuum pump R, pipe r , and valve U, substantially as described. 29th. In apparatus for separating oxygen from atmospheric air, the combination with the retort A, inlet pipe a , and outlet pipe a' , connecting pipes b and c , three-way valve M, cylinder and piston O, and connecting rod o , of the retorts B and C, pipe Q, the air or vacuum pump R, pipe r , and valve U, substantially as described. 30th. In apparatus for separating oxygen from atmospheric air, the combination with the retort A, inlet pipe a , and outlet pipe a' , connecting pipes b , c , three-way inlet valve M, cylinder and piston O, connecting rods o , o' , valve rod r , stop washers r^1 , r^2 , connecting rod V, and disc V¹, of the retorts B and C, pipe Q, the air or vacuum pump R, pipe r , and valve U, substantially as described. 31st. In apparatus for separating oxygen from atmospheric air, the combination with the retort A, inlet pipe a , and outlet pipe a' , connecting pipes b and c , three-way valve M, cylinder and piston O, and connecting rod o , of the retorts B and C, purifiers J and K, and three air pumps, H, I and R, working together, two forcing in air while the third is withdrawing oxygen, substantially as described. 32nd. In apparatus for separating oxygen from atmospheric air, the combination with the retort A, inlet pipe a , and outlet pipe a' , connecting pipes b , c , three-way inlet valve M, cylinder and piston O, connecting rods o , o' , valve rod r , stop washers r^1 , r^2 , connecting rod V, and disc V¹, of the retorts B and C, purifiers J and K, and three air pumps H, I and R, working together, two forcing in air while the third is withdrawing oxygen, substantially as described. 33rd. In apparatus for separating oxygen from atmospheric air, the combination with the retort A, inlet pipe a , and outlet pipe a' , connecting pipes b and c , three-way valve M, cylinder and piston O, and connecting rod o , of the retorts B and C, air purifiers J and K, pumps H, I, R, and gas heater P¹, substantially as described. 34th. In apparatus for separating oxygen from atmospheric air, the combination with the retort A, inlet pipe a , and outlet pipe a' , connecting pipes b and c ,

three-way inlet valve M, cylinder and piston O, connecting rods o , o' , valve rod r , stop washers r^1 , r^2 , connecting rod V, and disc V¹, of the retorts B and C, air purifiers J and K, pumps H, I, R, and gas heater P¹, substantially as described. 35th. In apparatus for separating oxygen from atmospheric air, the combination with the retort A, inlet pipe a , and outlet pipe a' , connecting pipes b and c , three-way valve M, cylinder and piston O, and connecting rod o , of the retorts B and C, air purifiers J and K, pumps H, I, R, gas heater P¹, and thermo regulator W, substantially as described. 36th. In apparatus for separating oxygen from atmospheric air, the combination with the retort A, inlet pipe a , and outlet pipe a' , connecting pipes b , c , three-way inlet valve M, cylinder and piston O, connecting rods o , o' , valve rod r , stop washers r^1 , r^2 , connecting rod V, and disc V¹, of the retorts B and C, air purifiers J and K, pumps H, I, R, gas heater P¹, and thermo regulator W, substantially as described.

No. 38,141. Hydrant. (Borne-fontaine.)

John Allen Gregg, West Bay City, Michigan, U.S.A., 22nd January, 1892; 5 years.

Claim.—The combination, with a hollow vertical column provided on its upper end with an enlarged chamber, a vertical shaft within the chamber and journaled in transverse supports, and having its upper end projecting through the upper end portion of the chamber and provided on its middle portion with a worm thread, the vertical arms m on opposite sides of the shaft and provided on their inner sides with teeth for engaging with the said worm thread, and having their lower ends connected to a head portion, the guides r and p for supporting the said arms, a valve rod secured by its upper end to the said head portion and carrying on its lower end a valve, and a seat for the valve secured within the lower portion of the column, substantially as set forth.

No. 38,142. Brooch or Lace Pin Safety Attachment.

(*Epingle de sûreté.*)

William Wattie, Worcester, Massachusetts, U.S.A., 22nd January, 1892; 5 years.

Claim.—1st. The combination, with a brooch, lace pin or other similar article, of a safety attachment consisting of a chain or cord attached at its upper end to said brooch, and a weight attached to said chain or cord, said safety attachment adapted to extend within the garment of the wearer and be entirely concealed from view, for the purpose, substantially as set forth. 2nd. The combination with a brooch, lace pin or similar article, of the safety attachment, consisting of a weight and a connection therefrom to the brooch, for the purpose stated, substantially as set forth.

No. 38,143. Water and Wind Wheel.

(*Roue hydraulique et à vent.*)

Narcisse Duval and Théodore Bélanger, both of Montreal, Quebec, Canada, 22nd January, 1892; 5 years.

Claim.—1st. A water or wind wheel consisting of a series of plates or floats, hinged to rods secured in the peripheries of two annular discs, the said discs being secured to the top and bottom of a cylinder mounted on a vertical shaft, and stops for holding the said hinged plates when receiving the impact of the current, substantially as set forth. 2nd. A water or wind wheel, the floats of which consist of hinged plates secured to the periphery of a disc or discs, stops for holding the said plates while receiving the impact of the current, the said plates being feathered or turned in the direction of the current, by the current on that side of the wheel turning against the stream or wind, substantially as set forth. 3rd. In a water or wind wheel, the combination with the cylinder B and discs D, E, of the rods F, hinged plates G and stops H, substantially as set forth.

No. 38,144. Lubricating Device.

(*Appareil de graissage.*)

James E. Totman and Martin Crickson, both of La Crosse, Wisconsin, U.S.A., 22nd January, 1892; 5 years.

Claim.—1st. In an attachment for lubricators for steam cylinders, the combination, with a body provided with an enlarged oil conduit and having an inclined surface a portion of its length, of a perforated plug in the conduit beyond the inclined surface, and a steam conduit leading from the steam pipe and communicating with the oil conduit opposite to and discharging upon the inclined surface, substantially as described. 2nd. In an attachment for lubricators for steam cylinders, the combination, with a body having two channels, each communicating the steam supply pipe and one of them with the oil supply, of a perforated plug across one of the channels, said channel being formed with an inclined surface, and an oil chamber above the plug, substantially as described. 3rd. In an attachment for lubricators for steam cylinders, the combination, with a body provided with a channel for the passage of the oil and a second passage for the entrance of steam thereto from the steam pipe, of a plug in the passage, the inner end of which is hollow and provided with perforations, and a perforated plate in the end of the plug, substantially as described. 4th. In an attachment for lubricators for steam cylinders, the combination, with a body provided with two passages, each communicating with the steam supply pipe

and one of them with the oil supply, of a perforated plug across the oil passage beyond the entrance of the steam passage, a perforated tube at the end of the oil passage projecting into the steam supply pipe in the direction of the passage of the steam to the cylinder and a removable plug in the end of the tube, substantially as described.

No. 38,145. Keel Block. (*Cric pour quilles.*)

Warren Henry Carr and James Darius Robinson, both of Bath, Maine, U. S. A., 25th January, 1892; 5 years.

Claim.—1st. The combination of an inclined block, an adjustable block mounted thereon, and a screw for operating said adjustable block; substantially as set forth. 2nd. The combination with a wedge base-block having flanges at its sides, of an adjustable wedge block sliding on the base-block between the flanges and a screw for operating the adjustable block; substantially as described. 3rd. The combination with a wedge block provided with an apertured lug, of a wedge block carrying a screw working in said lug substantially as described. 4th. The combination, with a wedge block provided with the flanges and apertured lug, of a wedge block recessed as described, the screw, collars, and means for revolving said screw, substantially as set forth.

No. 38,146. Clothes Washer. (*Machine à blanchir.*)

Edward Byron Near, Petersburg, Ontario, Canada, Assignee of Garret Seger, Buffalo, New York, U. S. A., 25th January, 1892; 5 years.

Claim.—1st. In clothes washers, the disc A, to which are secured the caps *b*, substantially in the manner and for the purpose set forth. 2nd. In clothes washers, the disc A, to which are secured the caps *b*, and operated by means of the handle C, substantially in the manner and for the purpose set forth.

No. 38,147. Screw Eyes. (*Anneau à vis.*)

The American Screw Company, assignees of Charles D. Rodgers, all of Providence, Rhode Island, U. S. A., 25th January, 1892; 15 years.

Claim.—1st. As an improved article of manufacture, a screw-eye having its shank portion provided with a raised screw-thread whose diameter exceeds that of the wire or unthreaded portion. 2nd. The wire screw-eye, substantially as hereinbefore described, having its shank or stem provided with a raised screw-thread whose diameter is greater than that of the wire itself, and having the opposite end of the wire cut to a concave form transversely and fitting and inclosing a portion of the shank. 3rd. A gullet-pointed screw-eye made of wire, the shank portion having a rolled or swaged screw-thread formed thereon, and having the end of the wire contiguous to the eye-joint provided with side lips or extensions *c*¹, in contact with and closing a portion of the shank, substantially as hereinbefore described and for the purpose set forth.

No. 38,148. Sulky Spring Tooth Harrow.

(*Hersa à dents élastiques.*)

The J. W. Mann Manufacturing Company, assignees of Thomas G. Cook, all of Brockville, Ontario, Canada, 25th January, 1892; 5 years.

Claim.—1st. The vertically standing C-shaped spring P, the row of the spring facing towards the rear of the machine, and the lower end of said spring secured to the rear of the harrow section, the upper end of said spring terminating above an arm L, secured to a rock shaft J, journaled to the sulky frame, and the terminations of said spring and arm connected by a chain O, for forcing the harrow teeth into the ground, as set forth. 2nd. The combination, with a flexible harrow section, of a rearwardly attached C-shaped spring P, a rock shaft J, journaled in the sulky frame and having an arm L, and a chain or chains O, T, connecting said arm with the upper and lower ends of said springs, as set forth.

No. 38,149. Pulley. (*Ponlie.*)

Isaac N. Kendall, New Westminster, British Columbia, Canada, 25th January, 1892; 5 years.

Claim.—1st. The combination of the grooved pulley and a series of levers fulcrumed upon the face of the pulley, and having the outer ends thereof provided with grooves opposite the groove of the pulley and an adjustable non-rotating sleeve provided at its inner end with a flange having a track for engaging the inner ends of the levers, substantially as specified. 2nd. The combination, with the pulley, the side of which is grooved and the series of clamping levers fulcrumed upon the face of the pulley and grooved near their outer ends, of a sleeve mounted for longitudinal adjustment upon the same and a flange provided with a track for operating against the inner ends of the levers and mounted upon said sleeve, substantially as specified. 3rd. The combination, with the pulley, its shaft, the clamping levers, and means for operating the same, of the bearing for one end of the shaft, a set screw supported in the bearing and bearing against the end of the shaft a bushing encircling the set screws and provided upon its inner end with a flange, and a rubber or other yielding packing encircling the bushing and interposed between the same and the end of the bearing, substantially as specified. 4th. The combination, with pulley, shell, the series of pairs of bearing lugs secured to the

face of the same, the series of levers pivoted between the bearing ears, the grooved lugs 19 and 20 located between the levers the bearing 3 for the end of the shaft, the shaft 1, the tube or sleeve 11 having the flange 12, the sliding sleeve 21 splined upon the sleeve 11 and provided with the rear flange 22 and the front flange 26 having the track 27 for operating the levers, the bolts 24 connecting the rear flanges of the two sleeves, the nuts mounted upon the bolts between the flanges, the headed bushing 6 located in the rear end of the bearing 2, the adjusting screw threaded in the bushing terminating at its inner end against the shaft and at its outer end provided with a hand-wheel, and the rubber packing 8, interposed between the head of the bushing and the bearing, substantially as specified. 5th. The combination, with the pulley provided with a bearing ear secured thereto, of a clamping lever provided upon one face with a recess into which the bearing ear projects, a pin passing through said lever and the bearing ear, and an adjustable bolt carried by the lever near its inner end and adapted to bear upon the side of the pulley, as and for the purpose specified. 6th. The combination, with the pulley provided with ear secured thereto by means of a pin or bolt, and an elastic washer interposed between the pulley and the head of said securing bolt, of a clamping lever pivotally connected to said bearing ear, as and for the purpose specified.

No. 38,150. Circular Knitting Machine.

(*Machine à tricôt circulaire.*)

The S. B. Wilkins Co., Rockford, Illinois, assignees of John R. Bridges, Findley, Ohio, U. S. A., 25th January, 1892; 5 years.

Claim.—1st. The combination of the needle-bed and its needles, some of which are fashioning-needles, the needle-operating cams, the reciprocating jacks connected to the needles and constructed to engage with said cams, supporting-jack for the reciprocating jacks of the fashioning-needles, an expanding and contracting cam and means whereby said cam is caused to act upon the supporting-jacks of the fashioning-needles so as to move the reciprocating jacks into and out of engagement with the needle-operating cams, all substantially as specified. 2nd. The combination of the needle-bed and its needles, some of which are fashioning-needles, the needle-operating cams, the reciprocating jack connected to the needles and movable into and out of engagement with said cams, supporting-jacks for the reciprocating jacks of the fashioning-needles, pins acting on said supporting-jacks, and an expanding and contracting cam acting on said pins, all substantially as specified. 3rd. The combination of the needle-bed and its needles, the needle-actuating cams, jacks connected to said needles and movable into and out of engagement with the cams, an expanding and contracting cam, and means whereby individual jacks may be acted upon thereby, a ring whereby a number of jacks may be acted upon simultaneously, and means whereby said ring is actuated by said expanding and contracting cam, all substantially as specified. 4th. The combination of the needle-bed and its needles, the needle-operating cams, the reciprocating jacks movable into and out of engagement with said cams, the supporting jacks, the lifting and ring pins, and the jack-ring with an expanding and contracting cam adapted to actuate said lifting and ring pins, whereby some of the needles may be simultaneously and others singly withdrawn from or brought into action, all substantially as specified. 5th. The combination, with the cam-ring B, having the sectional ring I rigidly secured thereto, and the main or driving belt L¹ of a series of tight and loose pulleys L² L³ and L⁴, straight belt L⁷, cross-belt L¹⁰, pulley L⁸ mechanism to communicate motion from said pulley L⁸ to said cam-ring B, a swinging tappet adapted to be operated by said sectional ring, a belt-shifter and connecting mechanism intermediate of said tappet and belt shifter, all constructed and arranged substantially as shown and described. 6th. The combination of a radially arranged series of needles a cam-ring adapted to reciprocate the same, a vertically arranged series of hook-jacks provided each with a hook, a hook-cam cylinder adapted to actuate said hook-jacks in the direction of their length, and mechanism to impart motion to said cam-ring and hook-cam cylinder, the said several parts being constructed and arranged to operate substantially as set forth. 7th. The combination with the hook-jacks and cam-ring, of an adjustable plate secured to said ring and constructed and arranged substantially as shown and described, whereby the length of the loops and the texture of the fabric may be regulated and determined, as set forth. 8th. The combination with the cam-ring and the operating-cams thereof, of a spring provided with a lobe located upon each side of the said operating cams and arranged to ride over and upon the needle-jacks, as shown and described, whereby all unsupported jacks are forced out of operative connection connection with said cams, as set forth.

No. 38,151. Process of and Apparatus for Manufacturing Gas. (*Procédé et appareil pour la fabrication du gaz.*)

Burdett Loomis, Hartford, Connecticut, U. S. A., 25th January, 1892; 5 years.

Claim.—1st. A gas generator having a closed circumferential hearth and a central grate opening in combination with an exhauster connecting by suitable flues with the central grate opening, for the purpose described. 2nd. A downdraft generator having an air supply pipe connecting with its top, and a closed circumferential hearth having a central opening and an ash-pit, in combination with

the exhauster connecting with such central ash-pit, whereby the air-draft and gaseous products are drawn away from the side walls of the furnace and more evenly through the body of fuel, for the purpose described. 3rd. A gas generator having an air supply pipe or opening at its top above the fuel and an outlet pipe leading from its bottom, in combination with a cooler connecting with such outlet pipe and an exhauster connecting with the cooler for drawing air down into the fuel and the resulting gases out from the bottom of the generator and through the cooler, as and for the purpose described. 4th. In combination with the ash-pit of a furnace having a contracted grate opening, the wide central flue placed below such ash-pit, and division walls constructed in such flue for supporting the floor of the ash-pit and forming steam heating surfaces. 5th. A downdraft gas generating furnace having supply pipes for steam, oil and powdered fuel, connecting with the fuel chamber, and a gas outlet pipe leading from its base, in combination with a cooler and exhauster connecting with such gas outlet pipe, a pipe J, having valve *j*, leading from the exhauster, a smoke escape pipe Y, having blow-off valve *y*, and a pipe K, having valve *k*, both connecting with pipe J, between its valve *j* and the exhauster, substantially as and for the purpose described. 6th. The process of generating heating or fuel gas, which consists of drawing both air and steam down into and through a body of ignited fuel, thereby causing combustion of the fuel with formation of producer-gas and decomposition of the steam with formation of water-gas, causing vapors distilled from the upper layers of coal to pass into the heated fuel below for conversion into fixed gas, and drawing the resulting mixed gases down through the fuel and out at the bottom of the generator, whereby the fuel may be supplied and arranged in the generator while the exhauster is in operation without any danger and delay caused by flame and smoke being blown into the operator's face, and also whereby the coal may be better coked and converted into gas. 7th. The process of generating heating or fuel gas, which consists in admitting air to the top of a bed of ignited fuel for causing combustion thereof, and at the same time admitting steam into the more highly heated fuel below the top, and drawing both the air and steam down into and through the heated fuel, thereby causing combustion of the fuel with formation of producer-gas and decomposition of the steam with formation of water-gas, causing vapors distilled from the upper layers of coal to pass into the heated fuel below for conversion into fixed gas, and drawing the resulting mixed gases down through the fuel and out at the bottom of the generator.

No. 38,152. Machine for Cutting Pipes.

(*Machine pour couper les tuyaux en fonte.*)

Aleide Charest, Montreal, Quebec, Canada, 25th January, 1892; 5 years.

Resumé.—1o. La combinaison des quatre rouleaux coupeurs E, E', E" et des montants A, A', tel que décrit. 2o. La combinaison de la vis D, et de l'échelle c, au moyen des quelles la pression des rouleaux est faite sur le tuyau, tel que ci-dessus décrit et pour les fins indiquées.

No. 38,153. Boot and Shoe. (Chaussure)

George Valiant, Toronto, Ontario, Canada, 26th January, 1892; 5 years.

Claim.—1st. A boot or shoe having an inner sole provided with perforations *a*, cross grooves *c*, surrounding groove *b*, and duct or passage *d*, and a plain ungrooved outer sole applied directly to the inner sole.

No. 38,154. Machine for Turning Moulding.

(*Machine à tourner les moulures.*)

James N. Stout, New York, assignee of Julius F. Gebhardt, both in State of Brooklyn, New York, U. S. A., 26th January, 1892; 5 years.

Claim.—1st. In a lathe attachment for turning mouldings, the combination, with a frame, of a swinging frame in the same, a series of rock-shafts in said swinging frame cutters on the rock-shafts and rods uniting the several rock-shafts with the common handle substantially as set forth. 2nd. The combination, with a frame, of a swinging frame in the same, a spring for pressing said frame upward, a cam for pressing it downward, a series of rock-shafts in said frame and cutters on the rock-shafts and rods uniting the several rock-shafts with a common handle substantially as set forth. 3rd. The combination, with a frame, of a swinging frame in the same, vertically adjustable independent bearing pieces on the swinging frame, a rock-shaft in each pair of bearing pieces, cutters on the rock-shafts and rods uniting the several rock-shafts with a common handle, substantially as set forth. 4th. The combination, with a frame, of a series of cutters, a rock-shaft carrying two arms a short distance from each other, each arm being provided with a marking or gauge blade, and mechanism for manipulating said arms, substantially as set forth. 5th. The combination, with a frame, of a swinging frame in the same, rocking shafts having cutters mounted in said swinging frame a cam lever acting on the swinging frame, a shaft provided with two arms a short distance from each other, marking blades on said arms one of said arms being connected with the cam shaft, substantially as set forth. 6th. The combination, with a frame, of a slotted guide sleeve in the same, a swinging frame

mounted in the above mentioned frame, rocking shafts in the swinging frame and cutters on said rocking shafts, substantially as set forth. 7th. The combination, with a frame of a swinging frame in the same, rocking shafts in said swinging frame cutters on the rocking shafts, a rod on each shaft the free ends of said rods being slotted, and a common handle piece connected with the slotted ends of said bars, substantially as set forth.

No. 38,155. Sash Balance and Lock.

(*Arrête-croisée.*)

Benjamin Marshall, San Francisco, California, U.S.A., 26th January, 1892; 5 years.

Claim.—A sash-raising device, consisting of a sash having its rail provided with a bore extending longitudinally within the same, a rod situated within said bore and provided at one end with a pinion a spring, encircling said rod and adapted to wind as the sash is lowered, a rack on the window casing engaged by said pinion, and a catch seated in the sash and adapted to engage the teeth of the pinion, substantially as described.

No. 38,156. Roofing Fabric.

(*Matériau pour toitures.*)

Henry Ward Johns, New York, N.Y., U.S.A., 26th January, 1892; 15 years.

Claim.—1st. A compound sheet comprising essentially a plurality of separate sheets of different materials and of average equal widths, one of them being canvas having a selvage edge, any excess in width and projecting edge of the canvas being made straight and equal in width to the other sheets by turning in the edges thereof and cementing material between the several sheets, substantially as set forth. 2nd. A compound sheet comprising essentially a plurality of separate sheets, having cementing material between them, one or both the edges of either of said sheets being folded over upon itself, thus thickening the edge of the sheet and interposing a rib between it and the next sheet, whereby the outflowing of the cementing material is obstructed, substantially as set forth.

No. 38,157. Manufacture of Files and Rasps.

(*Fabrication de limes et râpes.*)

Alfred Weed, Tarrytown, New York, N.Y., U.S.A., 26th January, 1892; 5 years.

Claim.—1st. The within described improvement in the art of cutting files, the same consisting in bringing the cutting tool at an angle against the face of the blank and then forcing the tool into the blank and raising the tooth by forcing downward the heel of the tool, swinging the latter upon its cutting point or edge as a centre, substantially as set forth. 2nd. The combination in a file cutting machine of a support for the blank, a head reciprocating substantially at right angles to the blank and a cutting tool arranged at an angle said head and blank and pivotally connected to swing at its upper end and about its cutting edge or point as a centre when the head descends, substantially as set forth. 3rd. The combination with a reciprocating head of a tool pivoted to the head at its upper end and an inclined arm 10, and spring 13, substantially as set forth. 4th. The combination with a reciprocating head, of a carrier pivoted at one end to swing horizontally on said end and an inclined tool pivoted to the free end of the carrier, substantially as described. 5th. The combination of the reciprocating head, carrier, shaft and appliances for vibrating the shaft automatically, substantially as set forth. 6th. The combination of the reciprocating head, shaft 4, carrier supporting the cutting tool pinion, and rack and wheel 23, connected to reciprocate the rack, and means for turning the wheel with a step by step movement, substantially as described. 7th. The combination of the reciprocating head carrying the cutter tool, the blank carrier 15 and pivoted bed 18, substantially as set forth. 8th. The combination in a machine for cutting files and rasps, of a bed for supporting the blank, a tool having a beveled end, a bearing or rest for the back of the tool and means for reciprocating the tool upon said bearing, substantially as set forth. 9th. The combination of the bed for supporting a blank of a tool, a carrier for supporting the tool provided with a strap for receiving an eccentric and a cross piece 20, arranged to constitute a bearing for the tool adjacent to the blank, substantially as described. 10th. The combination of the cutting tool of a file or rasp cutter, a bed supporting the blank, means for automatically swinging the bed a single step on the upward movement of the tool, substantially as set forth. 11th. The combination of the tool, pivoted bed, a wheel having teeth for engaging the tooth of the bed, means for turning said wheel intermittently and a spring for swinging the bed in one direction, substantially as set forth. 12th. The combination of the bed and its tooth, the toothed wheel provided with a ratchet, an arm 27, carrying a pawl engaging said ratchet and a vibrating arm 31, engaging a pin on the arm 27, substantially as set forth. 13th. The bed provided with a slide for receiving the blank, a screw for feeding the slide, and devices arranged to turn the tool as the bed swings in one direction, substantially as set forth. 14th. The combination of the swinging bed, slide and feed screw, of a ratchet on the end of the screw and a part carried by the base for engaging the ratchet, substantially as set forth.

No. 38,158. Flushing Siphon. (*Siphon de réservoir.*)

Henry R. Ruttan, Winnipeg, Manitoba, Canada, 26th January, 1892; 5 years.

Claim.—The combination of the siphon C, the valve G, double lever N, N, float E, and weight H, connecting rod K, and movable keeper I, substantially for the purpose and as above set forth.

No. 38,159. Neck-Yoke. (*Volée d'avant.*)

Merrell Gadberry, Leon, Kansas, U.S.A., 27th January, 1892; 5 years.

Claim.—1st. The combination of the neck-yoke, the bottom plate secured to the neck-yoke and provided with a pivot depending from the lower face of the neck-yoke, the pole tip having a socket and provided with an annular shoulder and oppositely-disposed grooves, and the coupling-block arranged on the pivot and located below the neck-yoke and provided with a stem arranged in the socket and having oppositely disposed lugs, whereby said neck-yoke will have a vertical swing at the end of the pole-tip and a horizontal oscillation or swing above the pole-tip, substantially as described. 2nd. The combination of the neck-yoke provided with a depending pivot, the coupling block arranged on the pivot and located below the neck-yoke to have a free horizontal oscillation and provided with a stem, a pole-tip arranged in the same plane as the coupling-block and having a socket to receive the stem, whereby the neck-yoke is also permitted a vertical oscillation or swing, and the flange 18 on the block to fit over the end of the pole-tip, substantially as described.

No. 38,160. Fish Hook. (*Hameçon.*)

John Thomas Eichelberger, St. Louis, Missouri, U.S.A., 27th January, 1892; 5 years.

Claim.—1st. The hook A, the upper end of its shank turned horizontally and having an eye a^2 , combined with the ring D, having headed pin d engaging in said eye a^2 , as and for the purposes set forth. 2nd. The fish hook having the eye turned, as described, the ring D, having the headed pin d , the line, and the float, substantially as described.

No. 38,161. Hydraulic Stump Extractor.

(*Arrache-souche hydraulique.*)

Alfred Taylor, San Francisco, California, U. S. A., 27th January, 1892; 5 years.

Claim.—1st. A stump extractor comprising a portable frame, a cylinder carried by the frame, a piston mounted movably in the cylinder and adapted to carry a lifting cable, and a pump carried by the frame and connecting with the lifting cylinder, substantially as shown and described. 2nd. A stump extractor comprising a main frame provided with crank axles and mounted on wheels, means for holding the frame in a raised or lowered position, a lifting cylinder mounted in the upper portion of the frame, a vertically movable piston carried by the cylinder and adapted to carry a lifting cable, and a pump carried by the frame and connecting with the lifting cylinder, substantially as shown and described. 3rd. A stump extractor comprising a main frame having a lifting cylinder at its upper end, a piston held to move vertically in the cylinder and adapted to carry a lifting cable, a water tank carried by the frame, a pump mounted on the tank and connected by a pipe with the lifting cylinder, and a valve arranged in the pipe, substantially as shown and described. 4th. A stump extractor comprising a tripod having its legs provided with shoes at their lower ends, crank axles mounted on the legs of the tripod and also in suitable wheels, means for fixing the position of the cranks, a lifting cylinder held in a vertical position at the upper end of the tripod, a movable piston mounted in the cylinder and adapted to carry a lifting cable, and a pump carried by the tripod, said pump connecting with a source of water supply and with a lifting cylinder, substantially as shown and described. 5th. In a stump extractor, the combination with a tripod, of a cylinder having sockets thereon to fit the upper ends of the tripod legs, a movable piston mounted in the cylinder and adapted to carry a lifting cable, and a pump connected with the cylinder and with the source of water supply, substantially as shown and described. 6th. The combination with the main tripod or frame, of a cylinder carried thereby, a vertically movable piston mounted in the cylinder, said piston having a grooved head adapted to carry a cable, and a pump carried by the tripod or frame and connected with the cylinder and with the source of water supply, substantially as shown and described. 7th. In a stump extractor, the combination with the tripod having lifting mechanism thereon, of crank axles pivoted to the legs of the tripod and mounted in wheels, and means for fixing the position of the cranks in relation to the tripod and wheels, substantially as shown and described. 8th. In a stump extractor, the combination with a lifting chain, of a grip having a central bend to fit a stump, and having end keepers to receive the chain, substantially as shown and described. 9th. The combination with a pump cylinder having a suitable inlet and discharge, of a hollow piston mounted in the cylinder, a smaller piston mounted in the bore of the larger piston, and means for attaching and detaching the two pistons, substantially as shown and described. 10th. A pump comprising two parallel cylinders having suitable inlets and outlets, hollow main pistons held to move vertically in the cylinder, smaller pistons mounted longitudinally in the

main pistons, means for securing the main pistons and the smaller pistons together, and a handle pivoted between the two smaller pistons and extending through recesses in the tops of the said pistons, substantially as shown and described.

No. 38,162. Device for Tapping Stay Bolt Holes.

(*Appareil pour tarauder les trous de boulon d'entretoise.*)

James Thomas Connelly, Milton, Pennsylvania, U.S.A., 27th January, 1892; 5 years.

Claim.—1st. An internally threaded screw tap, substantially as and for the purpose set forth. 2nd. A screw tap having a central longitudinal bore threaded its entire length, substantially as and for the purpose set forth. 3rd. The combination, with a threaded spindle, of a screw tap having a central bore and internally threaded, the internally threaded screw tap being adapted to work upon the screw threaded spindle, substantially as and for the purpose set forth. 4th. The combination, with a spindle threaded its entire length, of a screw tap provided with a central longitudinal bore and internally threaded its entire length, said internally threaded tap being adapted to receive the threaded spindle and work upon the same, substantially as and for the purpose set forth. 5th. In a device for tapping long distance stay bolt holes, the combination, with a threaded spindle, of screw taps oppositely mounted upon the spindle and having a screw threaded bore receiving the same, substantially as and for the purpose set forth. 6th. In a device for tapping long distance stay bolt holes, the combination, with a spindle-screw threaded throughout its length, of screw taps oppositely mounted upon the spindle and having a central longitudinal bore screw threaded throughout its length and receiving the corresponding spindle, substantially as and for the purpose set forth. 7th. In a device for tapping long distance stay bolt holes, the combination, with the spindle threaded throughout its length, of screw taps oppositely mounted upon the ends of the spindle and provided with a central longitudinal bore screw threaded throughout its length, the threads of the spindle having the same pitch as the taps, substantially as and for the purpose set forth. 8th. The combination, with a threaded spindle, of an internally and externally threaded screw tap, substantially as and for the purpose set forth.

No. 38,163. Boot and Shoe Counter.

(*Contrefort de chaussure.*)

James Ferguson Sharpe, London, Ontario, Canada, 27th January, 1892; 5 years.

Claim.—A counter B, secured in position by a row of stitches a , substantially as and for the purpose specified.

No. 38,164. Flange for Loom Beams and Warper Beams. (*Rebord pour métiers à tisser.*)

William Stafford, Lancaster, Ontario, Canada, 27th January, 1892; 5 years.

Claim.—1st. The flange a in combination with rim c , without ribs d , d , and loose centre or boss b , substantially as and for the purpose hereinbefore set forth. 2nd. The flange a in combination with rim c , and loose centre or boss b , without ribs d , substantially as and for the purpose hereinbefore set forth. 3rd. The flange a in combination with rim c , and ribs d , d , and without loose centre or boss b , substantially as and for the purpose hereinbefore set forth. 4th. The flange a in combination with rim c , ribs d , d , and loose centre or boss b , substantially as and for the purpose hereinbefore set forth. 5th. The combination of the flange a , rim c , ribs d , fast center or boss f and rim g , substantially as and for the purpose hereinbefore set forth. 6th. The combination of the flange a , rim c , fast center or boss f , without ribs d , substantially as and for the purpose hereinbefore set forth.

No. 38,165. Plough. (*Charrue.*)

Samuel Irwin, Markdale, and Alexander G. Hunter, Dundalk, both in Ontario, Canada, 27th January, 1892; 5 years.

Claim.—1st. A plough provided with a roller journalled in suitable bearings located between the landside and mould board, interposed between the shear and heel, and extending below the bottom of the landside and mould board, substantially as set forth. 2nd. In a plough, a roller journalled in suitable bearings, located between the landside and mould board, interposed between the shear and heel, and projecting below the bottom of the landside and mould board, in combination with a permanent scraper to clean the roller during the movement of the machine, substantially as described. 3rd. A plough provided with a roller journalled in suitable bearings located between the landside and the mould board, interposed between the heel and shear, said roller projecting below the bottom of the landside and mould board, said bearings formed in rods secured to the plough handles, substantially as described.

No. 38,166. Car Axle Box Lid.

(*Couvercle de boîte à graisse.*)

Robert Soutter and Fred. A. Haines, both of Chicago, Illinois, U.S.A., 27th January, 1892; 5 years.

Claim.—1st. In a car axle box, a lid pivoted thereto at one end, and adapted to swing edgewise about said pivot to uncover the box,

a spring which is connected to the lid at one end only, at a point remote from the pivoted end of the lid toward the other end, said spring extending from its attachment to the lid toward and overhanging the pivoted end of the latter, and the pivot bolt passing through said overhanging end and adapted to flex the spring toward the lid to give it tension, substantially as set forth. 2nd. In a car axle box, a lid pivoted thereto at one end and adapted to swing edgewise about its pivot to uncover the box, the pivot bolt and a spring which is retained by the pivot bolt and bears and is laterally stopped on the lid at a point remote from the pivoted end toward the other end, substantially as set forth. 3rd. In a car axle box, a lid pivoted at one end to the box, and adapted to swing edgewise on its pivot to uncover the box, said lid having a transverse slot at a point remote from its pivoted end, and the flat bar spring adapted to be inserted through said slot from the upper side, and upon being tilted downward toward the pivoted end to bear at one side of the slot upon the under side of the lid, and at the other side of the slot upon the upper side of the lid, said spring when thus tilted extending toward and overhanging the pivoted end of the lid, and the pivot bolt passing through said overhanging end and adapted upon being tightened to flex the spring toward the lid, and by the tension thus produced to render the spring substantially rigid with the lid, but capable of being forced slightly longitudinally with respect thereto, substantially as set forth.

No. 38,167. Calendar. (Calendrier.)

David Ross, London, England, 30th January, 1892; 5 years.

Claim.—1st. A calendar rendered serviceable for an ordinary year by bringing the figure or figures denoting the century into a given relation with the figures denoting the year of the century, and thereby bringing the names of the months and the figures denoting the days of the month into such relation with the letters denoting the days of the week as to constitute the calendar for that year. 2nd. A calendar rendered serviceable for a leap year by bringing the figure or figures denoting the century into a given relation with one set of year figures for January and February and with a duplicate set for the remainder of the year, substantially as described. 3rd. A calendar rendered serviceable for a leap year by bringing the figure or figures denoting the century into a given relation with one set of year figures for January and February, and with a duplicate set for the remainder of the year, and thereby bringing the names of the months and the figures denoting the days of the month into such relation with the letters denoting the days of the week as to constitute the calendar for these respective periods of the given leap year. 4th. A calendar rendered serviceable for an ordinary year by bringing the century figures of figures into a given relation with the figures denoting the year of the century, and for a leap year by bringing the century figure or figures into relation with one set of year figures for January and February, and with another set for the remainder of the year, substantially as described. 5th. In a calendar, the combination with one set of century figures serving for the old style, of another set of century figures for the new style, substantially as described. 6th. In a calendar, the particular arrangement of the new style century figures whereby the three exceptional years in every four hundred which are not leap years, although multiples of 4, are provided for, substantially as described and illustrated in the accompanying drawings. 7th. In an adjustable calendar, the duplication of the leap-year "year figures," substantially as described and illustrated in the accompanying drawings. 8th. In a calendar, the old and new style table A, substantially as described and illustrated in the accompanying drawings, for the old style the century figures being consecutive from 0 to 6, in the second 7 to 13, and in the third 14 to 20; for the new style in the fourth line the figures 15 and 16 are placed in the fifth and sixth columns, and in the fifth line 17, 18, 19 and 20 are placed in the first, third, fifth and sixth columns respectively. 9th. In a calendar, the combination on one sheet of tables B and E, with the tables A, C and D on another sheet, the whole combined and arranged substantially as described and illustrated in the accompanying drawings. 10th. In a circular calendar, the combination on one sheet of tables A and E, with the tables B, C and D on another sheet, the whole combined and arranged, substantially as described and illustrated in the accompanying drawings.

No. 38,168. Bedstead. (Couchette.)

James Massie, Toronto, Ontario, Canada, 30th January, 1892; 5 years.

Claim.—1st. The combination, with the stiff frame of a bedstead, of a wire mattress secured to both sides and both ends of said bedstead frame, substantially as and for the purpose specified. 2nd. A wire mattress surrounded by and secured to a light frame, connected by a series of loops to the sides and ends of a rigid bedstead frame, substantially as and for the purpose specified. 3rd. A wire mattress surrounded by and secured to a light frame, which is connected by a series of loops to both sides and one end of the rigid bedstead frame, in combination with an end piece fastened to one end of the mattress, and adjustably connected to one end of the rigid bedstead frame, substantially as and for the purpose specified. 4th. A woven wire pillow E, secured to the end pieces F, which are supported by arms hinged to the end pieces and to the frame A, substantially as and for the purpose specified. 5th. A bedstead frame composed of two angularly shaped end pieces, each piece having a corner piece made integral with and at right angles to it, the said corner pieces

being shaped to receive and hold the side pieces of the bedstead frame, substantially as and for the purpose specified. 6th. A bracket piece P, having a dovetail side designed to fit into a dovetail recess made in the corner pieces a, and a collar b, made at the base of the said dovetail, in combination with the collar P, substantially as and for the purpose specified.

No. 38,169. Stone Cutting Machine.

(Machine à tailler la pierre.)

David Rettiger, Strong City, Kansas, U.S.A., 30th January, 1892; 5 years.

Claim.—1st. The combination, with a reciprocating car, a cog and gear mechanism for operating it, and a drive shaft for operating such mechanism, said shaft provided with a friction pulley G, of a set of friction pulleys H, H', arranged to engage the opposite sides of the pulley G and to be alternately thrown into or out of engagement with said pulleys, lever mechanism for forcing such wheels into frictional contact with the wheel G and arranged relatively, whereby the said pulley G is caused to slip and rebound slightly when the chisels strike flinty portions of the stone and great resistance is met, substantially as and for the purpose described. 2nd. The combination of the reciprocating car, rack and gear mechanism for operating it, a series of cylinders transversely of the car carrying chisels arranged tangentially, sprocket wheels on the shaft of the cylinders, the main drive shaft, chain connections between the shafts and sprockets, the tighteners d engaging said chains, and the friction pulley devices for operating the rack and gear mechanism of the car, all arranged substantially as shown and described. 3rd. The combination of the cutting cylinders having their shafts provided with sprocket wheels, the drive shaft, the chain connections between the drive shaft and sprocket wheels, and the tighteners d, having toothed wheels pressing against the said chain connections, all substantially as and for the purposes set forth.

No. 38,170. Armature for Dynamo Electric Machines and Motors. (Armature pour machines dynamo-électriques et moteurs.)

The Reliance Electric Manufacturing Company, Waterford, Ontario, Canada, assignees of Frank Banson Rae, Detroit, Michigan, U.S.A., 30th January, 1892; 5 years.

Claim.—1st. An armature consisting of a shaft having recesses in which are secured the non-magnetic splines, disks, having notches fitting said splines, end plates also having notches, fitting the splines, and nuts mounted on the shaft and fitting recesses in the end plates, substantially as described. 2nd. An armature, consisting of a shaft having longitudinal recesses, splines of non-conducting material secured in said recesses, disks of magnetic material mounted on the splines, end plates of non-magnetic material also mounted on the splines, and nuts screwed upon the shaft and fitting recesses in the end plates, substantially as described.

No. 38,171. Accompanying Methods for Musical Instruments having Key Boards. (Méthode d'accompagnement pour instruments de musique à clavier.)

George Philippe Omer Hereux, Yamachiche, Quebec, Canada, 30th January, 1892; 5 years.

Claim.—A new accompanying method for musical instruments having key boards, composed of the rod A, having any suitable number of sides on to which are marked different accompaniments by means of points c, c, c, etc., and one of its ends provided with a disk a, having the key of the rod A marked thereon.

No. 38,172. Rod and Pipe Cutter.

(Decoupoir à barre et tuyau.)

Henry Diebel, Sauk Centre, Minnesota, U.S.A., 30th January, 1892; 5 years.

Claim.—1st. In a cutting and threading tool, the combination with the stock having central openings a, and having grooves c and i on diametrically opposite sides of the said opening a, of the cutter fitted in one groove, means for adjusting the cutter in the said groove, and the handle secured in the other groove and having its inner end flush with the said opening a and adopted to receive the thrust or working pressure, substantially as set forth. 2nd. A cutting and threading tool comprising the stock having opening a, grooves c and i on diametrically opposite sides of the said opening, and having recess H in its rear side, the guide section having its flanged end inserted in the said recess H and held therein by plates h, the cutter B in the groove c, the set screw C for adjusting cutter B, and the handle I, secured in the groove i and having its inner end extended flush with opening a and adapted to receive the thrust, substantially as specified.

No. 38,173. Swinging Chair. (Chaise oscillante.)

Julius M. Eller, Cleburne, Texas, U.S.A., 30th January, 1892; 5 years.

Claim.—1st. The combination with a chair of the cross bar secured to the forward under side of the seat, the suspending ropes secured at one end to the opposite ends of said cross bars the rope secured to the rear side of the seat, and the propulsion spring secured to the opposite end of said rope, substantially as specified. 2nd. The combination with a chair seat of suspending ropes attached at their lower ends to the opposite forward sides of the seat, a rope secured to the rear side of the seat, and a spiral or coiled spring secured to the opposite end of said rope, substantially as specified.

CERTIFICATES OF THE PAYMENT OF FEES FOR FURTHER TERMS HAVE BEEN ATTACHED TO THE FOLLOWING PATENTS.

2432. WILLIAM STAHLSCHEIDT & COMPANY (assignees), 2nd five years of No. 26,612, from the 6th day of May, 1892. Improvements in Opera Chairs, 5th January, 1892.
2433. GEO. P. D. LOWRIE, 2nd five years of No. 25,693, from the 11th day of January, 1892. Improvements in Cylindrical Wooden Packages, 9th January, 1892.
2434. JAMES CRUICKSHANK, 3rd five years of No. 13,975, from the 11th day of January, 1892. Improvements on Waggon, 9th January, 1892.
2435. WILLIAM B. DUNNING, 2nd five years of No. 25,708, from the 12th day of January, 1892. Improvements in Base Burning Boilers for Steam Heating, 9th January, 1892.
2436. WILLIAM GREEY and J. G. GREEY, 3rd five years of No. 14,034, from the 19th day of January, 1892. Improvements on Machines for Collecting Dust in Flour Mills, 9th January, 1892.
2437. BERNARD CHARLES MALLOY, 2nd five years of No. 25,806, from the 19th day of January, 1892. Improvements in Apparatus for Amalgamating Gold and other Precious Metals, 9th January, 1892.
2438. WILLIAM EDWIN HOWARTH, 3rd five years of No. 13,978, from the 11th day of January, 1892. Improvements on Combined Fanning Mills and Grain Separators, 11th January, 1892.
2439. JACOB GARNER GERMAN, 3rd five years of No. 14,093, from the 30th day of January, 1892. Improvements in Wrought Iron Fences, 12th January, 1892.
2440. MASTERMAN AUTOMATIC BRAKE EQUALIZER COMPANY (assignees), 2nd five years of No. 25,713, from the 13th day of January, 1892. Improvements in Car Brakes, 13th January, 1892.
2441. MARK B. TRUE, 2nd five years of No. 25,727, from the 13th day of January, 1892. Improvements in Mechanical Movements, 13th January, 1892.
2442. EDWARD SELDEN TOWNSEND KENNEDY, 2nd five years of No. 25,917, from the 4th day of February, 1892. Improvements in Flame Deflectors for Upright Boilers, 14th January, 1892.
2443. ROSWELL H. SMITH, 3rd five years of No. 13,987, from the 16th day of January, 1892. Improvements on Hanging Open Back Saws for different uses, 14th January, 1892.
2444. MOIETZ IMMISCH, 3rd five years of No. 26,030, from the 17th day of February, 1892. Improvements in Electro Motors and Dynamo Machines, 14th January, 1892.
2445. MASSEY MANUFACTURING COMPANY (assignees), 2nd five years of No. 25,759, from the 17th day of January, 1892. Improvements in Harvesters, 15th January, 1892.
2446. MASSEY MANUFACTURING COMPANY (assignees), 2nd five years of No. 25,775, from the 17th day of January, 1892. Improvements in Knotting Devices for Grain Binders in the Automatic Binding of Sheaves of Grain, 15th January, 1892.
2447. FRANK HOWARD RANSOM, 3rd five years of No. 13,997, from the 16th day of January, 1892. Improvements on Trunks, 15th January, 1892.
2448. JOHN HENRY GROUT, 2nd five years of No. 25,790, from the 18th day of January, 1892. Improvements in Sulky Plows, 16th January, 1892.
2449. GEORGE PIRNIE, 2nd five years of No. 28,398, from the 20th day of January, 1892. Improvements in Whips, 19th January, 1892.
2450. WILLIAM ALLEN LAWRENCE, 2nd five years of No. 25,838, from the 24th day of January, 1892. Improvements in Combination Locks, 20th January, 1892.
2451. CHARLES JAMES SHIRREFF, 2nd five years of No. 25,828, from the 24th day of January, 1892. Improvements in Mangles, 21st January, 1892.
2452. STEPHEN STIGER, 2nd five years of No. 25,940, from the 7th day of February, 1892. Improvements in Scales, 21st January, 1892.
2453. DARWIN ALANSON GREENE, 2nd five years of No. 25,905, from the 2nd day of February, 1892. Improvements in Sawing Machines, 21st January, 1892.
2454. BELL TELEPHONE COMPANY (assignees), 3rd five years of No. 14,454, from the 21st day of March, 1892. Improvements in Contact or Microphone Telephones, 22nd January, 1892.
2455. SAMUEL WOLCOTT PARSONS, 2nd five years of No. 25,832, from the 24th day of January, 1892. Improvements in Washing Machines, 23rd January, 1892.
2456. JEAN SCHERBEL, 2nd and 3rd five years of No. 25,955, from the 9th day of February, 1892. Improvements on the Manufacture of Boxes and other Articles of Cardboard, Wood, Leather and the like, in Clamps of Fittings for the Corners and Edges of the same, and apparatus connected therewith, 25th January, 1892.
2457. GEORGE D. POHL, 2nd five years of No. 25,873, from the 28th day of January, 1892. Improvements in Self Salting Curd Mills, 25th January, 1892.
2458. GEORGE W. CANNON, 2nd five years of No. 26,746, from the 18th day of May, 1892. Improvements in Dumb Waiters, 26th January, 1892.
2459. ISRAEL KINNEY, 2nd five years of No. 25,866, from the 27th day of January, 1892. Improved Metal Fabrics, 26th January, 1892.
2460. DONALD LIVINGSTONE and MARSHAL L. NUTTING, 2nd five years of No. 25,851, from the 26th day of January, 1892. Machine for Cutting the Bands of Sheaves of Grain and Feeding the same to Threshing Machines, 26th January, 1892.
2461. HENRY BURNHAM WILLS, CHARLES EDWARD RAPSON and HENRY AUGUSTINE BIGGINS, 2nd five years of No. 26,062, from the 25th day of February, 1892. Improvements in Machines for Ornamenting Wood, 26th January, 1892.
2462. EDWIN HERBERT CLARE, 2nd five years of No. 25,901, from the 2nd day of February, 1892. Improvements in Root Cutters for Slicing Turnips, &c., 28th of January, 1892.
2463. WYCKOFF SEAMANS and BENEDICT (assignees), 2nd five years of No. 26,102, from the 28th day of February, 1892. Improvements in Cabinets or Cases for Typewriters, 28th January, 1892.
2464. EBENEZER BAKER WELCH, 2nd five years of No. 25,885, from the 29th day of January, 1892. Improvements in Trimming Mechanism for Sewing Machines, 28th January, 1892.
2465. WILLIAM ROBERT HARTIGAN, 2nd five years of No. 25,897, from the first day of February, 1892. Improvements in Egg Openers, 28th January, 1892.
2466. NATHAN MANUFACTURING COMPANY (assignees), 2nd five years of No. 26,380, from the 4th day of April, 1892. Improvements in Lubricators for use on Locomotives, &c., 28th January, 1892.
2467. ORRIS HUBERT WARREN, 2nd five years of No. 25,946, from the 8th day of February, 1892. Improvements in Oil Cans, 30th January, 1892.

JANUARY LIST OF TRADE MARKS.

Registered at the Department of Agriculture--Copyright and Trade Mark Branch.

4222. ASPINWALL MANUFACTURING COMPANY, of Three Rivers, Michigan, U.S.A. Agricultural Implements, such as Potatoe Planters, Diggers and Corn Planters, 2nd January, 1892.
4223. DOUGLAS, BROTHER & CO., of Tamworth, Addington County, Ont. Liniment, 2nd January, 1892.
4224. THE METALLIC ROOFING COMPANY OF CANADA, LTD, Toronto, Ont. Sheet Metal Plates, 7th January, 1892.
4225. THE PYN KA SYNDICATE, LTD, of Liverpool, England. All kinds of Polishing and Cleaning Preparations and Materials, 7th January, 1892.
4226. SIEGFRIED AND BRANDENSTEIN, of San Francisco, California, U.S.A. Tea, 11th January, 1892.
4227. THE INDEPENDENT MATCH CO, de Louiseville, Qué. Allumettes chimiques, 13 janvier, 1892.
4228. WILLIAM ANDREWS COLLINS, of Montreal, Qué. Medicinal Preparation, 19th January, 1892.
4229. WHALEY, ROYCE & CO., of Toronto, Ont. Band Instruments and Accordeons, 23rd January, 1892.
4230. THE CARTER MEDICINE COMPANY, of New York, N.Y., U.S.A. Pills, 25th January, 1892.
4231. MÜLLER, PHILIPP & COMPANY, of Marienbad, Bohemia, Austria-Hungary. Medicinal Tablets, containing Salts obtained from the Springs of Marienbad, 27th January, 1892.

COPYRIGHTS.

Entered during the month of January, 1892, at the Department of Agriculture—

Copyright and Trade Mark Branch,

6260. THE "RECORDER" MAP OF THE TOWNSHIP OF YORK, shewing the boundaries of the Public School Sections and Local Municipalities, also of the East Half of the Township of Etobicoke, 1892. Scale, $3\frac{1}{4}$ inches=1 mile. Allen & Co., Toronto, Ont., 2nd January, 1892.
6261. WEEKLY HOUSEHOLD EXPENSE BOOK. Williamson & Co., Toronto, Ont., 2nd January, 1892.
6262. SCALE EIGHT FEET TO ONE INCH } échelles { avec toutes les subdivi-
6263. SCALE FOUR FEET TO ONE INCH } échelles { sions du pouce ang-
lais en fractions diverses et uniformes. John Esinhart, Montréal, Qué., 2 janvier, 1892.
6264. STROUD'S PICTORIAL CALENDAR, 1892. W. D. Stroud & Sons, Montreal, Que., 4th January, 1892.
6265. MAGGIE MURPHY'S WALTZ, arranged by E. Corlett. W. H. Billing, Toronto, Ont., 7th January, 1892.
6266. COWPER, by Goldwin Smith. English Men of Letters. Macmillan & Co., London, England, 7th January, 1892.
6267. IN THE HANDS OF THE ENEMY. Painted by James Hovenden (engraving). The Mail Printing Co., L'd, Toronto, Ont., 8th January, 1892.
6268. FLOWER SONG (Rosenlied) for piano, by Charles Morley. Op. 60.
6269. L'AIDE-DE-CAMP. Morceau Militaire, pour piano, par Victor Delacour.
6270. MARGUERITE. No. 1 of Album Leaves, for piano, by F. X. Chwatal. The Anglo-Canadian Music Publishers' Association, L'd, London, England, 3th January, 1892.
6271. LIFE OF THE RIGHT HONOURABLE SIR JOHN A. MACDONALD, G.C.B., &c., &c., by his nephew, Lt.-Col. J. P. Macpherson, A.D.C. (in two vols.), Ottawa, Ont., 8th January, 1892.
6272. THE CANADIAN ALBUM. Men of Canana; or, Success by Example. Vol. I. Edited by Rev. Wm. Cochrane, D.D. Thos. S. Linscott, Brantford, Ont., 9th January, 1892.
6273. PARLIAMENTARY PROCEDURE AND PRACTICE. With a Review of the Origin, Growth and Operation of Parliamentary Institutions in the Dominion of Canada. By John George Bourinot. Second Edition. Revised and Enlarged. Ottawa, Ont., 11th January, 1892.
6274. MARCHE DES TAMBOURS. Morceau Militaire, par Sydney Smith. The Anglo-Canadian Music Publishers' Association, L'd, London, England, 12th January, 1892.
6275. BELL TELEPHONE COMPANY OF CANADA, WESTERN EXCHANGES, SUBSCRIBERS' DIRECTORY, ONTARIO DEPARTMENT, DECEMBER, 1891. Bell Telephone Company of Canada, Montreal, Que., 14th January, 1892.
6276. LA SERENATA DE BRAGA. Op. 222. Transcrite pour piano, par Sydney Smith. The Anglo-Canadian Music Publishers' Association, L'd, London, England, 14th January, 1892.
6277. CHAPTERS IN THE HISTORY OF ORANGEISM, which are now being preliminarily published in separate articles in "The Sentinel and Orange and Protestant Advocate," Toronto, Ont. (Temporary Copyright.) Richard Lilburn, Belfast, Ireland, 15th January, 1892.
6278. SLEEP THOU, MY SON! Sacred Song. Words and Music by M. Piccolomini. Chappell & Co., London, England, 15th January, 1892.
6279. PAS DE QUATRE. Skirt Dance, for the piano, from the Opera Burlesque Faust up to Date, by Meyer Lutz. I. Suckling & Sons, Toronto, Ont., 15th January, 1892.

6280. FETE HONGROISE. Mazurka Elegante, pour piano. Op. 43, par Sydney Smith. The Anglo-Canadian Music Publishers' Association, L'd, London, England, 15th January, 1892.
6281. WOULDN'T IT BE NICE. Topical Song. Words by James Fax. Music by Chas. Bohmer. Whaley, Royce & Co., Toronto, Ont., 16th January, 1892.
6282. HOUSEKEEPERS' WEEKLY CASH BOOK. Francis Jeffrey, Toronto, Ont., 16th January, 1892.
6283. A COUNTRY RAMBLE POLKA, by P. Bucalossi. Chappell & Co., London, England, 18th January, 1892.
6284. A WORD BOOK TO THE STUDENTS OF ENGLISH HISTORY, by Rev. John de Soyres, M.A. Second Edition. Revised and Enlarged. St. John, N.B., 19th January, 1892.
6285. PRINCE IMPERIAL GALOP, for piano, by Chas. Coote. I. Suckling & Sons, Toronto, Ont., 20th January, 1892.
6286. HEATHER AND HAREBELL. Songs and Lyrics, by John MacFarlane. Wm. Drysdale & Co., Montreal, Que., 20th January, 1892.
6287. THE EXPERT ACCOUNTANT'S SYSTEM OF BALANCING BOOKS OF ACCOUNTS, by Keltie & Beck. David Keltie and John Alexander Beck, Hamilton, Ont., 20th January, 1892.
6288. YOUNG MEN, ARISE! Words by Julia A. Johnston. Music by James McGranahan. D. A. Budge, Montreal, Que., 21st January, 1892.
6289. TRIUMPHANT SONGS, NO. 3, by E. O. Excell. Wm. Briggs, Toronto, Ont., 25th January, 1892.
6290. EVENTIDE. Waltz. By James Campbell. George J. Sheppard, Montreal, Que., 27th January, 1892.
6291. ADIEU! Melodie pour piano, par Sydney Smith. Op. 114.
6292. BY THE GOLDEN RIVER. Song. Words by Clifton Bingham. Music by F. Boscovitz.
6293. FAUST. Fantaisie brillante sur l'opera de Gounod, pour piano, par Sydney Smith. Op. 117.
6294. PAROLES DU CŒUR. Andantino pour piano, par Victor Delacour.
6295. SALAMMBO. Waltz. By Poppewell Royle. The Anglo-Canadian Music Publishers' Association, L'd, London, England, 27th January, 1892.
6296. PERPETUAL READY REFERENCE GUIDE TO THE STATUTES OF CANADA, viz.: The Revised Statutes of 1886, and all subsequent amending, repealing, cognate and new Acts. Compiled by Fred. K. Blatch, Ottawa, Ont., 27th January, 1892.
6297. THE MERCHANTS' AND MANUFACTURERS' CREDIT SYSTEM BOOK. (Forms.) The Toronto Blank Form Co., Toronto, Ont., 29th January, 1892.

THE
CANADIAN PATENT OFFICE RECORD.

ILLUSTRATIONS.

Vol. XX.

JANUARY, 1892.

No. 1.

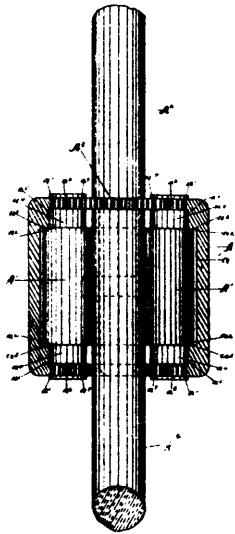

38025 Stilson's Shaft and Journal Box.

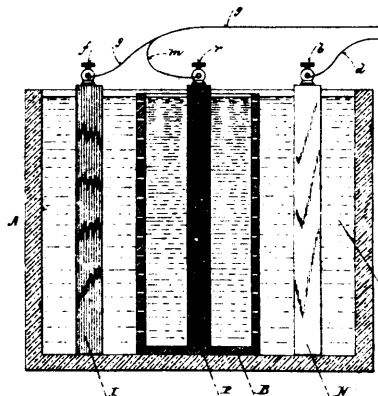

38026 Richards and James' Electric Battery.



38027 Gray's Spoon.

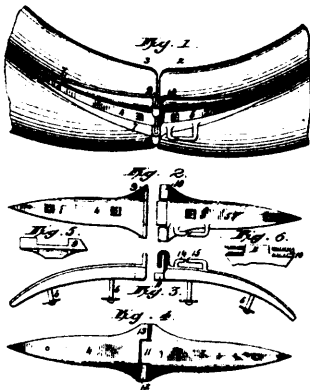

38028 Kickenapp's Collar Fastener.

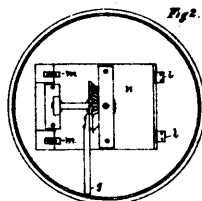
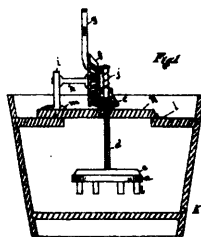

38029 Champion's Washing Machine.

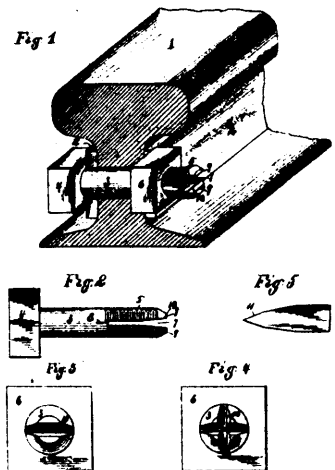

38030 Walker's Nut Lock.

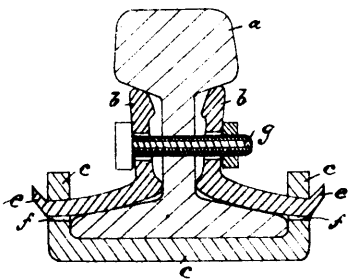

33031 Eno's Railway Joint.

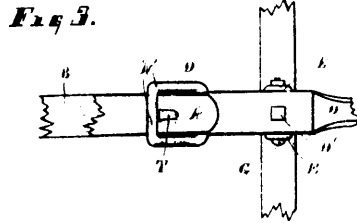

33032 Atkinson's Vehicle Spring.

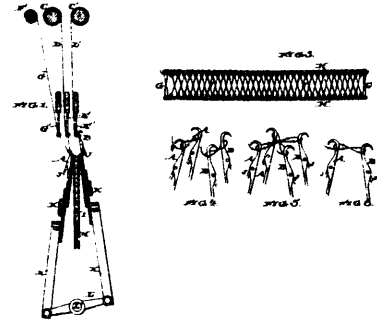

33033 Clewley and McGill's Knitted Bag.

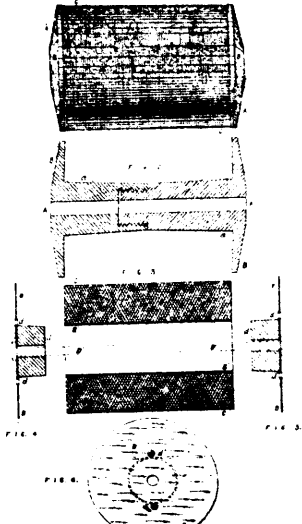

33034 Haynes and Wilcock's Spool for Yarn, etc.

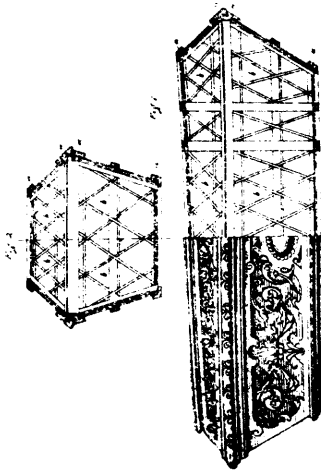

33035 Mueller and Stader's Coffin.

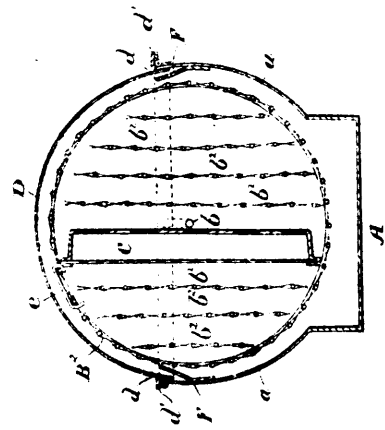

33036 Davis' Dish Washer.

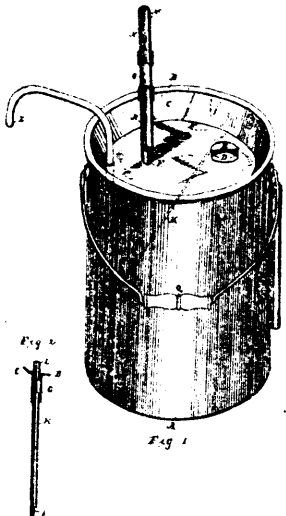

33037 Garland's Can for Petroleum.

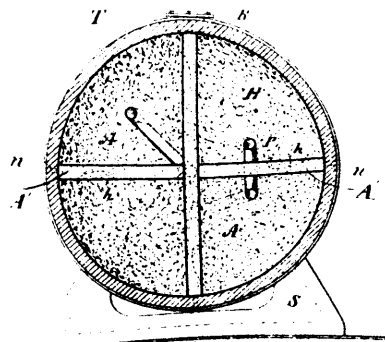

33038 Hasbrouck's Apparatus for Ageing Liquors.

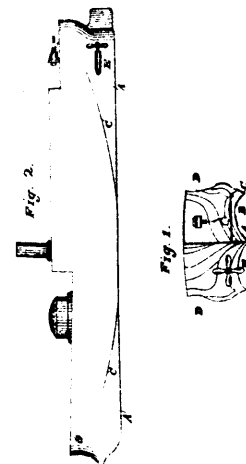

33039 Hodgett's Art of Constructing the Hulls of Iron-clads and Other Vessels.

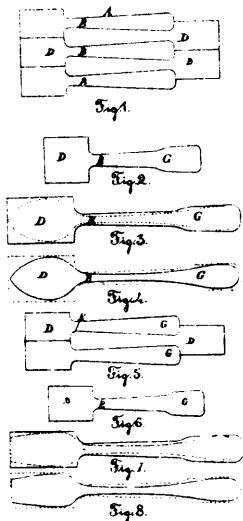

33040 Hart's Spoon and Fork.

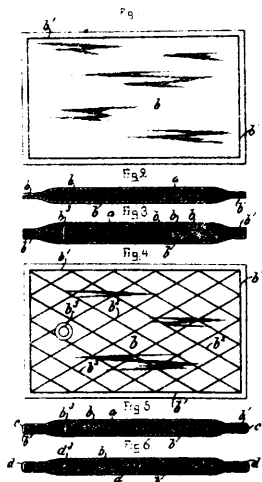

33042 Roger's Pad for Electric Cells.

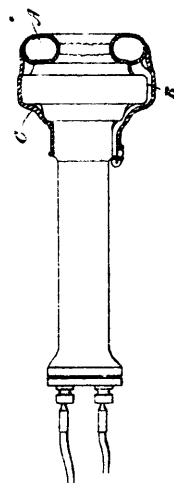

33043 Gross' Telephone Receiver.

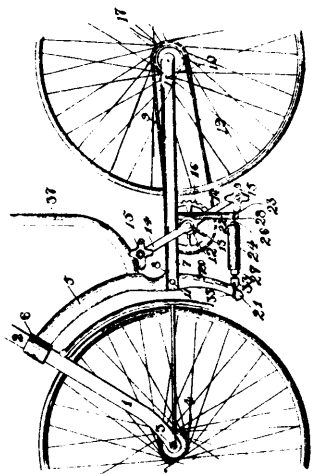

33044 Mathew's Bicycle.

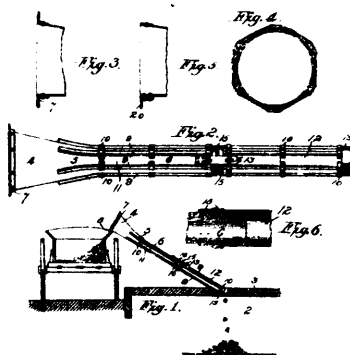

33045 Emery's Chute for Grain and Coal.

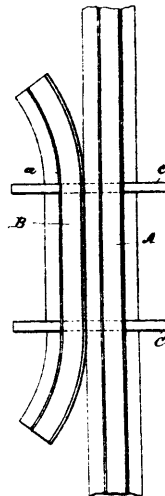

33046 Smith and Blackwell's Device for Securing Guard Rails in Place.

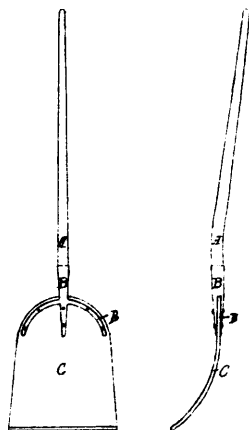

33047 Still's Wooden Shovel.

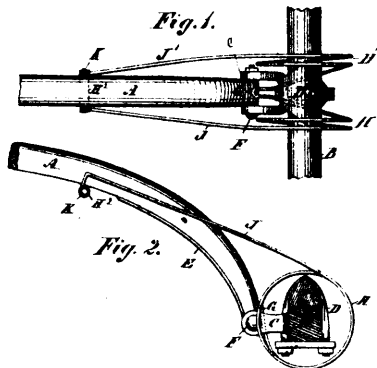

33048 Fletcher's Thill Support.

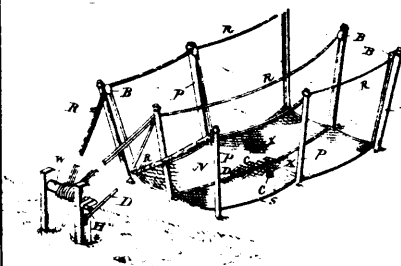

33049 Jones' Fishing Seine.

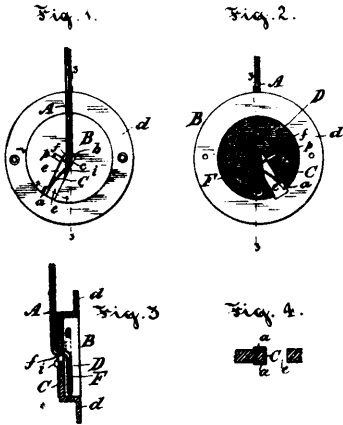

38050 Lusk's Bail and Bar for Pails, etc.

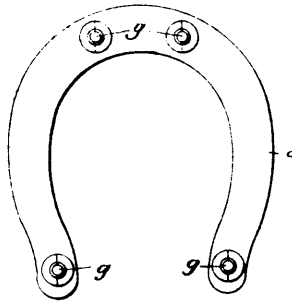

38051 Higgins' Horseshoe Calk.

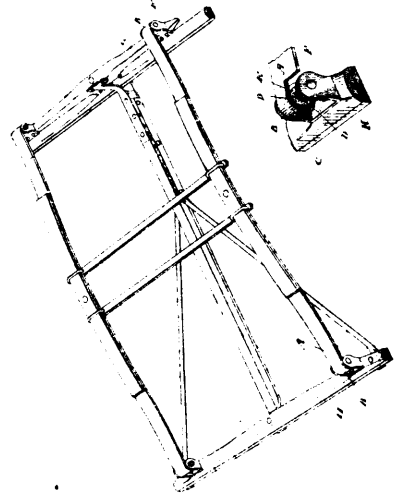

38052 McLaughlin's Carriage Gear.

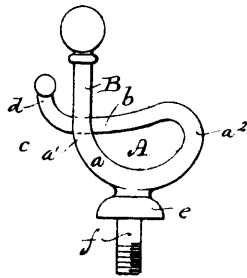

38053 Lobdell's Check Hook.

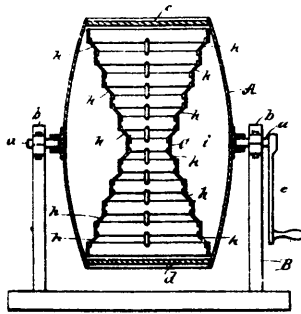

38054 Mark's Churn.

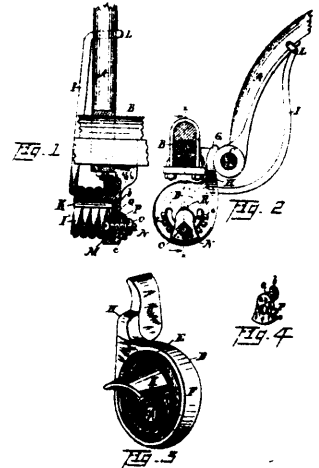

38055 Bishop and Miller's Shaft Support and Anti-Rattler.

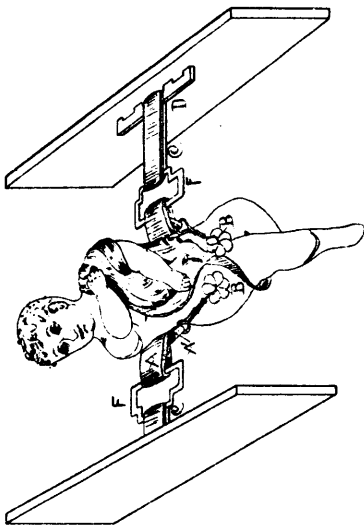

38056 Kangler's Holder for Bed Clothes and Babies.

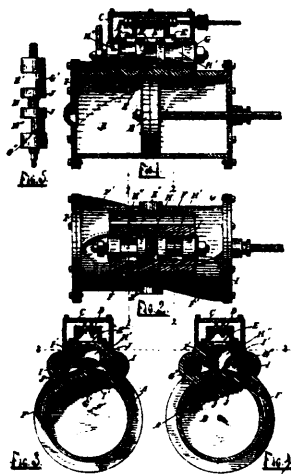

38058 Fraser and Cosford's Reversing Gear for Steam Engines.

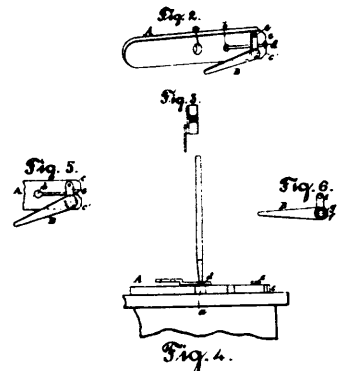

38059 Cunningham's Jewel Holder.

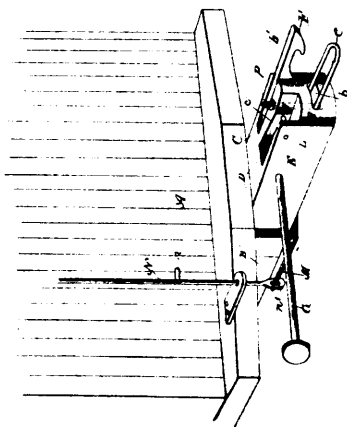

38060 Kirby's Car Coupler.

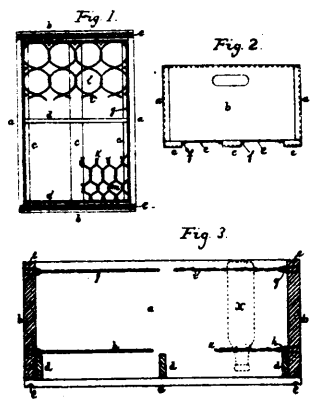

38061 Marlow's Bottle Case.

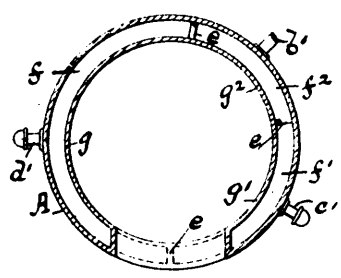

38062 Dwinnell's Hot Water Heater.

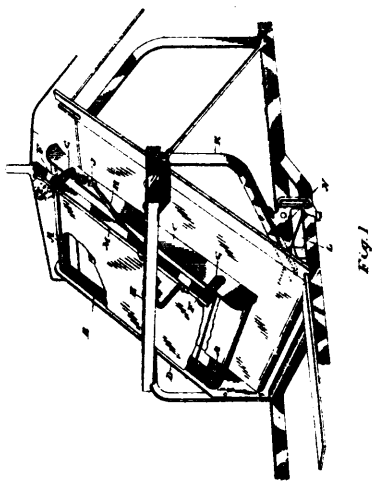

38063 Jones and Wedlake's Harvester Binder.

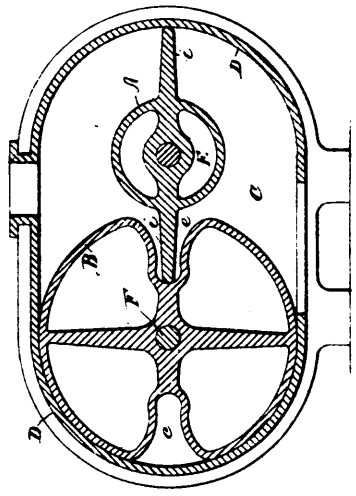

38064 Johnson's Rotary Engine, Blower, Pump and Water Meter.

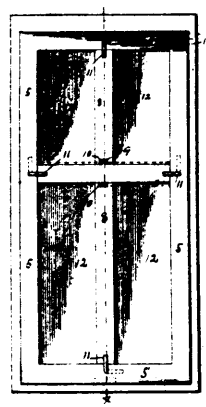

38065 Lyle's Screen Door.

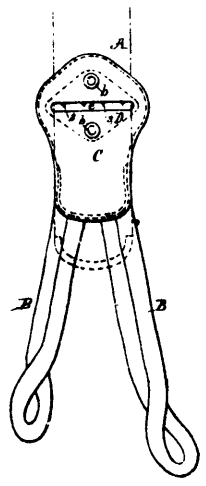

38066 Lieberthal's Suspender.

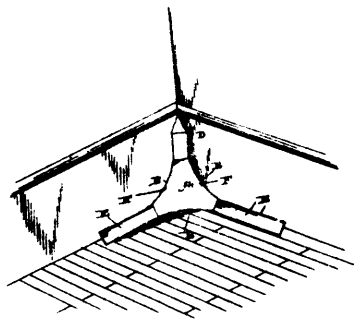

38067 Rockwell's Corner Shield and Protector.

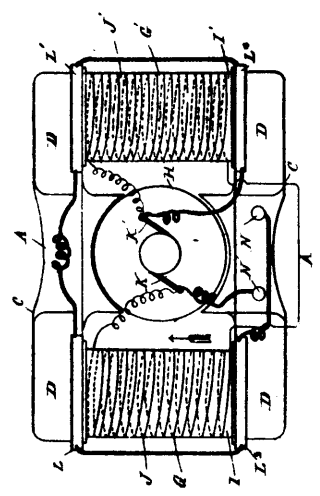

38068 Rae's Dynamo Electric Machine.

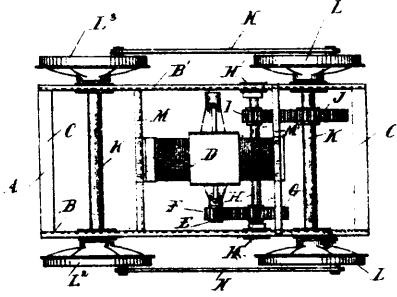

33066 Rae's Motor Truck for Electrically Propelled Vehicle.

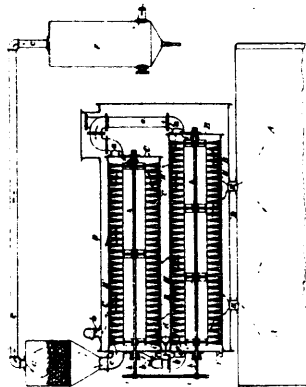

33070 Frasch's Apparatus for Refining Petroleum.

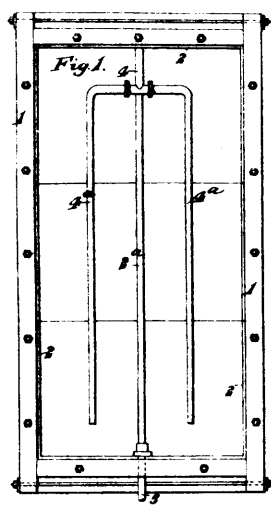

33073 Raabe's Treatment of Vegetable Textile Fibres for the Manufacture of Yarns and Fabrics.

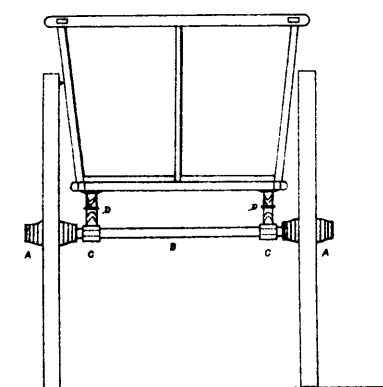

33072 Farquhar's Vehicle.

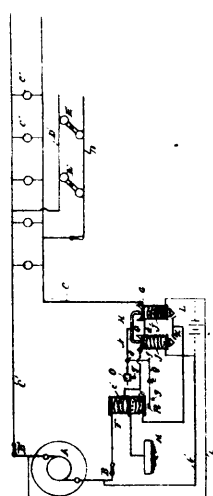

33074 Rae's Electrical Cut Out.

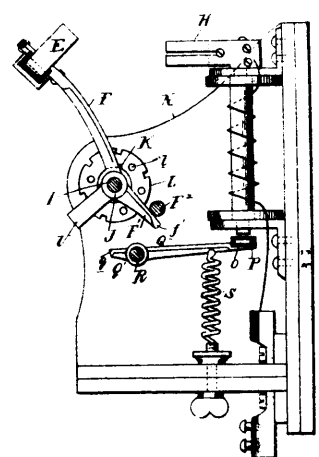

33075 Rae's Limit Switch.

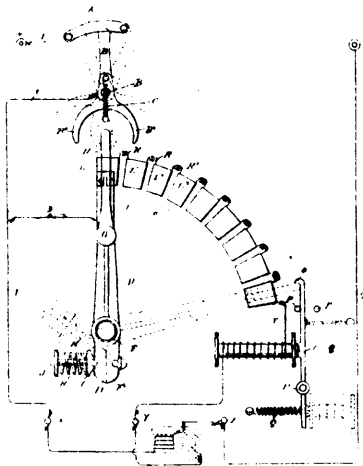

33076 Rae's Switch for Stationary Motors.

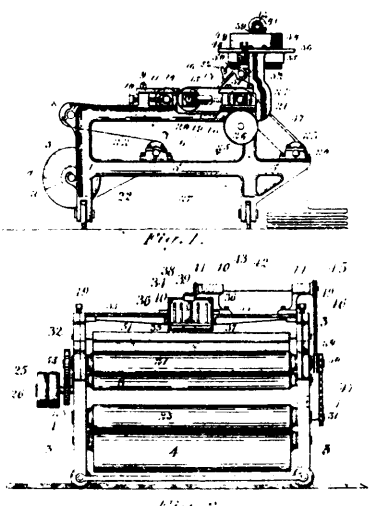

33077 Armitage's Painting Machine.

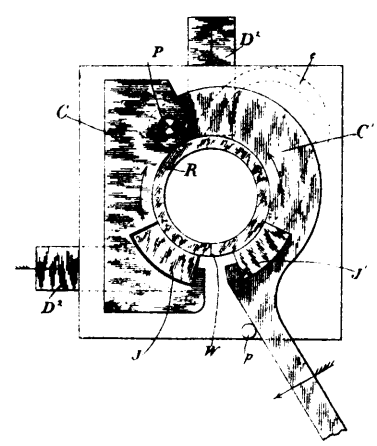

33078 Lemp's Method of Welding Rings by Electricity.

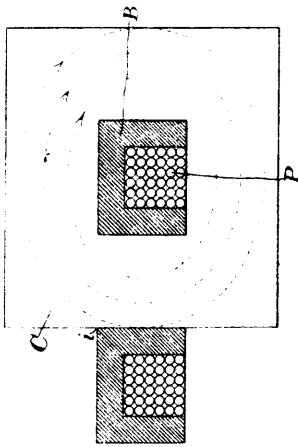

38079 Lemp's Transformer for Heavy Currents.

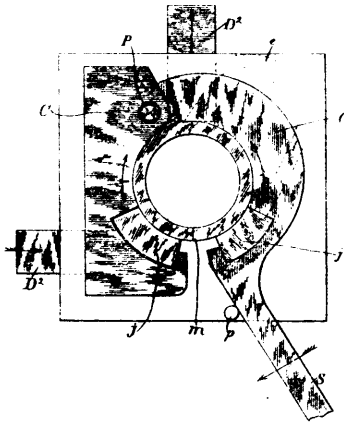

38080 Lemp's Electrical Apparatus for Welding Rings.

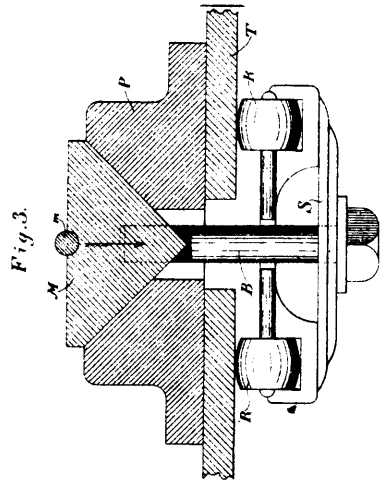

38081 Lemp's Sliding Clamp for Electric Welding Apparatus.

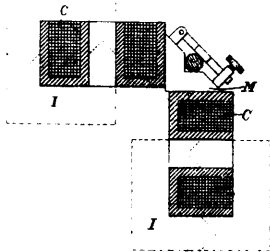

38082 Lemp's Electric Welding Apparatus.

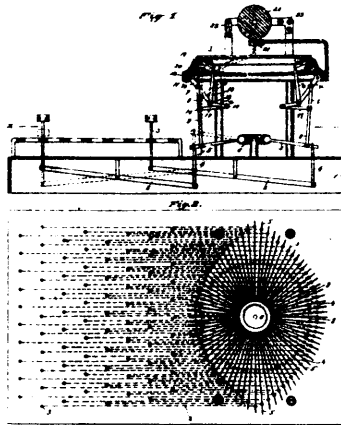

38083 Felbel and Steiger's Type Writing Machine.

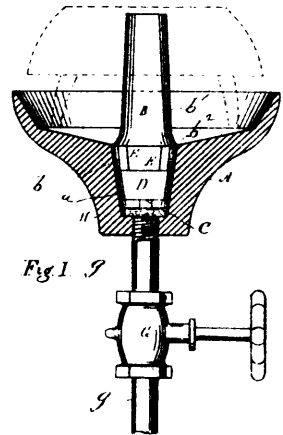

38084 Willi's Burner for Crude Oil.

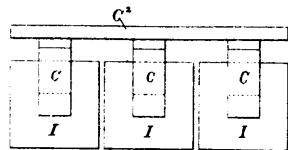

38085 Still's Copy Holder for Typewriters.

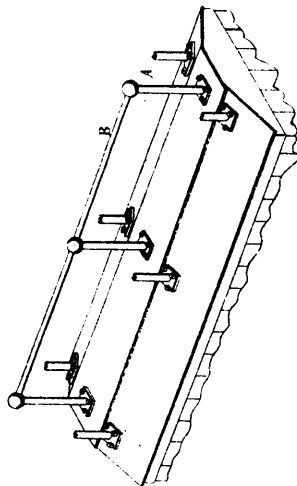

38086 Sullivan's Guide Rod for the Tops of Freight Cars.

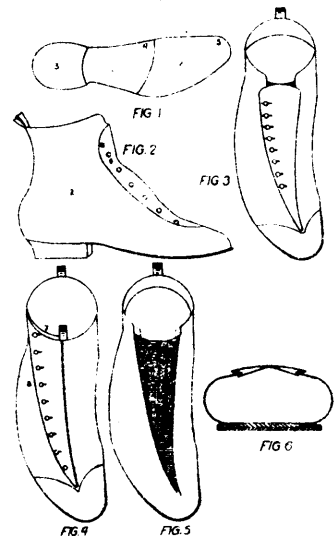

38087 Hood's Boot and Shoe.

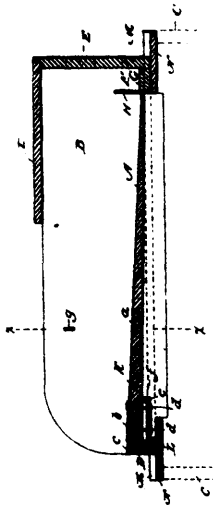

33088 Jenne's Trap for Animals.

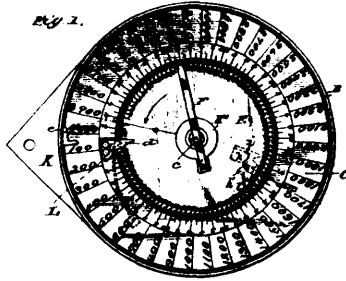

33089 Blackshaw and Rogers' Adding Machine.

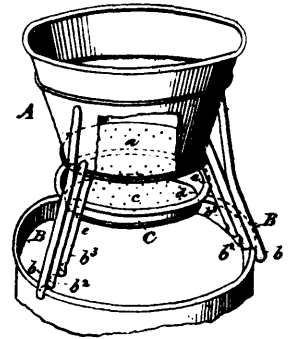

33090 Macy's Aerator for Milk.

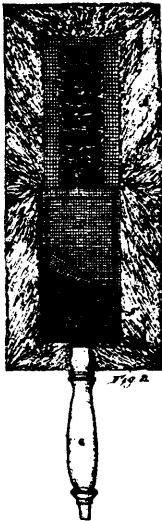

33091 Hair's Duster.

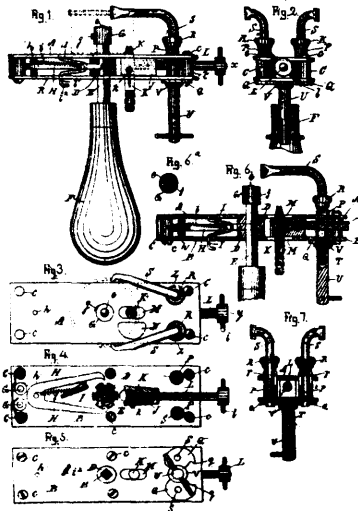

33092 Vaughan's Mainspring Winder.

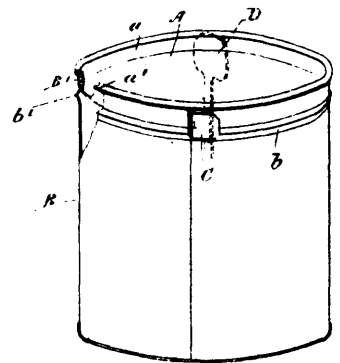

33093 Pratt's Tin Can.

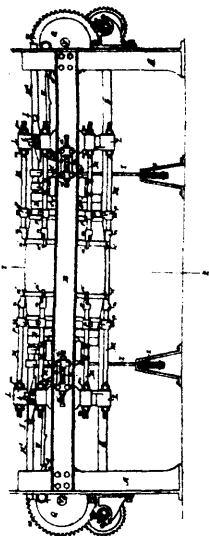

33094 Parker's Barrell Setting Up Machine.

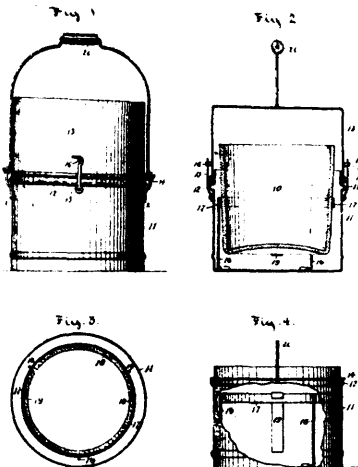

33095 Kneeland's Package for Shipping and Preserving Butter, &c.

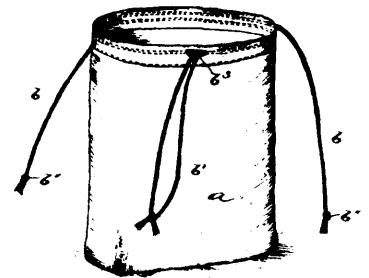

33097 Cussen's Tobacco Pouch.

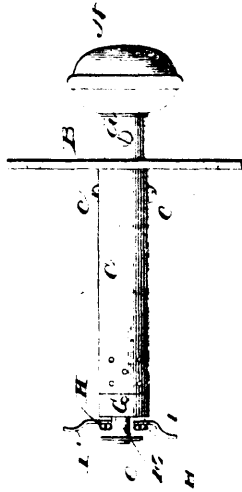

38098 Cleveland's Electrical Door Bell Pull.

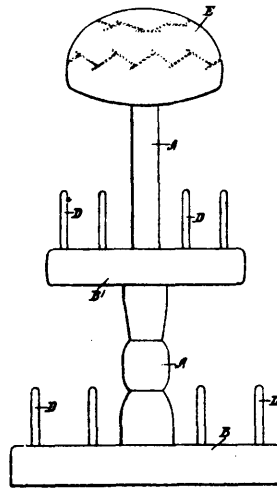

38099 Browlaugh's Spool Holder and Needle Cushion.

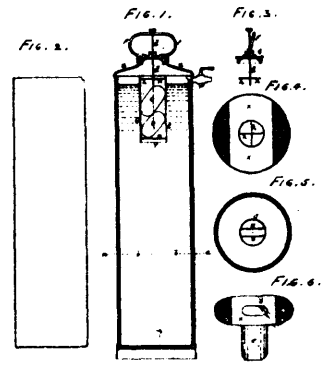

38100 Patton's Chemical Fire Engine.

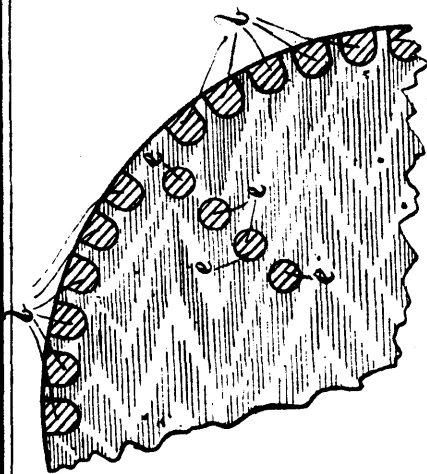

38103 McCrossan's Washing Machine.

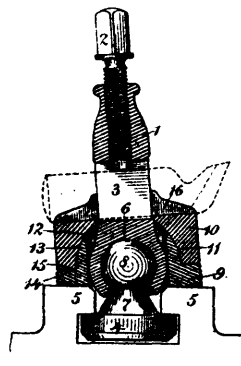

38104 Ronan's Tool Holder.

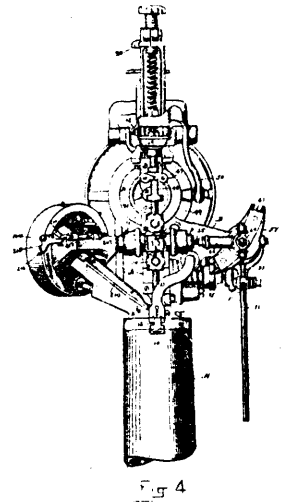

38105 Gooding and Ladd's Lasting Machine.

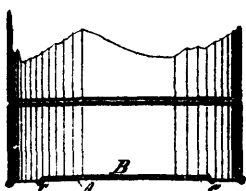

Fig. 2

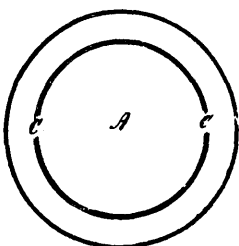
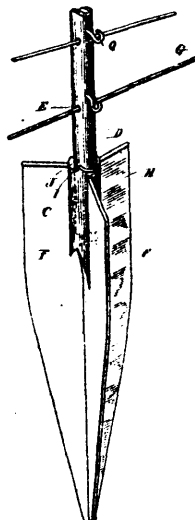
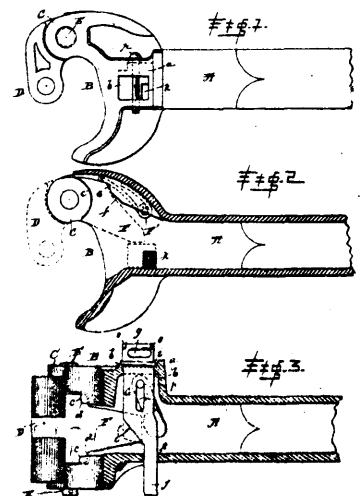

Fig. 1

38106 King's Tinware Vessels.



38108 Weienett's Fence Post.



38109 Hinson's Car Coupler.

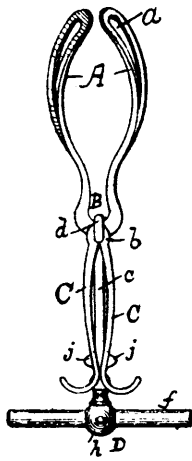

38110 Lyman's Tractor for Obstetric Forceps.

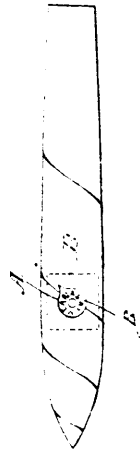

38111 Ascano-Y-Meana's Means for Preventing Fraud in the Sale of Cigars.

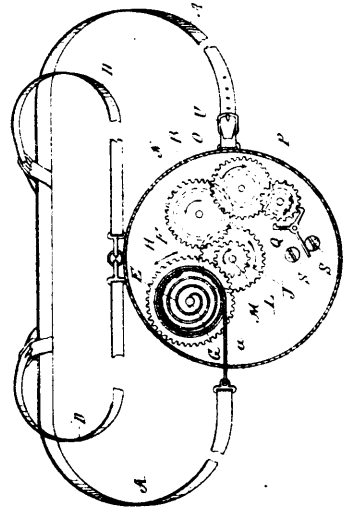

38112 Davis' Device for Inducing full Respiration.

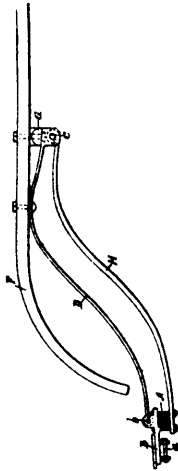

38113 Woods' Road Cart.

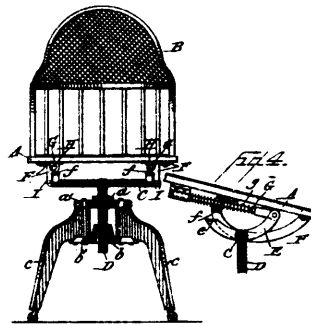

38114 Gage and Herrick's Chair.

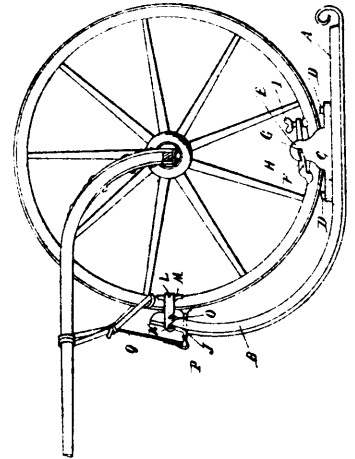

38115 Blankart's Sleigh Runner for Vehicles.



38116 Merrill's Railway Surface Cattle Guard.

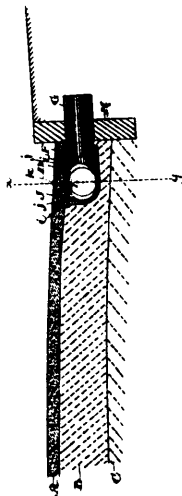

38117 Wright's Method of Laying Electrical Conduits

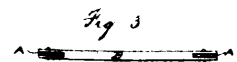
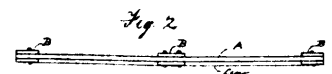
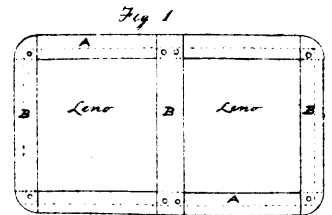

38118 Williams' Cover for Fruit Baskets.

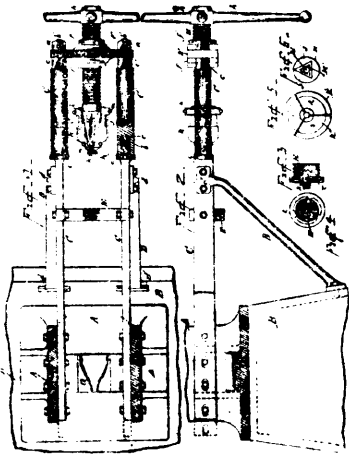

38119 Kennedy's Machine for Swaging the Ends of Metal Tubes

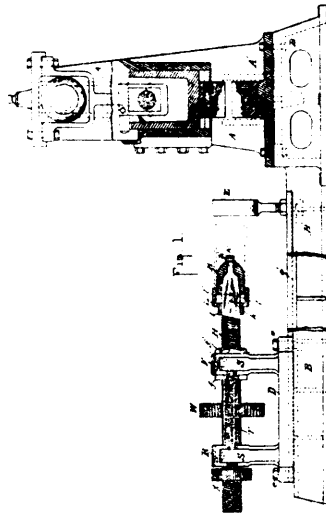

38120 Kennedy's Machine for Swaging the Ends of Metal Tubes.



38121 Beer's Weather Strip.

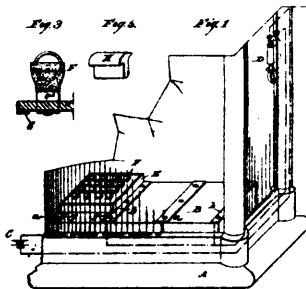

38122 Kruschke's Electric Shoe Casw Alarm.

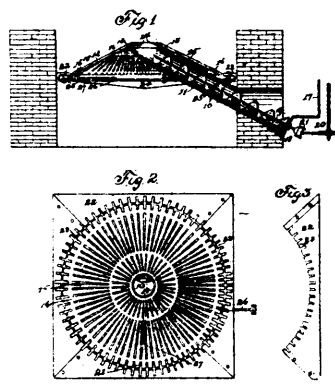

38123 Brown's Complete Combustion Mechanism.

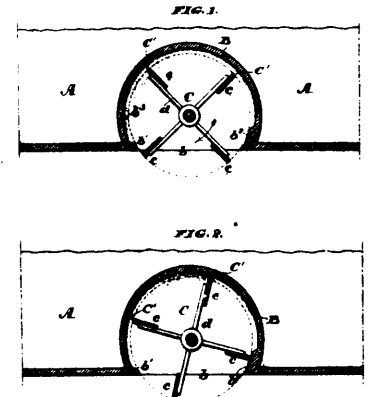

38124 Wigmore's Ship Propeller.

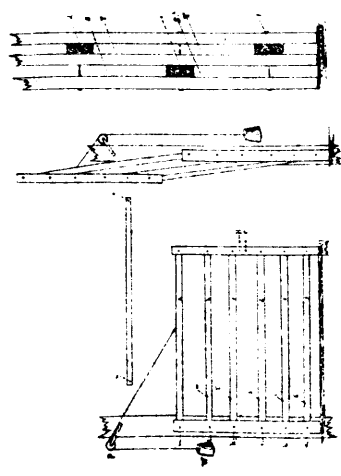

38125 Shoebottom's Gate.

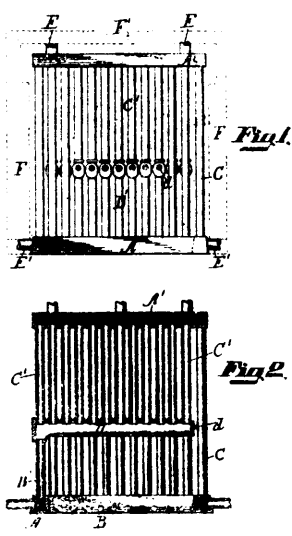

38126 Moust's Water Heater.

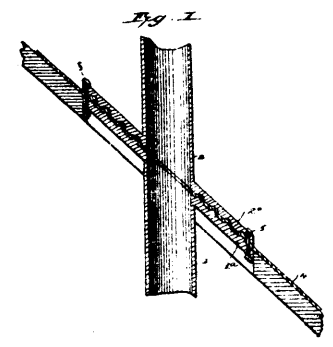

38127 Bidwell's Pipe Joint.

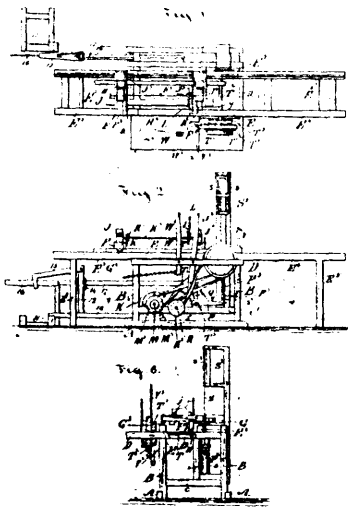

38128 Nadon's Sawmill.

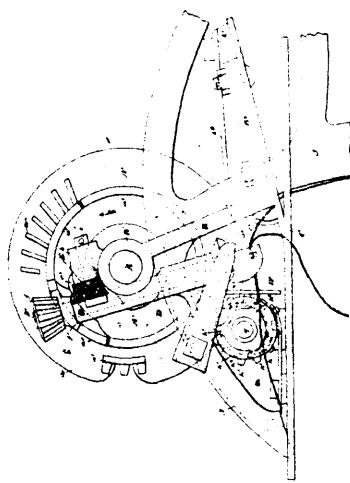

38129 Seiberling's Knotter for Harvester Binders.

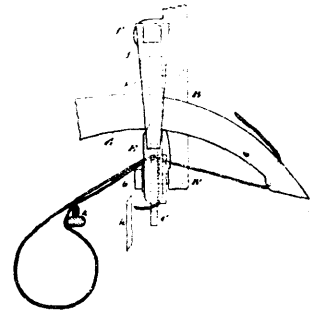

38130 Seiberling's Knotter for Harvester Binders.

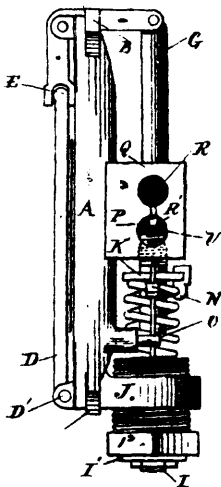

38131 McElroy's Temperature Regulator.

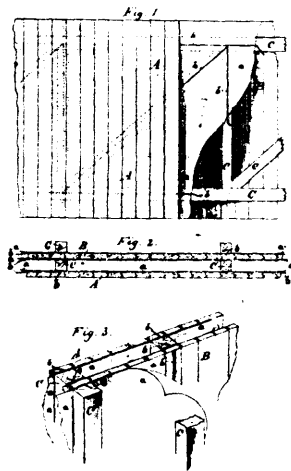

38132 Hanrahan's Refrigerator Car and Building.

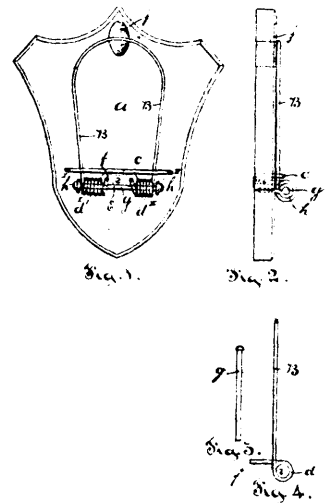

38134 Moore and Willett's Car Ticket Holder.

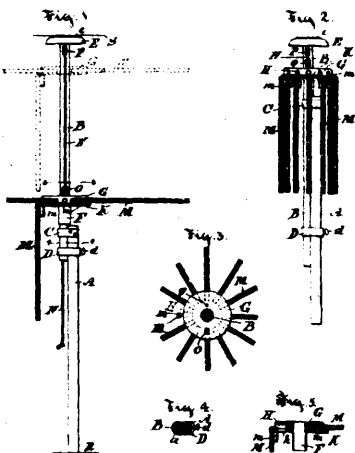

38135 Austen's Clothes Drier.

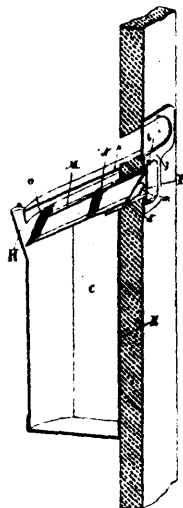

38136 Batter's Milk Receiver.

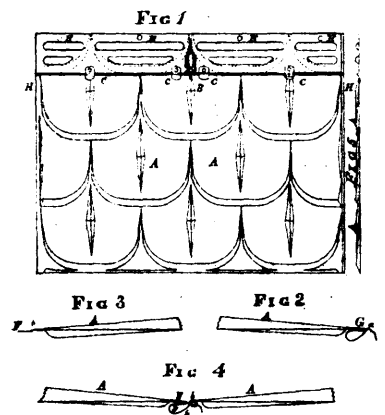

38137 Pedlar's Shingle.

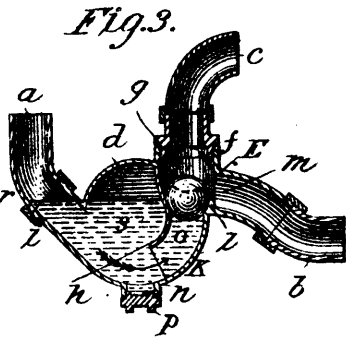

38138 Scott's Safety Tap for Discharge Pipes.

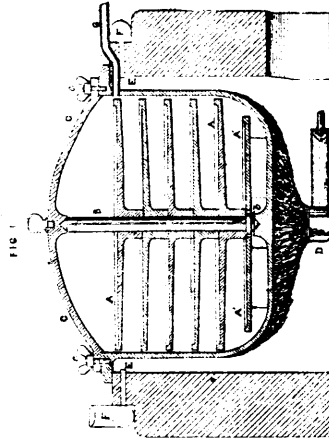

38139 Parkinson's Method of Treating Permanganate.

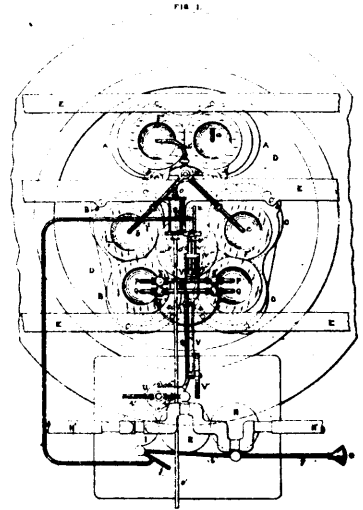

38140 Parkinson's Apparatus for Obtaining Oxygen from Atmospheric Air.

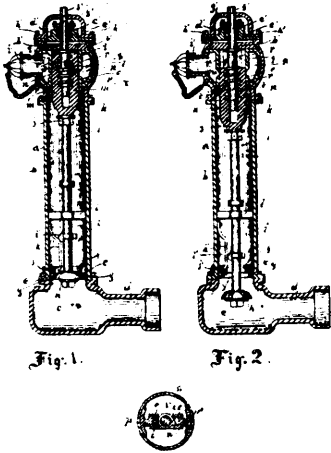

38141 Gregg's Hydrant.

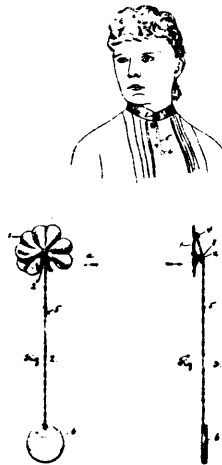

38142 Wattie's Brooch.

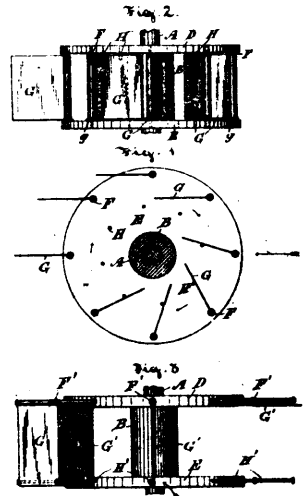

38143 Duval and Belanger's Wheel for Water and Wind.

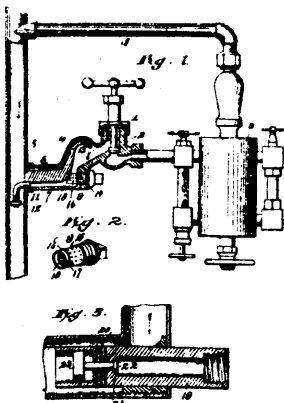

38144 Totman and Eriksen's Lubricating Device.

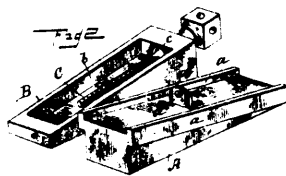

38145 Carr's Keel Block.

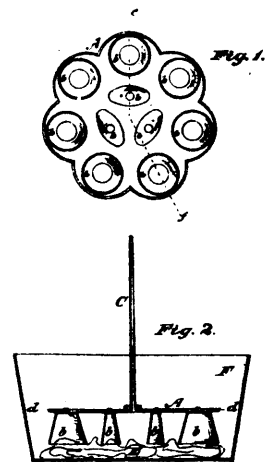

38146 Near's Clothes Washer.

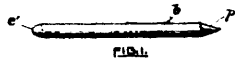

FIG. 1.



FIG. 2.



FIG. 3.



FIG. 4.



FIG. 5.

33147

Rogers' Screw Eye.

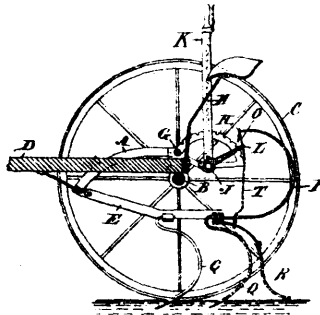

33148

Cook's Sulky Spring Tooth Harrow.

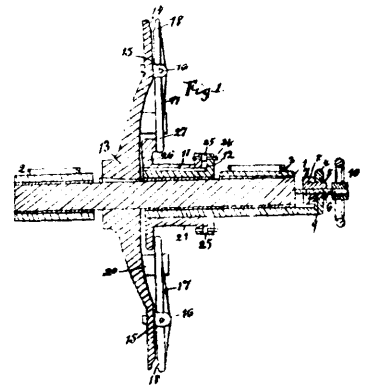

33149

Kendall's Pulley.

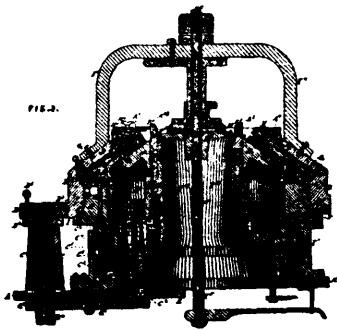

33150

Bridges' Circular Knitting Machine.

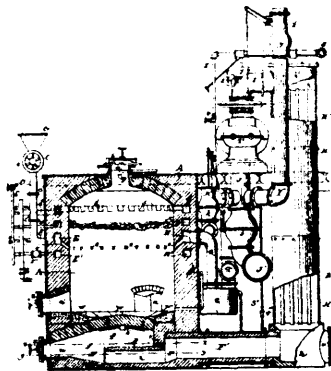

33151

Lomis' Apparatus for the Manufacture of Gas.

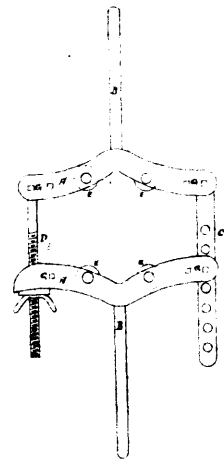

33152

Charest's Machine for Cutting Iron Pipes.

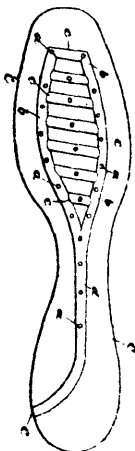

33153

Valiant's Boot and Shoe.

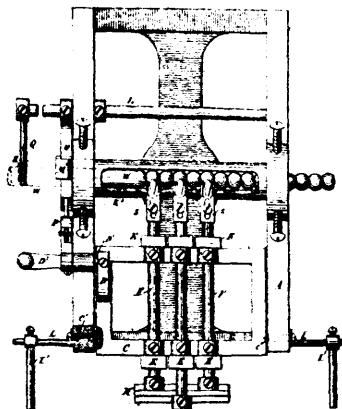

33154

Gebhardt's Machine for Turning Mouldings.

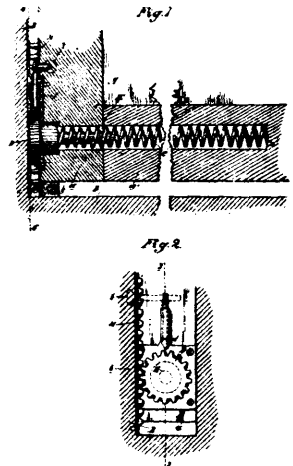

33155

Marshall's Sash Balance and Lock.

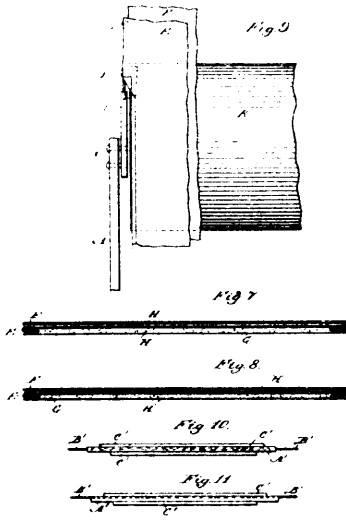

38156 John's Roofing Fabric.

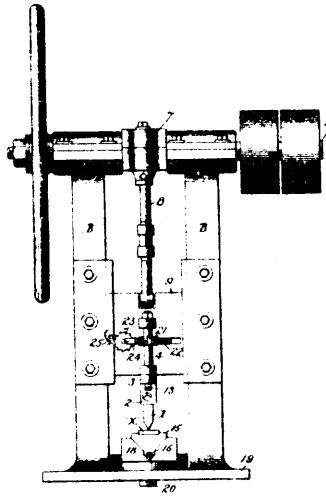

38157 Weed's File and Rasp.

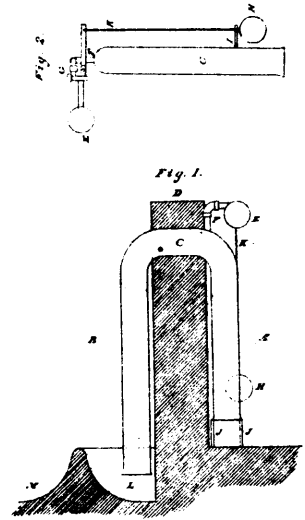

38158 Ruttan's Siphon.

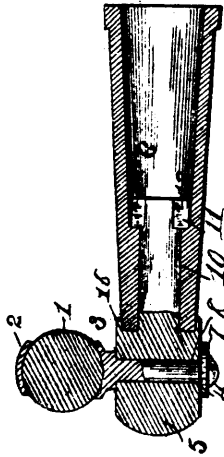

38159 Gadberry's Neck Yoke.

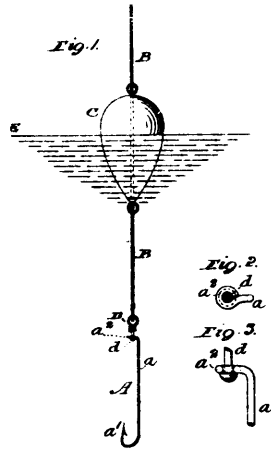

38160 Eichelberger's Fish Hook.

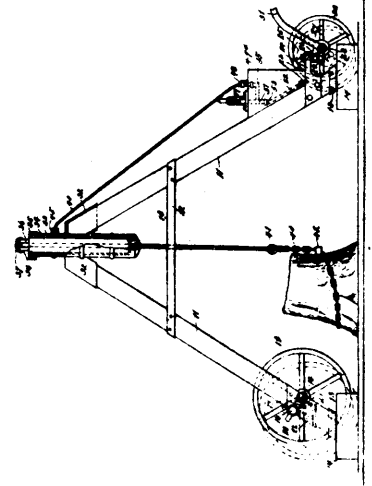

38161 Taylor's Hydraulic Stump Extractor.



38162 Connolly's Device for Tapping Stay Bolt Holes.

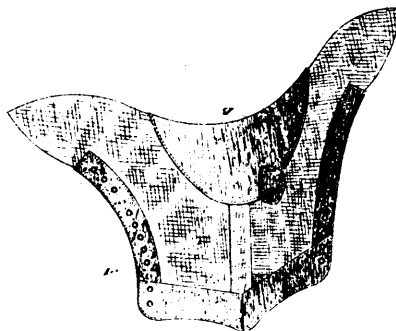

38163 Sharpe's Counter for Boots and Shoes.

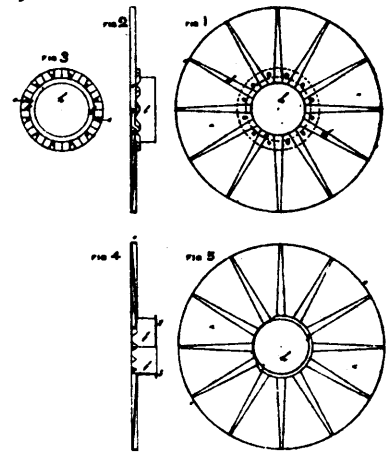

38164 Stafford's Flange for Loom Beams and Warper Beams.

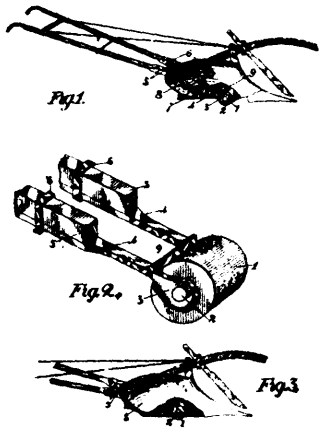

38165 Irwin's Plow.

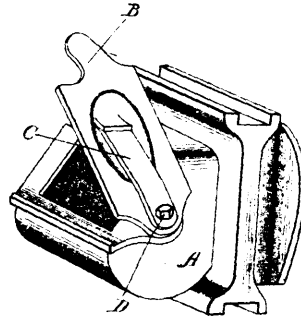

38166 Soutter's Lid for Car Axle Boxes.

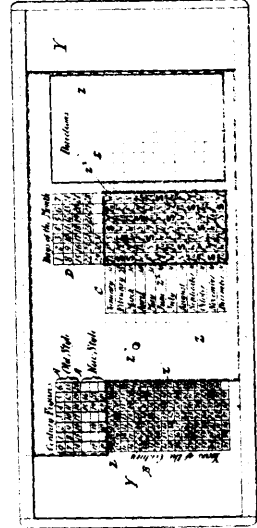

38167 Ross' Calendar.

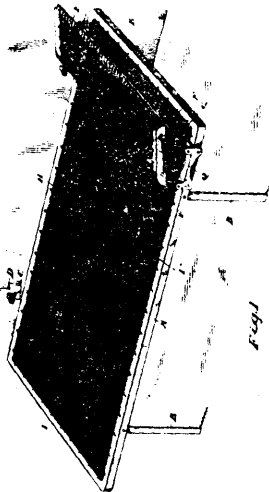

38168 Massie's Bedstead.

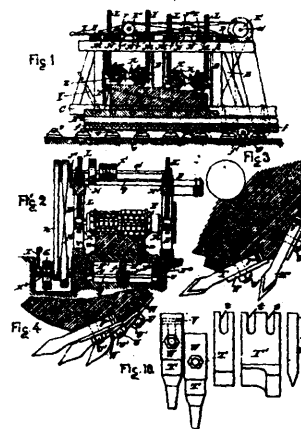

38169 Rettiger's Stone Cutting Machine.

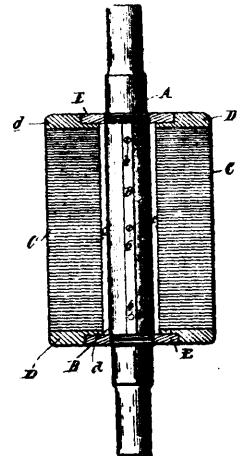

38170 Rae's Armature for Dynamo Electric Machines and Motors.

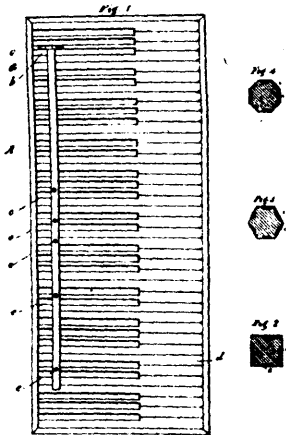

38171 Heroux's Accompanying Methods for Musical Instruments having Key Boards.

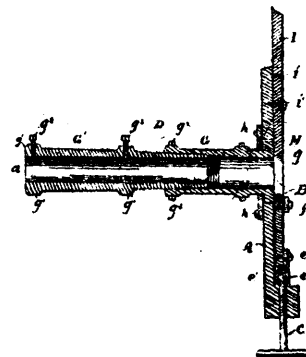

38172 Diebel's Cutter for Rods and Pipes.

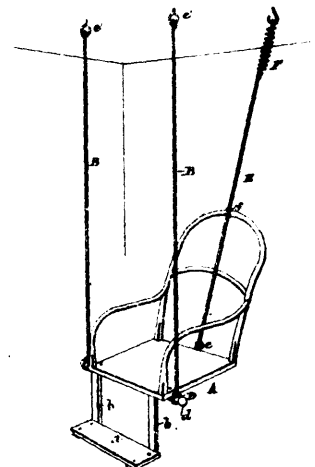

38173 Eller's Swinging Chair.