

Technical and Bibliographic Notes / Notes techniques et bibliographiques

The Institute has attempted to obtain the best original copy available for filming. Features of this copy which may be bibliographically unique, which may alter any of the images in the reproduction, or which may significantly change the usual method of filming, are checked below.

L'Institut a microfilmé le meilleur exemplaire qu'il lui a été possible de se procurer. Les détails de cet exemplaire qui sont peut-être uniques du point de vue bibliographique, qui peuvent modifier une image reproduite, ou qui peuvent exiger une modification dans la méthode normale de filmage sont indiqués ci-dessous.

Coloured covers/
Couverture de couleur

Coloured pages/
Pages de couleur

Covers damaged/
Couverture endommagée

Pages damaged/
Pages endommagées

Covers restored and/or laminated/
Couverture restaurée et/ou pelliculée

Pages restored and/or laminated/
Pages restaurées et/ou pelliculées

Cover title missing/
Le titre de couverture manque

Pages discoloured, stained or foxed/
Pages décolorées, tachetées ou piquées

Coloured maps/
Cartes géographiques en couleur

Pages detached/
Pages détachées

Coloured ink (i.e. other than blue or black)/
Encre de couleur (i.e. autre que bleue ou noire)

Showthrough/
Transparence

Coloured plates and/or illustrations/
Planches et/ou illustrations en couleur

Quality of print varies/
Qualité inégale de l'impression

Bound with other material/
Relié avec d'autres documents

Continuous pagination/
Pagination continue

Tight binding may cause shadows or distortion along interior margin/
La reliure serrée peut causer de l'ombre ou de la distorsion le long de la marge intérieure

Includes index(es)/
Comprend un (des) index

Blank leaves added during restoration may appear within the text. Whenever possible, these have been omitted from filming/
Il se peut que certaines pages blanches ajoutées lors d'une restauration apparaissent dans le texte, mais, lorsque cela était possible, ces pages n'ont pas été filmées.

Title on header taken from: /
Le titre de l'en-tête provient:

Title page of issue/
Page de titre de la livraison

Caption of issue/
Titre de départ de la livraison

Masthead/
Générique (périodiques) de la livraison

Additional comments: /
Commentaires supplémentaires:

This item is filmed at the reduction ratio checked below /
Ce document est filmé au taux de réduction indiqué ci-dessous.

10X	12X	14X	16X	18X	20X	22X	24X	26X	28X	30X	32X
								/			

The Canadian Patent Office

RECORD

Vol. I.—No. 8.

NOVEMBER, 1873.

Price in Canada \$1.50 per An
United States - \$2.00 "

CONTENTS.

INVENTIONS PATENTED,.....	175
INDEX OF INVENTIONS,.....	180
INDEX OF PATENTERS,.....	180
ILLUSTRATIONS,.....	181

No. 2734. HENRY S. WOOD, Philadelphia, Penn., U. S., 22nd September, 1873, for 5 years: "A Mirror Reflector, and Toilet Glass." (Un miroir réflecteur et à toilette.)

It is supported on a stand for convenient transportation and handling, and has an adjustable stem, which may be extended or contracted according to height desired.

Claim.—1st. The self-sustaining joint consisting of the friction blocks E, geared to each other, and the plates C, D, combined and operating as set forth; 2nd. The plate C, formed with the plug B, and the detached plate D, connected to said plug by the projection and notch a, b, in combination with the blocks E; 3rd. The tapering plugs B, and jointing portions B¹, having tapering sockets B², in combination with the jamb nuts, or washers P, and thumb screws R; 4th. The countersunk thumb screws R, S, and angular washers P, in combination with the plugs, or portions of the axial couplings or joints of the arms which support the mirror reflector M.

No. 2735. HENRY S. WOOD, Philadelphia, Penn., U. S., 22nd September, 1873, for 5 years: "Mirror Reflector and Toilet Glass." (Miroir réflecteur et à toilette.)

Claim.—1st. The combined mirror reflector and toilet glass, the same consisting of the glass C, a supporting stand and a double jointed connection between the glass and stand; 2nd. The stem or staff B, of the glass C, consisting of the telescopic sections B¹, B², B³, and holding screws E, combined and operating as set forth; 3rd. The upper section of the stem formed with the plug F, in combination with the arm J, which is jointed to the plug F, and by the plug K, to the arm J, to which the glass C, is connected.

No. 2736. ISRAEL P. MAGOON & HENRY FAIRBANKS, St. Johnsbury, Vt., U. S., 22nd September, 1873, for 15 years: "Locomotive Feed Water Heater." (Chauffeur d'eau d'alimentation de locomotives.)

Claim.—A double coil E, around the chimney B, through which the feed water is forced, and the said coil, inclosed by an insulated casing D, forming a chamber F, within which is the said coil, and into which the exhaust steam passes.

No. 2737. JAMES HINCHLIFFE, Hamilton, Ont., 22nd September, 1873, for 5 years: "Reversible Self-heating Smoothing Iron." (Fer à repasser à chauffage automate.)

Claim.—1st. A reversible smoothing iron a, a, containing chamber s, heated as shown by alcohol or burning fluid; 2nd. The arrangement of the swinging levers c, c¹, in combination with the collar o, projection r, for swinging the iron; 3rd. The arrangement of the adjustable stop lever d, as shown with its prongs u, u, slot in, hinged by the pin e, to the projection r; 4th. The arrangement of the fluid reservoir f, in combination with the iron a, a; 5th. The arrangement of the tube C¹, passing from the reservoir to the fire chamber s; 6th. The arrangement of the tap v, the joint h, cup j, and wick i, all combined with the other parts of the device; 7th. The arrangement of the wire netting k, covering the chamber s, as specified.

No. 2738. GEORGE J. WILSON, Ottawa, Ont., 22nd September, 1873, for 5 years: "Machine for Turning Wood." (Un tour à bois.)

Claim.—The combination of driving shaft A, driving drum B, cone pulleys C, driving latho disc D, adjusting foot disc E, screw shaft F, adjusting screw nut G, driving cog-wheel H, centre point cog-wheels I, centre points K, lever L, clutch pulley M, pin N, travelling cutting bed o, cutting tool P, cutting bed adjuster Q, handle R, spur-wheels S, and endless screws T.

No. 2739. JOHN E. COFFIN, Portland, Me., U. S., 25th September, 1873, for 5 years: "Split Match Card." (Carte d'allumettes fendues.)

The match card is a split card, that is to say, the interstices between each match are split by a knife, in contradistinction to the sawkerfs now generally in use.

Claim.—A match card or block in which the incisions which divide the matches, are not extended entirely throughout the length of the blank in order that a portion of such blank may be left intact for purposes stated.

No. 2740. JOHN RICHMOND, Morris, Ont., 25th September, 1873, for 5 years: "Thrashing Machine Jack." (Élévateur de machine à battre.)

Claim.—1st. The combination of the pulley A, with the frame C, for the purpose of raising or lowering a thrashing machine; 2nd. The combination of the rack D, with pulley A, and frame C, for the purpose of protecting the connecting rod E.

No. 2741. ANDREW G. GRAY, St. John, N. B., 25th September, 1873, for 5 years: "Mode of Fastening Door Knobs to their Spindles." (Manière d'ajuster les boutons de portes à leurs axes.)

This arrangement is intended as a substitute for the screw fastening now in use and to dispense with the necessity of perforating the spindle at certain places to fit the thickness of doors most in use, but which do not fit doors of other thicknesses.

Claim.—The combination of door knob B, shank C, eccentric pin D, with the slotted spindle A, made as specified.

No. 2742. HIRAM J. WATTLES, Rockford, Ill., U. S., 25th September, 1873, for 5 years: "A Carriage for Ploughs." (Une voiture pour les charrues.)

The invention is a carriage for ploughs to prevent the heavy friction of dragging when in use.

Claim.—A beam G, the eccentric lever B, the cogs of lever C, that wash into cog axle T, the ratchet V, and the spring lever.

No. 2743. JOSEPH H. LIVINGSTON, New York, U. S., 25th September, 1873, for 5 years: "Process for Manufacturing Butter." (Procédé de fabrication du beurre.)

Claim.—1st. The treatment of animal fat, for the purpose of manufacturing the new article of commodity specified; 2nd. A new article of manufacture in butter, produced from animal fat or suet, as described; 3rd. In butter produced from the oil procured from animal fat, as a new article of manufacture.

No. 2744. LEMUEL R. PALMER, Belfast, Me., U. S., 25th September, 1873, for 15 years: "A Stave Joiner." (Un jointeur de douves.)

Improvement in the class of jointing machines, for varying the curvature of the edge of the staves proportionately to their width, the adjustment of the guides being effected by the width of the stave itself.

Claim.—The adjustable rail operated by a lever M, and the stave carriage with its bearings C, lever D, and plate W, when combined with a lifting incline r, and a wire or cord for guiding the incline into the plate r.

No. 2745. PETER K. DEDERICK, Albany, N. Y., U. S., 25th September, 1873, for 5 years: "A Self-dumping Tub." (Une cuvette à bascule.)

Claim.—The latches F, F, connected and secured to the tub A, and adjusted to the bail B, at both sides of the tub.

No. 2746. FRANCIS W. BROWN, Cincinnati, Ohio, U. S., 25th September, 1873 for 5 years: "Improvements on Tuckers." (Perfectionnements aux plisseuses.)

The object is to construct a tucker for sewing machines, with suitable devices for folding, holding and guiding the material, so that the tuck or plaits shall be evenly and smoothly made, of any width and with any distance between, without the use of markers.

Claim.—1st. The elevated main tucker plate A, with the slot a; 2nd. The adjustable arm C, Ci, combined with the folding hook or gauge H; 3rd. The arm C, Ci, in combination with the main slotted plate A; 4th. The combination of plate A, with the plates B, and C; 5th. The gauges H, and D, arranged upon supporting arms and combined with the main plate A, and made adjustable; 6th. The adjustable supporting plate E, constructed and arranged as set forth.

No. 2747. WILLIAM LIDDELL, REUEL H. THAYER & WILLIAM C. RIDDELL, Buffalo, N. Y., U. S., 25th September, 1873, for 10 years: "Machine for Making Paper Bags." (Machine à faire les sacs de papier.)

Claim.—1st. The combination in a paper bag machine and with a stationary blade or cutter of the roller G, G, provided with cutters g, g; 2nd. A paper bag machine, the combination with the stationary blade K, of the supporting arm K', attached thereto so as to permit the passage of the overlapped and unfastened edges of the folded paper tube; 3rd. The combination with the roller F, F, the former provided with a recess g, of the stationary knife and arm K, K', and ledge k; 4th. The combination with the knife and arm K, K', and roller F, provided with recess g, of the adjustable screw k; 5th. The combination with the pressure rollers q, q, and folding blade p, of the revolving pasting bar S; 6th. The combination with the guide rollers h, and curved gauges C, C, of the edge punches E, and guide brackets d; 7th. The combination of the edge punches, striking arms c, c, and rocking shaft e; 8th. The combination with the edge punches, rocking shaft e, and striking arms c, c, of the plate n, return spring n', pawl n', oscillating arm n, pitman m', and crank arm m; 9th. The combination with the cutter rollers G, G, of the elliptical gear wheels L, L, for imparting a variable motion to the cutter rollers; 10th. The combination with the pressure or feeding rollers q, q, and folding blade p, of the revolving pasting bar S; 11th. The combination with the shaft P, actuated by the counter shaft O, or its equivalent, of the revolving pasting bar S, folding blade and rocking arms pi, p, rocking lever r, and cam r; 12th. The combination with the shaft P, of the arms s, s, and paste roller u, pivoted pasting blade S, provided with arms s', and reacting spring t; 13th. The combination with the pasting blade S, and brush z, of the clamping plates z', z'.

No. 2748. CHARLES W. HEBARD, Rochester, N. Y., U. S., 25th September, 1873, for 5 years: "Manufacture of Pipe." (Fabrication de tuyau.)

Claim.—1st. The process of forming a wooden pipe, by a continuous winding of the splints upon a "form" or core, when said splints pass from a tank of cement, and are coated upon all sides so that in the act of winding they build up the body of the pipe in a continuous body of cement from inside to outside; 2nd. An apparatus for winding wooden splints, to form pipe, the giving to the form or core an alternate reciprocating movement to compensate for the winding, in combination with a stationary position of the splint or vice-versa; 3rd. In combination with the form or core D, the supporting car frame or block I, 4th. In combination with the form or core, the presser K; 5th. The combination of the inclined board p, and hinged jaw r; 6th. The teeth or projections q, q, on the board p, and supplementary jaw w, either or both when employed in the manner specified; 7th. In combination with the car or truck E, the swinging gears 7, and 8, with engaging and disengaging pinions 9, and 10, and the changeable pinion 7; 8th. The arrangement for constructing spirally wound wooden pipe, the form or core consisting either of the segments and wedge bars and key as shown in Figs. 3, and 6, or the hinged staves as shown in 7, 8, and 9, the parts constituting the same being held to the bearing

heads by means of screws or equivalents, and made collapsible in the manner specified; 9th. In combination with the form D, the standards C, C, hinged at one end for operation; 10th. In combination with the bearing heads holding the form or core, the adjustable directing plates p', as specified.

No. 2749. JOHN D. LAWLOR, Montreal, Que., 25th September, 1873, for 5 years: "Shuttle Bobbin Winder." (Bobinoir de machine à coudre.)

Claim.—The surfaces p, or q, or both, and spring r, in combination with the bracket d, arranged to hold the shuttle spool n, as described.

No. 2750. JOHN BRYCE, Grand Haven, Mich., U. S., 25th September, 1873, for 5 years: "A Spinning Wheel." (Un rouet.)

Claim.—1st. The spindle A, and its friction pulley a, held in contact with the wheel b, by means of a sliding spring bearing; 2nd. The sliding shaft B, with its wheel b, and disk b', combined with the wheel C, and made adjustable by means of the screw g; 3rd. The sliding spindle A, and sliding shaft B, combined with each other by means of the grooved wheel a, and wheel b, working in the grooves of the wheel a; 4th. The combination of the hand wheel C, the adjustable shaft b, and the spindle A, held in contact with its driving wheel by the spring c', all supported on a suitable frame and constructed, and operating in the manner set forth.

No. 2751. JOHN MCPHERSON, Westminster, Ont., 25th September, 1873, for 5 years: "A Secrétaire." (Un secrétaire.)

It is so constructed, that it can be put into any ordinary writing desk, bureau or secrétaire.

Claim.—The arrangement of letter, or arms D, arms I, in combination with front top and lever B, and front cover C; in the application of quadrant E, and latch F.

No. 2752. JEAN E. RICHARD, Columbia, S. C., U. S., 25th September, 1873, for 5 years: "Belt Fastening." (Joint de courroie.)

Claim.—The combination of the separable clamp-plates and the core pieces, with the split, cut, or bored belt-ends, as set forth.

No. 2753. ALBERT H. JARECKI & JOHN M. ORMSBEE, Erie, Penn., U. S., 25th September, 1873, for 15 years: "Improved Pipe Tongs." (Tenailles à tuyaux perfectionnées.)

Claim.—1st. The steel-bar G, pointed and sharpened on both ends, serrated on one face, and operated by the worm-wheel D; 2nd. The combination of the handles A, A', hook B, enlarged, forked, and mortised part C, worm-wheel D, and reversible, and serrated steel-bar G, all constructed and arranged as set forth.

No. 2754. WILLIAM COOPER, Ypsilanti, Mich., U. S., 25th September, 1873, for 5 years: "Bucket for Chain Pumps." (Godet de pompe à cha-pelet.)

Claim.—1st. The elastic disc B, of a chain pump-bucket, provided with a notch c, on its periphery; 2nd. The wheel A, provided with a circumferential groove forming an upper and lower flange and made of one piece of metal, in combination with the elastic collar B, sprung into said groove and the bail C; 3rd. In combination with the above claims, the leather or other material J, inserted in the groove c.

No. 2755. LEVI K. FULLER, Brattleboro, Vt., U. S., 25th September, 1873, for 5 years: "Ventilator and Dust Arrester." (Ventilateur et arête-poussière.)

Claim.—A ventilating apparatus consisting of the chamber A, provided with the induction and eduction orifices a, a, spray wheel c, and one or more partitions B, B, and slides b, b, arranged and operating as specified.

No. 2756. WILLIAM H. SKIDMORE, Philadelphia, Penn., U. S., 25th September, 1873, for 5 years: "Buffer and Coupling Apparatus for Railway and other Carriages." (Appareil de choc et d'attelage de voitures de chemins de fer et autres.)

Claim.—1st. The combination of the double hook-automatic coupling, the spring buffers, and the device for disengaging both hooks at once and thereby uncoupling the cars; 2nd. A car provided with both a link and pin coupling and an automatic hook coupling, a hooked coupling bar attached to the main draw bar and adapted to be projected beyond the face of the drawhead and locked in that position when the automatic part is to be used, or

to be moved back out of the way when the link and pin coupling is alone to be used; 3rd. The stop plate F, constructed as described and combined with the parts B, D, e; 4th. The drawhead B, and flanged hook-guide and holder C, when cast or welded in one metallic piece; 5th. The rocking plate G, combined with the lever, the draw bar, and the hooks so as to be capable of disengaging both hooks at once; 6th. The buffer plate M, constructed as described; 7th. The combination of the buffer plate M, pins or projections f, t, and springs s, with the car platforms; 8th. The projecting plate P, or its equivalent, in combination with the buffer plate M, and springs s.

No. 2757. JEREMIAH BENNETT, Montreal, Que., 25th September, 1873, for 5 years: "Shuttle Holder and Ejector of Sewing Machine." (Charriot de navette et chasse-navette de machine à coudre.)

The object is to prevent the shuttle from escaping from the carriage while the machine is in motion, so as to avoid breaking or damaging the machine, or the shuttle; to make the contrivance self-acting; and to provide a ready means of "shooting" the shuttle out of its holder when the machine is at rest.

Claim.—1st. The shuttle holder d, and shuttle c, in combination with the lever f; 2nd. The lever f, in combination with the pin m; 3rd. The lever f, consisting of parts h, f, and k, in combination with the shuttle c, and shuttle holder d; 4th. The lever f, consisting of parts k, f, and i, in combination with shuttle c, and shuttle-holder d.

No. 2758. THOMAS W. MOFFATT, Orillia, Ont., 25th September, 1873, for 5 years: "Machine for Conducting Tea from Packages." (Machine à soutirer le thé des boîtes.)

Claim.—A machine having a spiral screw B, attached to a shaft F, worked by the handle E, and revolving in the cylinder A, left open on the top, with a flange as in Fig. 2, on line a, b, of Fig. 3, which spiral screw being turned by the said handle conducts the tea or other substance through the channel C, into the mouth D, into any vessel that is there to receive it.

No. 2759. WILLIAM MUNROE, Worcester, Mass., U. S., 25th September, 1873, for 5 years: "A Reed Organ Board." (Un sommier d'orgue.)

Claim.—The application of glass or other similar material to the cells of reed organs.

No. 2760. FRANCIS KENNY, Hartford, Ct., U. S., 25th September, 1873, for 5 years: "Machine for Joining Sheet Metal Plates by a Double Seam." (Machine à joindre les plaques métalliques par un double membron.)

Claim.—1st. The combination of the handles, the bar g, shaped as described, and the bar C, having the forming bar s, shaped as described, hinged thereto, the whole arranged and operating as described; 2nd. In combination with the parts as claimed in the last clause; the foot piece K, and spring m, as described.

No. 2761. WILLIAM D. BAXTER, New York, U. S., 25th September, 1873, for 5 years: "Improvements in Double-acting Force and Lift Pumps." (Perfectionnements aux pompes foulantes et élévatoires à double effet.)

Claim.—1st. The pistons e, and yoke-pieces p, actuated by the rollers o, lever l, in combination with the pumps d, d', and water way h, provided with stuffing boxes for the piston rods n, and an air vessel k, the parts being arranged and constructed as described; 2nd. The double-acting hollow cock C, with openings l, J, K, and L, cylinder B, with pipe or channels A, B, D, and E, in combination with the pump cylinders d, d', reservoir R, and inlet pipe o; 3rd. The dovetail B, and L, threaded bar F, and nut G, in combination with the journal boxes D, and H, and the bed C'.

No. 2762. EDMOND N. LACROIX, Minneapolis, Minn., U. S., 25th September, 1873, for 5 years: "Middlings Separator and Purifier." (Séparateur et purificateur des gruaux.)

Claim.—1st. The combination with the series of longitudinal screens B, B, of the cross screen C, lying at right angles to the others; 2nd. In combination with the screen on which the middlings are received, and with an exhaust which draws off the fine fibrous matters and impurities, an air tube or tubes located under the screen or screens, and an independent air blower connecting with said tube or tubes, and so arranged as to clear the meshes of the screens by currents or jets from said tube or tubes; 3rd. The combination of the air tube or tubes L, with the screens, when said air tube or tubes are made to travel beneath the screens, and so arranged as to concentrate the blast and force it through the

meshes in a thin line; 4th. The construction of the air tube L, with the enlarged body b, contracted top s, and narrow slit or opening k, extending longitudinally of the tubes. 5th. In combination with the travelling air tube or tubes L, a flexible tube or tubes N, and a blower, fan, or equivalent device Q, for forcing air through the air tube or tubes; 6th. In combination with the travelling air tube L, or a travelling brush, the double threaded screw S; 7th. In combination with the screens, the eccentric a', a', and straps b', b', for producing a compound horizontal and vertical motion of the screens.

No. 2763. SAMUEL MITCHELL, Lima, N. Y., U. S., 25th September, 1873, for 5 years: "Spoke Socket for Wheels." (Douille de rais de roue.)

Claim.—The combined socket and clip C, with the branches d, d', on each side provided with the spur or spurs f, for driving into the wood, and having the supplementary socket g, as specified.

No. 2764. LORENZO BROWN, Mapleton, Ont., 25th September, 1873, for 5 years: "A Corn Planter." (Un butteur à blé-d'inde.)

Consists in the combination with the chute and seed box of an inserted spring between the pivoted side of the chute, and handles for closing the seed discharge aperture in such a manner that the hand of the operator in planting grasps the handles and by compression feeds the seed measure by the motion of the spring.

Claim.—1st. The arrangement and combination of the spring T, with the sides A, B, 2nd. The seed carrier lever F, arranged and operating in combination with the sides A, B, and seed box E; 3rd. The provision of the handles K, M, arranged with respect to the sides A, B, and the loop L, for operating the machine by one hand in the manner set forth.

No. 2765. JOSEPH BARKER, Chicago, Ill., U. S., 2nd October, 1873, for 5 years: "Machine for Sand Papering Lumber." (Porte-papier de verre pour polir les bois.)

Claim.—1st. The combination of the central blast a, with the rotating sand-papering wheel F; 2nd. The central blast, in combination with the sand-papering wheel F, and the transverse chamber c, communicating with the central blast; 3rd. The sand-papering wheel F, constructed of removable sand-papering blocks L, when combined in a machine for sand-papering.

No. 2766. ALBERT C. LANGWORTHY, Aurora, Ill., U. S., 2nd October, 1873, for 5 years: "Washing Machine and Ironing Table." (Machine à laver et table à repasser.)

Claim.—1st. The removable ironing table B, cover A, when forming a combined ironing table; 2nd. The washer J, provided with mortises n, to receive standards i, in combination with the frame pieces G, levers E, rubber S, cross piece X, and cross bar P; 3rd. The combination of the guides r, pivoted slides V, wash box C, D, G, and washer E, S, F, I, G, J, P, X, as described.

No. 2767. WILLIAM B. MACK, Boston, Mass., U. S., 2nd October, 1873, for 5 years: "A Steam Injector or Ejector." (Un injecteur ou éjecteur à vapeur.)

Claim.—An injector or ejector, a solid stem or spindle w, arranged to operate back and forth within a steam-cone or tube z, and formed with a concave curved tapering termination n'.

No. 2768. JAMES H. HULL, St. Johnsbury, Vt., U. S., 2nd October, 1873, for 5 years: "A Weather Strip for Doors and Windows." (Un bourrelet de portes et de fenêtres.)

The effect being to render doors and windows perfectly air-tight by the application of moveable strips inserted round their edges.

Claim.—The weather strip as follows. Fig. 2. the strip E, the moveable slit F, with the rubber G, and the set screws H, H, with the spiral springs I, I.

No. 2769. JAMES L. DAVIS & WILLIAM H. DAVIS, Jersey City, N. J., U. S., (Assignees of Richard Van V. de Guinon), 6th October, 1873, for 5 years: "Apparatus for Carbureting Hydrogen Gas." (Appareil à carburer le gaz hydrogène.)

The hydrogen gas is made in the humid way by the action of a solution of sulphuric acid, or iron, or zinc, and when so formed it is made to pass through hydro-carbon and the two gases combining form carburetted hydrogen of a superior quality.

Claim.—1st. The upright columns H, H, having perforated disks, at stated distances supported from the bottom and containing the filtering substance in combination with the circular gas receiver 5, 5, 5, connected with or separated from the body of the machine; 2nd. The arrangement of the cocks K, F, in combination with the body A, A, of the gas generator and carbon chamber.

No. 2770. JEAN E. RICHARD, Columbia, S. C., U. S., 6th October, 1873, for 5 years: "Portable Air Gas Machine." (Machine à gaz portative.)

Relates to a machine for generating illuminating gas by the mixture of air with gasolene, naphtha or other hydro-carbon in the necessary proportions.

Claim.—1st. The diaphragm *a*, perforated near the bottom and arranged within the cylinder A; 2nd. The hollow perforated shaft D, having an enlarged centre of sufficient diameter, fitted through the diaphragm *a*, and the wheels F, and G; 3rd. The packing *o*, connected with the lubricating pipe *m*, and arranged within the diaphragm *a*, and upon the shaft D; 4th. The discharge pipe J, arranged as described, and provided with the swivel valve *z*; 5th. In combination with the packing V₁, and V₂, the washer *v*, constructed and arranged as described.

No. 2771. JEROME B. STILLSON & JOHN A. KLEY, Chicago, Ill., U. S., 6th October, 1873, for 15 years: "Chemical Fire Engine." (Appareil chimique à incendie.)

Consists in combining with the gas tanks a force pump; in the mode of supporting the tanks upon the frame, and in the peculiar construction of the bed frame and running gear, &c.

Claim.—1st. In combination with the acid chamber D, the discharging rod *c*, *c*, made in two parts, and constructed and protected from the acid; 2nd. The combination of the two gas tanks with a force pump G, constructed and arranged to operate with either or both of such tanks; 3rd. The combination of the two tanks with the pump G, suction hose H, pipe *b*, and valves *i*, *j*, *j*, and pipe F, so that the tanks may be operated separately or in conjunction; 4th. The combination of the valve-cock *k*, and pipe *l*, with the tanks A, B; 5th. The mode described of securing the tanks to their supports by means of flanges *m*, and bolts; 6th. The bed frame consisting of the side pieces K, K, cross bars L, L', L₂, L₃, tank supports *m*, *m*', and supports *n*, *n*, for the pump; all constructed as specified.

No. 2772. JAMES ECCLES, Philadelphia, Penn., U. S., 6th October, 1873, for 5 years: "Frictionless Journal and Shaft Bearings." (Tourillon et coussinet sans friction.)

Claim.—1st. A journal box, the interposition between the axle or sleeve thereon, and a circular bearing surface concentric with the axle, of a series of anti-friction rollers geared to the axle or sleeve and to the said concentric circular bearing surface by cog-wheels the pitch lines of which coincide with the bearing surfaces; 2nd. The combination of the ring E, axle G, and interposed geared rollers with a block B; 3rd. The combination of the ring E, axle G, interposed geared rollers and block B, with the box *a*, and spring *f*; 4th. In interposing between a plate for receiving the end thrust of a shaft and a plate or disc on the latter, a series of conical rollers adapted to bevelled tracks on the said plates and geared to the said tracks by bevelled wheels the pitch lines of which coincide with bearing surfaces of the tracks and rollers; 5th. The conical rollers interposed between and geared to a fixed plate and revolving plate, the latter of which has a flange for resisting the end thrust of the said rollers.

No. 2773. RICHARD S. BRADLEY, Toronto, Ont., 6th October, 1873, for 5 years: "Washing Machine." (Machine à laver le linge.)

Claim.—The perforated hollow cylinder A, when suspended on the gudgeons B, within the water tank D.

No. 2774. THOMAS DARK, Buffalo, N. Y., U. S., 6th October, 1873, for 5 years: "Receiver and Stench Trap of Street Sewer." (Puits et clapet d'égout.)

Serves the double purpose of a stench trap and of permitting the ready cleaning of the sewer.

Claim.—The combination of the iron receiver A, with slanting ends *a*, *a*, trap B, and outside flanges *b*, *b*, all formed in one piece and having the hinged valve C, resting on packed seats or groover *c*, *c*, and held in place by cross bar C, working into grooves *d*, *d*.

No. 2775. THOMAS FORFAR, Waterdown, Ont., 6th October, 1873, for 5 years: "Machine for Wringing Clothes." (Machine à tordre le linge.)

Claim.—The combination and arrangement of the several parts, namely: the double and single ended frame A, as shown on Figs. 1 and 3, with the springs G, at each end for regulating the pressure on the rollers C, and D, for the purpose of mangling clothes or other articles, all operating as set forth.

No. 2776. CHARLES S. REED, Oakville, Ont., 6th October, 1873, for 5 years: "Frame for Stretching Hides and Leather." (Herse pour étirer les peaux et le cuir.)

Claim.—1st. The attachment of the slide bar A, to the frame D, by means of parallel swinging hooks or: *z*, B, B, B; 2nd. The movement of the slide bar A, by means of the cam C; 3rd. The combination of the slide bar A, the swinging hooks or bars B, B, B, and the cam C, arranged as described.

No. 2777. HENRY Q. HAWLEY, Albany, N. Y., U. S., 6th October, 1873, for 5 years: "Fluid Measuring Motor." (Moteur pour le mesurage des fluides.)

The apparatus is constructed so as to remove all injurious friction, thereby materially reducing the wear of the moving parts.

Claim.—1st. A rotary fluid motor or meter an inner wheel carrying pistons in separate chambers revolving concentrically with a portion of the periphery of the case and eccentrically with the remainder; 2nd. The loose and shouldered pistons D, in combination with the wheel C, and case A; 3rd. The pistons D, straight or curved, constructed with chambers and loose packing combined with an inner wheel; 4th. A series of wheels of similar construction acting alternately in separate chambers of case and placed upon the same shaft; 5th. A worm screw or toothed pinion on the shaft connecting with indicating dials or registering apparatus in combination with a rotary motor; 6th. In cone pulleys in combination with the case A, shaft B, and wheel C, and their attachments; 7th. The lubricating and packing screw *b*, in combination with the case and wheels; 8th. The combination of the grooved case A, with the eccentric wheel *v*, carrying the loose pistons P, said wheel and pistons having chambers, shouldered and pins.

No. 2778. BENJAMIN T. TRIMMER, Rochester, N. Y., U. S., 6th October, 1873, for 5 years: "Middlings Separator and Purifier." (Séparateur et purificateur des gruaux.)

Claim.—1st. The primary screen E, located above the machine and employed for the purpose of screening the middlings before subjecting them to a current of air; 2nd. The chutes *p*, *p*, and adjustable slides *r*, *r*; 3rd. In combination with the chutes *p*, *p*, the inclined boards *s*, *s*; 4th. In combination with the exhaust fan and fan case B, C, the slides *d*, *d*, and valve *f*; 5th. In combination with the screen I, the curved bearing *e*, and eccentric *w*, or equivalent for imparting a compound vertical and horizontal rocking motion to said screen; 6th. The series of independent sieves or screens K, K, mounted in a single frame, and so arranged as to be removable at pleasure; 7th. In combination with the screen I, the knocker L, operated by a cam *x*, or equivalent.

No. 2779. JAMES HAY & FEARGUS PERKS, Montreal, Que., 6th October, 1873, for 5 years: "A Fire-escape." (Un appareil de sauvetage.)

Claim.—1st. The rails *a*, with bogie *c*, in combination with blocks and pulleys *e*, and *b*, basket *f*, chain *k*, pin *m*, arm *o*, and wire or cord *p*; 2nd. The combination of the pin or bolt *n*, pivoted at *n*, pivoted arm *o*, and cord or wire *p*, in combination with chain *k*.

No. 2780. DONALD J. MCARTHUR, Lobo, Ont., 6th October, 1873, for 5 years: "Machine for Capturing Potato Bugs." (Machine à attrapper les punaises à patates.)

When the machine is pushed forward the fan wheel strikes the potatoe vines knocking the insects against shield and into a drawer.

Claim.—The application of frame A, and wheel B, in combination with pinion bar E, pulleys J, and K, shield G, box N, and drawer H.

No. 2781. WILLIAM FARRIS, Yarmouth, Me., U. S., 6th October, 1873, for 5 years: "Tanning Liquid." (Liquide de Tannage.)

Claim.—A compound of ingredients for a tanning bath, consisting of sulphate of soda, sulphate of potash, alum, sulphur, common salt, catechu and quercitron and the described equivalents.

No. 2782. DAVID VASS, Montreal, Que., 6th October, 1873, for 5 years: "Combined Chair and Lounge." (Chaise et causeuse combinées.)

Claim.—1st. The chair or lounge constructed as described in combination with the arms composed of links G, and H; 2nd. The arms consisting of links G, and H, joined together at K, with eyes or pivots at L, and B, all working together as described.

No. 2783. SAMUEL CRAWFORD, London, Ont., 6th October, 1873, for 5 years: "Improvements in Reaping and Mowing Machines." (Perfectionnements aux faucheuses-moissonneuses.)

Relates to the construction and combination of an iron truss frame arranged in such a manner when applied to the machine that the whole will be held together by only four bolts.

Claim.—1st. The truss frame A, of metal applied to reaping and mowing machines; and. The combined brackets and corner irons B, B', in combination with the truss frame, A, A'; 3rd. The arrangement of the gear K, J, L, shaft and wheel H, L, on the outside of the truss frame A, between it, and the drive wheel. 4th. The arrangement of the ratchet P, cast on the back of the bevel wheel K; 5th. The arrangement of attaching the tongue R, to the truss and corner iron E, and centre box O.

No. 2784. MILO HARRIS & JAMES GILBERDS, Jamestown, N. Y., U. S., 6th October, 1873, for 15 years: "Package for the Transportation and Preservation of Perishable Substances." (Boite pour la conservation et le transport de substances périssables.)

Claim.—1st. In combination with the vessel c, the cover B, constructed with the shoulder h, fitted to the mouth of said vessel and the clamping hoop A, formed and operating as set forth; 2nd. In combination with the vessel c, and covers B, the elastic band D, and clamping hook A, to pack the cover joint; 3rd. The elastic band D, combined with the vessel C, and its cover B.

No. 2785. WILLIAM STACK, Sussex Vale, N. B., 6th October, 1873, for 5 years: "Process for Basting and Cleansing Hides and Skins for Tanning." (Procédé pour dégorger les peaux pour le tannage.)

The mixture consists of bran, oil of vitriol, common salt and tar water in certain proportions.

Claim.—The process described for basting hides and skins as specified.

No. 2786. WILLIAM B. DICK, Glasgow, Scotland, 10th October, 1873, for 5 years: "A Fire Extinguisher." (Extincteur d'incendie.)

Relates to fire extinguishing apparatus of the kind in which carbonic acid gas, mixed with or dissolved in water, is projected by its own expansive force along with the water from a strong vessel through a stop or regulator valve and delivery hose or pipe.

Claim.—1st. The novel combination of the vessel (1) with the rigidly fixed bottom socket (6) for the acid bottle (5) the said socket (6) having the prongs (12) and with the movable cap (8) by means of which the bottle is held and can be forced down against the prongs (12); 2nd. The holding of the acid bottle (5) between a fixed bottom support (9) and a movable cap (8) by forcing down which cap the bottom of the bottle may be broken against prongs or points (12) in the bottom support (9) as described.

No. 2787. ELIAS VERNON, Hamilton, Ont., 10th October, 1873, for 5 years: "Improvements on Coal Cooking Stoves." (Perfectionnements aux poêles de cuisine à charbon.)

Claim.—1st. The combination of a circular coal cooking stove and a base burning self feeding heating stove; 2nd. The arrangement of the smoke passage i, around the feeder d; 3rd. The arrangement of the circular sliding damper e, over the feeder d; 4th. The arrangement of the circular sliding damper e, at the base of the feeder for regulating the draft; 5th. The arrangement of the mouth h, of

the feeder d, in combination with the other portions of the stove 6th. The circular top b, of the stove having the horizontal air tube c, c, c, c, c, c, in combination with the passage i; 7th The arrangement of the direct air passages n, n, n, n, n, between the air tubes c, &c., as specified.

No. 2788. JOHN ROURK, Kingston, Ont., 10th October, 1873, for 5 years: "Improvements in the Propulsion and Steering of Boats by Steam." (Perfectionnements dans la propulsion et la manière de gouverner les vaisseaux par la vapeur.)

Claim.—1st. The application of steam derived from the exhaust pipe of a steam engine, or directly from the boiler, for the steering or propelling of boats, by its discharge against water or air; 2nd. The bifurcated or straight pipe P, connected with the exhaust pipe or boiler, of a steam engine, and extended to the stern, and bow of a boat, either above or under the water line.

No. 2789. MICHEL PARENT, Montreal, Que., 10th October, 1873, for 5 years: "A Fire Escape." (Un appareil de sauvetage.)

Claim.—1o. Un harnais de sauvetage, la combinaison des courroies A, et B, avec la bandoulière C, et la courroie D; 2o. La combinaison des courroies E, E, et des crochets a, fermoirs F; 3o. La combinaison du crochet néplat G, et du crochet à ressort H, avec la courroie D. 4o. La combinaison des diverses courroies et des divers crochets à fermoir et à ressort; 5o. Les échelles de fer K, avec leurs crochets L, leurs grilles M, et leurs pistons N. Figs. 3 et 4; 6o. La combinaison de l'ensemble du système, avec des poulies de sauvetage en l'épand l'utes et leurs appendices tel que courroies, bandoulières, crochets, nacelles et cerceau, tel que décrit.

No. 2790. ISRAEL KINNEY, London, Ont., 10th October, 1873, for 5 years: "Clamping Tool." (Une mordache.)

Claim.—1st. The metal bars A, B, running angularly to each other, and attached at both ends, in combination with the sliding jaws C. 2nd. The combination of one or more sliding jaws with the metal bars A, B, running angularly to each other, and open at the widest end.

No. 2791. WILLIAM H. CORY & EDWARD CORY, London, Eng., 10th October, 1873, (Extension of Patent No. 2571), for 5 years: "Artificial Fuel Blocks." (Blocs de combustible artificiel.)

Claim.—The mixture of cement, or clay and silicate of soda or of potash with carbonaceous matter for the production of fuel blocks, as described.

No. 2792. JAMES MAGUIRE, Montreal, Que., 11th October, 1873, for 5 years: "Shafts and Poles of Vehicles." (Limonières et timons de voitures.)

Claim.—1st. The axle a, stage b, eyes c, and bolts d, in combination with two straight or ordinarily configured shafts e; 2nd. The novel combination of the axle a, stays b, splinter-bar c, and pole i, constructed, arranged and operating as described; 3rd. The novel arrangement of the socket a, and socket k, in combination with the stays b, and splinter bar c, and otherwise arranged as described, whereby the pole i, is rendered self-supporting; 4th. The pole i, having curved neck h.

No. 2793. PETER GERLACH, ANDREW KNIPPER & JOHN GERLACH, Cleveland, Ohio, U. S., 11th October, 1873, for 5 years: "A Stave Sawing Machine." (Machine à scier le merrain.)

Claim.—The combination of the carriage a, carriage bed c, provided with rails f, f, and adjustable gauge o, with the cylindrical saw b, when said carriage and bed are arranged at one side of the saw and constructed as described.

No. 2794. JAMES H. BAKER & ASA DONEY, Saratoga Springs, N. Y., U. S., 11th October, 1873, for 5 years: "Improved Bed Spring." (Resort de lit perfectionné.)

Claim.—1st. The casting A, provided with the flanges a, a, and sleeve b, in combination with the bushing i, pin c, constructed and arranged as set forth; 2nd. The casting A, provided with the flanges a, a, and sleeve b, in combination with the leather bush, ng i, pin C, spring B, and casting B, all constructed and arranged as specified.

THE CANADIAN PATENT OFFICE RECORD.

ILLUSTRATIONS.

Vol. I.

NOVEMBER, 1873.

No. 8.

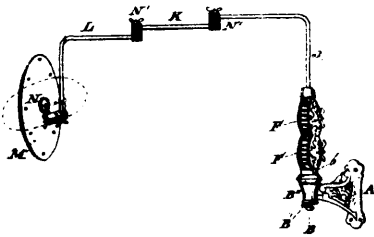

2734 Wood's Mirror Reflector and Toilet Glass.

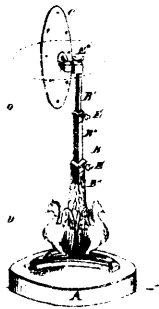

2735 Wood's Mirror Reflector and Toilet Glass.

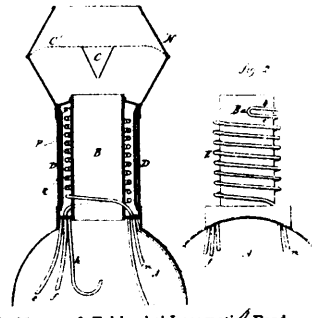

2736 Magoon & Fairbanks' Locomotive Feed Water Heater.

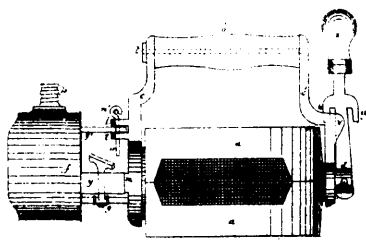

2737 Hinchliffe's Reversible Self-heating Smoothing Iron.

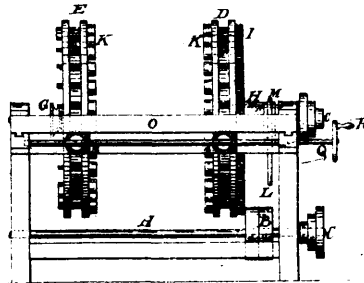

2738 Wilson's Machine for Turning Wood.

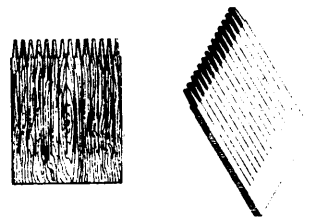

2739 Coffin's Split Match Card.

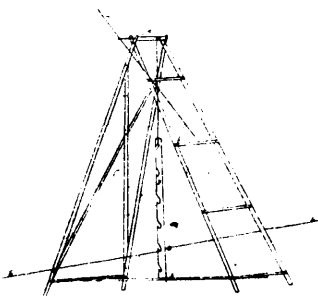

2740 Richmond's Thrashing Machine Jack.

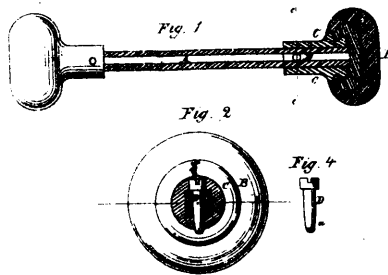

2741 Gray's Mode of Fastening Door Knobs to their Spindles.

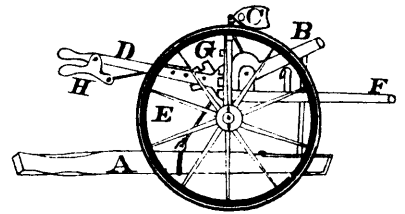

2742 Wattles' Carriage for Ploughs.

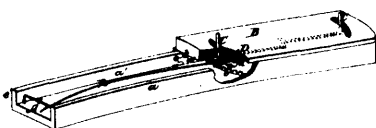

2744 Palmer's Stave Jointer.

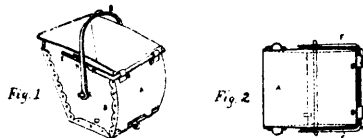

2745 Dederick's Self-dumping Tub.

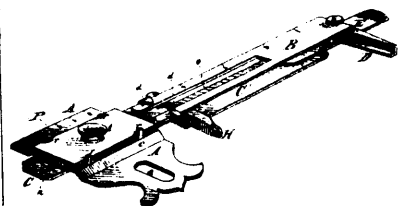

2746 Brown's Improvements on Tuckers.

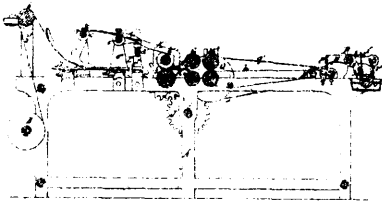

2747 Liddell, Thayer & Riddell's Machine for Making Paper Bags.

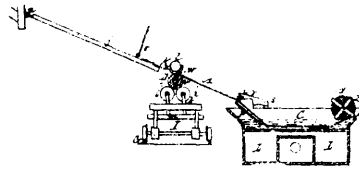

2748 Hebard's Manufacture of Pipe.

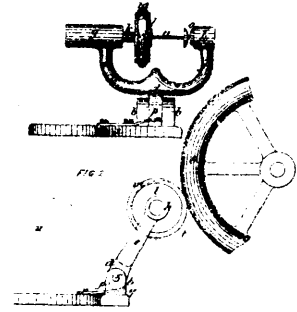

2749 Lawlor's Shuttle Bobbin Winder.

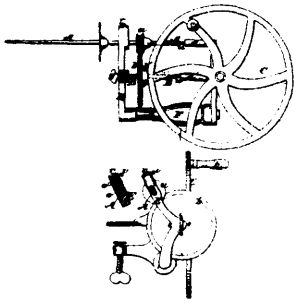

2750 Bryce's Spinning Wheel.

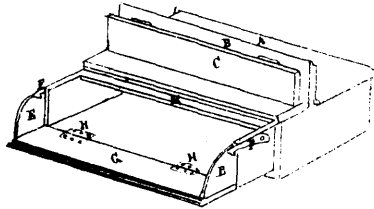

2751 McPherson's Secrétaire.

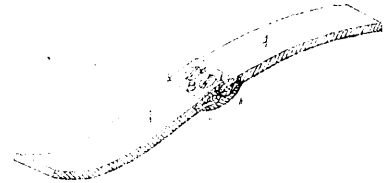

2752 Richard's Belt Fastening.

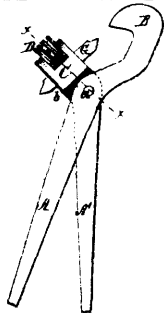

2753 Jarecki & Ormsbee's Improved Pipe Tongs.

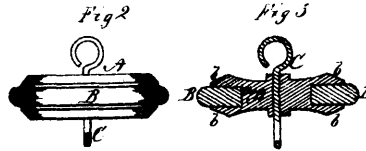

2754 Cooper's Bucket for Chain Pumps.

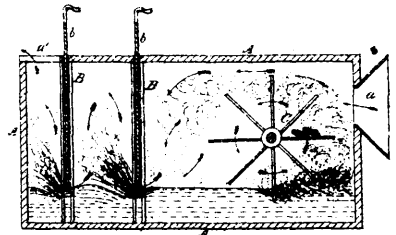

2755 Fuller's Ventilator and Dust Arrester.

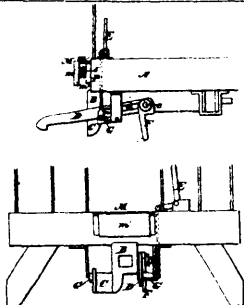

2756 Skidmore's Buffer and Coupling Apparatus for Railway and other Carriages.

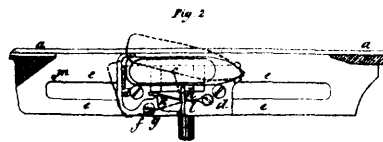

2757 Bennett's Shuttle Holder and Ejector of Sewing Machine.

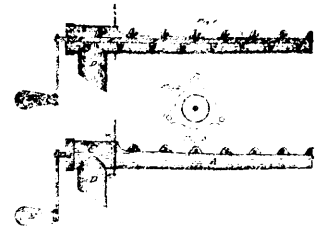

2758 Moffatt's Machine for Conducting Tea from Packages.

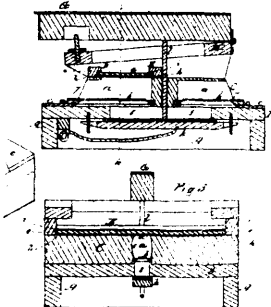

2759 Munroe's Reed Organ Board.

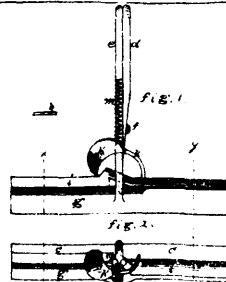

2760 Kenney's Machine for Joining Sheet Metal Plates by a Double Seam.

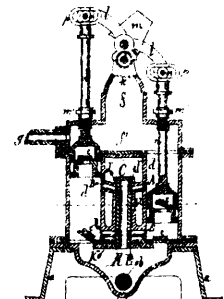

2761 Baxter's Improvements in Double-Acting Force and Lift Pumps.

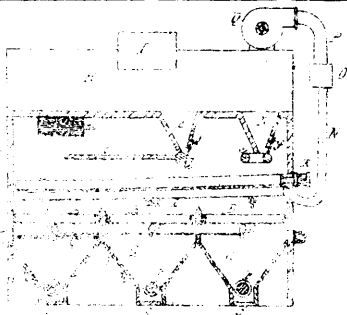

2762 Lacroix's Middlings Separator and Purifier.

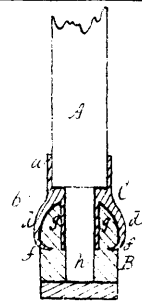

2763 Mitcheli's Spoke Socket for Wheels.

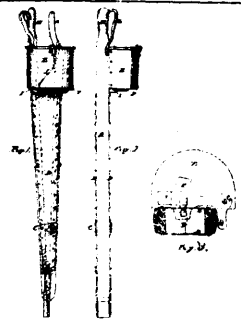

2764 Brown's Corn Planter.

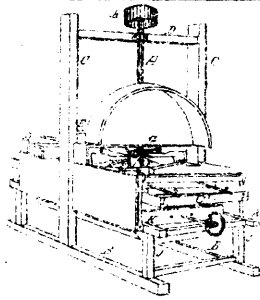

2765 Barker's Machine for Sand Papering Lumber.

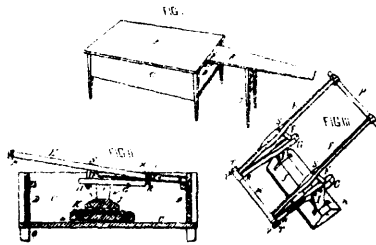

2766 Langworthy's Washing Machine and Ironing Table.

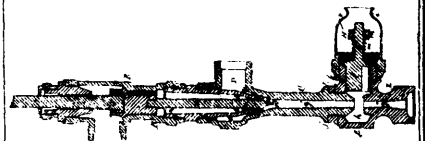

2767 Mack's Steam Injector or Ejector.

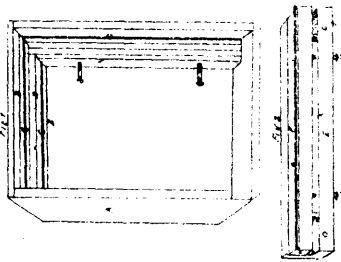

2768 Hull's Weather Strip for Doors and Windows.

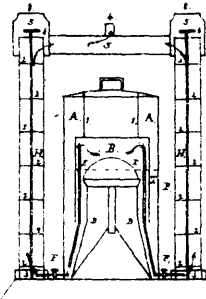

2769 De Guison's Apparatus for Carburetting Hydrogen Gas.

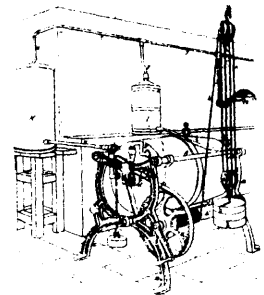

2770 Richard's Portable Air Gas Machine.

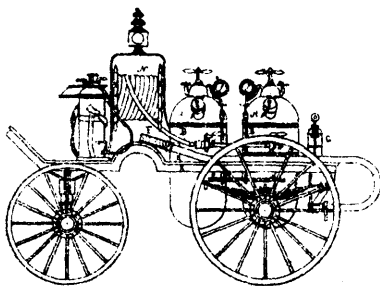

2771 Stillson & Kley's Chemical Fire Engine.

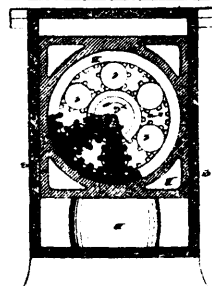

2772 Eccles' Frictionless Journal and Shaft Bearings.

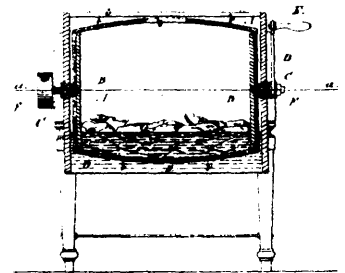

2773 Bradley's Washing Machine.

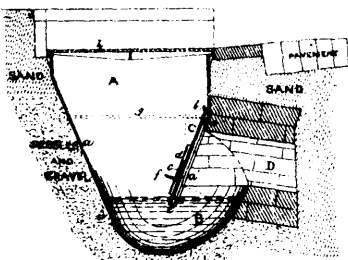

2774 Dark's Receiver and Stench Trap of Street Sewer.

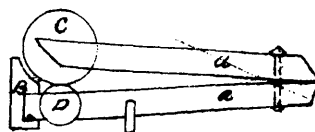

2775 Forfar's Machine for Wringing Clothes.

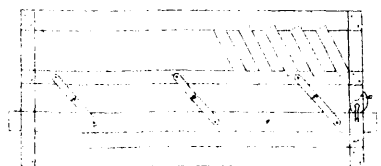

2776 Reed's Frame for Stretching Hides and Leather.

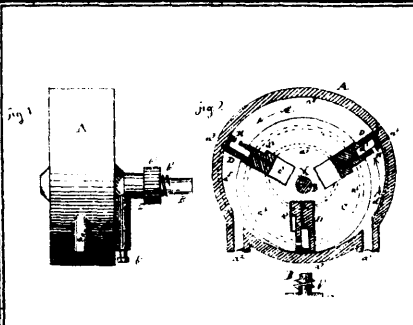

2777 Hawley's Fluid Measuring Motor.

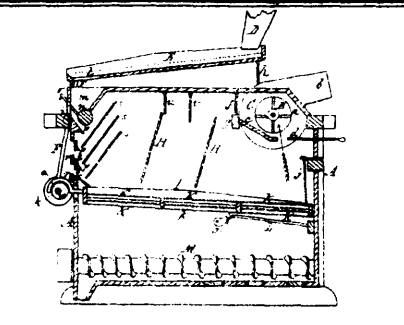

2778 Trimmer's Middlings Separator and Purifier.

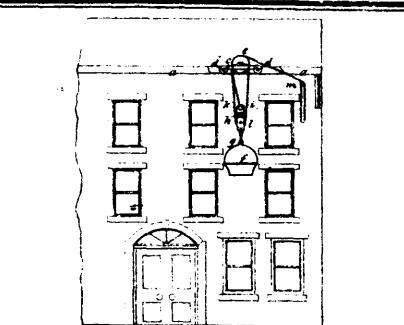

2779 Hay & Perks' Fire-escape.

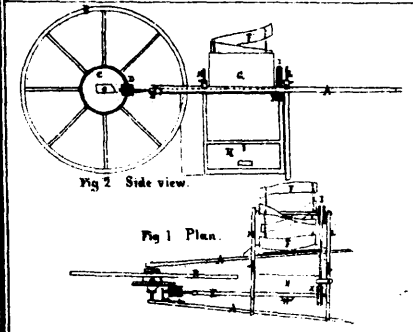

2780 McArthur's Machine for Capturing Potato Bugs.

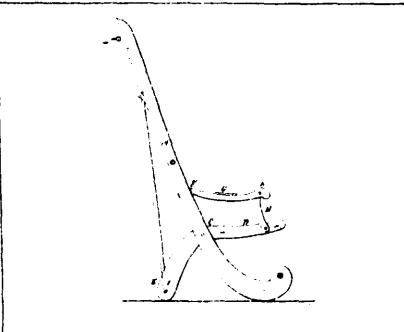

2782 Vass' Combined Chair and Lounge.

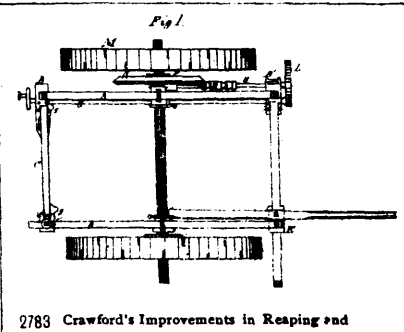

2783 Crawford's Improvements in Reaping and Mowing Machines.

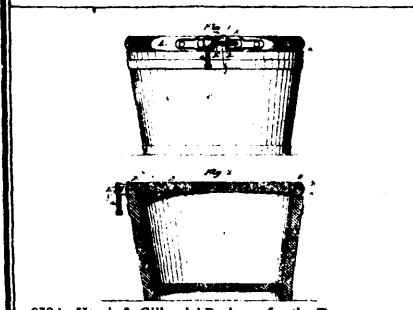

2784 Harris & Gilberts' Package for the Transportation and Preservation of Perishable Substances.

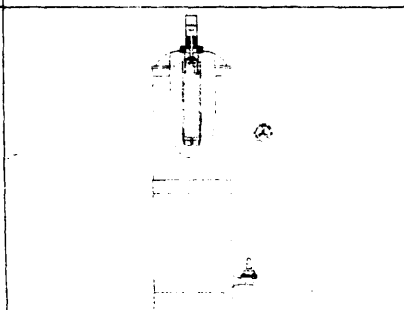

2786 Dick's Fire Extinguisher.

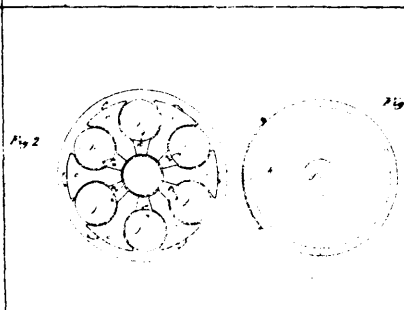

2787 Vernon's Improvements on Coal Cooking Stoves.

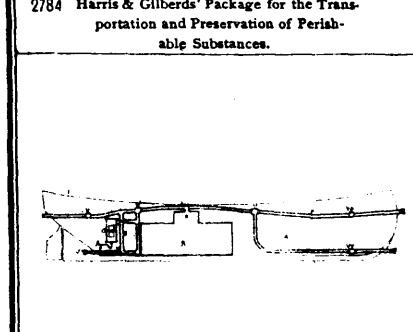

2788 Rourke's Improvements in the Propulsion and Steering of Boats by Steam.

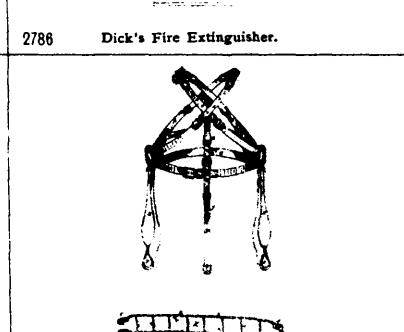

2789 Parent's Fire-escape.

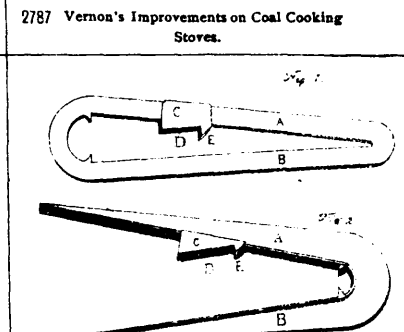

2790 Kinney's Clamping Tool.

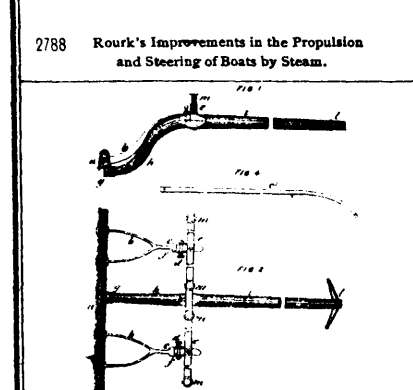

2792 Maquire's Shafts and Poles of Vehicles.

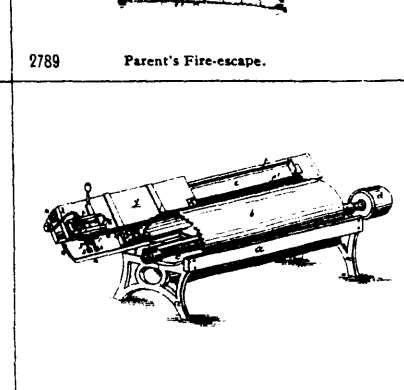

2793 Gerlach, Knipper & Gerlach's Stave Sawing Machine.

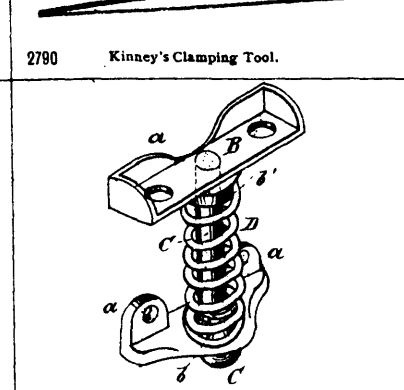

2794 Baker & Doney's Improved Bed Spring.