

**CIHM  
Microfiche  
Series  
(Monographs)**

**ICMH  
Collection de  
microfiches  
(monographies)**



**Canadian Institute for Historical Microreproductions / Institut canadien de microreproductions historiques**

**© 1997**



The copy filmed here has been reproduced thanks to the generosity of:

Osler Library,  
McGill University,  
Montreal

The images appearing here are the best quality possible considering the condition and legibility of the original copy and in keeping with the filming contract specifications.

Original copies in printed paper covers are filmed beginning with the front cover and ending on the last page with a printed or illustrated impression, or the back cover when appropriate. All other original copies are filmed beginning on the first page with a printed or illustrated impression, and ending on the last page with a printed or illustrated impression.

The last recorded frame on each microfiche shall contain the symbol  $\rightarrow$  (meaning "CONTINUED"), or the symbol  $\nabla$  (meaning "END"), whichever applies.

Maps, plates, charts, etc., may be filmed at different reduction ratios. Those too large to be entirely included in one exposure are filmed beginning in the upper left hand corner, left to right and top to bottom, as many frames as required. The following diagrams illustrate the method:

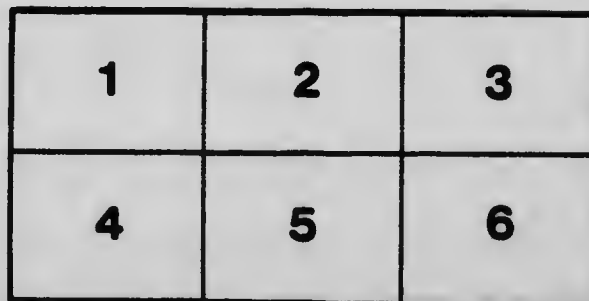
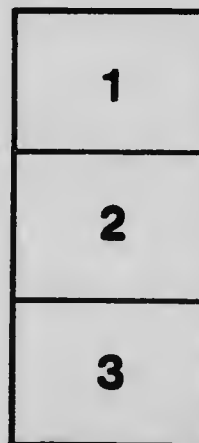

L'exemplaire filmé fut reproduit grâce à la générosité de:

Osler Library,  
McGill University,  
Montreal

Les images suivantes ont été reproduites avec le plus grand soin, compte tenu de la condition et de la netteté de l'exemplaire filmé, et en conformité avec les conditions du contrat de filmage.

Les exemplaires originaux dont la couverture en papier est imprimée sont filmés en commençant par le premier plat et en terminant soit par la dernière page qui comporte une empreinte d'impression ou d'illustration, soit par le second plat, selon le cas. Tous les autres exemplaires originaux sont filmés en commençant par la première page qui comporte une empreinte d'impression ou d'illustration et en terminant par la dernière page qui comporte une telle empreinte.

Un des symboles suivants apparaîtra sur la dernière image de chaque microfiche, selon le cas: le symbole  $\rightarrow$  signifie "A SUIVRE", le symbole  $\nabla$  signifie "FIN".

Les cartes, planches, tableaux, etc., peuvent être filmés à des taux de réduction différents. Lorsque le document est trop grand pour être reproduit en un seul cliché, il est filmé à partir de l'angle supérieur gauche, de gauche à droite, et de haut en bas, en prenant le nombre d'images nécessaire. Les diagrammes suivants illustrent la méthode.

# MICROCOPY RESOLUTION TEST CHART

(ANSI and ISO TEST CHART No. 2)

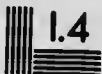
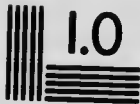

**APPLIED IMAGE Inc**

1653 East Main Street  
Rochester, New York 14609 USA  
(716) 482 - 0300 - Phone  
(716) 288 - 5989 - Fax

*To Dr. Shepherd*

*with my compliments.*

*Jan 19.05.*

*L. H. Key*

# MCGILL UNIVERSITY

## MEDICAL FACULTY



# CATALOGUE

OF THE

## HYGIENE MUSEUM

---

DECEMBER, 1904

---

MONTREAL:

MORTON, PHILLIPS AND Co., PRINTERS AND STATIONERS  
1757 NOTRE DAME STREET.

1905.

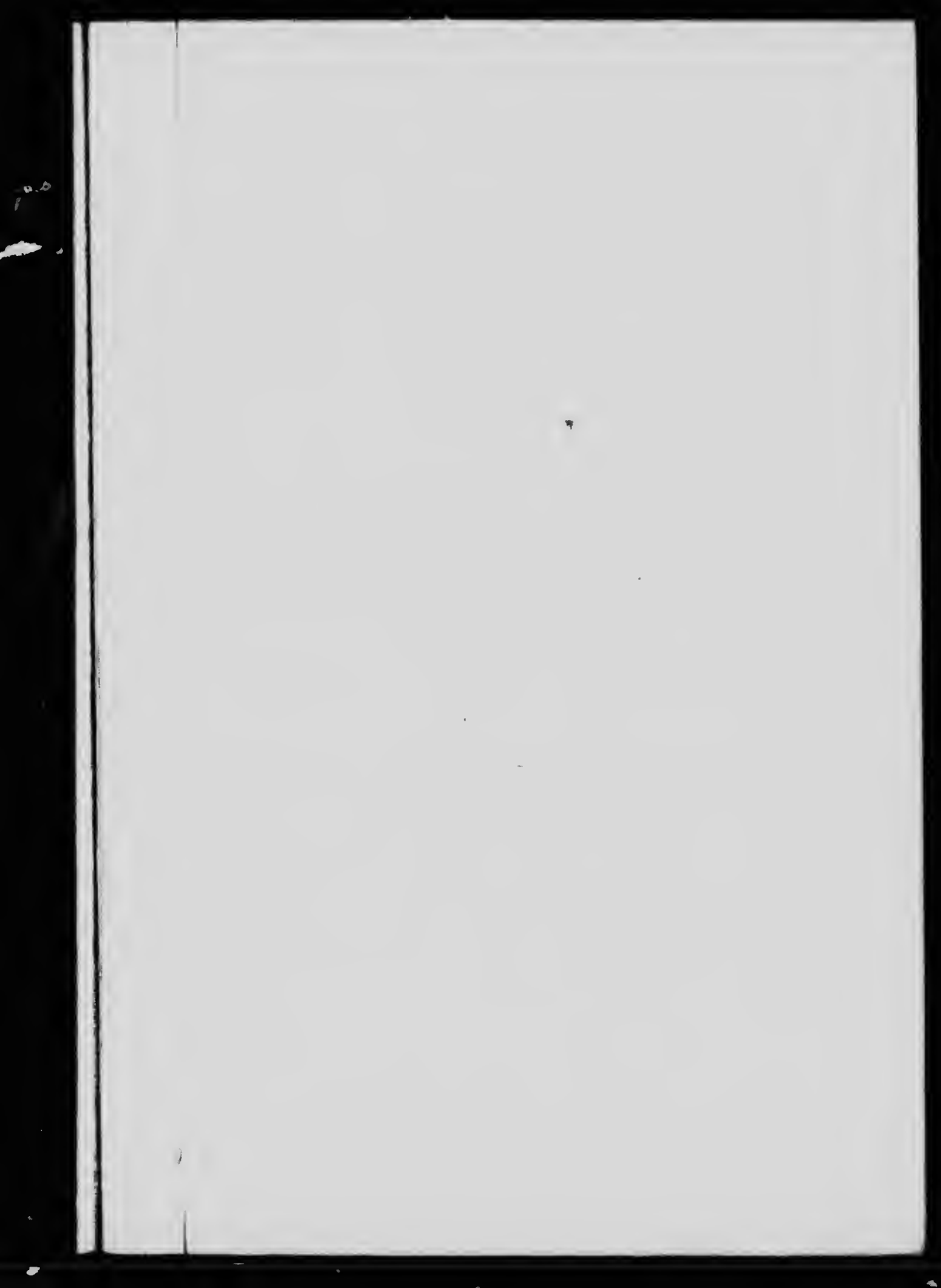



# MCGILL UNIVERSITY

## MEDICAL FACULTY



## CATALOGUE

OF THE

## HYGIENE MUSEUM

---

DECEMBER, 1904

---

MONTREAL:

MORTON, PHILLIPS AND Co., PRINTERS AND STATIONERS.

1757 NOTRE DAME STREET.

---

1905.





## PREFACE.

---

In compiling this Catalogue of the Hygiene Museum, I have endeavoured to keep the amount of description and explanation down to a minimum.

It will be noticed that in the choice of the various exhibits, the chief idea has been always to make each specimen a "type" of a class. This has been done for two reasons—first, in order to keep the collection within reasonable limits, and, secondly, to avoid repetition as far as possible.

This method of dealing with "types" of classes, will, I think, prove of more value to the student of Hygiene, than the individual consideration of numberless specimens of each class—for in studying the "type," special attention may be paid to the "working principles" of the class—which principles can be applied to any particular specimen.

In this way, I think, a more lasting and serviceable impression is created in the mind, than by a cursory examination of a multitude of specimens, all exhibiting the same working principles with slight modification in each case.

With this in view, explanatory diagrams of the more important or complicated apparatus have been enclosed in the catalogue.

The Decimal System has been adopted throughout classifying and numbering the exhibits.

The different sections of the Museum are indicated by large numbers, corresponding to the Sectional numbers in the Catalogue.

My best thanks are due to Dr. F. B. Jones for his kindly assistance, which he has given in the work.

T. A. STARKEY

HYGIENE LABORATORY,  
MCGILL UNIVERSITY,

*Dec. 9th, 1904.*

oughout in

licated by  
umbers in

es for the

**RKEY.**



## SECTION I.—DISINFECTION.

### 1.1 Disinfectants.

A disinfectant, or germicide, is an agent which is capable of killing or destroying micro-organisms, especially the pathogenic varieties. To attain this result the disinfectant must be applied in a certain definite strength; when used in weaker proportions it may only inhibit the growth and not actually kill the organism.

A complete list of disinfectants would include, besides those enumerated below, such agencies as fire, heat (moist and dry), sunlight and oxygen. The subjoined list, however, comprises all the more common disinfectants in ordinary use, and of these

Carbolic Acid, Perchloride of Mercury, Sulphur, Chlorine, Iodoform, Potassium Permanganate, and Formalin, are most employed, and the strengths are given in which they may be relied upon to disinfect completely all organisms, both spore-bearing and non-spore-bearing.

Carbolic Acid, Perchloride of Mercury, Sulphur, Chlorine, and Formalin, are described more in detail later on.

#### 1.11 NATURAL DISINFECTANTS.

- |                   |                 |
|-------------------|-----------------|
| 1.111 Turpentine. | } Applied pure. |
| 1.112 Eucalyptus. |                 |
| 1.113 Eucalyptol. |                 |
| 1.114 Camphor.    |                 |

## 1.12 COAL TAR PRODUCTS.

- 1.121 Aniline.
- 1.122 Carbohc Acid. 5%.
- 1.123 Creosol, 4%.
- 1.124 Salicylic Acid.
- 1.125 Thymol. } Solution in Alcohol, 1%.
- 1.126 Menthol. }
- 1.127 Resorein. }
- 1.128 Iodoform. Applied pure.
- 1.129 Formochlorol. Formalin and Calc  
Chloride.
- 1.120 Formalin. 3-10% solution.

## 1.13 INORGANIC DISINFECTANTS.

- 1.131 Lime. (1 Slaked Lime. Water, 4 parts)
- 1.131a Chlorinated Lime. 5%.
- 1.132 Boric Acid. 5%.
- 1.133 Borax.
- 1.134 Chromic Acid. 1%.
- 1.135 Corrosive Sublimate. 1%.
- 1.136 Zinc Sulphate.
- 1.137 Iron Sulphate.
- 1.138 Copper Sulphate.
- 1.139 Potassium Permanganate. 1%.
- 1.130 Sulphur. (SO<sub>2</sub> 1%.)

## 1.14 PATENT DISINFECTANTS.

- 1.141 Specimens of Jeye's patent disinfecting  
and soaps.

## 1.2 Disinfectants Commonly Used.

### 1.21 SPECIMENS OF SULPHUR BLOCKS

for generating Sulphur Dioxide Gas.

Many varieties are made; the ones with wicks burn somewhat better, and are not so liable to go out as the ones without.

Minimum amount—1 lb. Sulphur for every thousand cubic feet of space. This gives in actual practice about 1%  $\text{SO}_2$ . For disinfection the presence of moisture is very essential.

### 1.22 SPECIMEN OF CHLORINATED LIME

ordinarily used for the generation of Chlorine Gas.

This is made up in 1 lb. tins for convenience; the gas is generated by adding a pint of crude Hydrochloric Acid to each pound of Chloride of Lime.

Plenty of moisture must first be supplied in order that thorough disinfection may ensue.

### 1.23 SPECIMEN OF FORMALIN.

This is a 40% solution of Formaldehyde in water. "Formalin" is the technical or trade name for this solution.

It deteriorates rather quickly, and after being kept a month or two usually contains about 33-36% of Formaldehyde.

The Formalin Gas is generated from this by boiling in one of the special generators.

### 1.24 SPECIMEN OF TRIFORM TABLOIDS.

This is a polymer of Formaldehyde. Chemically, it consists of three molecules of Formaldehyde, and



can be obtained from a solution of Formaldehyde the addition of dilute Sulphuric Acid.

When heated it is dissociated again into Formaldehyde Gas.

This is one of the original methods of generating Formaldehyde.

#### 1.25 SPECIMEN OF CARBOLIC ACID.

Used generally in strength 1 in 20, occasionally weaker 1 in 40.

#### 1.26 PERCHLORIDE OF MERCURY.

Used in solutions ranging in strength from 500 to 1 in 10,000.

### 1.3 Formalin Machines.

#### 1.31. HAND SPRAYING MACHINE.

A portable machine for spraying disinfecting solutions, such as Formalin or Carbolic Acid, walls, etc.

This machine is the one usually employed by municipalities.

#### 1.32 HAND SPRAYING MACHINE.

This is on the same principle as No. 1.31, a cheaper variety, being made of common tin.

#### 1.33 HAND SPRAY.

A small hand spray for Formalin.

#### 1.34 ALFORMANT LAMP.

This lamp is for the use of Paraform Tablets. The Tablets are placed in the iron cup above the lamp.

maldehyde by

nto Formalde-

of generating

, occasionally

th from 1 in

nfecting solu-  
e Acid, upon

employed by

No. 1.5, but  
on tin.

rm Tabloids.  
up above the

FIG. FORMALDEHYDE GAS GENERATOR.

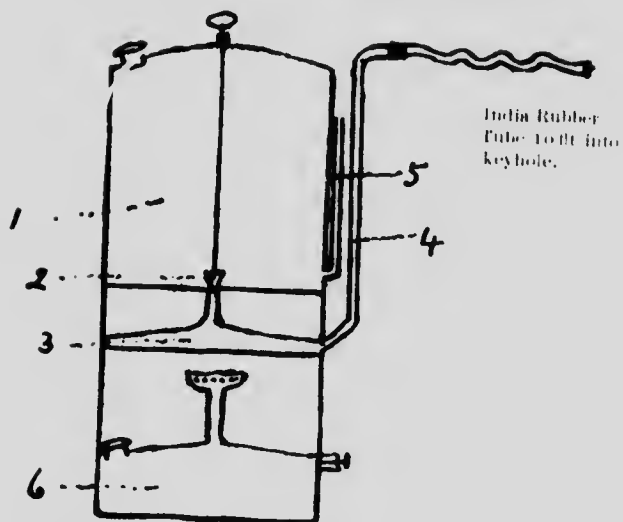

1. Reservoir for Formalin.
2. Valve regulating flow.
3. Heated Chamber in which gas is generated.
4. Exit Tube for gas.
5. Gauge for Reservoir.
6. Primus Lamp.

spirit lamp ; the heat from this causes the Formaldehyde Gas to be evolved from the Tabloids.

A minimum of 20 Tabloids to the thousand cubic feet of space is to be recommended.

#### 1.35 FORMALIN GENERATOR.

The Formalin Solution is placed in the copper boiler above ; the heat is supplied from a spirit lamp below, the gas coming off through the funnel-shaped nozzle when the solution boils.

#### 1.36 FORMALIN GENERATOR.

The principle involved in this is the same as in No. 1.35, except that the heat is supplied by a kerosene primus lamp.

#### 1.37 FORMALIN GENERATOR.

The construction is practically the same as No. 1.36, but, in addition there is a long India rubber tube attached to the gas nozzle, so that the apparatus can be used outside the room.

The India rubber tube is inserted through the key-hole, or some other suitable aperture, and the gas, as it is evolved, is conducted into the room by means of the tubing. This is an advantage over the preceding generators, for the reason that the whole operation can be watched and regulated from the outside, whereas, in the preceding ones, the lamps are placed in the room, and, after having been started, are left there without further supervision.

#### 1.38 FORMALIN GENERATOR.

This has a tubular boiler in place of the simple copper boiler, as in the preceding specimens.

### 1.39 ROBINSON'S FORMALIN LAMP.

This lamp is for use with Alcohol.

### 1.30 TRILLAT'S FORMO-CHLOROL GENERATOR.

This machine is in all respects similar to an ordinary autoclave. The Formalin Solution is placed in the inner chamber, quantities recommended being not less than a litre, and not more than three and a half litres. The cover is screwed down and heat applied below by means of the ordinary primus lamp.

When the manometer registers a pressure of three atmospheres, the stop cock is slowly turned on. The temperature at this pressure is generally about 135°C and it is not desirable to take it beyond this. The gas which comes through the stop cock can be conducted into the room through a hole, or some other aperture, by means of an India rubber pipe.

## 1.4 Steam Disinfecting Apparatus.

### 1.41 SIMPLE APPARATUS FOR PASTEURISING MILK.

Water is placed in the can to a depth of about 3 inches; the bottles, after having been perfectly cleansed, are filled with milk to within about an inch of the neck. One bottle is filled with water and a thermometer inserted through the cover so that the temperature of the water in the bottle can be registered. The bottles are then placed in the rack, the corks being lightly inserted to allow of the escape of steam, the whole placed in the water and the cover adjusted. Heat is applied below, and the temperature of the milk inside the bottles is carried

to an  
ation is  
mended  
an three  
own and  
y primus

of three  
n. The  
t 135°C,  
is. The  
can be  
or some  
pipe.

of about  
perfectly  
an inch  
ter and  
that the  
be regis-  
ack, the  
scape of  
and the  
and the  
s carried

REFERENCE.

1. Disinfecter.
2. Steam Valve.
3. Automatic Steam Valve.
4. Air Chamber, actuating Automatic Steam Valve.
5. Stop Cock.
6. Safety Valve.
7. Valve on Pipe for Air.
8. Water Chamber.
9. Stop Cock.
10. Water Supply Valve to Disinfecter.
11. Thermometer.
12. Stop Cock Outlet.
13. Boiler.
14. Water Supply to Boiler.
15. Safety Valve.

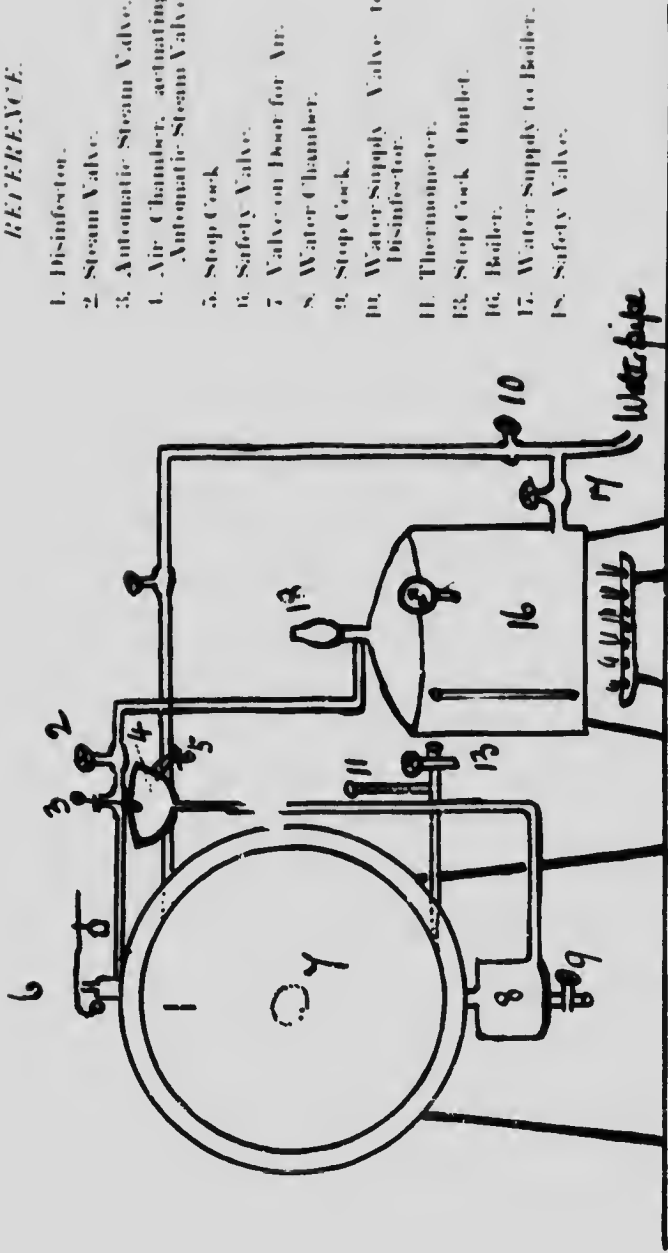

FIG. 1. STEAM DISINFECTOR.

to from 70-80°C for 15-20 minutes. It is then allowed to cool down.

The cover is then taken off, and the corks quickly pressed tight into the necks of the bottles.

If necessary this procedure can be repeated at the end of 12 or 24 hours so as to give the milk a double pasteurization, but this is not commonly practised.

#### 1.42 RECK'S STEAM DISINFECTOR.

To work this apparatus the first step is to warm up the chamber. This is done by opening the outlet (13) and then admitting the steam slowly through the valve (2).

The next step is, to place the articles to be disinfected inside the chamber on a rack, spreading them out so that the steam can penetrate thoroughly. It is now closed and steam valve (2) opened slowly, the outlet valve (13) being kept fully open; the little air valve (5) is also opened.

The steam is allowed to pass through until all the air from the inside of the chamber has been completely driven out. When this is accomplished the thermometer (11) will indicate 100°C. The valve (13) is now closed and the pressure begins to rise. This pressure forces the water from the chamber (8) into the ball (5), and when the water begins to run out of the little stop-cock (5) the latter must be closed.

This ball is the reducing valve which automatically shuts off the steam, when the pressure has reached two-thirds of a pound. The process is allowed to go on for 20 minutes. The steam valve (2) is then shut off, the outlet (13) opened, and cold water admitted by opening the tap (10). This cold water condenses the steam in the disinfector.



The delivery door of the disinfecter is now open, the carriage drawn out, and emptied. The disinfected articles must be shaken in the open air to remove steam, and to dry them.

The diagram of the steam boiler explains it all, but, before commencing the disinfection, the pressure gauge should always record 26 lbs.

#### 1.43 MODEL OF KNY'S STEAM DISINFECTOR.

This is in full working order with Formosa Injector.

#### DIRECTIONS FOR WORKING.

The clothes, or articles to be disinfected, are placed on the rack within the chamber of the disinfecter through the opening marked (1.) The doors are tightly closed, valve (8) is opened to allow of escape of air; valve (9) is also opened, and steam is then allowed to circulate within the jacket by means of valve (6.) After a few minutes, the chamber until the chamber has been thoroughly heated, valve (9) is closed; the steam is thus under pressure in the jacket, and is allowed to remain so for ten or fifteen minutes. This is done with the object of warming up the contents of the inner or disinfesting chamber in order that no condensation may take place when the live steam is admitted around the infected articles. Valves (5) are then opened and the steam rushes in to the inner chamber, displacing the air through openings (8.) In a few minutes it will be seen that the whole of the air has been displaced when valves (8) can be closed and the live steam left in contact with the articles to be disinfected for about one half, to one hour.

L.B. KNY'S STEAM DISINFECTOR

low opened,  
ne different  
remove the

lains itself,  
he pressure

Formalin

, are placed  
disinfector  
ors are then  
low of the  
d, and the  
the jacket  
tes, that is,  
eated, valve  
ssure in the  
n or fifteen  
of warming  
ng chamber,  
place when  
e infectious  
d the steam  
ing the air  
es it will be  
n displaced.  
live steam  
infected for

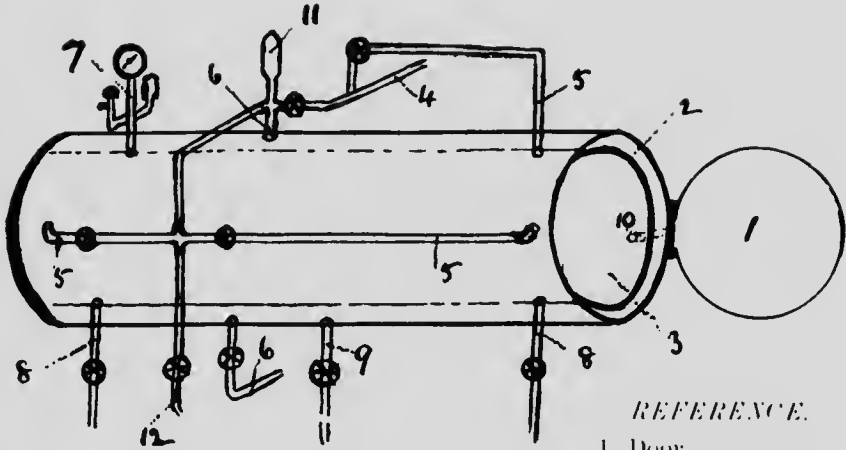

REFERENCE.

1. Door.
2. Outside Chamber or Steam Jacket.
3. Inside Chamber into which articles to be disinfected are placed.
4. Main Steam Pipe from Boiler.
5. Steam Pipes to Inner Chamber.
6. Steam Pipes to Outer Chamber or Jacket.
7. Pressure Gauge with Safety Valve, communicating with inner Chamber.
8. Outlets for Air, Condensed Steam, etc., from Inner Chamber.
9. Outlets for Air, Condensed Steam, etc., from Jacket.
10. Pipe from Formalin Injector to Inner Chamber.
11. Safety Valve.
12. Waste Pipe for Steam.

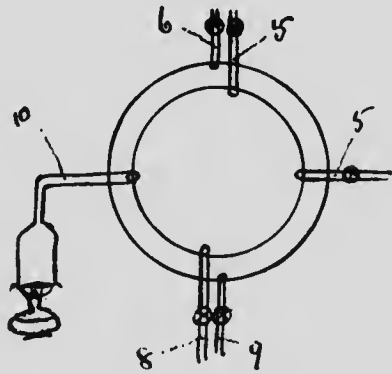

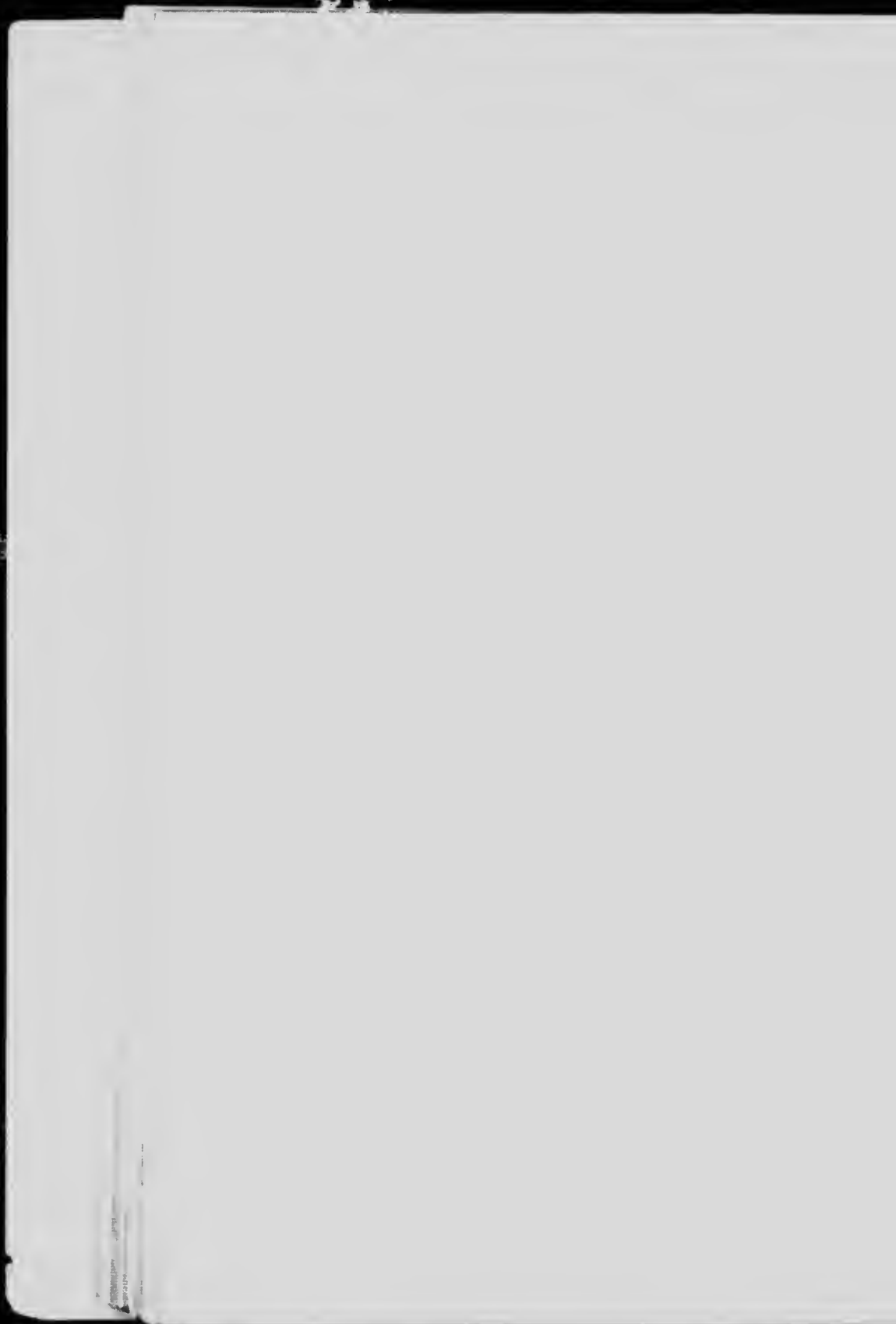

It is exceedingly important that the whole of the air inside the disinfecting chamber shall be displaced before valves (8) are closed, otherwise efficient disinfection does not take place.

If desired, at this point, Formalin vapour can be driven into the inner chamber, to aid in disinfection. This is done by placing a pint of Formalin in the little boiler by the side, adjusting the flame beneath, and when the solution boils the vapour forces its way into the inner chamber.

When sufficient time has elapsed for disinfection, the steam to the inner chamber is cut off by closing valves (6), and valves (8) are opened so as to admit air. The jacket is still kept working, and in this way the articles in the interior are quickly dried. This requires only about ten to fifteen minutes. At the end of that time the steam to the jacket is cut off by closing valves (6), the door at the opposite end of the sterilizer is opened and the articles taken out into the next room, for as will be seen from the model, the ends of the sterilizer project into different rooms, one being reserved for infectious articles, the other for the disinfected ones; in this way contamination is avoided.

#### 144 MODEL OF THRESH'S STEAM DISINFECTOR.

This consists of a boiler jacket, the space enclosed being the disinfecting chamber.

The articles to be disinfected are placed in the cage in the interior, the door closed, the steam turned on, and allowed to pass through the chamber under the ordinary atmospheric pressure.

The boiler is a simple boiler, except that the water consists of a 2% solution of Calcium Chloride. This is used in order that a temperature of 105°C. may be

imparted to the steam as it comes off from the solution. Hence the articles in the inter-sterilized by means of current steam at about The process lasts about 40 minutes, to an hour

This disinfector is usually mounted on wheels is one eminently suitable for poor rural centers where it is impossible to establish one central infecting station.

## 1.9 General.

### 1.91 SAMPLES OF TARPAULIN USED IN DISINFECTION

Infected clothes and material generally are sprinkled with some disinfectant, wrapped in tarpaulins and safely conveyed to the public or private, disinfecting station.

### 1.92 SPECIMEN OF CANVAS BUCKET USED IN DISINF

from the boiling  
the interior are  
at about 105°C.  
an hour.

on wheels, and  
rural districts  
the central dis-

#### FECTION.

erally can be  
pped in these  
he public, or

#### DISINFECTION.

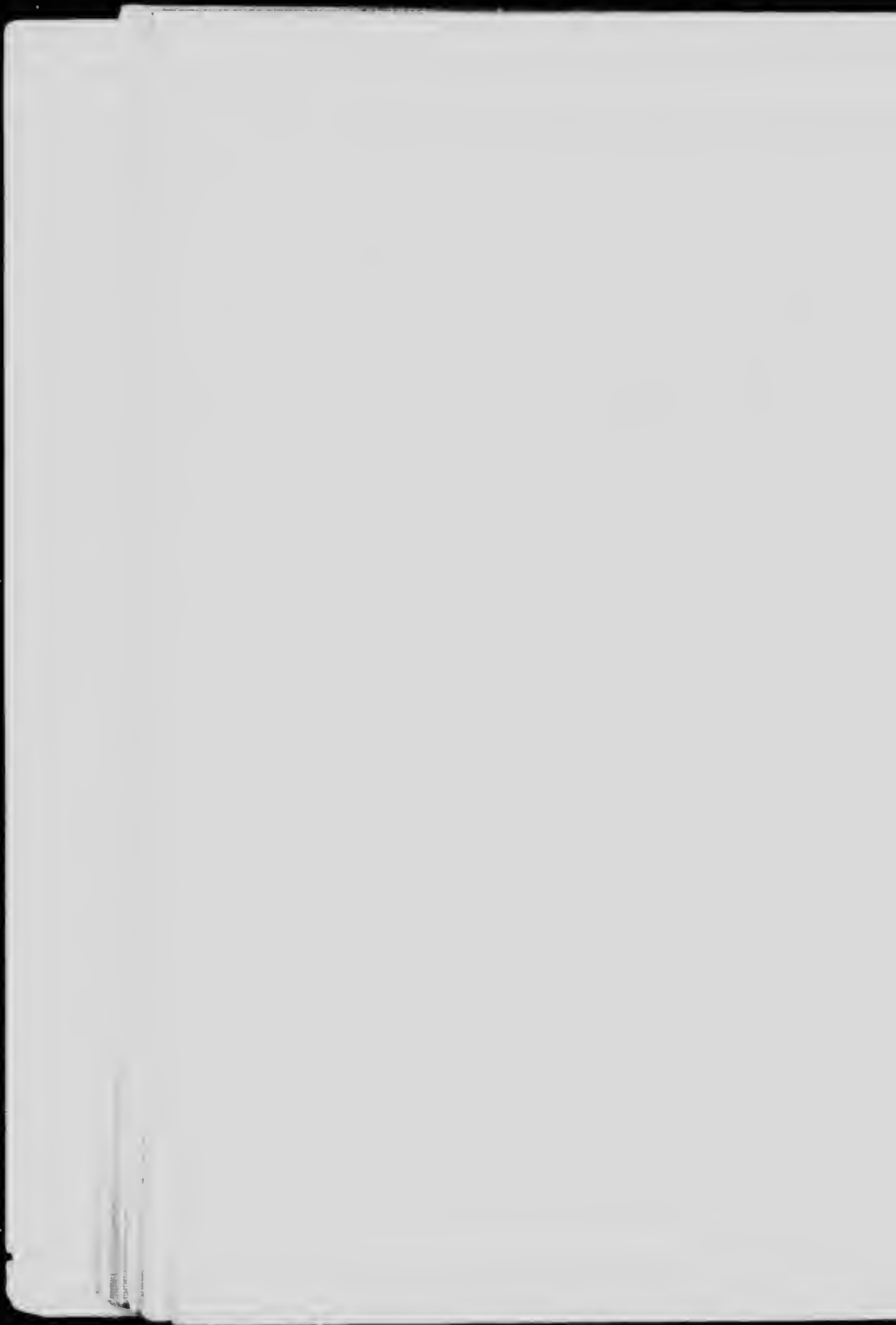

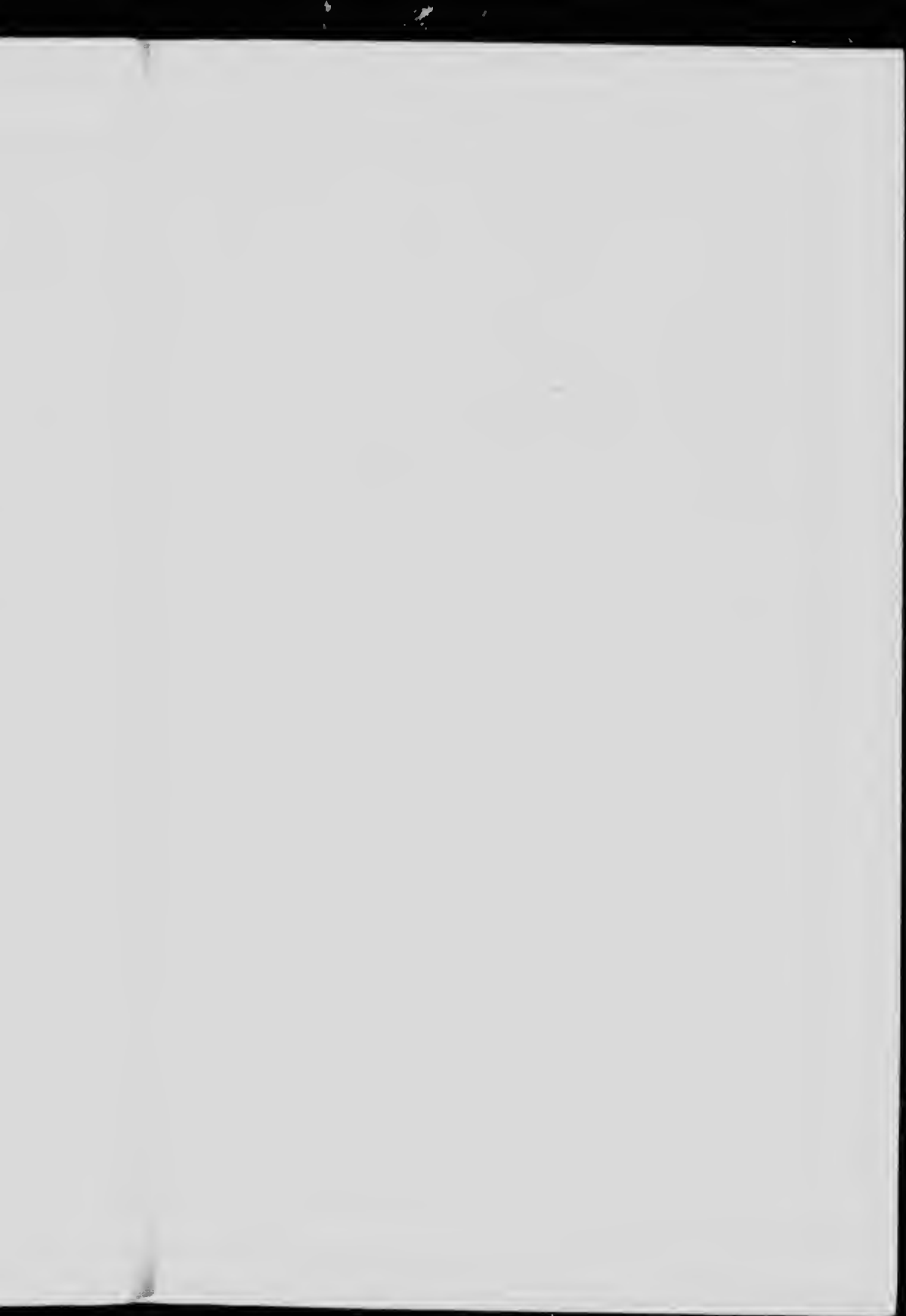









## SECTION II.—HEATING AND LIGHTING.

### *HEATING.*

In this Section are exhibited various kinds of stoves and grates used for heating purposes. It will be noted that the exhibits are worked by gas, but it is to be borne in mind that, although the heating agent is gas, the same remarks apply with equal force to any other agent, such as oil, coal, coke or wood.

The manner in which the heating is generated is of little importance. That which concerns us from a hygienic point of view is the working principle of the stove or grate, paying particular attention to the mode in which the heat is radiated or conveyed, and also, as to what becomes of the products of combustion.

#### **2.1 Stoves.**

(Presented by Messrs. Fletcher Russell & Co., Warrington, England.)

##### **2.11 SINGLE BURNER GAS STOVE.**

This apparatus can be placed in any part of a room; the products of combustion are conducted straight into the apartment, there being no flue connected with a chimney, or other outlet. The heating is accomplished by simple convection, the air in the room comes into contact with the heated portions of the stove, and by virtue of being heated, rises and diffuses itself into the apartment generally.

The principle is a bad one, seeing that the idea of such a place would be breathing the air with the products of combustion.

#### 2.12 HEATING STOVE WITH SIX GAS JETS.

The principle of heating with this apparatus is much more preferable to that of 2.11. The products of combustion are conveyed by means of a flue to a chimney, and so into the outside air. Again, fresh air, from the outside, is conducted, by means of a duct, through the heated portion of the stove, and is allowed to have free access to the apartment. In this way the stove acts as a good ventilator, admitting the fresh air from the outside, and at the same time warming it if the outside air be too cold.

#### 2.13 GAS FIRE GRATE.

This is supplied with patent non-strike-back Bunsen burners. The flame from the burners is directed on to an iron fret-work, which becomes red-hot and radiates its heat into the room just like an ordinary fire. The products of combustion are conveyed by means of a flue to the chimney, and so into the outside air. The stove is enamelled with porcelain silicate enamel, which is not affected by heat.

The chief point about this stove is the large heating surface presented to the room, and, with a given consumption of gas, throws out far more heat than an ordinary gas fire.

#### 2.14 BALL FIRE GAS GRATE.

This has patent non-strike-back Bunsen burners, and the principle of heating involved is that of simple radiation, exactly similar to 2.13, but

at the inmates  
e air vitiated

apparatus is  
The products  
of a flue to  
Again, fresh  
ans of tubes,  
tove, and so  
artment. In  
or, admitting  
ne same time

n-strike-back  
urners plays  
es red hot,  
just like an  
ion are con-  
y, and so to  
with patent  
heat.  
arge heating  
a given con-  
at than the

en burners.  
is that of  
3, but the

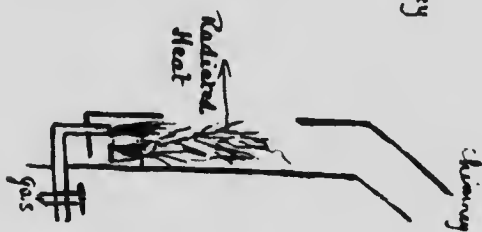
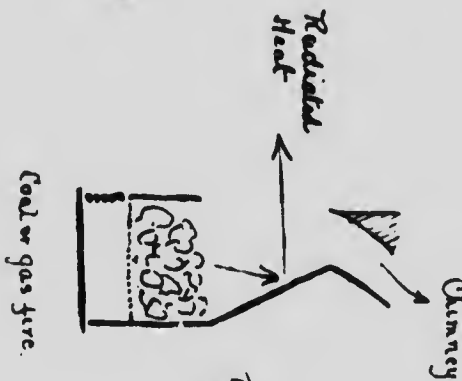
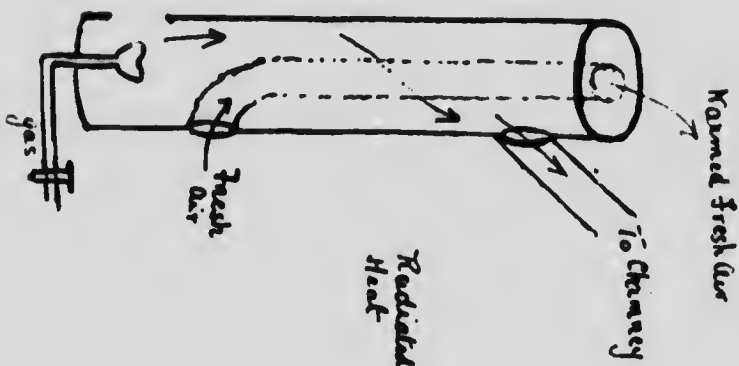
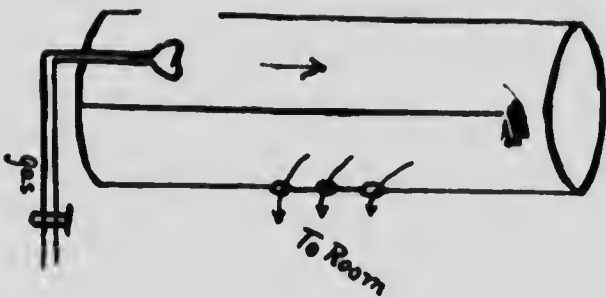

2

100

100

amount of heat given off from this fire with the same amount of gas consumed as in 2.13, is very much less.

The products of combustion are conveyed to the chimney; the grate is enamelled with patent silicate enamel

#### 2.15 BALL FIRE GAS GRATE.

This has the patent non-strike-back Bunsen burners, and is the same in every respect as 2.14, except that ordinary Japan black is used as the enamel. This Japan black, when heated, gives rise to a very offensive odor.

### 2.2 Gas Burners (Heating.)

(Presented by Messrs. Fletcher Russell & Co., Warrington, England.)

#### 2.21 SPECIMEN OF DOUBLE RING BUNSEN BURNER.

#### 2.22 SPECIMEN OF SINGLE RING BUNSEN BURNER.

#### 2.23 SPECIMEN OF PATENT SAFETY BUNSEN BURNER.

As used in laboratories, etc.

### 2.3 Radiators and Appliances.

#### 2.31 WORKING MODEL OF SYSTEM OF HEATING BY HOT WATER RADIATORS.

This model illustrates the circulation of hot water through pipes, radiators, and coils: the principle involved being that of convection, and radiation to a much less extent.

The hot water rises by virtue of its lessened density, but as it passes through the coils it becomes cooled, and its density thereby increased, the latter causing it to sink to the boiler, where it is again warmed up, and so the process of circulation continues.



### 2.32 WORKING MODEL OF ORDINARY HOT WATER SYSTEM USED IN A HOUSEHOLD.

This model illustrates the circulation of hot water in pipes. It is fitted with glass tubes and expansion joints, boiler, gas burner, circulating tank, bath and sink supplies.

### 2.33 SMALL WATER TUBE BOILER.

(Presented by Messrs. Fletcher Russell & Co., Warrington, Eng.)

This is heated by means of a Bunsen burner. It is connected up with an ordinary radiator, and is a very compact form of hot water heating, suitable for heating small houses, green-houses, etc.

The specimen shown is capable of heating 80 ft. of 2 in. pipe, the water inside being kept at a temperature of 50-55°F., according to the weather. A smaller boiler, one and two-thirds the size of this, is capable of heating 200 ft. of 2 in. pipe to the same temperature.

### 2.34 MODEL OF JOHNSON'S THERMO-REGULATOR.

This can be applied to hot water, or steam radiators, or to hot and cold air conditioning. It is an automatic apparatus, the automatic nature of the system being actuated by means of a thermostat, which is placed in the room of the apartment. The power is supplied by compressed air, which is conducted through pipes to the working valves attached to the heating apparatus of whatever kind. When the temperature reaches a given point a lever attached to the thermostat operates a small valve, and allows the compressed air to pass through the regulating valves, which it passes, and so cuts off the heat supply until the temperature in the room falls again, when the compressed air valve is

## WATER SYSTEM

of hot water  
and expansion  
tank, bath and

more closed and the hot water or steam is allowed to circulate. So the process goes on automatically.

## 2.5 General

### 2.51 GAS DISTRIBUTORS.

(Presented by Messrs. Fletcher Russell & Co., Warrington, England.)

Warrington, England)

### 2.52 SPECIMEN OF GAS COOKING OVEN.

(Presented by Messrs. Fletcher Russell & Co.)

burner. It  
adiator, and is  
ating. It is  
houses, etc.  
ing 80 ft. of  
at a temper-  
weather. A  
is, is capable  
ame temper-

This is a cheap and handy form of small oven, capable of cooking, and also for being used for boiling pans, etc. The feature about it is, that the products of combustion have very free exit, and so do not tend to contaminate the food in the interior of the oven.

### 2.53 SPECIMEN OF POLISHING IRON

(Presented by Messrs. Fletcher Russell & Co.)

R.  
m radiators,  
an automatic  
ng actuated  
l in the wall  
ed by com-  
pipes to the  
apparatus of  
re reaches a  
mostat opens  
air to reach  
d so cuts off  
n the room  
lve is once

The heat is supplied by a Bunsen flame in the interior of the iron.

### 2.54 SPECIMEN OF PRIMUS BRASING LAMP.

*LIGHTING.*

In this section are exhibited the various materials or agents, which have been used for giving light to dwellings, etc. They are given in the order in which they came into use, and are as follows:

Candles,  
Oil lamps,  
Gas,  
Electricity.

Our chief concern with these lighting agents is from a public health point of view—to ascertain how far they affect the atmosphere in rooms, and so to exert a direct action on the health of the individuals inhabiting them. This action on the atmosphere is always looked at from a two-fold point of view—first, as to how much oxygen each requires for combustion purposes, and, second, what products of combustion, deleterious or otherwise, are given off into the atmosphere.

In comparing the value from a hygienic point of view, it is, of course, always distinctly understood that we are employing lights of equal candle power. As a minor consideration, one may take note of the effects produced on the eyes by the different artificial lighting agents. This will be noticed in the various exhibits.

Thus far we have only dealt with artificial lighting. A word may be said about the apparatus used in the order to avail ourselves of the ordinary daylight. They may be dismissed briefly by saying that they consist chiefly of reflectors and refractors, which enable us to throw the daylight into long narrow beams where otherwise it would never be possible to

trate. As daylight, or sunlight, is very essential to the preservation of health, the reason for having apparatus to enable us to use it, in what may be termed inaccessible rooms, is obvious.

## 2.7 Reflectors and Refractors for Daylight.

### 2.71 SPECIMEN OF REFLECTOR.

placed outside an ordinary window at such an angle that the light rays, coming from above, are reflected horizontally into the room.

These are particularly useful in large buildings where the windows, lighting the lower rooms, look out on to a small alley-way between large buildings, and where it would be quite impossible for the direct rays of the sunlight ever to find their way into the room.

### 2.75 SPECIMENS OF PRISMS.

used for refracting vertical rays in a horizontal direction.

These are useful for illuminating cellars, and such like, where the source of light can only be obtained from the ground level, such ground surface being utilized at the same time for traffic purposes. These prisms of glass are very strong, and are capable of bearing large weights, so that considerable traffic might take place over them without causing material damage.

## 2.8 Artificial Agents.

### 2.81 CANDLES.

2.811 Sample of common tallow candle.

2.812 Paraffin wax candle.

2.813 Sperm candle.

It may be noted, under this heading of candles, that the term "Candle power" means the amount of light given out by one sperm candle, made in such a way that it will consume 120 grains of sperm per hour. This has been the standard for comparison of lights for quite a long time, but, more recently, a standard gas jet has been utilized, because a more accurate observation has shown that a gas jet can be constructed so as to give a far more constant light than the sperm candle.

## 2.82 LAMPS.

2.821 Specimen of common paraffin lamp.

2.822 Colza oil lamp.

2.823 Incandescent oil lamp.

The incandescence is caused by mixing the atomized oil with a large amount of air, which, on combustion, gives a non-luminous flame exactly like a Bunsen burner. This flame is intensely hot like the Bunsen flame, and is capable of producing incandescence in a silicate mantle.

---

Under the heading of oil lamps a reference is made as to the use of kerosene, or paraffin oil, in relation to explosions.

As is well known, when paraffin oil is heated to a certain point, it gives off a vapour, which, when mixed with air, is highly explosive, and so all paraffin oils, used for lighting purposes, have to be carefully supervised to ensure that the more volatile oils are excluded therefrom.

In the use of very cheap and common lamps the special danger consists in the oil receiv-

becoming overheated. In a good lamp this is more or less guarded against. It is for this reason that Colza oil is used, it being non-explosive.

### 2.83 GAS.

#### 2.831 SPECIMENS OF ORDINARY GAS JETS.

These are constructed so as to allow of a certain amount of gas being consumed per hour, and are sold under such standardization, a given amount of gas producing a certain intensity of light, and they are usually designated as 8, 10 or 16 candle power, and so on.

#### 2.832 SPECIMENS OF ARGAND BURNER.

It is claimed for this burner that, with an equal amount of gas consumed, a brighter light is produced than by the use of an ordinary burner.

#### 2.833 SPECIMEN OF INCANDESCENT LIGHT.

This is produced by the action of the Bunsen flame on an incandescent mantle.

It has been asserted that incandescent lights are harmful to the eyes on account of their intensity and whiteness of light. This is noticed more by those who have to work long hours under such a light, and the fact is more or less true that clerks, and others, do suffer from the glare produced. It is a matter of common experience that a soft yellow light, such as a lamp light, is much more comfortable to read by, for a long period, than a white glaring light.

## 2.837 SPECIMEN OF ACETYLENE GAS LAMP.

The flame produced by the use of this is very intense and white, though much smaller in size than the ordinary gas jet. The remarks, about its effect upon the eye, apply to this specimen of lighting with more force than to the ordinary incandescent gas light.

## 2.84 ELECTRIC LIGHTING.

## 2.841 SPECIMENS OF INCANDESCENT LAMPS.

These are of varying candle power, the common ones being 8, 10, 16 and 32. They give a very agreeable light, though, for reading purposes and such like, they are not so comfortable to the eyes as an ordinary lamp.

## 2.846 SAMPLE OF ARC LAMP.

The arc lamp, which gives a tremendous powerful light, is used practically only where large areas have to be lit up, such as streets, very large working establishments, and the like. The effect produced by arc lamps is much the same as that of ordinary sunlight.

2.85 Table showing amount of carbon dioxide given off by each type of artificial lighting. Of course it is understood that equal lights are compared, inasmuch as their intensity is concerned, and the usual standard is taken as being an eight candle power light, *e.g.*, a gas lamp of eight candle power would be compared with a lamp producing the same amount of light as produced from eight standard sperm candles. *e*

By a study of this table it will be seen that the order in which these various types vitiate the atmosphere, is the same in which they were invented, namely, candles, lamps, gas and electricity.

From the table the fact is very evident that electricity, considered from this point of view, is by far the best lighting agent, seeing that it consumes none of the oxygen of the air, neither does it give off any deleterious constituents, such as carbon dioxide, to it. This latter remark, of course, applies to the incandescent electric lights and not to the arc lights.

It may be noted also, in speaking of the deleterious products of combustion of these various materials, that, in the case of coal gas, there are other products, equally undesirable besides  $\text{CO}_2$ , *e.g.*, sulphur dioxide, which quickly becomes converted into sulphuric acid. This, besides being an irritant to the respiratory mucous membranes, exerts a decided corrosive action on all exposed metal work about an ordinary dwelling.



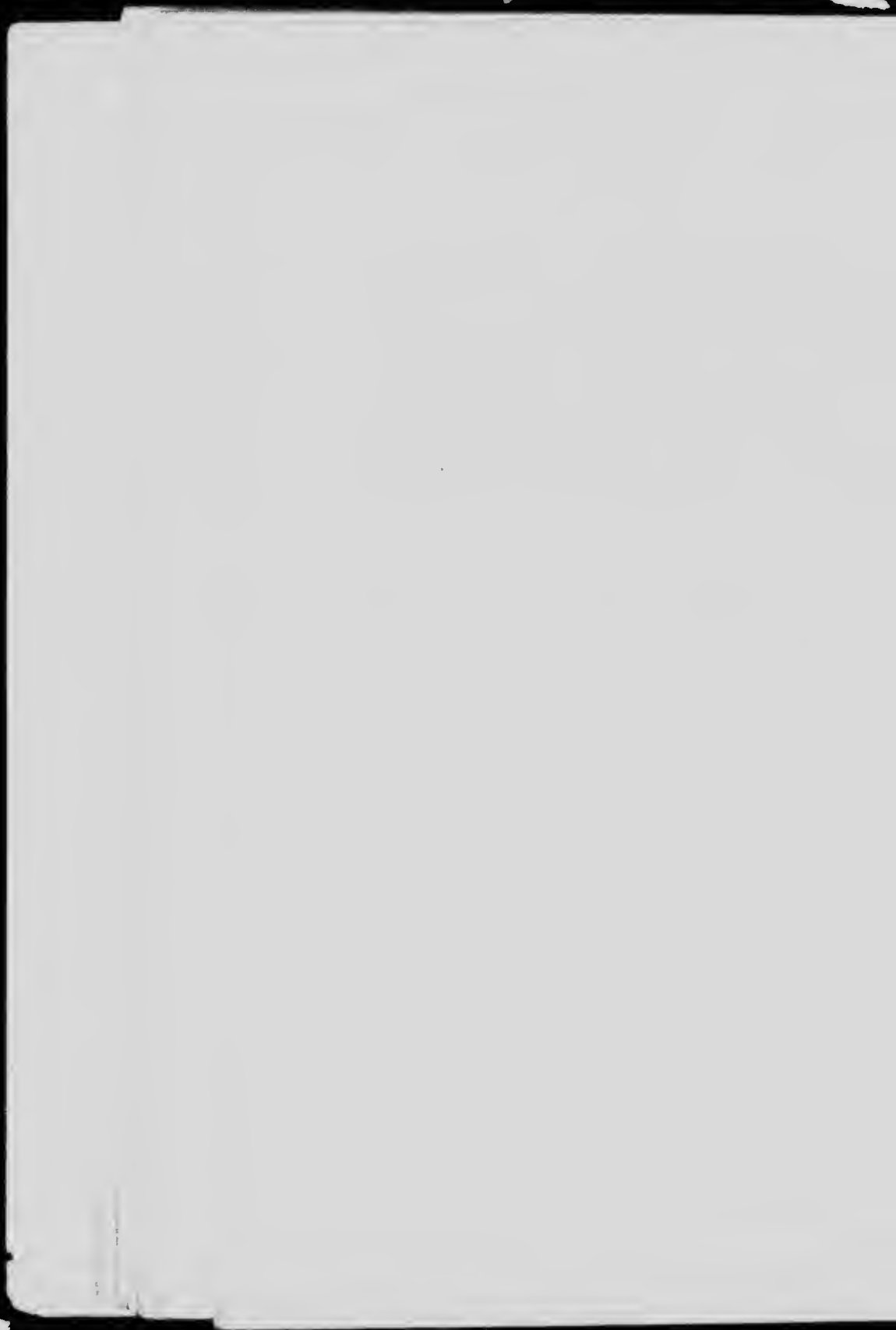

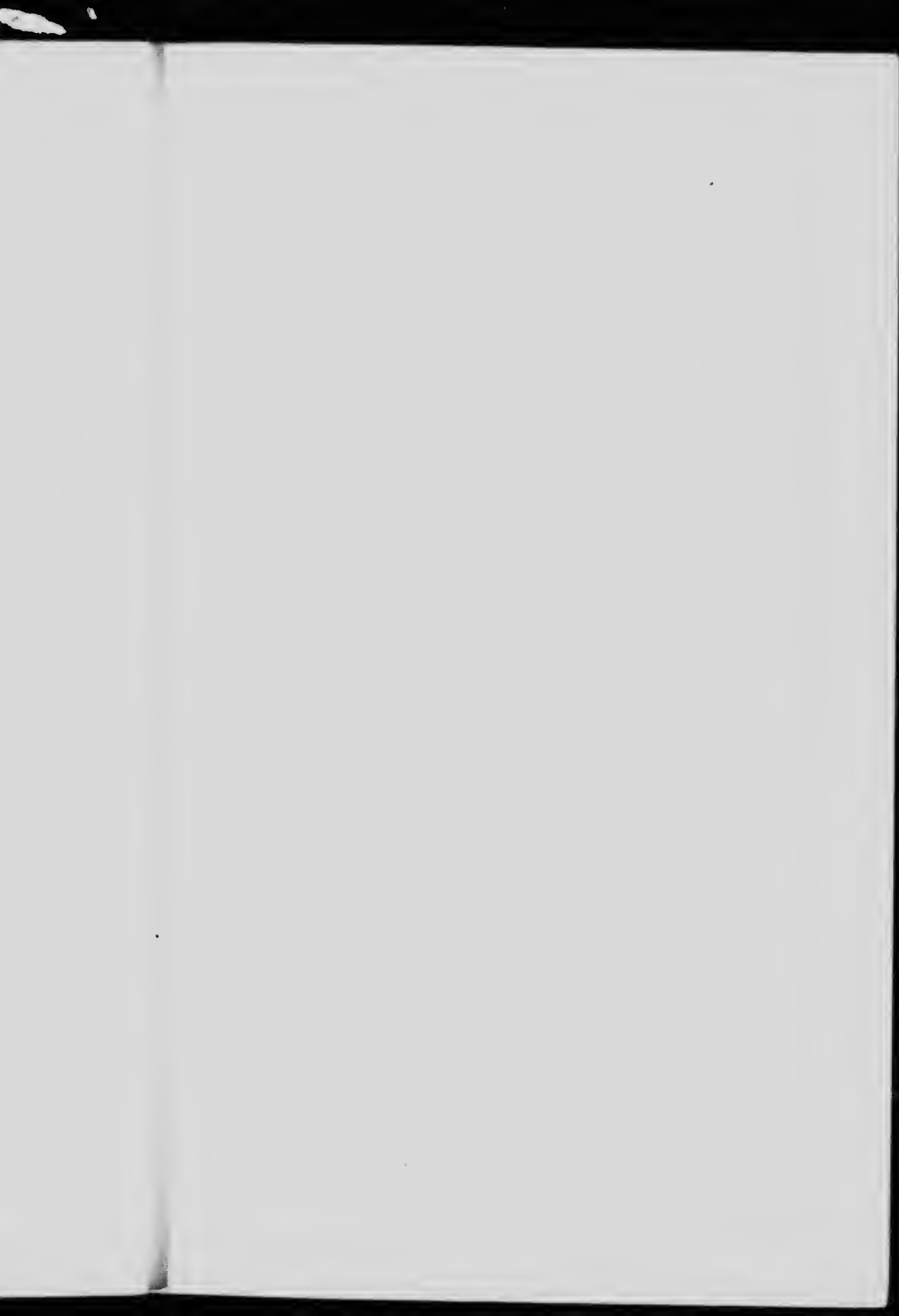



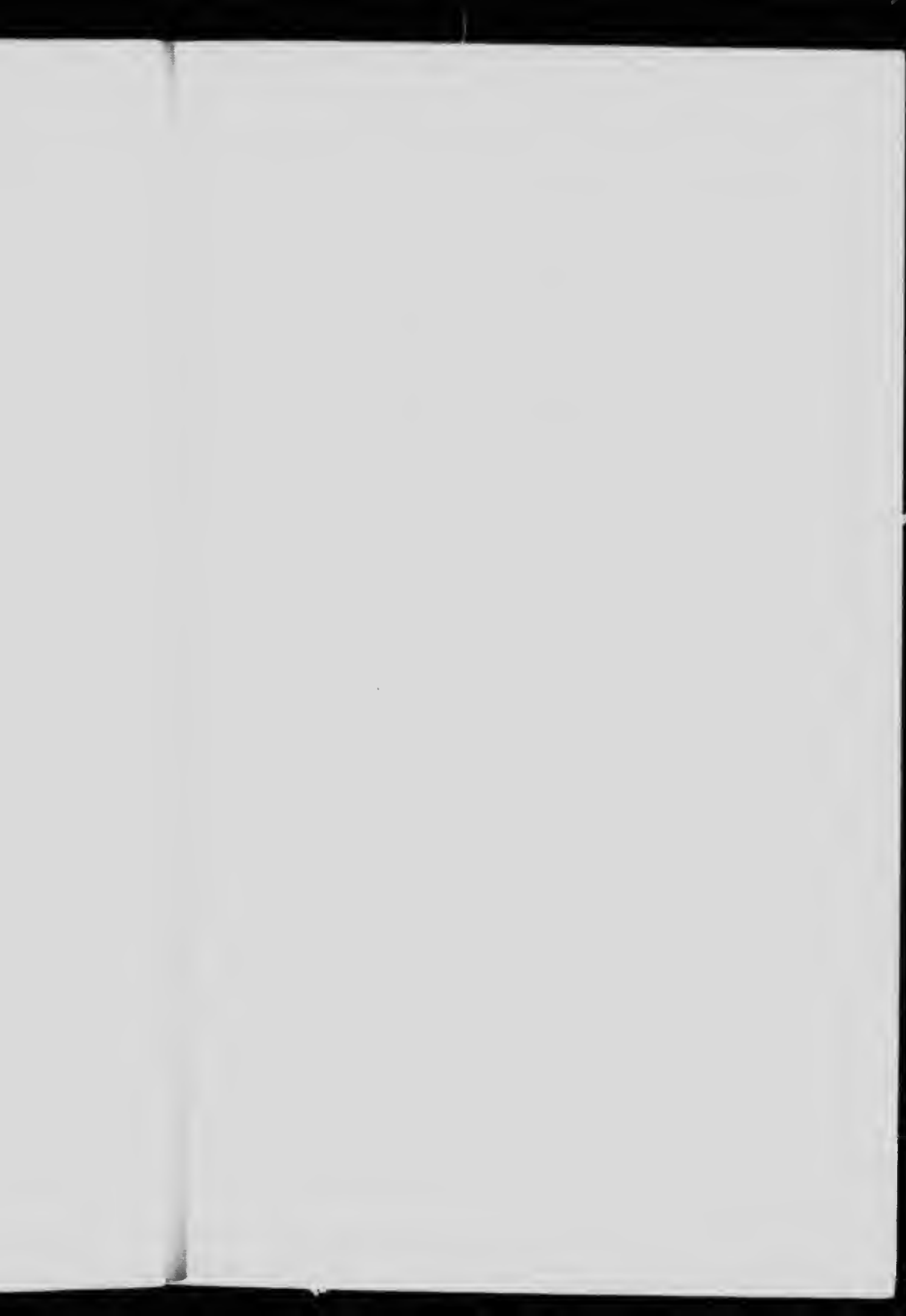



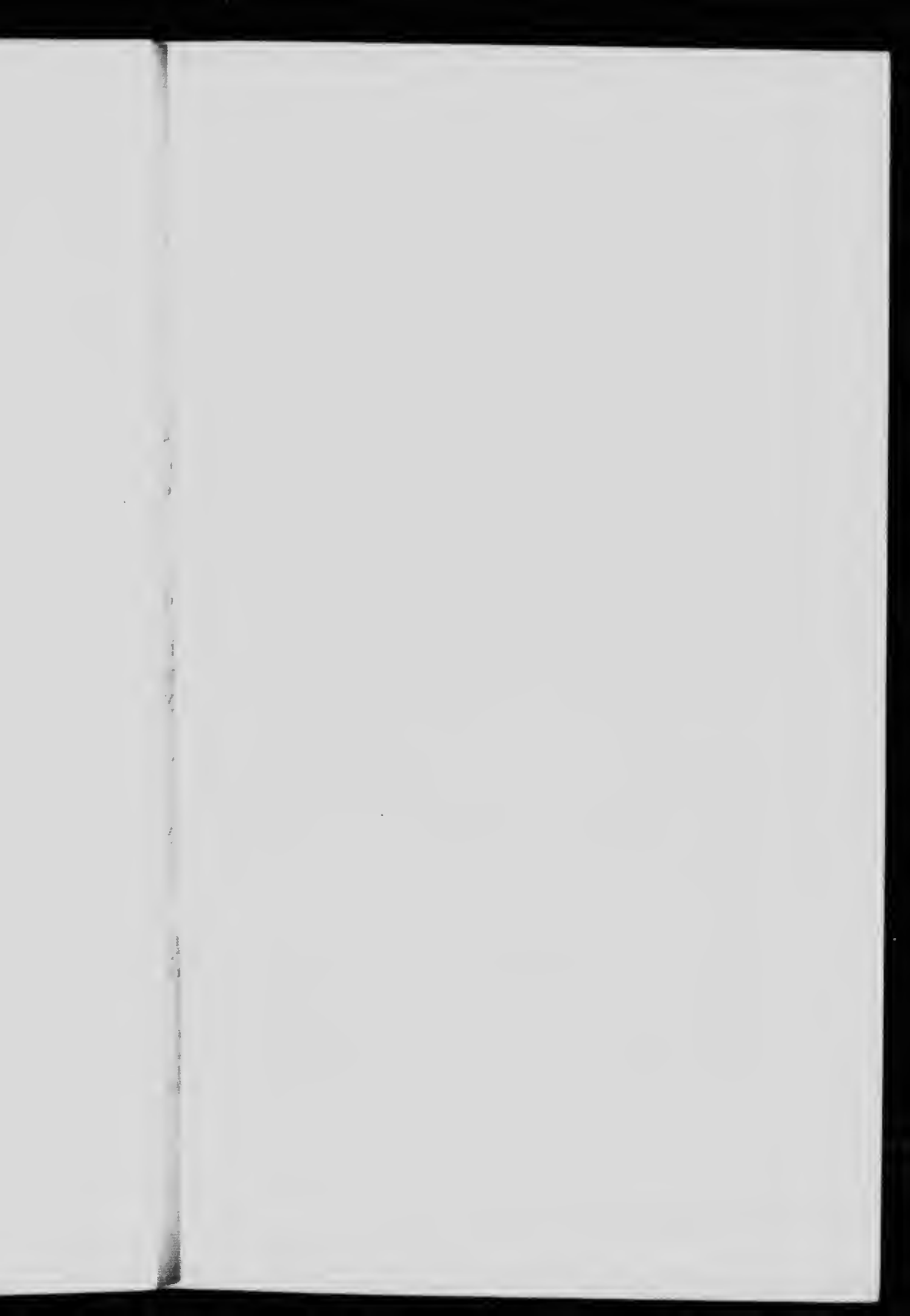

## SECTION III.—WATER.

### 3.1 Water Pipes, etc.

#### 3.11 SPECIMEN OF ORDINARY HEAVY LEAD PIPE.

This pipe is used for ordinary water connections for high pressure. With an intermittent water supply of low pressure, a lighter variety of lead is used.

#### 3.12 SPECIMEN OF LEAD PIPE LINED WITH TIN.

This is for water, mineral water, beer, etc., designed to prevent lead poisoning.

A drawback to this kind of pipe is the fact that when the tin coating is broken, a galvanic action is set up between the tin and the lead, causing an appreciable solution of lead.

#### 3.13 SPECIMEN OF IRON PIPE COATED WITH ANGLUS SMITH'S PREPARATION.

This coating is a kind of coal tar varnish, is very durable, and can be used for large and small pipes.

#### 3.14 SPECIMEN OF IRON PIPE, TIN LINED.

This is used under the same conditions as 3.12, the drawback being that the iron pipe can be bent in the same fashion as lead.

#### 3.15 SPECIMEN OF IRON PIPE, GLASS LINED.

This was invented with a view to the prevention of the absorption of metal.

PIPE.

connections  
at water sup-  
of lead pipe

N.

etc., designed

the fact that.  
ic action sets  
using a very

NGES SMITH'S

nish, is very  
small pipes.

tions mostly  
a pipe cannot

prevention of

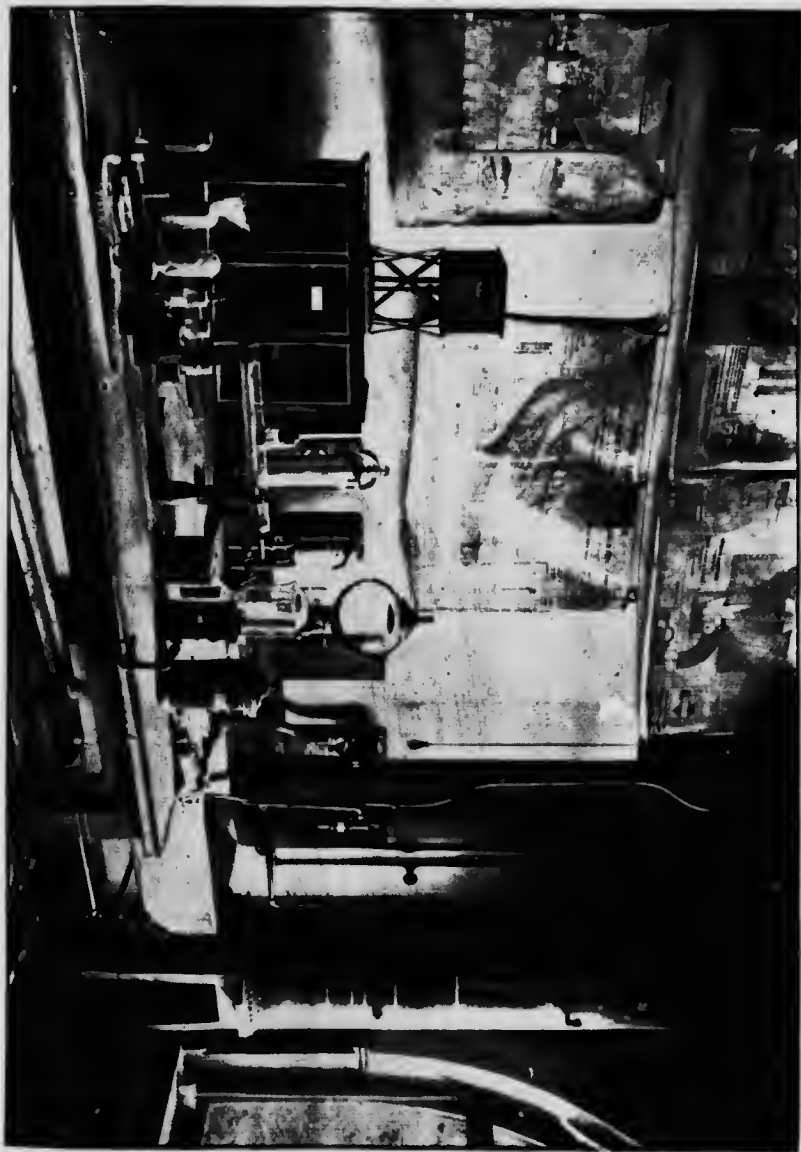



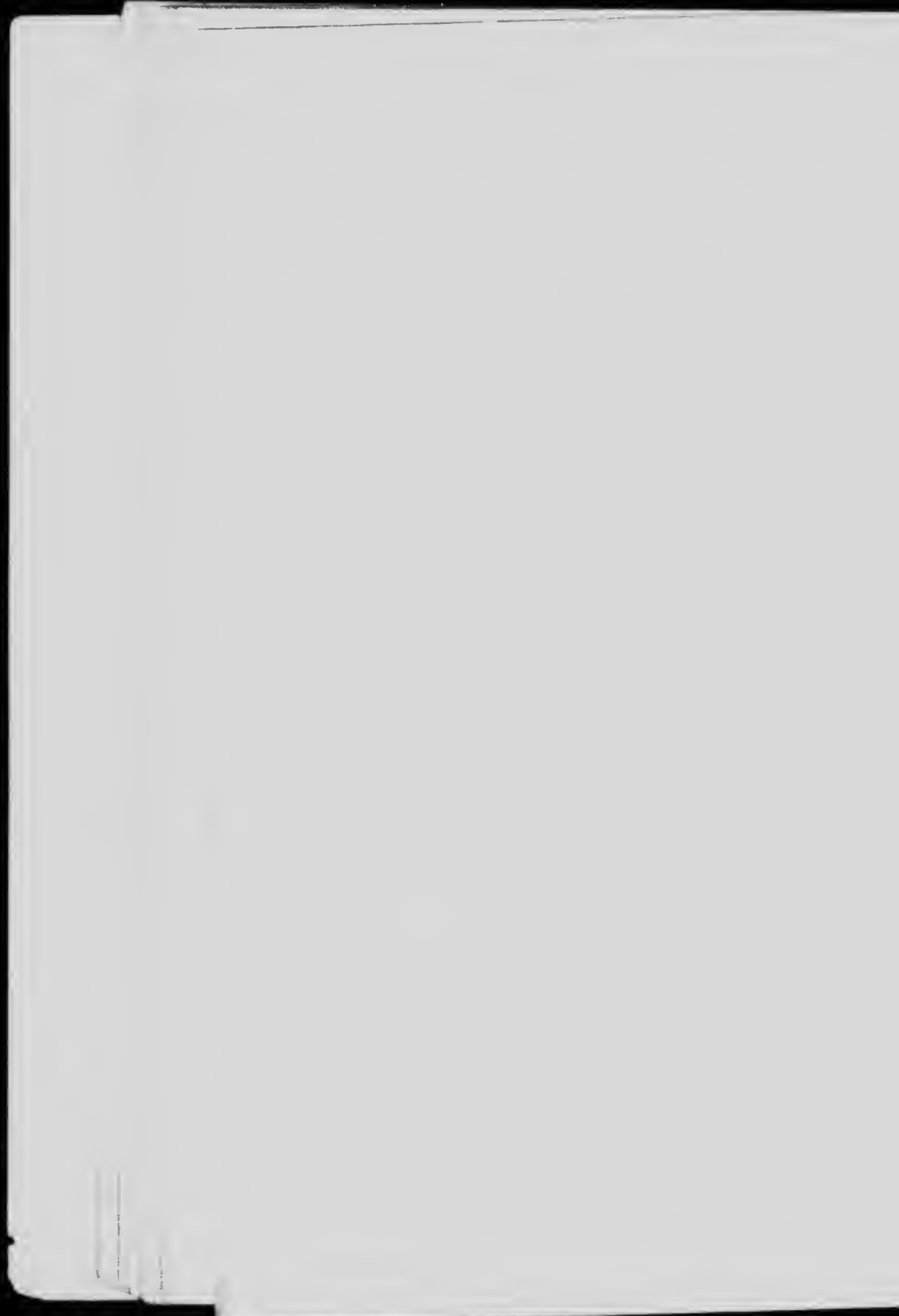

The great disadvantage to this pipe is that the glass lining is broken whenever the iron pipe is bent.

### 3.16 SPECIMEN OF GALVANIZED IRON PIPE.

The durability of this is not very great, the zinc coating wearing off and corroding.

### 3.17 SPECIMEN OF 5/8TH GALVANIZED IRON PIPE.

This shows the lumen almost occluded by the defective coating.

### 3.18 SPECIMEN OF OLD WOODEN CONDUIT.

This was used in ancient times for the distribution of water supply. The specimen was excavated in Montreal, somewhere in the region of Craig Street. Date uncertain.

### 3.19 MODEL ILLUSTRATING THE SUCTION ACTION EXERTED BY LEAKY WATER PIPES.

This consists of an ordinary piece of lead pipe, as used in water connections, placed inside a glass cylinder; connected with the interior of the glass cylinder is a manometer, to indicate any difference of pressure. The lead pipe is punctured with a small hole, such as is usually made by an ordinary wire nail.

If water be allowed to run through the lead pipe, (the bigger the pressure the better), it will be found that air is sucked in through the small hole, the lessened pressure inside the glass cylinder is indicated by the manometer. If the manometer is taken out and the cylinder filled with coloured water, it will be noticed that this water is sucked through the small hole in the same way as the air in the first experiment.

Thus contamination by ground air and ground water can be demonstrated.

3.19a SPECIMEN OF ORDINARY LEAD WATER PLUMBING  
in which a hole has been gnawed by rats.

*FILTRATION.*

**3.2 Municipal Filtration Systems.**

**3.21 MODEL OF FISCHER'S SYSTEM OF WATER FILTRATION.**

This consists of a series of hollow blocks made of artificial stone. The water, under its own pressure, is allowed to flow into the interior of these stone blocks, and it then percolates through the stone during which process it is subjected to filtration.

This filter is not a germ-free filter, and the system has not met with any great amount of success.

**3.22 WORKING SECTIONAL MODEL OF ORDINARY SAND-FILTER FILTRATION.**

This, as used for municipal purposes, is a sand-filter constructed, from above downwards, of the following materials:—First; fine sand 18 in., coarse sand 3 in., fine gravel 3 in., coarse gravel 5 in., and broken brick 10 inches.

The essential part of this sand filter is a gelatinous layer formed on the surface of the fine sand. This layer is capable of straining off practically all organisms and of retaining any matter in suspension. The process is one of purely mechanical filtration. As the gelatinous layer increases in thickness, and finally reaches a point

where the water is no longer able to percolate, it is then time for the filter to be cleaned. This is done by scraping off the upper inch of fine sand along with the gelatinous layer. The filter is not in working order again until a new gelatinous coating has formed. This takes about three days.

### 33 Domestic Filters.

#### 3.31 MODEL OF ORDINARY DOMESTIC FILTER.

This will illustrate all the ordinary varieties of domestic filters, and consists of an upper and lower chamber, separated by a filtering medium, the lower the receptacle for the filtered water.

Many substances are used to effect this filtration, the following being a list :-- Sponge, flannel, charcoal, sand, asbestos, unglazed fireclay, oxide of manganese, iron oxide, pieces of iron, powdered charcoal and lime mixed.

In all of these the filtration is but crude : they are capable of straining off only large particles, and are in no sense germ free, in fact many of them form a growing medium for organisms, which may be caught upon them, and so, after a time, the water that comes through may actually contain more organisms than the original unfiltered water.

Charcoal has the property of decolorizing waters tinted with vegetable matter.

#### 3.32 SPECIMEN OF MAIGNEN'S TABLE FILTER.

The filtering medium is Maignen's Carbo-calcis. The remarks made under 3.31 are applicable to this.

**3.33 FIVE SAMPLES OF MAIGNEN'S PORTABLE FILTERS.**

These vary in size from a little pocket filter up to a large camp filter. The principle involved is precisely the same as in 3.31.

**3.34 SPECIMEN OF MAIGNEN'S IRON CYLINDER FILTER.**

This is for permanent attachment to a water pipe and is on the same principle as stated above.

**3.35 SPECIMEN OF CARBO-CALCIS.**

This is used in Maignen's filters.

**3.36 SPECIMEN OF DAVIS'S FILTER.**

This is for permanent attachment to a water pipe and the process of filtration here is through fine charcoal, and a mixture of lime and charcoal.

The results of filtration are the same as in an ordinary domestic filter.

**3.37 SPECIMENS OF MATERIAL USED IN DAVIS'S FILTERS.****3.4 Biological Filters.**

The principle of the biological, or germ-free filter is that water is made to pass through some very fine porous material capable of straining off all suspended matter, including micro-organisms. The material usually employed consists of some preparation such as unglazed porcelain, kieselguhr (powdered diatom shells), or very fine artificial stoneware. The water may be forced through by pressure, or drawn through by vacuum.

In all varieties of this filter, it is found that a slimy layer collects on the outside of the filter.

medium, and, after a time becomes so thick as to prevent any water passing through at all. The filtering block has then to be cleaned, which is done by scraping the slimy layer off, and sterilizing the cylinder, either by boiling, or by steam in the autoclave.

It is to be noted that in all these filters the filtrate is not permanently sterile. This depends upon the fact that the organisms in a few days grow through the interstices of the filtering medium. It is an actual process of "growing through," for no amount of pressure can force organisms through, and this being the case, the period when the filter "gives out" varies with different materials according to the size of the interstices, *e.g.*, unglazed porcelain generally lasts about five or six days, giving sterile filtrate with continuous filtration; kisselguhr four to five days; fine unglazed stoneware from one to three days.

#### 3.41 LARGE SIZED "ECLIPSE" FILTER.

(Presented by Messrs. Morgan & Son, Montreal.)

This is for permanent attachment; the medium is unglazed artificial stoneware.

This filter is capable of giving a large quantity of filtered water, but the filtrate only remains sterile for about one day.

#### 3.42 PASTEUR FILTER.

Permanent attachment. Filter medium, fine unglazed porcelain.

The rate of filtration is slow as compared with the others, but this filter remains sterile longer than any other, namely, five to six days.

**3.43 BERKEFELD FILTER.**

(Presented by The Berkefeld Filter Co., Oxford St.,  
London, England.)

Detachable union; filter medium, finely powdered diatom shells (Kieselguhr).

The rate of filtration in this is fairly rapid, and remains sterile for four to five days.

The feature about this filter is its detachable union for it can be fixed on to any ordinary sized tap with great ease.

**3 44 THE PASTEURIZING FILTER.**

(Presented by The Pasteurizing Filter Co., 71A St. James St.  
Montreal.)

The filtering medium consists of a plate or disc of patent composition, held firmly between two iron slabs. The water is forced through the filter plate by the usual main pressure, and is sterilized on its passage through.

The recommendation for this filter lies in its extreme simplicity and especially in the ease of changing the plates.

No sterilizing and cleaning of the old plate is required, a new plate being used each time and the old one discarded. The disc needs to be changed every four days.

**3.9 General.****3.91 LARGE WORKING MODEL ILLUSTRATING MOVEMENT OF UNDERGROUND WATER.**

This consists of a mass of sand about 18 inches deep, 18 inches wide, and six feet long, representing the superficial permeable layer. The floor of the tank in which this sand is contained, represents the first impermeable stratum. The interstices of

lower part of the sand are filled with water, representing "ground water"; in the centre is a hole, representing the ordinary superficial well, and, extending in a straight line on each side of this well, is a series of observation tubes. The well and tubes are connected to gauges on the front of the box, so that the level of the underground water in any of these borings can be seen at a glance.

When water is pumped out of the well, the level of the underground water is indicated on the manometers, and takes the form of a curve, which is very steep near to the well, running away into the ordinary level of the ground water at a very short distance from the well.

This is instructive, showing how the level of the underground water is depressed in the vicinity of the well which is being used; and so it follows, that any contaminating material, situated in the vicinity of the well, can be, so to speak, drawn into it. In cases where the well is not used, the contaminating material would be carried away in the direction of the side flow of the underground water.

The side movement of the ground water can be illustrated, and its bearing to public health, by pumping the water out of one end of the box. In this way the whole of the underground water takes on a side movement towards the end from which the pumping takes place. It can be shown that any point of pollution on the far side of the well from the seat of pumping, will actually contaminate the underground water which flows from the pollution point, past the well, to the place where the water is being pumped out. This can be beautifully illustrated by introducing some chemical, which can be easily detected, at the point where pollution is supposed to take place.















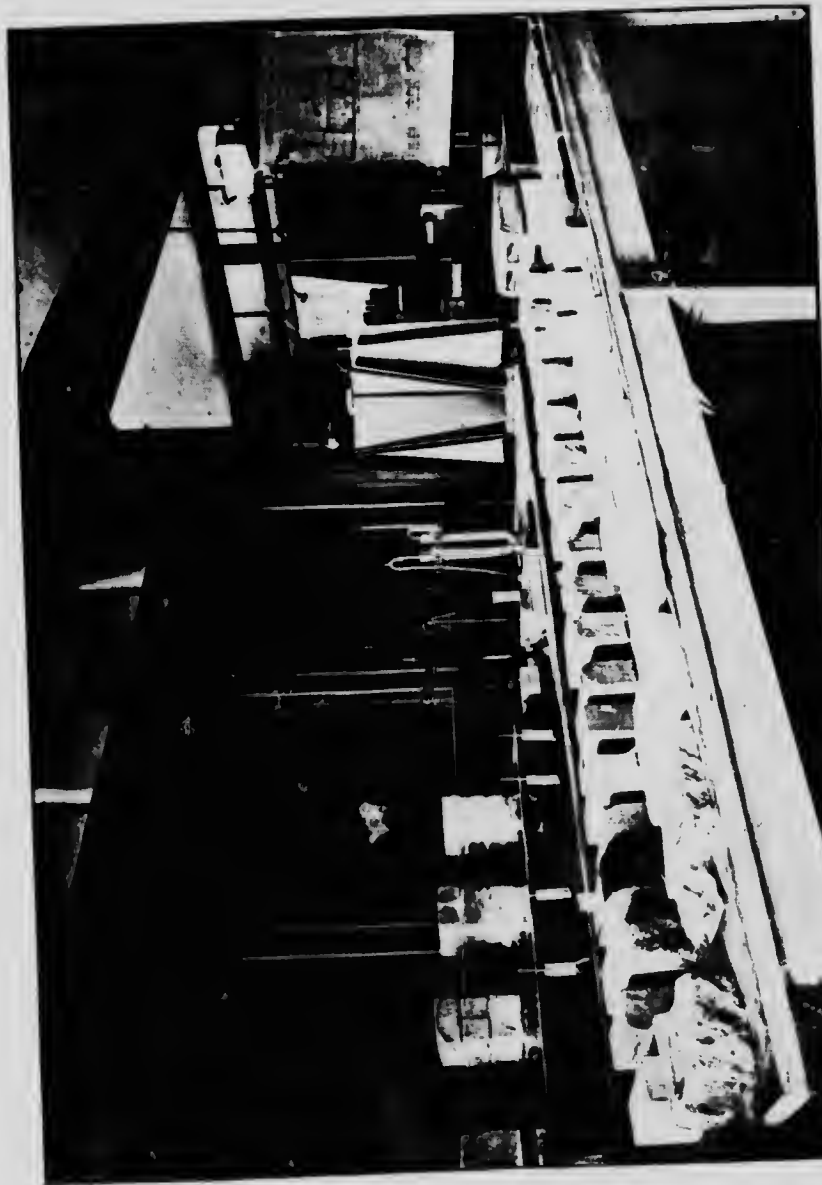

## SECTION IV. BUILDING.

In comparing brick work and stone work, from a hygienic point of view, there is very little to be said ; it is generally held that stone work is colder, and more liable to dampness, than brick work ; there is a substratum of truth in this. Stone work is thicker than brick work ; stone, when wet, is very difficult to dry thoroughly, hence, the reason is clear why it is that the stone is generally cold and damp. As regards the durability of stone over brick, this probably has been exaggerated, for in the light of modern experience, well pressed brick lasts almost as long as stone, that is, from the point of view of the wear and tear of the elements.

Another point to be noted in this connection is the fact that, in ordinary practice, they do not lay damp proof courses in stone work, hence, another factor aiding dampness rising up from the foundations.

### 4.1 Stone.

#### 4.11 SANDSTONE.

(Presented by Messrs. Gray & Wighton, Montreal.)

- 4.111 Buff sandstone, Cleveland, Ohio.
- 4.112 Ohio sandstone.
- 4.113 Sandstone, New Brunswick
- 4.114 Sandstone, Scotland.
- 4.115 Sandstone, Scotland.



**4.12 LIMESTONE.**

(Presented by Messrs. Gray & Wighton.)

- 4.121 Limestone, Montreal.
- 4.122 Limestone, Quebec.

**4.13 GRANITE.**

(Presented by Messrs. Gray & Wighton.)

- 4.131 Granite, Stanstead, Quebec.
- 4.132 Granite, Nova Scotia.
- 4.133 Gregoire granite, Quebec.
- 4.134 Granite, Barre, Vermont.
- 4.135 Quiney granite, Massachusetts.
- 4.136 Scotch granite.

**4.2 Brick.****4.21 PRESSED BRICK.**

(Presented by Messrs. Gray & Wighton, Montreal.)

- 4.211 Pressed Brick, Ormstown, Quebec.
- 4.212 Pressed Brick, Milton, Ontario.
- 4.213 Pressed Brick, Laprairie, Quebec.

**4.22 PLASTIC BRICK.**

(Presented by Messrs. Gray & Wighton, Montreal.)

- 4.221 Plastic Brick, Laprairie, Quebec.

**4.23 COMMON BUILDING BRICK.**

(Presented by Messrs. Gray & Wighton.)

- 4.231 Common Brick.
- 4.232 River Brick.

**4.21 FIRE BRICK.**

(Presented by Messrs. Gray & Wighton.)

- 4.241 Fire Brick, plain, Glasgow.
- 4.242 Fire Brick, enamelled, Kilmarnock, Scotland.
- 4.243 Fire Brick, enamelled, American.
- 4.244 Silicate Brick.

**4.3 Wood, used in construction.**

- 4.31 Ash.
- 4.32 Oak.
- 4.33 Maple.
- 4.34 Cotton Wood or Whitewood.
- 4.35 Pine.
- 4.36 Black Walnut.
- 4.37 Mahogany.

**4.4 Roofing.**

A word may be said about these materials :

Corrugated Iron is a cheap roofing and much utilised. It is very durable. The disadvantage in its use lies in the great power it possesses of Radiation. In summer it makes the room very hot, and, conversely in winter, very cold.

A bad form of Roofing is one which will hold, or retain, a large amount of moisture, and also afford facilities for harbouring vermin—the best illustration of this is Thatched Roofing.

- 4.41 Specimens of Slate.
- 4.42 Specimens of Roof Tile.
- 4.43 Specimens of Corrugated Iron.
- 4.44 Specimens of Wood Shingle.

## 4.5 Flooring.

### 4.51 MARBLE.

(Presented by Messrs. Gray & Wighton, Montreal.)

4.511 American Marble, Tennessee.

4.512 American Marble.

4.513 Italian Marble, Carrara.

### 4.52 TILE.

4.521 English Floor Tile.

### 4.53 LINOLITH.

(Presented by the Linolith Co.)

This material is fire-proof and almost "sound proof."  
When the glaze wears off, it is somewhat absorbent.

4.531 Glazed.

4.532 Unglazed.

4.533 Tinted.

4.534 Mouldings, for rounding off the same.

## 4.6 Damp-Proof Courses.

4.61 Glazed Tile, perforated.

4.62 Asphalt.

4.63 Slate and Cement.

4.64 Cement.

4.65 Plain Mortar.

The object of the damp-proof course is to prevent the water soaking up from the ground around the foundations, into the walls of the building, and the materials used, are given in the order of their efficiency. Glazed tile and asphalt stand in a class by

themselves, being infinitely superior to any of the others; of these two, glazed tiles are more preferable, but more expensive, than asphalt.

#### 4.7 General.

- 4.71 Specimens of composition of Mortar, and Concrete, showing proportions of ingredients.
- 4.72 Specimen of Tile Lining for smoke flues.
- 4.73 Specimen of Terra Cotta Lining for walls.
- 4.74 Cardboard Model of Building Angle.

The angle is one of 63.5 and its use is to prevent houses being built too close to one another, and too high, so that efficient ventilation, and access of sunlight are both prevented.

The principle is brought into practice where new buildings are being erected near older ones, and the method of working is as follows: An imaginary horizontal line is drawn through the older house from front to back at right angles and on a level with the ground. From a point on this line where the outer wall reaches the ground, a line is drawn at an angle of 63.5' and no portion of the building, about to be erected, ought to intercept that imaginary line, chimneys and ornaments not being taken into consideration.

The working principle of this building model has, in some places, been put into practice, with reference to new buildings, on new sites. The breadth of the lot, from front to back, has been taken as a basis for calculation. An imaginary line is drawn horizontally at ground level from front to back of the lot, and at a point where

it reaches the back fence, an imaginary line drawn on an angle of  $63.5^\circ$ . No portion of building, about to be erected, with the exception of chimneys, and roof ornaments, being allowed to intercept that line.

These principles cannot be put into practice in very large towns, with reference to building of offices, and warehouses, and such like for obvious reasons; but great benefit resulted by applying these principles to building of houses, especially those in which poor classes live.

4.75 Specimens of Expanded Metal used in pla  
ceilings and walls.

#### 4.8 Wall Coverings.

4.81 Model showing types of various materials  
for wall coverings, some good, some bad

This model contains types of specimens, viz

White Wash

Distemper or Calceining

Paint

Common Wall Paper

Good Wall Paper

Plain Glazed Wall Paper for white

Plain Wall Tile

Decorated Glazed Wall Paper

Thick Corrugated Surface Paper

Velvet Cloth

Japanese Rough Surface Cloths

The ideal hygienic wall covering is one th  
durable, washable, possessing smooth surface so

no dust or dirt can collect thereon. Patterns of the paper can be ignored, seeing that this can be obtained to suit any taste. From the specimens exhibited, one can readily pick out the types that would fulfil these requirements. Undoubtedly, it is very difficult to relinquish the beautiful cloth coverings for walls, in favor of plain glazed papers, but there is no doubt, that such cloths do harbour dust, and from a public health point of view, one aims at getting rid of this disadvantage, seeing that the dust may contain infectious matter.

ary line is  
tion of the  
exception  
ng allowed

to practice  
ce to the  
l such like,  
enefit has  
les to the  
which the

in plaster

aterials used  
me bad.

ens, viz. :

r whitening

r  
per

ths

one that is  
face so that



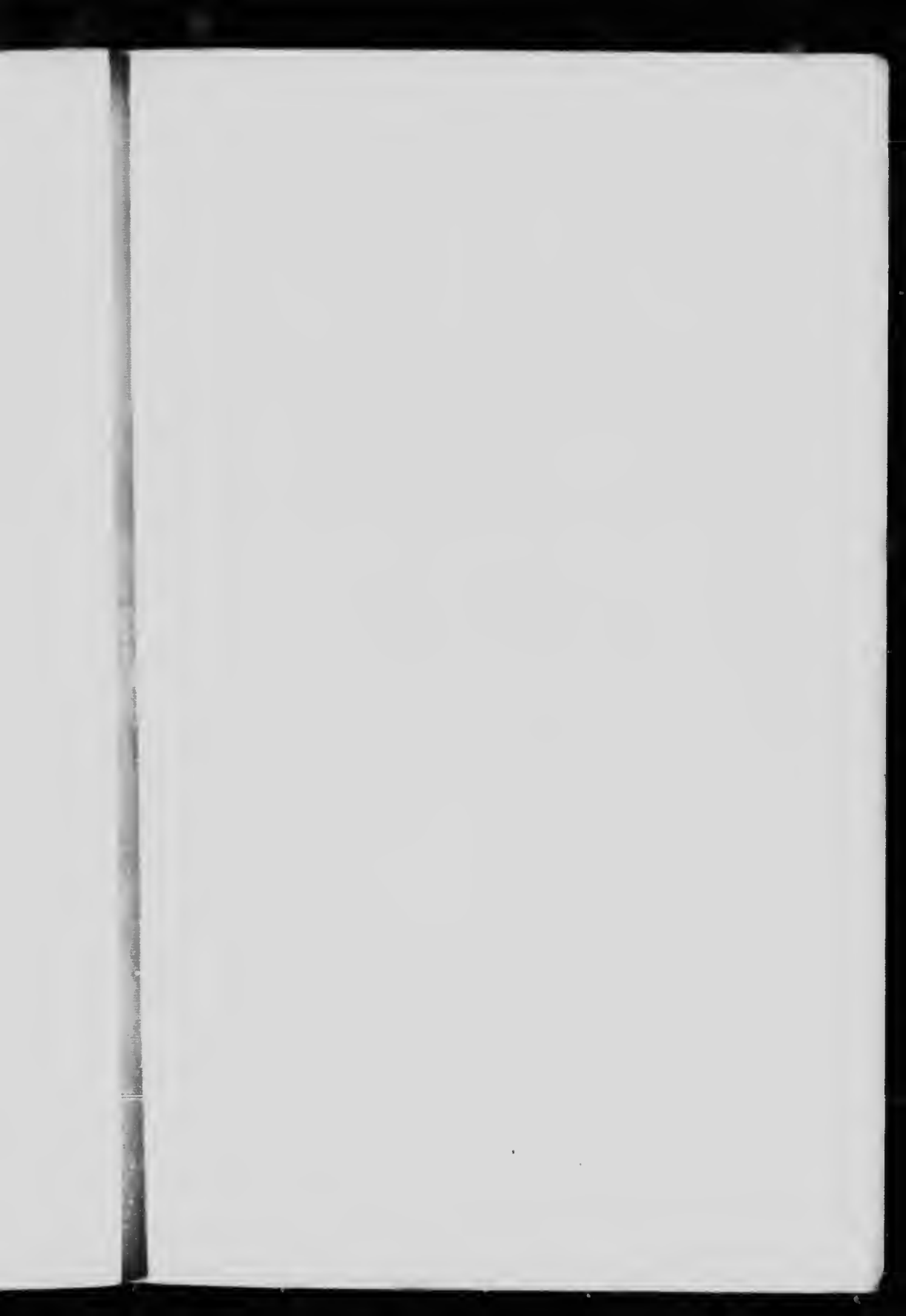







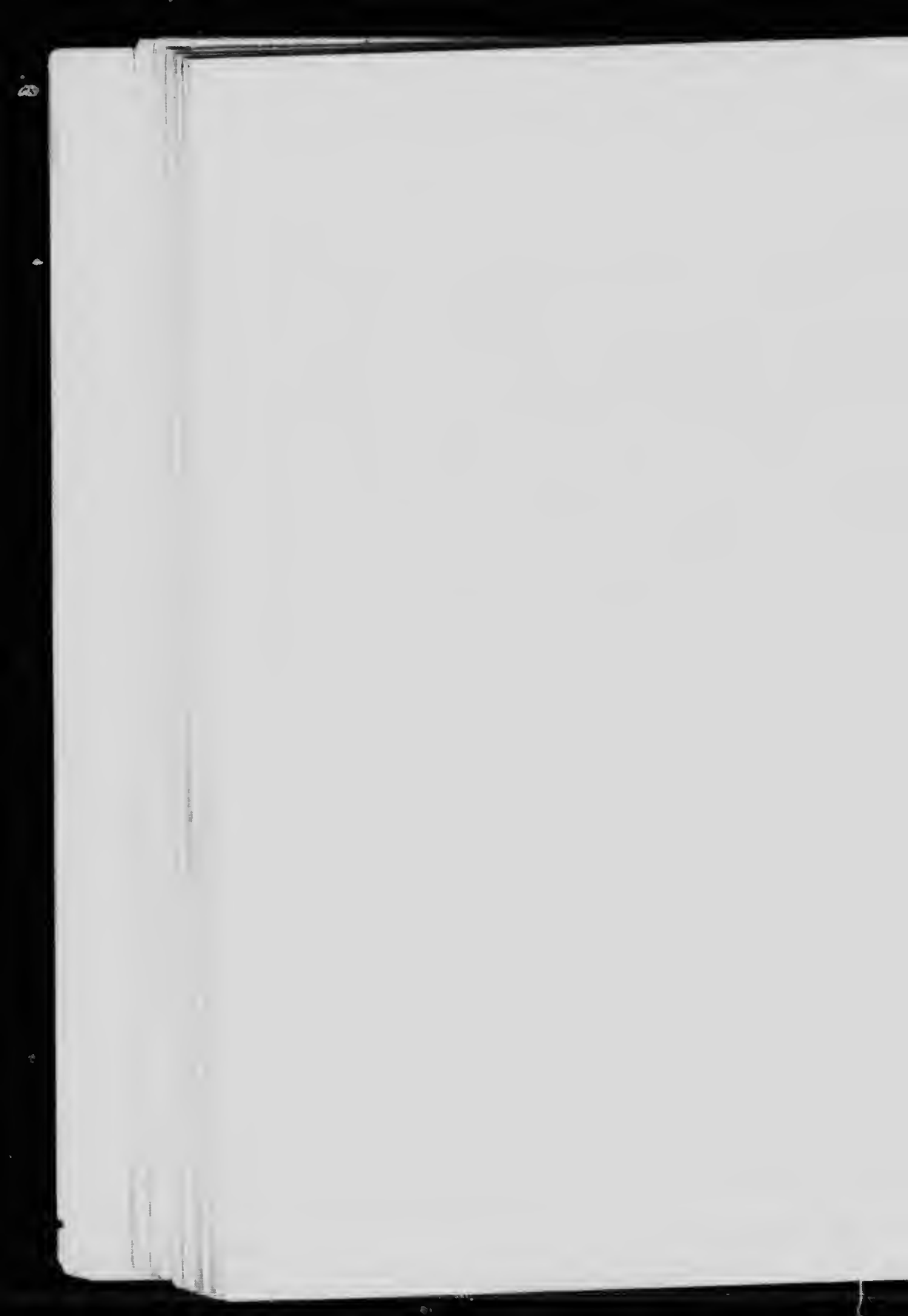



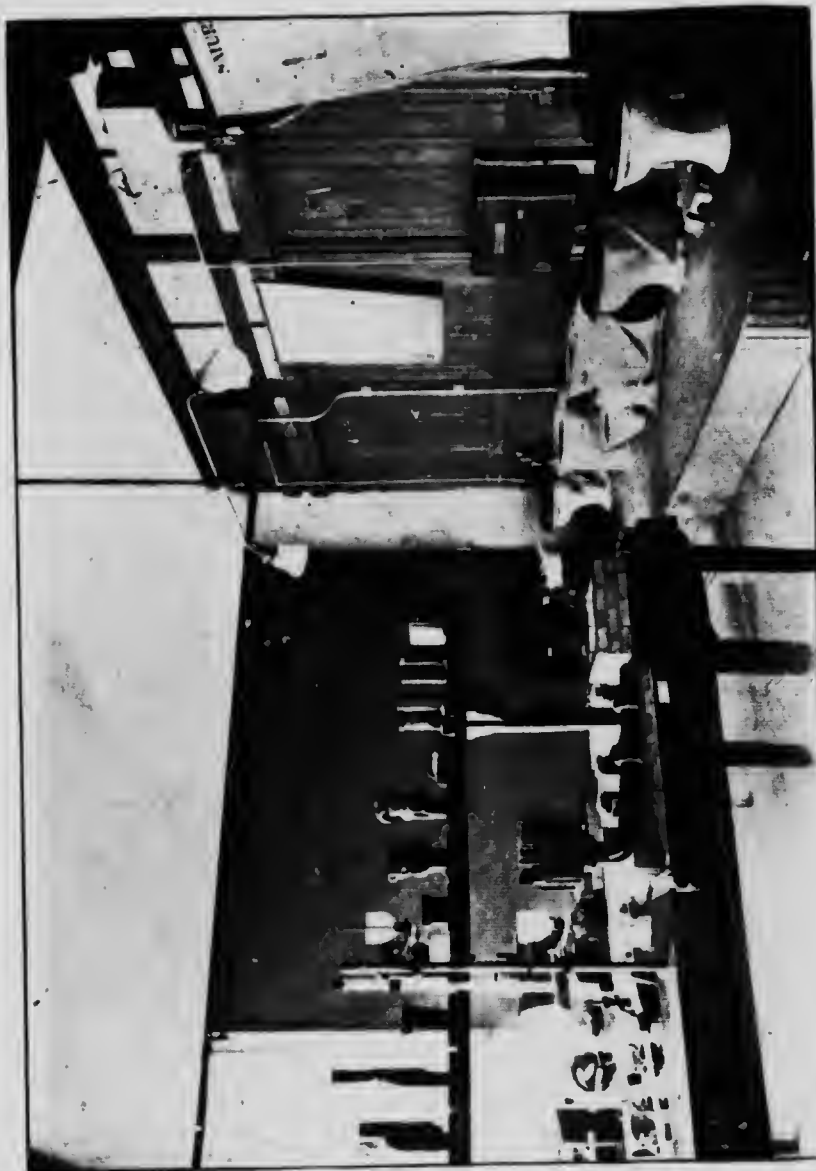

## SECTION V.—SOILS.

In this Section will be considered the various kinds of soil, chiefly from the point of view in its relation to health. The actual chemical composition of the different soils is of minor importance. The principal points to which attention will be paid are :

1. The permeability of the soils to water.
2. The permeability to air and gases.
3. The water holding capacity of different soils.

1. As regards the permeability of soil to water, this is of importance in relation to drainage, sub-soil water, and water supplies derived from the latter. In examining water supplies derived from the soil, of course it is of great import to have an idea of the permeability of the soil to water, with a view to the possibility of contamination by drainage, which may be in the soil. The greater the permeability, the greater the risk of pollution, in the sense that in a very permeable soil, the drainage can travel with greater ease, and, finally, in those cases, where the soil forms an impermeable layer, the water beneath that layer, for instance, would be protected, in a large measure, from pollution in the layers above.

2. The permeability of soil to gases is also of great interest, seeing that this bears specially upon the question of ground air, and the admission of that

ground air to dwelling houses. The more permeable the soil to gases, the greater will be the amount of ground air drawn into the house, under ordinary circumstances. In view of the composition of ground air, and the desirability of excluding such from dwellings, this question of permeability is of importance.

Intimately associated with this permeability is the question of composition of the soils, in so far as concerns the gases in the soil, *e.g.*, decaying vegetable matter, and such like, affecting the ground air in its own peculiar fashion.

3. The water holding capacity of soils. From a health point of view, this can be put in plain language, namely, is the soil damp or not? That is, is it capable of holding water in its interstices? As will be seen from the apparatus and tables, the soils are arranged in the order of their water holding capacity.

It may be briefly noted that all these three points—the permeability of soil to water and gas, and also its water holding capacity, depend entirely upon the size of the grains, and also the interstices. It is obvious that the more open the soil is, the more permeable will it be to both water and gas. As regards the water holding capacity, this, too, depends upon the size of the grains, and as it depends entirely upon the question of capillarity, the smaller the grains, the greater the capillarity. This water holding capacity is not to be confounded with that of the quantity of water that one is able to pack in the interstices of a soil, it is essentially the quantity of water that the soil is able to suck up, and hold, in its interstices by capillary action, which is quite a different matter.

## 5.1 Samples of Soil.

- 5.11 Rock.
- 5.12 Gravel.
- 5.13 Sand.
- 5.14 Clay.
- 5.15 Loam, or Humus.
- 5.16 Sandy Loam.
- 5.17 Peat.
- 5.19 Made Soils, *i.e.*, Soils containing House Refuse.

## 5.2 Analytical Apparatus.

- 5.21 **ELUTRIATOR**, or apparatus, for separating a sample of soil into its various parts, by a process of washing and sedimentation.

An idea of the composition of the soil may be obtained by the use of this apparatus, and depends upon the fact that the heavier particles sink more rapidly than the finer particles, so that, on settling, the soil separates out in its different layers, *e.g.*, rock, gravel below, then sand, then clay, and finally humus on top. By the use of the foot mle. a rough percentage composition is thus obtained.

## 5.3 Permeability of Soil.

- 5.31 **APPARATUS EXHIBITING THE PERMEABILITY OF SOIL TO AIR.**

This exhibit shows very well how permeable an ordinary sandy soil is, *e.g.*, to air, very slight pressure indeed being sufficient to force the air through a couple of feet of the soil. The closer the



texture, the more pressure will be required, and, in this connection, it may be noted that if the interstices of the soil be occupied by water, the whole mass practically becomes impervious to air, but the interstices unoccupied by water are always occupied by air or gas.

**5.32 TABLES SHOWING THE ORDER OF PERMEABILITY OF GASES of the various kinds of soils.**

**5.33 TABLE SHOWING COMPOSITION OF A SPECIMEN OF GROUND AIR.**

The special points to be noted are the percentage of  $\text{CO}_2$  and of moisture ( $\text{H}_2\text{O}$ )

**5.34 TABLE SHOWING PERMEABILITY OF SOILS TO WATER.**

This table simply shows the rate at which water or sewage it may be, can run through a given sample of soil; it is important from the point of view of polluting materials travelling through the soil and contaminating water supplies.

**5.37 TABLE SHOWING THE WATER HOLDING CAPACITY OF VARIOUS SOILS.**

As has already been noted, this water holding capacity depends entirely upon the capillary attraction.

**5.38 Model exhibiting the different powers which various soils possess in drawing up water, and holding it in the interstices, in other words, capillarity. It shows very well that the smaller the grains, and the smaller the interstices of the soil, the more marked the capillary attraction.**

d, and, in  
the inter-  
the whole  
r, but the  
occupied

#### PERMEABILITY

SPECIMEN OF

the large

#### TO WATER.

h water. or  
sample of  
f view of  
e soil and

#### CAPACITY

er holding  
capillary

ch various  
ng it in its

It shows  
the inter-  
e capillary

RECEIVED

1912  
1913  
1914  
1915  
1916  
1917  
1918  
1919  
1920  
1921  
1922  
1923  
1924  
1925  
1926  
1927  
1928  
1929  
1930  
1931  
1932  
1933  
1934  
1935  
1936  
1937  
1938  
1939  
1940  
1941  
1942  
1943  
1944  
1945  
1946  
1947  
1948  
1949  
1950  
1951  
1952  
1953  
1954  
1955  
1956  
1957  
1958  
1959  
1960  
1961  
1962  
1963  
1964  
1965  
1966  
1967  
1968  
1969  
1970  
1971  
1972  
1973  
1974  
1975  
1976  
1977  
1978  
1979  
1980  
1981  
1982  
1983  
1984  
1985  
1986  
1987  
1988  
1989  
1990  
1991  
1992  
1993  
1994  
1995  
1996  
1997  
1998  
1999  
2000  
2001  
2002  
2003  
2004  
2005  
2006  
2007  
2008  
2009  
2010  
2011  
2012





# MICROCOPY RESOLUTION TEST CHART

(ANSI and ISO TEST CHART No. 2)



**APPLIED IMAGE Inc**

1653 East Main Street  
Rochester, New York 14609 USA  
(716) 482 - 0300 - Phone  
(716) 288 - 5989 - Fax







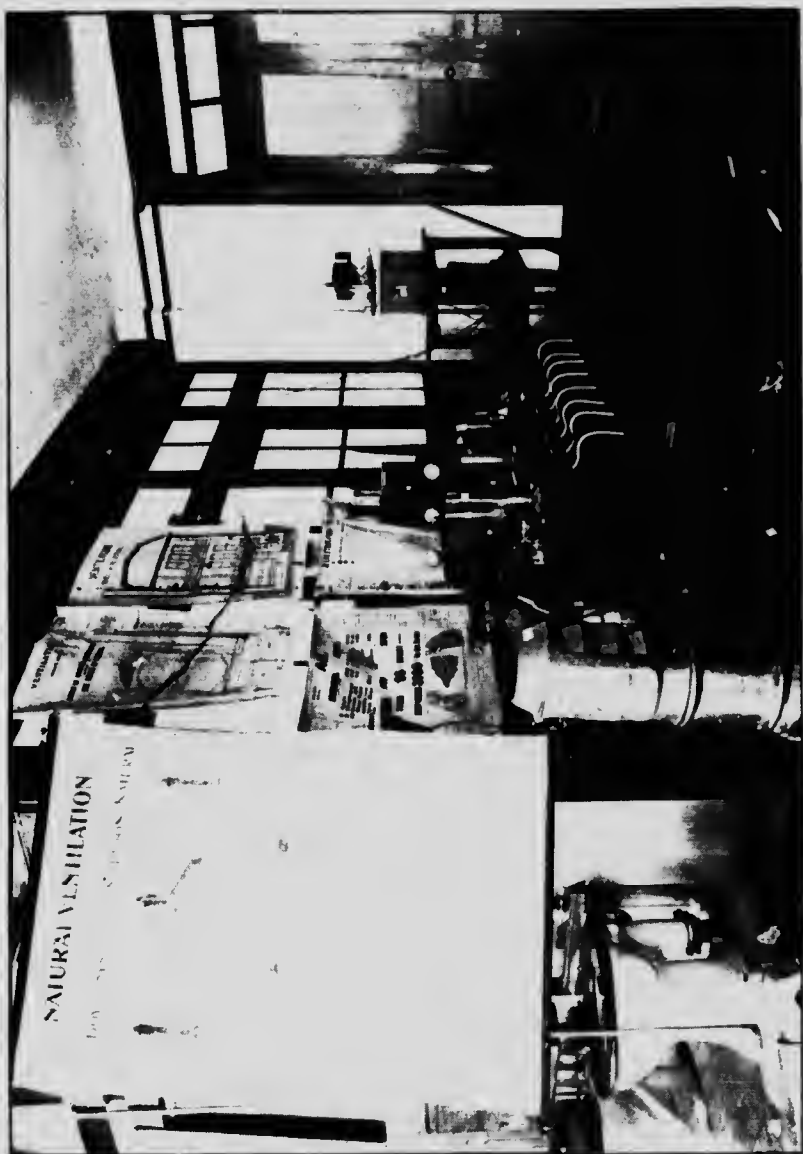

## SECTION VI. —VENTILATION.

### 6.1 Physical Apparatus.

#### 6.11 APPARATUS SHOWING THE EFFECT OF DIFFERENT DENSITIES

on two columns of air, exactly the same size.

#### 6.12 ANEMOMETER RECORDING THE VELOCITY OF AN AIR CURRENT.

#### 6.13 CYLINDER FOR COLLECTING SAMPLES OF AIR, WITH EXHAUST, AND GAUGE.

The cylinder is first of all exhausted of air, the taps are then closed, and the cylinder can be transported to any point where a sample of air is desired.

One of the stop-cocks is then opened, the air rushes in, and so the sample is taken.

When it is desired to analyze the sample, the air is displaced from the cylinder by water, and collected.

#### 6.14 WORKING MODEL SHOWING POROSITY OF AN ORDINARY BRICK.

It is astonishing what an amount of air will pass through an ordinary brick, under slight pressure.

### 6.2 Air "lets."

#### 6.21 MODEL OF TOBIN'S TUBE, ON STAND.

the wooden partition representing the wall of the house.

The long curved-up portion is the inside. Height of the inner opening generally about 4 feet from the ground. Inside the tube is a small valve for regulating the amount of air.

#### 6.22 MODEL OF TOBIN'S TUBE, DETACHED.

This possesses a small screen, otherwise the same in all respects as 6.21.

#### 6.23 MODEL OF TOBIN'S TUBE, SHORT VARIETY.

It is placed in the wall so that the inner opening should be about 4 feet from the ground. The valve and dust screen are the same as in the preceding variety.

#### 6.24 MODEL OF COOPER'S LOUVRE.

This slotted window is usually placed at the top of the room, the slots are so arranged as to give the incoming air an upward direction towards the ceiling. From its position with reference to the other part of the room, experience has shown that, more often than not, it acts as an outlet, and not as an inlet.

#### 6.25 MODEL OF HINKS—BIRD WINDOW.

This simple arrangement, whereby the lower sash of an ordinary window is raised by means of a plug of wood, is eminently suitable for poor property where expensive ventilators cannot be afforded. The incoming air finds its way into the room between the two sashes, and by virtue of the arrangement, is given an upward tendency.

#### 6.26 WORKING MODEL OF ELLISON'S BRICK.

This apparatus is very useful for ventilation below floors, and in some instances for common living rooms

It consists of a brick of ordinary size, in the centre of which, one or two holes are bored.

The holes are of conical shape, the smaller end is the outside, and the larger end is the inside.

This conical opening prevents the incoming air from impinging upon any object in the room with too great a force or velocity, for, when the model is worked, it can be seen how beautifully diffused the current of air is, and also, how much less is the velocity of the air at the inner opening than it is at the outer opening.

#### 6.27 WORKING MODEL OF SHERINGHAM'S VALVE.

This apparatus is usually fixed in the upper part of the room, and is intended to act as an inlet, but, by virtue of its position near the ceiling, more often than not acts as an outlet.

### 6.3 Air Outlets.

#### 631 MODEL OF MICA-FLAP VALVE.

This is placed in the upper part of the room, and allows communication from the room to the chimney, but not vice-versa. The apparatus when new acts very well, but after it has been used for a time, the hinges of the flaps begin to rust, and become fixed, so that the valve no longer works.

### 6.4 Extraction Apparatus.

#### 6.41 MODEL OF SIMPLE BI-VALVE COWL.

Cowls are useful to prevent back draft down the chimney, and are built in such a way that wh. never

the wind blows across them, in whatever direction an up-draft is always caused.

It is to be noted that any cowl must of necessity offer a considerable amount of friction to the out-flow of air, but this disadvantage is more than counterbalanced by the absence of back drafts, the latter being one of the principal reasons why cowls are used.

#### 6.42 BOYLE'S AIR PUMP VENTILATING COWL.

(Presented by Messrs. Boyle & Co., Holborn Viaduct, London, England.)

The working principle of this is the same as 6.41, the chief object for which it is used being more of an extraction shaft than to prevent back drafts.

#### 6.43 BOYLE'S IMPROVED AIR PUMP VENTILATING COWL.

(Presented by Messrs. Boyle & Co.)

The working principle is precisely the same as 6.42.

#### 6.44 MODEL OF BOYLE'S AIR PUMP VENTILATING COWL.

(Presented by Messrs. Boyle & Co.)

Connected with air-tight space, representing a room in which two inlets are placed at the lower part.

This model shows the extraction power of the air pump. It may be noted that the "pumping" action depends upon the wind blowing over the cowl, and that on absolutely calm days the outflow of air would depend entirely upon natural forces, viz., difference of density in the air inside and outside the room, due to difference of temperature.

#### 6.45 DIAGRAM SHOWING PLANS OF BOYLE'S APPARATUS

as applied to school rooms, houses, etc.

(Presented by Messrs. Boyle & Co.)

#### 6.46 FULL SIZED TILE FOR CHIMNEY STACK.

(Presented by the Standard Tile Co., St. Johns, Que.)

### 6.5 General Apparatus for Ventilation.

#### 6.51 WORKING MODEL, BUILT TO SCALE.

showing rectangular room with fire-place, chimney, inlets, and outlets.

It illustrates the principles of ventilation as carried out by natural forces, and shows very beautifully the relationship that ought to exist between inlets and outlets, viz., that the inlets ought to be, in total area, rather larger than the outlets.

If this be not the case, as shown by the model, some of the outlets will be converted into inlets.

## 6.9 Meteorological Instruments.

### 6.91 WIND GAUGE.

This records in miles, and fifths of miles, up to a total of 500. It shows the movement of the air in a given time, and from this the velocity is calculated.

### 6.92 ORDINARY RAIN GAUGE.

This reads down to  $\frac{1}{100}$  of an inch.

### 6.93 THERMOMETERS.

#### 6.931 MAXIMUM AND MINIMUM THERMOMETER (Six's).

#### 6.932 RADIATION THERMOMETER.

This instrument is used for recording the direct heat of the sun's rays; it consists of an ordinary thermometer, the bulb of which is blackened, placed inside a vacuum tube; the latter is used so as to prevent any error by conduction, due to the temperature of the surrounding air.

#### 6.933 RECORDING THERMOMETER OR THERMOGRAPH (7 days)

This instrument requires to be standardized by means of a good mercurial thermometer. The record is fairly accurate to within about a half a degree.

### 6.94 BAROMETERS.

#### 6.941 FORTIN'S STANDARD BAROMETER.

This is an excellent instrument, where exceedingly accurate observations are required. It is very neces

sary always to see that the surface of the mercury in the cup below, just touches the ivory point.

The ivory point records zero on the side scale. By means of the vernier, readings can be taken to  $\frac{1}{500}$  of an inch or  $\frac{1}{10}$  of a m. m.

In very accurate observations, corrections for temperature, altitude, and expansion of brass casing must be made; in the ordinary work, co-efficient of expansion of metal can be ignored.

Corrections for altitude may be roughly taken, an inch of mercury to one thousand feet in height.

For temperature  $\frac{1}{10000}$  part of an inch of mercury for every degree F.

#### 6.942 RECORDING BAROMETER OR BAROGRAPH (7 days).

This instrument has to be standardized by means of a mercurial barometer, and works fairly accurately to about  $\frac{1}{10}$  of an inch.

#### 6.95 SUN-SHINE RECORDERS.

##### 6.951 CAMPBELL-STOKES' SUN-SHINE RECORDER.

This instrument records the amount of actual sunshine, not day light. The instrument must be carefully adjusted, the lower end must point due south, and the angle of declination must correspond to the latitude of the place.

The glass ball acts as a perfect lens with  $1\frac{1}{4}$  inch focus; the sun's rays are thus brought to a point on the paper, where a hole is burnt, and as the earth moves, this focal point moves, leaving a burnt track along the paper, indicating the actual time that the sun is not obscured in any way.



**6.96 HYGROMETERS.****6.961 DANIEL'S HYGROMETER, direct method.**

This instrument records the actual temperature at which the dew is deposited.

**6.962 HAIR HYGROMETER.**

This instrument is by no means accurate.

**6.963 WET AND DRY BULB THERMOMETERS.**

This is the indirect method of calculating the dew point, and is the one most commonly used.

It depends upon the fact that the drier the air the faster will be the evaporation, and as the evaporation causes lowering of temperature, so will the wet bulb differ from the dry.

By a series of tables, the dew point is calculated from these differences of temperature.

ture at

the dew

air the  
oration  
t bulb

culated

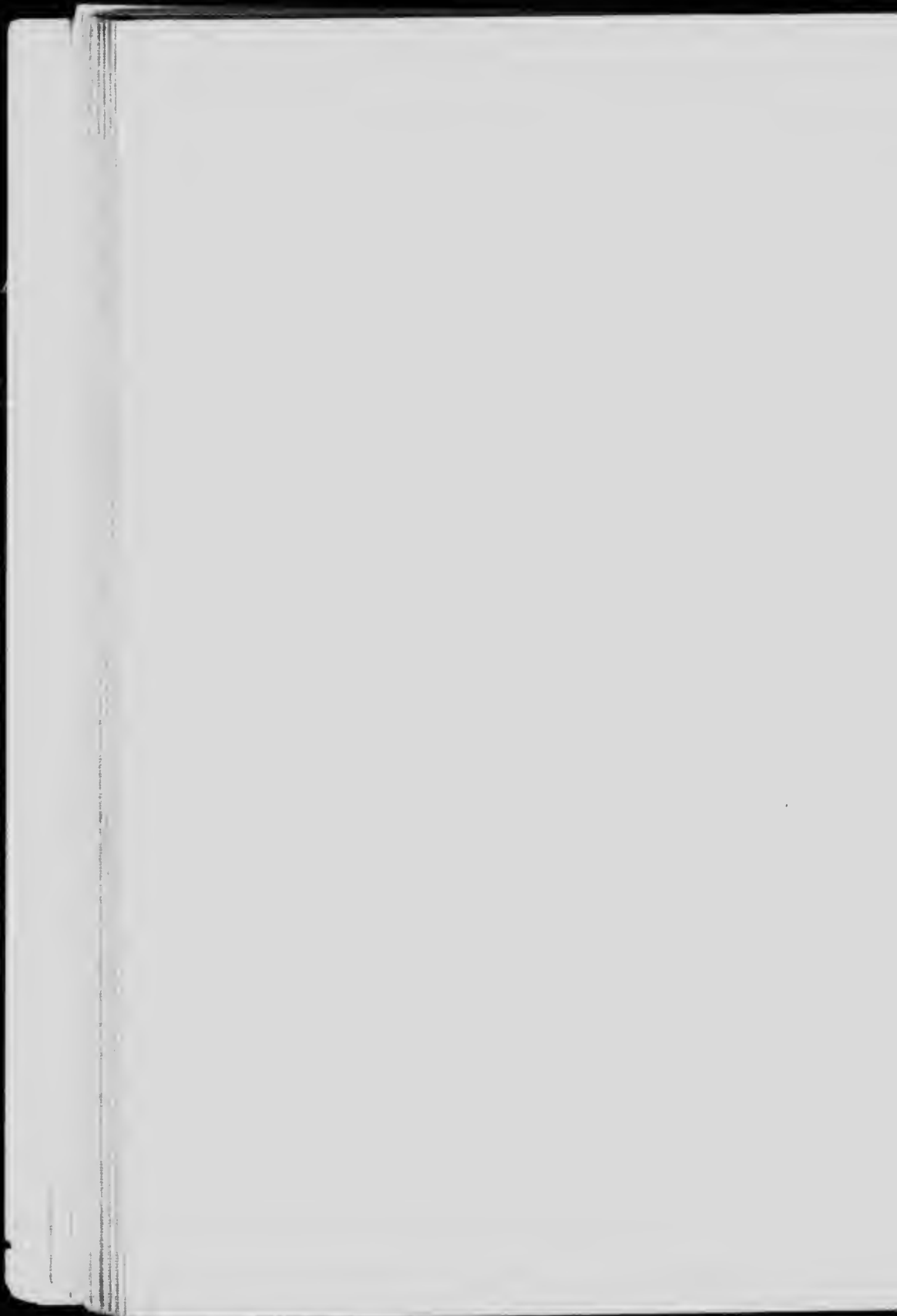









## SECTION VII. DRAINAGE AND REFUSE DISPOSAL.

### 7.1 Traps.

#### 7.11 SIMPLE TRAPS.

- 7.111 Simple S-trap, showing depth of water seal, cleansing eye, etc.
- 7.112 Modified S-trap.
- 7.113 Simple U-trap.
- 7.114 Simple P-trap,
- 7.115 Model of 4-inch iron P-trap.
- 7.116 Simple syphon trap.
- 7.117 Model of dipstone trap (old fashioned, not used now-a-days)

#### 7.12 GULLEY TRAPS.

- 7.121 Simple gulley trap.
- 7.122 Sediment gulley trap.
- 7.123 Head for gulley trap.

#### 7.13 INTERCEPTING TRAPS.

- 7.131 Buchan's intercepting trap (model.)
- 7.132 Full sized sectional model of Buchan's intercepting trap.
- 7.133 Running trap with central inspection eye, 6 inch tile drain.
- 7.134 Weaver's intercepting trap (model.)

#### 7.14 GREASE TRAPS.

- 7.141 Sectional model grease trap, full sized.



### 7.15 COMPLEX TRAPS.

7.151 Sanitas trap.

7.152 Ideal trap.

7.153 Simple P-trap with mercury air-seal.

A word may be said with reference to traps: experience has taught that the simple trap is, after all, the best. The following are the essentials of a good trap:

1. Even linen throughout: absence of corners and projections to prevent accumulation of debris.
2. Efficient water seal (2 to 3 inches.)
3. Simplicity of construction.
4. Self-cleansing.
5. Access, inside and out, for cleansing purposes.

It will be seen from these points, that the simple trap meets the requirements better than any other, and it is for these reasons that the complex traps have not accomplished all that was expected of them. It may be noted that these complex traps were invented chiefly with a view to prevent syphonage of the water seal, but to attain this, several of the other essentials of a good trap have been of necessity sacrificed.

The same remarks apply with equal force to the intercepting trap.

## 7.2 Water Closets and Flush-Tanks.

In this Section, containing water closets, the exhibits have been arranged in the order in which they came before the public.

os :  
ter  
of a

ers  
of

s.

ple  
aer.  
ave  
It  
ted  
the  
her  
sity

the

bits  
me

Syphon Jet  
English Type.

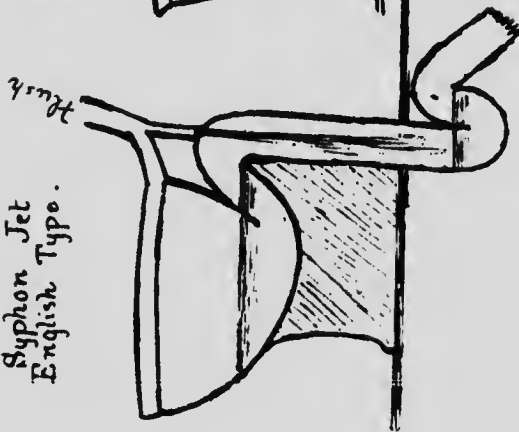

Syphon Jet  
American Type

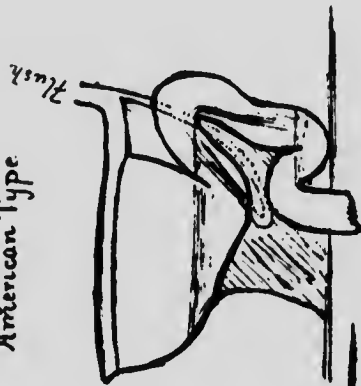

Washdown  
English Type

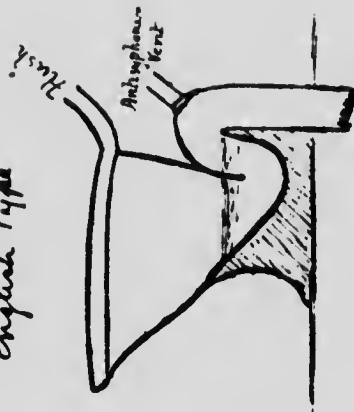

The first variety of water closet invented was the old-fashioned PAN closet; next in order came the LONG HOPPER, and the SHORT variety of the same.

These two classes are now entirely out of date, and are no longer sanctioned by municipal authorities, nevertheless, one comes across them, every now and again, in very old houses in out-of-the-way places, and a series of exhibits would not be complete without containing these interesting old-time specimens.

The next in order of invention are the simple WASH-DOWN varieties.

These have stood the test of time. They are much patronized at the present day, and it is very doubtful if the modern types are such a vast improvement over the simple WASH-DOWN.

Closely following the WASH-DOWN came the type known as the WASH-OUT, which, at the time, was thought to be a great improvement over the WASH-DOWN, but here again, experience has proved that it has not accomplished everything which was expected of it; its chief drawback is that it is not self-cleansing in a satisfactory way.

During the last decade or so, the SYPHON-JET CLOSET has come to the front. There are a good many kinds of this closet on the market, but we can divide them into two classes, the English, and the American.

The Syphon jet closet must have, for its working, two traps, with an intervening portion of free pipe, containing air.

The working principle is the partial exhaustion of the air in the long limb, so that the upper trap is syphoned off at the same time as the main flush comes down into the bowl of the closet.

There are thus two forces working—propelling

forces from the bowl side, and a suction force from the drain side; in this way the contents of the trap and bowl are thoroughly cleared away.

In the English type, the jet, which creates the partial vacuum, is situated immediately behind the first trap, allowing the jet of water to impinge upon the surface of the second trap, thus carrying away a certain amount of air contained in the long limb.

In the American type, the jet is situated in the lower part of the first trap, and forces a certain amount of the water seal over the back lip, to fall down on the surface of the second trap, so carrying the air with it.

There is no doubt about the self-cleansing of this type of closet, the only drawback to its use being that it creates rather a marked noise when flushed. A slighter disadvantage is the fact that, by being more complicated in structure than a simple WASH-DOWN, it is more liable to get out of order.

A word may here be said, with advantage concerning FLUSH-TANKS. The simple variety of FLUSH-TANKS is that of one outlet, with simple plug valve, the flush taking place only so long as the valve is pulled up. This simple type is not to be recommended, for the reason that people won't keep the valve pulled up long enough for an efficient flush to take place. The type in common use is the SYPHONIC FLUSH-TANK: in this type the flush is actuated by a simple pull of the handle; this starts the syphon working, and the whole flush is completed automatically.

Most tanks are situated about 6 feet above the level of the closet; this is to give the flush a head.

There are one or two varieties where the tank is placed low down, about a foot above the closet, in this case the outlet has to be much bigger (2 to 2½

inch pipe), so that the volume of water gives the necessary head to the flush.

## 7.21 PAN CLOSETS.

### 7.211 OLD FASHIONED PAN CLOSET

with container and bellows "cut-off" complete. This type is now no longer in use; it had to be abandoned because it was always so very filthy.

(Presented by the Royal Sanitary Institute, London, England.)

## 7.22 HOPPERS.

### 7.221 OLD FASHIONED LONG HOPPER

with detachable S-trap. This type of closet is also out of date for the same reason as the preceding, namely: because it is impossible to keep it clean. The painted line on the inside indicates the usual course which the flush takes, and it will be readily seen that it could not possibly cleanse the whole surface of the bowl.

### 7.222 SHORT VARIETY OF HOPPER CLOSET.

This has the same drawbacks as the long hopper, in every way, and is not used now-a-days. Another fault about these hopper closets is the detachable trap.

The joint between the bowl and the trap was very often leaky, and, hence a nuisance.

## 7.23 WASH-DOWN CLOSETS.

### 7.231 SIMPLE WASH-DOWN CLOSET

with syphon flush-tank. This variety is a very good one indeed, and has stood the test of time.

7.232 A full size sectional model of WASH-DOWN CLOSET, showing construction of flushing rim, trap and anti syphonage vent, depth and area of water seal.

#### 7.24 WASH-OUT CLOSETS.

##### 7.241 WASH-OUT CLOSET

with cheap variety of syphon flush-tank. The drawback to this type is that the whole of the inner surface of the bowl is not completely cleansed, especially in front. Again the force of the flush is not directed directly into the trap, but is broken, more or less, against the front wall of the pan, hence, very often one finds them somewhat foul.

#### 7.25 SYPHONIC CLOSETS.

##### 7.251 SYPHON JET CLOSET, ENGLISH TYPE

with flush-tank, 6 feet above. In this specimen the flush is exceedingly powerful, though of very short duration.

The workmanship about this exhibit is very strong and durable.

(Presented by Messrs. Jennings & Co., Lambeth, London, England)

##### 7.252 SYPHON JET CLOSET.

American type with flush-tank placed low down, about one foot above the bowl; in this exhibit the flush is not so powerful, but of longer duration.

(Presented by Messrs. Robertson & Co., Craig St., Montreal)

### 7.253 SYPHON JET CLOSET, AMERICAN TYPE WITH FLUSHOMETER IN PLACE OF FLUSH-TANK.

This flushometer is commanding more and more attention, and is claimed to be much superior to the flush-tank; it works well, but requires a large supply pipe and good pressure, at least a head of 15 feet of water.

A word of warning against this flushometer is necessary, not against the mechanism, for that is good, but against the way in which it occasionally is connected up with the water supply pipe.

The danger under these conditions is that of back flow or suction into the water main; if the flushometer be connected up with a pipe from a tank used solely for flushing purposes, then it has no such drawbacks, and can be strongly recommended.

(Presented by the Standard Manufacturing Co., Pittsburg, Penn.)

## 73 Baths and Sinks.

### 7.31 FULL SIZE BATH.

enamelled iron, fittings complete, vertical plunger, with overflow in the same.

Enamelled iron has of late years come much to the front as a rival of porcelain for baths and sinks. In comparison one may note that enamelled iron is slightly cheaper than porcelain, and is not so liable to breakage. On the other hand, enamelled iron is liable to chip, and once the enamel is off the iron rusts. This drawback has been reduced to a minimum in modern enamelling.

(Presented by the Standard Manufacturing Co., Pittsburg, Penn.)



**7.32 STOP SINK.**

enamelled iron, fittings complete, S-trap with anti-siphonage vent.

Stop sinks are in every respect to be treated precisely in the same way as water closets. They are very useful in hotels, hospitals and very big houses.

(Presented by the Standard Manufacturing Co., Pittsburg, Penn.)

**7.33 LAVATORY SINK.**

enamelled iron, fittings complete, vertical plunger, with overflow in same. This variety of sink is attached to the wall, and has no supports underneath. This arrangement favours access for cleaning purposes, and is at the same time very strong.

(Presented by the Standard Manufacturing Co., Pittsburg, Penn.)

**7.4 Drain Pipes, etc.****7.41 JOINTS, PLUMBING, ETC.**

7.411 Specimen of 4 inch iron piping, showing method of lead caulking for joint.

(Presented by Messrs. Hughes & Son, Montreal.)

7.412 Specimen of wiped solder joint. This shows the junction of lead pipe to brass collar.

7.413 Specimen of wiped solder joint: junction between two pieces of iron pipe. The bright iron is coated with a thin layer of copper, by rubbing the surface with the copper soldering iron.

7.414 Specimen of wiped solder joint: junction between two pieces of lead pipe. This is the best method of joining lead to lead, the resulting joint is

very strong. Occasionally one sees a seamed joint between two pieces of lead. It is not to be recommended because the joint is weak and liable to crack.

- 7.415 Models of eccentric joint for iron piping. The mechanism insures a perfectly true invert. The joint is caulked with molten lead precisely the same as any other simple joint.

(Presented by Messrs. Freeman & Co., 1 Victoria St., London, S.W. England.)

#### 7.42 IRON PIPES.

- 7.421 Specimen of 2 inch iron pipe, galvanized.

- 7.422 Specimen of a 4 inch iron drain pipe.

(Presented by Messrs. Burns Bros., Whitehall, London, England.)

- 7.423 Specimen of a 4 inch iron drain pipe with cleansing flange on end.

(Presented by Messrs. Burns Bros., London.)

- 7.424 Iron manhole cover with double water seal.

(Presented by Messrs. Burns Bros., London.)

#### 7.43 TILE AND STONEWARE PIPES.

(Presented by the Standard Tile Co., St. Johns, Que.)

- 7.431 Models of ordinary tile drain pipe, simple joint, with cement. In laying ordinary tiles, and iron drains, the difficulty is to keep the invert perfectly true.

- 7.432 Models of stoneware drain pipe with bituminous collar to insure a perfect invert. The joint is completed with Portland cement.

7.433 Full size 6 inch tile drain pipe.

7.434 Two specimens of tile invert for sewers.

#### 7.14 JUNCTION PIPES, REDUCING SECTIONS, ETC.

7.441 Full size 6 inch tile drain with 4 inch Y.-junction.  
(Presented by the Standard Tile Co., St. Johns, Que.)

7.442 Full size 6 inch tile drain pipe, with 6 inch T.-junction.

(Presented by the Standard Tile Co.)

7.443 A 4 inch iron pipe with 4 inch Y.-junction.

(Presented by Messrs. Burns Bros., Whitehall, London, England.)

7.444 A 4 inch heavy iron drain pipe, with triple junction. On the upper surface is a bolted casing to form inspection chamber.

(Presented by Messrs. Burns Bros., Whitehall, London, England.)

7.446 Reducing section of tile drain pipe, from 6 inches to 4 inches.

(Presented by the Standard Tile Co., St. Johns, Que.)

7.447 Expanding section of tile drain pipe, from 4 inches to 6 inches.

(Presented by the Standard Tile Co., St. Johns, Que.)

7.448 A 6 inch tile drain pipe, curve-bend.

(Presented by the Standard Tile Co., St. Johns, Que.)

#### 7.45 DRAINAGE SYSTEMS, ETC.

7.451 Model showing simple house drain: tile pipes laid on cement bed; manhole, with intercepting

trap, at the far end of the drain. The upper end of the drain is where the soil-pipe enters.

- 7.452 A model showing the manner in which a water seal, in a trap, may be broken by expansion of gas.

A little water is placed in the trap; the air in the glass bulb may be warmed by placing the hands on on the outside, the air inside is then under greater pressure, and the water seal is forced out.

- 7.453 Working model of system of house drainage, showing the different methods by which the water seals, in the traps, may be broken.

It also illustrates the disconnection of the drain from the sewer, and the ventilation of the whole system.

The four methods, in which a water seal may be broken, are as follows :

- 1 Evaporation.
- 2 Suction.
- 3 Back pressure.
- 4 Momentum.

#### 7.46 DRAIN TESTERS, ETC.

##### 7.461 BURNS' ECLIPSE DRAIN TESTER

with connecting pipes. This is a simple smoke testing machine. Smouldering cotton waste is placed in the interior of the copper chamber, the cover is placed over it, and a little water poured down on the side of the cover to form a water seal. On working the bellows, the smoke will be seen to issue from the connecting pipe, and if this be connected to the drain, the smoke, of course, will enter the drain pipe.

and any crack or hole in the drain will be at once evidenced by the escape of smoke therefrom.

(Presented by Messrs. Burns Bros., Whitehall, London, England.)

#### 7.462 BURNS' CIRCULAR DRAIN PLUGS.

6 inch, 5 inch and 4 inch.

(Presented by Messrs. Burns Bros., London.)

#### 7.463 BURNS' SQUARE GULLEY PLUG WITH CLAMP.

(Presented by Messrs. Burns Bros., London.)

#### 7.464 BURNS' EXPANDABLE GULLEY PLUG.

canvas cover, with air pump to expand the same, also pressure gauge for testing pressure inside the drain.

This is a very useful plug, and one to be strongly recommended; it will fit any drain from 4 to 9 inches.

(Presented by Messrs. Burns Bros., London.)

#### 7.465 RAVENOR'S PATENT DRAIN TESTER.

(Presented by Mr. Ravenor, Newbury, Bucks, England.)

The machine is for testing drains, and soil pipes, by means of smoke, and air pressure, and has for its object the arrangement and construction of an apparatus with which Smoke Rockets can be used very effectively, in drains of considerable length, without danger of explosion of unconsumed gases emitted from the previous Rocket; and, further, ready adaptability is secured for testing with air and smoke, separately or combined, at high or low pressure, as desired, viz., from  $\frac{1}{2}$  oz. to 10 lbs., or more. Rockets can be fired successively without disturbing the con-

once

gland.)

inch.

same.  
the

ongly  
ches.

s, by  
or its  
ppar-  
very  
hou  
itted  
lapt  
noke.  
ce, as  
kets  
con-

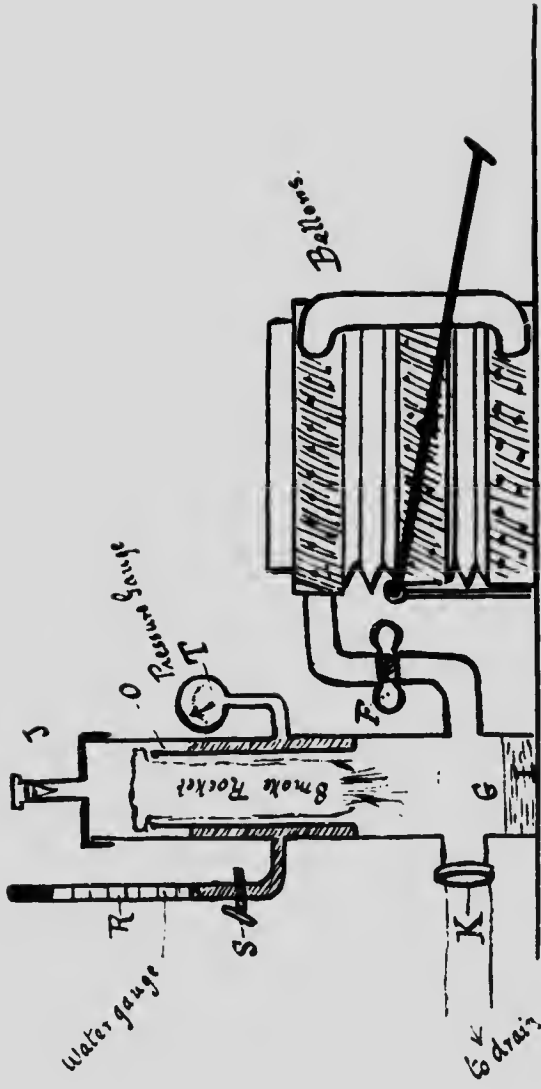

7.165. RAVENOR'S DRAIN TESTER.

nection with the drain, and without fear of explosion. At the bottom of the Smoke Chamber, Fig. G, will be found a small receptacle, Fig. I, for containing water, which will catch and extinguish any sparks, or incandescent material, that may be emitted by the Rocket during combustion; also fresh Rockets may be inserted, by simply removing the brass cap, Fig. J, at the top of the cylinder.

#### TO TEST FOR LOW PRESSURE.

Before using the machine, remove the cap J from top of cylinder, and pour in water, until it can just be seen in the lower part of gauge R.

After stopping all ventilating pipes, connect up drain with the outlet K, by means of a length of hose, and, leaving both stop cocks (Figs. S & F) open, proceed to work the bellows. This will create a pressure on the water in the annular channel O, and cause the water to rise in the gauge glass R. The stop cock F must then be closed, and if the column of water in the gauge glass is maintained, it proves the drain is sound, but if the column of water falls, the drain is unsound. In such case and to locate the leakage, remove the cap J, insert a lighted smoke rocket, replace the cap J, and work bellows.

#### TO TEST FOR HIGH PRESSURE.

Simply shut off the small stop cock S and proceed as before. When the bellows are worked, the pressure will be indicated on the pressure gauge T, and on obtaining the desired pressure, quickly close the stop cock F, and if the pointer in the pressure gauge maintains its position the drain is sound, but if it falls towards zero the drain is unsound. The bellows will give a pressure of 4 lbs., equal to a column



of water 8 ft. high. If a higher pressure is required, an ordinary cyclist's inflator may be attached to the valve fitted in the cap J, but 8 lbs., equal to column of water 16 feet high, should be the maximum.

#### 7.49 DEFECTIVE DRAINAGE, PLUMBING, ETC.

- 7.491 Portion of trap from beneath a bath. The trap is made of seamed lead pipe and shows erosion along the line of seam. It also illustrates a hole, where the pipe has been eaten away by rats.
- 7.492 Specimen of P-trap made of seamed lead piping. Cracks and erosions can be seen all along the line of seam. It also shows too great depth of water seal; this is liable to prevent self cleansing of a trap.
- 7.493 Specimen of old lead P-trap with two overflows entering—one near the side of the trap, and the other at the lower part of it. The overflows most probably came from water tanks and safe-trays, and it can readily be seen how gases from the trap could find their way into the rooms, where these overflows took their origin.
- 7.494 Specimen of old fashioned D-trap with overflow pipe entering into the lower part. These D-traps are now-a-days condemned, and no longer allowed to be used. From their construction it is quite impossible for them to be self-cleansing, and hence they were always very foul, as this exhibit shows. In nearly every instance, the overflow from a water tank (such tank being very commonly used for drinking purposes), was always connected up with the D-trap, and it is obvious to everyone, seeing how filthy these traps were, that it was quite an

easy matter to have large volumes of gases of decomposition entering the living rooms

## 7.5 Sewage Disposal.

### 7.51 BROAD IRRIGATION.--Plan.

This is the simplest form of sewage treatment and the plan explains itself.

### 7.52 INTERMITTENT DOWNWARD FILTRATION. Diagram.

This scheme differs from the Broad Irrigation in the fact that it possesses collecting drain tiles placed about 3 feet below the surface of the ground. In this way a larger amount of sewage can be applied over a given area of land.

### 7.53 DIBBIN'S SYSTEM. Diagram.

This scheme is said to be purely Aerobic, but in actual practice a fair amount of Anaerobic action actually takes place.

Clogging of the first contact bed is the chief drawback to this system.

### 7.54 SCOTT-MONCRIEFF SYSTEM. Diagram.

In this system one gets an Anaerobic treatment first, and secondly, an Aerobic.

The first contact bed is very liable to become choked.

### 7.55 SEPTIC TANK SYSTEM.—Diagram.

The diagram explains the different components of the scheme.

After treatment in contact beds, in some cases, the effluent is applied to land on the Intermittent Downward Filtration Plan. Under such circumstances, a particularly fine effluent is the final result.

#### 7.56 SEWAGE DISPOSAL MODEL

of large size sewage bed with automatic sewage spreader. The supply being regulated by an automatic valve Mather and Platt's patent.

The tank A represents the sewage outfall. The sewage is banked up by means of the automatic valve B, until the necessary amount of sewage has been collected in A, when it is delivered to the automatic spreader C. This spreader slowly revolves and distributes the sewage evenly over the contact bed D. By the time the sewage has percolated through bed D, the organic matter has been completely oxidized, and the effluent is of a good standard. When the discharge has finished, the valve B closes until a fresh quantity of sewage has collected in A, when the process is repeated over again and so goes on continuously.

This process is to be recommended for weak sewage, and for effluents from settling tanks. The great feature is the continuous process. Unlike the simple contact bed which requires 8 to 12 hours rest out of 24, this continuous process is capable of going on steadily for months without stopping.

(Presented by Messrs. Mather and Platt, Manchester, England.)

#### 7.57 BOX CONTAINING MODEL

of automatic valves for supplying sewage sprinklers in series. This shows how the automatic gear can be applied to a series of beds at a sewage farm. The

256. SEWAGE DISPOSAL MODEL.

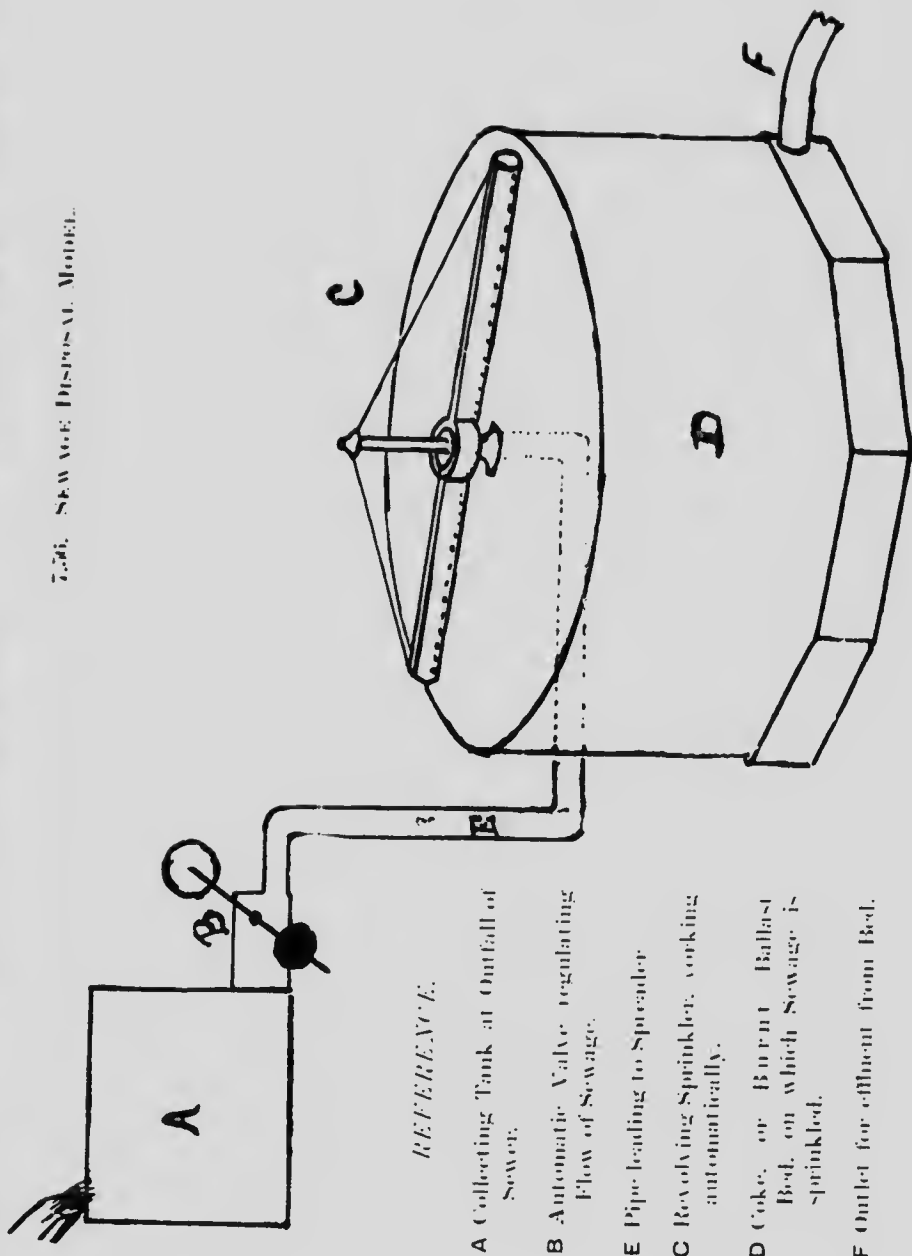

REFERENCE.

- A Collecting Tank at Outfall of Sewer.
- B Automatic Valve regulating Flow of Sewage.
- E Pipe leading to Sprinkler
- C Revolving Sprinkler, working automatically.
- D Coke, or Burnt Ballast Bed, on which Sewage is sprinkled.
- F Outlet for effluent from Bed.

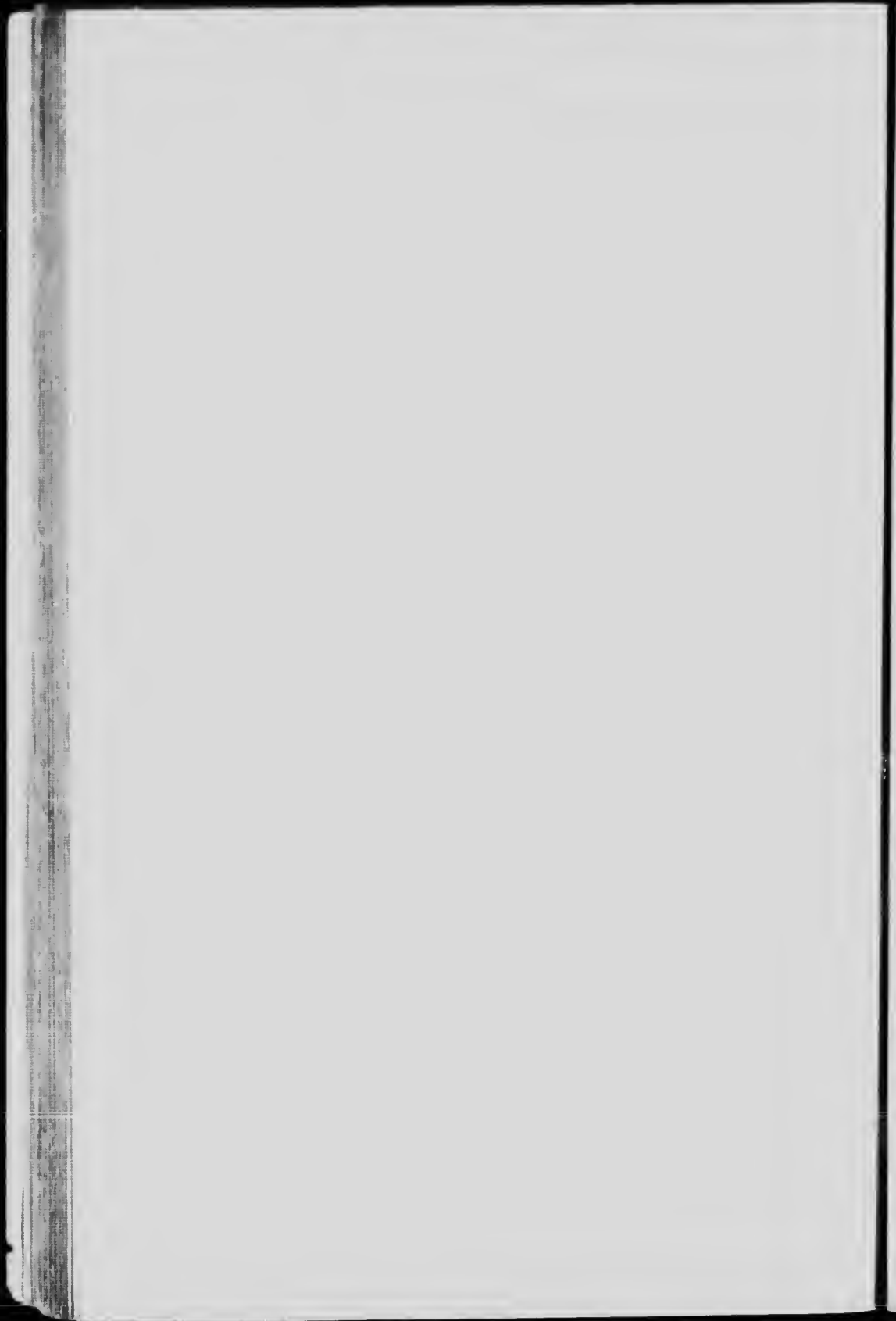

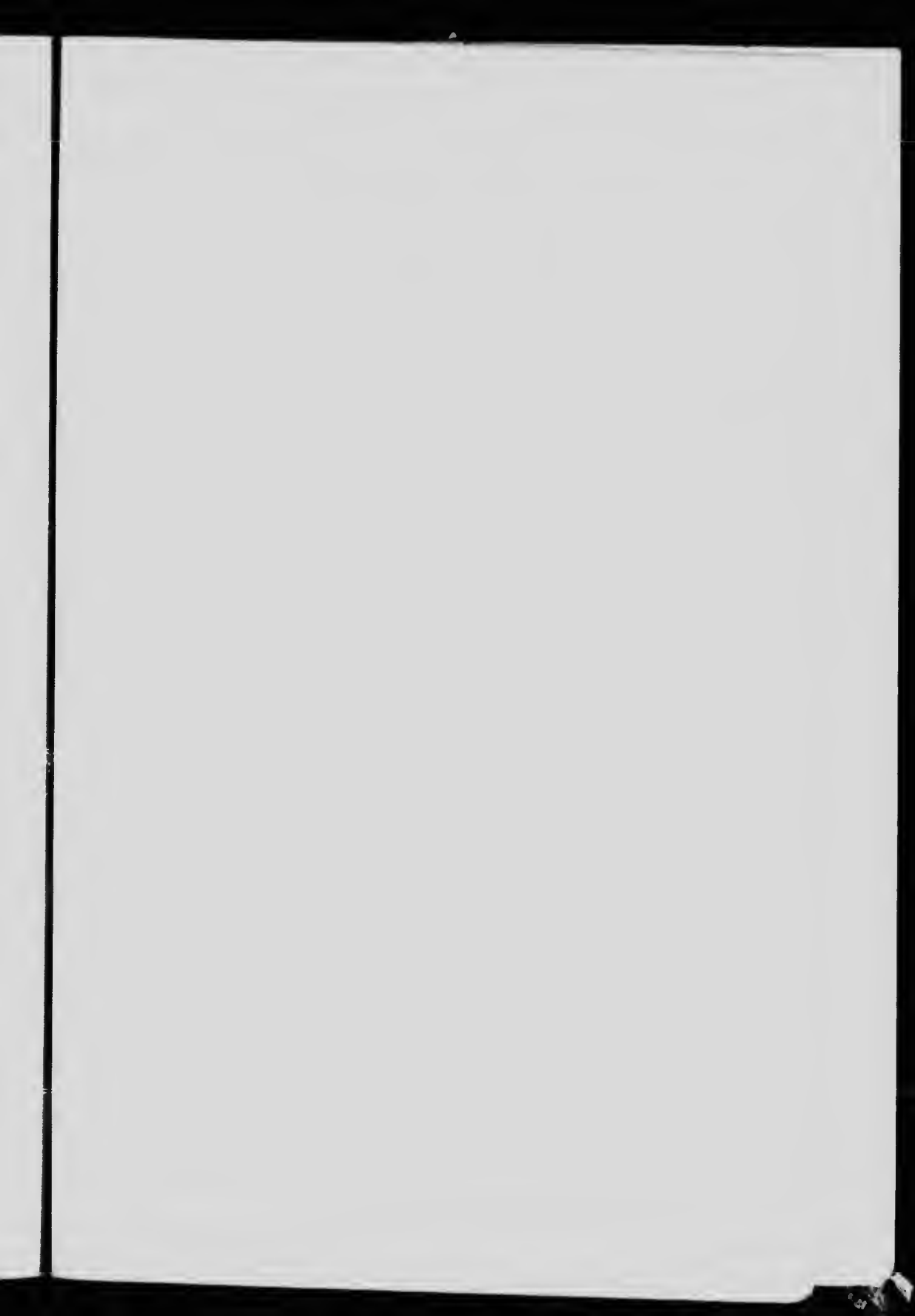

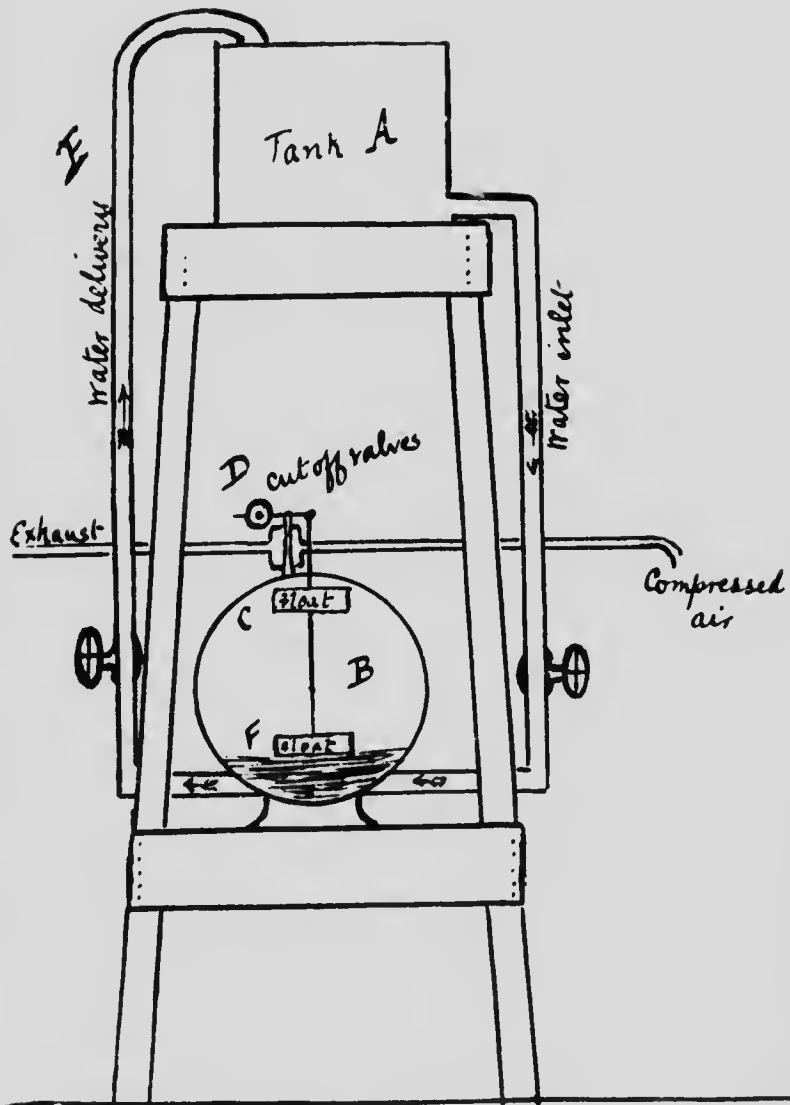

7.58 SHONE'S ELECTOR.

great beauty of the whole arrangement is that one man is quite capable of looking after a dozen beds.

(Presented by Messrs. Mather & Platt, Manchester, Eng.)

### 7.58 SHONE'S EJECTOR.

#### Large working model.

(Presented by Messrs. Hughes & Lancaster, Victoria St., London, S.W., England.)

This apparatus has proved of great benefit in manipulating sewage and water as regards promoting the flow of the same in the pipes. It is particularly useful in a flat country, where, owing to the depth which sewers, for instance, must eventually reach in order that the necessary fall may be given to them, a fresh start has to be given to the pipe somewhere near the surface, and this the ejector accomplishes automatically, being placed at suitable points where the sewers reach such a depth as to become unmanageable and the sewage is raised vertically to a point near the surface, and so begins on a new incline. Thus it goes on, and when the second incline has reached such a depth as is thought sufficient, it is raised again to the surface, and so on.

The model consists of a tank (A) at the top of the stand, representing a sewer; the sewage flows into a cylinder (B) in which it rises gradually, and when near the top lifts the upper float (C.) This actuates a series of cut off valves (D) which admit compressed air, supplied from a machine. This compressed air presses on the surface of the liquid in (B) and forces it through the water delivery tube (E) to any height required. In the model it is simply returned into the tank (A.) A valve, situated near the inlet, pre-



vents back flow along the inlet tube. As the sewage descends in the cylinder (B), it eventually runs clear of the lower float (F), and the weight of water in the lower float pulls down the cut off valves (D) which close the compressed air taps and open the exhaust. The sewage then begins to flow again from the tank (A) and gradually fills the cylinder (B), when the whole process is repeated as before.

This simple arrangement works automatically, as will be seen from the description, and it is only necessary in practice to supply the compressed air, which is done by a series of pipes laid underground, much in the same fashion as gas pipes are laid. The compressed air is supplied from a central station.

## 7.6 Disposal of Dry Refuse.

### 7.61 FULL SIZED GALVANIZED IRON DUST-BIN

for house refuse : capacity of 2 cubic feet.

Experience has taught that this is the most useful size. With an ordinary household, this bin will hold nearly a week's refuse, and under the ordinary municipal management, dust-bins are usually cleared twice a week.

The other important points about the bin to be noted are :

- 1 Quite air-tight, preventing access of rain, and the dust from blowing about the yard.
- 2 It is moveable.
- 3 It is impervious, so that no liquid matter can soak into it.
- 4 It can be thoroughly sterilized.
- 5 Its convenient size enables it to be easily handled.

### 7.62 DOMESTIC GARBAGE DESTROYER.

The apparatus is fixed in the flue just above the kitchen range. This is a useful little arrangement and obviates the necessity of putting decomposable matter into the dust-bin.

### 7.63 MODEL OF HORSFALL'S HIGH TEMPERATURE INCINERATOR.

(Presented by The Horsfall Co., Leeds, Yorkshire, England.)

The refuse is tipped at the back of the furnace and finds its way into the furnace chamber, generally by means of a "shoot." It then comes into contact first of all with the drying hearth; from there it is pushed along the fire bars until it comes into contact with the actual fire, which is situated near to the front door of the furnace. Previous to actual incineration, the refuse undergoes a marked process of distillation: the gases produced thereby are very obnoxious and have to be thoroughly dealt with. The fire itself is worked by a "hot blast" which is supplied by the steam jets of the blower; this generates a tremendous heat, usually about 2000 F. The outlet to the furnace chamber is situated immediately above the front door, leading into a zig-zag flue; this flue for a considerable distance is maintained at a white heat.

The fire itself is fed by the refuse only, and this is found to be quite sufficient for this arrangement.

It will be seen that the gases, produced by distillation, have to pass through the outlet, along the white hot flue before reaching the chimney; during their passage through the flue they are completely burnt.

As regards the refuse, nothing remains but fine ash and a little clinker. The ash collects in the space below the fire bars, and is very useful, when mixed with cement or lime, for making concrete or mortar. Lastly, there is a further economy: a series of boiler tubes can be placed in the flue, near the chimney, where the heat is quite sufficient to generate a large amount of steam, which can be utilized for mechanical purposes.

#### 7.69 MOULE'S PATENT EARTH CLOSET.

(Presented by the Moule's Earth Closet Co., Covent Garden  
London, Eng.)

This appliance is particularly useful for country houses; it is exceedingly simple, and the different parts explain themselves. The thing to be noted about it is that the contents of the bucket must always be kept dry. Slops and the like must be carefully excluded, otherwise when a large amount of moisture is present, decomposition sets in and a nuisance results.





## SECTION VIII. FOOD STUFFS AND CLOTHING.

### 8.1 Food Stuffs.

#### 8.11 TABLE SHOWING COMPOSITION OF VARIOUS KINDS OF FOOD.

These percentage compositions represent water free solids.

#### 8.12 BOX CONTAINING SPECIMENS OF ALL COMMON STARCHES.

Accompanying this exhibit is a series of slides showing the microscopic characteristics of the various starches.

#### 8.13 SERIES OF EXHIBITS.

showing all mineral and vegetable substances used for food adulterations.

##### 8.131 BREAD AND FLOUR ADULTERATIONS.

8.1311 Alum adulterant for bread, flour, and baking powder.

8.1312 Magnesium carbonate, adulterant for flour.

8.1313 Plaster Paris, adulterant for bread and sugar.

8.1314 Indian corn flour, adulterant for flour.

8.1315 Barley meal, adulterant for oatmeal.

8.1316 Bran, adulterant for oatmeal.

## 8.132 ADULTERANTS FOR SUGAR CONFECTIONERY.

- 8.1321 China clay, adulterant for peppermint lozenges.
- 8.1322 Barytes, adulterant for sugar.
- 8.1323 Verditer.
- 8.1324 Emerald green.
- 8.1325 Yellow chromate of lead.
- 8.1325a Carbonate of lead.
- 8.1326 Glucose, adulterant for sugar, honey, etc
- 8.1327 Ultramarine.
- 8.1328 Prussian blue.
- 8.1329 Indigo.
- 8.1320 Raw nuber.

## 8.133 ADULTERANTS FOR PEPPERS.

- 8.1330 Turmeric.
- 8.1331 Linseed Meal.
- 8.1332 Ground rice.
- 8.1333 Cinnabar.
- 8.1334 Red lead.
- 8.1335 Orpiment.
- 8.1336 True Brunswick green.
- 8.1337 Poivrete.
- 8.1338 Pepper shells.
- 8.1339 Artificial pepper mixture.
- 8.1339a Artificial Cayenne pepper.

## 8.134 ADULTERANTS FOR MUSTARDS.

- 8.1341 Ground rape seed.
- 8.1342 Ground oil cake.
- 8.1343 Potato starch.
- 8.1344 Mustard husks.
- 8.1345 Artificial mustard mixture.

## 8.135 ADULTERANTS FOR SPICES.

- 8.1350 Mustard husks, for allspice.
- 8.1350a Ground cocoanut shells, for allspice.
- 8.1351 Cassia, for cinnamon.
- 8.1352 Artificial clove mixture.
- 8.1353 Artificial allspice mixture.
- 8.1354 Artificial ginger mixture.
- 8.1355 Artificial nutmeg mixture.
- 8.1356 Artificial mace mixture.
- 8.1357 Exhausted cloves.
- 8.1357a Clove stems.
- 8.1358 Ground olive pips.
- 8.1358a Almond shells.
- 8.1359 Sawdust.
- 8.1359a Wild mace.

## 8.136 ADULTERANTS FOR ALCOHOLIC BEVERAGES.

- 8.1361 Boracic acid, for beer and milk.
- 8.1362 Aniline violet, for wines.
- 8.1362a Aniline red.
- 8.1363 Magenta, for red wines.
- 8.1364 Tannin.
- 8.1365 *Cocculus indicus*, for hops.
- 8.1366 Catechu.
- 8.1367 Red sandal wood.
- 8.1367a Yellow sandal wood.
- 8.1368 Brazil wood.
- 8.1369 Logwood.
- 8.1360 Caramel, for brandy, etc.

## 8.137 ADULTERANTS FOR PICKLES, SAUCES, ETC.

- 8.1371 Venetian red.
- 8.1372 Blue vitriol.
- 8.1373 Yellow ochre.



- 8.1374 Cochineal.
- 8.1375 Verdigris.
- 8.1376 Sample of Tomato Catsup, with artificial coloring matter.
- 8.1377 Sample of silk dyed with artificial catsup.
- 8.1378 Sample of silk treated with home made catsup.

## 8.138 ADULTERANTS FOR TEAS.

- 8.1381 Sample of pure tea.
- 8.1382 Sample of exhausted tea leaves, dried.
- 8.1383 Burnt nuber.
- 8.1384 Bichromate of potash.
- 8.1385 Black lead.
- 8.1386 Green vitriol.
- 8.1388 Iron filings.

## 8.139 ADULTERANTS FOR COFFEE.

- 8.1391 Pure coffee berry.
- 8.1392 Artificial coffee berry, or "Process coffee."
- 8.1393 Coffee pellets.
- 8.1394 Roasted peas.
- 8.1395 Dandelion root.
- 8.1396 Chicory.

## 8.130 ADULTERANTS FOR BUTTER AND CHEESE.

- 8.1301 Oleomargarine.
- 8.1302 Renovated butter.
- 8.1303 Saffron - colouring matter for butter.
- 8.1304 Spanish annatto, colouring matter for cheese and butter.
- 8.1305 Fulwood's annatto, colouring matter for cheese.

## 8.2 Clothing.

(Specimens presented by Messrs. Morgan & Son, Montreal.)

### 8.21 LINEN.

8.211 Specimen of linen.

8.212 Specimen of Deimel mesh linen.

(Presented by the Deimel Mesh Co., Montreal.)

8.213 Specimen of linen and cotton, mixed.

### 8.22 COTTON.

8.221 Specimen of cotton goods, plain and coloured.

8.222 Specimen of cotton material, got up to imitate flannel.

8.223 Specimen of cotton and wool, mixed.

### 8.23 WOOL.

8.231 Canadian woollen goods.

8.232 English woollen goods.

8.233 Irish woollen goods.

8.234 French woollen goods.

### 8.24 SILK.

8.241 Specimen of silk material, plain.

### 8.25 GENERAL.

Specimen of cloths causing irritation of skin.

8.27 Table showing CONDUCTIVITY of various articles of clothing, compared with water as a standard.

As will be seen from the preceding table, there is very little appreciable difference in the conductivity of the various fibres, used as clothing, with regard to heat.

There is no doubt in the average person's mind, that there is a difference, and very markedly so, as regards the various articles, wool, cotton, and silk, when used for keeping the body warm, and everyone will agree that woollen materials are the warmest.

It is accounted for by the fact that natural wool contains numerous little air spaces, and that the air contained therein, acts as a poor conductor of heat, hence the material keeps the body warm. On the other hand, cotton material, pure and simple, does not contain these minute air spaces, and so the cotton fibre is enabled to conduct heat rapidly from the body, and dissipate it into the surroundings; in this way cotton material feels cool.

The remarks made about cotton apply practically with equal force to linen material. Taking advantage of this knowledge, manufacturers have endeavoured to make a material of cotton or linen fibre, woven in such a fashion as to include numerous little air spaces, thereby imitating wool as nearly as they can as regards structure, and it has been found that these little air spaces act as non-conductors of heat, and so this (meshed) material feels ever so much warmer than plain cotton or linen.

Silk, by its fine texture, enclosing a fair amount of air, and also by the fact that it is rather an inferior conductor of heat, feels warmer than cotton or linen, but is less so than wool.

With reference to all the foregoing materials, one may note the fact that there is a certain amount

of free ventilation permissible through the interstices of the various materials.

At this point furs may be conveniently mentioned. There is no doubt about the warmth of furs, and it is due to the hair of the fur.

The hair fibre, by itself, is very like wool as regards its conductivity, but the mass of hair encloses a large quantity of air, and as we have already seen, this is a very good non-conductor, and so the furs feel warm. The leather portion of the fur makes a difference, in the fact that it prevents wind blowing through; at the same time it has the disadvantage of preventing ventilation.



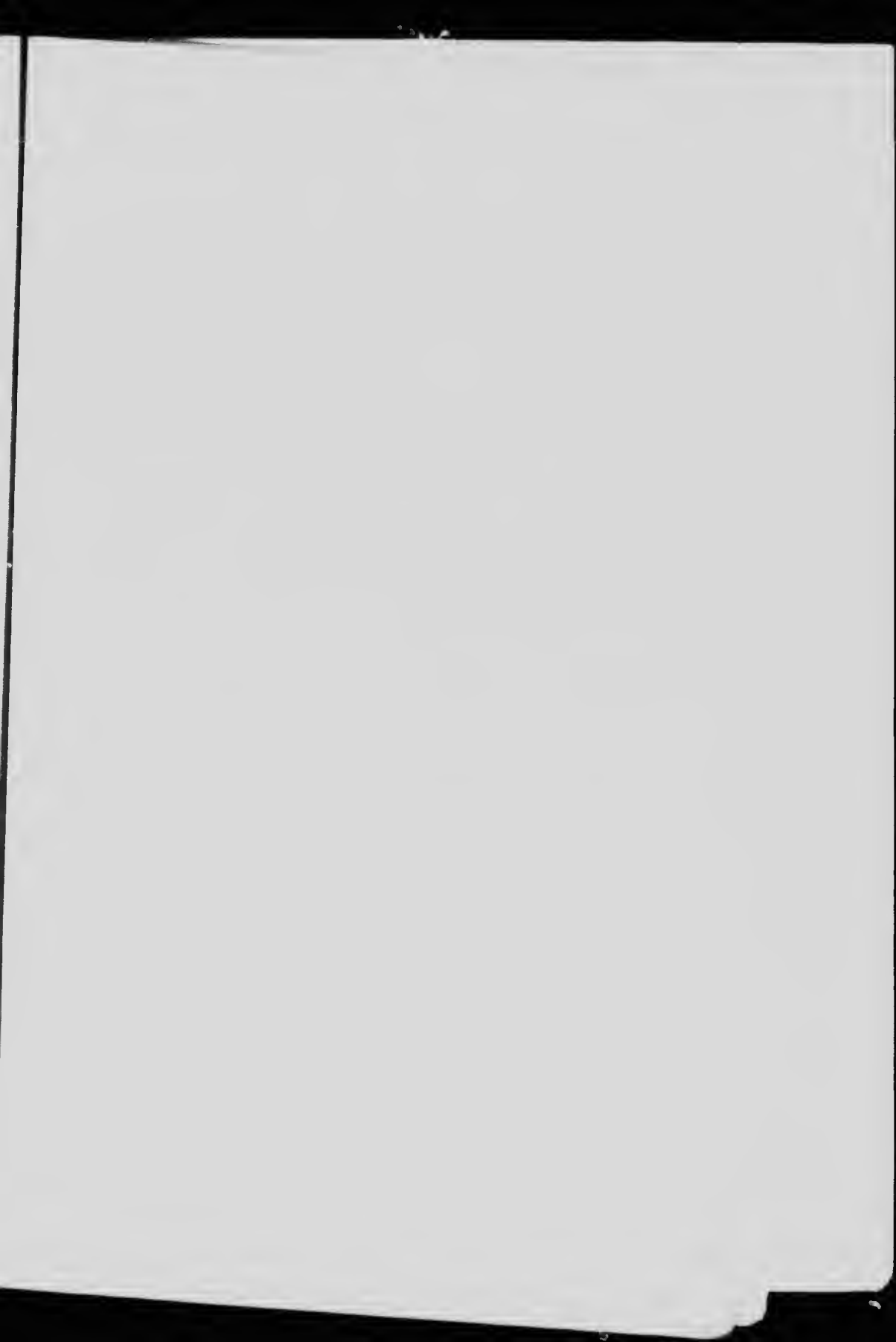



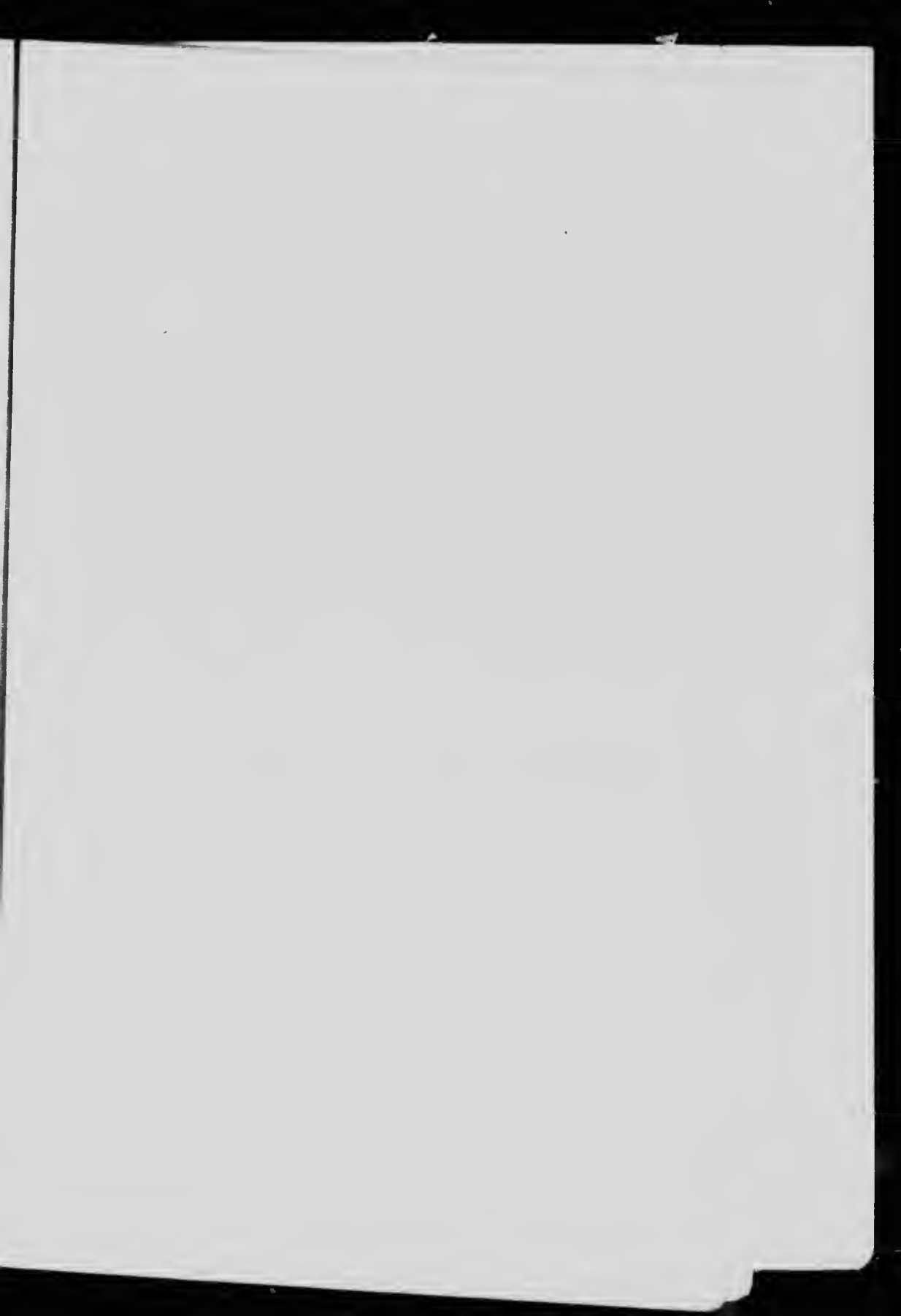



0.

0.2

0.

0.

0.

0.

0.

0.

0.8

0.8

0.8

0.8

## SECTION 0. -PATHOLOGICAL AND BACTERIOLOGICAL.

### 0.1 Tuberculosis.

- 0.11 Tuberculosis of the lung. -Bovine.
- 0.12 Tuberculosis of the pleurae, -Bovine.
- 0.13 Tuberculosis of the diaphragm, -Bovine.
- 0.14 Tuberculosis of the peritonium, -Bovine.
- 0.15 Tuberculosis of the lymphatic glands, -Bovine.

These tuberculous lesions illustrated by the foregoing specimens, are such as one finds during the inspection of meat at slaughter houses. The various exhibits are very typical of the conditions met with.

### 0.2 Intestinal Parasites.

- 0.21 Specimens of liver (sheep) showing liver fluke.
- 0.22 Specimen of liver (pig) showing cysts of *Tenia* *Echinococcus*.
- 0.23 Specimen of common round worm.
- 0.24 Specimen of Pin worm.
- 0.25 Specimen of Tape worm -*Tenia* *Mediocanellata*.
- 0.26 Specimen of muscle showing *Trichina* *Spiralis*.

### 0.8 Bacteria.

- 0.81 Series of tubes containing growths of various micro-organisms.
- 0.82 Series of slides showing appearances of most of the common micro-organisms.
- 0.83 Chart of colored drawings, executed from slides, exhibiting various micro-organisms, stained.

