

Technical and Bibliographic Notes / Notes techniques et bibliographiques

The Institute has attempted to obtain the best original copy available for filming. Features of this copy which may be bibliographically unique, which may alter any of the images in the reproduction, or which may significantly change the usual method of filming, are checked below.

L'Institut a microfilmé le meilleur exemplaire qu'il lui a été possible de se procurer. Les détails de cet exemplaire qui sont peut-être uniques du point de vue bibliographique, qui peuvent modifier une image reproduite, ou qui peuvent exiger une modification dans la méthode normale de filmage sont indiqués ci-dessous.

- Coloured covers/
Couverture de couleur
- Covers damaged/
Couverture endommagée
- Covers restored and/or laminated/
Couverture restaurée et/ou pelliculée
- Cover title missing/
Le titre de couverture manque
- Coloured maps/
Cartes géographiques en couleur
- Coloured ink (i.e. other than blue or black)/
Encre de couleur (i.e. autre que bleue ou noire)
- Coloured plates and/or illustrations/
Planches et/ou illustrations en couleur
- Bound with other material/
Relié avec d'autres documents
- Tight binding may cause shadows or distortion
along interior margin/
La reliure serrée peut causer de l'ombre ou de la
distorsion le long de la marge intérieure
- Blank leaves added during restoration may appear
within the text. Whenever possible, these have
been omitted from filming/
Il se peut que certaines pages blanches ajoutées
lors d'une restauration apparaissent dans le texte,
mais, lorsque cela était possible, ces pages n'ont
pas été filmées.

- Coloured pages/
Pages de couleur
- Pages damaged/
Pages endommagées
- Pages restored and/or laminated/
Pages restaurées et/ou pelliculées
- Pages discoloured, stained or foxed/
Pages décolorées, tachetées ou piquées
- Pages detached/
Pages détachées
- Showthrough/
Transparence
- Quality of print varies/
Qualité inégale de l'impression
- Continuous pagination/
Pagination continue
- Includes index(es)/
Comprend un (des) index

Title on header taken from: /
Le titre de l'en-tête provient:

- Title page of issue/
Page de titre de la livraison
- Caption of issue/
Titre de départ de la livraison
- Masthead/
Générique (périodiques) de la livraison

Additional comments: /
Commentaires supplémentaires:

This item is filmed at the reduction ratio checked below /
Ce document est filmé au taux de réduction indiqué ci-dessous.

10X	14X	18X	22X	26X	30X
<input type="checkbox"/>	<input type="checkbox"/>	<input type="checkbox"/>	<input checked="" type="checkbox"/>	<input type="checkbox"/>	<input type="checkbox"/>
12X	16X	20X	24X	28X	32X



THE
CANADIAN
BEE JOURNAL

"The Greatest Possible Good to the Greatest Possible Number."

VOL. IX, No. 5.

BEETON ONT., JUNE 1, 1893.

WHOLE No. 337.

The Porter Spring Bee Escape

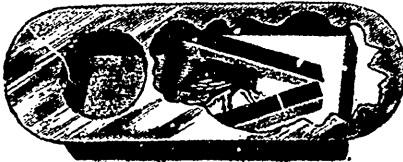

Was awarded THREE PRIZES at the Toronto Industrial Exposition in 1891. Wm. McEvoy, Foul Brood Inspector, Woodburn, Ont., says of them on Jan'y 29th, '92:—"I know from experience it won't pay any beekeeper to do without them, as they are one of the best things ever brought into any apiary, and should be used in every bee yard in the

whole wide world."

F. A. Gemmill, Stratford, Ont.:—"I have used many kinds of escapes for years past, but like yours best of all."

Prof. Cook:—"No bee-keeper can afford to be without them."

Send for testimonials and read what others say about them.

Prices:—Each, by mail, post paid, with full directions, 20c. Per dozen, \$2.25.

If not found satisfactory after trial return them, and we will refund your money.

R. & E. C. PORTER, LEWISTON, 116, U.S.

b 12t. Mention this Journal.

THE DOMINION BEEKEEPER'S
PRINTING ESTABLISHMENT
BEETON, ONT.

THE PUBLISHERS OF THE
CANADIAN BEE JOURNAL
ARE PREPARED TO
FURNISH EVERY DESCRIPTION OF PRINTING

REQUIRED BY BEEKEEPERS, SUCH AS
CATALOGUES, CARDS, CIRCULARS, LABELS, ETC.

NEW SUPPLY FIRM.

FRENCH, CHEFFEY & Co.

BEG TO ANNOUNCE TO THE

Beekeeping Public

That they have purchased the Factory and Plant of the D. A. Jones Co., and are now prepared to fill Orders for all kinds of Bee Supplies. Give us a trial order. Goods sold at low prices, and for cash only.

FRENCH, CHEFFEY & CO.,

BELTON, ONT.

DOVETAILED HIVES.

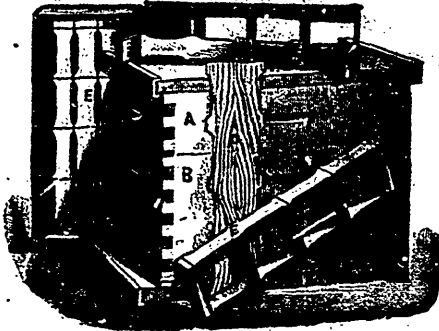

You want the best Bee Hive, best constructed (especially for comb honey), best manufactured. We have it. See what E. W. Evans, Kingsey, Que., writes:—

MARCH 27th, 1893.—I am greatly pleased with what you have sent me. I never saw better or smoother work. Everything was so securely packed that they reached me without any damage.

If you want bee hives you cannot afford to purchase before you have written to us. Circular and price list on application. Remember the firm.

GOULD, SHAPLEY & MUIR CO. (LTD

Brantford, Ont.

ADVERTISEMENTS.



THE PEOPLE'S

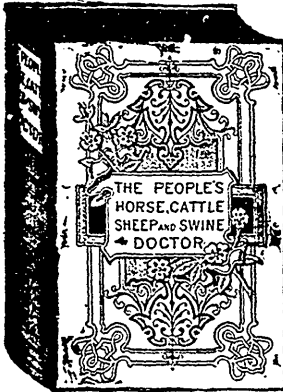

HORSE,

CATTLE,

SHEEP

and

SWINE

Containing in four parts clear and concise descriptions of the diseases of the respective animals, with the exact doses of medicine for each.

A book on *diseases of domestic animals*, which should present a description of each disease and name, the proper medicines for treatment in such condensed form as to be *within the means of everybody*, has long been recognized as a desideratum. This work covers the ground completely. The book embodies the *best practice* of the ablest Veterinarians in this country and Europe, and the information is arranged so as to be *easily accessible*—an important consideration. *Each disease* is first described, then follows the *symptoms* by which it may be recognized, and lastly is given the *proper remedies*. The different medicines employed in all diseases are described and the doses required are given. The book is copiously *illustrated*, including engravings showing the shapes of horses' teeth at different ages. An elaborate index is a valuable feature.

It is printed in clear, good type on fine paper, and is handsomely bound in cloth, with ink side stamp and gold back, and is a book which every person ought to possess, who has anything to do with the care of animals.

It will be sent to any address—postpaid—on receipt of the price, **One Dollar**, or on the remarkably liberal terms stated above.

DOCTOR.

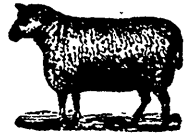

THE ABOVE BOOK MAY BE HAD FOR

ONLY 75 CENTS

BY ADDRESSING THE,

Canadian Poultry Journal,
Beeton, Ont.

ADVERTISEMENTS.

HONEY KNIVES.



I have on hand a quantity of Ebony Polished Handles, Mirror Blade Honey Knives, such as are usually sold for \$1 or \$1.25, extra quality, which will be mailed to any address, postage prepaid, on receipt of 75c.

SMOKERS.

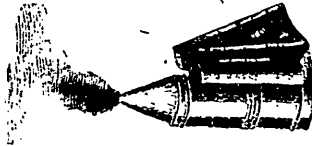

No. 2 plain, mailed to any address on receipt of 75c. Regular price, \$1.25.

HONEY EXTRACTORS.



Honey Extractors, made to hold Jones, Langstroth, Quinby or Combination Frames, crated and shipped to any address upon receipt of \$5.50. The regular price for these goods is \$7.50, but as I have a quantity on hand, I must clear them out, and will sell at above price.

Lithographed Honey Labels and all other bee supplies at proportionately low prices. All of which goods are in A.1 condition

G. T. SOMERS, Beeton, Ont.

THE CANADIAN BEE JOURNAL.

"The Greatest Possible Good to the Greatest Possible Number."

VOL. IX, No. 5.

BEETON, ONT., JUNE 1, 1893.

WHOLE No. 338.

: : : THE : : :

Canadian Bee Journal,

ISSUED 1ST AND 15TH OF EACH MONTH

G. T. SOMERS - MANAGER.

DEVOTED EXCLUSIVELY TO THE INTERESTS OF
THE HONEY PRODUCER

ONE DOLLAR PER ANNUM IN ADVANCE.

Advertising Rates.

Time.	1 Inch.	2 In.	4 In.	1 Col.	Page.
1 month ...	\$ 2 00	\$ 3 00	\$ 4 50	\$ 6 50	\$ 10 00
2 months...	3 00	4 50	6 50	11 00	17 00
3 months...	4 00	5 50	9 00	15 00	25 00
6 months...	6 00	9 00	15 00	25 00	40 00
12 months...	10 00	15 00	25 00	40 00	75 00

MR. H. L. JONES, of Goodna, Queensland, is our agent for Australia and adjacent British colonies and will receive subscriptions at the rate of five shillings per annum postpaid.

THE CANADIAN BEE JOURNAL.

BEETON, ONTARIO, JUNE 1, 1893.

BEE-STINGS vs. RHEUMATISM.

At the expense of worrying our good friend, Dr. Mason, the littlest bit in the world, we recommend to his attention the following communication which we have just received from that practical and experienced authority on bees and their belongings and doings, Mr. R. F. Holtermann, on the subject of bee-stings as a cure for rheumatism. We wish

to premise Mr. Holtermann's note with the assertion that whether bee-stings cure rheumatism or whether they do not the circumstance or incident—or whatever else he may please to style it—has not the smallest particle of interest in it for ourselves personally. We are happy to say that we have never been afflicted with rheumatism, lumbago, sciatica, neuralgia, or any other of its kindred and tormenting allies, and the consequence is that a bee sting would be of no value to us, whilst more than one might be decidedly objectionable. Dr. Mason will therefore observe that we are entirely disinterested in our recommendation of the addition of this valuable remedy to his pharmacopœia. As a rule, we object, as he does, to anything that savors of empiricism, or that may be regarded as coming within the category of questionable therapeutics, and although we have upon a previous occasion employed an expression which might painfully impress the excellent doctor with the idea that our views in regard to medical practice savored somewhat of latitudinarianism and left us open to the insinuation that we had a leaning in the direction of homœopathic treatment, we beg to assure him that he is quite mistaken on that point, and that we are too conservative in our

views to be led astray by every strange doctrine that has not the venerable odor of antiquity and precedence for its support. "With these few remarks,"—if we may be permitted to quote the language frequently employed by usually longwinded and thickheaded public speakers,—we beg to recommend the following short note to the learned doctor's distinguished consideration:

BEE-STINGS AND RHEUMATISM.

Dr. Mason wants to know of some case where bee-stings cured rheumatism. I can give him one. Mrs. Luditt, Hensal, Ont., had to use a crutch, she suffered so much from rheumatism. One day she was alone in the house when the bees swarmed, and she had to go out to them on her crutches. The bees stung her, the effect was instantaneous, she dropped her crutches and reached the house without them, returning in quicker time than she reached the yard. "The proof of the pudding," etc.

Yours, etc.,

R. F. HOLTERMANN.

But we have still further evidence—evidence from practical and reputable men in regard to the value of our theory—to submit to the worthy doctor's consideration. We do not, as he appears to imagine, select these evidences and publish them in order to irritate or disturb anybody. In that respect we have none of the characteristics of the bee about us. We merely publish them for what they are worth. It does not matter what our views may be in regard to them; what we want is to get all the views of other people based upon positive practical experience. And so, in addition to the above letter from Mr. Holtermann, we append the following one from Mr. L. J. Templin, of Canon City, Col., which we take from *Gleanings of the 15th ult.* :—

STINGS AND RHEUMATISM.

There seems to be a growing conviction that bee-stings are good for rheumatism. My experience seems to point in that direction. For a great many years I had been subject to muscular rheumatism in my back and shoulders; and at times it would get into my arms till I felt as if I had the tooth-

ache all through the muscles of those limbs. Two years ago I purchased a dozen colonies of bees. They were in different styles of hives, some with movable frames and some without. I was told that they had not been opened for three years. At first they were inclined to resent the presence of a person in the apiary as an unwarranted intrusion. In transferring and manipulating them, of course, I received plenty of stings. In a short time I noticed that my rheumatism was gone, and so far it has not returned.

L. J. TEMPLIN.

Canon City, Col.

Mr. Corneil had an excellent article in the December number of the *Canadian Horticulturist* which we marked at the time for transfer to our pages. The large number of contributions on hand at the time and since then of immediate interest prevented us from giving place to it. As the article will be seasonable at any time, we shall make room for it in our next.

o o o

We publish on page 75 the first part of a very interesting article contributed to the *BRITISH BEE JOURNAL* entitled "Notes on Bees and Bee-keeping in the Tropics and at the Antipodes." We hope to be able to give the conclusion of it in our next issue.

o o o

Our friend Mr. W. J. Brown, of Chard, has had a peck of troubles on his hands; at least we should judge so from a communication just received from him. His bees had commenced robbing, and the only thing he could compare them with were the famed Kilkenny cats, which left nothing to mark the cataclysm but their tails. We are glad to know that he has at length become master of the situation, that is as regards the bees, if not as regards the pump.

o o o

And yet if Mr. Brown had only had his wits about him—and just a *little more* patience—he could have applied one to the other with marked success. We never saw a more con-

venient mode of subduing a troublesome mob—whether of bees or men—than the use of a good stream of water. Let him get the pump in good working order at once, and the next time his bees kick up a fuss, he will find that the turning upon them of a good stream of water, either by means of an ordinary force pump or garden hose, will quickly bring them to their senses, and give them something else to worry about except robbing their neighbors. "Keep it as a souvenir," indeed. He can give it that character in the fervid imagination of the bees without much trouble.

o o o

We have the report elsewhere, of Mr. Kitchin, Secretary of the Lambton Beekeepers' Association, and regret to observe that the meeting at Sarnia was not as interesting or enthusiastic as usual. We are not at all surprised at it, however, in view of the fact that just about the time of the meeting the weather we were experiencing was quite as unseasonable, as gloomy and uncomfortable generally, as we have ever yet experienced. The probability is, too, that a good deal of anxiety was being felt by beekeepers generally—and especially by those having extensive apiaries and large numbers of colonies on hand—as to what the outcome might be.

o o o

We should like to get a correct account of the importation of honey into the United Kingdom from all parts. We observe by reference to the JOURNAL that Canada's export in 1887 was the smallest of any but one, that of Australia, which was only three hundred and thirty cwts., ours being four hundred and twenty-six cwts.; at the same time the export from the United States to the United Kingdom was four thousand and a half cwts., over ten times as much as ours. This is not what it

ought to be; and we should strive to make a better showing than that. Our brethren across the line have all they can do to hold their own with us, ratably, in other respects. Let us show them that we can give them something to do in this line as well.

o o o

We trust our readers will continue to send us their experiences of the season that has closed, and as to how matters stand with them just now, what the prospects are, and what the bees are doing. Come, gentlemen, send along your manuscripts. Only write them out plainly and legibly, and we'll attend to getting them in good shape for you. You will all benefit by these communications; and the probability is that what you are endeavoring to find out is the very thing your neighbor is anxious to tell you.

ORIGINAL CORRESPONDENCE.

FOR THE CANADIAN BEE JOURNAL.

LAMBTON BEEKEEPERS.

The Lambton beekeepers met in the town of Sarnia on May 19th. Although the attendance was better than usual, there appeared to be a great lack of interest and enthusiasm on the part of the meeting. What the cause of it was would be difficult to say.

The early part of the meeting was occupied by routine business, and the after part in the discussion of questions in connection with the beekeeping industry. Mr. W. Mowbray of Sarnia read a paper on "Wintering Bees, and some of the Troubles connected therewith."

The Association had the pleasure of receiving such experienced and well known beekeepers as W. G. Hutchinson of the Review, and F. A. Gemmill, President of the Ontario Beekeepers' Association.

The next meeting will be held in the town of Brigden on the 25th. Oct. next.

J. R. KITCHIN, Secretary.

For THE CANADIAN BEE JOURNAL.

BRANT BEEKEEPERS' ASSOCIATION.

The meeting of the Brant Beekeepers' Association was held at the Court House, Brantford, April 15, 1893. The attendance was good, the meeting having been well advertised, and owing to the fact that Mr. F. A. Gemmell (president of the Ontario Beekeepers' Association) was expected to be at the convention.

After a good deal of business was dispatched, the President, R. F. Holtermann, called upon Mr. Gemmell for an address upon the important subject of Building up Colonies for the Honey Flow. In his introductory remarks, the President stated that much valuable information might be expected from Mr. Gemmell, he being not only an extensive practical beekeeper, but a great reader as well of apicultural literature.

Mr. Gemmell stated that plenty of stores were necessary of the best liquid capped honey. Very little tinkering should be done until the pollen came in. Natural pollen was the best; otherwise, he fed artificial, as he thought it kept the bees at home. He inverted several covers to hives, feeding rye or graham flour. He did not know whether the bees used all they stored or not, but he never saw any clogging of stores from pollen. Feeding through a feeder he did not advocate, as solid sealed combs were the best. If a strong colony was short of stores it was a good plan to use a feeder daily,—an ordinary gin jar with a perforated tin cover would answer. The jar should be covered about with chaff or straw. Cut a hole in the quill, and put a wooden frame covered with wire cloth over the whole; this would prevent the bees from getting through the hole whilst they were able at the same time to get at the syrup through the wire cloth. He fed them with sugar syrup, composed of equal quantities of sugar and water mingled with a little honey. It should be remembered, however, that although honey is a far better food than anything else for stimulative

purposes, it leads to robbing. Mr. Gemmell stated that he preferred sealed combs between fruit and clover blooms some advocated feeding; but when this practice was resorted to the bees were very liable to swarm, and that just when they should begin to store supplies. This is particularly the case in regard to comb honey.

Question by Mr. C. Edmanson:—Do you ever spread brood?

Mr. Gemmell:—I never spread brood unless I am sure there is no danger of chilling, say after 1st June. If not done properly it is a very dangerous operation, which most beekeepers have failed to make a success of. I sometimes turn in the outer side of the outside brood combs; this spreads the chamber but a very little at a time.

Question by Mr. John Charlton:—How much do you give them in the fall?

Mr. Gemmell:—I believe in giving them plenty,—even forty pounds. They will make good use of what is left over winter in the spring, and then spring feeding will not be necessary. I do not believe in building up weak colonies at the expense of the strong. If anything is done in this direction, it should be by taking combs from other weak colonies, giving out of these weak colonies some strong others very weak.

Question by Mr. James Shaver:—What do you do with second swarms?

Mr. Gemmell:—I seldom, if ever, have them.

Mr. F. J. Davis, Cainsville, thought Mr. Gemmell had done very well. They kept swarming down without great difficulty. They took many brood combs from the colonies in the fall giving them sealed combs of honey. They wintered them on their summer stands and left the outside packing on the hives until the bees hung out; they then unpacked them, gave them more room, and cut out the queen cells. He thought when a colony was weak the queen was deficient. He then kills the queen and puts the first swarm on the combs. The colony would then be ready for the basswood flow.

The president said he could most heartily endorse every statement made by Mr. Gemmell with the exception of one. Mr. G. appeared to think that a colony might become very strong too early. There were several writers who advocated this, but he (Mr. Holtermann) could not get a colony too strong. If the body of a hive would not hold the bees comfortably one or more supers would.

Mr. GEMMELL admitted that it was not very often that a colony got strong too early. It might be the case sometimes.

Mr. HOLTERMANN then said he would advise beginners who wanted to increase their number of colonies to work in the following way:—They should prevent swarming as much as possible; get all the honey they could and sell it, putting aside the proceeds from honey which they could not otherwise get when increasing, adding to it also the money which would have been necessary to purchase hives and foundation, and buy bees in the spring: they would find that the better method of working.

In reply to a question Mr. Gemmell said that in running for comb honey he hived the bees on starters at the end of the

season. The colony would of course be likely to have but little honey in the brood chamber, and the combs would be in poor shape; but he thought the superiority of the comb honey secured would more than make up for that. For extracted honey he hived on full sheets or combs. In the sections he used full sheets of foundation, and put a small piece or strip of foundation standing up along the bottom piece of the sections; this prevented pop holes in the sections.

The discussion drifted into leveling hives, and the importance of having them level to secure combs built straight. Several related their experiences in this matter with considerable profit to those present.

Mr. C. EDMONSON, Brantford, the delegate to the annual meeting of the Ontario Beekeepers' Association, then gave his report of the meeting at Walkerton. The report was very carefully prepared, and showed that Mr. Edmonson was very conscientious in fulfilling the duties of a delegate. As the Ontario Beekeepers' Association meeting has been very fully reported in the columns of the C.B.J., it is unnecessary to give his report in these pages.

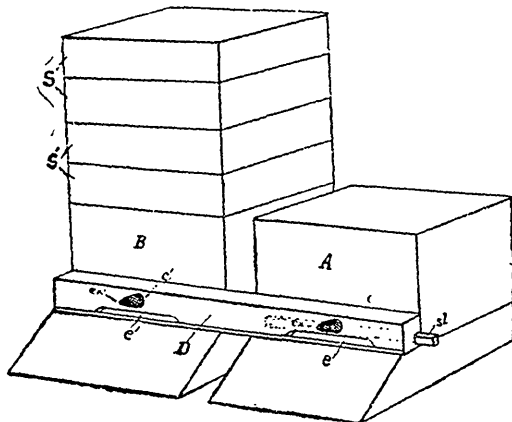

Bee Hives with Langden non-swarmers attached: A, B, hives; S, S', supers; D, non-swarming device; e, e', entrances corresponding to hive entrances; sl, slide for closing entrance; c, c', conical wire cloth bee escapes; ex, exits of same.

The vice-President, J. R. HOWELL, then took the chair and Mr. R. F. Holtermann gave a report of the North American Beekeepers' convention held at Washington, D.C., which he attended. He spoke upon Dr. Wiley's remarks upon the adulteration of honey, and then showed the Pratt Self-Hiver which had first come under his notice at Washington, where E. R. Root had shown it. He said that he had no faith in self hivers last year, and never recommended the Alley to anyone. But the principle in this one was correct. The bees were in hive No. 1, the self-hiver was placed upon a new hive (hive 2), and the entrance to it (G) either covered with perforated metal or closed entirely. When hive 1 rests flat on the self-hiver and hive 2, the entrance is at E. The bees pass through a hole in the solid board which separates No. 1 and 2 hives, and through the perforated metal (B); again they pass through metal D, and out at E. As the swarm issues they pass out in the usual way just described. The queen attempts to follow and can only pass out at C, when she is in the new hive and the metal D prevents her from following the swarm in the air. The queen, unless she returns to point C, must remain in the new hive, when the bees, missing their queen, will return to their old and accustomed entrance, and on their way to the old hive will find the queen in the new hive, and will remain there. Hive 1, which is supposed to have supers for comb (H) extracted honey, is, when convenient, placed on a new stand and its super placed on hive 1, the self-hiver being removed.

Upon the president resuming the chair, a very cordial and unanimous vote of thanks was tendered Mr. Gemmel for his able and instructive address, to which that gentleman replied in fitting terms. Thirty-five to forty attended the meeting, amongst whom were, Eva Adams, John and Wallace Charlton, Wm. Munshall, G. E. Robinson, D. Westbrook, Mrs. F. J. Davis, the Misses Davis, Miss A. Falton, Edgerton Shaver, Geo. Morris, T. H. Morris, Sam. Cleaver, and those already mentioned.

FOR THE CANADIAN BEE JOURNAL.
BEEKEEPERS' REPORTS.

Mr. W. J. Brown, of Chard, Ont., under date May 25, 1893, reports as follows:—
“On October 11th and 12th, 1892, I put my bees in the cellar, eighty eight stocks. The temperature of the cellar throughout the winter, and up to date of removal to their summer stands, stood at from 48° to 55°. With the exception of a few stocks which were set out a few days previously, my bees were cellared until the 8th May.— five months, less two days.

“Now for the result, as compared with outdoor wintering I found two dead out of the eighty-eight. One of these two were destroyed by mice, the other was an old hive which may have been queenless when put into winter quarters. During the cold backward spring three more stocks have succumbed.

“A neighbor who put twenty-three stocks in clamps succeeded in bringing fifteen of them through alive. Another who put thirteen stocks in clamps has but one alive now. Of course they do not read the BEE JOURNALS nor attend our Beekeepers' Conventions. Another man who does read the JOURNALS and endeavors to keep abreast of the times put ninety-eight stocks into winter quarters, part of them in the cellar and part in garret. His loss was only five stocks. If this unfavorable weather lasts much longer, it is difficult to say where we may be landed when the season comes round to put them in winter quarters again.

“Plum and dandelion are in full bloom; but in consequence of the severity of the weather, the bees are unable to visit them.”

Dr. Miller says that this has been the worst spring (for bees, we presume) that he has experienced in thirty years.

Dr. Hicks reports in A.B.J. that the crop of cucumbers has been increased by fifty per cent., in consequence of the proximity of apiaries.

Brother Miller says the Fair is not half finished yet, and won't be before the middle of the month, that is as regards setting the exhibits in position.

FOR THE CANADIAN BEE JOURNAL.

QUESTION DRAWER.

DEAR SIR,—In answer to your query regarding the bleaching of wax, I may say I have never tried to bleach it myself, but I find the following process in the *Encyclopædia Britannica*:

“To bleach wax, it is formed into shreds and strips, so as to expose the greatest possible surface. So prepared, it is spread out, and frequently watered and turned in the direct sunlight—a slow but effective process. To hasten the bleaching action, the wax may be mixed with about one sixth of pure spirits of turpentine, and this preparation, on exposure, by its copious production of ozone, effects in four or five days a bleaching which otherwise would occupy three or four weeks. When the bleaching is complete, all trace of turpentine oil will have disappeared.”

Yours, etc., S. CORNELL.

Lindsay, 16th May, 1893.

THE CANADIAN BEE JOURNAL.

AFTER DINNER THOUGHTS.

MR. EDITOR,—The usual time for thought on this subject brings to my remembrance my promise to try to help Mr. Darling in analyzing some of the trials which the novice encounters while learning to keep bees. Friend D. is right when he says that a beekeeper's real trouble begins when he has to depend on books and periodicals. In order to succeed in any worthy undertaking a man must be real, for a man made of paper and ink is tossed about with every wind that blows. Of course, Mr. D., if a novice tried, as you say, to follow Mr. Doolittle's plan of natural swarming, he would have all swarms and no honey; for as usual, he would take the term “natural swarming” to mean—let them swarm all they can, or as they will; while Mr. D. certainly must have meant—let them swarm naturally, but not to excess. You say why is it that the instruction given so often proves partially if not wholly useless to the novice. I think the majority of their failures is because we, older ones, don't talk plainly enough. We

stay on top of the fence and talk down to people; a misunderstanding of terms used is the result, and the novice is not so much to be blamed as we. I will pass by the caging of queens, to get large crops of honey, for I don't do such foolish things. I aim to simplify beekeeping, and reduce the cost of producing honey. You say, why is it that some of those very prolific queens sometimes prove to be the poorest stock a man has in his yard. Surely I never saw a poor stock which had a very prolific queen, but I have had such stocks swarm very early when I was off my guard, and go to the woods, and the stock remain so thrifty that it took keen eyes to detect that it had cast a swarm without opening the hive. Again, I agree that you can't induce a few bees to go into the tiering up business, but you can produce them to do it. Produce a half bushel of bees, and see how quick I will send them into their cases. I would shade and ventilate them just enough to keep down excessive heat, which is one great cause of swarming. Give them a case of sections about a week before the general honey flow commences, placing in the centre a few sections of empty comb, even if I had to cut the comb from an outside frame in the brood chamber and fit it in the sections, for such combs though dark can be extracted. After a few of the strongest have made a good start in cases, distribute their partly filled sections among the next strongest which will help them to start also. I would do this before they got the swarming fever. Perhaps one colony in fifteen or twenty will act as though they didn't care whether school kept or not, and prefer idleness. First, see if such colonies have a queen; if they have, then borrow enough unfinished sections from two or three strong colonies to make a full case, and give it to them, which will shame them into activity. Now that half bushel colony will swarm soon. When it does, just wait until the last is in the air, then remove it to a new stand before many bees from the field return to it, placing a hive for the new swarm in its place. Now go and fetch the swarm which by this time has alighted and

hive it; then place a case of empty sections on it, and fetch its old case, bees and all, and put on top of that. Keep on tiering up as they need it. Don't go too fast and get a lot of unsealed sections on your hands, nor don't let your bees be idle for want of room. Don't irritate and discourage your bees by removing single sections when sealed; wait until a whole case is sealed, then remove it. You say, it may be that the object for which we are working makes a difference, and the advice that would be suitable at one time would not do for another, and you wonder, that being the case, *why it is that the different results are not stated.* Friend D., I have underlined this last question, and would repeat it with trumpet sound, expecting, however, only to hear echo answer *why?* The reason may be that—"a little wisdom intoxicates the brain, but drinking deeper sobers it again." While thus intoxicated, some writers jump at conclusions no matter how ruinous they may prove to others, and in a blind and indefinite manner jump from branch to branch in a way that would keep a city sportsman busy trying to keep his eyes on them, much more to understand their chatter, and then imagine they have done much for the novice. Oh! that men would try to describe matters as plainly as when they were children, and that they would be as kind and—as honest.

Long live the giant C.B.J.—

Long may its pages bright
Not fear the right to do or say,
And stand forth in its might.

The C.B.J. was born to last;
Its creaking timbers stood
Against the storm clouds and the blast,
And scattered seeds of good.

JOHN F. GATES.

Ovid, Erie Co., Pa.

Brother York of the A.B.J. is a happy man. He says, "From our office we can go to the Fair all day and it need not cost us over 60 cents,—10c. for car-fare and 50c. for admission fees." This, he says, does not of course include refreshments, which can be had within the gates at a slight advance over rates outside. He recommends visitors to take their lunches with them, and then—they can spend as much more as they like.

FOR THE CANADIAN BEE JOURNAL.

HONEY EXHIBITS.

I notice the article of W. H. Kirby on Exhibitions. I would quite agree with Mr. Kirby in a statement that there are better methods of popularizing honey than to make an exhibit but only to the extent that we adopt a method in which we bring honey under the notice of the public, and in that way incline their thoughts in the direction of using honey. Honey exhibits are open to any one, and the more go the better. I have always looked upon it in this light. Those not exhibiting are receiving a certain amount of benefit from those exhibiting, and the former gets rather the better for the bargain. The way I look at the Chicago exhibit is perhaps wrong one, but I will give it briefly: First, we expect to benefit as Canadians or Ontario people in showing that our country can produce so fine an article of honey; that we have the flora, the climate, the bees and the enterprising beekeepers. All this will tend to give a good impression, and bring a desirable class of men and means to aid in the development of our country. Next, I would by no means feel sure that the British, French and German markets may not be of use to us. As far as the United States market is concerned, I look for no returns.

The remark on page 19: "The Columbian Exhibition is not going to be of much benefit to the Canadian apiarist, with the exception perhaps of the one who is going to superintend the exhibit; and the few exhibitors who will have their honey carried there free of charge," etc. Again, on the same page remarks in a similar strain re the deputation at the Colonial Exhibition.

I do not think these remarks are well directed. Of course it is an honor to be so selected; but in the first case the pay is not much; in the latter nothing at all, and only the desire to serve one's country and the belief that one could so serve would make up for leaving one's business for so long, reside in a strange city under all the strange and exciting conditions which place one's life if not in danger, at least causes

great discomfort. There is no play about attending an exhibit for two or three weeks, but when it becomes months, such a life must become well nigh unbearable.

R. F. HOLTERMANN.

Brantford, Ont.

P.S.—The benefits derived from making honey exhibits may be enhanced very much by the exhibitor.

R.F.H.

FOR THE CANADIAN BEE JOURNAL.
EXHIBITIONS.

MR. EDITOR.—I think Mr. Kirby is laboring under a very wrong impression with regard to the Industrial. He says he very much questions the utility of the Industrial to the specialist. Perhaps he is not aware that nearly all exhibitors there are specialists. He also objects to the association grant, because there are only a few exhibitors there, and they take all the prizes. Did it never occur to Mr. Kirby that he might exhibit his honey there, and be one of the prize takers, and not only take prizes, but realize the one and a half to two cents per pound extra which exhibitors are supposed to get.

I think the Industrial has been one of the best means in the Dominion for creating a market for honey. I remember the time when scarcely a grocer in Toronto kept honey for sale, but now you will find few grocers without it, and why is the change? Simply because of such exhibits as have been shown at the Industrial. Many who would purchase a small quantity there would next ask their grocers for it and so create a market for Mr. Kirby and others.

Six years ago I made my first exhibit of honey in Toronto—a very small one. I knew no one there except Mr. D. A. Jones, who had tons of honey on exhibition. There were about eighteen exhibitors that year. The next year I enlarged on it, and did fairly well both in sales and prizes, and so have done every year since; but I have never sold a pound of honey to a dealer. As it does not cost anything to return exhibits by rail, I always send back any

thing that is not sold. I find that the exhibit pays as an advertisement not only in Toronto but at home where it is talked of; and now I can scarcely supply the home market in this small town. For every five pounds I sold when I began bee-keeping one hundred pounds are now sold.

Mr. Kirby may be under the impression that the prizes are too large; but if he will consider that, owing to keen competition and the fact that the honey has to be of the finest quality, carefully handled, and a large proportion of which must be put up in fancy glasses, and that three weeks of time is usually taken up, the prizes do not more than cover expenses.

This is the latest spring I have known for pollen. I set out forty colonies on April 24th, and forty-three on May 2nd, but no pollen came in till May 7th. They appear to have wintered fairly; but I will know more about that when the weather gets fine enough to examine them.

R. H. SMITH.

Bracebridge, May 6th, 1893.

FOR THE CANADIAN BEE JOURNAL.

HONEY PROGNOSTICATIONS.

DEAR SIR.—I observe that Mr. THOS. JOHNSTON in his article in the CANADIAN BEE JOURNAL of the 15th ult., tries to make me ridiculous. That's all right; let him try it to his heart's content. If, however, he can lay aside his prejudice and preconceived ideas in regard to the secretion of nectar, I can convince him that I can foretell any failure or success as regards the honey flow. I can predict so far as regards my own location without a particle of doubt, and so can any other person with regard to his particular location when he knows the true cause of the failure.

Mr. Johnston says if I hit it as well as I did last year, he counts on getting a hundred pounds. If he gets a hundred pounds of white clover and linden honey per colony he will surprise me. I am glad that he is giving you, Canadians;

instructions in the art of producing comb honey, as you are sadly in need of the information. He tells you "we have a prophet down in Tennessee who advises us six months in advance just what quantities of honey we may expect." Yes, that is what I have done and can do, let me be prophetic or anti-prophetic. I will keep you Canadians posted in regard to the amount of honey you may expect to gather, and I hope Mr. Johnston will keep you posted on the art of producing it.

The poplars are just beginning to bloom here, and if the weather permits our bees to get out and work, they will roll in plenty of honey. It lasts about three weeks, but produces great quantities of honey. If it bloomed in June, July or August, and was as productive as it is now, the bees would store enormous quantities from it. As a general thing, however, it rains whilst it is in bloom fully one-half the time; still I have known seventy-five pounds of honey to be taken two years in succession.

It has been raining for the last two or three days, but has now cleared off, leaving some snow on the mountains; our bees have worked well to-day all the same.

SAM. WILSON.

Cosby, Tenn., U.S., May, 1893.

FOR THE CANADIAN BEE JOURNAL.

PREPARING BEES FOR WINTER, AND SOME OF THE DIFFICULTIES IN WINTERING.

FALL PREPARATION.

1. Must have a good queen,—this requires inspection. Without a queen the colony will be dead before spring.
2. Must have plenty of honey, say thirty pounds, and that must be of good quality. No honey dew, or glucose, or thin, watery honey will do for winter. Bad honey causes dysentery.
3. Must have a fair supply of bees. A small colony cannot keep up a sufficient heat, and before spring a small colony will be dead.
4. To winter well they must not have any

spare room above, such as a case of sections; if they have, they are apt to scatter and cannot keep up sufficient heat.

5. In packing, a coarse porous cloth, a piece of a grain bag, or something similar, should be laid over the frames, and a chaff cushion six inches thick on top of the cloth. This will enable us to remove the cushion without disturbing the bees, and a dry one can be put on if there is any dampness. I have found oat chaff very good, but timothy chaff is better, generally keeping dry all winter. Do not use sawdust, as it is apt to get very wet.

Put up in this shape, bees will generally come through winter on their summer stands without any other packing, being watchful not to let the doorway get frozen solid, as that would smother them.

I am not sure if they would be any safer if hives were put close together and packed with twelve inches of straw. As this does not keep out the frost they are liable either way to be ruined if a long spell of hard weather occurs. Another difficulty that occurs in both cases is that of mice getting in and cutting away a large amount of comb, spoiling three or four frames, making a nest, and leaving a very filthy mess to be cleaned out in the spring. To prevent this, have the hives well made and tight, and make the doorway so narrow that no mouse can get through.

Those having cellars under their houses would find it safer to place their bees in them before very severe weather comes on; but the cellar must be dry, and the temperature at about 45° F. In this case they will be safe in severe winters like the last one; but in mild winters they would lose the chance of having a fly out on any warm day that might come. This is the worst disadvantage of cellar wintering.

In placing them in a cellar they should be raised at least one foot from the floor and kept the same distance from the walls; the room must be kept perfectly dark, no noise be allowed to disturb them, and the air kept sweet. If the weather gets warm, then trouble commences; the temperature must be kept below 50°,—this may be done

by opening doors or windows at night, or, as a last resort, by bringing in some snow. If the room gets too cold it will be equally fatal. After having done all this we may still fail and not be able to give a reason for it; and it would be a wise precaution to winter some more than is required, so as to have a requisite number in the spring. About the first spring work is cleaning of the bottom boards; this requires two persons—one to lift the hives and the other to put in a clean board. By having a number of spare bottom boards this can be done very rapidly; and the combs and hives of any that are dead should be thoroughly cleaned and made ready for a swarm. Those that are light should be helped, as they may die before apples blossom, and it would be folly to lose them now.

W. MOWBRAY.

Sarnia.

FOR THE CANADIAN BEE JOURNAL.

NEW BEEKEEPING PATENTS.

The following is a list of patents issued to date, from the United States Patent Office, Washington, D.C. :—

Bee-Swarmer. Edward A. Floyd, Paola, Kans. Fyled Dec. 21, 1892. (No model.)

Claim.—1. In a bee swarmer the combination of two hives, a covered unobstructed swarmer for connecting them through which bees may pass from either hive to the other, the swarmer being provided with openings for the passage of the workers, and an alighting ledge beneath the said openings, substantially as shown and described.

2. An improved swarmer comprising a floor, the edges of which constitute alighting ledges, a covering narrower than the floor and which is secured thereto to form a longitudinal passage, the said covering being formed with longitudinal openings at its lower edges for the passage of the workers, substantially as shown and described.

3. In a bee swarmer, the combination of two hives having exits, alighting ledges projecting beneath the latter, a swarmer adapted to rest on said ledges and connect

the hives, the said swarmer consisting of a floor having projecting ledges which constitute alighting ledges, a longitudinal covering which is secured to but narrower than the floor and which is formed with openings for the passage of the workers substantially as shown and described.

NOTES ON BEES AND BEEKEEPING IN THE TROPICS AND AT THE ANTIPODES.

(From the *British Bee Journal*.)

Before leaving England for Penang (Malay Peninsula) in November, 1890, I had had some small experience in the keeping and manipulation of bees. It was with something like a wrench that I left England, for I was under the false impression that bees could not be cultivated in the tropics, and I felt that I should have to forego one of the greatest pleasures in life, which I believe intelligent and loving beekeeping is.

My surprise was great when I found that a schoolmaster friend of mine in Penang kept a hive of native bees which had been given to him by a professor in the Penang Roman Catholic Seminary. They were small bees, marked like our English bee, but lighter in color, exceedingly fiery, given to swarming, but failing in the great thing needful, viz., honey making. Of course they collected honey, but seemingly only in sufficient quantities to supply their own immediate necessities. My friend, the schoolmaster, took me to the Seminary, where the students kept from about fifty to one hundred hives of these tiny honey bees. I should say that keeping such bees (except for pleasure) was very unprofitable. I also discovered that another bee lived in the neighborhood—a little black fellow. I had a creeper growing in the verandah of my house—the Honolulu creeper I believe it was called—which attracted these little workers in thousands. I found two nests of them in the woods. One I took, but the honey was frightfully strong, and though very sweet, decidedly unpleasant.

During all the time I was in the Straits I never once saw the famous *Apis dorsata*. I rambled about the jungles, noticing everything, but I never came across this noted race of bees. I often wondered, while living in the Straits, if beekeeping on scientific lines could be successfully carried out there. I wrote to Mr. Blow for his advice, who thought that the thing was possible. But, then, how was I to get the right sort of bees? Could I depend on getting bees safely shipped all the way from England? I

believe that had I remained in the Straits I should by now have accomplished the introduction of the *Apis Ligurica*; but, unfortunately, after residing there for fifteen months, I left the place, and took up my residence in Western Australia, the tropical part of it.

Since leaving Penang I have by inquiry and study been convinced that Penang (and the Malay Peninsula) is a splendid field for the tropical beekeeper. A temperature never exceeding ninety in the shade, and a large and varied flora, are in favor of bees prospering there if properly managed. The place in Australia, to which I departed from Penang, was within the tropics, the line of latitude (20°) being just above it. The name of the township is Roebourne. I found there were no bees there. There were none in the colony further north than Geraldton. I found that this part of Western Australia possessed a dry but frightfully hot climate. For eight months of the year we had simply to live and endure as well as we could. It was no uncommon thing for the thermometer in the shade to range from 120 to 130 degrees. We had to calmly put up with hot scorching winds, sand storms, and westerly gales. The country around was devoid of beauty—sandy plains and rocky mountains alternating. There was very little vegetation either, and how the sheep lived was a mystery to me. There was a dried up water course near the town, where gum trees grew in some profusion. The question which occurred to me was—could bees prosper in a country like this? I had been here about three months when I was attacked with typhoid fever, and on recovery I went to Perth, the capital, to recruit my health. I had now made up my mind to return to the Straits as soon as I could conveniently give up my appointment at Roebourne. A line of steamers run between Fremantle, the port of Perth and Singapore. So I determined to buy a hive of bees, take them with me to Roebourne, and then afterwards go on to Singapore. I secured my bees, a fine stock of hybrids. I was most lucky in getting them safely shipped as far as Roebourne. At various ports of call on the way I would let them out if the day was perfectly calm, and, as the ship always stayed until dusk, I then secured them without loss. The novelty of bees in Roebourne was very strange. The residents said they would never thrive. But didn't they! They gathered quantities of good honey—it was the winter season when I introduced them—from the numerous flowers then in bloom. I sold the honey to the residents for 1s. 6d. and 2s. per section. Good, eh? They also swarmed, but the swarm, as I opine, came out when I was

from home, and betook itself to the trees in the watercourse. However, the bees which swarmed are there now, and will, I have no doubt, prosper and increase, to the great advantage of the settlers.

(To be continued.)

According to Dr. Miller's statements in *Gleanings*, the Fair is just as expensive or just as cheap as one may choose to make it. He says: "One of the things I was interested to know, was whether the stories told of the extortion and great cost of everything were true." "But," he says, "it's a good deal as you choose to look at it. I could fill pages telling you about the many great and beautiful things you can see for fifty cents, and how everything is arranged for your comfort; and I could take a blue view of affairs, and fill as many more pages telling how some one is ready to fleece you at every step, and that discomforts are on every hand."

ADVERTISEMENTS.

SEND IN YOUR ORDERS

AND GET

Manufacturer's Prices

ON ALL KINDS OF
BEEKEEPER'S

SUPPLIES.

The best Sections and Comb
Foundation.

I HAVE FOR SALE

75 Swarms of Bees

In 8 Framed Hives, Langstroth, all in excellent condition. Will sell reasonably if disposed of at once.

C. A. OUELETTE,
TILBURY CENTRE, ONT.

A GOOD BOOK.

THIS IS AN ENTIRELY NEW WORK

Of nearly 500 PAGES and a LARGE NUMBER OF ILLUSTRATIONS, *beautifully bound in extra-cloth with ink side stamp and gold back.* It embodies the ripe experience of a veteran housekeeper, and its recipes (of which there are great numbers on all branches of cookery) can be relied upon as accurate and trustworthy.

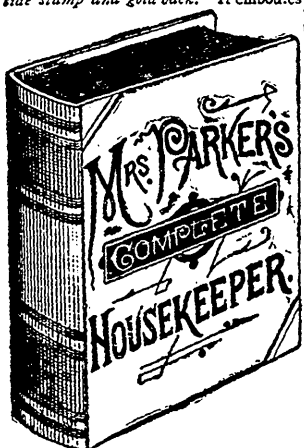

BREAD.—It tells how to make **BREAD** of all kinds, and gives numerous ways of preparing **YEAST**. Numerous recipes are given for making **ROLLS**, **BISCUITS**, **CRUMPLETS**, **SALLY LUNN**, **BUNS**, **CRACKERS**, **BATTER CAKES**, **CORN CAKES**, **MUFFINS**, **GEMS**, **WAFFLES**, **PUFFS**, **FRITTERS**, **MUSH**, **GRIES**, etc. **SOUPS.**—It tells how to make 60 different kinds of **SOUPS**, including **OX-TAIL**, **POCILLON**, **MOCK TURTLE**, **TERRAPIN**, **CONSOMME**, **SPANISH**, **FRENCH**, **TOMATO**, **JULIENNA**, etc. **MEATS.**—Clear and concise rules are given for **BOILING**, **ROASTING**, **BAKING**, **BROILING** and **FRYING MEATS** of all kinds. It gives the best method of **CUTTING UP** and **CURING PORK**, with an illustration and description of a **SMOKE HOUSE**. **POULTRY.**—It tells how to **SELECT**, **KILL** and **DRESS Poultry**, and numerous ways of cooking the same are given, as well as for **GAME**. **SALADS.**—**CHICKEN**, **HAM**, **OYSTER**, **FISH**, etc., and how to prepare. **EGGS.**—Numerous ways of preparing **EGGS** are given, including **OMELETS**. **FICKLES.**—How to make **CUCUMBERS**, **TOMATOES**, **WALNUTS**, **CABBAGE**, **CAULIFLOWER**, etc. **CATSUPS.**—To make from **TOMATOES**, **WALNUTS**, **CUCUMBERS**, **MUSHROOMS**, etc. **CAKE MAKING.**—175 Recipes for making every conceivable kind of **CAKE**, from the **PLAINEST** to **Wedding**, with full directions for icing are given. **PUDDINGS, DUMPLINGS, ETC.**—110 different kinds of **Puddings**, **Dumplings**, etc., with numerous **SALCES** for the same are given. **PASTRY.**—Directions are given for making 75 different kinds of **PIES**, including **PLUM**, **PEACH**, **APPLE**, **LEMON**, **CUSTARD**, **CREAM**, **CHOCOLATE**, **PUMPKIN**, **MINCE**, etc. **ICE CREAM AND WATER ICES.**—35 recipes are given under this head, with full directions for preparing and making **ICE CREAM** and **WATER ICES**. **DYEING.**—It tells how to dye

clothes successfully in a variety of colors and shades, with directions for **CLEANING SOILED GARMENTS**.

Handsomely bound in Extra Cloth; sent postpaid to any address on receipt of price.

The above Book may be had for **ONLY SEVENTY-FIVE**

CENTS by addressing **THE CANADIAN POULTRY JOURNAL.**

BEETON, ONT.

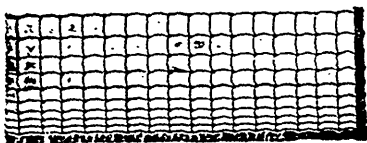

3 POSTS TO 100 FEET.

It will give and take, but never sag. It is a smooth fence. Will turn all kinds of stock. It is made of a coiled spring wire. Illustrated paper and price list sent free. **PAGE WIRE FENCE CO.** of Ont., Ltd., Walkerville, Ont.

MYERS BROS.,

The Leading Supply Manufacturers of the Dominion, are prepared to execute orders for all kinds of Hives, Supers, Foundation, Smokers, and Snow White Sections. One piece and your piece.

98-page Illustrated Circular of Supplies and Household Conveniences free.

Angrite Stove Mats each 25c., 3 for 65c., 5 for \$1. Address,

MYERS BROS.

Stratford, Ont.

1852

1893

LANGSTROTH ON THE HONEY-BEE. REVISED.

Price by Mail, \$1.40; by Express or Freight With Other Goods, \$1.25.

By its copious indexes, by its arrangements in numbered paragraphs, including reference numbers on any question in bee culture, any information can be instantly found. This book is the most complete treatise on bee-keeping yet published. A French Edition Just Published.

'78 Dadant's Comb Foundation '93

More than ever. - Better than ever. - Wholesale and Retail.

Half a million pounds sold in thirteen years. Over \$200,000 in value. It is the Best, and guaranteed every inch equal to sample. All dealers who have tried it have increased their trade every year. Samples, Catalogue free to all. Send your address.

We also make a specialty of Cotton and Silk Tulle of very best grade for bee-veils. We supply A. I. Root and others. Prices low. Samples free.

Smokers, Honey Sections, Extractors, Tin Pails for Honey, etc. Instructions to Beginners with Circulars free.

Chas. Dadant & Son, Hamilton, Hancock Co., Ill.

MENTION THIS JOURNAL

b-6 1y

POSITIVELY

JERSEYS FOR SALE.

AFTER APRIL 30TH

I will ship Pure Italian Queens by return mail at the following prices:

Warranted Queens, each..... \$1.00
Tested Queens, each..... 1.50
Select tested yellow to the tip, breeders', each 2.00

I refer by permission to the Editor of this journal who has purchased a number of Queens from me.

W. H. LAW,

b 22-7m.

Lavaca, Ark., U. S.

\$100 will buy a fine registered Jersey Cow, 5 years old. It is estimated she gave over 9000 pounds of milk last year. She is giving over 1000 per month now, on winter food. \$65 will buy a registered Jersey Heifer from above, same due to calve May 26th.

21 1y G. A. DEADMAN, Brussels, Ont.

CONSER'S PATENT NON-SWARMER.

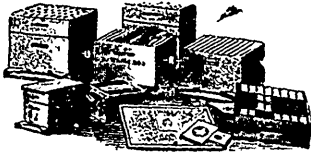

New idea in producing comb honey that will revolutionize beekeeping. On exhibition at the World's Fair. Write for circular to

JOHN CONSER,
m 110 East Main St., Sedalia, Mo.

**ONE
CENT**



is all it costs to receive a copy of the best Agricultural Monthly in Canada. Send your name on a post card to the RURAL CANADIAN, Toronto, when a sample will be sent free.



10 Cts. Only \$80 a Mile.

Land-Owners save one-half the cost and avoid dangerous bars.

Agents make \$200 per month and expense Cash. The best local and travelling agents wanted everywhere. Write at once for circulars and choice territory. Address A. G. Hulbert, Patentee, care of Hulbert Fence and Wire Co., 90 1/2 Olive Street, St. Louis, Mo. Factory Catalogue with 200 engraved designs and prices, sent free to any who want fancy iron and wire work for city, cemetery and farm fences, etc. b-7. 1yr

**SEND FOR
SAMPLE COPY**

OF THE

Canadian Bee Journal

ADDRESS: BEETON, ONT.

ONE DOLLAR

PAYS FOR

**Cook's Manual of
the Apiary.**

This book should be in the home

of every beekeeper. Address :

CANADIAN BEE JOURNAL,

BEETON, ONT.

EXCHANGE AND MART.

SEND us fifty cents and get Hutchinson's "Advanced Bee Culture." C B Beeton.

40 OR 50 SWARMS OF BEES for sale cheap, or exchange for a set of double harness, sulky rake, or seed drill. THOS. CHRISTIAN, Lorraine, Ont. b2-51

FOR SALE—A limited quantity of Section Foundation made from my own white capping wax. For prices address, J. ALPAUGH, Box 704, St. Thomas, Ont. 25-11

A QUANTITY of Porter & Hastings Bee Escapes on hand I will sell them cheap. Would clear the lot out at a low price to a dealer G. T. SOMERS, Beeton, Ont. 11

WE HAVE several bound volumes of Clark's "Birds Eye View" of Beekeeping. Will mail on receipt of 10c. CANADIAN BEE JOURNAL, Beeton, Ont. b-24-11

FOR SALE..2,000 lbs. No. 1 Extracted Clover and Basswood Honey, mostly put up in 60 lb. tins; a portion of it in 5, 8, and 10 lb. tins. JAS. STEWART, Meaford, Ont. b24-51

FOR SALE.—20 colonies bees, at a sacrifice, in good hives, will weigh from 75 to 100 lbs. Must be sold at once. Will give a good bargain. R. J. GRACEY, Wellandport, Ont.

1893. WRITE now and see how low I can supply you with odd and regular sized Hives and Frames. Also set prices on sections, foundation, Honey Extractors, Knives, smokers, and anything you may need in the apiary for 1893. W. A. CHRYSLER, Box 450 Chatham, Ont.

FIVE BANDED BEES—I make a specialty of breeding Five Banded Bees and Queens. Had twenty-six years experience in breeding Queens and I have two fine Queens to breed from for 1893. Will sell Untested in May, \$1; Tested, \$1.75. June, 75c; or \$8 a dozen: Tested \$1.50. August, 60c, or \$6 a dozen. September, 50c. Sample of Bees and Drones sent free. All Queens that arrive dead, return the cage and I will send another. Satisfaction guaranteed or money refunded. N. H. SMITH, Box 2, Tilbury Centre, Ont. b24 5t.

FIVE BANDED GOLDEN ITALIANS.

My Five Banded Golden Italians are not excelled by any bees in existence. A fair trial will convince. Queens, after June 1st, \$1 each; 6 for \$5. Special prices on large orders. Safe arrival guaranteed. Send for descriptive circular giving full particulars.

CHARLES D. DUVAL.
SPENCERVILLE MONTG. CO. MD

ORDERS TAKEN NOW FOR

TESTED ITALIAN QUEENS

to be shipped June 1st. Prices as follow: those under one year old \$1.25, under 2 years, \$1 with a discount of 10 per cent for cash on orders received this month. I have been selecting and breeding queens for the past ten years and believe I have bees that are equal to any.

G. A. DEADMAN,

b 21 1 y. Druggist, Apurist, Etc., Brussels.

-- GOLDEN ITALIAN QUEENS. --

Bred from Select Mothers for the coming season at a grade of prices to suit the times. Orders booked now. Untested Queens, June, \$1; Untested Queens, July and after, 75 cents; Tested Queens, May, \$1.50; Tested Queens, June, \$1.25; Tested Queens, July and after, \$1; Select Tested Queens, May and June, \$2; Select Tested Queens, July and after, \$1.50. For large quantities, write for prices. All Untested queens warranted purely mated. A. E. SHERRINGTON, Box 270, Walkerton, Ont.

Attention, Beekeepers!

Tested Italian Queen in May, \$1.50 each. Snow white sections \$2.50 per thousand. Hoffman frames and a full line of Beekeepers' Supplies. Twenty page price list free. J. M. KINZIE, Rochester, Oakland Co., Mich. b4 1y.

BARNES'

FOOT

AND



HAND

POWER

MACHINERY

This cut represents our Combined Circular and Scroll Saw, which is the best machine made for beekeepers' use in the construction of their hives, sections, boxes, etc. Machines sent on trial. For catalogues, price lists, etc., address W. F. & JNO. BARNES CO., 574 Ruby street, Rockford, Ill. b41y.

We Want Agents

To get up Club Lists of New Subscribers for the

Canadian Bee Journal.

New Subscriptions date from time of receiving same. Sample copies furnished free to agents. For particulars address:

BEEETON PUB. CO.

BEEETON, - ONT.

ADVERTISEMENTS.

CIRCULAR FOR 1893

Now ready, in which we offer
**GRAY CARNIOLAN AND GOLDEN ITALIAN
 QUEENS**

In their 'time bred from pure mothers, and by the
 best method known. Send for Circular.

For Carniolans to	For Italians to
JOHN ANDREWS,	L. E. BURNHAM,
Fatten's Mills, N.Y.	Vaughns, N.Y.

DR. J. W. CRENSHAW,
 VERSAILLES, KENTUCKY, U.S

offers for sale **Untested Queens.** May and
 June, \$1; After, 75c. Imported or Doolittle
 mother, as preferred. Contracts solicited.
 Root's goods for sale; also Celery plants, July to
 Sept., at \$2 per thousand. b4 1y



Carniolan and Italian QUEENS

bred from pure mothers for
 the coming season, at a grade of prices to
 compare with that of honey production;
 and the utmost care should be taken to
 have them as good as any man can breed.
 Carniolans or Italians, untested, each, 75
 cts.; 3 untested queens, \$2; 6 untested
 queens, 3 60; tested queens from either
 yards, after the 20th of June, each, \$1.
 All queens that are known to be mismated
 will be sold at 50 cents each, including all
 'Yellow Carniolans.'

For further particulars send for circular
 to JOHN ANDREWS, Fattens Mills,
 Wash. Co., N. Y.

THE American Beekeeper

A 24 page illustrated monthly for beginners.

FIFTY CENTS A YEAR.

Sample copy free. Published by

The W. T. FALCONER Mfg. Co'y
 JAMESTOWN, N. Y. U. S.

Largest Manufacturers in America

—OF—
 BEE HIVES, SECTIONS, AND ALL
 BEEKEEPERS' SUPPLIES.

Large Illustrated Catalogue & Price List Free.
 B. r. Y.

THE ISLAND HOME

Is the only Queen and Drone Rearing
 Establishment in America, where mating
 is under perfect control, where all queens
 are mated on an island five miles from
 mainland to

HAND-PICKED DRONES

They are acknowledged by all to be the
 finest in the world. Our queens are reared
 and mated with as much precision as you
 can breed sheep; therefore we have no such
 thing as tested and untested queens—ours
 are

Thoroughbred Queens.

One queen of our original stock, G. M.
 Doolittle valued at \$50.

We warrant every queen to produce Five
 Banded Bees, equal to sample, which we
 send free by mail to all who apply. (Ask
 other breeders for such a guarantee.) Safe
 arrival and satisfaction in all cases. Drop
 us a card, and have a look at the finest bees
 in the world. truly yours,

A. W. BROWN, PORT ROWAN, ONT.
 b 7 1 yr

HONEY CANS.

SPECIAL —PRICES

	Per 100
2 lb. and 2½ lb., slip top.....	\$ 4 50
3 lb. and 5 lb., slip top.....	5 50
5 lb., screw top.....	6 50
10 lb., screw top, with bail.....	11 00
60 lb. round, 1 screw top—in lots of 10, 25c. each.	
60 lb., lots of 10, round, encased in wood, 33c.	
60 lb. square, encased in wood 48c.	
5 lb. Tin Honey Pails, straight sides with bail; cover fits tight; the cheapest in the market..	\$ 6 00
10 lb. Tin Honey Pail, same as above.....	8 00
N.B.—No charge for boxes or packing.	
2 lb. wood pail, per 100.....	\$1 30
4 lb. wood pail, per 100.....	1 80

Send for our 1893 Illustrated Catalogue
 of Beekeepers' Supplies. Prices lower than
 ever.
 b16 6t T. PHILLIPS & Co., Orillia.

HASTINGS' LIGHTNING

BEE



ESCAPE

Send for sample of Hastings' Lightning Bee Escape and you will be convinced that it is the best and most practical Escape yet produced. It will clear the supers in a short space of time (2 to 4 hrs.) and it is impossible for the bees to clog the passage as they cannot return. Each Escape guaranteed as represented. Price by mail, each, 20c; \$2.25 per dozen. Full directions with each Escape. Write for discount. Electrotypes for dealers' catalogues furnished free.

TESTIMONIALS.

M. E. HASTINGS, ORISKANY, N. Y., March 7, 1892.
 Dear Sir,—The Lightning Ventilated Bee Escapes which you sent to me last season worked well and all that you claimed for them. They do not clog, and clear the supers rapidly. In fact it is the best escape I have yet used. I cannot speak too highly of the Escape, and consider it a great boon to bee keepers.
 Respectfully Yours, W. E. CLARK.

Dear Sir,—NEW YORK MILLS, N. Y., April 4, 1892
 The Bee Escape invented by you is the best I have yet seen, freeing the sections most effectually in short order, and its construction being such as to make it impossible to get out of repair. It will therefore meet with the approval of all bee-keepers.
 Yours Respectfully, F. A. GLADWIN.

M. E. HASTINGS, UTICA, N. Y., October 21, 1892.
 Dear Sir,—Your Lightning Bee Escape does away with the hard, disagreeable work attending the harvesting of honey, being very much easier than the old way. In my opinion it is the best Escape yet produced.
 Truly Yours, B. E. FOSTER.

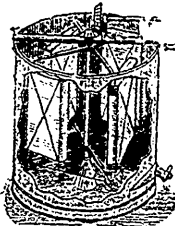

HASTINGS' POSITIVE REVERSIBLE EXTRACTOR

The above illustration shows a New Extractor now ready for the market. The principal features are that it is positive in the reversing of the baskets, as they all move at once without either the use of chains or reversing of the crank.

It is not necessary to turn the crank more than one way in extracting; but if desired it can be turned either way. It is produced by experts in extracting to be the most desirable Reversible Extractor yet produced. When ordering send a sample frame and price will be quoted on either 3, 4, 5 or 6 frame Extractors.

Hastings' Perfection Feeders.

These Feeders are now made with a capacity of two quarts, and the price is reduced to thirty cents each, or \$3 per dozen, by express or freight. When ordered by mail add ten cents each for postage. These Feeders can be re-filled without moving the Feeder, or disturbing the bees. The letting down of food is regulated by a thumb screw. It is easy to regulate—either a quart or a spoonful can be given in a day or an hour, as may be required, and where it is most needed, over the cluster of bees. For rapid feeding two feeders may be placed over the bees at one time, not a drop of food can be lost, and the robber bees cannot get at it. Special rates to dealers. Write for prices. Supply dealers furnished at wholesale prices. An electrotype will be furnished free to dealers wishing to advertise Feeder in their catalogues.

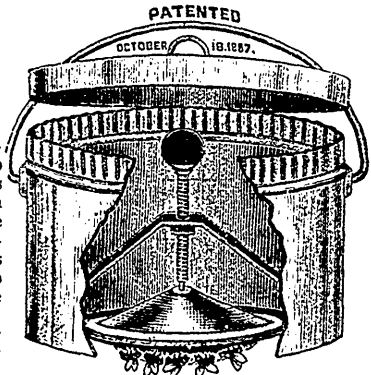

M. E. HASTINGS.

Patentee and sole Manufacturer, New York Mills, Oneida Co., N. Y.

MUTH'S

HONEY EXTRACTOR !

Square Glass Honey-Jars,
Tin Buckets, Bee-Hives,
Honey-Sections, &c., &c.
Perfection Cold-Blast Smokers.
Dealers in Honey and Beeswax.

CHAS. F. MUTH & SON CINCINNATI, O

Send 10c stamp for 'Practical Hints to Beekeepers. MENTION THIS JOURNAL b-2-1y

Toronto Island. For sale, as early as the season admits, pure bred Queens from Doolittle's Five Banded strain, also Maccum's strain mated to pure yellow drones on this Island. Our situation enables us to warrant Untested Queens purely mated. This is no experiment. Send for descriptive circular. Untested, \$1; Tested, \$1.50. Special rates on large orders.

JOHN McARTHUR & CO.,
881 Yong St. Toronto, Ont.

b24-4t

HAVE YOU SEEN IT ?

If not send for free Sample Copy of the

" Progressive Bee-Keeper."

A Wide Awake Monthly Journal that pleases everybody. 50c. per year.

ADDRESS :

Progressive Bee-Keeper - Unionville, Mo.
c-1f

PATENT

WIRED COMB FOUNDATION.

Is better, cheaper and not half the trouble to use that it is to wire frames. Every cell perfect. Thin, flat-bottom foundation has no fish-bone in surplus honey. Being the cleanest is usually worked the quickest of any foundation made. J. VAN DEUSEN & SONS, Sole Manufacturers, Sprout Brook, Montgomery Co., N.Y. b4 1y.



: TO :

Ontario Beekeepers.

INTENDING exhibitors of Honey at the Chicago Exposition, will kindly place their Extracted Honey in tin jars, as the Commission intend shipping the Honey in these cans to Chicago. The Dominion Government will furnish glass jars in which the Extracted Honey will be shown. This will secure safe transport, and Exhibits will reach Chicago in much better shape.

NICHOLAS AWREY, M.P.P.,
Ontario Commissioner World's Columbian Exp. b14 ft.

QUEENS AND BEES !

FINE ITALIANS

From South Carolina to Canada in nice condition :—

- | | MAY. | JUNE AND AFTER. |
|--------------------------------|---------|-----------------|
| 1 untested Queen, | \$1. | 75 cents each. |
| 6 untested Queens, | \$5. | \$4. |
| 1 tested Queen, | \$1.50. | \$1.50. |
| 3 tested Queens, | \$4. | \$4. |
| Select tested, | \$2.50. | \$2.50. |
| 2 Frame Nuclei with any queen, | \$1.50 | each, extra. |

Safe arrival guaranteed.

W. J. ELLISON,

3 12in Catchall, Sumter Co., S. C.

BIG SMOKERS FOR BIG BEEKEEPERS.

My new Smoker is now ready. I claim the following points of excellence, viz.:— A stronger blast than any ever made; a valve accessible from the outside, and for delicacy of spring exceeded by none; calf-skin leather instead of sheepskin; bellows boards protected against damp, by shellac inside and outside; fire-barrel, 3¼ x 10 inches, and bellows 6 x 9, spring outside, grate heavy, and riveted in the barrel. Neither ashes nor cinders can possibly get into the bellows. The whole is well constructed. There is not a weak or flimsy spot in the whole machine. Price, \$2.50 each, cash with order. When 3 or more are ordered together express charges will be prepaid.

S. CORNEIL.

Lindsay, March 28, 1893. 1-tf

Swarming Prevented!

THE BEEKEEPER'S REVIEW will take another step in advance by publishing in its March issue an illustrated article by B. Taylor, showing how, by a slight modification of hives and a little manipulation, the bees from two queens can be made to work unitedly in one super and **swarming be absolutely prevented.** Send ten cents and when this number is out it will be sent together with two other copies of late but different issues; or, for \$1, the REVIEW will be sent from January to the end of the year. The 50-cent book, "Advanced Bee Culture," and the REVIEW one year for \$1.25. W. Z. HUTCHISON, Flint, Mich.

24-1f

IF YOU WANT

DOVETAILED HIVES

Good Sections, the very best grade of Foundation Excellent Smokers, 8 sizes, special, Gauge's Wire Nails, Swarming devices, Perforated Metal at fine cut prices, or all other kinds of useful supplies at low figures, and good quality. Send at once to

W. A. CHRYSLER, Box 450. Chatham Ont. 24 1f

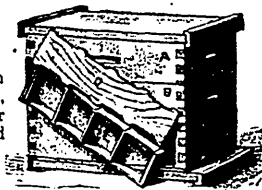

A CLEARING SALE.

The following goods will be sold with the following discounts from the D. A. Jones Co's. Catalogue which will be supplied on application. If you require anything, send in a list at once for quotations:—Honey Labels, 50 per cent. discount; Queen Registers, 50 per cent.; Section Presses, 30 per cent.; Force Pumps, 30 per cent.; Wire Nails, 30 per cent.; Wire Embedders and Section Foundation Fastenings, 30 per cent.; Sun Wax Extractors, 30 per cent.; Jones Honey Knives, 30 per cent.; Jones No. 2 Smokers for 75 cents; Jones Honey Extractors, made to carry Langstroth, Jones, Combination and Richardson frames: a quantity of 60 lb. Tins, encased in wood; Perforated Metal; Honey Boards; Hive Clamps; Queen Cage Metal: a few pairs of Rubber Gloves, large sizes; a quantity of Bokhara Clover: Brood and Section Foundation; second hand Canadian Feeders: second hand 8 and 9 Frame Combination Hives; about 200 Supers made up for 9 Frame Combination Hives, new; Bee Charts: Wire Cloth; Hastings & Porter Bee-escape. All of which goods will be cleared out at a price.

A NUMBER OF COLONIES OF BEES

IN EXCELLENT CONDITION.

A SET OF TINSMITH'S TOOLS

ALL IN GOOD ORDER.

Correspondence solicited. For any further particulars address,

G. T. SOMERS, BEETON, ONT.