

**CIHM
Microfiche
Series
(Monographs)**

**ICMH
Collection de
microfiches
(monographies)**



Canadian Institute for Historical Microreproductions / Institut canadien de microreproductions historiques

© 1998

Technical and Bibliographic Notes/Notes techniques et bibliographiques

The Institute has attempted to obtain the best original copy available for filming. Features of this copy which may be bibliographically unique, which may alter any of the images in the reproduction, or which may significantly change the usual method of filming, are checked below.

L'Institut a microfilmé le meilleur exemplaire qu'il lui a été possible de se procurer. Les détails de cet exemplaire qui sont peut-être uniques du point de vue bibliographique, qui peuvent modifier une image reproduite, ou qui peuvent exiger une modification dans la méthode normale de filmage sont indiqués ci-dessous.

- | | |
|--|--|
| <input type="checkbox"/> Coloured covers/
Couverture de couleur | <input type="checkbox"/> Coloured pages/
Pages de couleur |
| <input type="checkbox"/> Covers damaged/
Couverture endommagée | <input checked="" type="checkbox"/> Pages damaged/
Pages endommagées |
| <input type="checkbox"/> Covers restored and/or laminated/
Couverture restaurée et/ou pelliculée | <input type="checkbox"/> Pages restored and/or laminated/
Pages restaurées et/ou pelliculées |
| <input type="checkbox"/> Cover title missing/
Le titre de couverture manquant | <input checked="" type="checkbox"/> Pages discoloured, stained or foxed/
Pages décolorées, tachetées ou piquées |
| <input type="checkbox"/> Coloured maps/
Cartes géographiques en couleur | <input type="checkbox"/> Pages detached/
Pages détachées |
| <input checked="" type="checkbox"/> Coloured ink (i.e. other than blue or black)/
Encre de couleur (i.e. autre que bleue ou noire) | <input checked="" type="checkbox"/> Showthrough/
Transparence |
| <input type="checkbox"/> Coloured plates and/or illustrations/
Planches et/ou illustrations en couleur | <input type="checkbox"/> Quality of print varies/
Qualité inégale de l'impression |
| <input type="checkbox"/> Bound with other material/
Relié avec d'autres documents | <input type="checkbox"/> Includes supplementary material/
Comprend du matériel supplémentaire |
| <input checked="" type="checkbox"/> Tight binding may cause shadows or distortion
along interior margin/
Le reliure serrée peut causer de l'ombre ou de la
distorsion le long de la marge intérieure | <input type="checkbox"/> Only edition available/
Seule édition disponible |
| <input type="checkbox"/> Blank leaves added during restoration may
appear within the text. Whenever possible, these
have been omitted from filming/
Il se peut que certaines pages blanches ajoutées
lors d'une restauration apparaissent dans le texte,
mais, lorsque cela était possible, ces pages n'ont
pas été filmées. | <input type="checkbox"/> Pages wholly or partially obscured by errata
slips, tissues, etc., have been refilmed to
ensure the best possible image/
Les pages totalement ou partiellement
obscurcies par un feuillet d'errata, une pelure,
etc., ont été filmées à nouveau de façon à
obtenir la meilleure image possible. |
| <input type="checkbox"/> Additional comments:/
Commentaires supplémentaires: | |

This item is filmed at the reduction ratio checked below/
Ce document est filmé au taux de réduction indiqué ci-dessous.

10X	14X	18X	22X	26X	30X
<input type="checkbox"/>	<input type="checkbox"/>	<input checked="" type="checkbox"/>	<input type="checkbox"/>	<input type="checkbox"/>	<input type="checkbox"/>
12X	16X	20X	24X	28X	32X

The copy filmed here has been reproduced thanks to the generosity of:

Toronto Reference Library

The images appearing here are the best quality possible considering the condition and legibility of the original copy and in keeping with the filming contract specifications.

Original copies in printed paper covers are filmed beginning with the front cover and ending on the last page with a printed or illustrated impression, or the back cover when appropriate. All other original copies are filmed beginning on the first page with a printed or illustrated impression, and ending on the last page with a printed or illustrated impression.

The last recorded frame on each microfiche shell contain the symbol \rightarrow (meaning "CONTINUED"), or the symbol ∇ (meaning "END"), whichever applies.

Maps, plates, charts, etc., may be filmed at different reduction ratios. Those too large to be entirely included in one exposure are filmed beginning in the upper left hand corner, left to right and top to bottom, as many frames as required. The following diagrams illustrate the method:

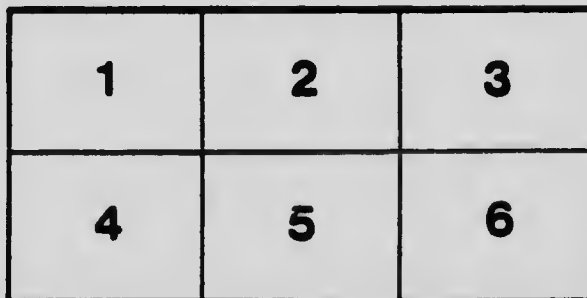
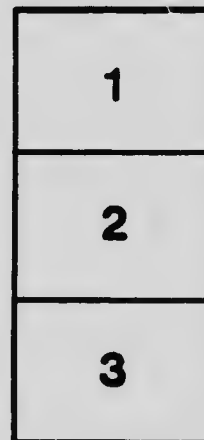

L'exemplaire filmé fut reproduit grâce à la générosité de:

Toronto Reference Library

Les images suivantes ont été reproduites avec le plus grand soin, compte tenu de la condition et de la netteté de l'exemplaire filmé, et en conformité avec les conditions du contrat de filmage.

Les exemplaires originaux dont la couverture en papier est imprimée sont filmés en commençant par le premier plat et en terminant soit par la dernière page qui comporte une empreinte d'impression ou d'illustration, soit par le second plat, selon le cas. Tous les autres exemplaires originaux sont filmés en commençant par la première page qui comporte une empreinte d'impression ou d'illustration et en terminant par la dernière page qui comporte une telle empreinte.

Un des symboles suivants apparaît sur la dernière image de chaque microfiche, selon le cas: le symbole \rightarrow signifie "A SUIVRE", le symbole ∇ signifie "FIN".

Les cartes, planches, tableaux, etc., peuvent être filmés à des taux de réduction différents. Lorsque le document est trop grand pour être reproduit en un seul cliché, il est filmé à partir de l'angle supérieur gauche, de gauche à droite, et de haut en bas, en prenant le nombre d'images nécessaire. Les diagrammes suivants illustrent la méthode.

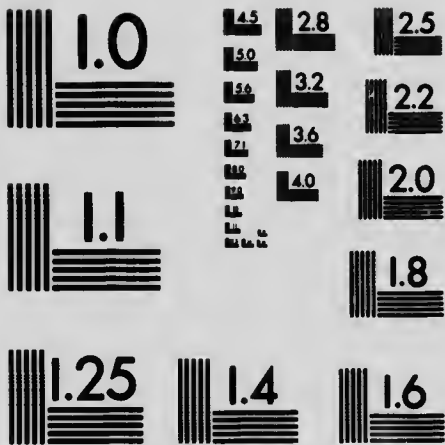

MICROCOPY RESOLUTION TEST CHART
NATIONAL BUREAU OF STANDARDS
STANDARD REFERENCE MATERIAL 1010a
(ANSI and ISO TEST CHART No. 2)

IN

Ent

RITUAL
OF THE
INDEPENDENT ORDER OF FORESTERS
FOR
SUBORDINATE COURTS



This Ritual supersedes all former editions and becomes the only authorized Official Ritual of the Order.

Entered according to Act of the Parliament of Canada, in the year one thousand nine hundred and five, by OROHYATEKHA, Supreme Chief Ranger, at the Department of Agriculture.

TORONTO, ONT. :
The Hunter, Rose Co., Limited, Printers
1905

DIAGRAM OF COURT ROOM

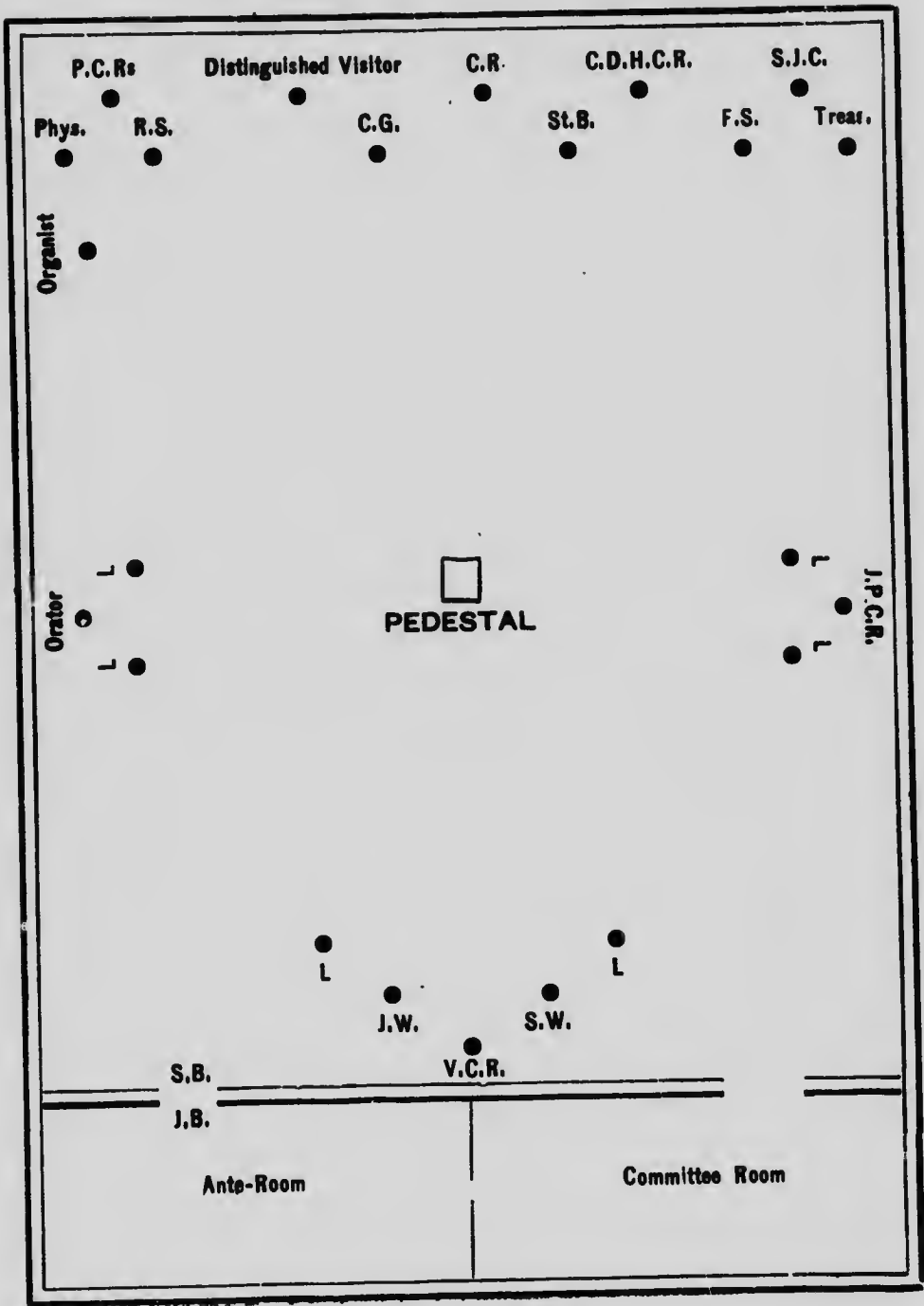

FFR 7 1973

366.60771
F59.2

GENERAL INSTRUCTIONS

Presiding Officer.—In the absence of the C.R., the Junior P.C.R. shall preside; if the Junior P.C.R. be absent, then the P.C.R. present who was most recently the C.R. shall preside; if there be no P.C.R. present who has occupied the C.R.'s chair, the Senior Honorary P.C.R. shall preside; if no P.C.R. be present, then the V.C.R. shall preside; and if the V.C.R. be absent, the officer of the Court who is next highest in rank shall preside. If no officer of the Court be present, then any member may call the Court to order, and a Chief Ranger *pro tem.* be chosen, who shall preside until an officer of the Court arrives. Through courtesy to a distinguished visitor of rank, the Presiding Officer may invite him to preside.

Absent Officers.—In the case of officers being absent, the Presiding officer shall fill the chairs by *pro tem.* appointments from the members of the Court or visiting members present. Whenever a regular officer arrives he shall take his chair.

Voting.—The Presiding Officer shall not be entitled to vote when the voting is by sign vote or by yea and nay vote, but shall give the casting vote on such occasions in the event of a tie. When the voting is by written ballot or ball ballot the Presiding Officer shall cast his ballot the same as the other members, and shall not in that case be entitled to give the casting vote in the event of a tie. A visitor, though acting as C.R., has no vote, and in case of a tie shall declare the motion lost because it has not received the requisite majority of votes.

Balloting for Candidates.—When a candidate is to be balloted for, the C.R. shall instruct the S.W. to prepare the ballot-box, who will thereupon get the ballot-box and take all ballots out of the compartment into which the ballots are to be cast by the members. The C.R. will then say to the Court, "We are about to ballot on the application of—for membership in this Court: white balls elect, black balls reject." The S.W. will then present the ballot-box to the V.C.R.,

who will inspect it to see that there are no balls in the compartment into which the ballots are to be cast; it will then be presented to the C.R., who will also inspect it, and, closing the box, will cast his ballot; the S.W. will then place the ballot-box on the pedestal, cast his ballot and return to his station. The C.R. will then direct the members to vote, one at a time. When all have voted who wish, the C.R. will say, "Have all voted who wish? If so, I declare the balloting closed." The S.W. will then present the ballot-box to the V.C.R. for inspection, after which he will present the ballot-box to the C.R., who will also inspect it. The C.R. will then say, "V.C.R., how do you find the ballot?" And the V.C.R. will answer, "favorable," or "unfavorable," as the case may be. The C.R. will then announce to the Court the result of the ballot, saying: "I also find the ballot favorable; and declare——duly elected to membership in this Court" (or "I also find the ballot unfavorable; and declare——duly rejected"). Any number of candidates can be allotted for at one time, provided, however, after the ballot is taken, should three or more black balls appear, the C.R. shall order a separate ballot to be taken for each candidate. Should a candidate be rejected, and the Court has reason to believe it was done to serve personal ends, it must proceed in accordance with the Constitution and Laws of the Order relating to the subject.

The black disks, "●" indicate the number of raps of the Gavel to be given by the Officers for calling up, seating, or calling the Court to order; in certain cases they also indicate the knocks to be given on the inner door of the Court room.

In the Initiation Ceremony, when there is more than one candidate, the words printed in *italics* must be transposed into the plural number. For instance, "*Candidate*" must be changed to **Candidates**, and "*he (she) has*" must be changed to "**they have,**" etc. When necessary, the plural must be changed to the singular number.

RITUAL

FOR

SUBORDINATE AND COMPANION COURTS

OPENING



CEREMONY.

(When the hour arrives for opening the Court, the C.R. will call the Court to order by one rap of the gavel; the officers will then take their respective stations. In a Companion Court, instead of "Brother, Brothers or Brethren," use Companion or Companions and change the masculine form whenever necessary to the feminine form.)

C.R.—The Court will please come to order. All who are not members of the Order will please retire.

(If there be any vacancies in the offices, the C.R. will make the necessary *pro tem.* appointments, as follows:)

C.R.—I appoint *Bro. (Comp.)*—as—*pro tem.*, etc.

C.R.—The Woodwards will see that all present are worthy Foresters.

(The S.W. and J.W. will advance to the C.R. and give the S.A.P.W., and then beginning at the right and left of the Chair, examine all present, of whom they have any doubt, in the current S.A.P.W., except those on the Dais, for whom the C.R. is held responsible. If the Woodwards find any one without the S.A.P.W., they will immediately report the fact to the C.R., who will forthwith deal with the case, by communicating the S.A.P.W., or by ordering the delinquent to retire. After the examination, the Woodwards will report to the V.C.R., who, when satisfied that all present are worthy Foresters, will report to the C.R., as follows:)

V.C.R.—Chief Ranger, all present are worthy Foresters.

C.R.—Thank you, Vice Chief Ranger.



C.R.—The Orator will address the Throne of Grace.

OPENING PRAYER.

Orator.—Great and Merciful God, we once more assemble together in Thy holy name and humbly invoke Thy blessing upon this Court. We pray Thee to incline our hearts to do Thy will; teach us to be wise, moderate and just in all our actions; courteous and forgiving to one another and lenient in condemnation of an erring member. Teach us to make truth, justice and charity the ground-work of all our acts; and to Thee be ascribed all the glory and praise, now and evermore. Amen.

C.R.—I now declare the Court duly and legally opened for the transaction of business.



(The C.R. will then begin with No. 2 of the Order of Business and proceed with the same as laid down in the "Order of Business.")

ORDER OF BUSINESS.

1. Opening ceremony.
2. Calling roll of officers.
3. Reading, correcting and confirming the minutes.
4. Propositions for membership.
5. Reports of committees on character.
6. Balloting for candidates.
7. Has the Recording Secretary notice of acceptance by the Medical Board of the medical examination paper of any applicant for membership
8. Initiation of candidates.
9. Appointment of the Special Auditing Committee.
10. The Financial Secretary will state when and how *he* sent the monthly remittances to The Supreme Court for the present month.

{ The R.S. will note the date given by F.S., and record whether }
by Post Office or Express Money Order, or Bank Draft. }

(If the F.S. has not sent the report and remittance for the present month, *he* should be required to do so forthwith. Special attention is directed to the Constitution and Laws of the Order, which clearly show that it is not necessary for the F.S. to wait for an order to send the monthly remittance to The Supreme Court, but that the order may be drawn at the next meeting of the Court after the remittance has been sent.)

11. The Recording Secretary will draw an order on the Treasurer for the amount of the present month's remittance to The Supreme Court.

12. The duplicate of the monthly report for the present month will now be filed as the property of the Court; and the Special Auditing Committee will carefully examine it and report on its correctness.

13. The Recording Secretary will read the names of those suspended members for whom notices of reinstatement have been received from the Supreme Secretary since the last meeting, and enter the names in the minutes.

14. Intermission. (During which payments are to be made to the Financial Secretary.)

15. Has the Recording Secretary the receipt for the remittances for the present month?

(If not, and a reasonable time has elapsed since the remittance was made, the R.S. should forthwith write to the Supreme Secretary, inquiring why the receipt for the monthly remittance has not been forwarded.)

16. Has the Recording Secretary any other communications?

17. Is any member out of employment?

18. Reception of general communications.

19. Bills or accounts.

20. Reports of standing committees.

[(a) Sick. (b) Finance. (c) Arbitration, if charges have been referred to it.]

21. Reports of special committees. { (a) Special Auditing.
(b) Other Committees. }

22. Unfinished business.

23. General business.

24. { Reports of officers. }

25. { Election of officers. }

26. { Installation of officers. }

To be called only at the time of the election and installation of officers.

27. Good and welfare.

28. Closing ceremony.

[Each monthly report and remittance should be made by the Financial Secretary before the *third* day of the month. The Constitution and Laws provide that the penalty for failure to remit is suspension or expulsion. All reports should be written in duplicate; the duplicate should be laid before the Court at its first meeting in each month, and should be carefully examined by the Special Auditing Committee as to its correctness, and then filed with the records as the property of the Court. All remittances shall be made as provided in the Constitution and Laws.]

It is the *business* of the officers and members to know that the Financial Secretary does his whole duty at the right time and in the right way, failing in which he should be removed from office at once.

When a Court becomes suspended, subject to the provisions of the Constitution and Laws the penalty of suspension attaches to the members as well, and reinstatement of the Court and members can be effected only as provided in the Constitution and Laws.

Any member who fails to pay on or before the last day of the month, all assessments, dues, fees, taxes, fines and other demands of the Order for the succeeding month, *ipso facto* stands suspended on the first day of such succeeding month. A member suspended for non-payment must apply for reinstatement on Form No. 15 and be reinstated *within ninety days* from the date of his suspension, or he will be re-rated at his present age on reinstatement. The Constitution and Laws clearly provide the manner in which members suspended for non-payment can be reinstated, and they can be reinstated in no other way. The penalty attaching to a Court and the members who permit a suspended member to apply for reinstatement while ill or disabled is also set forth in the Constitution and Laws.

An applicant for membership must not be initiated until he has been examined by the Court Physician or other duly authorized examining Physician and recommended by him to the Court, on Form No. 59, for beneficiary membership and before the said Form No. 59 has been received by the Recording Secretary, or before his medical examination paper has been accepted and passed by the Medical Board, as the case may be.

It is to the interest of each member that he procure a copy of the Constitution and Laws as amended at the last session of The Supreme Court, as every member is bound by the Constitution and Laws of the Order as revised from time to time.]

CLOSING



CEREMONY.

●

C. R.—The Court will give attention to the closing ceremonies. Financial Secretary, give the name of each member who has paid you since last report, and the amount paid by each; also give the name of each suspended member applying for reinstatement on Form No. 15, and the amount of arrears deposited by each.

F. S. (Rising)—Chief Ranger, they are as follows:

(The F.S. will here hand a signed memorandum to the R.S., containing the amounts paid to the F.S. since last report and by whom paid, after which he will state audibly to the Court the receipts in detail, naming each member who has paid and the amount paid; the R.S. will check from the memorandum handed to him by the F.S., and afterwards enter the same in the minutes. It is the duty of both the C.D. and the C.R. to see that the R.S. enters the names and amounts in the minutes.)

C. R.—The Recording Secretary will see that the proper entries are made in the Records, of the names and amounts as just given by the Financial Secretary.

Financial Secretary, you will now hand over to the Treasurer the whole amount of money you have received since the time *he* signed the last receipt in your Cash Book.

● ● ●

C. R.—*Brethren (Companions)*, the business of the Court having been concluded, I have to thank you for your presence and attention this evening, and to impress upon your minds the importance of being present at all our meetings, not only to watch

over the interests of the Order, but to take part in the deliberations of the Court. I trust you will all be able to attend our next meeting.

The Orator will now address the Throne of Grace.

CLOSING PRAYER

O.—Our Father who art in Heaven, we bow again in humble submission before Thy Throne of Grace. We implore Thy direction and blessing upon all our efforts to advance the principles of our Order; and we earnestly beseech Thee to grant to all Foresters, but especially to all members of this Court, wisdom and strength to walk in the paths of peace, virtue and morality; to be courteous and forgiving, and lenient in condemnation of an erring member. Guide our footsteps in safety to our homes; through the journey of life ever lead us; and finally, through Thy infinite mercy, bring us to Thy Heavenly Court above, and to Thy holy name be all the glory and praise now and for evermore. Amen.

C. R.—I now declare the Court duly and legally closed.



FIRST

INITIATION



CEREMONY.

C. R.—Senior Woodward, you will retire to the ante-room and ascertain if there be any *Candidates* waiting to be initiated; and, if so, report their names in full to the Court.

(The S. W. will then retire, and if there be any candidates, he will, upon returning to the Court, report their names in full to the Court.)

C. R.—Recording Secretary, *has the Candidate* been duly proposed and regularly elected for membership in our Order?

(As soon as the C.R. addresses the R.S., the latter will rise in his place and remain standing till he has answered the questions.)

R. S.—*He has*, Chief Ranger.

C. R.—*Has the Candidate* been duly examined by the Court Physician and recommended by him to the Court, on Form No. 59, for beneficiary membership, and have you received that form?

R. S.—I have received Form No. 59, fully and properly filled up, for———(*give name*), and———*has* already been accepted by the Medical Board.

C. R.—*Has the Candidate* complied with all the other requirements of the Constitution and Laws, Rules and Usages of the Order?

R. S.—*He has*, Chief Ranger.

(The C.R. must postpone the initiation if the Candidate has not been examined by the Court Physician or other duly authorized examining Physician and recommended by him to the Court on Form No. 59 for beneficiary membership, or, in the absence of such recommendation, if his medical examination has not been accepted and passed by the Medical Board. The Chief Ranger, or any officer or member acting as Chief Ranger, who administers the Obligation to a candidate before he has been examined by the Court Physician or other duly authorized examining Physician and recommended by him to the Court, on Form No. 59, for beneficiary membership, or before his medical examination has been accepted and passed by the Medical Board, as the case may be, shall *ipso facto* stand suspended from the Order.)

C. R.—Thank you, Recording Secretary. If there be any valid objection to the admission of——— into this Court, let it now be declared.

(If an objection be made by any member, the Court must decide at once, without debate, by a majority vote, whether it is valid or not. If the objection be held valid, then the Initiation must be postponed and the objection duly considered at the same or at the next meeting. If the objection be held not valid, or if no objection be offered, the Initiation will be immediately proceeded with, as follows:)

C. R.—There being no valid objection to the Initiation of the *Candidate* the Past Chief Ranger and the Financial Secretary will retire to the ante-room and see that all the conditions required by the Constitution and Laws, Rules and Usages of the Order are duly complied with by the *Candidate*.

(The Past Chief Ranger will put the following questions to the Candidate in the ante-room, and if the answers be satisfactory will so report to the Court on returning thereto:)

P. C. R.———, it is my duty to ask you certain preliminary questions, but before doing so, I beg to assure you that there is nothing in the Obligation or Constitution and Laws of the Independent Order of Foresters which in any way interferes with the religious, political or social rights or duties of its members. The discussion of political or religious subjects is not permitted within our Court Rooms. Our aim is to afford each other mutual aid and relief, as well as the protection for our loved ones which is given by the Order. Having made these explanations you will please answer the following questions:

(1) **P. C. R.**—What is your profession, trade or occupation? You will please describe it fully.

Candidate— { The Candidate must give full particulars stating the nature of the profession, trade or occupation followed, with such exactitude and detail as to make it perfectly clear what the duties are which are attached to such profession, trade or occupation. }

P. C. R.—I beg to inform you that your present occupation will place you in the —— Class; (or, I regret to inform you that your present occupation is proscribed by our laws, and you cannot be admit-

ted to membership. You will therefore be good enough to retire).

(Persons engaged in the occupations proscribed in the Constitution and Laws, or who are engaged in the manufacture or sale of intoxicating liquors, or in occupations that have been scheduled as specially dangerous, cannot be admitted to membership in the Order. If the candidate be admissible the P.C.R. will proceed as follows :)

(2) **P.C.R.**—Have you, since your medical examination for admission to our Order, been under medical treatment of any kind, or taken medicine, or consulted any physician on account of any disease or ailment ?

Candidate—I have not. (If otherwise the Candidate must give particulars which must be reported to the Court by the P.C.R.)

(3) **P.C.R.**—Are you to the best of your knowledge, at the present time, in good, sound mental and physical health ?

Candidate.—I am.

(4) **P.C.R.**—Do you believe in the existence of a Supreme Being, the Ruler and Governor of the Universe ?

Candidate.—I do.

(5) **P.C.R.**—Do you agree to keep inviolate any unwritten or other private work of the Order which may be communicated to you and that you will be governed and bound by the Constitution and Laws, Rituals, Rules and Usages of the Independent Order of Foresters ?

Candidate—I do.

(6) **P.C.R.**—Do you agree for yourself and in behalf of your heirs and beneficiaries, in the event of your ceasing at any time to be a member of the Order “in good standing” as defined in the Constitution and Laws of the Order, that all your rights,

title or claim to, or interest in any property, funds, privileges or benefits of this Court, or of The Supreme Court, shall thereby terminate and become absolutely null and void?

Candidate.—I do.

(The Financial Secretary will then collect the balance, if any, of the Initiation and other Fees; after which the two officers will return to the Court Room and report. They will re-enter the Court Room just as an ordinary member does, by giving the proper signals, etc.)

P.C.R.—Chief Ranger, the *Candidate* has answered satisfactorily all the questions. (If the applicant is entering as a beneficiary member.)

— gives *his* occupation as —, and I informed *him* that *he* would be rated in the — Class.

(The occupation of each Candidate must be reported and the Class in which each will be rated entered in the Minutes of the Court; or if the occupation is proscribed it must be so reported to the Court and likewise entered in the Minutes by the Recording Secretary.)

C.R.—Thank you, Past Chief Ranger.

F.S.—Chief Ranger, the *Candidate* has paid the required fees.

C.R.—Thank you, Financial Secretary. The Senior and Junior Woodward's will now repair to the ante-room, and introduce the *Candidate* for Initiation.

(The Woodward's will retire, and as soon as ready the S. W. will give three loud knocks at the inner door.)

S.W.—●●●

S.B.—Vice Chief Ranger, there is an alarm at the inner gate.

V.C.R.—Ascertain the cause of the alarm.

(The Senior Beadle will then give three loud knocks upon the door and open the wicket and, having ascertained that the S.W. and the Candidate were seeking admission to the Court, will close the wicket and report to the Vice Chief Ranger.)

S.B.—●●●—Who comes there to disturb the harmony of our Camp?

J. B.—The Woodwards with *a stranger* who was captured in the outskirts of our Camp and who expresses a desire to become a Forester.

S. B.—Vice Chief Ranger, the alarm was caused by the Woodwards who ask for the admission of *a stranger* by whom a desire to become *a Forester* has been expressed.

V. C. R.—Chief Ranger, the Woodwards are at the inner gate. They desire admission for *a stranger* who *wishes* to become *a Forester*.

[C. R.—Let them be admitted and the *stranger* presented to the Vice Chief Ranger for instruction.

V. C. R.—Senior Beadle, by command of the Chief Ranger you will admit the Woodwards and direct them to present the *Stranger* to the Vice Chief Ranger for instruction.

S. B.—●●● (^{Opens the door.}) Senior Woodward, by command of the Chief Ranger you are permitted to enter the Court Room with the *Stranger*, whom you will present to the Vice Chief Ranger for instruction.]

(The Senior Beadle will then throw the inner door wide open and the Woodwards and Candidate will enter and proceed in a slow march around the room. As the Candidate enters, the Chief Ranger will proceed with the Initiation as set forth in pages 61 to 85. If the Court has no singers the "Glorys" on page 72 will be said by the Past Chief Ranger and the Officers and Members will respond with the "Amens.")

If it be desired to omit the charges, instead of saying the words above within the heavy brackets, the Chief Ranger will proceed as follows :

C. R.—Let them be admitted and, after hearing the words of the Orator, the Woodwards will present the *Stranger* at the Pedestal.

V. C. R.—Senior Beadle, by command of the Chief Ranger you will direct the Woodwards, after hearing the words of the Orator, to present the *Stranger* at the Pedestal.

S.B.— ●●● (Opens the door.) Senior Woodward, by command of the Chief Ranger you are permitted to enter the Court room with the *Stranger*, whom you will present at the Pedestal after he has heard the words of the Orator.

(The Candidate will be conducted slowly around the room, and as soon as the Orator has read the Ten Commandments the Woodwards will present the Candidate at the Pedestal and the Ceremony will proceed as follows :)

C.R.—The Court will assist me to confer the Obligation on the *Candidate*.



(The Chief Ranger will take position at the side of the Pedestal opposite the Candidate. The Past Chief Ranger and Orator will take positions at the other two sides of the Pedestal, while the Vice Chief Ranger will stand immediately to the right of the Candidate and at the proper time flash the Great Symbolic Light.)

S.W.—Chief Ranger, I beg to present to you ———, who is a *Candidate* for admission to our Order.

C.R.— ———, your membership in this Order is contingent upon your being in perfect health, therefore it is my duty to inquire whether you are at the present time under medical treatment of any kind, or taking medicine for any disease or ailment.

Candidate.—I am not.

C.R.—Then I am to understand that you are at the present time in good, sound mental and physical health?

Candidate.—I am.

(If the Candidate be under treatment of any kind, or is taking medicine for any disease or ailment, or is otherwise not in perfect health at the time of the Initiation the ceremony must be postponed until the Candidate has been restored to perfect health; but if he be in good, sound mental and physical health, the ceremony will be proceeded with as follows:

C. R.—*The* (or *Each*) Candidate will place *his* right hand over *his* heart, as a token of sincerity, raise *his* left hand heavenward, as a pledge of fidelity, and say "I," pronounce *his* own name in full, and repeat after me our solemn obligation.

THE OBLIGATION.

1 I, (*name in full*) | of my own free will and
 2 accord, | do solemnly and sincerely promise |
 3 that I will never reveal | any word, | sign, |
 4 grip | or token, | or any unwritten | or other
 5 private work | of the Independent Order of
 6 Foresters, | which shall now | or may hereafter |
 7 be communicated to me, | to any one in the
 8 world | unless it be to a member | in good stand-
 9 ing | who is authorized | by the Rules and Usages
 10 of the Order | to receive the same.

11 I also promise | to do all that lies in my power |
 12 to alleviate the needs, | protect the honor | and
 13 advance the welfare | of the members of this
 14 Order.

15 I further promise | to bear true allegiance | to
 16 The Supreme Court | and to be governed | by its
 17 Constitution and Laws, | Rules and Usages, |
 18 now in force | or which it may hereafter enact |
 19 or establish.

20 Lastly I promise | that, should I ever cease |
 21 to be a member of the Order, | my obligation of
 22 secrecy | shall remain binding | and in full force.

23 For the faithful observance | of all these prom-
 24 ises | I hereby pledge | my sacred honor.

C. R.—Woodwards, you will now conduct the *Candidate* to the Financial Secretary, who will enter *his name* on the membership roll of this Court; after which you will present *him* to me for further instructions.

(After the Candidate has been duly enrolled by the F.S., he will be presented to the C. R., as follows:)

S. W.—Chief Ranger, I present to you the newly obligated *Candidate*, who *has* been duly enrolled as a *member* of this Court.

I will now instruct you in the unwritten work of the Order.

FIRST SECTION.

The first sign is called the **ENTERSIGN**, and is given thus ☞

THE **COUNTERSIGN**, or answer to it, is given thus ☞

THE **SEA SIGN**, or **SIGN OF DISTRESS**, is given thus ☞

THE **COUNTERSIGN**, or answer to it, is given thus ☞

THE **WORDS OF DISTRESS** are as follows ☞

THE **TRAVELLING SIGN**, or **SIGN OF RECOGNITION**, is given thus ☞

THE **COUNTERSIGN**, or answer to it, is given thus ☞

THE **WARNING SIGN AND DANGER SIGNAL** are given thus ☞.

THE **TOKEN** is given thus ☞

The answer to the **TOKEN** is ☞

THE **VOTING SIGN** is given thus ☞

THE **GRIP** is given in this manner ☞

THE **GAVEL** in the hands of the Officers conveys a certain meaning to the Court. In the hands

of the Chief Ranger, *three* raps call up the whole Court; *two* raps seat the Court; *one* rap calls to order. In the hands of the Vice Chief Ranger, *one* rap calls to order; *two* raps, in answer to the alarm at the inner door, is an order to the Senior Beadle to attend to the alarm.

SECOND SECTION.

To enter a Court Room while a Court is in session proceed as follows:

At the outer door give any usual alarm, such as knocking or ringing the bell, the same as at the door of a neighbor. If required by the officer in charge, give the Permanent Password, or letter it with *him* as *he* may wish. The Permanent Password is _____. This will admit you to the ante-room. There clothe yourself in proper regalia. At the inner door give _____, and to the officer in charge give the current Semi-Annual Password, which is _____. This will admit you to the Court Room. Advance to the centre of the room, below the Pedestal, and, facing the Past Chief Ranger, give the *Entersign*, at the same time saying "Past Chief Ranger." *He* will answer you by giving the *Countersign*, upon which you will take your seat.

If not in order for you to be admitted at the moment of giving the alarm at the inner door, (and it is not in order for you to be admitted during the Opening, Closing or Initiatory Ceremony), the Senior Beadle will answer your alarm by giving _____ on the door, in which case it will be your duty to wait; and, as soon as the Ceremony for which you are thus detained is completed, the Senior Beadle

will open the wicket, then you will advance and give the proper Password and you will be admitted to the Court Room.

If you are visiting a Court, at the inner door give, in addition to the Semi-Annual Password, your name, the name and number of your Court and your rank, if any, in the Order.

If you desire to address the Court, rise in your place and face the Presiding Officer and give the *Token*, at the same time saying, "Chief Ranger;" and, when you have received the answer to the *Token* from the Chief Ranger, proceed with your remarks.

Whenever you cross the room from one side to the other, unless you are an officer entitled to a seat on the Dais, cross below the Pedestal and when in front of the Chief Ranger, turn towards *him* and give the *Entersign* simply, without saying "Chief Ranger."

If you desire to retire before the Court has regularly closed, proceed to the "Saluting point"—just below the Pedestal—turn toward the Past Chief Ranger and give the *Entersign* and say, "Past Chief Ranger, permit me to retire." The Past Chief Ranger, if it is proper for you to retire then, will answer you by giving the *Countersign*, at the same time saying, "Senior Beadle, permit the *brother* to retire," upon which you will retire without further ceremony.

THIRD SECTION.

The HONORS to visitors of rank are given as follows, the Court in each case being called up:

To CHIEF RANGERS AND PAST CHIEF RANGERS, each member will give the Old Sign of Recognition, thus ☉

TO DEPUTIES OF THE SUPREME CHIEF RANGER AND OF A HIGH CHIEF RANGER, each member will assume the attitude of initiation, thus ☉

TO OFFICERS OF A HIGH COURT, the Old Sign of Recognition and the Entersign are given together, thus ☉

TO AN OFFICER OF THE SUPREME COURT, other than the Supreme Chief Ranger, each member will give the Supreme Court Salutation, thus ☉

TO THE SUPREME CHIEF RANGER, each member will give the Royal Salute, thus ☉

These constitute the unwritten work of the Subordinate and Companion Court Degree.

Brother (Companion), I am now authorized to address you by that term and in

LIBERTY, BENEVOLENCE AND CONCORD,

to extend to you a hearty welcome into our noble Order. You have bound *yourself* to us by a tie which all upright persons reverence and respect, and a violation of which will carry with it its own punishment. It becomes you, therefore, from the present hour, to honor our principles by an unblemished course of life, honorable dealing and conscientious uprightness, whereby you will reflect credit upon your own personal character, and add to the stability of an Order with whose progress and prosperity your own interests are now identified. You are now entitled to receive free of cost a copy of the

CONSTITUTION AND LAWS OF THIS ORDER,

and it is your duty forthwith to obtain such copy from the Recording Secretary of this Court. Study

well their provisions, for you will find that, not only your duties as a Forester, but your rights and privileges in the Order, are therein clearly set forth.

I take pleasure in decorating you with this Forestric Emblem. You will observe that the predominating color thereon is PURPLE, the fourth Color of the Order.

This COLOR has, from the earliest ages, been reserved to distinguish Royal and Noble personages.

Let your deeds of Benevolence and your works of Charity, as well as your unswerving fidelity to truth and justice, be your patents of nobility, and so win the right, as a Forester, to wear THE PURPLE.



Now by the authority vested in me by the Constitution and Laws of the Order, I proclaim you a Forester, and entitled to all the rights and privileges of membership in our beloved Order.

The Woodwards will escort our *Brother* (*Companion*) to a seat in the Court Room.



SECOND

INITIATION



CEREMONY

WITH THE R.R.R.

C.R.—Senior Woodward, you will retire to the ante-room and ascertain if there be any *Candidates* waiting to be initiated; and, if so, report their names in full to the Court.

(The S.W. will then retire, and if there be any candidates, he will, upon returning to the Court, report their names in full to the Court.)

C.R.—Recording Secretary, *has the Candidate* been duly proposed and regularly elected for membership in our Order?

(As soon as the C.R. addresses the R.S., the latter will rise in his place and remain standing until he has answered the questions.)

R.S.—*He has, Chief Ranger.*

C.R.—*Has the Candidate* been duly examined by the Court Physician and recommended by him to the Court, on Form No. 59, for beneficiary membership, and have you received that Form?

R.S.—I have received Form No. 59, fully and properly filled up, for ——— (*give name*), and ——— *has* already been accepted by the Medical Board.

C.R.—*Has the Candidate* complied with all the other requirements of the Constitution and Laws, Rules and Usages of the Order?

R.S.—*He has, Chief Ranger.*

(The C.R. must postpone the initiation if the Candidate has not been examined by the Court Physician or other duly authorized examining Physician and recommended by him to the Court on Form No. 59 for beneficiary membership, or, in the absence of such recommendation, if his medical examination has not been accepted and passed by the Medical Board. The Chief Ranger, or any officer or member acting as Chief Ranger, who administers the obligation to a candidate before he has been examined by the Court Physician or other duly authorized examining Physician and recommended by him to the Court, on Form No. 59, for beneficiary membership, or before his medical examination has been accepted and passed by the Medical Board, as the case may be, shall *ipso facto* stand suspended from the order.)

C.R.—Thank you, Recording Secretary. If there be any valid objection to the admission of _____ into this Court, let it now be declared.

(If an objection be made by any member, the Court must decide at once, without debate, by a majority vote, whether it is valid or not. If the objection be held valid, then the Initiation must be postponed and the objection duly considered at the same or at the next meeting. If the objection be held not valid, or if no objection be offered, the Initiation will be immediately proceeded with, as follows:)

C.R.—No valid objection having been declared the Past Chief Ranger and the Financial Secretary will retire to the ante-room and see that all the conditions required by the Constitution and Laws, Rules and Usages of the Order are duly complied with by the *Candidate*.

(The Past Chief Ranger will put the following questions to the Candidate in the ante-room, and if the answers be satisfactory will so report to the Court on returning thereto:)

P.C.R.— _____, it is my duty to ask you certain preliminary questions, but before doing so, I beg to assure you that there is nothing in the Obligation or Constitution and Laws of the Independent Order of Foresters which in any way interferes with the religious, political or social rights or duties of its members. The discussion of political or religious subjects is not permitted within our Court Rooms. Our aim is to afford each other mutual aid and relief, as well as the protection for our loved ones which is given by the Order. Having made these explanations you will please answer the following questions:

(1) **P.C.R.**—What is your profession, trade or occupation? You will please describe it fully.

Candidate— {The Candidate must give full particulars stating the nature of the profession, trade or occupation followed, with such exactitude and detail as to make it perfectly clear what the duties are which are attached to such profession, trade or occupation. }

P. C. R.—I beg to inform you that your present occupation will place you in the——Class; (*or*, I regret to inform you that your present occupation is proscribed by our laws, and you cannot be admitted to membership. You will therefore be good enough to retire).

(Persons engaged in the occupations proscribed in the Constitution and Laws or who may be engaged in the manufacture or sale of intoxicating liquors or in occupations that have been scheduled as specially dangerous, cannot be admitted to membership in the Order. If the Candidate be admissible, the P. C. R. will proceed as follows :)

(2) **P. C. R.**—Have you, since your medical examination for admission to our Order, been under medical treatment of any kind, or taken medicine, or consulted any physician on account of any disease or ailment?

Candidate.—I have not. (If otherwise, the Candidate must give particulars which must be reported to the Court by the P. C. R.)

(3) **P. C. R.**—Are you to the best of your knowledge, at the present time, in good, sound mental and physical health?

Candidate.—I am.

(4) **P. C. R.**—Do you believe in the existence of a Supreme Being, the Ruler and Governor of the Universe?

Candidate.—I do.

(5) **P. C. R.**—Do you agree to keep inviolate any unwritten or other private work of the Order which may be communicated to you and that you will be governed and bound by the Constitution and Laws, Rituals, Rules and Usages of the Independent Order of Foresters?

Candidate.—I do.

(6) **P. C. R.**—Do you agree for yourself and in behalf of your heirs and beneficiaries, in the event of your ceasing at any time to be a member of the Order “in good standing” as defined in the Constitution and Laws of the Order, that all your rights, title or claim to, or interest in any property, funds, privileges or benefits of this Court, or of The Supreme Court, shall thereby terminate and become absolutely null and void.

Candidate.—I do.

(The Financial Secretary will then collect the balance, if any, of the Initiation and other fees; after which the two officers will return to the Court Room and report. They will re-enter the Court Room just as an ordinary member does, by giving the proper signals, etc.)

P. C. R.—Chief Ranger, the *Candidate* has answered satisfactorily all the questions. (If the applicant is entering as a beneficiary member.)
 — gives *his* occupation as —, and I informed *him* that *he* would be rated in the — Class.

(The occupation of each Candidate must be reported and the Class in which each will be rated entered in the Minutes of the Court; or if the occupation is proscribed it must be so reported to the Court and likewise entered in the Minutes by the Recording Secretary.)

C. R.—Thank you, Past Chief Ranger.

F. S.—Chief Ranger, the *Candidate* has paid the required fees.

C. R.—Thank you, Financial Secretary. The Senior and Junior Woodwards will now repair to the ante-room, and introduce the *Candidate* for Initiation.

(The Woodwards will retire, and as soon as ready the S. W. will give three loud knocks at the inner door.)

S. W.—●●●

S. B.—Vice Chief Ranger, there is an alarm at the inner gate.

V. C. R.—Ascertain the cause of the alarm.

(The Senior Beadle will then give three loud knocks upon the door and open the wicket and, having ascertained that the S.W. and the Candidate were seeking admission to the Court, will close the wicket and report to the Vice Chief Ranger).

S. B.—●●●—Who comes there to disturb the harmony of our Camp?

J. B.—The Woodwards with *a stranger* who was captured in the outskirts of our Camp.

S. B.—Vice Chief Ranger, the alarm was caused by the Woodwards who ask for admission to our Court. They are accompanied by *a stranger* whom they captured in the outskirts of our Forest.

V. C. R.—Chief Ranger, the Woodwards are at our inner gate with *a stranger* whom they captured in the outskirts of our Forest.

C. R.—Let the *Stranger* be admitted, under proper escort.

V. C. R. Senior Beadle, by command of the Chief Ranger, the *Stranger*, under proper escort, is permitted to enter our Court Room.

(The Senior Beadle will again give three loud knocks on the door, then throw it wide open and proceed as follows:)

S. B.—●●●—(opens the door.) By command of the Chief Ranger, the *Stranger*, under proper escort, is permitted to enter our Court Room.

(As the Candidate is entering the Court Room the Chief Ranger will proceed as follows:)



C. R.—Hear ye and give heed to the words of the Orator.

(The Woodwards will conduct the candidate very slowly around the Court Room outside of the R. R. R. while the Orator reads the Ten Commandments.)

Orator.—And God spake all these words saying, I am the Lord thy God, which have brought thee out of the land of Egypt, out of the house of bondage.

I. Thou shalt have no other Gods before me.

II. Thou shalt not make unto thee any graven image, or any likeness of anything that is in heaven above, or that is in the earth beneath or that is in the water under the earth; thou shalt not bow down thyself to them nor serve them; for I the Lord thy God am a jealous God, visiting the iniquity of the fathers upon the children unto the third and fourth generation of them that hate me; and showing mercy unto thousands of them that love me and keep my commandments.

III. Thou shalt not take the name of the Lord thy God in vain; for the Lord will not hold him guiltless that taketh His name in vain.

IV. Remember the Sabbath Day to keep it holy. Six days shalt thou labor and do all thy work; but the seventh day is the Sabbath of the Lord thy God; in it thou shalt not do any work, thou nor thy son nor thy daughter, thy man-servant nor thy maid-servant, nor thy cattle, nor the stranger that is within thy gates. For in six days the Lord made heaven and earth, the sea, and all that in them is, and rested

the seventh day; wherefore the Lord blessed the Sabbath Day, and hallowed it.

V. Honor thy father and thy mother; that thy days may be long upon the land which the Lord thy God giveth thee.

VI. Thou shalt not kill.

VII. Thou shalt not commit adultery.

VIII. Thou shalt not steal.

IX. Thou shalt not bear false witness against thy neighbor.

X. Thou shalt not covet thy neighbor's house, thou shalt not covet thy neighbor's wife, nor his man-servant, nor his maid-servant, nor his ox, nor his ass, nor anything that is thy neighbor's.

All the Members.—Amen! Amen! Amen!

(The "Amens" may be said or sung. If sung the following notes may be used :)



[The following Ode may be sung as soon as the Orator has finished reading the Ten Commandments, and when the singing has ended the Vice Chief Ranger will challenge. If the Ode be not sung the Vice Chief Ranger will challenge as soon as the Ten Commandments are read by the Orator.]

St. Oswald, 8, 7.

Cou - rage, stranger, do not stumble, Though thy path be
Let the road be rough and dreary And its end far

dark as night; There's a star to guide the hum - ble -
out of sight; Foot it brave - ly! strong and weary -

Trust in God and do the right.
Trust in God and do the right.

V.C.R.—Halt! I demand of you the countersign and pass.

(If there be more than one Candidate the V.C.R., after challenging and getting no response, will say "Stand aside!" and proceed to challenge the other Candidates. If there be only one Candidate, or when the last Candidate has been challenged, the V.C.R. will continue as follows:)

V.C.R.—What! Have you not the countersign and pass? You must be a spy; Woodward's seize

this stranger and conduct *him* to our Chief Ranger for sentence.

(The brethren will then commence making a noise, running to and fro, exclaiming, "A spy! A spy! Hang the spy!" etc. The Woodwards will then seize the Candidate, one on each side, and conduct him once over the R.R.R., carefully protecting him from injury of any kind, thence to the Pedestal. If there be more than one Candidate, the Chief Ranger must appoint *two* members to assist *each* additional Candidate in like manner over the R.R.R. If the R.R.R. has been dispensed with, the Woodwards will conduct the Candidate to the Pedestal, as soon as the Orator has done reading the Commandments, when all present form a circle around him, except the Woodwards, C.R., P.C.R., V.C.R. and Orator, who stand within the circle on the four sides of the Pedestal, the C.R. facing the Candidate and the V.C.R. standing immediately to the right of the Candidate.)

V.C.R.—Chief Ranger, I have to report that *this stranger* was captured by the Woodwards in the outskirts of our Forest, and brought within our Camp. I demanded of *him* the countersign and pass, but *he* was unable to give them. Fearing that *he* might be *a spy*, I ordered *him* to be secured and conducted to your presence.

C.R.—Vice Chief Ranger, you did well. Let the *Captive* be taken to the place of execution and there suffer the penalty due to *a spy*.

(The brethren again cry out excitedly, "Hang him! Hang the spy!" etc.)

P.C.R.—Silence! Chief Ranger, I have just recognized the *Stranger* and I beg to assure you that *this captive* is not *a spy*, but having heard of the noble deeds of the Foresters in protecting the Widows and Orphans as well as the weak and oppressed, made due application for membership, came into the outskirts of our Forest and beckoned to the Senior Woodward, that through him *he* might gain ad-

mission to our Camp and be made a Forester. I am willing to give my pledge for *him*.

C. R.—Past Chief Ranger, I accept the pledge, and if *he* prove unworthy your life shall be the forfeit.

C. R.—Captive *Stranger*, by what qualifications do you seek admission to our ranks?

P. C. R.—(*Answering for the Candidate.*) By being sincerely desirous of assisting you in your benevolent work, and being of sound physical health, and of good report.

C. R.—Captive *Stranger*, you have heard the Past Chief Ranger in your behalf. Has he truthfully answered for you?

Captive.—He has.

C. R.—I request of you your *name* in full.

Captive.—(*Gives his name in full.*)

C. R.—Vice Chief Ranger, *this name* has already been reported in our Forest Home as well worthy to be inscribed upon the Honor Roll of the Independent Order of Foresters. You will, therefore, loosen the *Captive's* bonds and restore *him* to light and liberty.

(The Captive's bonds will then be loosened and the blindfold taken off.)

C. R.—Mr.———, I congratulate you upon having escaped a great danger, through good report. Let this incident ever remind you that a good name is to be prized above all earthly possessions, and let it also be a lesson to you ever to look with Charity upon the shortcomings of your fellow-men, and

never to condemn anyone, especially a Brother, unheard and without affording him the most ample opportunity of vindicating himself. Let me further assure you that nothing which has been done here is without a purpose and signification. The road over which you have just passed is intended to remind you that the path through the forest of this life, at best, is a rough, rugged road, and full of unseen dangers; and as you would undoubtedly have met with serious mishaps, and perhaps fallen by the way, had you not been guided and assisted by trusty friends, so in the journey of life, if assisted by patience in adversity, persistence in rectitude of action, and guided by the Divine rule, "Do unto others as ye would they should do unto you," you will triumph over all obstacles, and finally obtain the reward of the faithful—the approbation of an all-wise and merciful Supreme Chief, our Father in Heaven. You will now be conducted to the Vice Chief Ranger for instruction.

(The Initiation Ceremony will be continued as laid down in the third Initiation Ceremony, commencing at the bottom of page 62 and ending on page 85, omitting, of course, all references to the Guard of Honor. If, however, it is desired to omit the Charges of the Vice Chief Ranger, and the Past Chief Ranger, the Chief Ranger, instead of saying "You will now be conducted to the Vice Chief Ranger for instruction," will direct that the Candidate be conducted to the pedestal, as follows:)

[C.R.--The Woodwards will now conduct the Candidate to the Pedestal, there to take the solemn Obligation of the Order.]

(The Ceremony will then proceed as laid down in the Third Initiation Ceremony, commencing at the bottom of page 69 and ending on page 85. If, however, it be desired to omit the Charge of the Standard Bearer (which in this Ceremony will be given by the Orator), after the Orator has invoked the blessing and the Chief Officers have retired to their stations as laid down on page 73, the Chief Ranger will take up the Ceremony at the top of page 76 and it will proceed to the end on page 85.)

RITUAL

— FOR —

SUBORDINATE AND COMPANION COURTS

(WITH THE GUARD OF HONOR.)

OPENING



CEREMONY

[NOTE.—The station of the Chief Ranger must always be regarded as the *north* or upper end of the room; the Past Chief Ranger the *east*, the Vice-Chief Ranger the *south* or lower end of the room and that of the Orator the *west*. The *right* side in the Court Room is to the right hand side of the Chief Ranger, or the *west* side of the Court Room; and the *left* side is the left hand side of the Chief Ranger, or the *east* side of the Court Room. *Front* is towards the Chief Ranger's station.]

THE GUARD OF HONOR.

(The regular Guard of Honor shall consist of the Captain of the Guard, Standard Bearer, four or more Lancers and the two Woodward's, two Beadles and an Organist. The Lancer next to the Captain shall be considered to be the Senior Lancer and the one next to the Standard Bearer the Junior Lancer. The starting point of the Captain and Standard Bearer or other leaders of the Guard in each movement of the Guard is indicated by a cross in the various Diagrams. The words of command may be dispensed with altogether at the option of the Captain.

When the hour arrives for opening the Court, the Senior P.C.R. or in the absence of all P.C.Rs., the Officer next in rank who is present shall act as C.R. and call the Court to order by one rap of the gavel. The officers present in the Court Room will then take their respective stations. The C.R., the J.P.C.R., the V.C.R., the Orator and the Guard of Honor will assemble in the Ante-room.)

Acting C. R.—The Court will please come to order. All who are not members of the Order will please retire.

(If there be any vacancies in the offices, the Acting C.R. will make the necessary *pro tem.* appointments, as follows:)

Acting C. R.—I will appoint Brother (*Companion*)
—— as —— *pro tem.*, etc.

Acting C.R.—The Financial Secretary and Treasurer will see that all present are worthy Foresters.

(The F.S. and T. will advance to the Acting C.R. and give the current S.A.P.W. and then, beginning at the right and left of the Chair, examine all present, of whom they have any doubt, in the current S.A.P.W., except those on the Dais, for whom the Acting C.R. is held responsible. After the examination, the F.S. and T. will report to the Acting C.R. as follows :)

F.S.—Chief Ranger, all present on your right are worthy Foresters.

T.—Chief Ranger, all present on your left are worthy Foresters.

Acting C.R.—Brethren (*Companions*), all present being worthy Foresters, I will ask the Senior Beadle to inform the Captain of the Guard that the Court is now ready to receive its chief officers.

S.B.—^(Gives three knocks on the door and then throws it wide open.) ● ● ● **Captain of the Guard, I am directed by the Acting Chief Ranger to inform you that the Court is now ready to receive its chief officers.**

(The chief officers, escorted by the Guard of Honor, will then enter the Court Room and proceed around the Court Room to the front of the station of the V.C.R. and there halt and face the Pedestal, as indicated in Diagram No. 1. Meanwhile the Guard of Honor will advance towards the Pedestal, as per Diagram No. 1, and halt on each side of the Pedestal.)

OFFICERS SALUTING THE CHAIR.

(When the Guard of Honor turn to the right and left in front of the station of the Vice-Chief Ranger, the Chief Ranger will incline to *his* left, halt in front of the station of the Senior Lancer, the Past Chief Ranger will take position immediately to the right of the Chief Ranger, the Orator to the right of the Past Chief Ranger, and the Vice-Chief Ranger to the right of the Orator. Each of them will halt without word of command and turn and face the Pedestal together. They will stand in line facing the Pedestal, as shown in Diagram No. 2 till the Guard of Honor halt and face inward on either side of the Pedestal, and the Acting Chief Ranger calls up the Court, which is done as soon as the Guard of Honor is halted and faced inward; the officers will then advance in line, four abreast, to the saluting point, as shown in Diagram No. 2, and give the Entersign to the Acting Chief Ranger. The Commands given by the Captain in this ceremony are "Guard, halt! Inward turn!" "Present arms!" The latter command is given as the chief officers start towards the Pedestal.)

RECEPTION OF THE CHIEF OFFICERS.
 DIAGRAM No. 1.

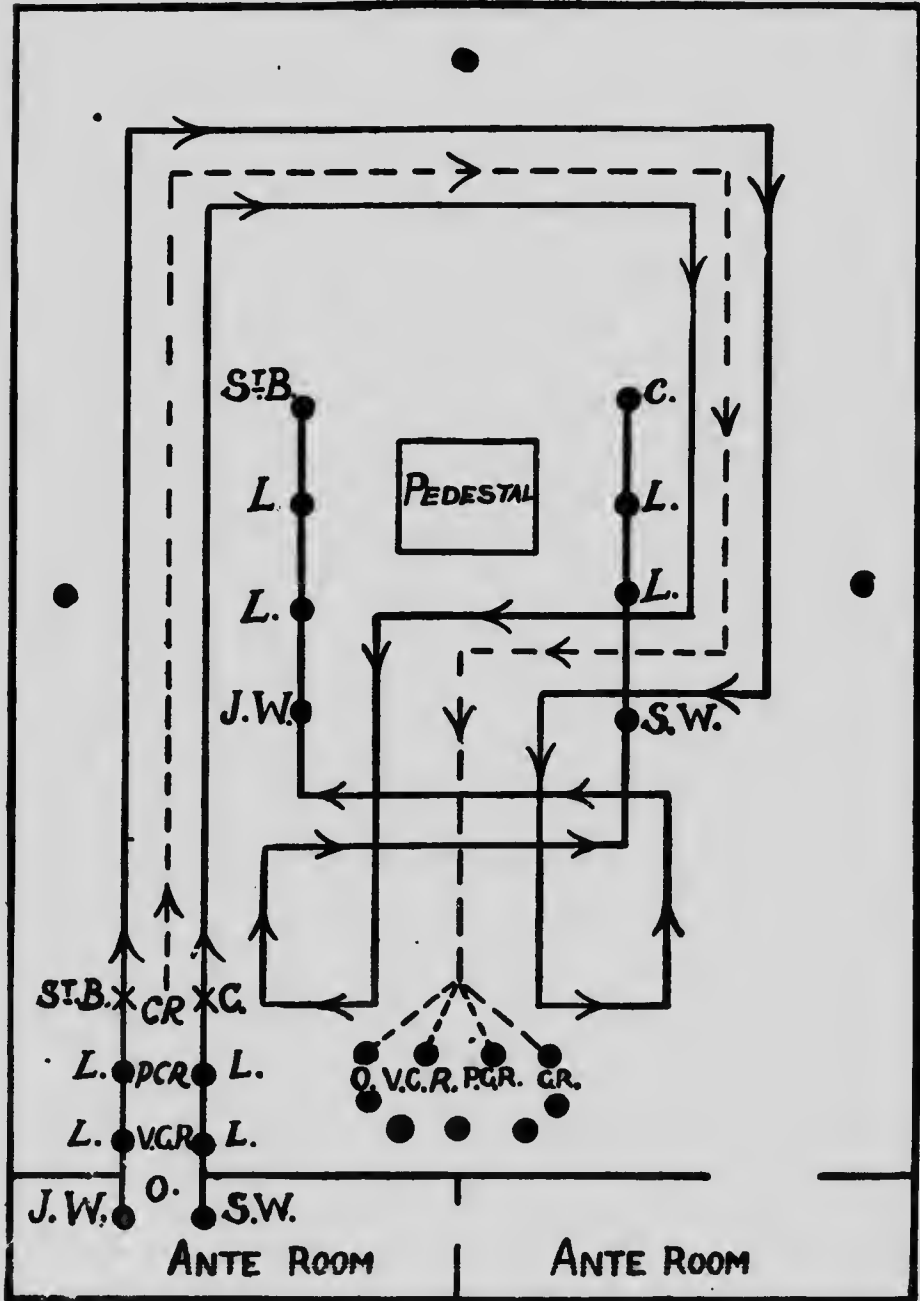

THE CHIEF OFFICERS SALUTE THE CHAIR.
 DIAGRAM No. 2.

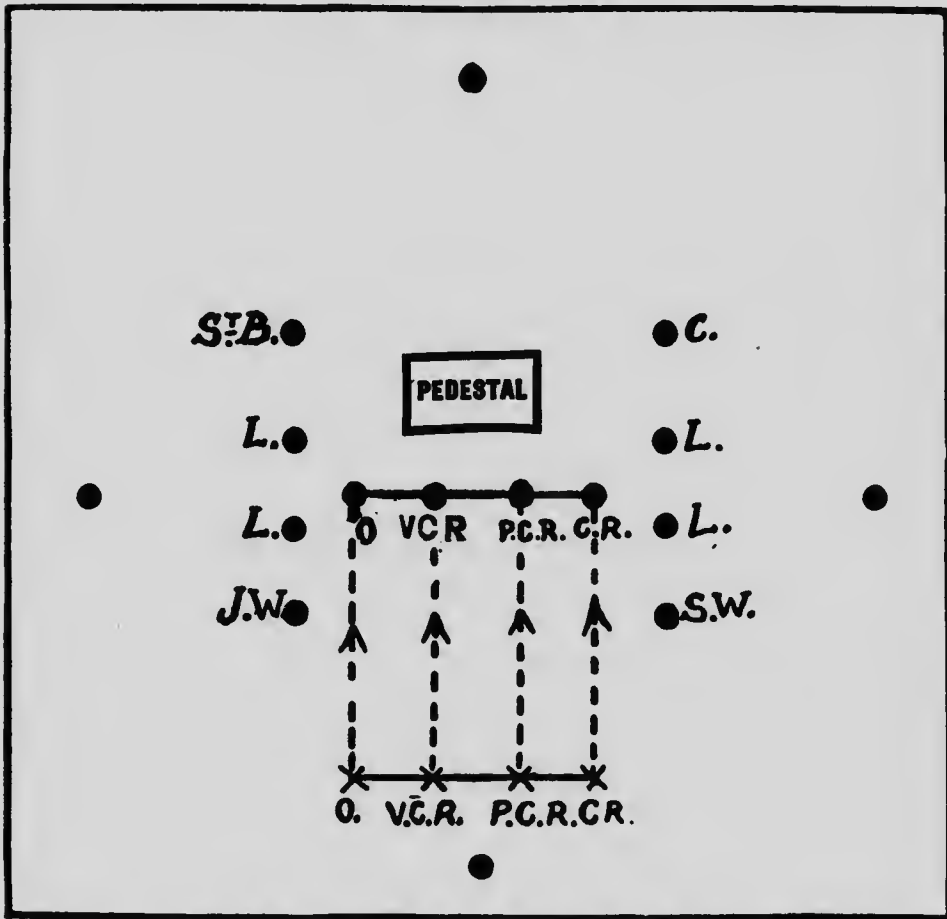

THE WORDS OF COMMAND.

C.G.—Guard, halt! Inward turn!

Acting C.R.—● ● ●

(As soon as the Court is called up the chief officers will march towards the Pedestal and halt in front thereof and salute. The Guard will present arms as the officers begin their march towards the Pedestal.)

C.G.—Guard, present arms!

(When the Acting Chief Ranger has given the *Countersign* in acknowledgment of the *Entersign*, he will seat the Court.)

Acting C.R.—● ●

SEATING THE CHIEF RANGER.

(As soon as the Court has been seated the Captain will give the words of command, "Guard, shoulder arms!" "Right and left turn!" "Quick march!" "Guard, halt!" "Inward turn!" and "Guard, form the Arch of Honor!" At the first words of command the Guard will march as indicated in Diagram No. 3, to the station of the Chief Ranger and halt in two lines about three or four feet apart. As soon as the Guard has halted and faced inward, the Chief Ranger will start, going by the right of the Pedestal and, marching between the lines of the Guard, proceed to *his* station. Just before the Chief Ranger reaches the lines of the Guard they will form the Arch of Honor.)

DIAGRAM No. 3.

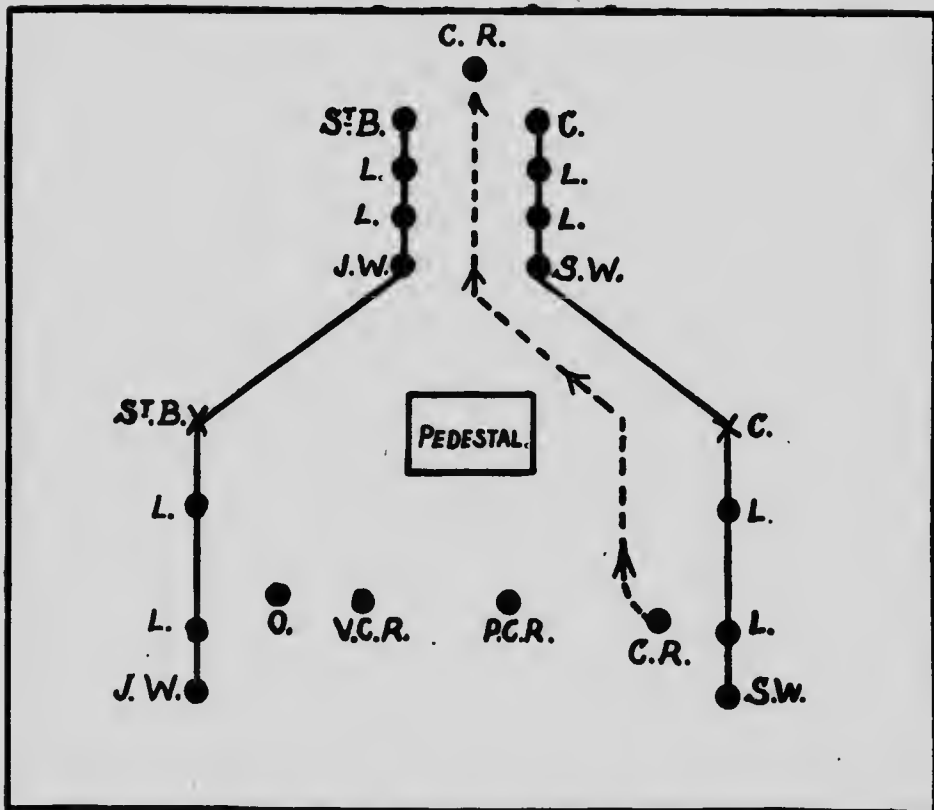

WORDS OF COMMAND.

C. G.—Guard, shoulder arms! Right and left turn! Quick march!

C. G.—Guard, halt! Inward turn!

C. G.—Guard, form the Arch of Honor!

(As soon as the Chief Ranger is seated, the Captain will give the words of command, "Guard, Shoulder arms!" "Right and left turn!" "Quick march!" and the Guard will march as indicated in Diagram No. 4, to the station of the Past Chief Ranger, when the same ceremony will be repeated as for seating the Chief Ranger. The P.C.R., the V.C.R. and the Orator will each start for *his* station immediately after the words of command "Form the Arch of Honor" shall have been given.)

SEATING THE P.C.R.

DIAGRAM No. 4.

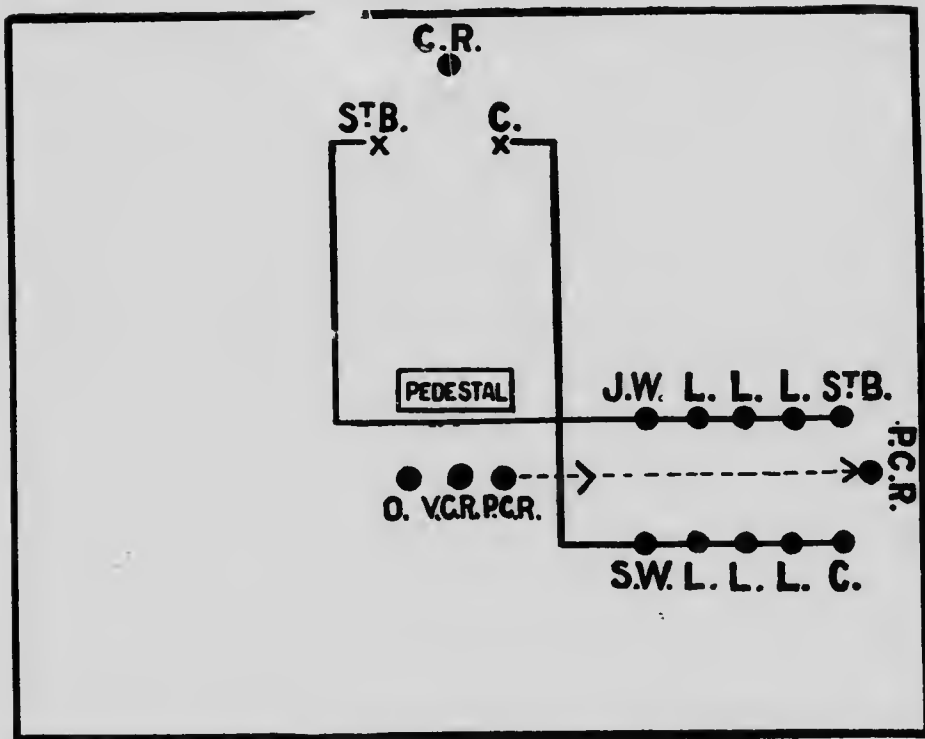

WORDS OF COMMAND.

C.G.—Guard, shoulder arms! Right and left turn! Quick march!

C.G.—Guard, halt! Inward turn!

C.G.—Guard, form the Arch of Honor!

SEATING THE V.C.R.

DIAGRAM No. 5.

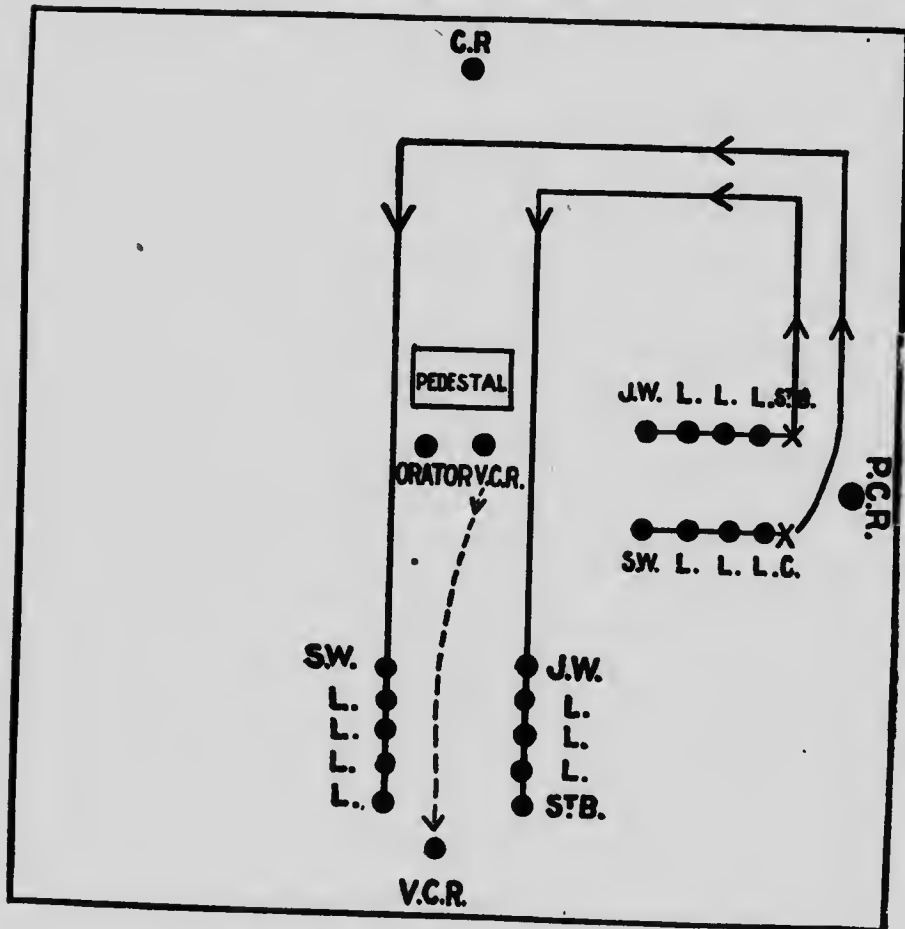

WORDS OF COMMAND.

C.G.—Guard, shoulder arms! Right and left turn! Quick march!

C.G.—Guard, halt! Inward turn!

C.G.—Guard, form the Arch of Honor!

SEATING THE ORATOR.

DIAGRAM No. 6.

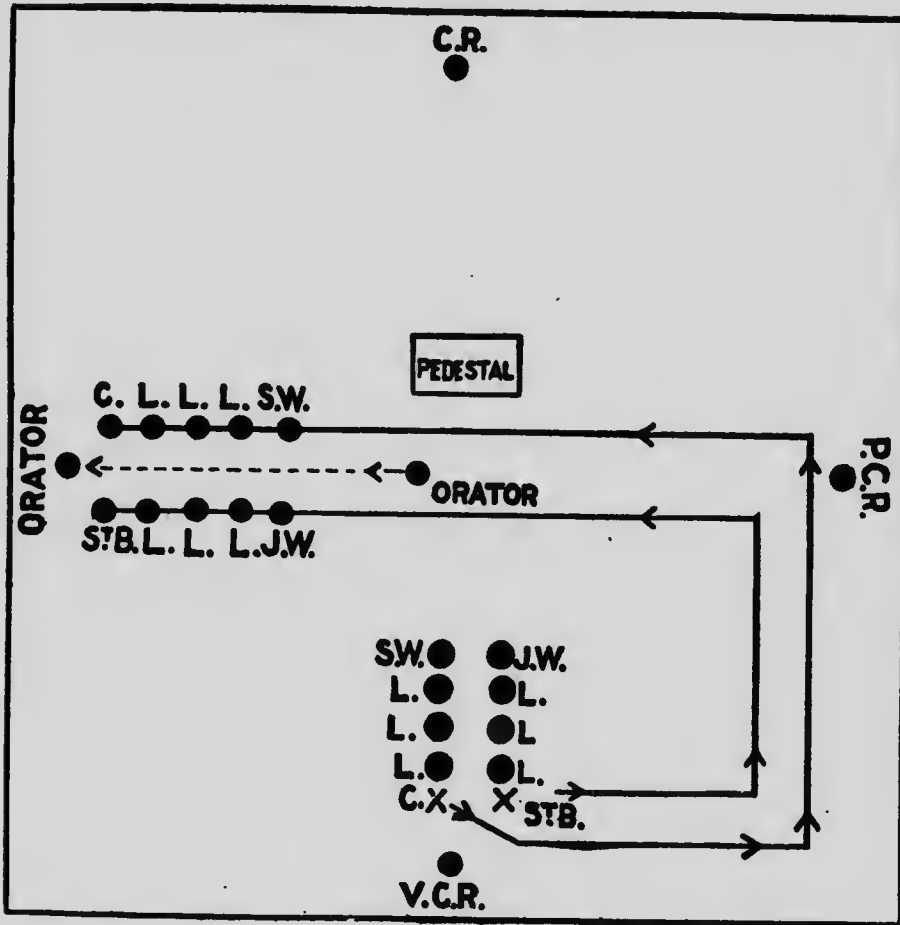

WORDS OF COMMAND.

C. G.—Guard, shoulder arms! Right and left turn! Quick march!

C. G.—Guard, halt! Inward turn!

C. G.—Guard, form the Arch of Honor!

THE GUARD SALUTING THE CHAIR.

(The Guard will march, as indicated in Diagram No. 7, to the Saluting point, just below the Pedestal, and then form up in single line facing the Chief Ranger and give the *Entersign*. The words of command to be given in this movement follow Diagram No. 7.)

DIAGRAM No. 7.

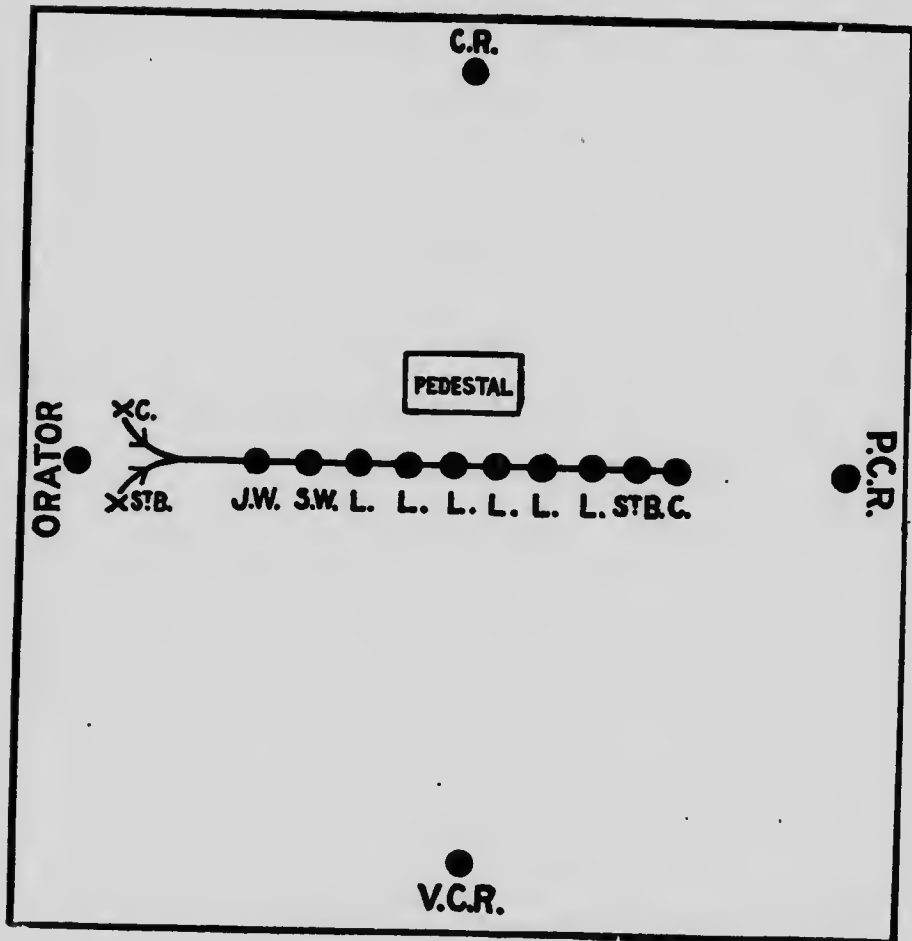

WORDS OF COMMAND.

C. G.—Guard, right and left turn! Quick march!

C. G.—Guard, halt! Front! Dress! Eyes front!

(The Guard will give the *Entersign*.)

SEATING THE WOODWARDS.

(As soon as the Guard have saluted they will march off in single file, as indicated in Diagram No. 8, reforming into double files on turning to the right to march towards the *south* end of the Court Room. When the Guard finally turns towards the *south*, below the Pedestal, the Senior and Junior Woodward will cross over and turn southward and march side by side between the files of the remainder of the Guard to their stations. The Guard will not form the Arch of Honor, but simply halt and face inward. The words of command will be found below Diagram No. 8.)

DIAGRAM No. 8.

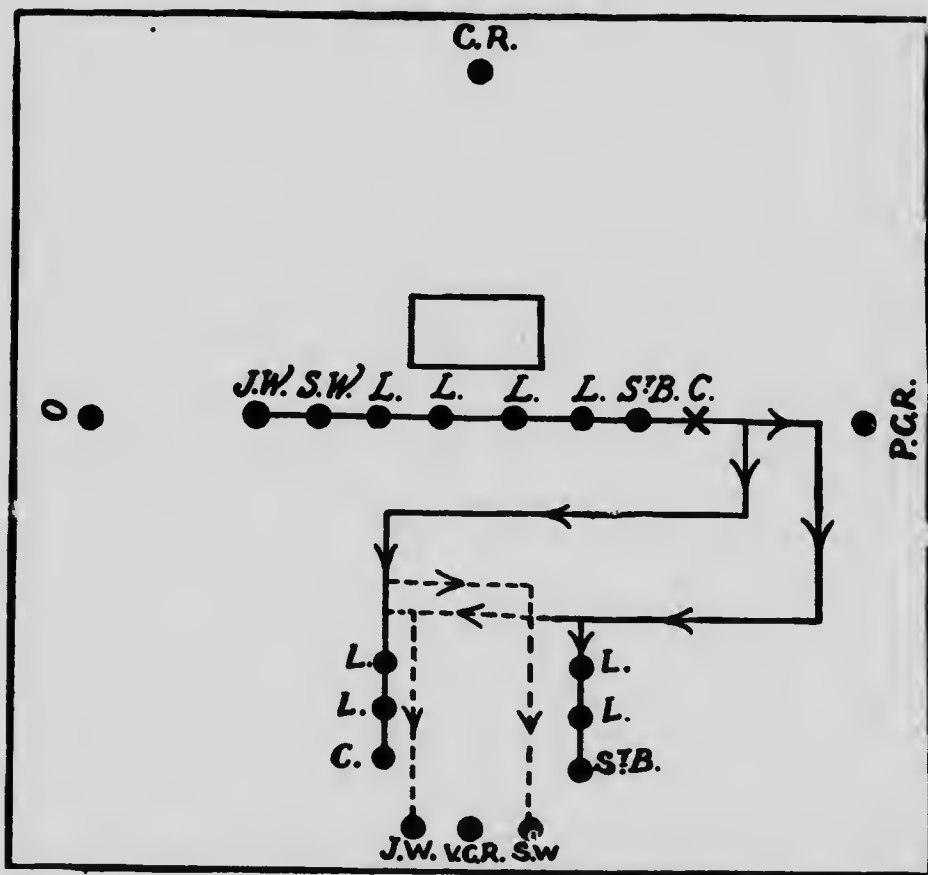

WORDS OF COMMAND.

C.G.—Guard, left turn! Quick march!

C.G.—Guard, halt! Inward turn!

SEATING THE C. AND ST. B.

(As soon as the Senior Woodward and Junior Woodward are seated, the remainder of the Guard will proceed to the stations of the Captain and Standard Bearer, as indicated in Diagram No. 9. When the Guard has reached their respective positions, as indicated in Diagram No. 9, the Senior Lancer will give the words of command, "Guard, halt!" "Inward turn!" The Captain and Standard Bearer will then turn inward and march side by side between the lines of the Lancers to their seats. The words of command to be given in this movement follow Diagram No. 9.)

DIAGRAM No. 9.

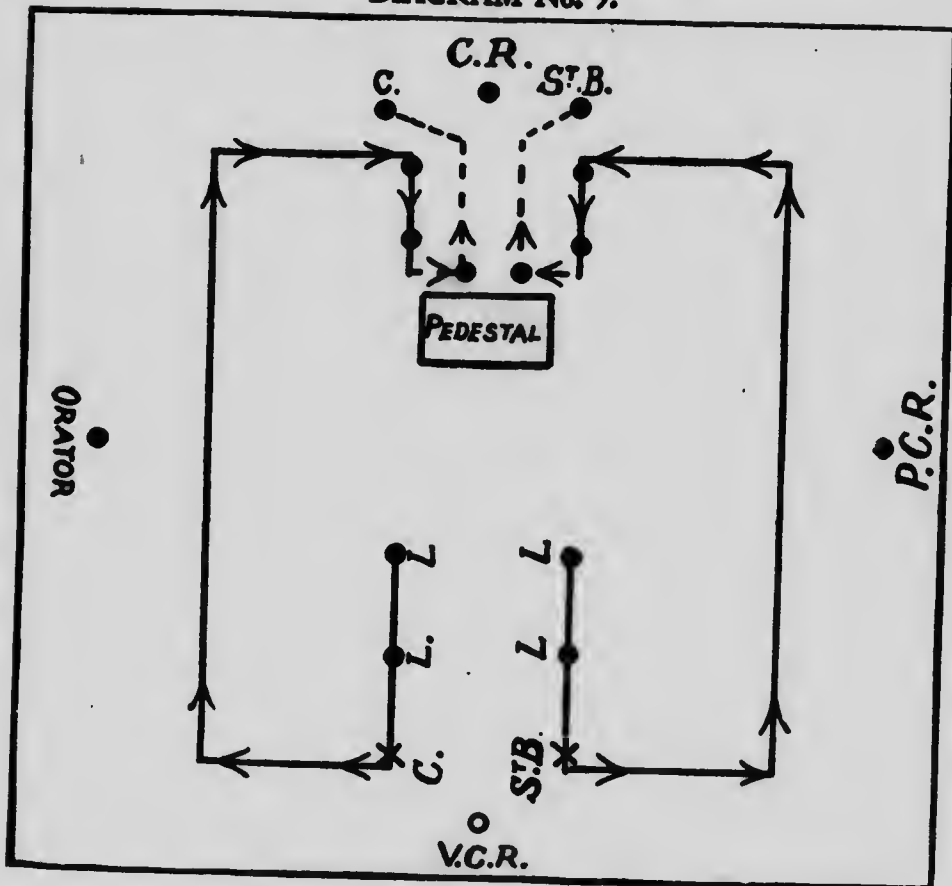

WORDS OF COMMAND.

C.G.—Guard, right and left turn! Quick march!
S.L.—Guard, halt! Inward turn!

SEATING THE LANCERS.

(When the Captain and Standard Bearer are seated, the Senior Lancer will give the words of command, "Right and left turn!" "Quick march!" whereupon the Lancers will march to their respective stations, as indicated in Diagram No. 10. The two crosses indicate the positions, at the start, of the Senior and Junior Lancer.)

DIAGRAM No. 10.

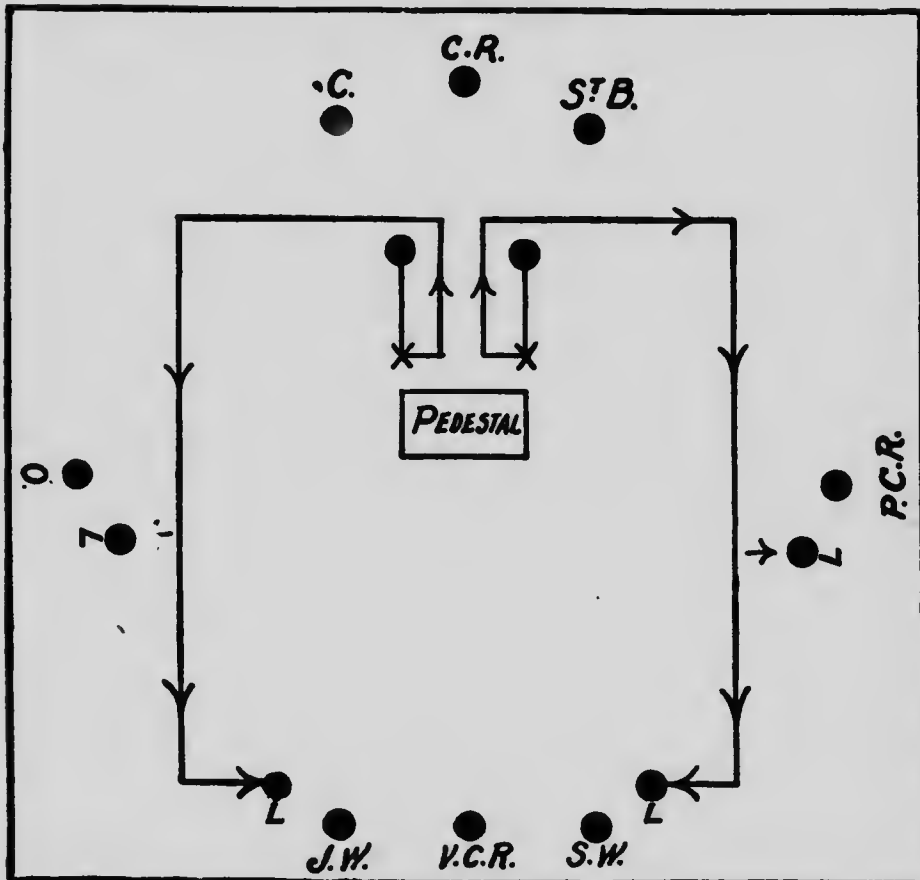

WORDS OF COMMAND.

S.L.—Right and left turn! Quick march!

(When the Lancers have been seated the Chief Ranger will complete the opening of the Court as follows :)



C.R.—The Orator will address the Throne of Grace.

OPENING PRAYER.

Orator.—Great and Merciful God, we once more assemble together in Thy holy name and humbly invoke Thy blessing upon this Court. We pray Thee to incline our hearts to do Thy will; teach us to be wise, moderate and just in all our actions; courteous and forgiving to one another and lenient in condemnation of an erring member. Teach us to make truth, justice and charity the ground-work of all our acts; and to Thee be ascribed all the glory and praise, now and evermore. Amen.

C.R.—I now declare the Court duly and legally opened for the transaction of business.



(The C.R. will then begin with No. 2 of the Order of Business and proceed with the same as laid down in the "Order of Business.")



ORDER OF BUSINESS

1. Opening ceremony.
2. Calling roll of officers.
3. Reading, correcting and confirming the minutes.
4. Propositions for membership.
5. Reports of committees on character.
6. Balloting for candidates.
7. Has the Recording Secretary notice of acceptance by the Medical Board of the medical examination paper of any applicant for membership?
8. Initiation of candidates.
9. Appointment of the Special Auditing Committee.
10. The Financial Secretary will state when and how *he* sent the monthly remittance to The Supreme Court for the present month.

(The R.S. will note the date given by F.S., and record whether)
(by Post Office or Express Money Order, or Bank Draft.)

(If the F.S. has not sent the report and remittance for the present month, *he* should be required to do so forthwith. Special attention is directed to the Constitution and Laws of the Order, which clearly show that it is not necessary for the F.S. to wait for an order to send the monthly remittance to The Supreme Court, but that the order may be drawn at the next meeting of the Court after the remittance has been sent.)

11. The Recording Secretary will draw an order on the Treasurer for the amount of the present month's remittance to The Supreme Court.

12. The duplicate of the monthly report for the present month will now be filed as the property of the Court; and the Special Auditing Committee will carefully examine it and report on its correctness.

13. The Recording Secretary will read the names of those suspended members for whom notices of reinstatement have been received from the Supreme Secretary since the last meeting, and enter the names in the minutes.

14. Intermission. (During which payments are to be made to the Financial Secretary.)

15. Has the Recording Secretary the receipt for the remittances for the present month?

(If not, and a reasonable time has elapsed since the remittance was made, the R.S. should forthwith write to the Supreme Secretary, inquiring why the receipt for the monthly remittance has not been forwarded.)

16. Has the Recording Secretary any other communications?

17. Is any member out of employment?

18. Reception of general communications.

19. Bills or accounts.

20. Reports of standing committees.

(a) Sick. (b) Finance. (c) Arbitration, if charges have been referred to it.]

21. Reports of special committees. (a) Special Auditing. (b) Other Committees. }

22. Unfinished business.

23. General business.

24. { Reports of officers.

25. { Election of officers.

26. { Installation of officers.

To be called only at the time of the election and installation of officers.

27. Good and welfare.

28. Closing ceremony.

[Each monthly report and remittance should be made by the Financial Secretary before the *third* day of the month. The Constitution and Laws provide that the penalty for failure to remit is suspension or expulsion. All reports should be written in duplicate; the duplicate should be laid before the Court at its first meeting in each month, and should be carefully examined by the Special Auditing Committee as to its correctness, and then filed with the records as the property of the Court. All remittances shall be made as provided in the Constitution and Laws.]

It is the *business* of the officers and members to know that the Financial Secretary does his whole duty at the right time and in the right way, failing in which *he* should be removed from office at once.

When a Court becomes suspended, subject to the provisions of the Constitution and Laws the penalty or suspension attaches to the members as well, and reinstatement of the Court and members can be effected only as provided in the Constitution and Laws.

Any member who fails to pay on or before the last day of the month, all assessments, dues, fees, taxes, fines and other demands of the Order for the succeeding month, *ipso facto* stands suspended on the first day of such succeeding month. A member suspended for non-payment must apply for reinstatement on Form No. 15 and be reinstated *within ninety days* from the date of his suspension, or *he* will be re-rated at his present age on reinstatement. The Constitution and Laws clearly provide the manner in which members suspended for non-payment can be reinstated, and they can be reinstated in no other way. The penalty attaching to a Court and the members who permit a suspended member to apply for reinstatement while ill or disabled is also set forth in the Constitution and Laws.

An applicant for membership must not be initiated until *he* has been examined by the Court Physician or other duly authorized examining Physician and recommended by *him* to the Court, on Form No. 39, for beneficiary membership and before the said Form No. 39 has been received by the Recording Secretary, or before his medical examination paper has been accepted and passed by the Medical Board, as the case may be.

It is to the interest of each member that *he* procure a copy of the Constitution and Laws as amended at the last session of The Supreme Court, as every member is bound by the Constitution and Laws of the Order as revised from time to time.]

THIRD

INITIATION



CEREMONY.

(WITH THE GUARD OF HONOR.)

(The regular Guard of Honor shall consist of the Captain of the Guard, Standard Bearer, four or six Lancers, and the two Woodwards, two Beadles and an Organist. The Lancer next to the Captain shall be considered the Senior Lancer, and the one next to the Standard Bearer the Junior Lancer. The starting points of the Captain and Standard Bearer or other leaders of the Guard in each movement of the Guard are indicated by crosses in the various Diagrams. The words of command may be dispensed with altogether or in part at the option of the Captain. A sample of the uniform of a Companion Guard of Honor will be furnished on application to the Home Office, Temple Building, Toronto, Canada. The uniform of the Guard of Honor for a Subordinate Court is as follows: For the Captain of the Guard and the Standard Bearer, the uniform of a Brigadier-General of the Royal Foresters; for the other members of the Guard of Honor, the uniform of a Colonel of the Royal Foresters.)

C. R.—Senior Woodward, you will retire to the ante-room and ascertain if there be a *Candidate* waiting to be initiated, and if so report the *name* in full to the Court.

(The Senior Woodward will then retire, and, if there be any candidates, will, upon returning, report their names in full to the Court.)

S. W.—Chief Ranger, there *is* in the ante-room waiting to be initiated into this Court—(*give name*).

C. R.—Thank you, Senior Woodward. If there be any valid objection to the admission into this Court of the *Candidate* just named by the Senior Woodward, let it now be declared.

(If an objection be made by any member, the Court must decide at once without debate, by a majority vote, whether it is valid or not. If the objection be held valid, then the initiation must be postponed and the objection duly considered at the same or at the next meeting under "General Business" or "Reports of Committees on Character." If the objection be held not valid, or if no objection be offered, the initiation will be immediately proceeded with, as follows:

C. R.—No valid objection having been declared to the initiation of the *Candidate*, the Past Chief Ranger and the Financial Secretary will retire to the ante-room and see that the conditions required

by the Constitution and Laws, and the Rules and Usages of the Or 'er have been duly complied with by the *Candidate*.

(As soon as the Officers have retired the Chief Ranger will order the Guard to form the letters I.O.F., upon which the C.G. will march towards the *East*, thence around the room to the station of the Orator, then turning eastward and forming up in single file below the Pedestal, halt, front, dress and salute the presiding officer; each member of the Guard falling in at the proper place as the Guard marches past, and after saluting proceed thereafter to form the letters I. O. F.)

C. R.—The Guard will form the letters I.O.F.

FORMING THE LETTER I.

(In forming the letter "I," the Guard of Honor will turn to the right and march as indicated in Diagram No. 11. The Guard will, without word of command, halt in the proper place and face the *East*, except the Woodwards, who will face the *West*. The lines of march are indicated in Diagram No. 11. The words of command to be used, after the Salutation has been given, will be found at top of page 51.)

DIAGRAM No. 11.

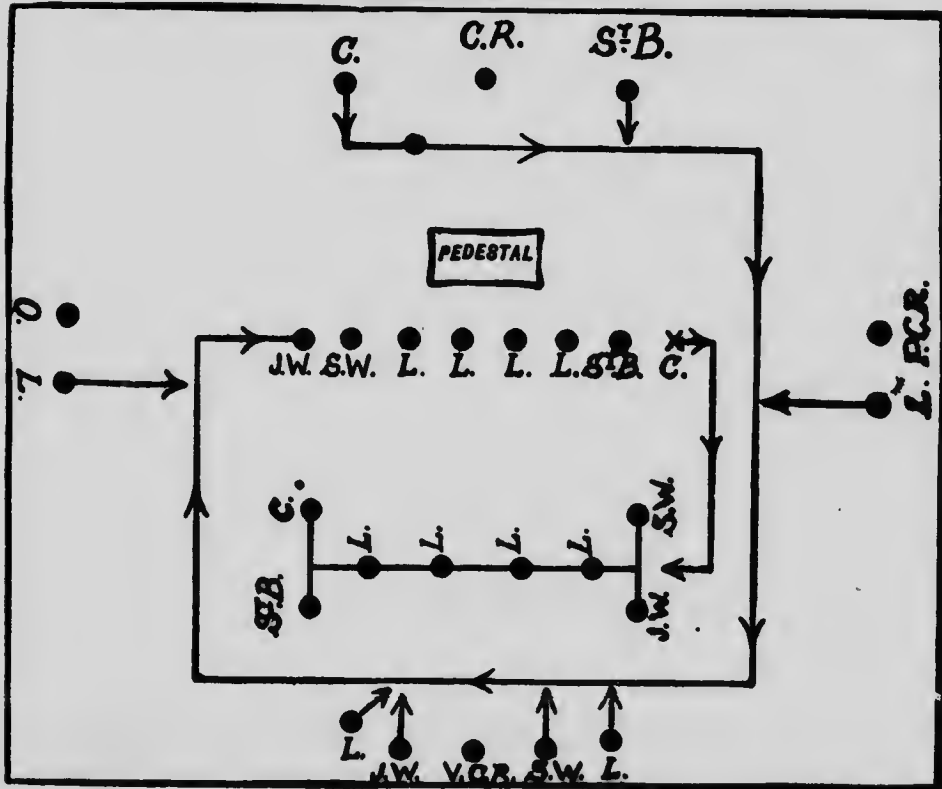

WORDS OF COMMAND.

- C. G.—Guard, fall in !
- C. G.—Guard, halt! Front! Dress! Eyes front!
- C. G.—Guard, right turn! Quick march!
- C. R.—The letter I!

FORMING THE LETTER O.

(The lines of march to be followed in forming the letter "O" are indicated in Diagram No. 12. The Guard will march in single file one and a half times around the Pedestal before halting. The words of command to be given during the movement will be found at top of page 52.)

DIAGRAM No. 12.

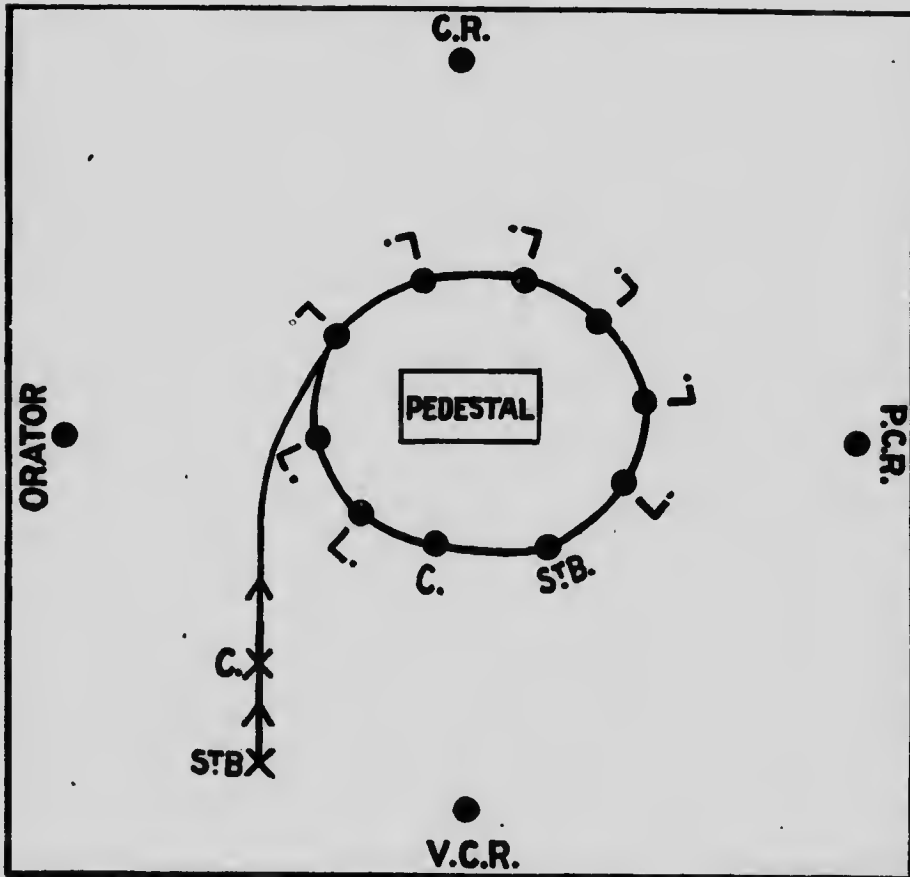

WORDS OF COMMAND.

- C. G.—Guard, about turn! Quick march!
 C. G.—Guard, halt!
 C. G.—Inward turn!
 C. R.—The letter O!

FORMING THE LETTER F.

(In forming the letter "F," members of the Guard as they reach the proper place, between the station of the C.R. and the Pedestal, will halt and face the *East* or the left side of the Court Room, except the S.W. and the J.W., who will face the *West*. The words of command at top of page 53 are to be given during this movement.)

DIAGRAM No. 13.

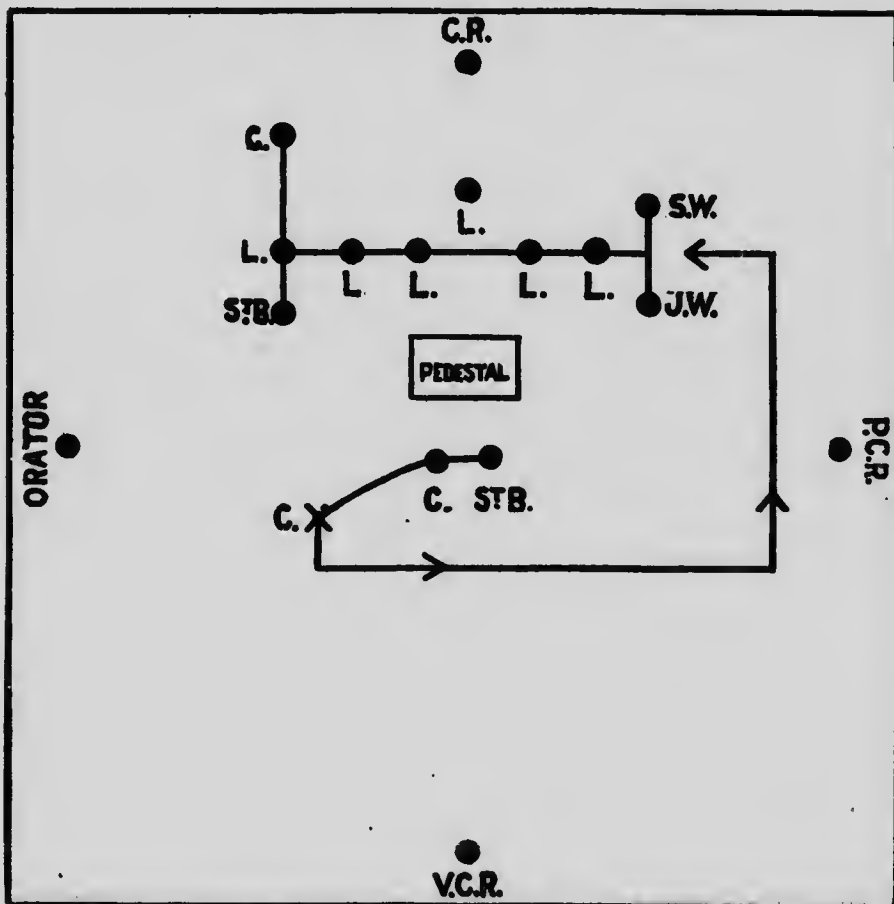

WORDS OF COMMAND.

- C. G.—Guard, left turn!
- C. G.—Guard, halt!
- C. R.—The letter F!

RETIRING OF THE GUARD.

(The Guard in retiring will march to the *South-west* corner of the Court Room in double file, where, as they turn *East*, they will change to single file and halt front across the lower end of the Court Room facing the Pedestal. Then, upon the word of command, they will march to the "saluting point," halt, dress, and give the *Entersign* as indicated in the Diagram No. 14. Upon the command of the C. R. they will retire to the ante-room, as indicated in Diagram No. 15, singing "Marching to Victory." The Guard may march around the Pedestal once or twice before retiring in order to give themselves more time to sing. The words of command to be given follow the Diagrams.)

DIAGRAM No. 14.

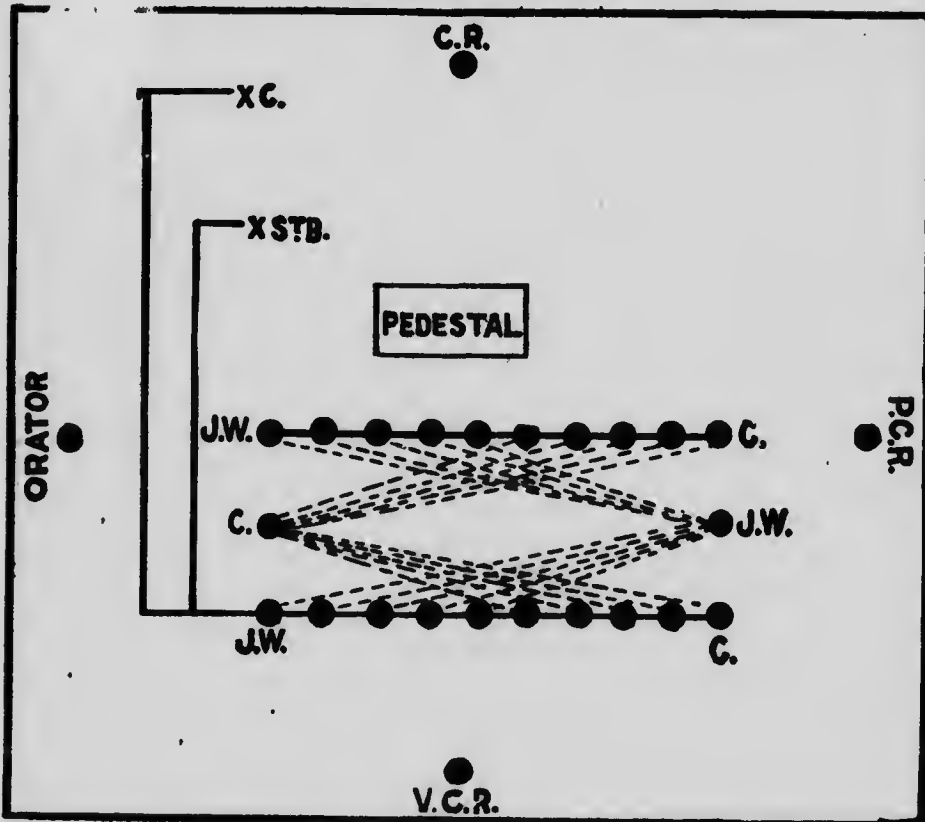

WORDS OF COMMAND.

C.G.—Guard, about turn! Quick march!

C.G.—Guard, halt! Front! Quick march!

C.G.—Guard, halt! Dress! Eyes front!

C.G.—Guard, right turn! Quick march!

C.R.—The Guard will now retire and escort the Woodward and the *Candidate* into the Chambers of the Court.

DIAGRAM No. 15.

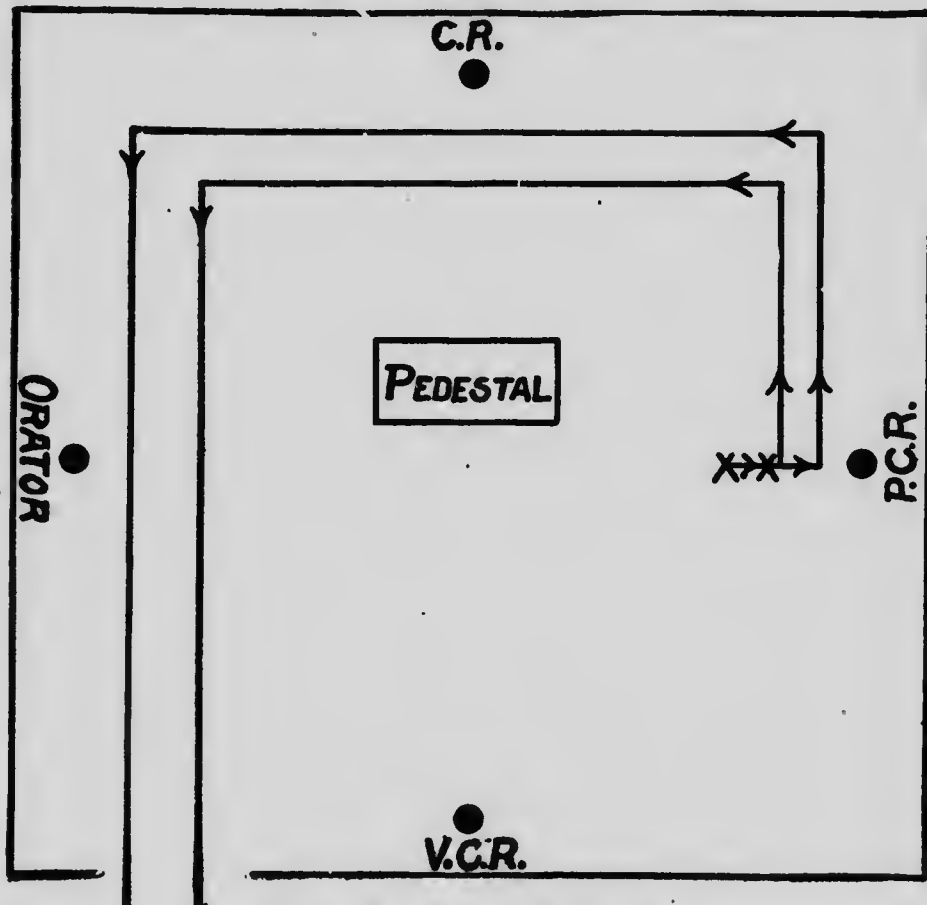
**WORDS OF COMMAND.**

C.G.—Guard, right turn! Quick march!

MARCHING TO VICTORY.

Introduction.

Air—Marching Through Georgia.

Musical notation for the Introduction, consisting of two staves (treble and bass clef) in 2/4 time, featuring a melody in the treble and accompaniment in the bass.

Song.

Musical notation for the first part of the song, including two staves and the lyrics: "1 Loud the swel-ling chor - us raise we'll 2 Sing! Our chief has cleared the way for".

Musical notation for the second part of the song, including two staves and the lyrics: "sing the good old song Vic-t'ry and her train, Sing it with a spi - rit that will For Liberty and con-cord strong, and".

Musical notation for the third part of the song, including two staves and the lyrics: "roll the world a - long love that soothes each pain; Sing it so that all may hear "Two Sor - row flies be - fore us for re-".

Chorus.

hundred thousand strong As we go marching to Vic-to-ry Hur-
sistance is in vain As we go marching to Vic-to-ry

rah! Hur-rah! Two hundred thousand strong Hur-rah! Hur-rah! The

I O F's our song Swell the chor-us loud and clear Our

conq'ring ranks a - long As we go march-ing to Vic-to-ry.

(The Past Chief Ranger will put the following questions to the Candidates in the ante-room, and, if the answers be satisfactory, will so report to the Court on returning thereto:)

P. C. R.— _____, it is my duty to ask you certain preliminary questions, but before doing so I am permitted to assure you that there is nothing in the Obligation or Constitution and Laws of the Independent Order of Foresters which in any way interferes with the religious, political or social rights or duties of its members. The discussion of political or religious subjects is not permitted within our Court Rooms. Our aim is simply to afford each other mutual aid and relief, as well as the protection for our loved ones which is given by the Order. Having made these explanations you will please answer the following questions:

(1) **P. C. R.**—What is your profession, trade or occupation? You will please describe it fully.

Candidate.— { The Candidate must give full particulars, stating the nature of the profession, trade or occupation followed with such exactitude and detail as to make it perfectly clear what the duties are which are attached to such profession, trade or occupation }

P. C. R.—I have to inform you that your present occupation will place you in the _____ Class; (or, I regret to inform you that your present occupation is proscribed by our laws and you cannot be admitted to membership. You will therefore be good enough to retire).

(Persons engaged in the occupations proscribed in the Constitution and Laws or who are engaged in the manufacture or sale of intoxicating liquors or in occupations that have been scheduled as specially dangerous cannot be admitted to membership in the Order. If the Candidate be admissible the P. C. R. will proceed as follows:)

(2) **P. C. R.**—Have you, since your medical examination for admission to our Order, been under medical treatment of any kind, or taken medicine, or consulted any physician on account of any disease or ailment?

Candidate.—I have not. { If otherwise the Candidate must give particulars, which must be reported to the Court by the P. C. R. }

(3) P. C. R.—Are you at the present time in good, sound mental and physical health?

Candidate.—I am.

(4) P. C. R.—Do you believe in the existence of a Supreme Being, the Ruler and Governor of the Universe?

Candidate.—I do.

(5) P. C. R.—Do you agree to keep inviolate any unwritten or other private work of the Order which may be communicated to you and that you will be governed and bound by the Constitution and Laws, Rituals, Rules and Usages of the Independent Order of Foresters?

Candidate.—I do.

(6) P. C. R.—Do you agree, for yourself and in behalf of your heirs and beneficiaries, in the event of your ceasing at any time to be a member of the Order in “good standing” as defined in the Constitution and Laws of the Order, that all your rights, title or claim to, or interest in any property, funds, privileges or benefits of this Court, or of The Supreme Court of the Independent Order of Foresters, shall thereby terminate and become absolutely null and void?

Candidate.—I do.

(The Financial Secretary will then collect the balance, if any, of the Initiation and other Fees; after which the two officers will return to the Court Room and report. They will re-enter the Court Room just as an ordinary member does by giving the proper knocks, etc.)

P. C. R.—Chief Ranger, the *Candidate* has answered satisfactorily all the questions. ^{if the applicant is entering} _{as a beneficiary member} _____ gives *his* occupation as _____, and I informed *him* that *he* would be rated in the _____ Class.

(The occupation of each candidate must be reported, and the Class in which each will be rated entered in the Minutes of the Court, or if the

occupation is proscribed it must be so reported to the Court and likewise entered in the Minutes by the Recording Secretary.)

C.R.—Thank you, Past Chief Ranger.

F.S.—Chief Ranger, the *Candidate* has paid the required fees.

C.R.—Thank you Financial Secretary. The Senior Beadle will inform the Senior Woodward that the Court is ready to receive the *Candidate*.

S.B.—● ● ● (<sup>Opens the door
or wicket.</sup>) Senior Woodward, by command of the Chief Ranger I beg to inform you that the Court is now ready to receive the *Candidate*.

(Immediately after the Senior Beadle announces that the Court is ready, the Senior Woodward will give three loud knocks on the door, which will be answered by the Senior Beadle also giving three loud knocks on the door as follows:)

S.W.—● ● ●

S.B.—Vice Chief Ranger, there is an alarm at the inner gate.

V.C.R.—Ascertain the cause of the alarm.

S.B.—● ● ● (<sup>Opens wicket and ascertains the cause
of the alarm, then reports.</sup>) Vice Chief Ranger, the alarm was caused by the Senior Woodward, who is at the inner gate with the *Candidate* under proper escort.

V.C.R.—Chief Ranger, the *Candidate*, under proper escort, is at the inner gate.

C.R.—Let the *Candidate* be admitted and presented in due form to the Vice Chief Ranger for instruction.

(The Woodwards will enter the Court Room with the *Candidate* between them. If there be more than one *Candidate*, the Senior Woodward will form the *Candidates* in single file; the Senior Woodward will lead and the Junior Woodward will bring up the rear of the file, while the remainder of the Guard will act as an escort.)

S.B.—(<sup>Throws the door
wide open.</sup>) By command of the Chief Ranger the *Candidate* is permitted to enter the Court Room.

ENTRY OF THE CANDIDATE.

(The *Candidate* will be conducted slowly around the room once or twice to the station of the Vice Chief Ranger, in order to give time to the Orator to read the Ten Commandments. If there be an organ or piano, the Organist should play a slow march *very softly* while the *Candidate* is being conducted around the Court Room. The words of command to be given during this movement are as follows:)

WORDS OF COMMAND.

C.G.—Guard, slow march! C.G.—Guard, halt!

DIAGRAM No. 16.

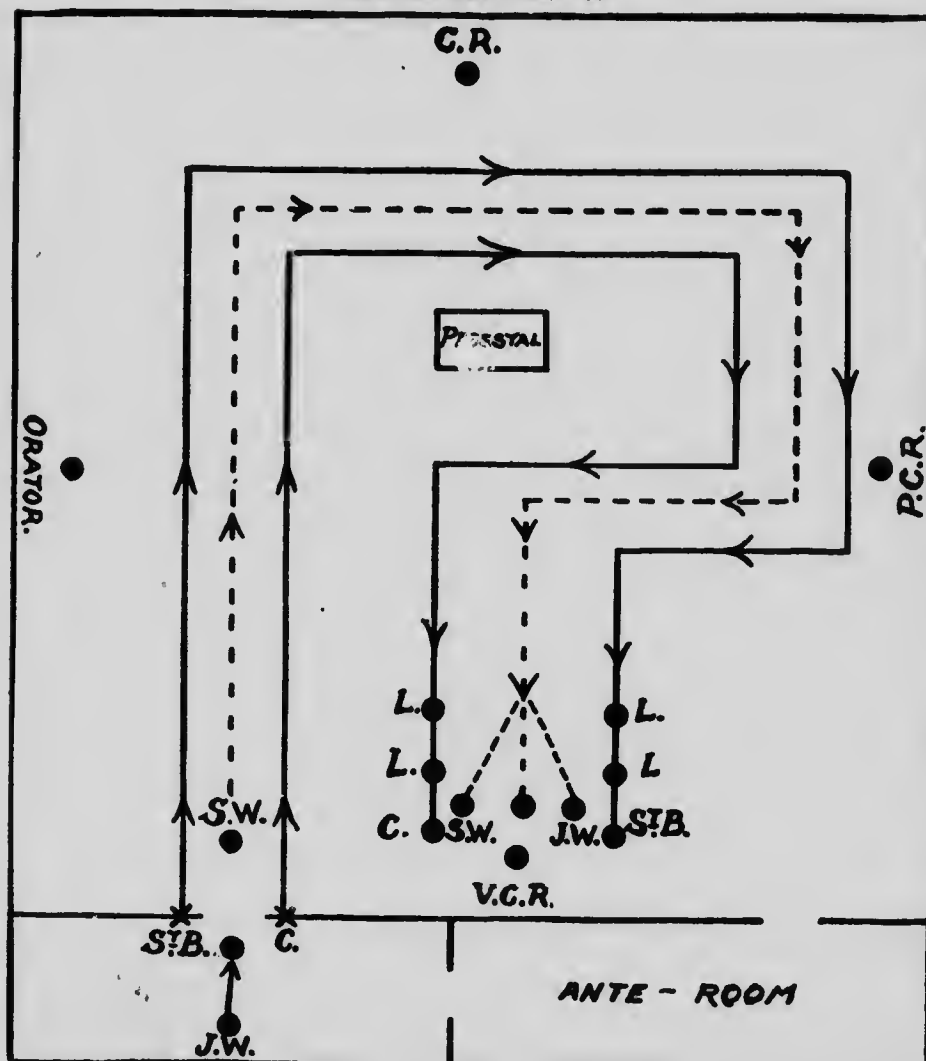

(The first words of command are to be given immediately after the Senior Beadle opens wide the door and announces the permission to enter the Court Room. The second word of command is to be given when the Woodward and the *Candidate* have reached the station of the Vice Chief Ranger. As the *Candidate* enters the Court Room, the Chief Ranger will proceed as follows :)

C. R.—● ● ●

C. R.—Hear ye and give heed to the words of the Orator.

Orator.—And God spake all these words saying, I am the Lord thy God, which have brought thee out of the land of Egypt, out of the house of bondage.

I. Thou shalt have no other Gods before me.

II. Thou shalt not make unto thee any graven image, or any likeness of anything that is in heaven above, or that is in the earth beneath or that is in the water under the earth; thou shalt not bow down thyself to them nor serve them; for I the Lord thy God am a jealous God, visiting the iniquity of the fathers upon the children unto the third and fourth generation of them that hate me; and showing mercy unto thousands of them that love me and keep my commandments.

III. Thou shalt not take the name of the Lord thy God in vain; for the Lord will not hold him guiltless that taketh His name in vain.

IV. Remember the Sabbath Day to keep it holy. Six days shalt thou labor and do all thy work; but the seventh day is the Sabbath of the Lord thy God; in it thou shalt not do any work, thou nor thy son nor thy daughter, thy man-servant nor thy maid-servant, nor thy cattle, nor thy stranger that is within thy gates. For in six days the Lord made heaven

and earth, the sea, and all that in them is, and rested the seventh day: wherefore the Lord blessed the Sabbath Day, and hallowed it.

V. Honor thy father and thy mother; that thy days may be long upon the land which the Lord thy God giveth thee.

VI. Thou shalt not kill.

VII. Thou shalt not commit adultery.

VIII. Thou shalt not steal.

IX. Thou shalt not bear false witness against thy neighbor.

X. Thou shalt not covet thy neighbor's house, thou shalt not covet thy neighbor's wife, nor his man-servant, nor his maid-servant, nor his ox nor his ass, nor anything that is thy neighbor's.

All the Members.—Amen! Amen! Amen!

(The "Amens" may be said or sung. If sung the following notes may be used:)

A-men, A - - - men, A - - - men.

S. W.—Vice Chief Ranger, by command of the Chief Ranger I present this *Candidate* before you for instruction.

V. C. R.—My *Friend*, it is my duty to inform you that the Independent Order of Foresters is a fraternal and benevolent institution formed for the purposes of

mutual aid and the protection of the loved ones within the home circle of every Forester. It is our pride that the Temple of Independent Forestry rests on strong and enduring foundations, and that it has for its chief corner stone the grand and ennobling principle of the "Fatherhood of God." It was, therefore, meet and proper that at the very threshold of the Order, the Ten Commandments given by God himself, to be a light and guide to all the nations of the earth, should have been repeated in your hearing.

If you will look at our Banner you will see displayed thereon the various colors and emblem of our Order. Their symbolic meaning is of interest to all Foresters

Red, one of these colors, is, by Milton, called a "celestial hue; and is a standard color in the Bow the Creator has placed in the Heavens, as a sign of His everlasting faithfulness and of His unbounded Benevolence to us, the creatures of His hand. To Foresters, therefore, this color symbolizes unalterable fidelity and unceasing benevolence. We trust, from henceforth, whenever your eye rests upon this Color, you will be inspired to greater deeds of Benevolence and Charity, as well as to a more devout sense of gratitude to the "Giver of every good and perfect gift." Let it be your aim day by day to become better and better, to the end that those who associate with you may be enlightened in mind and chastened in character.

Woodwards, you will now conduct the *Candidate* to the Past Chief Ranger for further instruction.

(The order of march will be found in Diagram No. 17. The words of command follow the Diagram.)

DIAGRAM No. 17.

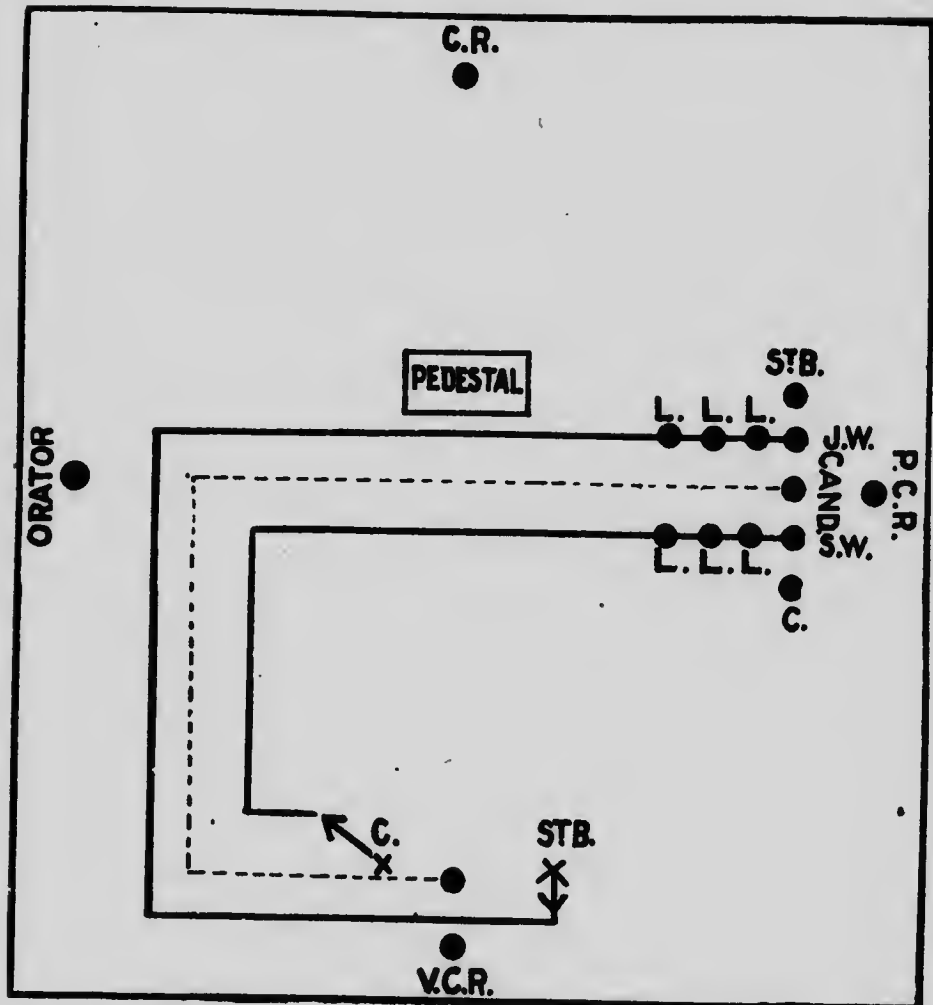

C. G.—Quick march! Right turn!

C. G.—Halt! Inward turn!

Orator.—He that can rule his tongue shall live without strife; and he that hateth babbling shall have less evil.

Forsake not an old friend, for the new is not one comparable to him; a new friend is as new wine: when it is old thou shalt drink it with pleasure.

Laugh no man to scorn in the bitterness of soul, neither do the like to thy friend.

Devise not a lie against thy brother; neither do the like to thy friend.

Change not a friend for any good, by no means, neither a faithful brother for the gold of Ophir.

And stretch thy hand unto the poor that thy blessing may be perfected.

Fail not to be with them that weep, and mourn with them that mourn.

Be not slow to visit the sick, for that shall make thee to be loved.

S.W.—Past Chief Ranger, by direction of the Vice Chief Ranger I beg to present this *Candidate* before you for further instruction.

P.C.R.—My *Friend*, the motto of our Order consists of the words "Liberty, Benevolence and Concord," which are represented by the letters "L., B. and C."

The first word—

LIBERTY,

is used by Foresters in its best and noblest sense. The Order recognizes the right of its members to enjoy every freedom of action that is consistent with

correctness of life and purity of thought. It seeks to broaden your mind and enlarge your sympathies; to free you from the narrowing influences of selfishness, and thus bring you into that higher and purer sphere where is enjoyed the God-given liberty of increasing, by our own efforts in conjunction with those of our fellow members, the sum total of genuine human happiness.

The second word of our motto—

BENEVOLENCE,

brings before us our responsibilities to our neighbors. To visit the afflicted and to relieve the distressed is a duty expressly enjoined upon us in the Word of God; for it is therein written: "Pure religion and undefiled before God and the Father is this: to visit the fatherless and widows in their affliction and to keep himself unspotted from the world."

The last word of our motto—

CONCORD,

suggests to all Foresters the imperative duty we owe to our beloved Order to zealously promote within our fraternal circle that mutual respect which begets perfect Concord in all our acts—the imperishable bond which unites us, as Foresters, in our work for Humanity.

It only remains for me to explain that *White*, the second color of our Order, is symbolic of that purity of heart and purpose as well as that moral rectitude

and inflexible uprightness which should characterize and adorn the life of every Forester.

You will now be conducted to the Pedestal, there to take the solemn Obligation of the Order.

(The Candidate will be conducted to the Pedestal on the lines indicated in Diagram No. 18. While the Candidate is being conducted to the Pedestal, "Onward, Faithful Foresters," will be sung:)

DIAGRAM No. 18.

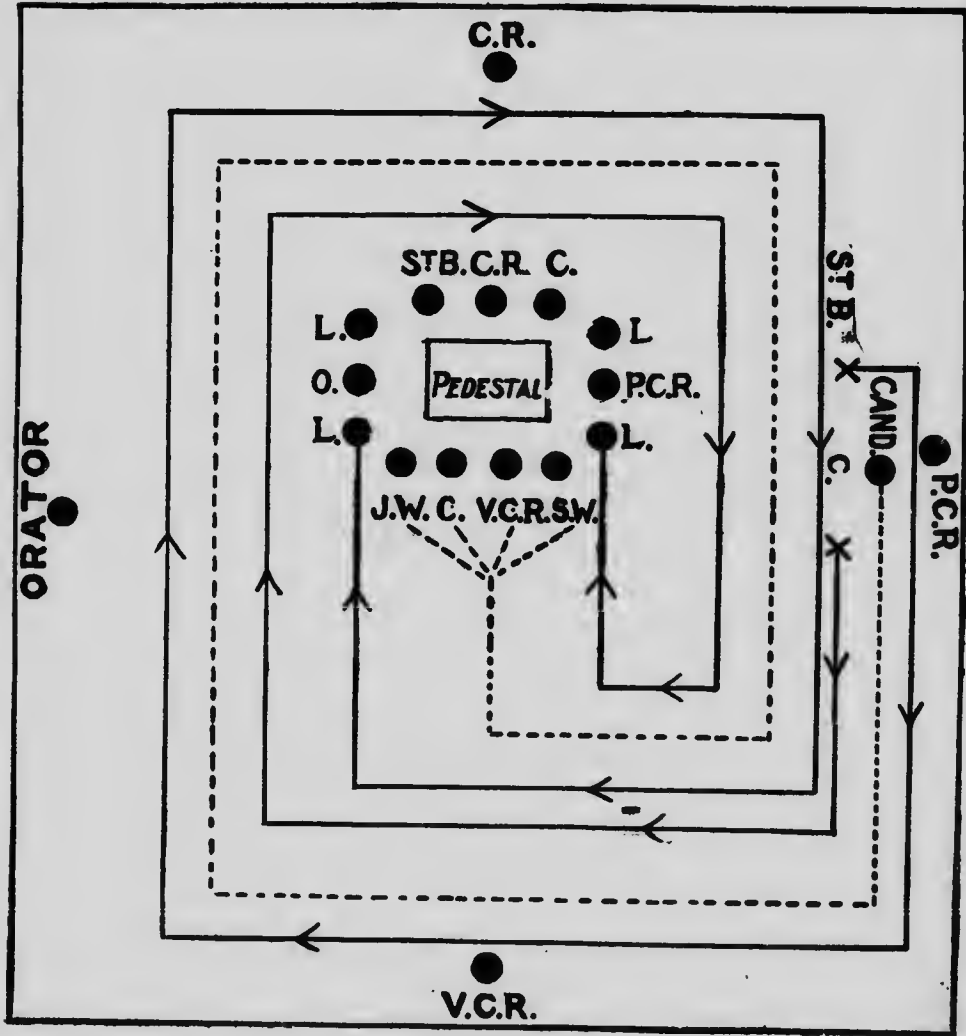

ONWARD, FAITHFUL FORESTERS.

1. On-ward, faithful For - es - ters, wave our ban - ner high;
 2. Wear-y sick and dy - ing. call to us for aid;
 3. On-ward, ev - er on - ward, en - e - gy re - new,

Lib - er - ty, for - ev - er, may its folds im - ply,
 Loved ones claim pro - tec - tion, du - ty on us laid,
 Do - ing un - to oth - ers as we'd have them do,

We are not di - vi - ded, one in Con - cord we,
 Ours a no - ble or - der, may its field ex - tend,
 Like a migh - ty ar - my, moves our or - der on,

One in sin. Be - nev - o - lence bless-ed un - i - ty.
 Till its arms en - cir - - - ole earth from end to end.
 Strong in pur - pose, faith - ful, till our work is done.

Onward faithful For - es - ters, wave our ban - ner high,

Lib - er - ty, for - ev - er, may its folds im - ply.



C. R.—The Court will now assist me to administer the Obligation to the *Candidate*. Let the “Circle of Concord” be formed.

(The C.R., P.C.R., V.C.R. and Orator will proceed to the Pedestal and take the places indicated in Diagram No. 18. The V.C.R. will take a position on the right of the *Candidate*, and at the proper time flash the "Symbolic Great Light." The Guard will retire to the nearest seats and rest till the Standard Bearer has finished his (*her*) address when they will return to their respective stations.)

C.R.—My *Friend!* it is my duty to inform you that as a Forester you will be expected to encourage and to aid the members of the Order in every legitimate and laudable undertaking which has for its object the promotion of the interests of our beloved Order and the good of Humanity; to succour the sick and to relieve the distressed, especially those of our own Forestric household; and to visit the widows and orphans in their affliction.

You will now be required to take upon yourself a solemn and binding obligation, which all members of the Independent Order of Foresters have taken, to be faithful and true to the principles of the Order, and to keep inviolate the unwritten or other private work which may be communicated to you. This Obligation contains nothing that will in any way conflict with any duty you may owe to your religion, to the state, to yourself or to those near and dear to you.

With this assurance, if you are still willing to proceed, (*each of*) you will place your right hand over your heart, as a token of your sincerity, raise your left hand heavenward, as a pledge of your fidelity, pronounce your own name in full and repeat after me:—

THE OBLIGATION.

1 I, (*name in full*) | of my own free will and
 2 accord, | do solemnly and sincerely promise |
 3 that I will never reveal | any word, | sign, |
 4 grip | or token, | or any unwritten | or other

5 private work | of the Independent Order of
6 Foresters, | which shall now | or may hereafter |
7 be communicated to me, | to any one in the
8 world | unless it be to a member | in good stand-
9 ing | who is authorized | by the Rules and Usages
10 of the Order | to receive the same.

11 I also promise | to do all that lies in my power |
12 to alleviate the needs, | protect the honor | and
13 advance the welfare | of the members of this
14 Order.

15 I further promise | to bear true allegiance | to
16 The Supreme Court | and to be governed | by its
17 Constitution and Laws, | Rules and Usages, |
18 now in force | or which it may hereafter enact |
19 or establish.

20 Lastly I promise | that, should I ever cease |
21 to be a member of the Order, | my obligation of
22 secrecy | shall remain binding | and in full force.

23 For the faithful observance | of all these prom-
24 ises | I hereby pledge | my sacred honor.

V. C. R.—^{Will flash the "Symbolic}
Great Light."]

P. C. R.—(or *Choir*) Glory be to Thee, O Lord!
Glory be to Thy Holy Name!
Glory be to Thy great works!

V. C. R.—^{Will again flash}
the Light.]

P. C. R.—Glory be to God on High and on earth
peace, good-will toward men.

V. C. R.—^{Will for the third time}
flash the Light.]

Officers and Members.—Amen! Amen! Amen!

(The above sentences may be said by the P. C. R. or they may be sung by the Court to the music which follows. If sung there must be a distinct pause in the music at the points indicated in the preceding sections in order to give the V. C. R. an opportunity to flash the "Symbolic Great Light.")

THIRD INITIATION CEREMONY.

Glo-ry be to Thee O Lord, Glo-ry be to Thy Ho-ly Name,

Glo-ry be to Thy great works, Glo-ry be to God on High,

and on earth peace, good - will to-ward men. A-men,

A-men, A . . . men, A . . . men.

C. R.—The Orator will invoke a blessing on our proceedings.

Orator.—O Omnipotent, Omniscient and Omnipresent Father, deign to bless the light we now enkindle in the *heart of this Thy servant* so that virtue may increasingly shine around and about *him* and *his* heart be filled with the Divine light of truth; and that the flame of love for righteousness may ever burn with unquenchable brightness within *his breast*; and to Thee, O Sovereign Ruler of the Universe, we will ascribe all might, majesty and power, now and evermore. Amen.

(The Chief Officers will retire to their stations.)



C. R.—The *Initiate* will now give attention to the Standard Bearer who will impart further instructions.

St. B.—My *Friend*, you have already been informed what two of the colors of the Order—*Red* and *White*—symbolize to Foresters.

Blue, the third color of the Order, is the hue given by the Creator to the firmament in which He placed the sun, the moon and the myriads of stars, moving in harmony and concord, not only “to give light upon the earth” and make it to bloom like unto the plains of Sharon, but also to give life and blessings to all His Creatures. Let this color, therefore, ever remind you of your deep obligations to an All-wise

Creator whose beneficence to us is manifested in divers and mysterious ways—in the beautiful coloring and sweet perfuming of the flowers and plants; in providing the various fruits of the earth; in giving us the day in which to work and the night for rest and recuperation; but above all, in endowing us with intellects to understand these and all the other great mercies vouchsafed to us by an All-merciful Father.

The *Emblem* of the Order is represented on our Banner. The “eye” depicted on the upper part of the Emblem is intended to remind us that wherever we are and whatever doing the “All-seeing Eye” of our Father in Heaven is upon us, beholding the evil and the good we do.

The figure on the right side of the Emblem is intended to represent “*Liberty*.” Its significance to Foresters has already been explained to you by our Past Chief Ranger. Let us add the hope that this word will stimulate you ever to strive to achieve your own liberty from the slavery of ignorance and vice and to exemplify virtue and uprightness in your daily life.

The figure on the left side of the Emblem represents “*Benevolence*” scattering her bounties around and about her. Imitate her example and it will be well with thee; for it is written, “To do good and to distribute forget not, for with such sacrifices God is well pleased.”

The clasped-hands in the lower part of the Emblem represents the unity of aim and purpose of Foresters,

as they work together in "*Concord*" for the good of Humanity.

C.R.—We will now sing our first Initiation Ode.

BLEST BE THE TIE THAT BINDS.

1. Blest be the tie that binds Our hearts in
2. We share our mu-tual woes Our mu-tual

Chris-tian love; The fel-low-ship of kind-red
bur-dens bear; And of-ten for each o-ther

minds Is like to the a-bove.
flows The sym-pa-this-ing tear.

C. R.—The Woodwards will escort the *Initiate* to the station of the Financial Secretary, there to be enrolled in the Records of the Independent Order of Foresters, after which the *Initiate* will be presented before me for final instructions.

DIAGRAM No. 19.

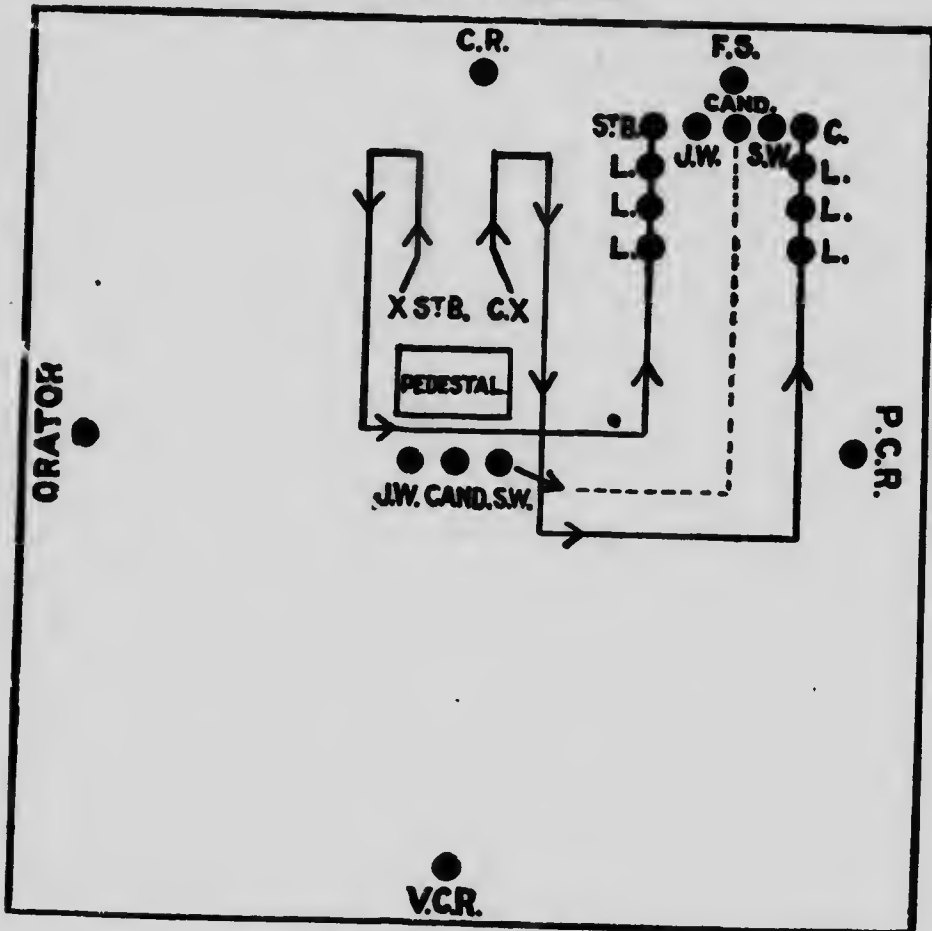

WORDS OF COMMAND.

- C. G.—Guard, right and left turn! Quick march!
- C. G.—Guard, mark time! Forward!
- C. G.—Guard, halt! Inward turn!

(The Woodward and the *Candidate* will turn to the right as the words of command, "Mark time!" are given, and march off between the two files of the Guard. When they reach that station the Guard will form up as indicated in Diagram No. 19. The words of command will be found below the Diagram.)

(As soon as the initiate has been enrolled, the Guard of Honor will escort the initiate to the chair of the Chief Ranger, as indicated in the Diagram No. 20, which follows. While marching to the station of the C.R., "In L., B. & C." will be sung. If necessary the Guard will march twice around the Pedestal before halting before the station of the Chief Ranger in order to give themselves a chance to sing.)

DIAGRAM NO. 20.

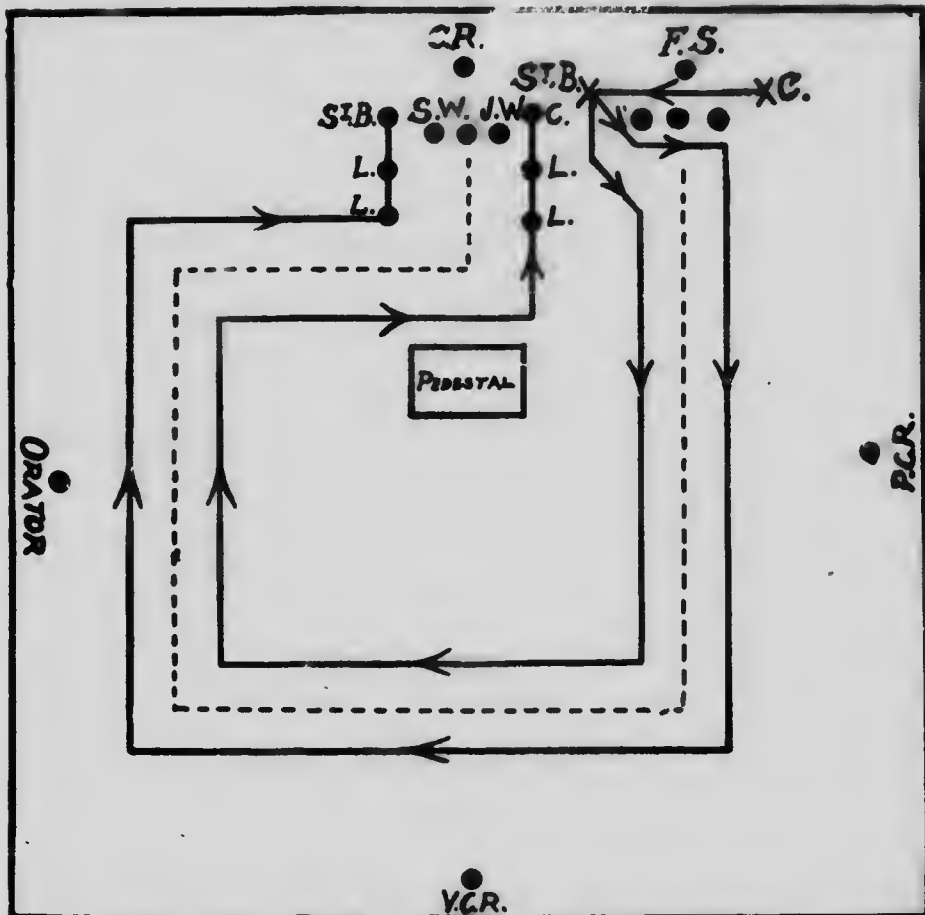

- C.G.—Guard! Right and left turn, Quick march!
- C.G.—Mark time! Forward!
- C.G.—Guard, halt! Inward turn!

IN L. B. C.

Introduction.

Bro. J. C. Morgan.

1 In
2 We
3 Not

L. B. C. true com - rades we, And firm will stand to -
know nor land nor race nor creed, There's but one Father o'er
on - ly this fair land of ours Right glad - ly owns our

geth - er, In vir - tues cause, for love's sweet sake, In
us all; Pure hon - est man - hood makes each man True
gentle sway, We bless where waves the U - nion Jack, Or

rain or shine or stormiest weath - er. Our watchwords three, fair
 no - ble - man what-e'er be - fall..... For this our aim the
 where "Old Glo-ry" greets the day..... And link-ed thus in

Li - ber-ty Be-nev'-lence pure and Concord strong, Like
 wide world o'er, To soothe each sor - row dry all tears, And
 lov-ing clasp so let them float o'er land and sea, Fair

stars shall guide us, While we sing in cho - rus as we march a -
 "scat-ter gold-en bles-sing" round Where - e'er the I. O. F. ap -
 sym-bols of fra - ter-nal love, Bright hope of all the world made

Chorus.

long. Let L. B. C. our watchword ev - er be ! Fair
 pearls.
 free.

friend-ship's bond on ev'-ry land and sea, We stand to-geth-er, We

Com-rades strong and free; Two hundred thou-sand voi-ces ech - o

L. B. C.

C. R.—My *Friend*, having taken upon yourself our solemn Obligation, I am about to entrust you with the unwritten and private work of the Order. Guard them sacredly, to the end that no unworthy person may gain a knowledge of the same, through any want of caution on your part.

FIRST SECTION.

The First Sign is called the **ENTERSIGN**, and is given thus ☞

THE COUNTERSIGN, or answer to it, is given thus ☞

THE SEA SIGN, or **SIGN OF DISTRESS**, is given thus ☞

THE COUNTERSIGN, or answer to it, is given thus ☞

THE WORDS OF DISTRESS are as follows ☞

THE TRAVELLING SIGN, or **SIGN OF RECOGNITION**, is given thus ☞

THE COUNTERSIGN, or answer to it, is given thus ☞

THE WARNING SIGN AND DANGER SIGNAL are given thus ☞

The **TOKEN** is given thus ☞

The answer to the **TOKEN** is ☞

THE VOTING SIGN is given thus ☞

THE GRIP is given in this manner ☞

THE GAVEL in the hands of the Officers conveys a certain meaning to the Court. In the hands of the Chief Ranger, *three* raps call up the whole Court; *two* raps seat the Court; *one* rap calls to order. In the hands of the Vice Chief Ranger, *one* rap calls to order; *two* raps, in answer to the alarm at the inner door, is an order to the Senior Beadle to attend to the alarm.

SECOND SECTION.

To enter a Court Room while a Court is in session proceed as follows :

At the outer door give any usual alarm, such as knocking or ringing the bell, the same as at the door of a neighbor. If required by the officer in charge, give the Permanent Password, or letter it with *him* as *he* may wish. The Permanent Password is _____. This will admit you to the ante-room. There clothe yourself in proper regalia. At the inner door give _____, and to the officer in charge give the current Semi-Annual Password, which is _____. This will admit you to the Court Room. Advance to the centre of the Room, below the Pedestal, and, facing the Past Chief Ranger, give the *Entersign*, at the same time saying, "Past Chief Ranger." *He* will answer you by giving the *Countersign*, upon which you will take your seat.

If not in order for you to be admitted at the moment of giving the alarm at the inner door, (and it is not in order for you to be admitted during the Opening, Closing or Initiatory Ceremony), the Senior Beadle will answer your alarm by giving _____ on the door, in which case it will be your duty to

wait; and, as soon as the Ceremony for which you are thus detained is completed, the Senior Beadle will open the wicket, then you will advance and give the proper Password and you will be admitted to the Court Room.

If you are visiting a Court, at the inner door give, in addition to the Semi-Annual Password, your name, the name and number of your Court and your rank, if any, in the Order.

If you desire to address the Court, rise in your place and face the Presiding Officer and give the *Token*, at the same time saying, "Chief Ranger;" and, when you have received the answer to the *Token* from the Chief Ranger, proceed with your remarks.

Whenever you cross the room from one side to the other, unless you are an officer entitled to a seat on the Dais, cross below the Pedestal and when in front of the Chief Ranger, turn towards *him* and give the Entersign simply, without saying "Chief Ranger."

If you desire to retire before the Court has regularly closed, proceed to the "Saluting point"—just below the Pedestal—turn toward the Past Chief Ranger and give the *Entersign* and say, "Past Chief Ranger, permit me to retire." The Past Chief Ranger, if it is proper for you to retire then, will answer you with the *Countersign*, at the same time saying, "Senior Beadle, permit the *brother* to retire," upon which you will retire without further ceremony.

THIRD SECTION.

The HONORS to visitors of rank are given as follows, the Court in each case being called up:

TO CHIEF RANGERS AND PAST CHIEF RANGERS, each member will give the Old Sign of Recognition, thus ☞

TO DEPUTIES OF THE SUPREME CHIEF RANGER AND OF A HIGH CHIEF RANGER, each member will assume the attitude of initiation, thus ☞

TO OFFICERS OF A HIGH COURT, the Old Sign of Recognition and the Entersign are given together, thus ☞

TO AN OFFICER OF THE SUPREME COURT, other than the Supreme Chief Ranger, each member will give the Supreme Court Salutation, thus ☞

TO THE SUPREME CHIEF RANGER, each member will give the Royal Salute, thus ☞

These constitute the unwritten work of the Subordinate and Companion Court Degree.

Brother (Companion), I am now authorized to address you by that term and in

LIBERTY, BENEVOLENCE AND CONCORD,
to extend to you a hearty welcome into our noble Order. You have bound *yourself* to us by a tie which all upright persons reverence and respect, and a violation of which will carry with it its own punishment. It becomes you, therefore, from the present hour, to honor our principles by an unblemished course of life, honorable dealing and conscientious uprightness, whereby you will reflect credit upon your own personal character, and add to the stability of an Order with whose progress and prosperity your own interests are now identified.

You are now entitled to receive free of cost a copy of the

CONSTITUTION AND LAWS OF THIS ORDER, and it is your duty to forthwith obtain such copy from the Recording Secretary of this Court. Study well their provisions, for you will find that, not only your duties as a Forester, but your rights and privileges in the Order, are therein clearly set forth.

I take pleasure in decorating you with this Forestric Emblem. You will observe that the predominating color thereon is **PURPLE**, the fourth Color of the Order.

This color has, from the earliest ages, been reserved to distinguish Royal and Noble personages.

Let your deeds of Benevolence and your works of Charity, as well as your unswerving fidelity to truth and justice, be your patents of nobility, and so win the right, as a Forester, to wear **THE PURPLE**.



Now by the authority vested in me by the Constitution and Laws of the Order, I proclaim you a Forester, and entitled to all the rights and privileges of membership in our beloved Order.

The Woodwards will escort our Brother (*Companion*) to a seat in the Court Room.



SEATING THE NEW MEMBER.

(The Guard and the newly initiated member will march on the lines indicated in Diagram No. 21. When they reach the imaginary line between the Chief Ranger and the Vice Chief Ranger, below the Pedestal, they will halt, face the Pedestal, salute, and then left turn and march around the Pedestal, turn to the right and pass on to a seat located between the Orator and the lower end of the Court Room. Having reached

the seat, the Guard will halt, face inward and form the Arch of Honor and the Woodwards will seat the new member. The words of command necessary to be used during this ceremony will be found below the Diagram. "The Maple Leaf Forever" or "Columbia, the Gem of the Ocean," will be sung while seating the Candidate.)

DIAGRAM No. 21.

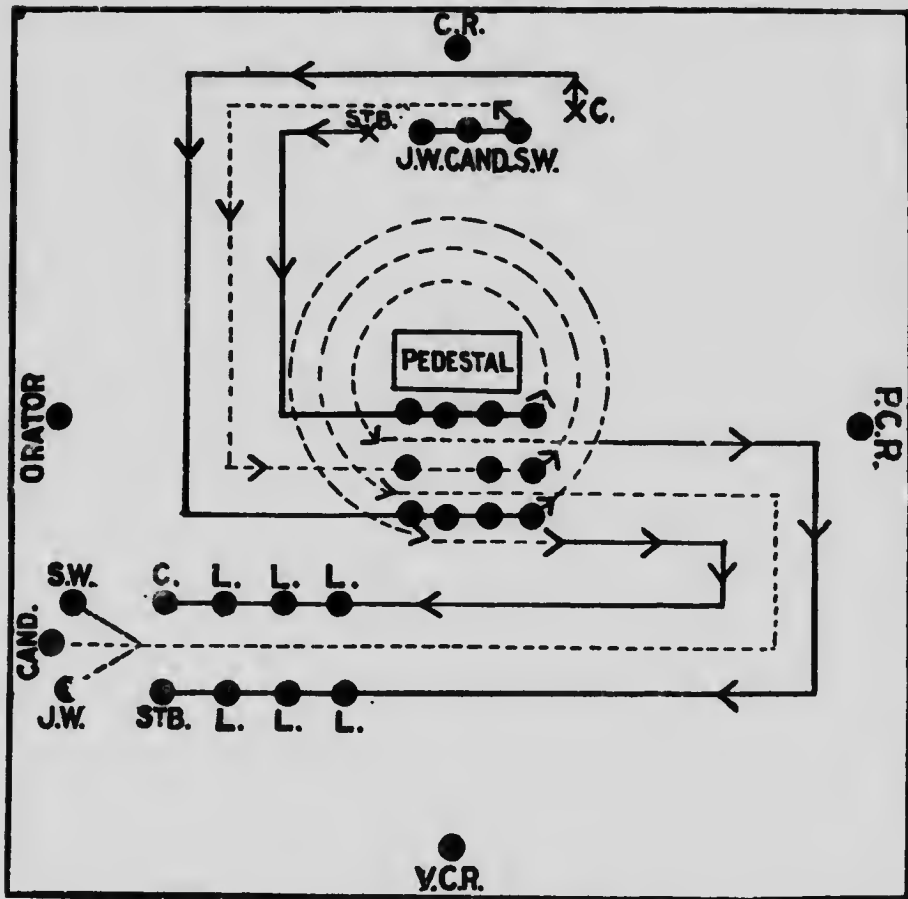

WORDS OF COMMAND.

- C. G.—Guard, right and left turn! Quick march!
- C. G.—Guard, halt! Front!
- C. G.—Guard, right turn! Quick march!
- C. G.—Guard, halt! Inward turn!

THE MAPLE LEAF FOREVER.

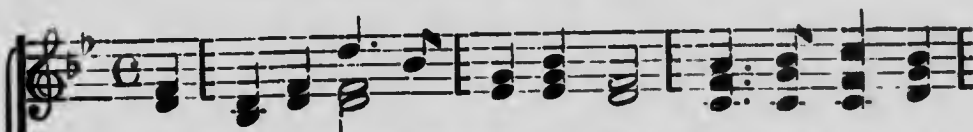

In days of yore, the he-ro Wolfe, Bri-tain's glo-ry
 On man-y hard fought bat-tle fields, Our brave fa-thers
 In au-tumn time, our Emblem dear Dons its tints of
 God bless our loved Can-a-dian homes, Our Do-min-ion's
 On Mer-ry Eng-land's far famed land, May kind Hea-ven

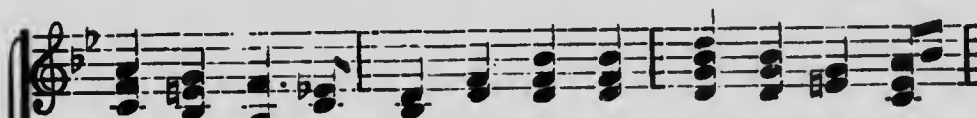
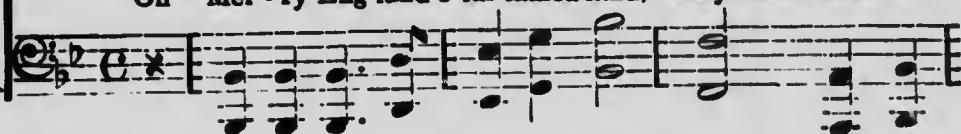

did main-tain, And plant-ed firm-ly Brit-ain's flag, On
 side by side, For free-dom, homes and loved ones dear, Firm-
 crim-son hue; Our blood would dye a deep-er red, Shed,
 vast do-main; May plen-ty ev-er be our lot, And
 sweet-ly smile; God bless Old Scot-land ev-er-more And

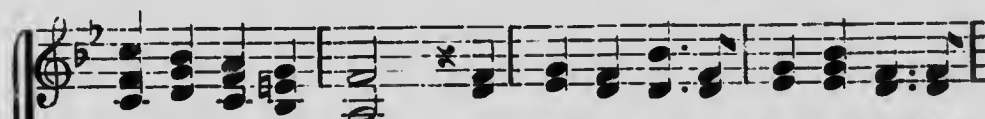
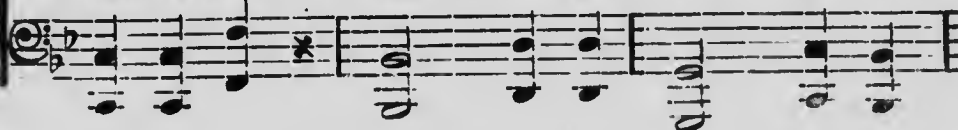

Can-a-da's fair do-main; Here may it wave, our boast our pride And
 ly stood and nobly died, And those dear rights, which they maintained We
 dear Can-a-da, for you! Ere sacr-ed rights our fa-thers won To
 peace hold an endless reign. Our un-ion bound by ties of love, That
 Ireland's Em-er-ald Isle! Then swell the song both loud and long, Till

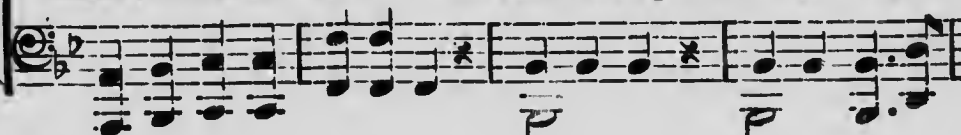

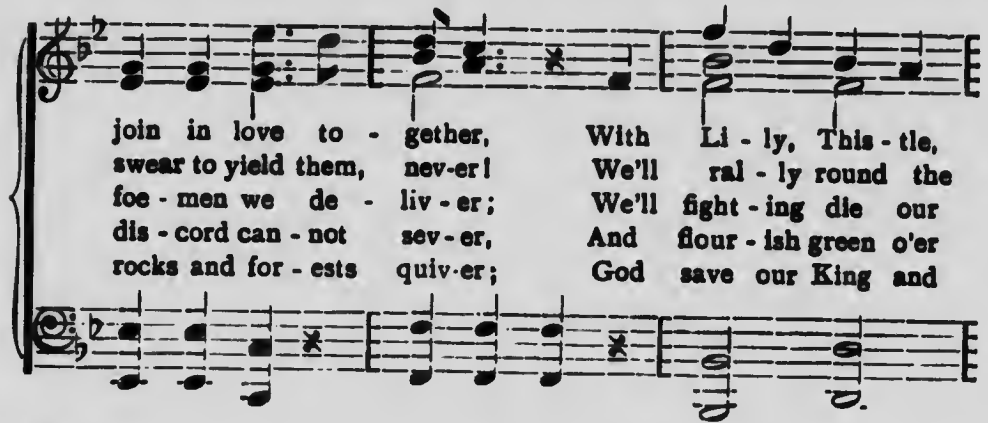

join in love to - gether, With Li - ly, This - tle,
 swear to yield them, nev - er! We'll ral - ly round the
 foe - men we de - liv - er; We'll fight - ing die our
 dis - cord can - not sev - er, And flour - ish green o'er
 rocks and for - ests quiv - er; God save our King and

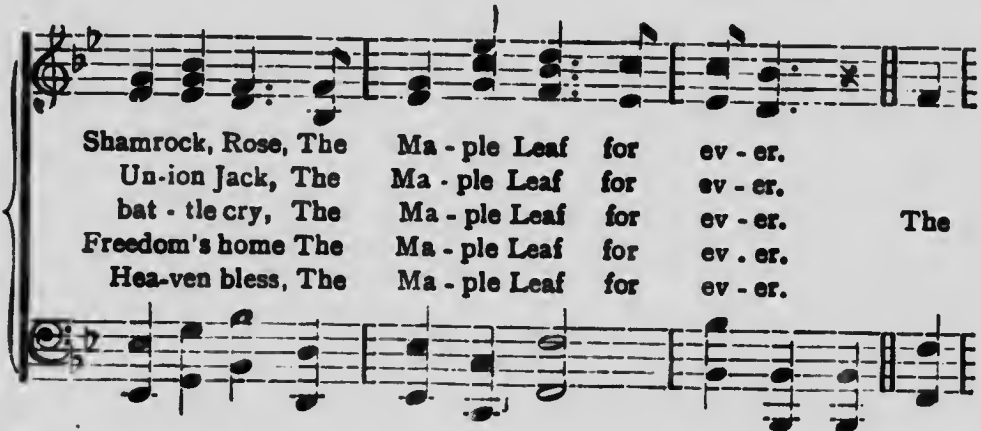

Shamrock, Rose, The Ma - ple Leaf for ev - er.
 Un - ion Jack, The Ma - ple Leaf for ev - er.
 bat - tle cry, The Ma - ple Leaf for ev - er. The
 Freedom's home The Ma - ple Leaf for ev - er.
 Hea - ven bless, The Ma - ple Leaf for ev - er.



Ma - ple Leaf our emblem dear; The Ma - ple Leaf for ev - er! God



save our King, and Heaven bless the Ma - ple Leaf for ev - er

COLUMBIA, THE GEM OF THE OCEAN

D. T. Shaw.

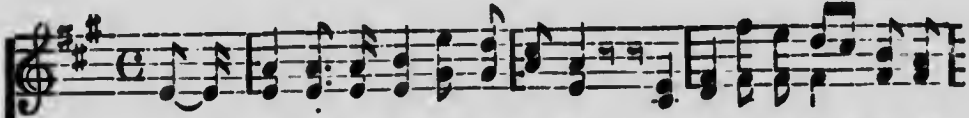

1 Oh, Co - um - bia, the gem of the o - cean, The home of the brave and the
 2 When war wing'd its wild des - o - la-tion, And threaten'd the land to de-
 3 The star span-gled ban-ner bring hith-er, O'er Colum-bia's true sons let it

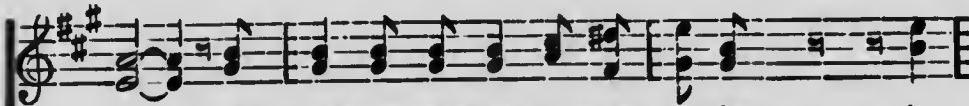
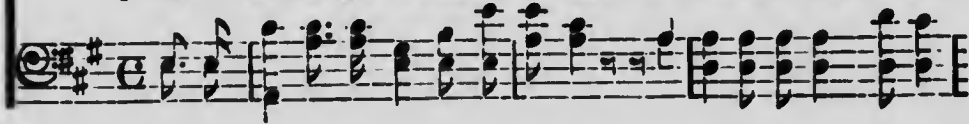

free The shrine of each pa - triot's de - vo - tion, A
 form, The ark then of free dom's foun-da-tion, Co-
 wave! May the wreaths they have won nev - er with - er, Nor its

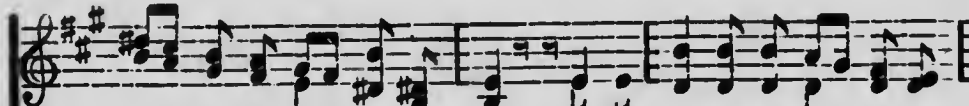

werid of-fers hom-age to thee: Thy man-dates make he - roes as-
 lum - bia, rode safe thro' the storm: With the gar-lands of vic - t'ry a-
 stars cease to shine on the brave; May the ser-vice u - ni - ted ne'er

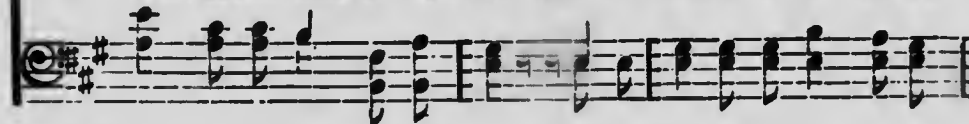

sem-ble, When Lib - er - ty's form stands in view; Thy
 round her, When so proud ly she bore her brave crew, With her
 sev - er, But hoid to their coi - ors so true; The

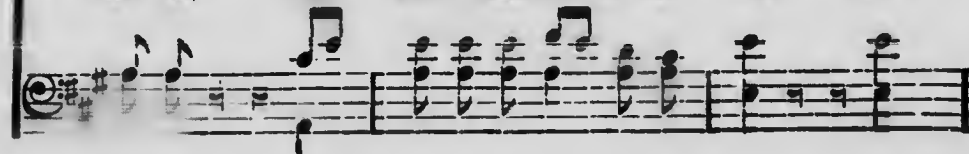



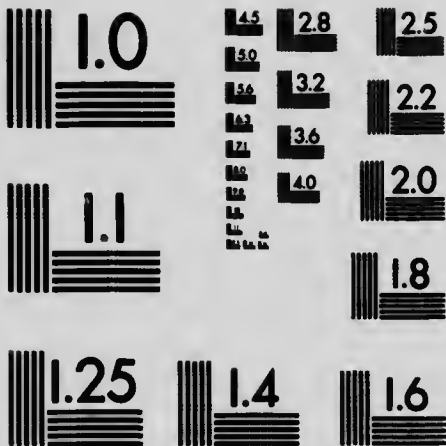

MICROCOPY RESOLUTION TEST CHART
NATIONAL BUREAU OF STANDARDS
STANDARD REFERENCE MATERIAL 1010a
(ANSI and ISO TEST CHART No. 2)

ban-ners make ty - ran-ny tremble,
 flag proudly float - ing be - fore her,
 ar - my and na - vy for - ev - er,

When borne by the red, white and
 The boast of the red, white and
 Three cheers for the red, white and

blue;
 blue,
 blue,

When borne by the red, white and
 The boast of the red, white and
 Three cheers for the red, white and

blue, When
 blue, The
 blue, Three

borne by the red, white and blue,
 boast of the red, white and blue,
 cheers for the red, white and blue,

Thy ban-ners make ty - ran-ny
 With her flag proudly float - ing be -
 The ar - my and na - vy fer -

tremble,
 fore her,
 ev - er,

When
 The
 Three

borne by the red, white and
 boast of the red, white and
 cheers for the red, white and

blue,
 blue.
 blue.

FORMING THE CROSS.

(After the *Candidate* has been seated the Guard will form the Cross, as indicated in Diagram No. 22, they will wheel to the left and continue wheeling until they have circled twice around the Standard Bearer, who forms the pivot, after which they will break off as set forth in Diagram No. 23.)

DIAGRAM No. 22.

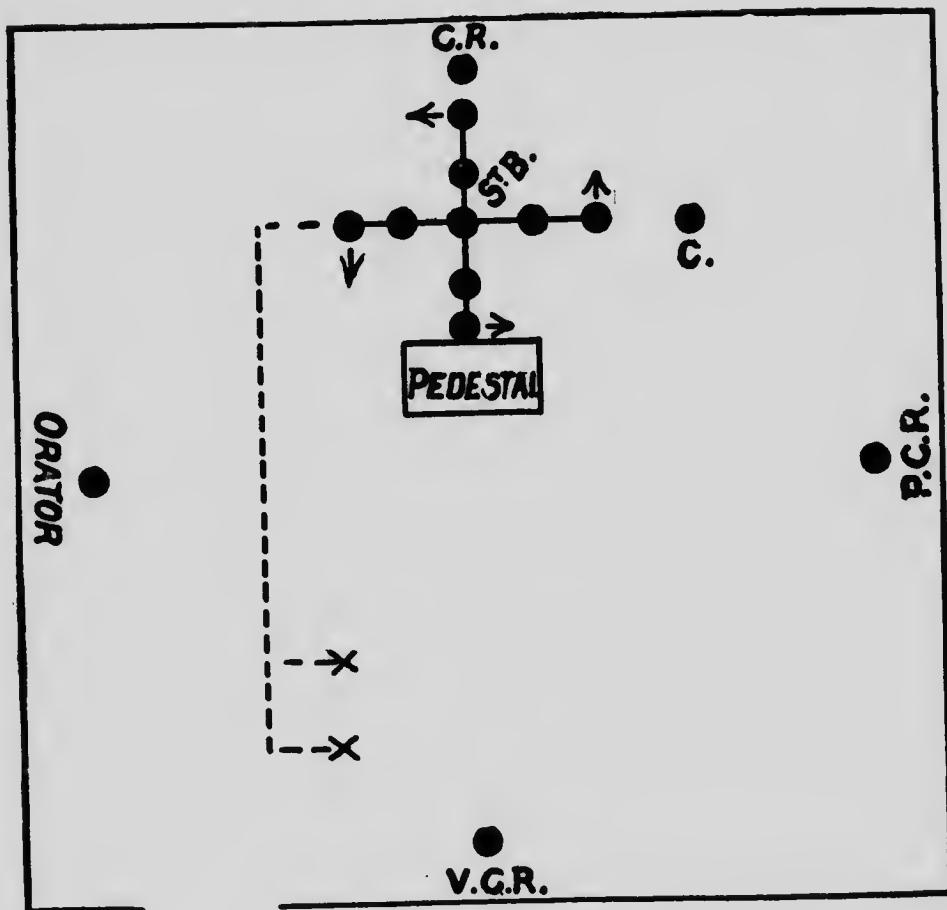

WORDS OF COMMAND.

C.G.—Guard, right and left turn! Quick march!

(After the movement in connection with the Cross has been finished, the Guard of Honor will, without word of command, march first in single file, and then in double file, as indicated in Diagram No. 23, and seat themselves according to the lines indicated in Diagram Nos. 8 and 10.)

SEATING THE GUARD.

DIAGRAM No. 23.

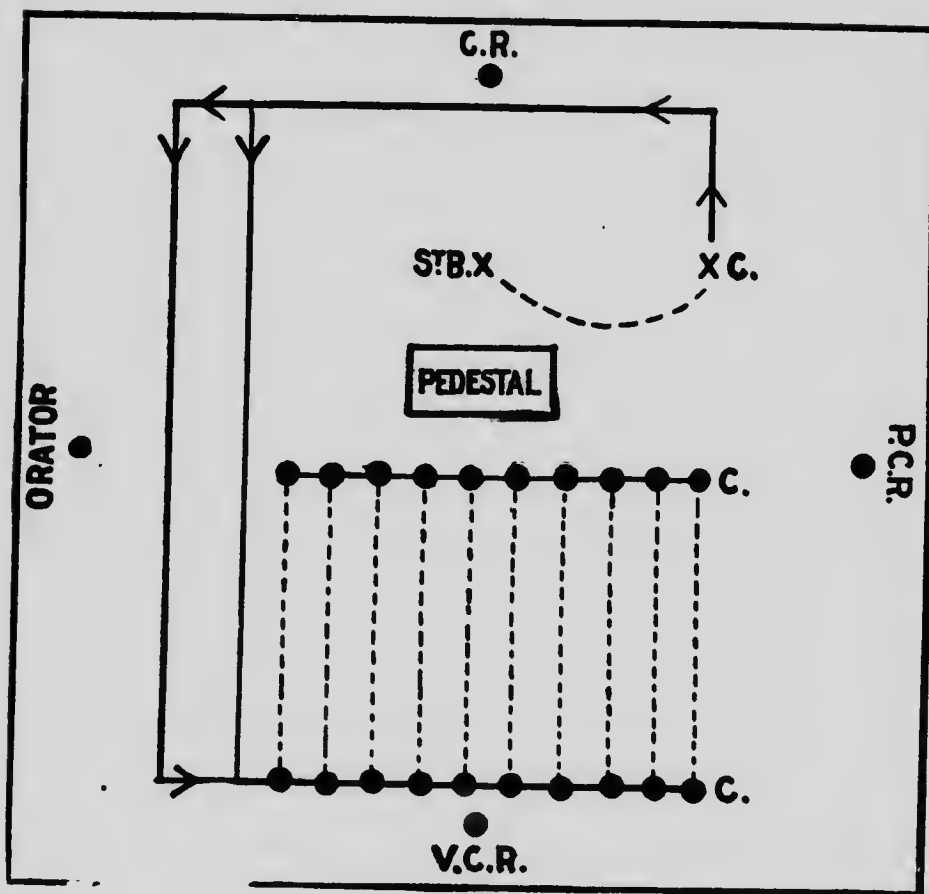

INSTALLATION CEREMONY.



(The officers who are entitled to install are the S.C.R. and other Executive and Past Executive officers of The Supreme Court ; a H.C.R. and other Executive and Past Executive officers of a High Court ; and the Deputies of the S.C.R., and of a H.C.R. The officer conducting the Ceremony of Installation shall at all times during the ceremony be addressed by his proper title, as S.C.R., H.C.R., D.S.C.R., etc., as the case may be. In public Installations, employ four raps for calling up and three for seating the Court. When installing the officers of a Companion Court use the words Companion and Companions wherever the words Brother, Brothers or Brethren occur, and use also the feminine for the masculine form wherever necessary. All being ready, the Installing Officer will proceed as follows :)

S.C.R.—Chief Ranger, your officers having been constitutionally elected, and the Court having made the necessary reports and remittances to The Supreme Court and to the High Court, it is my pleasure that the Installation of the officers-elect be proceeded with ; for which purpose you will direct the present officers to vacate their respective stations.

C.R.—Officers of Court —, No. —, by command of the *Supreme* Chief Ranger, I direct you to relinquish your stations so that your successors in office may be duly installed.

S. C. R.—Chief Ranger, in recognition of your eminent services, it is my desire that, on this occasion, you occupy the post of honor upon my right as Junior Past Chief Ranger of the Court.

(If the C.R. has been re-elected, then the above will be addressed to the junior P.C.R. The Installing Officer will then appoint a Supreme or High Marshal and Conductor, as the case may be.)

S.C.R.—The *Supreme* Secretary will call the roll of the officers to be installed. and the *Supreme* Marshal

and Conductor will arrange them at the pedestal for receiving the Obligation.

(The *Supreme* Marshal and Conductor will arrange the C.D., C.R., V.C.R., R.S., F.S., Treas. and the Phys. in a circle around the pedestal; the remaining officers will form a second circle around the principal officers, and about two feet from the inner circle, as under:)

DIAGRAM No. 24.

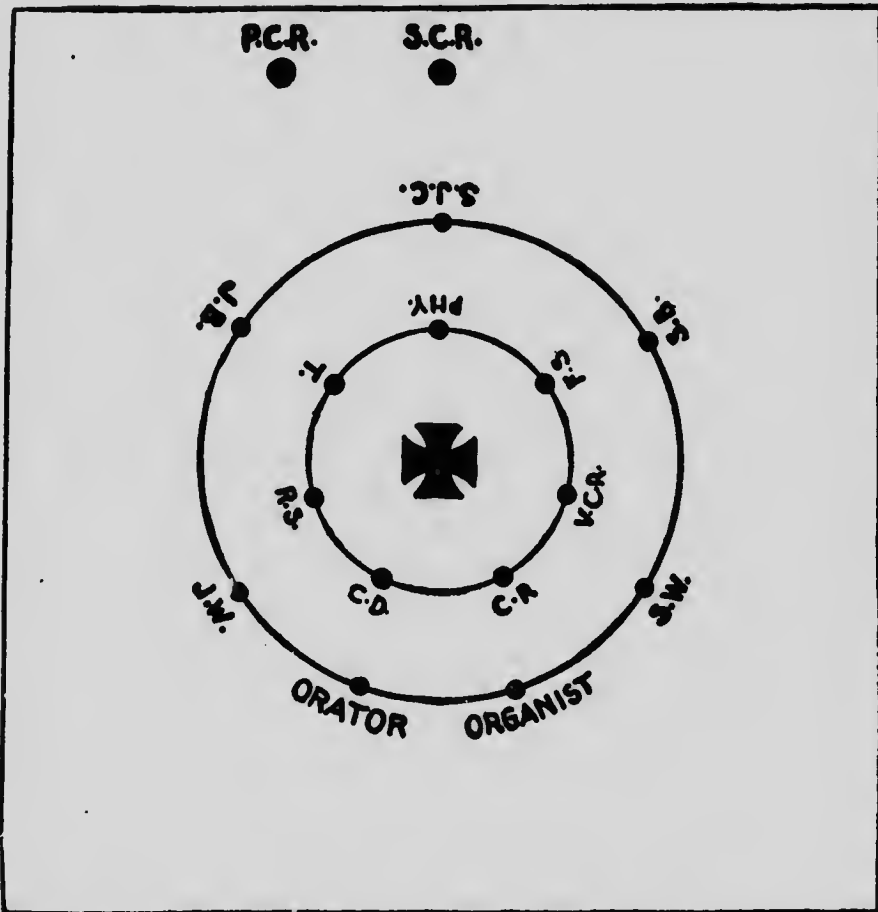

S.M.—*Supreme* Chief Ranger, the officers to be installed are at the pedestal ready to take the Obligation of office.



S.C.R.—Each of the officers will say “I,” pronounce his name in full, and repeat after me the

OBLIGATION OF OFFICE.

I, (*name in full*), in the presence of these witnesses, | do most solemnly and sincerely | promise and declare | that I will, | to the best of my knowledge and ability, | honestly and faithfully perform | the duties of the office | to which I have been elected or appointed. | I will act with strict impartiality | in all matters connected with my office, | and see that every *brother* has *his* just dues. | I will enforce | the Constitution and Laws | and the Rules and Regulations of the Order, | and be governed by the same. | I will abide by | the Ritual of the Order, | and will suffer no innovations therein. | I will pay due respect and obedience | to my superiors, | and treat with kindness and consideration | those who are my subordinates in office. | I further promise and declare | that I will safely keep and preserve | the Charter, | books, | papers, | regalia, | furniture, | and other property | and effects, | and funds of this Court, | or of any other Court of the Order, | which may come into my possession or custody, | and use them | solely for the benefit | of the Independent Order of Foresters; | and, at the close of my term of office, | I will safely transfer | and deliver them | to my successor in office, | or at any time | upon the demand of the Supreme Chief Ranger, | to him personally, | or to any one whom he may designate | to receive the same. | For the faithful observance | of each and all of these several promises, | I pledge my most sacred honor.



(The officers just obligated will then take seats below the pedestal, and the *Supreme* Marshal will present them to the S.C.R. for investiture, in the following order :)

BEADLES.

S. M.—*Supreme* Chief Ranger, I present to you the Senior and Junior Beadle for investiture with their badges of office.

S. C. R.—*Brothers* Senior and Junior Beadles, you will faithfully guard the doors, and allow no one to enter the Court Room without permission of the Chief Ranger, unless the proper passwords are given; and in all things strive to promote the welfare and harmony of your Court.

The *Supreme* Marshal will now invest you with your badges of office, and the *Supreme* Conductor will escort you to your respective posts, where you will at once enter upon the discharge of your duties.

WOODWARDS.

S. M.—*Supreme* Chief Ranger, the Woodwards are before you for investiture with their badges of office.

S. C. R.—*Brothers* Senior and Junior Woodward, it will be your duty to see if all present at the opening of the Court are worthy Foresters; to visit the sick and attend to their wants; take charge of and carefully keep all the property of the Court, and at the end of your term of office hand the same over to your successors in office; and perform such other lawful duties as may be ordered by the Chief Ranger, or by the Court. I am persuaded that you will so discharge all of your duties as to merit the still further confidence of your Court.

The *Supreme* Marshal will now invest you with your badges of office, and the *Supreme* Conductor will escort you to your stations in the Court to enter upon the discharge of your duties.

ORGANIST, SUPERINTENDENT OF JUVENILE COURT AND ORATOR.

S. M.—*Supreme* Chief Ranger, I present to you the Organist, the Superintendent of Juvenile Court and the Orator, for investiture with the badges of their respective offices.

S. M.—*Brother* Organist, you are to superintend and conduct the musical services of the Court, and perform such other lawful duties as may be assigned to you by the Constitution, Laws, Rules and Regulations of the Order, or by the Court. Yours is an important position in the Court, for by the proper performance of the functions of your office you can add materially to the effectiveness of the ceremonies and the interest and pleasure of the meetings. Always strive to do your best in the discharge of your duties.

Brother Superintendent of Juvenile Courts, the department assigned to you is deserving of your best energies. If there be at present no Juvenile Court in connection with this Court, I trust that ere the expiration of your term of office we shall have a flourishing one, established under your care and superintendence.

Brother Orator, you have been chosen to fill an honorable position in the Court. I trust you will always perform the duties of your office with due solemnity and dignity; and that our humble prayers, to our Heavenly Father, will be rendered by you, with all reverence and devoutness.

The *Supreme* Marshal will now invest each of you with the badge of your office, and the *Supreme* Conductor will escort you to your respective stations in the Court.

TREASURER, AND FINANCIAL SECRETARY.

S. M.—*Supreme* Chief Ranger, I now present to you the Treasurer and the Financial Secretary for investiture with the badges of their respective offices.

S. C. R.—*Brother* Treasurer, your duties are more especially to safely keep the funds of this Court, and to pay all legal orders drawn upon you out of such funds. The great importance and responsibility of the office you have assumed will always admonish you to hold untarnished the honor you have just pledged to the Court.

Brother Financial Secretary, it will be your duty to keep an accurate account of the financial standing of each member of your Court, and at each meeting of the Court pay over to the Treasurer all funds then in your hands, taking *his* receipt for the same; to issue all notices required by the Constitution and Laws, Rules and Usages of the Order, or that may be ordered by the Court; to send true and correct reports and make proper and timely remittances to The Supreme Court and to the High Court. I am persuaded that you fully appreciate the importance of the duties pertaining to your office, and that the pledges just given by you will be faithfully redeemed.

The *Supreme* Marshal will now invest each of you with the badges of your respective offices, after which the *Supreme* Conductor will escort you to your stations in the Court. You will enter upon the discharge of your duties as soon as you shall have given the bonds required by the Constitution and Laws of the Order.

RECORDING SECRETARY.

S. M.—*Supreme* Chief Ranger, I now have pleasure in presenting the Recording Secretary for investiture with the badge of *his* office.

S. C. R.—*Brother* Recording Secretary, you will keep accurate minutes of all meetings of this Court; pay all moneys coming into your hands to the Financial Secretary; you will not take part, directly nor indirectly, in any illegal transaction, nor suffer other members to do so, if in your power to prevent it; conduct all the correspondence of the Court and make true and correct reports to The Supreme Court and to the High Court; read to the Court at each meeting all communications received from The Supreme Court or the High Court since the last meeting; sign all orders voted by the Court and none other, unless otherwise provided for in the Constitution and Laws of the Order; and perform such other lawful duties as may be ordered by the Chief Ranger or by the Court.

The *Supreme* Marshal will now invest you with the badge of your office, and the *Supreme* Conductor will escort you to your station in the Court, and you will at once enter upon the discharge of the duties of your office.

VICE CHIEF RANGER.

S. M.—*Supreme* Chief Ranger, I have pleasure in presenting to you the Vice Chief Ranger for investiture with the badge of *his* office.

S. C. R.—*Brother* Vice Chief Ranger, it will be your duty to aid in preserving order; and in the ab-

sence of the Chief Ranger and the Past Chief Rangers of the Court, to perform to the best of your ability, the duties of presiding officer; and to strive by all lawful means to advance the welfare of the Court. You will not take part, directly nor indirectly, in any illegal transaction, nor suffer others to do so, if in your power to prevent it; and perform such other lawful duties as may be required of you by the Constitution and Laws of the Order, or by the Court.

The *Supreme Marshal* will now invest you with the badge of your office, and the *Supreme Conductor* will escort you to your station in the Court to enter upon the discharge of your duties.

PAST CHIEF RANGER.

S. C. R.—*Brother Junior Past Chief Ranger*, it affords me much pleasure to have the privilege of decorating you with this badge of honor. May this Court and the Order long enjoy the benefits of your wise counsel and ripe experience. You will now be escorted by the *Supreme Conductor* to your post.

PHYSICIAN.

S. M.—*Supreme Chief Ranger*, I have the honor to present the Physician of this Court for investiture with the badge of *his* office.

S. C. R.—*Doctor* ———, you have been elected for appointment to one of the most important and responsible positions in the Order. To your skill, diligence and integrity are to be committed, in a great measure, not only the lives of the members of the Court, but also the very life of the Order. Upon the

careful medical selection of our membership, as well as upon their moral worth, rests the success and perpetuity of our noble Order. Do you accept the high and honorable position to which you have been appointed, with a full appreciation of all its duties and responsibilities?

Physician.—I do.

S. C. R.—Do you promise to act with strict justice and impartiality in all cases, and according to your best judgment?

Physician.—I do.

S. C. R.—Do you further promise to make a thorough and careful examination as to the physical fitness of all applicants for admission to this Court, and recommend for membership only those who are, in your judgment, sound in mind and body?

Physician.—I do.

S. C. R.—And lastly, do you promise to attend, with diligence and fidelity, all members of the Court who may require your professional services?

Physician.—I do.

S. C. R.—I now invest you with the badge of your office, and as soon as you receive your Commission you will enter upon the discharge of your duties with the full consciousness that upon the fidelity, integrity and judgment with which you perform your duties rests in a great measure the prosperity of our noble Order.

The *Supreme* Conductor will now escort you to your station in the Court.

COURT DEPUTY.

S. M.—*Supreme* Chief Ranger, I have now the honor to present to you for investiture with the badge of *his* office, *Brother* ———, who has been elected to be commissioned as Court Deputy of this Court.

S. C. R.—*Brother* ———, you have been recommended to the most honorable position in the Court. It is your duty to exercise a general supervision over the work of the Court; to give decisions on points of law whenever an appeal is made to you; to enforce a strict adherence to the requirements of the Constitution and Laws, Rules and Regulations of the Order; to install the officers of this Court in the absence of superior officers; and to perform such other duties as may be required of you by the Constitution and Laws, or by the constituted authorities of the Order. I have every confidence that you will discharge the duties of your office faithfully and efficiently.

I now invest you with the badge of your office, and as soon as you receive your Commission you will enter upon the discharge of your duties. You will now please take your seat on the left of the Chief Ranger's chair.

CHIEF RANGER.

S. M.—*Supreme* Chief Ranger, I have now the honor to present to you *Brother* ———, the Chief Ranger of this Court, for investiture with the badge of *his* office.



S. C. R.—*Brother* ———, you have been elected to the highest position in the gift of your *brethren*. As

Chief Ranger of the Court, your duties will be multifarious, and at times very onerous, requiring from you great patience and tact. As chief executive officer, you should hold the interests of the Court, and of its members, of paramount importance. Ever strive to promote harmony among the members; rule with justice; reprove in kindness; and above all, set an example of promptness and regularity in attending the meetings of the Court, and of loyal obedience to the Constitution and Laws of the Order. I now invest you with the badge of your office (*does so*), in the full confidence that it will be handed to your successor in office, as unsullied as you now receive it, and I welcome you to your post of trust and honor. Take the Constitution and Laws and the Ritual of the Order as your guide and instructors. I commit to your keeping the Charter of this Court; may you ever cherish and defend it as the Magna Charta of your Forestric liberties and privileges; and may God protect you in health, and give you wisdom to govern this Court with honor to yourself and prosperity to our beloved Order. I have great pleasure in seating you in your official chair, and I proclaim you the Chief Ranger of this Court.

S.C.R.—*Supreme* Marshal, it is my pleasure that you proclaim the officers of Court _____, No. —, duly and legally installed.

(The S.M. will stand immediately in front of the Chair, below the Dais, face the Court and make proclamation as follows :)

S.M.—By command of the *Supreme* Chief Ranger, and in Liberty, Benevolence and Concord I proclaim

the officers of Court _____, No. —, of the Independent Order of Foresters, duly and legally installed; and may peace, harmony and good-will ever reign in this Court.

S. C. R.—Chief Ranger, I now surrender to you this gavel, the emblem of your authority; enter upon the discharge of your duties by seating the Court.





CEREMONY OF INSTITUTING A SUBORDINATE COURT.

(In instituting a Companion Court wherever the words Brother or Brothers occur the words Companion or Companions will be substituted and the masculine form changed to the feminine. The ceremony of instituting a new Court shall be conducted by the Supreme Chief Ranger, or, in his absence, by the Deputy who organized the Court or at the request of such Deputy by the Officer present who is highest in rank. When everything is ready and the doors properly tyled or secured, the Instituting Officer shall, if there are other Foresters present, appoint an acting Secretary and a Marshal to assist in the ceremony. After which the Instituting Officer will proceed as follows :)

Instituting Officer.—We are about to institute a new Court of the Independent Order of Foresters. If there be any present who have not filled in and signed the Application for Membership Form, as Charter applicants, and are desirous of so doing, they have the opportunity now.

(After all have applied for membership who desire to do so, the Instituting Officer will ask all who have not made an Application for Membership, and who are not Foresters, to withdraw, after which the ceremony will be proceeded with as follows :)

I. O.—The Secretary will call the Roll, and as each one is called *he* will step to the desk of the Secretary, deposit the Application for Membership Form and pay the required fees. The Secretary will enter the amounts paid opposite each applicant's name in the proper columns of the Instituting Officer's Returns.

The fees payable by Charter members are as follows :

- [1] The Charter Fee, which shall be not less than \$1 nor more than \$5 per member.
- [2] Each applicant pays for a Certificate of Membership, \$1.

[3] Each applicant must pay the Registration Fee, which is *fifty cents* for each \$500 of Mortuary Benefit taken.

[4] Each applicant must pay his own Medical Examination Fee.

(The Medical Examination Fee is \$1.50 for \$500 or \$1,000 of Mortuary Benefit, \$2.00 for \$2,000 or \$3,000, and \$3.00 for \$4,000 or \$5,000 of Mortuary Benefit.)

[5] Each applicant applying to be enrolled in The Supreme Court Sick and Funeral Benefit Department must pay in addition an Enrolment Fee of \$1.00 and a Registration Fee of \$1.00 in that department.

After all the Fees are collected, the Ceremony will be proceeded with as follows :)

I. O.—The next duty is to select the name of the Court.

(If the name has not already been selected, it will then be done, care being taken not to select the name of a living person, nor the name of an existing Court in the same Province, State or Country. It is always advisable to select two alternative names, giving the order of preference.)

I. O.—The Marshal will now present the Charter Applicants for obligation.

(The M. having arranged the Charter Applicants in a semi-circle below the Pedestal, the Ceremony will be proceeded with as follows:

The Instituting Officer must here, and to the end of the Ceremony, be addressed by his correct title as S.C.R., H.C.R., D.S.C.R., etc., as the case may be.)

M.—*Supreme* Chief Ranger, I have the honor to present these applicants for a Charter for a new Court of the Independent Order of Foresters. They have all signed the Application for Membership—Form No. 2. They are now ready to take upon themselves the Obligation of the Order.

(The C.R. will deliver the address, and administer the Obligation, on page 17, after which *he* will instruct in the unwritten and private work, as found on pages 18 to 21.)

S. C. R.—I will now appoint *Brothers* (^{Naming the}_{brethren}) a committee to recommend a staff of officers.

INSTALLATION OF OFFICERS.

(When the committee have made their selection, if the selection meets with the approval of the Instituting Officer, he will, on behalf of the Executive Council, or of the High Standing Committee, as the case may be, appoint them the first staff of Officers, and proceed to install them as per the Installation Ceremony found on pages 93 to 104 both inclusive, commencing with the words "The Supreme Secretary will call the roll of the officers to be installed." The Installing Officer may appoint others to office than those selected by the committee. After the officers have been installed the Installing Officer will conclude as follows :)

S. C. R.—Brethren, in behalf of the *Executive Council of The Supreme Court*, I will now install as the officers of this Court, the *Brethren* whose names have been reported by the committee and duly approved by me.

(After the officers have been installed the Instituting Officer will proceed as follows :)

S. C. R.—Brethren, your officers having been duly installed, I congratulate you on the successful performance of a most important ceremony, namely the institution of a new Court in this place. It is by such inaugurations as this that our noble Order will eventually extend its ramifications throughout the civilized world. May the establishment of this Court bind its members together in acts of charity and good-will to mankind, and serve to perpetuate the blessings of social union to the remotest time.



And now, by the authority vested in me by the Constitution and Laws as (*gives his own official title*), I declare that Court—, No.—, of the Independent Order of Foresters is duly and legally instituted for the objects and purposes recognized by the Constitution and Laws of the Order now in force or that may

hereafter be enacted ; and I declare each of you entitled to all the rights and privileges guaranteed to all worthy Foresters by the Constitution and Laws, Rules and Usages of the Order.

Under the Constitution and Laws of the Order, only those of you who have been examined by the examining physician and recommended by him for Temporary Beneficiary membership on Form No. 59, hold the status of Temporary Beneficiary members and those whose medical examinations have been accepted by the Medical Board are Regular Beneficiary members, while all others hold the status of Social members only.

Social members are required to pay Court dues, but they are not entitled to any of the monetary or other material benefits of the Order. You will therefore gain nothing by delaying to be examined ; and unless you are examined, and pass the Medical Board, within three months you will forfeit all the fees and dues you will have paid and will cease to be members of the Order.

Chief Ranger, you will now enter upon the discharge of your duties by seating the Court.



RECEPTION



CEREMONY.

FOR AN OFFICER.

(When receiving a Companion, substitute the word Companion for Brother and the feminine for the masculine form wherever they occur. The officers entitled to Honors when they visit a Court officially are the Officers of The Supreme Court, the Officers of a High Court, the Deputies of the Supreme Chief Ranger, and the Deputies of a High Chief Ranger; Chief Rangers and Past Chief Rangers.

When any of the above named officers or deputies visits a Subordinate Court, he will gain admission to the ante-room in the usual way, and make himself and his rank known to the J.B., who will at once alarm the Court by giving three loud knocks upon the inner door, whereupon the S.B. will immediately open the wicket and the J.B. will inform him of the name and the rank of the visitor. The S.B. will then announce to the C.R. the name and rank of the visitor in waiting, whereupon the C.R. will immediately suspend whatever business is before the Court and receive the visitor at once.)

FOR A SUPREME OR HIGH OFFICER.

J. B.—● ● ● Gives the S.B. the name
and rank of the visitor.)

S. B.—Chief Ranger, I have the pleasure of announcing that _____, the _____, is in the ante-room for the purpose of visiting our Court.



C. R.—The Court will assist me to receive the distinguished visitor with the Honors due to a _____ (*give rank.*) The Honors due to a (*give rank*) are given as follows: ☛ You must assume that attitude when the Court is called up as the visitor enters the door, and remain at “the salute” till the *visitor* is seated. I appoint _____ to act as an escort to the distinguished *visitor*.

(The C.R. will appoint two members of the Court to act as an escort to the visitor and these two should be, as a rule, the two present who hold the highest rank in the Order.)

J. B.—● ● ●

S. B.—(Throws wide open the Door and the Escort and Visitor enter.)



(After the escort and visitor have given the Entersign and received the response, the Senior Escort, who should be on the right of the visitor, will make the presentation as follows:)

Senior Escort.—Chief Ranger, I have the honor to present to you and through you to the Court — (give name), the — (give rank).

C. R.—(Addressing the Visitor by his Rank.)—, we are indeed honored by this visit, and it gives us pleasure to extend to you a most hearty fraternal greeting. You will now be conducted to the “post of honor.”

(The escort will then conduct the visitor to the “post of honor,” where the visitor will be received by the C.R. and after a hearty hand-shake, will be seated therein. The C.R. will then seat the Court. The escort will resume their respective places.)



C. R.—I have now the great pleasure of introducing to you our distinguished visitor (Giving the name and rank.)

(Members applause.)

FOR A DEPUTY, C.R., OR P.C.R.

J. B.—● ● ● (Gives the S.B. the name and rank of the visitor.)

S. B.—Chief Ranger, I have the pleasure of announcing that Brother (or Companion)— (Give name and rank.) is in the ante-room for the purpose of visiting our Court.

●

C. R.—The Court will assist me to receive the visitor, who is (^{Give the}_{visitor's rank.})——, with the honors due to that rank. The Honors due to a (^{Give}_{rank.}) are given as follows: ● You will assume that attitude when the Court is called up as the visitor enters the Court, and remain in that attitude till the *visitor is seated*. Senior Beadle, permit the visitor to enter.

(The S.B. will then permit the visitor to enter the Court, and as *he* enters, the Court will be called up and give the salutation.)

● ● ●

(After the visitor has given the Entersign in the usual way, the C.R. will give the Countersign and proceed as follows:)

C. R.—Brother (or *Companion*)——, I am glad to have the privilege of giving you a cordial welcome to our Court. Be good enough to approach the dais and occupy the “post of honor” upon my right.



RECEPTION



CEREMONY.

FOR THE S.C.R. WITH THE GUARD OF HONOR.

J.B.—●●● Inform the Court that the Supreme Chief Ranger is in the ante-room for the purpose of visiting the Court.

S.B.—Chief Ranger, I have the pleasure of announcing that the Supreme Chief Ranger is in the ante-room for the purpose of visiting our Court.

(All other business will be immediately suspended and the reception proceeded with at once.)

C.R.—The Court will assist me to receive our Supreme Chief Ranger with the honor due his exalted rank.

The manner of according the honors due to the Supreme Chief Ranger is by giving the Supreme Court Salutation which is given thus ♪, and the "Royal Salute" which is given thus ♪. The Supreme Court salutation will be given at the moment the S.C.R. enters the Court Room and the "Royal Salute" will be given after the Countersign has been given by me.

The Past Chief Ranger and the Guard will now retire and escort the Supreme Chief Ranger to the Pedestal.

C.G.—Guard, fall in! (at the Pedestal) Guard, halt, dress! Eyes front!

C.G.—Guard, right turn, quick march! Mark time! Forward!

RETIRING OF THE ESCORT.

(The Guard will fall in, proceed to the Pedestal, salute and retire as per Diagram A. Immediately after the Guard has saluted, the Past Chief Ranger will proceed to the Pedestal and salute, upon which the Guard will

reform into two lines and march to the ante-room as laid down in Diagram A. As the last files of the Guard turn *south* the Guard will mark time till the P.C.R. reaches *his* place between the C. and St. B., when the Guard will march forward escorting the P.C.R. as they retire. When the Supreme Chief Ranger is ready to enter, the J.B. will give three loud knocks on the door.)

J. B. — ● ● ●

S. B. — (Throws wide open the Door and the Escort and Visitor enter.)



DIAGRAM A.

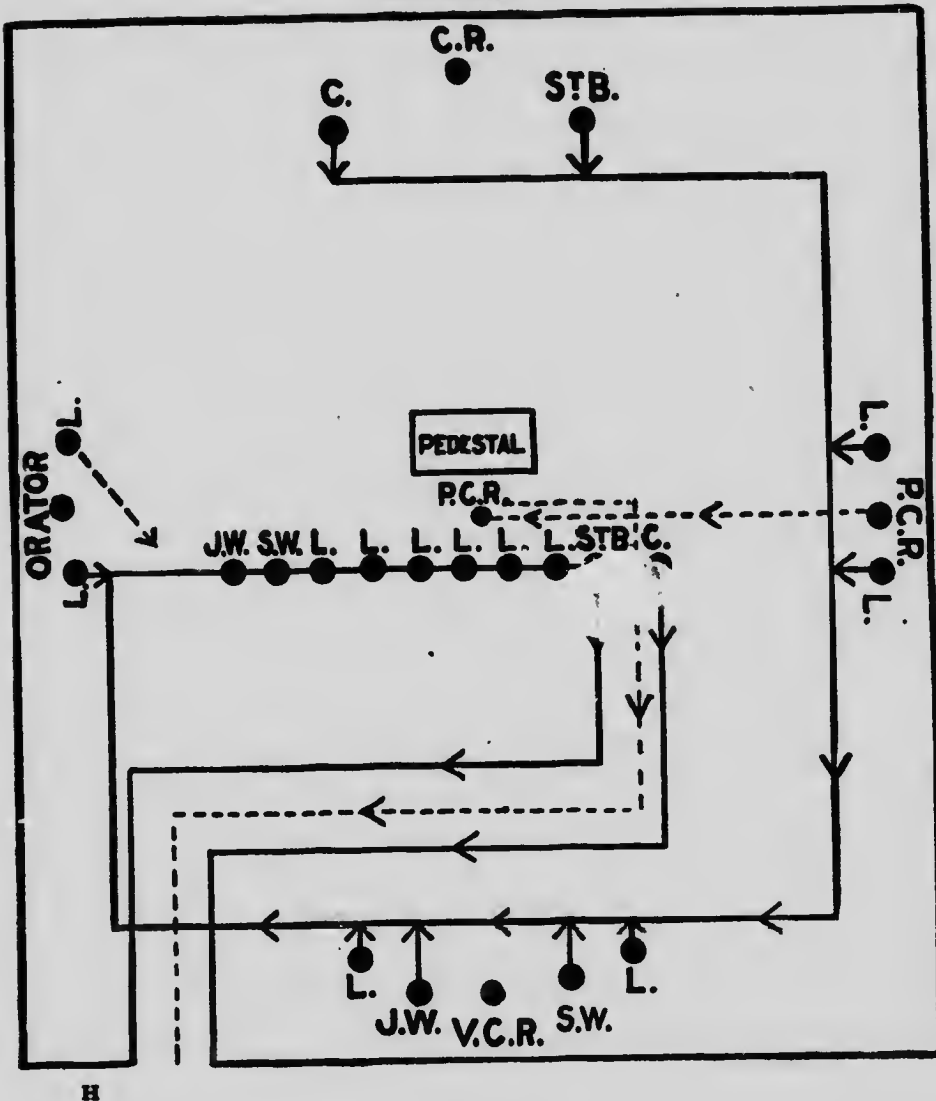

(As the S.C.R. enters the Court Room The *Supreme Court salutation* will be given, and the members will remain in position until the S.C.R. has been escorted to the Pedestal where the Guard will halt and form the "Arch of Honor" without word of command, as indicated in Diagram B. After the S.C.R. has given the Entersign and received the response, the P.C.R., who stands on the right of the S.C.R., will present the S.C.R. as follows:)

RECEIVING THE SUPREME CHIEF RANGER.

DIAGRAM B.

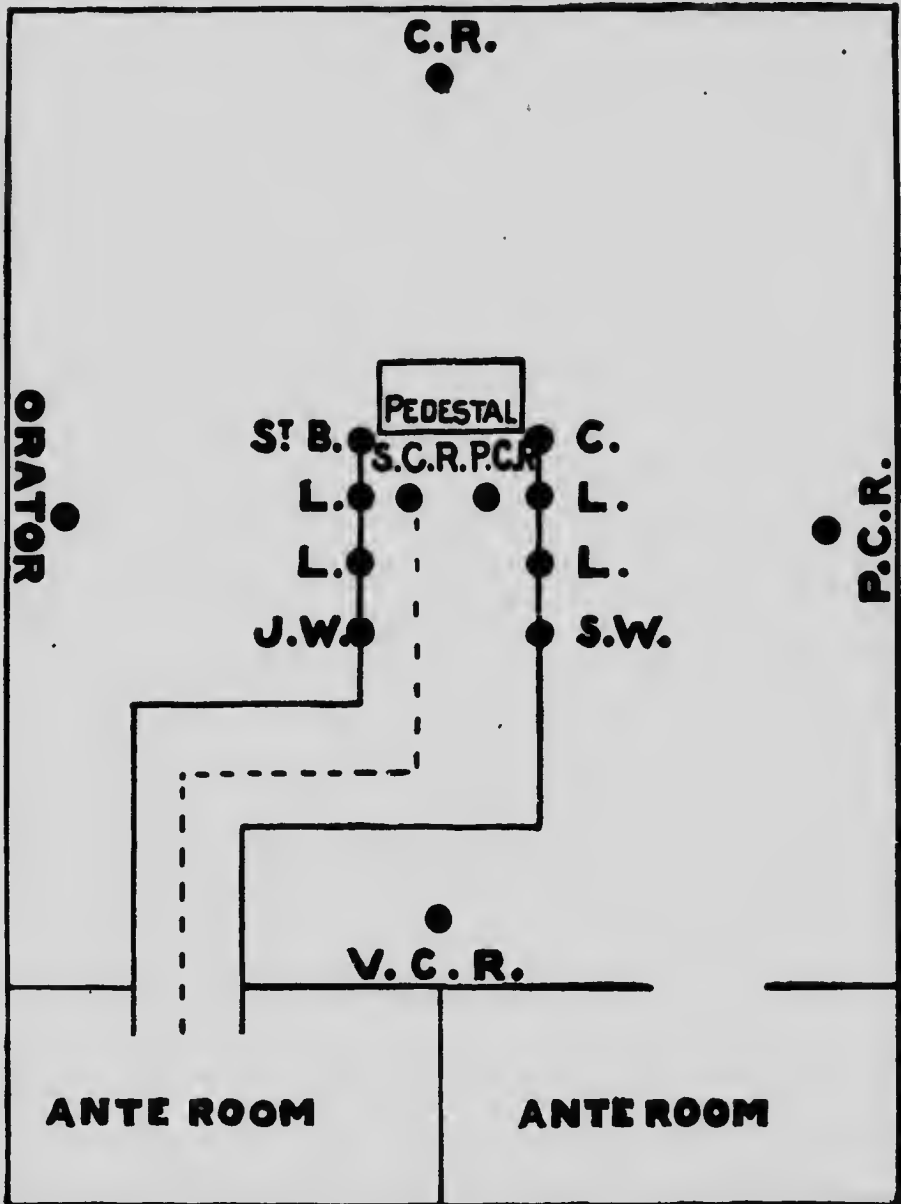

P. C. R.—Chief Ranger, I have the honor to present to you and through you to the Court, our Supreme Chief Ranger.

C. R.—*Brethren*, join me in giving the honors to the Supreme Chief Ranger, taking time from me. (The Royal Salute is then given) Supreme Chief Ranger, we are indeed honored by this visit and it gives us pleasure to extend to you a most cordial and hearty greeting. You will now be conducted to the "Post of Honor."

(The escort will then conduct the visitor to the "Post of Honor," as indicated in Diagram C, where he will be received by the C. R., and after a hearty hand-shake, will be seated therein. The C. R. will then seat the Court. After which the Guard of Honor will escort the P. C. R. to his seat and then resume their respective stations in the Court.)

DIAGRAM C.

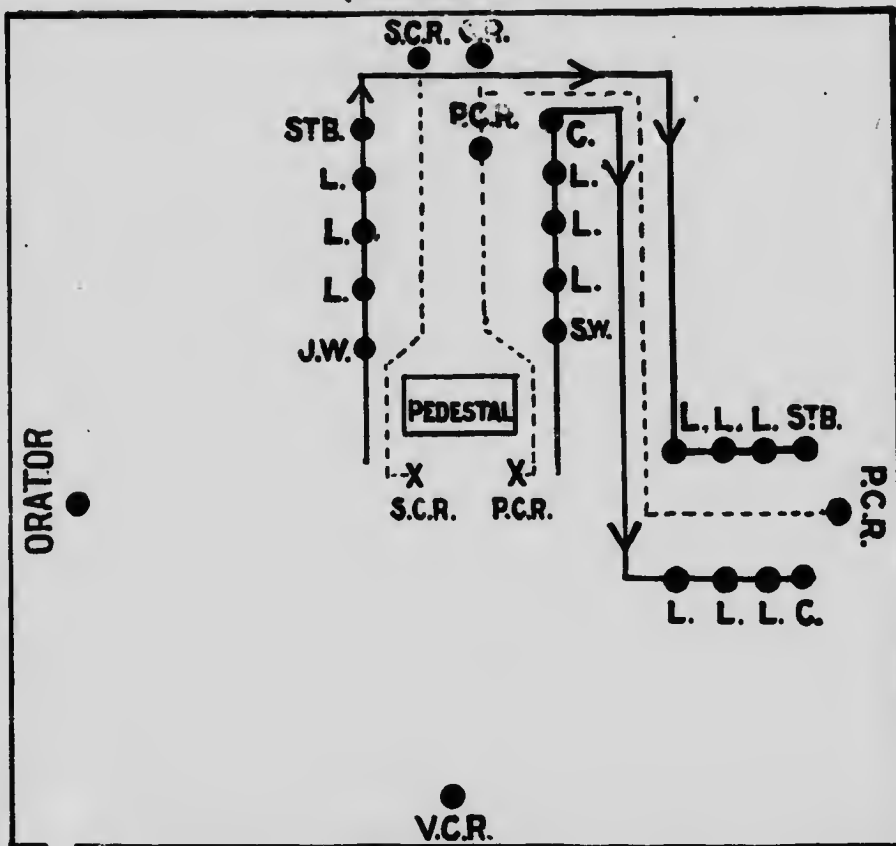

DEDICATION



CEREMONY.

(If the ceremony is to be performed in secret session, the Court will be opened in due form, and the Supreme or High officers will be received with the regular honors; if a public Dedication, the meeting will be simply called to order, when the officers will take their stations, the honors being omitted. The Supreme or High officers, in proper regalia, will assemble in the ante-room, and when ready the S.M. or H.M. will give the usual alarm. If the High officers are officiating substitute the word "High" for the word "Supreme" wherever it occurs.)

S. M.—● ● ●

S. B.—Chief Ranger, there is an alarm at the inner door.

C. R.—Ascertain the cause of the alarm, and report to me forthwith.

(The S. B. opens the wicket, ascertains the cause, and reports as follows:)

S. B.—Chief Ranger, I have to report that the alarm was caused by the Supreme Marshal demanding admittance for the *Supreme* Chief Ranger and his officers.

C. R.—Admit the distinguished officers in the name of Liberty, Benevolence and Concord.

S. B.—(^{Throws Door}_{wide open.}) By command of the Chief Ranger I bid you welcome in the name of Liberty, Benevolence and Concord.



(The Supreme or High officers will pass to the centre of the room and stand facing the chair; if in secret session, the honors will be given.)

C. R.—Respected *Supreme* Chief Ranger and officers of *The Supreme Court*, in behalf of Court

———, No.—, I welcome you to our Forest Home and request that you will occupy the place of honor in the Court.



(The officers of the Court then vacate their stations and the Supreme or High officers occupy them. The C.R. will deposit the keys of the hall on his pedestal, and take a seat on the left of the chair. The S.C.R. or H.C.R. will then appoint four *brothers*, recommended by the C.R. as S. or H. Heralds. The S. or H. Heralds will wear blue sashes; and will take their stations, the S.H. of the East about eight feet in front of the C.R.'s chair, the S.H. of the West the same distance in front of the V.C.R.'s chair, the S.H. of the North the same distance in front of the Orator's chair, and the S.H. of the South the same distance in front of the P.C.R.'s chair. As each Herald is about to make the Proclamation of Dedication he will light the "Symbolic Great Light" [made of salt, profusely sprinkled with alcohol or methylated spirits], placed on the pedestal in front of each Herald.)

C.R.—*Supreme* Chief Ranger, we have met you here to announce that this Temple of Benevolence and Charity is finished, and that it is the desire of the Court that it be set apart and dedicated to the purposes and uses of Independent Forestry. I place in your hands the keys of our Forest Home. (Places keys on pedestal.)

S.C.R.—Chief Ranger, officers and members of Court——, No.—, I accept this Temple for dedication to the purposes and uses of Independent Forestry. I congratulate you and the members of our Order upon having so comfortable a Forest Home. Here you are to meet to perform those sacred duties incumbent upon all worthy Foresters; to seek to elevate each other by cultivating all the social virtues and acting in the spirit of true Benevolence. Here you will inculcate upon all, the grand principles of our noble Order, that they may go hence better fitted to carry them out, by visiting the sick, relieving the distressed, burying the dead, protecting the widows and educat-

ing the orphans. May the God of love, peace and charity aid you in this laudable undertaking, and may this Temple of Liberty, Benevolence and Concord long stand as a monument of your zeal in the work for humanity in which our noble Order is engaged.

Members.—So mote it be.

S. C. R.—*Supreme* Marshal, it is my pleasure that this Forest Home shall now be dedicated to Independent Forestry, and that you make proclamation of the same.

S. M.—By command of the *Supreme* Chief Ranger I proclaim that it is his will and pleasure that this Forest Home be now dedicated to the high and noble purposes of Independent Forestry.



S. C. R.—The *Supreme* Orator will invoke the Divine favor on what we are about to do.

PRAYER.

S. Orator.—Great and Merciful Father, direct us in all our ways, that in all our works begun, continued and ended in Thee, we may glorify Thy holy name. Grant that this Temple of Liberty, Benevolence and Concord, about to be dedicated to the purposes of Independent Forestry, may remain as an enduring monument of Thy goodness and mercy, and that charity and good works may go out from its sacred walls to bless humanity, and magnify Thy Holy Name, now and evermore.

Members.—Amen.



S. V. C. R.—

When constant Faith and sacred Hope shall die,
 One lost in certainty, and one in joy,
 Then thou, more happy power, fair Charity!
 Triumphant sister, greatest of the three,
 Thy office and thy nature still the same,
 Lasting thy lamp and unconsumed thy flame,
 Shall stand before the host of heaven confessed,
 Forever blessing, and forever blessed.
 Lord, to Thee we dedicate this sacred Hall,
 And humbly ask upon us blessings all.

S. C. R.—By the authority of The Supreme Court and in the name of the Independent Order of Foresters, I hereby dedicate this Temple of Independent Forestry to works of Benevolence and Charity. May peace, harmony and good-will towards men ever reign within these walls.

Members.—So mote it be.

S. C. R.—*Supreme* Marshal, you have my command to make due proclamation of the Dedication of this Temple of Independent Forestry.

(The S. M. will stand in front of the Chair, below the Dais, facing the S. V. C. R., and make due proclamation.)

S. M.—Men and women, hear ye! By command of the *Supreme* Chief Ranger, I proclaim this Temple duly and legally dedicated to works of Benevolence and Charity. In Liberty, Benevolence and Concord let this proclamation be repeated in the East, and in the West, in the North and in the South.

S. H. of the East.—Hear ye! One and all! By command of the *Supreme* Chief Ranger, I proclaim this Temple duly and legally dedicated to works of Benevolence and Charity.

S.H. of the West.—Hear ye! One and all! By command of the *Supreme* Chief Ranger, I proclaim this Forest Home duly and legally dedicated to works of Benevolence and Charity.

S.H. of the North.—Hear ye! One and all! By command of the *Supreme* Chief Ranger, I proclaim this Temple of Liberty, Benevolence and Concord duly and legally dedicated to works of Benevolence and Charity.

S.H. of the South.—Hear ye! One and all! By command of the *Supreme* Chief Ranger, and in the name of the Independent Order of Foresters, I proclaim the due dedication of this Sacred Temple of Liberty, Benevolence and Concord to the purposes and uses of Independent Forestry; and to God be all the glory and praise now and evermore.

Members.—So mote it be.



S. C. R.—The *Supreme* Orator will invoke the blessing of Heaven on our proceedings.

PRAYER.

S. Orator.—We humbly beseech Thee, O Merciful God, to bless this Temple which has been so earnestly dedicated to the principles of Independent Forestry; endow each and all of us with a competency of Thy Divine wisdom, that through the principles of the Order, and by Thine aid, we may the better be enabled to display virtue, benevolence and charity, to the honor and glory of Thy Holy name. Amen.



S. C. R.—Chief Ranger, officers and members of Court —, No. —, I now return to your possession this Temple, dedicated to Independent Forestry. May your labors for the principles of Liberty, Benevolence and Concord, and for Humanity ever prosper; and may the blessing of Heaven rest upon you and all your works.

Members.—So mote it be.

(The S.C.R. will then return the keys of the hall to the C.R.)



ANNIVERSARY



SERVICE.

(In the absence of the Supreme or High officers, the C.R. will preside, and whether public or private all the officers will be in their proper places. The C.R. will appoint a good reader as Herald.)

●

C.R.—Officers and members, we have assembled on this auspicious occasion to commemorate the founding of our noble Order. On the 17th of June, A.D. 1874, in the city of Newark, New Jersey; at a convention of members of the Ancient Order of Foresters there assembled, the Independent Order of Foresters was brought into existence. The foundation then laid, though crude indeed, was destined to be developed into a grand and noble structure. On the 1st of July, A.D. 1881, in the city of Ottawa, Canada, was reared the present Temple of Benevolence and Charity, symmetrical and perfect in all its parts, and which we fervently hope will continue to bless humanity to the remotest time. Already thousands of our fellowmen have been benefited by the Independent Order of Foresters, and we have just reason to believe that generations yet unborn will sing the praises of our noble Order and its grand principles.

● ● ●

C.R.—The Orator will invoke the favor of Heaven upon our present assembly.

PRAYER.

Orator.—Great and Merciful God, we once more assemble in Thy holy name to offer up thanks to Thee for the many blessings Thou hast showered upon our noble Order. Thou hast been our guide, our strength, our wisdom; and upon Thee have we leaned, and not in vain, for all our prosperity. Thou hast favored us in all our undertakings, and our expectations have been more than realized. Prosper and direct us still in the cause of Liberty, Benevolence and Concord, and to Thee, O Father, be all the praise and glory now and for evermore.

Brethren.—Amen.

C. R.—We will now sing the anniversary ode.

ANNIVERSARY ODE.

St. Michael.

1. O! praise our God to - day His con - stant mer - cy bless,
 2. His arm the strength im - parts Our dai - ly toil to bear;
 3. God of the wid - ow, hear! Our work of mer - cy bless;

Whose love hath helped us on our way, And granted us suc - cess.
 His grace a - lone in - spires our hearts Each other's load to share.
 God of the fath - er - less, be near, And grant us good suc - cess.

C.R.—The Herald will read the proclamation of the Supreme (*or High*) Chief Ranger.

(The Herald will then read the proclamation.)

C.R.—Vice-Chief Ranger, what are the principles of the Independent Order of Foresters?

(The officers will rise as they respond.)

V.C.R.—Chief Ranger, Independent Forestry is a benevolent Order, based upon the broadest principles of mutual aid and fraternal intercourse in all the social and business relations of life. Its grand object is to unite in one true brotherhood all good men, without regard to sectarian creeds, political dogmas, or conditions in life; to provide for relief in sickness or disability; to establish, upon the mutual aid plan, a fund for the relief of widows and orphans of deceased members; to foster a spirit of co-operation in all departments of labor and commerce; to assist the unfortunate and relieve the distressed; to encourage and protect the professional man, laborer, artisan, tradesman, farmer, and all engaged in industrial pursuits.

C.R.—Past Chief Ranger, what do the principles of our Order teach us?

P.C.R.—Chief Ranger, we are taught by the principles of the Order to be sober, upright and conscientious, willing to help, ready to relieve, and obedient to the laws of our country. In our domestic relations we are taught as husbands, to be affectionate and trustful; as fathers, regardful of the moral and material well-being of our children and dependents; as sons, to be dutiful and exemplary; as friends, to

be steadfast and true. Every Court, from the very nature of our Constitution and Laws, and by reason of the objects, duties and responsibilities which they impose upon the membership, should promote the moral, social and intellectual welfare of those connected with the Order. To carry out more efficiently the aims of our noble Order, all good men are invited to unite together as co-workers in the Independent Order of Foresters.

Orator.—God speed the heavenly mission of our noble Order; onward be its progress, until misfortune has ceased to exist and there shall be no more want to relieve, and “sorrow and sighing shall flee away.”

Members.—So mote it be.

C. R.—Officers and members, let us all emulate the heroes of humanity who have gone before us; and by self-denying devotion to our Order, by conscientious uprightness in all our dealings, and by ever keeping in mind that “Pure religion and undefiled before God and the Father is this: to visit the fatherless and widows in their affliction, and to keep himself unspotted from the world,” endeavor to uphold the honor and advance the prosperity of the Independent Order of Foresters.

Members.—So mote it be.

(The oration, music, and such other exercises as the Court may have determined upon will now follow.)



C. R.—We will now conclude this Anniversary service by singing the Foresters' Anthem.

FORESTERS' ANTHEM.

Red, White and Blue.

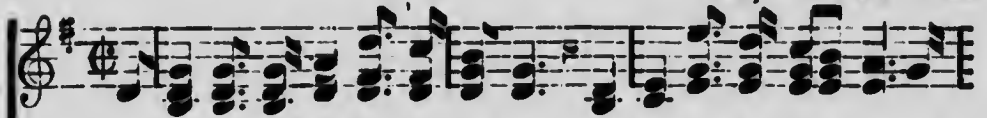

1 Our Order, from ocean to ocean, As firm as an ad - a - mant,
 2 Our Order stands on a found - a - tion Of "Lib - er - ty" and pure "Con -

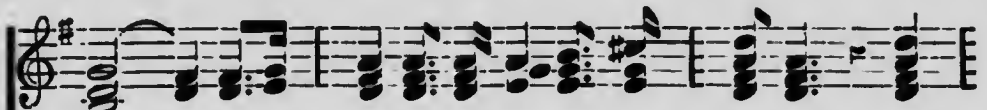
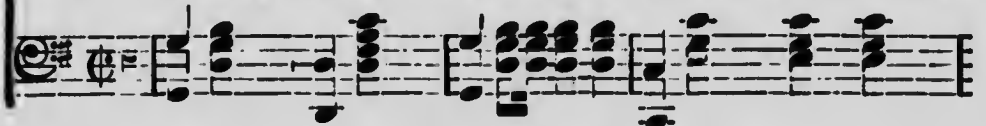

stands, We'll pledge it our warmest de - vo - tion, We'll
 cord," It joins every creed, every na - tion, With

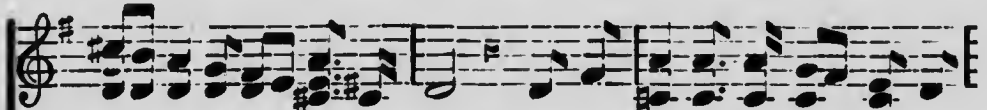

np - hold it with our trusty hands, When want or grim sor - row op -
 "Be - nev - o - lence" its watchword, The load of the weary it light -

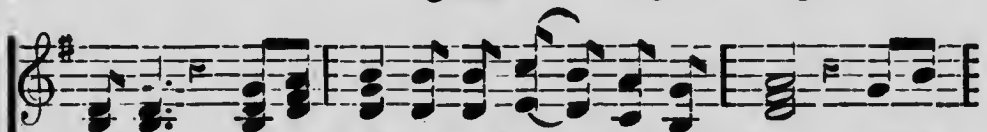
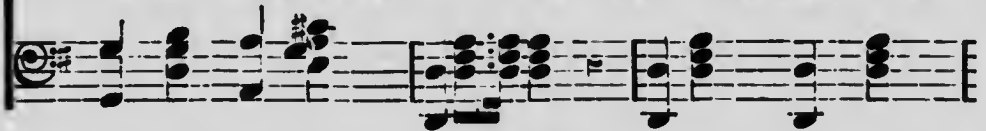

presses, It comes as a friend, strong and true; Like
 ens, Un - der the "Red, White and Blue;" The

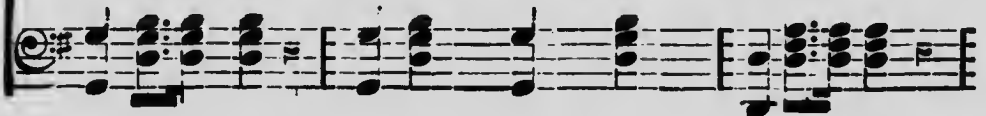

an an-gel of light it blesses
dark clouds of sorrow it brightens

Mankind 'neath the "Red, White and Blue."
'Neath the glorious "Red, White and Blue,"

Chorus

Three cheers for the "Red, White and Blue!" Three cheers for the "Red, White and

Blue!" The I. O. F. col - ors for - ev - er! Three cheers for the red, white and blue

C. R.—The Orator will now close with the Benediction.

BENEDICTION.

Orator.—To God, the Supreme Ruler of the Universe, be ascribed all the glory, might, majesty and dominion; and may the blessing of God, our Heavenly Father, be with us all now and evermore. Amen.

BURIAL



SERVICE.

(Whenever the Supreme officers are present they shall officiate, and in their absence the officers present who are next highest in rank shall conduct the ceremony as acting Supreme officers. There shall be a Chief Marshal and Orator appointed by the senior officer present, and Assistant Marshals by the C.R. of each of the Courts taking part—one Assistant Marshal for each Court. The Court Regalia, or emblems, properly draped with crape, shall be worn, except when the weather is unfavorable, or likely to be, in which case the brethren will wear black crape around the left arm fastened by a narrow piece of white ribbon; a small bow of black and white crape, on which a sprig of evergreen is fastened, is to be worn on the regalia, or, when the regalia is not used, then the bow must be worn on the right breast; the Supreme Marshal, or the Chief Marshal, in addition to that which each member wears, shall wear a sash of black and white crape, about four inches wide when joined, passing over the left shoulder, and shall carry a white baton trimmed with white and black crape; the Assistant Marshals shall wear over the left shoulder sashes of black crape only, and shall carry a white baton trimmed with black crape; the pall-bearers shall wear heavy white crape sashes trimmed with black, and black gloves; the officers and the members shall wear white gloves. The officers and members will form in procession two abreast, according to rank and precedence, being careful to observe that there is from six to ten feet of space between themselves and the next two in front, and will leave the Court room to proceed to the house in the following order:)

THE PROCESSION.

- (1) The Supreme, or High, or Chief Marshal, six to ten feet in advance.
- (2) The officiating Orator and Court Physician.
- (3) The members of the Order.
- (4) The officers of Courts according to rank.
- (5) The officers of the mourning Court.

(6) The Royal Foresters.

(7) The Supreme or High officers, according to rank, the highest rank being in the rear.

(On arriving at the house they will halt, open ranks and reverse.)

CEREMONY AT THE HOUSE.

(If desired, the following ceremony may be used at the house. If thought best the two ceremonies may be used at the grave.)

S. Orator.—Let us pray.

PRAYER.

Great and Merciful Sovereign of the Universe, in whom we live and move and have our being, and before whom all must hereafter appear and render an account of the deeds done in the body, we earnestly beseech Thee to deeply impress upon our minds the solemnity of this hour. And, O Merciful God, Thou who art the father of the widow and the orphans, we beseech Thee to look down in pity and love upon the stricken mourners; sustain and comfort them in this the hour of their sore affliction; and finally, by Thy infinite mercy, gather them all home into Thy everlasting kingdom.

The Members.—Amen.

(The following ode, or other suitable music, may then be sung at the discretion of the S.C.R.)

REST, WEARY HEART.

1. Rest, weary heart, (From all thy silent) se - cret pain, (Thy profitless regrets)
 griefs and and
 2. Rest, weary head, (Lie down to slumber) peace - ful tomb, (Light from above has)
 in the broken
 3. Rest, spirit free, (In the green) heav'nly shore, (Where sin and sorrow)
 pastures of the can ap -

long - ings vain; Wis - dom and love have or - dered all the past.
 thro' its gloom; Here, in the place where once the Sa - viour lay,
 proach no more; With all the flock by Christ the Shepherd fed,

All shall be bless - ed - ness and light at last; Cast off the
 Where He shall wake thee on a fu - ture day, Like a tired
 Be - side the stream of life e - ter - - nal led; For ev - er

cares that have so long op - pressed, Rest, sweet - ly rest.
 child up - on its mo - ther's breast, Rest, sweet - ly rest.
 with thy God and Sa - viour blest, Rest sweet - ly rest.

S.C.R.—In the midst of life we are in death. We live but to see those we love pass away into the silent tomb.

S. Orator.—“I am the resurrection, and the life: he that believeth in Me, though he were dead, yet shall he live: and whosoever liveth and believeth in Me shall never die.”

P.S.C.R.—Glory be to Thee, O Lord. (May be sung by Choir.)

The Members.—Amen.

S. C. R.—“What man is he that liveth, and shall not see death? Shall he deliver his soul from the hand of the grave? Man walketh in a vain shadow; he heapeth up riches, and cannot tell who shall gather them. Man dieth, and wasteth away: yea, man giveth up the ghost, and where is he?”

S. Orator.—“Yea, though I walk through the valley of the shadow of death, I will fear no evil: for thou art with me; Thy rod and Thy staff they comfort me.”

P.S.C.R.—“The Lord gave, and the Lord taketh away; blessed be the name of the Lord.” (May be sung by Choir.)

The Members.—Amen.

S.C.R.—“Behold, Thou hast made my days as it were a span long: and my age is even as nothing in respect of Thee; and verily every man living is altogether vanity.”

S. Orator.—“I heard a voice from Heaven, saying unto me, Write, from henceforth blessed are the dead who die in the Lord; even so saith the Spirit; for they rest from their labors.”

P.S.C.R.—Glory be to Thee, O Lord! (May be sung by Choir.)

S.C.R.—“Thou hast set our misdeeds before Thee; and our secret sins in the light of Thy countenance. For when Thou art angry all our days are gone; we bring our years to an end, as it were a tale that is told.”

S. Orator.—“Behold, I show you a mystery. We shall not all sleep, but we shall all be changed, in a moment, in the twinkling of an eye, at the last trump, (for the trumpet shall sound), and the dead shall be raised incorruptible, and we shall be changed. Then shall be brought to pass the saying that is written, Death is swallowed up in victory. O death, where is thy sting? O grave, where is thy victory?”

P.S.C.R.—“The Lord gave, and the Lord taketh away; blessed be the name of the Lord.” (May be sung by Choir.)

The Members.—Amen.

(The following ode, or other suitable music, may be sung at the discretion of the S.C.R.)

NEARER, MY GOD, TO THEE.

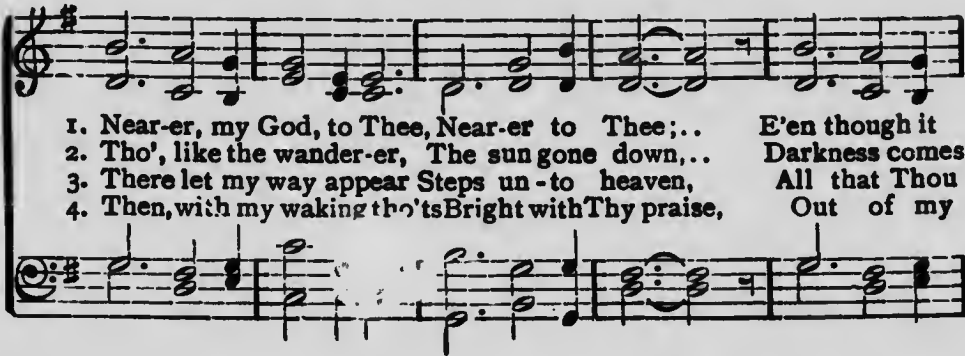

1. Near-er, my God, to Thee, Near-er to Thee;... E'en though it
 2. Tho', like the wander-er, The sun gone down,.. Darkness comes
 3. There let my way appear Steps un-to heaven, All that Thou
 4. Then, with my waking tho'ts Bright with Thy praise, Out of my

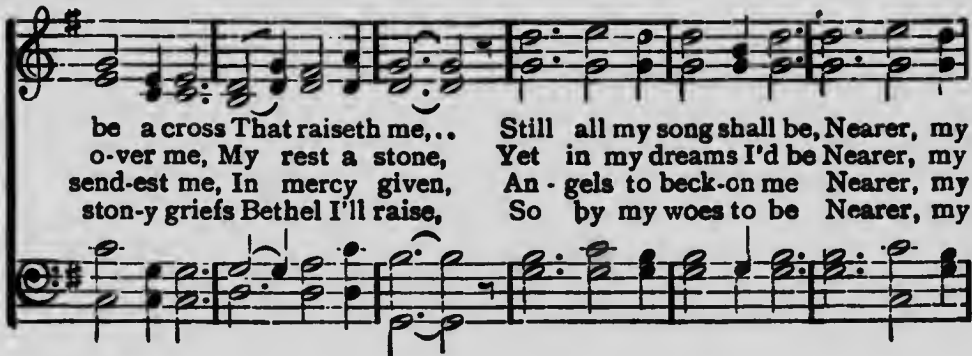

be a cross That raiseth me,.. Still all my song shall be, Nearer, my
 o-ver me, My rest a stone, Yet in my dreams I'd be Nearer, my
 send-est me, In mercy given, An-gels to beck-on me Nearer, my
 ston-y griefs Bethel I'll raise, So by my woes to be Nearer, my



God, to Thee, Near-er, my God, to Thee, Near-er to Thee.....
 God, to Thee, Near-er, my God, to Thee, Near-er to Thee.....
 God, to Thee, Near-er, my God, to Thee, Near-er to Thee.....
 God, to Thee, Near-er, my God, to Thee, Near-er to Thee.....

BURIAL CEREMONY.

(The procession will leave the house in the following order, to wit:)

- (1) Doctor and Clergyman.
- (2) Officers and members of Courts; those of the mourning Court being in the rear.
- (3) The Hearse accompanied by the Pall-bearers. { There must always be *nine* Pall-bearers, the position of the *ninth* being immediately in rear of the hearse.
- (4) The Mourners.
- (5) The Royal Foresters.
- (6) The High Court Officers, according to rank, the highest being in the rear.
- (7) The Supreme Court Officers, according to rank, the highest being in the rear.

ARRIVAL AT THE CEMETERY.

(As soon as the last file of the Officers and members of the Courts have passed the cemetery gates, they will halt, open ranks, turn inward and each place the left hand over the heart, at the same time slightly advancing the left foot, remain in that position until the hearse, the mourners, the Royal Foresters, the High Court and the Supreme Court Officers have passed through between the ranks and then fall in behind and resume the procession to the grave.)

ARRIVAL AT THE GRAVE.

(The two leaders of the Royal Foresters, when they reach the head of the grave, will separate, marching to the right and left in a circle till they meet again when they will all halt and turn inward, as indicated by the Rs. in Diagram No. 25. A gap will be left in this circle wide enough for the S.C.R., the P.S.C.R. and the S. Orator, as well as any other Supreme or High Officers who may be present, to take their positions at the head of the grave. The Pall-bearers will take position, four on the right and four on the left of the grave, while the ninth will take position at the foot of the grave, as indicated by the Ps. on Diagram No. 25. The S.C.R., the P.S.C.R. and the S. Orator will take positions at the head of the grave; other Supreme and High Officers will take positions on the right and left of the P.S.C.R. and the S. Orator; the Officers and members of the Courts will form in another circle around the others as indicated in the Diagram by the Fs. This circle, as well as that of the Royal Foresters, may be doubled or trebled as the number in attendance may require.)

If a Royal Forester is being buried, the Pall-bearers must be Royal Foresters, and when the S.C.R. begins the funeral address they will form the Arch of Steel over the grave, while all others will place the left hand over the heart, at the same time slightly advancing the left foot, which is the "burial attitude"; all will remain in the positions thus assumed until the S.C.R. has finished the funeral address.

If the deceased was not a Royal Forester the Pall-bearers will, instead of forming the Arch of Steel, each close all the fingers of the right hand over the thumb except the index finger, raise the arm so as to form a right angle at the elbow, and point the index finger heavenwards. They will remain in this attitude until the S.C.R. has finished the funeral address. After the usual religious ceremonies are performed, the S.C.R. or acting S.C.R., who stands at the head of the grave, will proceed as follows, using the feminine form whenever necessary if burying a Companion:)

DIAGRAM NO. 25.

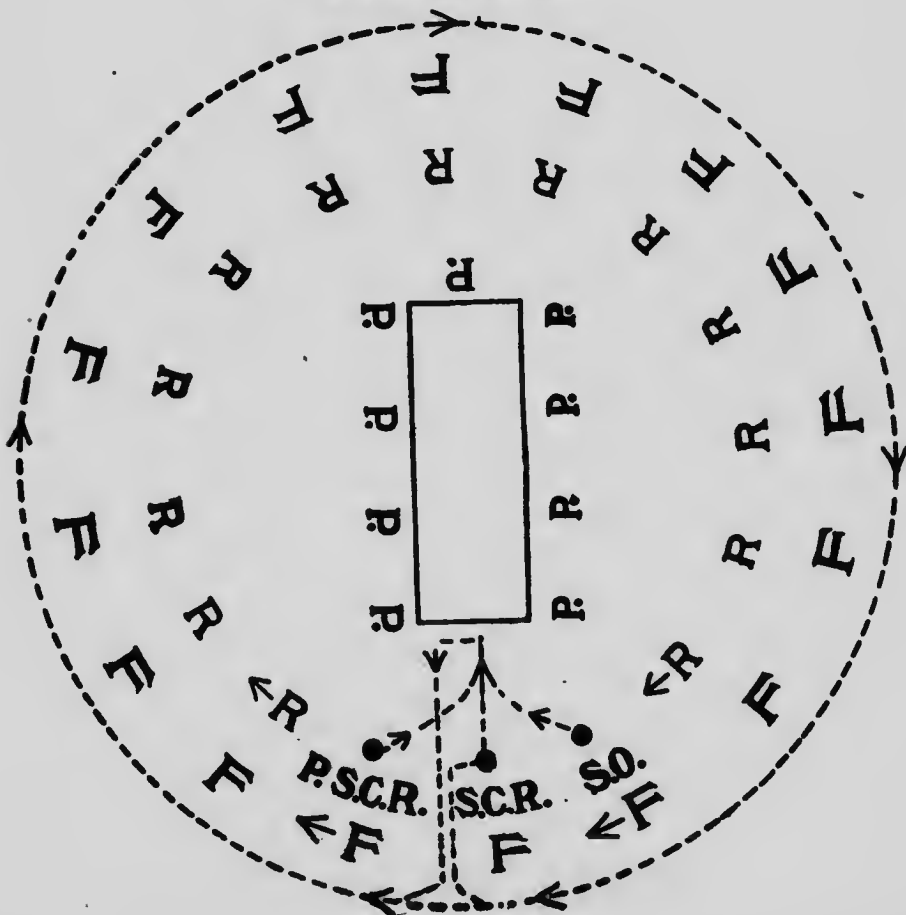

S.C.R.—We are assembled upon this solemn and mournful occasion, in obedience to the dictates of duty, and in conformity to the expressed wishes of our deceased *brother*, to perform the last sad rites which the living may render to the dead, by depositing the mortal remains of our late *brother* in their final resting place, where all ranks are levelled, and all distinctions swept away.

Our Father in Heaven, “who doeth all things well,” having, in His infinite wisdom, summoned our *brother* from the cares and anxieties of this life, we desire humbly to bow in submission, and pray for grace to say “Thy will be done.”

No more shall we gaze on the genial smile of our worthy *brother*, nor clasp *his* hand of welcome; no more respond to *his* Forestric signal, nor behold *him* in the happy circle formed in Liberty, Benevolence and Concord. The throbbing heart that beat responsive to the claims of humanity, the noble impulses that inspired *his* energies, and the earnest tones that pleaded so fervently for the principles of our noble Order, all are hushed and silent for ever.

May these mortal remains remind us of our own approaching end, and serve to stimulate us to greater works of benevolence and charity. May we have strength from on High to so regulate our conduct, that, guided by the dictates of unerring wisdom, we may enjoy in the latter period of our earthly existence, that tranquillity which flows from an unsullied conscience, even “the peace of God which passeth all understanding.”

Officers and Members.—So mote it be.

(As soon as the S.C.R. has finished the address he will advance to the head of the grave and throw his sprig of evergreen into the same, turning to the left about, and march forward straight from the head of the grave until he has passed through the outer circle of the Officers and members of the Courts, then turn to his right and pass around the outer circle back to his original position at the head of the grave.)

As soon as the S.C.R. starts for the head of the grave, the P.S.C.R. will turn to his right and step to the position just vacated by the S.C.R. and then follow the S.C.R. The S. Orator will turn to the left and follow the P.S.C.R.

As soon as the S. Orator moves, the Royal Foresters in the circle will turn to the left and follow the S. Orator, depositing their sprig of evergreen as they pass the head of the grave; then march around the outer circle, in the footsteps of the S.C.R., back to their original positions.

When the last of the Royal Foresters approaches the head of the grave, those in the outer circle will turn to the left, and the Forester who stood at the left hand of the S.C.R. as he passed through the outer circle, will march towards the head of the grave followed by the others in that circle and as each reaches the head of the grave, will throw therein the sprig of evergreen and likewise follow in the footsteps of the S.C.R. round the grave back to the starting point.

Whenever there is more than one circle, either among the Royal Foresters or among the Officers and members of the Courts, the marching will be done by the circles in succession, the first to move being the outer one.

When the S.C.R. gives the order to form the "Circle of Concord," the Officers and members and the Pall-bearers will again assume the "burial attitude," except if there be Royal Foresters in uniform in attendance, they will, this time, "present arms" and the Pall-bearers as they reform the Arch of Steel will tap each other's swords *nine* times in groups of *three* taps, the taps being made in quick succession, with a distinct pause between each group of *three* taps. This done, the brethren will form the "Circle of Concord," which is done by each crossing his arms in front and linking his right hand with his left neighbor's left hand, and his left hand with his right neighbor's right hand, then elevating the hands so linked three times; after which the procession will be reformed in the same order as when leaving the Court Room and march back to the cemetery gate or to the Court Room and then disperse.)

S.C.R.—This evergreen is symbolical of the immortality of the soul, and teaches us not to mourn for the dead as they who are without hope.

(After all have deposited the sprig of evergreen and have returned to their respective stations, the S.C.R. will give the order to form the "Circle of Concord.")

S.C.R.—Let the "Circle of Concord" be formed.



THE CEREMONY OF LAYING A CORNER STONE.

(The Corner Stone whenever practicable should be laid in the north east angle of the building. The masonry should be built up to the level on which the Corner Stone is to be laid. A cavity should be made in the stone which is intended to be placed immediately *under* the Corner Stone, say about 6 inches by 12 inches, by 6 inches deep, and a tin box made to fit into such cavity. The coins of the country, previously placed in a small bottle and hermetically sealed, together with the records and documents intended to be placed under the Corner Stone, should be placed in the tin box by the architect or superintendent of works, as they are enumerated by the Supreme Secretary from the Tablet. After which the tin box is likewise hermetically sealed, and then handed to the Supreme Secretary, who places the same in the cavity of the stone, after which the ceremony proceeds as laid down in the Ritual. The Supreme Chief Ranger or the officer present who is next highest in rank, shall perform the ceremony of laying the Corner Stone. The Supreme Chief Ranger or ranking officer may, however, delegate his authority to some Distinguished Personage selected for that purpose. The brethren shall assemble at the Court Room, or some other place convenient to the proposed new building, and march in procession, headed by the officers and members of the Court under whose auspices the ceremony is to be performed; next, the members; next, the officers according to rank, the seniors being in the rear; then the Supreme Chief Ranger and the associate Supreme Officers. The procession, upon reaching the place where the Corner Stone is to be laid, will halt, open ranks and reverse. The ceremony will then proceed as follows:)

S. C. R.—The Supreme Secretary will read the Tablet, and see that the Archives are properly placed within the foundation of the ——— to be erected upon these grounds.

(The Supreme Secretary will then read from a manuscript called "Tablet," such descriptions of the building as may have been prepared, together with an enumeration of the articles called "Archives" as may have been determined to place within the foundation of the building. When the Supreme Secretary begins to enumerate the "Archives," he will give the Architect time to place each article in the box. The Architect

will repeat the name of each article after the Supreme Secretary and place it within the box. The Architect will then have the box securely soldered and then hand it to the Supreme Secretary, who then places it in the proper place in the foundation wall, and reports as follows:)

S. S.—Supreme Chief Ranger, the Archives have been properly placed within the foundations of the — to be erected upon these grounds.

S. C. R.—Before we proceed to lay the Corner Stone let us invoke the blessing of Heaven upon what we are about to do.

S. Orator.—Protect us, O Lord, in all our doings with Thy most gracious favor, and further us with Thy continual help, that in all our works begun, continued and ended in Thee we may Glorify Thy Holy Name. Grant, O Merciful Father, that this — to be erected upon these grounds may remain as an enduring monument of Thy goodness and mercy to mankind, and that charity and good-will may go out from its walls to bless humanity and magnify Thy Holy name, now and evermore. Amen.

Officers and Members.—So mote it be.

S. Orator and Officers and Members.—Our Father who art in Heaven, Hallowed be Thy name, Thy kingdom come, Thy will be done on earth as it is in Heaven, give us this day our daily bread, and forgive us our trespasses as we forgive those who trespass against us, and lead us not into temptation, but deliver us from evil, for Thine is the Kingdom, the power and the glory, for ever and ever. Amen.

Officers and Members.—So mote it be.

S.C.R.—Let the Clerk of the Works attend to the mortar, to the end that the Corner Stone may be properly laid.

(The Clerk of the Works will then load the required mortar on the Stone, after which the S.S. will hand the Trowel to the S.C.R., who will give the finishing touches to the mortar and then the Corner Stone will be lowered to its place. The S.S. will next hand the Mallet to the S.C.R., who will then give three taps with it upon the Corner Stone and say:)

S.C.R.—In the name of the Independent Order of Foresters, I hereby lay the Corner Stone of the ———.

(The Architect or Superintendent of Works will then hand the Square to the P.S.C.R. or other person chosen to lay the Corner Stone, who will try the Corner Stone with it, and then the Architect or Superintendent of Works will receive from the P.S.C.R. the Square and hand to him the Level, who will place it on the Corner Stone for a moment and hand it back to the Architect or Superintendent of Works. The Architect or Superintendent of Works will next hand the Plummet or Spirit Level to the P.S.C.R., who will likewise try the Stone with it and return it to the Architect, and then say:)

P.S.C.R.—I proclaim this Corner Stone well and truly laid by ——— (giving title in full).

(If a Distinguished Personage has been chosen to lay the Corner Stone, the ceremony will be altered as follows: When the S.C.R. receives the Trowel from the S.S. he will say as follows:)

S.C.R.—In the name of the Independent Order of Foresters, I ask that ——— will do us the honor of laying the Corner Stone of this ———.

The S.C.R. will then hand the Trowel to the Distinguished Personage, who will therewith give the finishing touches to the mortar; so also when the S.S. hands the Mallet to the S.C.R., that officer will likewise pass the same to the Distinguished Personage, who will give the required three taps upon the Corner Stone, immediately after saying as follows:)

Distinguished Personage.—In the name of the Independent Order of Foresters I hereby lay the Corner Stone of the ———.

(The Ceremony will then proceed, as already laid down, with the exception that when the P.S.C.R. has tried the Corner Stone with the Square, Level and Plummet, he will report to the S.C.R., who will then make the proclamation as follows:)

P. S. C. R.—Supreme Chief Ranger, I find the Corner Stone well and truly laid.

S. C. R.—I proclaim the Corner Stone of the —— well and truly laid by ——.

(Cheers for the King, or President, or other ruler of the country in which the ceremony is performed, and cheers for the personage laying the Corner Stone, followed by music from the band.)



CLOSING



CEREMONY.

(WITH THE GUARD OF HONOR.)

C. R.—Brethren (*Companions*), assist me to close the Court.

C. R.—Financial Secretary, give the name of each member who has paid you since last report and the amount paid by each; also give the name of each suspended member applying for reinstatement on Form No. 15 and the amount of arrears deposited by each of them.

F. S.—Chief Ranger, they are as follows:

(The F.S. will here hand a signed memorandum to the R.S. containing the amounts paid to the F.S. since last report and by whom paid, after which *he* will give the receipts in detail, naming every member who had paid and the amount paid by each; the R.S. will check from the memorandum handed to *him* by the F.S., and afterwards enter the same in the minutes. It is the duty of both the C.D. and the C.R. to see that the R.S. enters the names and amounts in the minutes.)

C. R.—The Recording Secretary will see that the proper 'entries are made in the Records, of the names and amounts just given by the Financial Secretary.

Financial Secretary, you will now turn over to the Treasurer the whole amount of money you have received since the time *he* gave *his* last receipt in your Cash Book and *he* will receipt for the same in your Cash Book.

C.R.—(Rising)—Brethren (*Companions*), the business of the Court having been concluded, I have to thank you for your presence and attention this evening and to impress upon your minds the importance of being present at every meeting of the Court, not only to watch over the interests of the Order, but to take part in our deliberations. I trust you will all be able to be present at our next meeting.

(In Courts where there is no Guard of Honor the C. R. will complete the closing of the Court by saying "I NOW DECLARE THE COURT DULY CLOSED.")

The Captain of the Guard will call the Guard of Honor.

C. G.—Guard, fall in!

C. G.—Guard, halt! Front!

(The Guard, after halting below the Pedestal, as indicated in Diagram No. 26, will salute the chair; will march around the Pedestal, as indicated in Diagram No. 27, and halt, so that the Captain and the Standard Bearer will be below the Pedestal facing the C. R. The Guard will then form the "Arch of Honor" over the Pedestal and remain in position while "Auld Lang Syne" is sung. After which they will come to the "present" and remain in position till "God Save the King" or "My Country 'tis of Thee" is sung. After this they will escort the chief officers to the ante-room as indicated in Diagram No. 28.)

FORMING UP THE GUARD.

DIAGRAM No. 26.

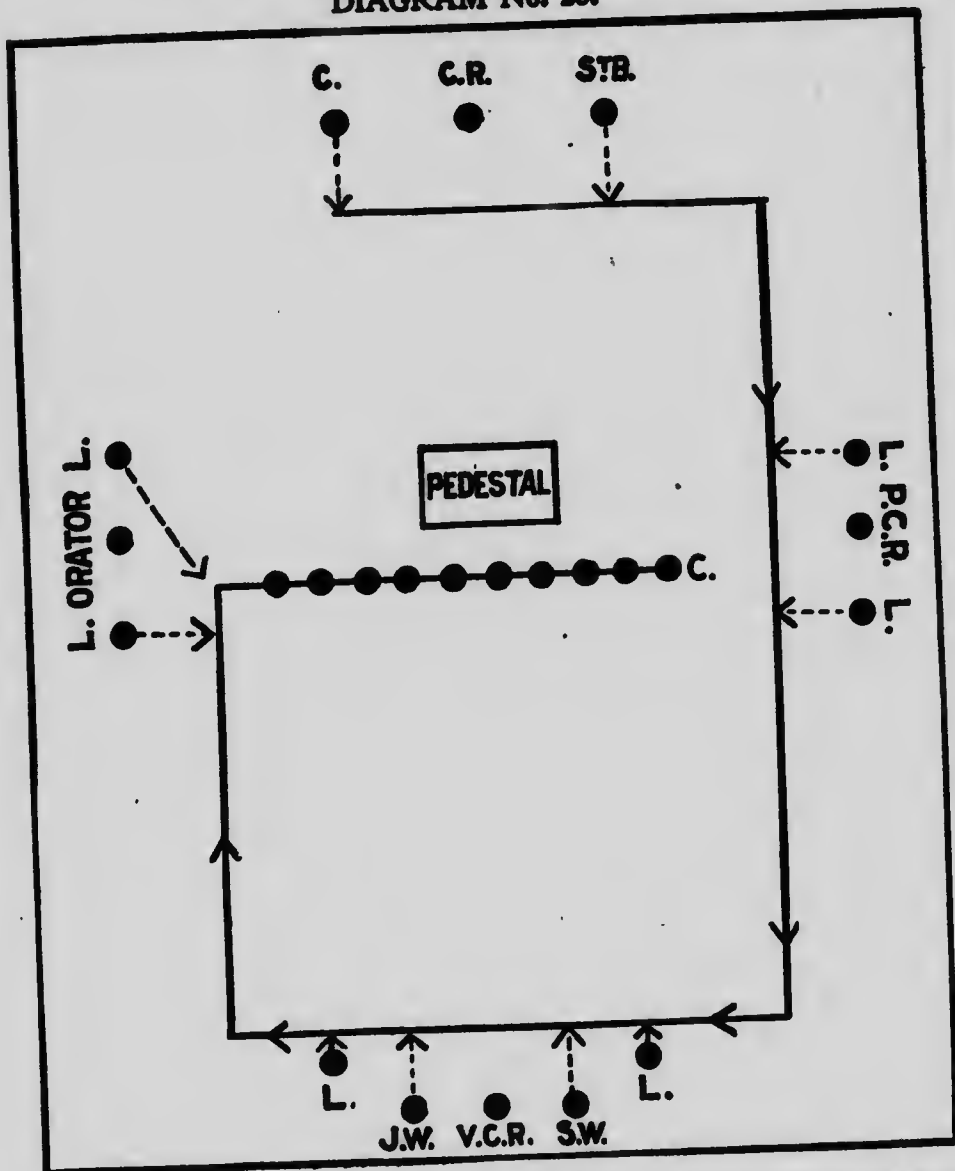

(As the Guard forms up around the Pedestal as indicated in Diagram No. 27, one or more verses of "Auld Lang Syne" will be sung, and a verse of either "God Save the King" or "My Country 'tis of Thee.")



C.R.—The Court will stand closed as soon as the chief officers have retired to the ante-room. The Past Chief Ranger (or the *Financial Secretary*) will take the chair.

DIAGRAM No. 27.

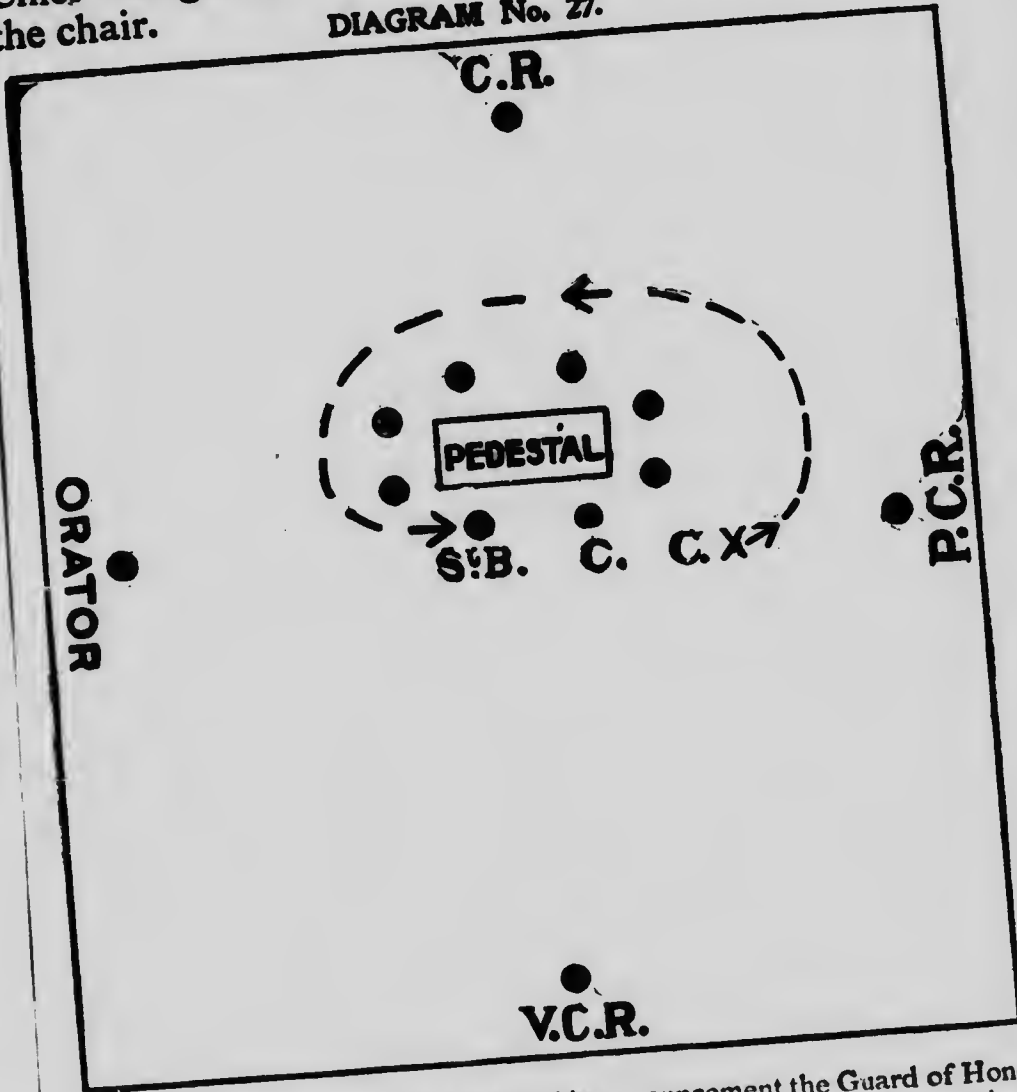

(As soon as the C.R. has made this announcement the Guard of Honor will march as indicated in Diagram No. 28, marking time, at the chair of each of the chief officers long enough to give such officers time to take *his* place between the lines of the Guard. The first officer to be taken up will be the Orator, and then the V.C.R., the P.C.R. next, and lastly the C R , after which they will march out into the ante-room as indicated in Diagram No. 28.)

CLOSING ODE. [AIR—Auld Lang Syne.

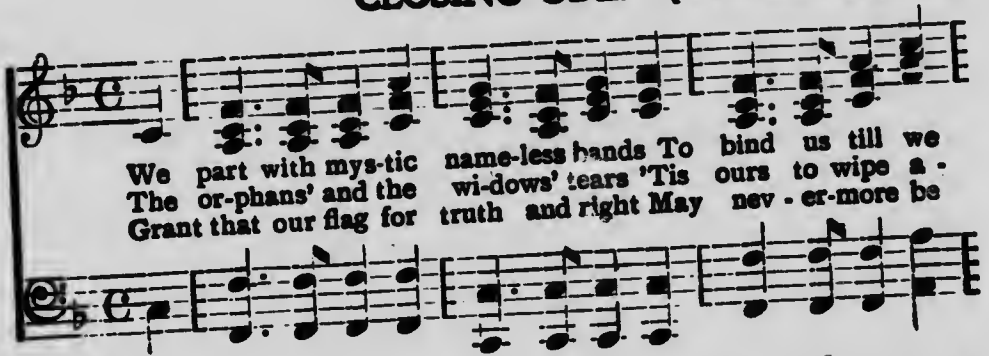

We part with mystic name-less hands To bind us till we
The or-phans' and the wi-dows' tears 'Tis ours to wipe a -
Grant that our flag for truth and right May nev - er-more be

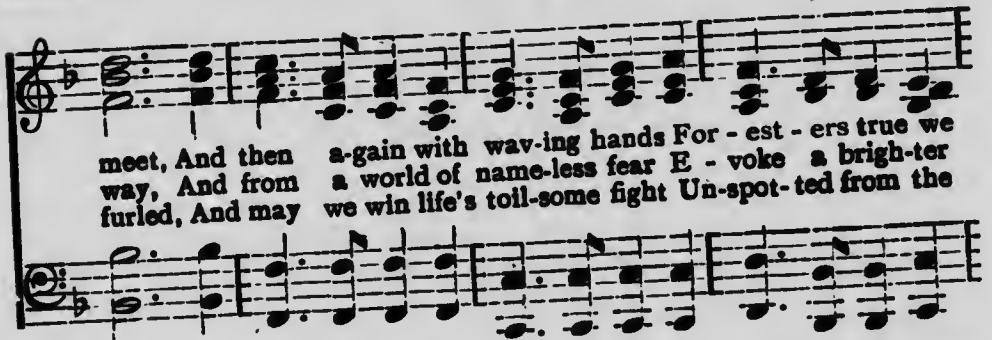

meet, And then a-gain with way-ing hands For - est - ers true we
way, And from a world of name-less fear E - voke a brigh-ter
furled, And may we win life's toil-some fight Un-spot - ted from the



greet. *Chorus.*
day. God help us all from Ran-ger chief To last with-in the line; To
world.

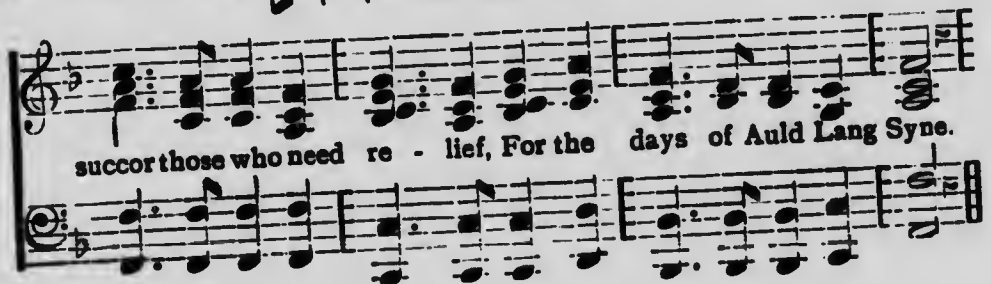

succor those who need re - lief, For the days of Auld Lang Syne.

- C. G.—Guard, right turn! Quick march!
- C. G.—{ Mark time! (at the station of the Orator) { Mark time! (at the station of the P.C.R.)
 { Forward!
- C. G.—{ Mark time! (at the station of the V.C.R.) { Mark time! (at the station of the C.R.)
 { Forward!

RETIRING THE CHIEF OFFICERS.

DIAGRAM No. 28.

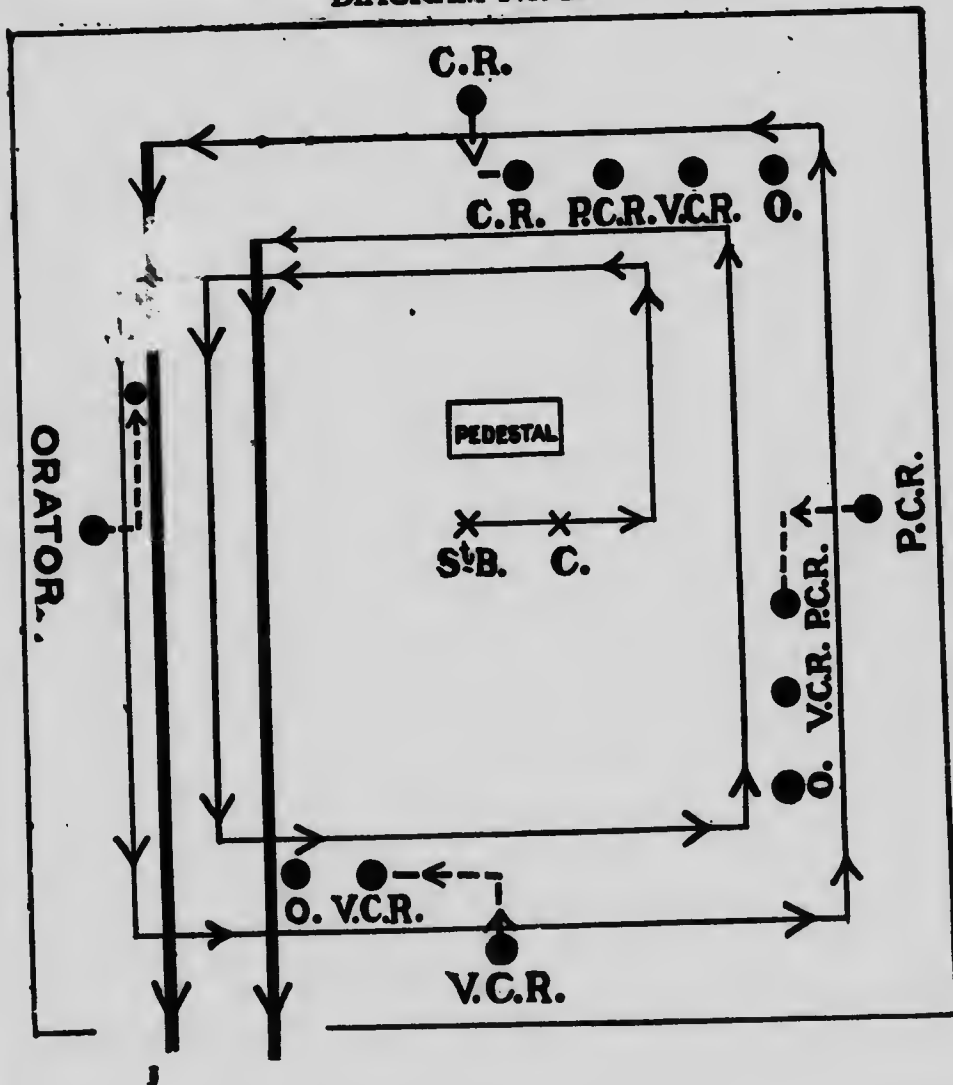

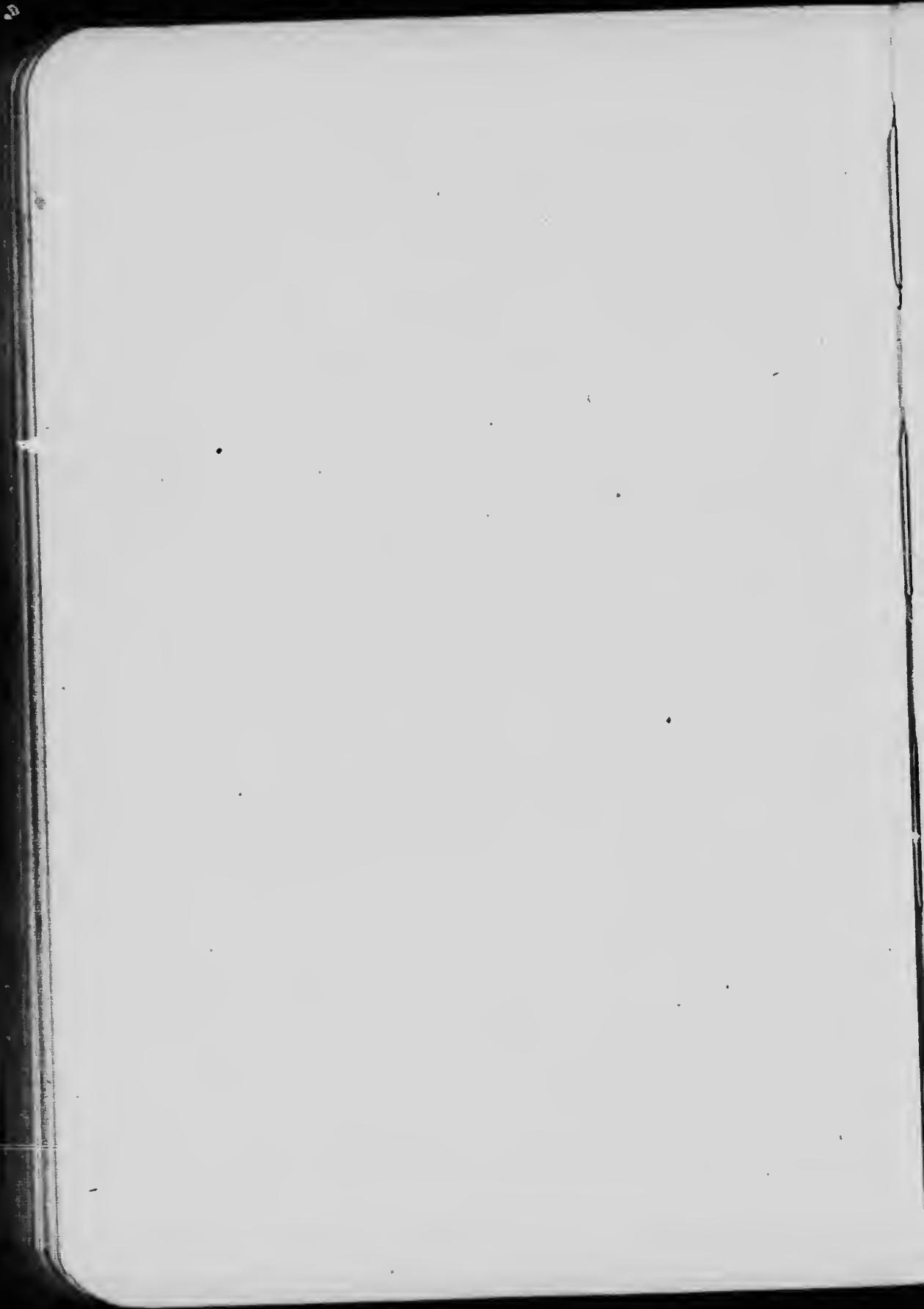

INDEX.

	PAGE
Diagram of Court Room - - - - -	2
General Instructions - - - - -	3
Opening Ceremony - - - - -	5
Order of Business - - - - -	7
Closing Ceremony - - - - -	9
First Initiation Ceremony - - - - -	11
Second Initiation Ceremony (with the R.R.R.) - -	23
Installation Ceremony - - - - -	93
Ceremony of Instituting a Subordinate Court - -	105
Reception Ceremony - - - - -	107
Dedication Ceremony - - - - -	116
Anniversary Service - - - - -	122
Burial Service - - - - -	128
Ceremony of Laying a Corner Stone - - - - -	138

WITH THE GUARD OF HONOR.

Opening Ceremony - - - - -	34
Order of Business - - - - -	47
Initiation Ceremony - - - - -	49
Reception Ceremony for the S.C.R. - - - - -	112
Closing Ceremony - - - - -	142

