

Technical and Bibliographic Notes / Notes techniques et bibliographiques

The Institute has attempted to obtain the best original copy available for filming. Features of this copy which may be bibliographically unique, which may alter any of the images in the reproduction, or which may significantly change the usual method of filming, are checked below.

L'Institut a microfilmé le meilleur exemplaire qu'il lui a été possible de se procurer. Les détails de cet exemplaire qui sont peut-être uniques du point de vue bibliographique, qui peuvent modifier une image reproduite, ou qui peuvent exiger une modification dans la méthode normale de filmage sont indiqués ci-dessous.

Coloured covers/  
Couverture de couleur

Coloured pages/  
Pages de couleur

Covers damaged/  
Couverture endommagée

Pages damaged/  
Pages endommagées

Covers restored and/or laminated/  
Couverture restaurée et/ou pelliculée

Pages restored and/or laminated/  
Pages restaurées et/ou pelliculées

Cover title missing/  
Le titre de couverture manque

Pages discoloured, stained or foxed/  
Pages décolorées, tachetées ou piquées

Coloured maps/  
Cartes géographiques en couleur

Pages detached/  
Pages détachées

Coloured ink (i.e. other than blue or black)/  
Encre de couleur (i.e. autre que bleue ou noire)

Showthrough/  
Transparence

Coloured plates and/or illustrations/  
Planches et/ou illustrations en couleur

Quality of print varies/  
Qualité inégale de l'impression

Bound with other material/  
Relié avec d'autres documents

Continuous pagination/  
Pagination continue

Tight binding may cause shadows or distortion along interior margin/  
La reliure serrée peut causer de l'ombre ou de la distorsion le long de la marge intérieure

Includes index(es)/  
Comprend un (des) index

Title on header taken from:  
Le titre de l'en-tête provient:

Blank leaves added during restoration may appear within the text. Whenever possible, these have been omitted from filming/  
Il se peut que certaines pages blanches ajoutées lors d'une restauration apparaissent dans le texte, mais, lorsque cela était possible, ces pages n'ont pas été filmées.

Title page of issue/  
Page de titre de la livraison

Caption of issue/  
Titre de départ de la livraison

Masthead/  
Générique (périodiques) de la livraison

Additional comments: / Commentaires supplémentaires: Various pagings.

This item is filmed at the reduction ratio checked below/  
Ce document est filmé au taux de réduction indiqué ci-dessous.

10X	14X	18X	22X	26X	30X
<input type="checkbox"/>	<input type="checkbox"/>	<input type="checkbox"/>	<input type="checkbox"/>	<input checked="" type="checkbox"/>	<input type="checkbox"/>
12X	16X	20X	24X	28X	32X

# THE TORONTO CONSTRUCTION AND ELECTRICAL SUPPLY CO. (LIMITED)

OFFICE AND WAREHOUSES:

63 TO 69 FRONT. ST. WEST, - TORONTO, CANADA.

SOLE CANADIAN AGENTS FOR THE

## WOOD ARC LIGHT SYSTEM

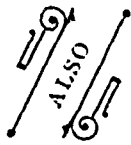

## THE SLATTERY INDUCTION SYSTEM

*For Long Distance Incandescent Electric Lighting.*

— ALSO —

METERS, TRANSFORMERS, AND ELECTRICAL SUPPLIES GENERALLY.

CORRESPONDENCE INVITED.

**NEW & 2ND HAND MACHINERY**  
 ILLUSTRATED CATALOGUE FREE TORONTO, CANADA  
 H.W. PETRIE

The Canadian Office & School Furniture Co.

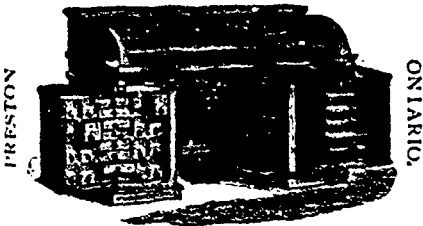

THE SMITH PREMIER TYPEWRITER,  
 THE EDISON PHONOGRAPH,  
 AND THEIR SUPPLIES.  
 DESKS AND CABINETS.  
 HOLLAND BROS. & YOUNG,  
 1740 NOTRE DAME ST. MONTREAL.

**TENDERS WANTED**  
 A Weekly Journal of advance information and public works.  
 The recognized medium for advertisements for "Tenders."  
**CANADIAN CONTRACT RECORD**  
 TORONTO.

## CORRUGATED

Our stock of both painted and galvanized sheets is large and complete.  
 Correspondence Solicited.  
**METALLIC ROOFING CO.**  
 OF CANADA, Ltd.  
 TORONTO, - ONT.  
 MANUFACTURERS.

## SHEET STEEL

# Hill Patent Friction Pulleys

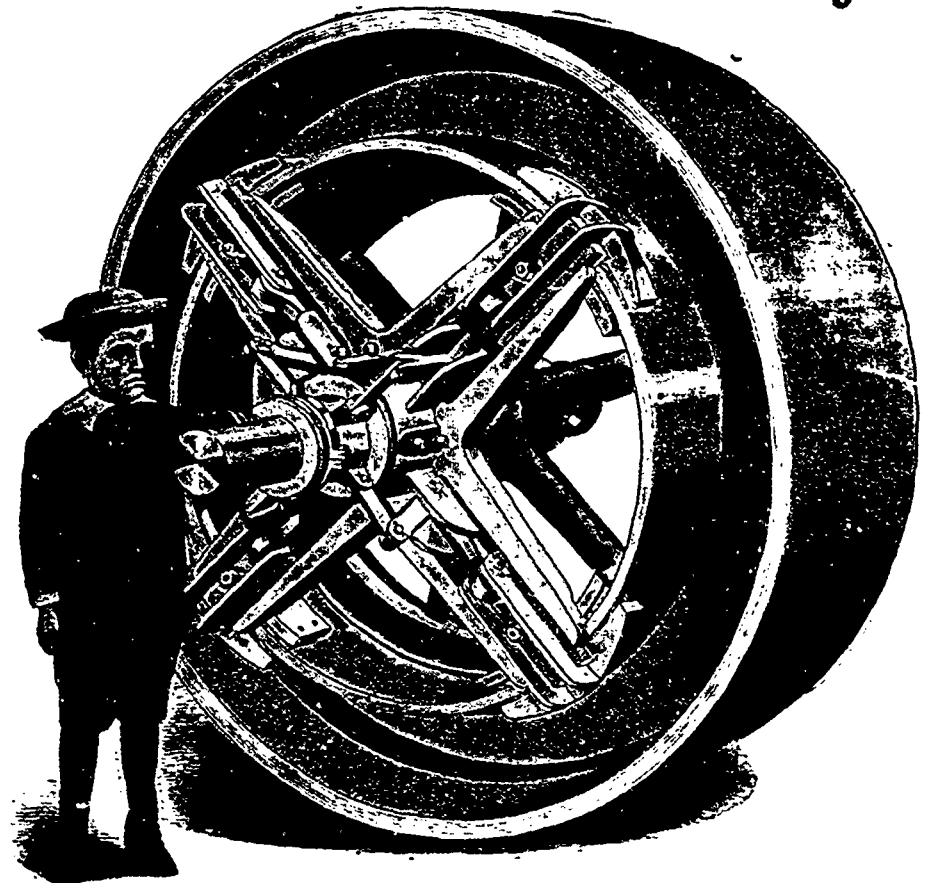

## AND CUT OFF COUPLINGS

For Electric Light Stations and all purposes where intermittent power is required.

# MILLER BROS. & TOMS,

(Successors to Miller Bros. & Mitchell)

Toronto Office: 74 York Street.

MONTREAL, QUE.

ESTABLISHED 1869.

THE  
**Toronto Construction & Electrical Supply Co.**  
 (LIMITED)

Office and Warerooms: 63 to 69 Front Street West, TORONTO, CANADA.

SOLE CANADIAN AGENTS FOR THE

**THOMSON-HOUSTON SYSTEMS**

*of Incandescent Electric Lighting, Electric Street Railways, Electric Mining Apparatus, Electric Pumps, Electric Hoists, Power Generators and Motors, Direct Reading Watt Meters, Transformers, Incandescent Lamps and General Supplies for Electric Light and Railway Plants.*

**THE "WOOD" ARC LIGHTING SYSTEM**

(MANUFACTURED BY THE FORT WAYNE ELECTRIC COMPANY.)

*A Full Line of Electric Lighting and Power Supplies always in stock. Write for Estimates.*

SOLE CANADIAN AGENTS FOR THE PERFECTED CROCKER-WHEELER ELECTRIC MOTORS.

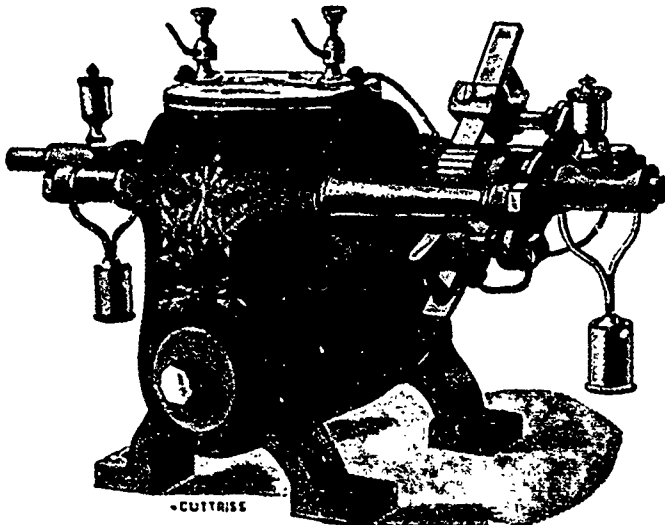

**KAY ELECTRIC WORKS**

NO. 268 JAMES ST. N. - HAMILTON, ONT.

MANUFACTURERS OF

**DYNAMOS**

*For Arc and Incandescent Lighting.*

**MOTORS**

*From 1-8 H. P. to 50 H. P.*

ELECTRO PLATING MACHINES AND GENERAL ELECTRICAL APPLIANCES. SPECIAL ATTENTION TO MILL AND FACTORY LIGHTING.

WRITE FOR CIRCULARS.

FINE - - *ELECTRIC* Street Cars  
 ... OUR SPECIALTY ...

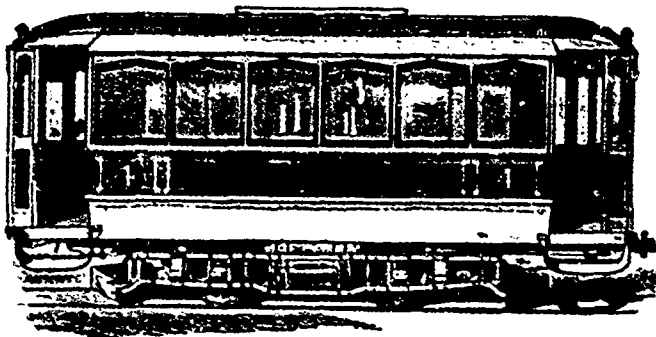

We also manufacture Horse and Trail Cars of every description.

**PATTERSON & GORBIN,**  
 ST. CATHARINES, ONT.

**TELEPHONES.**

*WE manufacture, for both main and private lines, first class thoroughly reliable telephones, equal to the genuine "Bell," and sell them outright at reasonable prices.*

*We contract to furnish Complete Exchanges, Telephone Instruments, Switchboards, Wire, Side Brackets, Insulators, &c.*

*Correspondence solicited from towns contemplating starting a telephone system, parties intending putting up private lines*

**T. W. NESS,**

644 Craig Street, - MONTREAL.

CANADIAN HEADQUARTERS FOR

ELECTRICAL SUPPLIES.

*Dynamo, Motors, Magneto Testing Bells,*

*Incandescent Lamps, Sockets, Cut-outs, &c.*

*Our T.W.N. "Swiss" Incandescent Lamp gives satisfaction.*

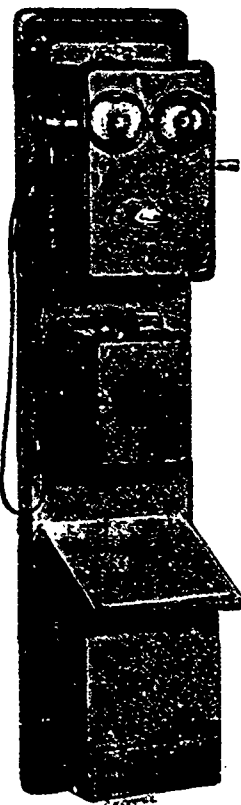

# CANADIAN ELECTRICAL NEWS

AND

## STEAM ENGINEERING JOURNAL.

Vol. II.

TORONTO AND MONTREAL, CANADA, MARCH, 1892.

No. 3.

### LONGITUDINAL AND GIRTH JOINTS IN BOILERS.

ALL writers upon the subject of steam boiler design devote considerable space to the discussion of the longitudinal joints, but it has appeared to some of our readers that the girth joints have not received sufficient attention. For example, in boilers that are to withstand high pressures, the longitudinal joints are now usually made by abutting the plates, and securing one or two overlapping straps to the plates by means of two rows of double or triple rivetting; while the girth joints on the same boiler are ordinary, single-riveted lap joints. It is the purpose of the present article to make it plain that this construction is correct, and if the single-riveted girth joint is properly designed, it is still considerably stronger than the double butt-strap, triple-riveted longitudinal joint.

The cut represents a hollow cylinder of steel, an ideal boiler shell, without heads or joints. It is 66 inches in diameter, and 14 feet long. The thickness of the metal is  $\frac{3}{8}$  of an inch, and its tensile strength, let us say, is 55,000 pounds per square inch of section. If this shell is burst by steam or water pressure, the fracture can run longitudinally, along the lines  $E F D C$ , or around the boiler, along the line  $B A$ .

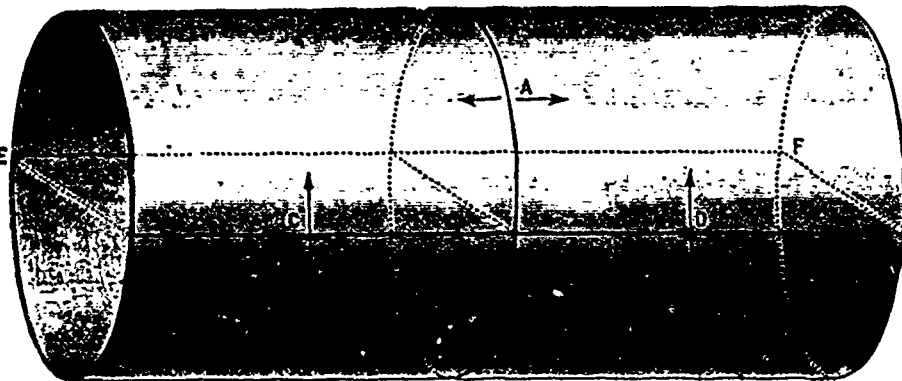

LONGITUDINAL VS. GIRTH JOINTS IN BOILERS.

Let us first find the bursting pressure, assuming that the fracture takes place longitudinally. At the moment of rupture, the strain on the metal must be just equal to its tensile strength; that is, to 55,000 pounds per square inch. The area of plate to be broken, along the line  $C D$ , is  $168 \times \frac{3}{8} = 63$  square inches, 168 being the length of the boiler in inches, and  $\frac{3}{8}$  being the thickness. The section along  $E F$  has the same area, so that the total area to be broken across is  $2 \times 63 = 126$  square inches; and since the strain on each square inch is 55,000 pounds at the moment of rupture, the total strain on the section of rupture will be  $126 \times 55,000 = 6,930,000$  pounds.

The total steam pressure tending to force the two halves of the boiler apart is equal to the pressure per square inch multiplied by the area of the cross-section of the boiler, which area, in this case, is  $168$  (length of boiler)  $\times 66$  (diameter of boiler) = 11,088 square inches. Those who are not familiar with this sort of calculation sometimes find it hard to understand why the surface of the shell is not used, instead of the area of cross-section. The answer is, that the pressure on the half  $E A D$ , for example, does not all act in the same direction, owing to the curvature of the shell. The pressure on parts that are close to the line  $C D$  acts almost horizontally, while on the parts lying along the top of the boiler it acts vertically. It would be easy to take these varying directions into account, but the same result can be reached without any figures, and in a very simple way. Suppose, for example, that the lower half of the boiler in the cut should be taken away, and that a flat plate should be bolted to the upper half in its place. If steam is now admitted, experience tells us that the boiler will not move either up or down; and it

follows from this that the pressure against the curved half of the structure is precisely equivalent, so far as forcing the halves of the boiler apart is concerned, to that against the flat plate bolted to it. Hence, as was stated in the first part of this paragraph, the total pressure tending to force the two halves of the boiler apart is equal to the pressure per square inch, multiplied by the area of cross-section of the boiler (11,088 square inches).

The pressure that would burst a shell like that shown in the cut is of such a magnitude, therefore, that if it is multiplied by 11,088 square inches (the area on which it acts) the product will be 6,930,000 pounds. Hence the bursting pressure is  $6,930,000 \div 11,088 = 625$  pounds per square inch. This is not the bursting pressure of a boiler of this size, but simply of a steel shell of the given dimensions; for we have not yet taken account of the joints that occur in boilers.

Let us now see what pressure would be required to force the

boilers apart endwise, tearing it along the line  $A B$ . The only thing that can produce a strain acting lengthwise along the boiler, is the pressure on the head, which is equal to the steam pressure per square inch, multiplied by the area of the head in the present case being  $66 \times 66 \times .7854 = 3,421$  sq. inches.

To withstand the strain so produced we have a ring of metal at  $A B$ , which is 207.3 inches in circumference ( $66 \times 3.1416 = 207.3$ ), and  $\frac{3}{8}$  of an inch thick. The area of this ring is  $207.3 \times \frac{3}{8} = 77.74$  square inches; and when the shell is about to break, the strain upon the section  $A B$  will be  $55,000 \times 77.74 = 4,275,700$  pounds. When the boiler parts, therefore, the steam pressure must be such that, by acting on an area of 3,421 square inches, it produces a resulting strain of 4,275,700 pounds. Hence the bursting pressure per square inch is  $4,275,700 \div 3,421 = 1,250$  pounds.

The results that we have thus far reached are, that it would take a steam pressure of 625 pounds per square inch to rupture a shell of the given dimensions longitudinally, and that it would take precisely twice this pressure, or 1,250 pounds per square inch, to rupture it circumferentially.

If the shell were made up of plates, riveted together, we should have to modify the foregoing calculation somewhat, so as to take account of the diminished strength due to the existence of the joints. Let us suppose there is a single-riveted girth joint whose dimensions are as follows: Diameter of rivets,  $\frac{5}{8}$  inch; diameter of rivet holes, 13-16 inch; pitch of rivets,  $1\frac{3}{4}$  inches; tensile strength of plates, 59,000 pounds. It will be found that this joint has 53 per cent. of the strength of the solid plate; so that the pressure per square inch that would rupture such a shell circumferentially, so as to blow the two ends apart, would be 53 per cent. of 1,250 pounds.  $1,250 \times 53 = 662.5$ . It would therefore take 662½ pounds to the square inch to pull this girth joint apart. But from our previous calculation it appeared that 625 pounds would tear the solid plate apart

lengthwise, so that it appears that the solid plate would tear longitudinally before a properly proportioned single-riveted girth joint would fail. This is ample justification for the use of single-riveted girth joints even when the longitudinal joints are butted and strapped and triple riveted.

Let us suppose that the boiler has triple riveted butt-strap joints, such as were described in the *Locomotive* for July, 1891, the dimensions of the joints being as follows. Strength of plate = 55,000 pounds per square inch; thickness of plate =  $\frac{3}{4}$  inch; diameter of rivet holes = 1.3-16; pitch of inner row of rivets = 3.4 inches; pitch of outer rows = 6.4 inches. In the issue of the *Locomotive* cited above the efficiency of this joint is shown to be 87.5 per cent. The pressure that would rupture the shell longitudinally being 625 pounds, the pressure that would rupture a similar shell with a longitudinal joint proportioned as above would be 87.5 per cent. of 625 pounds, which is 547 pounds; and the safe working pressure, allowing the usual factor of safety of 5, would be  $547 \div 5 = 109$  pounds per square inch.

To illustrate the fact that a single-riveted girth joint is stronger than any form of longitudinal joint, we have taken a particular case and computed the strength in both directions. A general proof of the same fact might be given, applicable to all diameters of boilers, all thicknesses of metal, and all styles of joints, but the proof would be algebraical, and for this reason we have not thought it necessary to include it. Those of our readers who understand algebra will have no difficulty in finding the general proof for themselves, for it is based upon precisely the same considerations as the numerical example given above.

#### CANADIAN ELECTRICAL ASSOCIATION.

A MEETING of the Executive Committee of the Canadian Electrical Association was held at 11 o'clock a. m. on Feb. 10th, at the Palmer House Hotel, Toronto, Mr. J. J. Wright in the chair, C. H. Mortimer acting as secretary. The following members were present: T. H. Wadland, D. Thomson, K. J. Dunstan, A. B. Smith, E. D. Edmonson, John Yule, S. J. Parker and H. O. Fisk.

A number of applications for membership were considered, and the following new members elected: R. M. Gardiner, Electric Light and Power Company, Hamilton, J. A. Kammerer, agent Royal Electric Co., Toronto, H. Brown, St. Thomas, J. Langton, manager Edison Electrical Works, Peterboro, E. Franklin Clements, president Gas Light Co., Yarmouth, Nova Scotia, C. W. Hagar, D. Starr, F. Thomson, Royal Electric Co., Montreal, and Messrs. Keegan and Milne, Montreal; C. Berkeley Powell and J. E. Brown, Standard Electric Co., Ottawa.

On motion of K. J. Dunstan, seconded by D. Thomson, the secretary was instructed to write to persons who attended the meeting for organization of the Canadian Electrical Association but who have not sent in their applications for membership, forward to them application form and request to know whether it is their intention to become members of the Association.

It was suggested that members should prepare papers to be read at the first annual convention in June as follows: Mr. S. J. Parker, "Does Electric Lighting Pay?"; Mr. J. J. Wright, "Power"; Mr. A. B. Smith, "Safe Wiring"; Mr. K. J. Dunstan, "Construction Work"; Mr. D. Thomson, "Central Stations"; Mr. H. O. Fisk, "Carbons."

On motion of Mr. Edmonson, Messrs. Thomson and Wadland were appointed a sub-committee to arrange for place of meeting in connection with the annual convention in June, also for the accommodation of exhibits, and for motive power in connection with the same.

On motion by Mr. Parker, the President, Vice President and Secretary were appointed a committee to interview the railway authorities regarding special rates for those attending the convention.

On motion by Mr. Smith, the Toronto members of the Executive were appointed a committee to prepare a circular for distribution, setting forth the objects of the Association, to secure the preparation of papers to be read at the annual convention, to formulate a programme for the convention, and to report at the next meeting of the Executive Committee.

On motion by Mr. Thomson, seconded by Mr. Dunstan, it was decided that the next meeting of the Executive would be held on the second Wednesday in March.

## THE STORAGE BATTERY FOR STREET RAILWAYS.

AN INTERESTING CORRESPONDENCE ON THE SUBJECT.

IN view of the fact that the Roberts Storage Battery Co., of Toronto, are asking the City Council to refuse permission to the Street Railway Company to adopt the overhead trolley electric system, on the ground of the superiority of their storage battery system for the purpose, we have thought it well to reproduce some correspondence which the publisher of the *ELECTRICAL NEWS* had with this company a year ago, arising out of an article in this journal on the adaptability of the storage battery for street railway work. It will be seen that the company, while professedly willing to submit their battery to a practical test, when urged to do so found means to evade the trial. Such being the case, the public will know what value should be attached to their present efforts to balk the carrying out of a great public improvement. The articles and correspondence referred to are as follows:—

"If ever there was a crying need for an underground conduit for electric railways that need is felt to-day. Improvement upon improvement has been made in the cars, the track, and especially in the motor and electrical outfit. Their success is a tangible and solid reality. The electric method of propulsion is practicable beyond a doubt, but the full and complete fruition of its success will not be realized until the unsightly and cumbersome overhead construction can be done away with. It would seem to the tyro a simple matter to lay a trench to contain the wires with a slot on top to enable the car to make a wiring contact with it at any point in its progress, but the fact remains that the more it is tried the more frequently and emphatically are its difficulties demonstrated. Wet, or even dampness—the arch enemy of the electrician—are fatal in the case of the open conductor such as must be employed to admit of contact with the moving motor. A perfectly insulated conductor in a closed conduit and carrying an alternating current intended to work the motor by induction has been proposed—something similar in principle to the telegraph employed on moving trains—but it is evidently a case of "the wish being the father of the thought" and we should not feel disposed to squander much wealth on the patent of the scheme. Another proposition to overcome the difficulties of a conduit and to reduce the leakage to a minimum is to employ a sectional conductor, a short length only being automatically placed in communication with the main insulated conductor while the car is upon it, and disconnected as the car leaves it and enters upon the next one ahead. The chief objection to this plan would seem to be its complexity and liability to derangement at most critical times. The storage battery is at present a forlorn hope, yet it would be idle to say it will never be made commercially available. It must, however, be radically improved before it can be. Though at present it may be a somewhat forlorn one, yet we do hope that the storage battery will be the coming solution of the problem. The advantage of having the car carry its motive power along entirely independent of connection with anything else and able to run on any track at present constructed would be a consummation devoutly to be wished. Its success would place the electric car upon the tracks of every street railroad in the Dominion, and our larger cities which now hesitate on account of the objectionable overhead construction, would rejoice in the fulfilment of their desires. The next best method not open to so much objection would be the conduit, providing it can be successfully accomplished. Some of the foremost of the construction companies are working at the problem with all the skill at their command. Let us hope that every success may crown the efforts of some enterprising inventor, and then the electric railroad on our busy streets would become a thing of beauty and a joy forever."

14 KING STREET WEST,  
TORONTO, Jan. 21st, 1891.

ROBERTS STORAGE BATTERY CO.,  
Adelaide Street West, City.

DEAR SIRS: I understand from a gentleman who called on you in the interests of this paper a few days ago, that you complain of some of the statements made in an article on the commercial utility of the storage battery.

I desire to say that the article in question was written without bias of any kind, and if the statements therein are in any way incorrect I shall be pleased to afford you the space necessary to correct any mis-statements which may possibly have been made.

Any matter for publication intended for next issue should reach us not later than the 26th inst.

Respectfully yours,  
C. H. MORTIMER.

TORONTO, Jan. 23rd, 1891.

Editor *ELECTRICAL NEWS*.

MY attention having been called to an article in your January number, and believing that the writer would readily avail himself of the opportunity of being set right in reference to the all

important and interesting question of the possible use of the storage battery system, for solving the question of rapid and comfortable transit, and eliminating all ideas of intentional misconception and allowing the error of judgment manifested in the article to be excusable, I nevertheless desire to set the matter before your already numerous readers in its proper aspect.

I notice the article in question refers to the storage battery as "a forlorn hope," and yet hopes against hope that the problem will be solved by an economically successful storage battery. Who only on Thursday last in the Toronto Courts of Arbitration. Mr. Rice, the eminent City Engineer of Cleveland, on the witness stand said, in answer to counsel, that the storage battery question had been solved for street car work, and further answered in reply to questions put to him as to where the question of the commercial value of the accumulator had been solved: "Right here in your own city you have the best storage battery system on this continent, and the best for street cars or any other work I have ever seen." In reply to further questions, he said he referred to the Roberts storage battery system, of Toronto. Truly a prophet is never without honor save in his own country.

I have four distinct engagements in four different cities of the States to put my system in operation. With scarcely any effort, but simply on representations of experts, a company was formed in the States a few days ago, with a capital of \$1,500,000.

Prof. Pike, a name known and relied upon all over the Dominion, after examining every known system on the continent, returned and gave an order for the School of Practical Science.

Statements regarding new storage batteries are practically worthless. In a masterly article in the *Electrical World*, the statement was made that the man who could point to a positive plate that had stood six months rough and careless work had solved the problem. Last week we forwarded to C. O. Mailloux, of New York, a positive plate that had been in constant service and subjected to continual travel for nearly two years. Mr. Mailloux in reply expressed an opinion that established a record, and one we had need to be proud of. We are now engaged upon a plant for car work and forming a company for that distinct purpose; that is, of utilizing the battery for car purposes.

Now, in what are the distinctive features necessary to insure a perfect battery for car work? Why exactly the features required in every purpose to which a storage battery is applied: 1st, Freedom from buckling; 2nd, Disintegration of the paste; 3rd, Capability of standing heavy charging and discharging. These are or have been the common difficulties to be met with in the solution of this problem. We have overcome every one of them. We have not been deterred by the "forlorn hope" ideas of anybody—no true plodder in the pathway of scientific research was ever deterred by that idea. In proof of that we give a three years guarantee.

What we have done can or may be improved upon by others, but this much is certain, that before many weeks pass a storage battery system will be in operation in or near enough to this city that will for ever settle the problem. We have quietly replaced and are replacing all the leading makes, and such is our confidence in our system that we have applied for patents in every country in the world where it is possible to obtain them.

The question has been solved in England. The Central Tramway Company, of Birmingham, are putting an extensive system into operation there; the North Metropolitan Company are also using storage batteries. They will have to be used in all crowded cities, and certainly nowhere, in my opinion, would the practical solution of the question be hailed more gladly than in Toronto and Montreal. Hamilton made an offer of track, car and motor for a test on their line, which offer we respectfully refused, as we did not care to be trammelled by an agreement that rendered necessary the possible subversion of our ideas.

We have the battery, experienced engineers, and the advent of our company will at once dispel "forlorn hopes," by the recognition of the end and object of the work of years.

A few days ago, at the invitation of the T. H. overhead system, Ald. Saunders, the mayor and a number of city gentlemen enjoyed the hospitality of the President, and after expressing their approval of everything, yet said that the storage battery would be the only permissible electric system allowed in the city.

Yours truly,

WM. ROBERTS.

"We publish elsewhere an epistle from the exponents of a storage battery who apparently take exception to our remarks on storage batteries in general. We should have been better satisfied if, instead of claiming superiority for their battery, they had shown or made an attempt to show, in what respect it is superior to others in experimental use to-day. Wherein does the construction differ? Does the material used differ from others, and if so, what is the advantage of the difference? If the battery is covered by patent, there should be no hesitation in courting the fullest publicity on these points. The refusal of an offer of car, track, and motor to demonstrate its efficiency, is to say the least of it, curious. When it is well known, and has been so expressed by us that a successful storage battery is the

El-Dorado of street railway men, that it is the crying need of the electrical world to-day, we should have thought that the proprietors of this bonanza would have jumped at the chance to show their goods without cost to themselves. This journal has no antagonism to any individual or industry. We aim to chronicle the progress of electrical science as it actually presents itself, and while of course we court the advertising patronage of our electrical friends, our highest aim is to make the ELECTRICAL NEWS of value to all engaged in electrical and engineering pursuits. To do this we intend to express our opinions of men and things without fear or favor, to chronicle events and discoveries as they actually present themselves, and to condemn the sharks who make use of a little smattering of electrical knowledge to make a raid upon the pocket books of the unwary in the name of science. By adopting a straightforward course and issuing a journal that can be depended upon, we shall increase our circulation to an extent that will make it necessary for any progressive concern to make use of its columns to reach the public. If we express opinions that to our readers may seem to be open to criticism, we shall be most happy to hear from them, and if we make a statement that appears not to be borne out by facts, and such is demonstrated to us, we will make full, public and complete recantation. We are proud to say, however, that during our publication of the ELECTRICAL MECHANICAL AND MILLING NEWS from its inception till it gave place to the present paper, we have had no occasion for anything of the sort, but on the contrary, "coming events" have so plainly "cast their shadows before," that in every case changes and developments which are so rapidly taking place in this progressive science have been accurately and completely foreshadowed by us. We make no exception in this matter of the storage battery. We have expressed our opinions of it, knowing what we talk about. We have said that no imitations of those "not dead" perhaps, but simply "gone before," will ever solve the problem, and that success must be looked for on new lines. We are, however, more anxious that our increasing clientele should have the fullest information on what is doing and actual facts connected therewith, than we are for our own glorification, therefore we make this offer to the storage battery people in question. Produce fifty of your cells, place them in charge of an expert appointed by us and one by you for a thorough and exhaustive test, and the results shall be made public without fear or favor. You have the floor."

TORONTO, 7th Feb., 1891.

C. H. MORTIMER,  
Editor ELECTRICAL NEWS, Toronto.

DEAR SIR,—Referring to your editorial relating to the letter signed by our Mr. Roberts, in your issue of Feb., we beg to say that the letter was written by your own request, and further it was submitted to you for approval, and it seems to us that had it not, in your opinion, gone into full enough detail, you should have said so at the time. As far as the construction of the plate is concerned, there has been certainly no hesitancy on our part in explaining in detail the peculiar construction of our battery. Our pamphlet (one of which was given you) gives both by cuts and printed matter, the fullest information on this point. Regarding the refusal of car, etc., what you say appears "to say the least curious," the explanation given you by our Mr. Macfarlane, and which we think was satisfactory to you, might have been earlier in your possession had you so desired it. Re your next remarks as to "electrical sharks," we accept, for ourselves your explanation that it in no way referred to us, but the general tone of your editorial, we think, was such that a reader would naturally infer that you were referring to us, and we must request you, in your next issue, to make the matter right.

Regarding your offer of testing cells, we will be more than pleased to have you test our battery at any time, and will place cells in our factory at your disposal for as exhaustive tests as you wish to make. Be good enough to let us know what day will be suitable to you. Yours truly,

THE ROBERTS STORAGE BATTERY AND ELECTRIC CONSTRUCTION CO.

By J. H. Macfarlane.

TORONTO, Feb. 9th, 1891.

ROBERTS STORAGE BATTERY  
AND ELECTRIC CONSTRUCTION Co., City.

DEAR SIR:—Replying to your letter of the 7th inst. received this morning, in which you express your willingness to submit your battery to a test as proposed in our editorial in February number of ELECTRICAL NEWS, I am pleased to observe your apparent readiness to have demonstrated by disinterested parties the merits of your invention.

Mr. J. J. Wright, manager of the Toronto Electric Light Co., to whom I spoke on the subject immediately after the conversation had with you a few days ago, has kindly consented to act as judge on my behalf in connection with such a test of your battery as we proposed. It will be necessary for you to appoint your expert to act with Mr. Wright in the matter.

The test should include 50 cells, and should take place outside your premises.

Mr. Wright offers to provide all the facilities necessary for a

[Continued on page 46.]

**MONTREAL ENGINEERS' VISIT TO MCGILL UNIVERSITY.**

MONTREAL, Feb. 6th, 1892.

Editor ELECTRICAL NEWS.

SIR, Through the courtesy of Prof. Bovey and the faculty of McGill University the Stationary Engineers' Association No. 1 of Montreal recently availed themselves of the opportunity of visiting the Department of Applied Science in connection with that institution.

They were received by Prof. Bovey and conducted through the different departments, where they saw what was of interest to them. This remark will apply particularly to the testing room, where the Professor gave a practical illustration of the method of getting at the breaking and torsional strains of different kinds of timber.

I feel sure that the engineers received much benefit from the visit. The members were in charge of a committee composed of Bros. Ryan, Smith and Robertson. On retiring from the building, Bro. Ryan thanked the Professor on behalf of the visitors for his kindness and the interest he had manifested on behalf of the Association. We hope it will not be our last visit to McGill University.

Yours truly,

"PUCK."

**A WORD OF ADVICE TO ENGINEERS.**

MONTREAL, Feb. 20, 1892.

Editor ELECTRICAL NEWS.

DEAR SIR, The qualities that go to make an engineer are, first, an understanding of his position and what is required of him, particularly in taking charge of a new plant. I do not mean a new engine and set of boilers with everything in first-class order, and including all the latest improvements, but one that has been run for some time, and which may have been in charge of a careless man, one who thinks anything is good enough for an engineer. Such a state of things should be of the past, not of the present. The engineer may find under such circumstances that his engine is pounding, that his draft is poor and he can't get satisfaction out of his boiler. Yet his best course will not be to get mad and swear at the man he has succeeded, nor go to the office and complain that he wants a new engine and boiler in fact, a new steam plant altogether. Rather let him look the matter squarely in the face, make up his mind that he has something in the line of a difficult job on his hands and get to work with a will.

After having made a careful inspection of the boilers, he should go and stand beside the engine, get acquainted with it, study all its faults, be sure he knows what ails it—where it pounds and where its lost motion is and that he can improve it a good deal before starting to work with wrench and hammer. After all lost motion has been taken out of it, and it is found that every time it passes its centres it gives a dull heavy thud, this is where his practical knowledge should come to his assistance. He should call in the help of the indicator, but supposing he does not understand the working of an indicator, let him lay his difficulty before the Association of Stationary Engineers, when he may depend that some brother will set him right. The writer has done so, with what effect can be seen. After the indicator was put on we got a card like this:

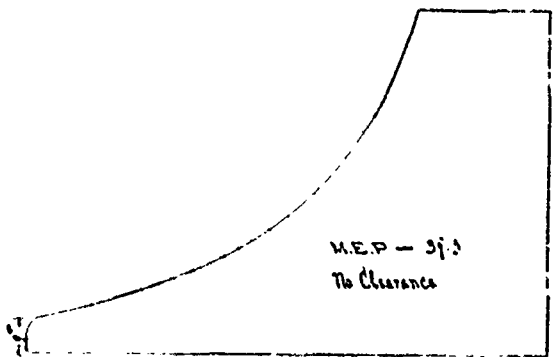

Now this was all a mystery to me. The brother said my engine valves were late, and that if I was willing he would adjust them for me. I replied "go ahead." He said that my engine was pounding for the want of more cushioning. After a

little fixing on the valve rods we set it in operation again, the result is that I am satisfied, and my engine is now running very smoothly.

A word to any engineer who thinks he knows it all: I would

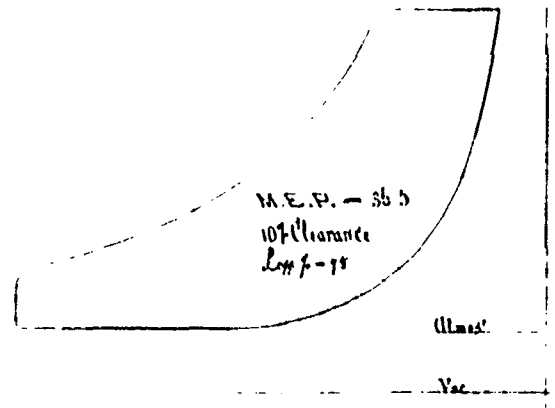

advise you to join some engineers' association. I think you will find some one who knows a little as well as yourself. In union of numbers there is strength and knowledge, you will become a competent man in your calling, with the capacity to fill positions of importance and emolument.

Yours truly,

"PUCK."

**THE TILSONBURG ELECTRIC STATION.**

February 12th, 1892.

Editor CANADIAN ELECTRICAL NEWS.

DEAR SIR, Some few days ago I was in the busy little town of Tilsonburg, and having occasion to remain there over night, concluded to visit the electric light station. I found it to be a brick building 30x50', just over the C. T. R. bridge on Broadway. I opened the front door and walked in, feeling a little timid, for a man must be very careful how he conducts himself *some* of the small stations, as the men in charge seem to have a undue idea of their importance in their own particular sphere, and seem to deny the right to others to express an opinion. However this kind of men is not very numerous. As soon as I got inside the station I saw a man who readily granted my request to be allowed to look over the plant. The gentleman was Mr. F. J. Barkey, who is the owner of the plant, and who also fills the position of engineer and electrician, assisted by his brother, Mr. W. E. Barkey.

The plant consists of one 45 light 1,500 c. p. 6 amp. Reliance arc machine and one 300-light 17 c. p. 110 volt, incandescent machine, the latter built by the Dominion Electric Co., of Fergus, Ont. The power is supplied by a 12x30" Harris Corliss engine, built by Messrs. J Inglis & Sons, of Toronto, which runs 80 rev pr minute, the average load being about 45 h. p. The steam is supplied by a 54"x12" 58 3" tubes, steel boiler, which was also built by Messrs. Inglis & Sons, and which carries a pressure of 80 lbs. per sq. inch.

The average run in winter is seven hours per night, and the amount of fuel consumed averages 1,200 of soft coal per run of nine hours. The coal costs \$3.85 per ton laid down at the boiler room door.

Everything around this plant is kept in good order; there is a place for everything and everything is in its place.

Mr. Barkey speaks very highly of the performance of the Reliance arc system, also of the Harris Corliss Engine.

The writer spent a very pleasant time with Mr. Barkey, and takes this opportunity of thanking him for the courtesy and kindness extended to him.

Yours truly,

TRAMP.

The Belgian Government has informed the Belgian Telephone Companies of its intention to resume from January 1, 1893, the working of all the telephone lines in Belgium.

A report from Winnipeg states that there is a disposition to upset the action of the Council of last year in granting the franchise for an electric street railway to Messrs. Ross & McKenzie.

The Globe Furniture Company, of Walkerville, Ont., have just installed an electric plant for lighting their factory. It was manufactured by the Jenny Motor Co., of Indianapolis, Ind. It operates 75 Edison lamps, a current of 110 volts being employed for the purpose. The results are very satisfactory.

**DYNAMO MACHINES.**

If there are any apparatus that have particularly exercised the imagination of inventors, they are assuredly lamps, commutators and dynamo machines. These latter, especially, have become very numerous in recent years. It is easy, however, to establish a classification between the different models. Every dynamo comprises two principal parts, viz., the armature and the inductor. The various kinds of continuous current armatures may all be referred to three well known types of winding—the Gramme, the Siemens and the Edison. Besides these there are still other types that we must consider, and, in particular, the De-roziers winding. We shall not dwell upon the details nor upon the advantages and disadvantages of these various armatures as they have already been presented to our readers.

As for the inductors, the same is not the case. It is but a few years ago that the labors of electricians indicated the conditions that these parts of the dynamo must satisfy. Among such conditions we may mention one in particular. It is necessary to reduce as much as possible the magnetic resistance of the current, or the resistance offered to the flux of force through the iron of the electros, and the air between the iron of the electros and the iron of the ring. The flux of force, as we know, is the product of the intensity of the magnetic field created by the surface embraced. Moreover, it must not be forgotten that a wire surrounding a piece of iron, and being itself traversed by a current, magnetizes such iron and creates in the interior a magnetic field of a certain intensity. If we take the product of such intensity by the surface of the piece of iron, we obtain the flux of force, the consideration of which is a most important matter in the construction of dynamos. These few remarks suffice to show that, in a good dynamo, the flux of force should have a maximum value. It is well, then, for a given number of windings of wire, to be careful as to the nature of the metal of the inductors, to employ iron of very great magnetic permeability, and to reduce as much as possible the resistance of the air necessarily interposed between the inductor poles and the armature. This latter condition imposes the obligation of placing the inductors as near as possible to the armature, leaving just the space necessary for the motion of the armature, and afterward of making the latter embrace the widest surface possible.

The second part of a dynamo machine, the inductor, gives rise, as may be seen, to more numerous inventions than the armature. In fact, there has been no want of models. One of our most learned electricians has conceived the happy and original idea of bringing together, in one plate, the various types of inductors of continuous current machines, which we reproduce in the accompanying engraving.

No. 1 represents the well known Gramme machine, No. 2 the Edison-Hopkinson, and No. 3 shows us the arrangement of the Siemens dynamo, with drum armature and horizontal inductors. This machine bears also the name of Hefner Alteneck, the engineer-in-chief of the Siemens establishment. In No. 4 we find the Schuckert type, with disk armature, and in No. 5 the form of the Weston machines, with drum armature, of the Burgin ring machines, and of the Crompton, Patterson and Cooper machines. No. 6 shows the large Edison machine of 1880, which was adopted by all the American central stations and by the Milan station. No. 7 represents a third type of the Edison dynamo of four or five bobbins. To this type is referred the English machine Phoenix. No. 8 gives the aspect of one of the first types of the Gramme machine. Messrs. Burgin & Crompton devised a dynamo, which is represented in No. 9, but which is

now abandoned. In this we find the first principles of the Meritens and Jackson machines. Fig 10 gives a diagram of the Kummer & Company machine, which is similar to the Jones dynamo and Gramme motor. In No. 11 is found represented one of the first models of the Gramme machine with several poles—a model which has since been constructed with more or less modification by the Oerlikon and Allgemeine Gesellschaft Companies, of Berlin. In all these machines we find a large external polygonal ring, to which, according to the radii, are adapted iron arms which, in the center, leave between them an annular space, in which the bobbin revolves. No. 22 shows a motor devised by Sylvanus Thompson. No. 13 is a modification of the inductors of the dynamo No. 9, proposed by Mr Kapp for the reduction of the magnetic resistance of the circuit. No. 14 is a section of the well known Griscom motor. No. 15 is a new form of motor for electric railways, constructed by the Thomson-Houston Company. In No. 16 is figured a section of the Eddy & Mather American machine. No. 17 shows a Ferguson dynamo. No. 18 shows one of the commonest forms of the Goolden & Trotter dynamos. The dynamo of the Telephone Company of Zurich is represented in No. 19, the Guzzi-Ravizza and Ironsides in No. 20, and the Tyne dynamo, of Scott & Mountain, in No. 21. No. 22 gives a section and profile of a superior type of Gramme dynamo, devised by Kapp, and since imitated by a number of manufacturers. No. 23 represents the Hochhausen dynamo. No. 24 the Elwell, Parker & Crompton dynamos, and No. 25 the Manchester type, due to Hopkinson. It is to this latter type that belong the Brown of Oerlikon, Mather & Platt, Sautter & Lemonnier, Tighe, Joel, Clark-Muirhead, Blakey, Emmot & Immisch and Sprague machines. Nos. 26, 27, 28, 29, 30 and 31 show, respectively, the Lahmeyer, Thomson-Houston, Wenstrom, Eickemeyer, Continental and Mordey & Jones machines. No. 32 represents a form common to several American motors, notably to the Patten and United States and Jenney motors. Silvanus Thompson devised the dynamo shown in No. 34. No. 35 gives the Form of Kennedy's ironclad dynamo machine. Finally, the Alioth Helvetia, Elwell, Siemens (with interior poles), Thury, Kester, Brush or Schuckert-Mordey or Victoria dynamo machines are represented in Nos. 36, 37, 38, 39, 40 and 41. This enumeration comprises but a few of the principal types of continuous current machines, now no longer new. Doubtless, among all these dynamos, there are several that are superior to the rest, but still, the same qualities are sometimes reached by various means and different forms, and it is often difficult to fix one's choice between several models. The question of cost alone intervenes. The short history that precedes shows the path that the dynamo machine has traveled since its invention, and it proves that the mind of inventors has not remained inactive.—*La Nature.*

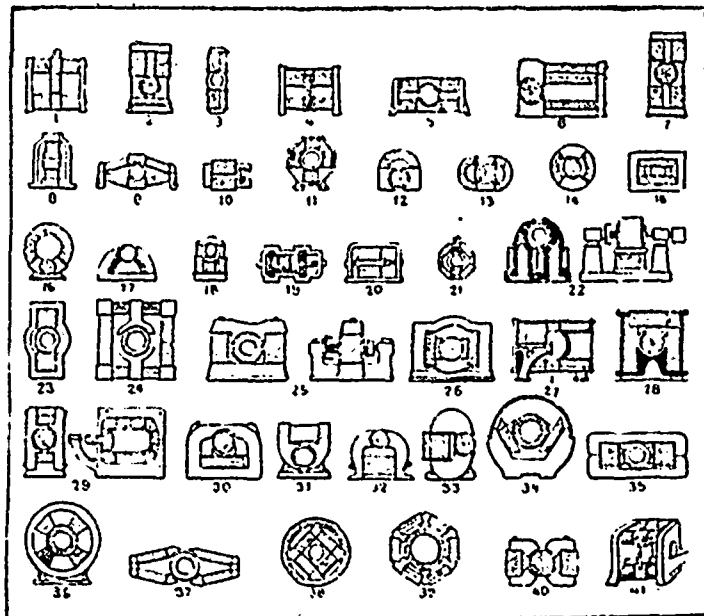

DYNAMO MACHINES

**PUBLICATIONS.**

We have received from the secretary a copy of the annual report of the Toronto Board of Trade. It is a volume of 100 pages, containing full statistics of the city's commerce, a list of the members, description of the new Board of Trade building, annual reports of the president, secretary and treasurer, etc.

The *Electrical Review*, published at 13 Park Row, New York, celebrates its tenth anniversary by issuing a very handsome Decennial Number dated February 20th, 1892. This issue contains a large number of very handsome illustrations and numerous special articles of more than ordinary merit. A history of electrical progress for the past ten years is an important feature. This Decennial Number of the *Electrical Review* is alike interesting to the layman and electrician, and presents in a graphic and interesting manner the landmarks of electricity for the past ten years with an outline of what the future may have in store for us in this field.



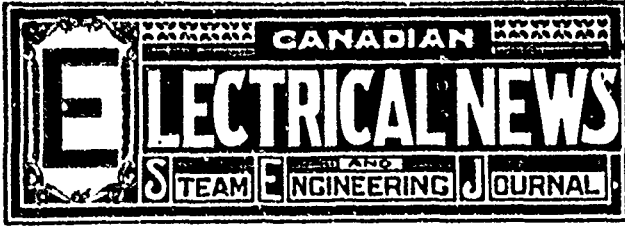

PUBLISHED ON THE FIRST OF EVERY MONTH BY

CHAS. H. MORTIMER,

Office, 14 King Street West,

TORONTO, - - - CANADA.

64 TEMPLE BUILDING, MONTREAL.

#### ADVERTISEMENTS.

Advertising rates sent promptly on application. Orders for advertising should reach the office of publication not later than the 15th day of the month immediately preceding date of issue. Changes in advertisements will be made whenever desired, without cost to the advertiser, but to insure proper compliance with the instructions of the advertiser, requests for change should reach the office as early as the 22nd day of the month.

#### SUBSCRIPTIONS.

The *ELECTRICAL NEWS* will be mailed to subscribers in the Dominion, or the United States, post free, for \$1.00 per annum, 50 cents for six months. The price of subscription may be remitted by currency, in registered letter, or by postal order payable to C. H. Mortimer. Please do not send cheques on local banks unless 25 cents is added for cost of discount. Money sent in unregistered letters must be at sender's risk. Subscriptions from foreign countries embraced in the General Postal Union, \$1.50 per annum. Subscriptions are payable in advance. The paper will be discontinued at expiration of term paid for if so stipulated by the subscriber, but where no such understanding exists, will be continued until instructions to discontinue are received and all arrearages paid.

Subscribers may have the mailing address changed as often as desired. When entering change, always give the old as well as the new address.

The Publisher should be notified of the failure of subscribers to receive their papers promptly and regularly.

#### EDITOR'S ANNOUNCEMENTS.

Correspondence is invited upon all topics coming legitimately within the scope of this journal.

RECENT tests have demonstrated the superiority of porcelain as compared with glass insulators. The inferiority of the glass usually used in the manufacture of insulators is given as the cause of their inefficiency.

THE laws of the State of New York provide for the exemption of manufactories from taxation. The courts have been asked to decide whether electric light stations are entitled to rank as manufactories. The decision is that electricity is a manufactured product, and an electric station a manufactory.

THE important announcement is made that an understanding has been arrived at between the Thomson Houston Co. and the Edison General Electric Co. which will result in the amalgamation at an early date of the interests of these great concerns. This amalgamation will no doubt be beneficial to all the manufacturing and supply houses, inasmuch as its object seems to be to maintain rather than cut prices.

THE French section of the stationary engineers of Montreal have organized a society, the officers of which are as follows. President, J. Guimond, first vice president, C. Tourgeon, second vice-president, J. Fecteau, secretary W. Gendron, assistant-secretary, A. Latour, treasurer, J. Martineau. Committee J. Bissonette (chairman), H. Bernier, T. Langlois, A. Ducap, W. Leclaire, R. Drouin and J. Gauthier. Guardian, C. Morin, conductor, J. Renette. The membership already numbers upwards of one hundred. The promoters of this movement are to be congratulated upon the success which has attended their efforts.

WE are reminded of the terrible calamity which happened in Quebec on the 12th of February last year, when a boiler explosion killed twenty persons at the Riverside Worsted Factory, by reports from Quebec that Marie Therien has entered an action for \$10,000 damages for the killing of her husband by the explosion at the worsted factory last year, against the directors, Messrs. Andrew Paton, R. W. Hencker, R. Brodie, John Turnbull and the Hon. M. A. Cochrane. Another plaintiff, named Simeon Hamel, is claiming \$2,000 from them for permanent injuries sustained on the same occasion. As the law now stands these parties may recover the damages claimed, and, if so, the loss of the Company by the explosion will be serious. Other boiler owners should take every precaution to avoid such complications as have arisen in this case.

THE opinion which prevailed to a large extent some time ago that there was an abundance of profit to be derived from the business of supplying electric light, and that consequently it was to the interest of municipal corporations to purchase and operate their own plant, is undoubtedly being discredited. That this is the case is shown by the fact that several of the corporations who purchased plant, and engaged in the manufacture of electric light, are now endeavoring to sell out to private concerns, while others are passing through an experience of difficulty with the management of electric apparatus, which should serve as a warning to their neighbors. It is shown in an article elsewhere that in the hands of those who have invested private capital in the business, the results have in many instances been unprofitable, and it is safe to say that as a rule private management is likely to be more economical than that exercised by the officials of municipal corporations.

THE formal opening of the newly equipped laboratory in connection with the School of Practical Science took place on the evening of February 24th. In response to invitations from the faculty the building was thronged with citizens in fact so great was the attendance that it was to a large extent impossible to examine the many interesting appliances connected with the institution. Although the equipment of the School is not complete, yet with the addition of the new laboratory it is in a position to give to young men a satisfactory technical training in civil, mechanical and electrical engineering and architecture. It is a subject for congratulation that we have now a native institution capable of imparting instruction to our young men in these important branches, and from the spirit of earnestness which is being manifested by the Minister of Education and the faculty, the School of Science seems destined soon to rank among the best equipped and most efficient technological colleges on this continent.

WE publish in another column a letter from a subscriber at Petrolia, calling attention to the fact that many of the readers of the NEWS lack a rudimentary knowledge of electricity, including familiarity with the technical terms employed in the science, and that consequently much of the information furnished by the *ELECTRICAL NEWS* is unintelligible to this class of readers. We have not been unaware of the fact to which our attention is called, and have endeavored from time to time to publish such information as we deemed would be of advantage to primary students of electricity. We have also to some extent published definitions of the technical terms employed. It would appear, however that we have not gone far enough in this direction to suit the requirements of some of our subscribers, and therefore we are very glad that our attention has been directed to the subject. It is our desire that subscribers should advise us in this way, of their needs, and thus place us in a position to supply them. In the present issue is published an article headed, "What is a Dynamo?" which has been written with the object of furnishing the information asked for in our correspondent's letter. We shall endeavor to supplement this article by others equally easy of comprehension, and which we trust will serve to explain to those who are inexperienced, the principles on which the various types of electric apparatus are constructed as well as the methods of their operation. Meanwhile, if any of our subscribers have suggestions to make, we shall be pleased if they will present them.

MUCH has been heard of the danger attendant upon the system of stringing electric wires overhead, and reiterated demands have been made that all wires be placed underground. It is questionable, however, whether the carrying out of this demand would not tend to enhance rather than diminish the danger. An example of the peril which is likely to attend the underground system occurred in Toronto a few days ago. Illuminating gas from the street mains found its way in sufficient quantity into one of the man-holes in the public streets through which passes a telephone cable, to require but the faintest induction spark from the covering of the cable, or a spark of atmospheric electricity to cause an explosion. The spark appears to have been forthcoming, for suddenly the heavy iron man-hole covering which had been firmly bolted down, was torn from its seat and carried into the air. A horse which was being

driven past the spot at the moment fell into the man-hole, and before it could be extricated there occurred a second explosion, burning the animal severely. The driver of the horse and another person who happened to be near the man-hole when the explosion occurred escaped with slight injuries. It is a well-known fact that about 10 per cent. of the total supply of illuminating gas which goes to the street mains leaks out at the joints and saturates the earth. This gas must find its way into the man-holes, and when the right admixture of gas and air is reached, the material is ready for an explosion. There is always danger with underground wires that the inductive current set up in the lead covering of the cable may become sufficiently strong to generate a spark which would be the means of igniting the combustible materials. Had the explosion to which we have referred taken place in the man-hole at the intersection of King and Yonge streets, where the traffic is always great during business hours, there would in all probability have been many persons killed. The daily press which has so often held up to view the horrors of the overhead system, should now have something to say on the other side of the question.

It is learned that the Convention of the National Electric Light Association of the United States which took place in Buffalo last week was perhaps the most successful, from a business point of view, ever held. The social frivolity which was so marked a feature of former conventions was to a considerable extent frowned down, and thereby much valuable time was afforded for the consideration of matters of serious moment. No action was taken on the motion to change the name to the "International" Association. The development of the Canadian Electrical Association was no doubt taken to mean that the representatives of Canadian electrical industries consider that their interests will be better served by a purely Canadian organization. It was decided that the conventions of the National Association shall hereafter be held not oftener than once a year unless it should be thought advisable to hold a meeting next year in connection with the Worlds' Fair at Chicago.

PREVIOUS to the organization of the Canadian Electrical Association, Mr. S. J. Parker, President of the Owen Sound Electric Light Co., issued circulars to the owners of electric plants in Ontario, requesting information which would serve to indicate the financial condition of the industry. Quite a number of replies were received, and the result is of a somewhat startling character. Out of twenty-five companies who responded to the enquiries, only fourteen were paying dividends; out of thirteen plants operated by steam power, only five were paying dividends; and out of a total invested capital of nearly \$1,000,000, \$560,000 was paying no return to the owners. Those companies which were paying dividends were obtaining from their customers not less than twenty-five cents per lamp for such lamps as were kept burning until midnight, and forty cents for all night lamps. In view of this showing, there is great need for steps to be taken to place the business of electric lighting on a more profitable basis. This can only be done by means of united action on the part of those interested, and we know of no better way of dealing with the subject than through the medium of the recently organized Canadian Electrical Association. We understand that prices in Canada are very much lower than in the United States. The present condition of affairs cannot last for any length of time, and the sooner action is taken to bring about an improvement the better for those whose capital has been invested in the business. There is no reason why capital invested in electric lighting should be non-profitable any more than when employed in other legitimate enterprises. No individual or company should be expected to employ their money for the public benefit without receiving a fair return in the way of profit. We understand that Mr. Parker, who is in possession of much valuable data, has consented to prepare a paper on the subject for the forthcoming convention of the Canadian Electrical Association to be held in the City of Hamilton, in June next. This paper should provoke a full discussion of this most important question, and result in some action being taken to bring about an improvement.

ciation is a live and growing institution. The membership already numbers about 35, and is representative of the leading electrical industries of the country. During the last month there have been received a considerable number of applications for membership, some of which have received the approval of the Executive Committee, while several others which came to hand at a later date are waiting to be passed upon by the Committee at its meeting on the 9th inst. Some of these applications have come from the far north-west, others from the maritime provinces, which may be regarded as a gratifying proof of widely diffused interest in the movement. At the last meeting of the Executive, sub-committees were appointed to bring the Association and its objects before the notice of persons interested in electrical matters, and to push forward the arrangements for the first annual convention which will take place in Hamilton in June. It is already certain that a number of very valuable papers will be forthcoming at this convention, and it is the determination of those who have the arrangements in hand that the occasion shall be one of so much interest that all will be amply repaid for their attendance. While the main object of the convention will be to afford instruction and business profit to those engaged in electrical enterprises, our electrical friends in Hamilton may be depended on to provide ways and means to render the visit a pleasant one from the social point of view. To those who have not as yet become members of the Association, we wish to say, it will pay you to do so. If you are desirous of improving your knowledge of electricity, or of any form of its application, the Association will assist you; if you have your capital invested in the business and want to know how the greatest remuneration may be secured from it, the Association will help you; if you wish to see hostile legislation defeated and cut-throat competition done away with, you should connect yourself with the Association and work shoulder to shoulder with those who are desirous of promoting electrical interests in these and all other directions.

WE would strongly urge upon central station managers who are supplying incandescent lighting, the advisability of using the meter system of supply only, for then the customer pays for just what he consumes and no more; the company supplying the current will then find that they can add fully twenty per cent. additional lights on their dynamos. Under the contract system it is found that the customer will burn all the lights whether he actually requires them for his business or not whereas with the meter system of supply he will know that when he turns on a light he commences to pay for it, the consequence of which is that there are no more used than are actually required, and if it is found that the occasional lighting of one or two lights in an unfrequented part of the store is necessary to display his wares, care is taken to see that they are turned off when they are no longer required. Then again the revenue in most cases will be found to increase rather than diminish when meters are used, for while there may be actually no increase in the amount of money that is paid for the lights, there is bound to be a perceptible difference in the coal pile. To those companies or individuals who are running dynamos until midnight only, there can be no question but that it would be of decided benefit too, for then the customer who allows his lights to burn (under the contract system) until the machine stops, "just as an advertisement," even though his store has been closed two or three hours earlier, will invariably turn his lights out when he closes his shop up for the night, which means so much in pocket for the company supplying them. There should be no hesitancy therefore in adopting meters, which with a monthly rental of 25 cents, will pay interest on the amount expended for them, and leave quite a nice margin for wear and tear. We well know that there is a tendency with some managers to doubt the practicability of electric meters, but there cannot be an atom of doubt in that direction, if they will but look up the records where they are extensively used both in Canada and the United States. It is but a foolish prejudice at best that will sway one's opinion to the extent of not using them, and a prejudice that would soon vanish into thin air did they but give them a trial. In this connection they would perhaps come to regard them as a veritable boon when they shall find that as a result of their use they are deriving a revenue from one hundred or more lights out of every five hundred that their dynamos are capable of producing. With such meters as the Schallenberger, Slattery and Thomson Recording Watt-Meter, many hundred of which are in daily use, it seems crude, and we may say, almost primitive, to see lighting compar. installing incandescent lights at so much a month or year. It is a well known fact that in nearly all the large European cities the current for both arc and incandescent lighting is supplied by meters, with little or no dissatisfaction among the customers, and with every satisfaction to those supplying them.

As will be seen by the report in another column of the meeting of the Executive Committee, the Canadian Electrical Association

## THE ELECTRIC TRANSMISSION OF POWER.

By GISEBERT KAPP.

(Continued from February Number.)

What we generally desire to get in practice is a constant speed of the motor, whatever may be the mechanical power taken out of it at any moment. This condition is the same as that required from a good steam engine or other well-governed prime mover. The construction of the motor to comply with this requirement depends, of course, on the condition of supply. We can imagine a large variety of cases; but, from a practical point of view, I need only consider two, namely, supply at constant pressure such as we get, or ought to get, from mains connected with a central electric light station, and supply of current at constant or variable pressure from a generator erected specially for the purpose, the regulation of current and pressure being automatic. The latter case is that more particularly met with in long distance transmission of large powers, the former is a case referring rather to the distribution of small parcels of power over short distances from a central station. I will take this first.

We have, then, these supply conditions—pressure at the terminals of the motor constant, current variable according to the

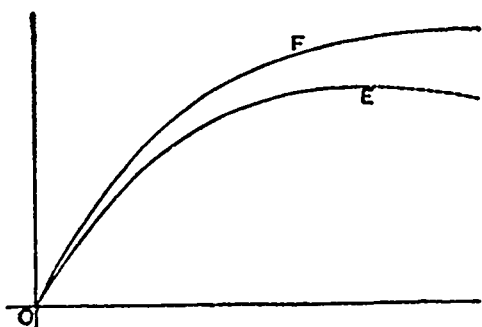

FIG. 4.

call for power. Let (in the diagram Fig. 4) the curve F represent the characteristic of magnetisation an electromotor, that is, a curve obtained by plotting ampere-turns of exciting power on the horizontal and total field strength (denoted in the formulae by  $F$  or  $Z$ ) on the vertical. If the motor is series-wound, you see that the larger the current the stronger will be its field, and by referring to the E.M.F. formula you will find that if the speed is to remain constant the counter E.M.F. must increase in the same ratio as the field strength increases. But the counter E.M.F. must, under all circumstances, be smaller than the supply E.M.F., by just the amount required to overcome resistance of the circuit through the motor, and this difference is, of course, proportional to the current. To satisfy the supply condition the counter E.M.F. of the motor ought to slightly decrease as the load, and with it the current, increases, then the speed will keep constant. But this is exactly the opposite of what the motor requires. Say the machine is running at a certain speed, and giving out a certain amount of mechanical power. Now increase the load. The immediate consequence will be that the speed is slightly decreased, the counter E.M.F. is slightly decreased, and the current is increased. This will immediately strengthen the field, and thus raise the counter E.M.F. again; this will check the current, produce a further drop in speed, and so the reaction will go on until a new stable condition of working is reached at a larger current and lower speed. If we take the load off, the same reaction takes place, only in the opposite sense, and the speed may become dangerously high. What I have here described happens, of course, only if the machine is worked on the rising part of the E.M.F. characteristic E, the part which we would naturally select for economical working. If we over-excite the field magnets, that is, if we employ a great deal more field wire than necessary, then we can work the machine on the drooping part of the characteristic shown by a dotted line in the diagram, and obtain approximately constant speed between certain limits, but the machine will still be liable to race as soon as we throw the load off completely. We thus find that a series-wound motor is certainly not suitable for our purpose.

Let us now inquire whether we shall be any better off with a shunt wound motor. The field excitation in such a machine does not depend on the current flowing through the armature as in a series machine, but it is simply the result of the terminal

pressure; in other words, whatever current may be required by the armature for giving power, can be and is, in fact, supplied by the source of current, without in any way affecting the field excitation. If the terminal pressure varies, the excitation and the field strength must also vary, but a variation in the working current will not directly influence the field strength. It will, however, indirectly influence it by reason of a subsidiary effect technically termed "armature reaction," and this I shall touch upon shortly. For the present we neglect it, and assume that the curve F correctly represents the field strength as a function of the terminal pressure. In machines having wrought-iron magnets the first part of this curve is almost a straight line, and in this region the field strength is consequently very nearly in direct proportion to the terminal E.M.F. To work the motor at this part of its curve all we have to do is to supply it with current at a pressure sensibly lower than that for which it is designed. In good machines the resistance of the armature is very low, so that only a few per cent. of the voltage supplied is lost in resistance, even when the maximum current flows through the armature. If, therefore, we work the motor considerably under its power, the armature loss will be almost negligible, that is to say, the counter E.M.F. will be very nearly equal to the supply E.M.F. Now, if you look at the formula for E.M.F., you find that on the left you have a value very nearly equal to the supply E.M.F., and on the right you have a constant multiplied with the product—field strength and speed. But the field strength under our special conditions of working is proportional to the supply E.M.F. on both sides of the equation, it cancels out, and you find that the speed, multiplied by a constant, is equal to unity. This, of course, holds good for any supply E.M.F. within the straight part of the curve; and we find, therefore, that the speed has a definite value which is independent of the supply E.M.F. We have here arrived at a very remarkable result. It is this, that if you work a shunt-motor underloaded and at a lower pressure than it is designed for, you may vary this pressure within certain limits without either altering the speed or the power given out.

As, however, the motor must be large in proportion to its work, the practical use of this remarkable property of shunt-motors is limited. What users of these machines want to do is not to get little power out of them, but to get as much power as possible, and, in many cases, more than was intended by the designer. Let us, then, see how we stand in the matter of speed and power regulation when we work the machine throughout the whole range of output for which it is designed. First, as to speed. Let us assume that the machine is working at a certain speed giving off a definite amount of power, and sup-

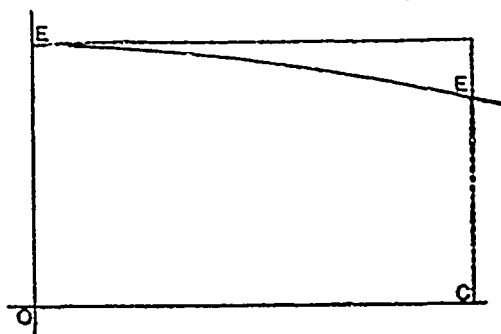

FIG. 5.

pose we wish to increase the speed. How shall we do it? The E.M.F. formula tells us. You see that field strength and speed occur on the same side of the equation. This means that the one can only be increased at the expense of the other. If we want the machine to run faster we must weaken its field, if we want it to run slower we must strengthen it. The variation of field strength is most conveniently brought about by a variable resistance in the shunt circuit of the machine before you, and can show you, by an experiment, this method of regulating the speed.

In this experiment we have altered both the speed and power, because, by running faster, we have obtained more current from the second machine and a brighter light in the lamp. Let us now see whether it is possible to keep the speed constant, and yet vary the power. Bearing in mind that the dynamo is a reversible machine, and drawing a parallel be-

tween a shunt-dynamo and a shunt-motor, we conclude that there should be no difficulty in doing this. The fact that a shunt-motor is an almost self-regulating machine has been first pointed out by Mr. Morley in an article which appeared in January, 1886, in the *Philosophical Magazine*. Mr. Morley's reasoning was somewhat as follows:—We know that a shunt-dynamo will, if driven at a constant speed, give an almost constant terminal pressure, no matter how the current may vary. Consequently, a shunt-motor, if supplied with current at constant pressure, will run at an almost constant speed, no matter how the load may vary. On testing his theoretical deduction by actual experiment, Mr. Morley was able to completely verify it. In one set of experiments the supply current was kept at 140 volts, and the load on the motor was varied from 1.8 to 16.3 H.P., yet the speed only varied by 3 per cent.; and a similar result was obtained with the same machine at a supply pressure of 100 volts. Mr. Morley stated in his Paper that the magnetic distortion of the field was *nil*, or, as we might also term it, that the armature reaction was negligible. It is, however, easy to see that, even if the armature reaction is sensible, we can yet obtain very fair regulation, provided we take care to have in the armature circuit such a resistance that the voltage loss due to the resistance is about equal to that due to armature reaction.

To explain this I must first say a few words about armature reaction, a phenomenon which may, perhaps, not be familiar to all of you. The current flowing through the armature transforms it into an electro-magnet, which, to a certain extent, opposes the flow of magnetic lines emanating from the field magnets. This is the case both in dynamos and motors, though not quite to the same extent. The larger the current the larger is the opposition which the armature offers to the field magnets; and it is the field strength which remains, after making allowance for this opposing magnetic force, which is productive of electromotive force. To calculate correctly the counter E.M.F. of a shunt-motor, we must, therefore, not assume the field strength in our E.M.F. equation to be constant, as I have done hitherto; but we must assume that it decreases slightly as the armature current increases. Graphically, this is represented in

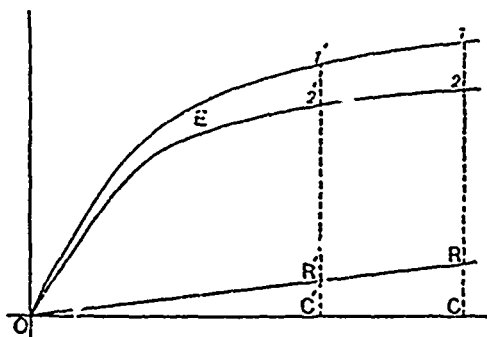

FIG. 6.

Fig. 5, where the current flowing through the armature is measured on the horizontal O C, and the field strength is represented by the inclined full line above. If there were no armature reaction, the field strength would be given by the dotted horizontal line. If the speed is to remain constant, the counter E.M.F. must be proportional to the field strength; and, by suitably altering the scale (with which we measure the ordinates in the diagram), we can take the top line to represent counter E.M.F. I have accordingly marked it E E.

The vertical distance, O E, represents now the supply E.M.F.; and when the motor is running light, this is, of course, equal to the counter E.M.F. Now, let a load be thrown on, causing a considerable increase of current. The counter E.M.F. need now not be quite so large as before, since part of the supply E.M.F. has been already absorbed by the resistance of the armature circuit, and the counter E.M.F. need only balance the remainder. We find, thus, that the supply condition of constant voltage requires the counter E.M.F. to become lower, as the power demanded from the motor increases. At the same time, the working condition of constant speed can only be attained by a lowering of the counter E.M.F. as the current increases; and it is, therefore, perfectly obvious that, if the lowering of the counter E.M.F., as determined by either condition, is the same, we must have constant speed at variable power—

that is, a self-regulating motor. Generally, the line E E in the diagram representing counter E.M.F. is not quite straight, but slightly curved, presenting the concave side to the axis of abscissæ; whilst the line representing resistance loss through armature is, of course, quite straight. If we so design the machine as to get exactly the same speed when running quite light and fully loaded, the speed will be slightly less at half-load, but the difference can only be very small. I am able to show you this property of the shunt-motor to be almost perfectly self-regulating by means of the apparatus here before you.

Thus you see that the shunt-door motor is an excellent machine for keeping the speed constant when worked on a constant-pressure circuit. The only drawback to its employment is, that the resistance must be inserted into the armature circuit at starting; but this may be done automatically, by placing the resistance permanently in circuit, and causing it to be short circuited by means of a centrifugal regulator fixed to the armature shaft, and so arranged that when the speed has attained a certain value the balls fly out and close a switch. Such an automatic device is also of value in case the motor should be overloaded. If this should happen the speed will drop, and the resistance will be automatically re-inserted, keeping the current within safe limits. By these means a customer of an electric light company is prevented from taking from the mains more current than he has contracted for.

Before leaving the subject of speed regulation on constant pressure circuits, I must briefly allude to a system in use on electric tramways. Motors for tram-cars are not required to run at a constant speed, but they are required to have a wide range of torque. At starting or when running uphill, the speed may be low, but the static effort must be great. These motors are, therefore, generally series-wound, and provision is made by means of a compound switch for inserting a larger or smaller number of field magnet coils, so as to vary the field strength according to requirements. The arrangement of the motors under the floor of the car is shown on the diagrams on the wall, which represent respectively the cars of Mr. Reckenzaun, the Electrical Engineering Company, and the General Electric Power and Traction Company, but time will not permit of my going into the details of the various designs.

When current is supplied to the motor not from a general system of mains, but from a special generator, serving no other purpose, the regulation of speed and power can be effected equally well by series, compound, or shunt-machines. As regards the latter, I need not go into details, as this case is really included in the case of supply at constant pressure, which I have already fully treated. After what I have said about this case, you will also readily see that compound wound motors with the main coils demagnetising are equivalent to shunt-motors with large armature reaction, and that, in fact, a shunt-motor with very small armature reaction, such, for instance, as a multipolar machine, may be made self-regulating by the addition of demagnetising main coils on the field magnets. I shall later on give you details of a large transmission plant carried out on these lines, and need, therefore, not go further into the subject now. There remains, then, only the plain series motor to be considered.

In this case both the generating and the receiving dynamo are series-wound, and it is easy to see that by suitably designing these machines we can bring it about that the motor will run at a constant speed under varying loads if the generator is kept running at a constant speed at all times. Let the two curves in Fig 6 represent E.M.F. characteristics of the two machines, the upper curve referring to the generator and the lower to the motor. These curves give the useful E.M.F. after deducting armature reaction, and refer, of course, to constant speed in each case. The current flowing through the circuit is that which we obtain by dividing the difference between the ordinates of the two curves by the total resistance. The resistance is, of course, a constant, and the curve representing current and difference of E.M.F. is, therefore a straight line, O R in the diagram. The vertical length, C R, gives the voltage loss with a current, O C, due to resistance, and this must be equal to the voltage difference, 1, 2, between the curves. This determines, therefore, the speed of the motor for that particular current. Suppose the lower curve is the E.M.F. characteristic

for that particular speed. Now, let us throw some of the load off, then the current will assume a smaller value, say  $O C'$ . The voltage loss is now  $C' R$ , and the voltage difference  $1' 2'$ . If the E.M.F. characteristic fits this new working condition, then  $1' 2'$  must be equal to  $C' R$ , and the speed will remain the same as before. We thus find that if we so design the machines that the difference between their E.M.F. characteristics at any working point is equal to the voltage loss by resistance, we obtain a perfectly self regulating system of power transmission. Most of the transmissions now at work have been designed by taking advantage of this very valuable quality of series machines, but I must state at once that, in actual practice, the case is not quite so simple as I have here represented it. One of the difficulties met with is that we cannot always get the two characteristics to fit each other exactly over the whole range of output; another difficulty arises from there being generally a slight difference between the ascending and descending characteristics; but the most serious obstacle to quick and perfect regulation is the self-induction of the field magnets, especially if the machines are large. The self-induction prevents the rapid response of one machine to the other which is required to make the regulation absolutely perfect. A sudden change of load cannot be followed immediately by a corresponding change in the power supplied to the motor, as time is required by the magnets to settle down into the new working condition; and during the transitory period, which may last many seconds, there is a surging of power to and fro which creates fluctuation of speed. To mitigate this evil, Herr Dobrovolsky, of the Berlin Electric Company, has devised a plan by which a kind of electrical damper is applied to the generator in the shape of a non-inductive high resistance placed across the terminals of the magnet coils as a shunt, and left there permanently. Any abnormal wave of E.M.F. which might otherwise disturb the working of the motor or endanger the insulation of either machine spends itself in heating this resistance, and the disturbance quickly subsides.

#### THE LINE.

I pass now to the consideration of the line, a subject of great importance, especially in long distance transmission, since in these cases the cost of the line forms a very large item in the total cost of plant. You are all familiar with Sir William Thomson's law for greatest economy in conductors. Briefly, the reasoning on which this law has been developed is as follows:—The annual cost of power delivered is made up of two items. First, the cost of the power only, and secondly, the interest on the capital outlay. The cost of power includes that amount which is wasted in heating the conductor. If I therefore wish to work with the greatest economy, the sum of annual interest on the capital outlay and cost of power wasted must be a minimum; and this condition is attained when the two are equal. Prof. Ayrton and Perry were the first to question the practical applicability of this law. In a Paper read by them before the Institution of Electrical Engineers, in March, 1888, they showed that, under certain conditions, better economy can be obtained by departing from, instead of following, Sir William Thomson's law. I do not propose to give you quotations from their paper, which is highly mathematical, but I will endeavour to put the subject before you in a different way, requiring only very little mathematical treatment.

First of all, let us see, in a general way, what Sir William Thomson's law really means. It supposes that the annual electrical horse-power has a definite value at any place reached by the conductor. This is generally assumed for the distributing system as carried out from central stations. Whether a customer lives 100 yards or 500 yards from a central station, the company charges him the same for the current. But the assumption is not, strictly speaking, correct. To see this, let us suppose that the cost to the company of putting an annual horse power into their mains is £20, and they get £30 for every annual horse-power taken by the customer. Now, if I lose 1 H.P., shall I be right in writing off this loss at £20? Clearly not; for if I had not lost this particular horse power, I might have sold it for £30. But there is another way of looking at this. You might say that the £10 difference between the cost and selling price of power represents profit and interest of plant and mains, and that, therefore, the lost power should be debited at net cost. To this I reply, that my object is not to put power

into the mains, but to take power out, or, rather enable my customers to take power out, for which they will pay me; and so we might keep arguing the question, without ever coming to a definite understanding. Now, if we cannot settle such a simple problem by common-sense reasoning, there must be something wrong in our premises; and in this case, it is not difficult to see where the hitch is. It is in the assumption that the power has a constant value. In reality, this is never the case. If it were the case—that is to say, if one horse-power had the same value at the motor end as it has at the generator end of the line—it would be perfectly useless to establish a transmission plant; it would be like carrying coals from Cardiff to Newcastle. It is only because the power has a great value at the motor end of the line, and a small value at the generator end, that it will pay us to lay out capital in plant, and incur the risk of working it.

Under no circumstances will it be economical to lose more than half the total power in the line.

The correct way of treating this problem is, therefore, to take into account the cost of the power, both at the generating and at the receiving station. We must, further, take into account not only the interest and depreciation of the line, but also the interest and depreciation of the machinery at either end; and, in estimating these items, we must know at what voltage the plant is to work, and what total power is required; for the prime cost per horse-power depends very materially on the total power and voltage. To make this clear: if I want to reduce the capital outlay on the line, I must work at high voltage, and with a large energy loss. This means that I must put down a larger generator than would otherwise be required, and, moreover, one that gives a high pressure current. It is thus quite possible that what I save in the line I shall have to expend at the generating station, to say nothing of the increased charge for waste power, and the greater liability to have a breakdown, owing to high voltage.

You see this problem is a very complicated one; and Thomson's law, which says nothing about voltage or cost of machines, will not fit it. It is, however, possible to amend this law, so as to obtain at least an approximate solution. The premises on which the formula has been deduced are as follows:—

*Conditions given.*—Annual value of brake horse-power at generating station; voltage at generator terminals; brake horse-power required at motor end; distance of transmission; cost per horse-power of machines and regulating appliances at the given output, and voltage; cost of conductor, per ton of copper erected, interest, and depreciation of whole plant.

*Data required.*—Working current, brake horse-power at generating station, mechanical efficiency, voltage at motor, total capital outlay per brake horse-power delivered, and cost of annual brake horse-power.

The efficiency of each machine is assumed to be 90 per cent. The formula gives only the current, but the other data can be found by very simple calculations, which need no explanation. The cost of supports for the line per mile, whether overhead or under ground, can be taken as constant, that is, not depending on the exact current within the limits, which can easily be foreseen in each case; and it therefore does not enter into the formula for the current. Interest and depreciation I have taken the same for all parts of the plant, so as to avoid too great a complication of the formula. If you now work out by the aid of the current formula the same transmission problem for different voltages, you will find that there is one particular voltage for which the annual cost of the brake horse-power delivered at the motor end of the line is a minimum; and, provided this voltage is within reasonable limits, it ought to be adopted. When making such calculations, you will find that the greater the cost of power at the generating station, the higher is the most economical voltage, this voltage also, of course, increasing with the distance.

Each case must be worked out with due regard to local conditions, and nothing in the shape of cut and dried rules or figures can make this work superfluous. On the other hand, it is very desirable to collect information as to the cost of works which have actually been carried out, and by the liberality of Mr. Brown, the engineer to the Oerlikon Works, Switzerland, I am able to place before you some figures of this kind which are contained in the following table. The figures give the whole

capital outlay for the electrical parts of some of the power transmissions erected by this firm:—

COST OF TRANSMISSION OF POWER PLANT.

Distance in miles.	H.P. Delivered.	Speed of Machines.	Cost in £.			Total Cost.*	Cost per H.P.
			Gen.	Mot.	Line.		
1.870	85	450	640	560	440	£1,880	£22.2
2.80	195	500	760	680	132	1,800	9.7
2.80	51	600	320	280	60	720	14.1
3.75	90	550	520	480	80	1,240	13.8
5.60	71	600	440	400	60	1,040	14.6
2.80	40	700	260	240	20	640	16
3.75	75	600	480	440	68	1,120	15
5.00	87	500	520	480	100	1,260	14.5
1.560	150	600	760	720	336	2,050	13.7
2.20	93	450	440	420	232	1,270	13.7
6.250	11	900	132	110	480	960	87
2.200	51	600	360	320	300	1,140	22.4
.187	60	900	240	220	18	600	10
5.000	41	750	240	200	344	1,020	24.8
3.750	220	600	1,040	960	640	2,960	13.5
.002	15	600	112	104	8	252	16.8
.250	19	700	160	160	20	390	20.5

\* This includes regulating apparatus, instruments, posts, insulators, lightning arresters, erection and supervision.

TORONTO BRANCH C. A. S. E.

The last regular meeting of the above society was held on Friday evening, February 12th, President A. E. Edkins in the chair.

On motion the general routine of business was postponed until next regular meeting. This was done in order to give the members a chance to hear Mr. G. C. Robb, Chief Engineer of the Boiler Inspection & Insurance Co. of Canada, who had been kind enough to promise to give them a "talk" on "Steam Boilers, and What Takes Place during the Process of Getting up Steam."

Mr. Robb made frequent use of the black-board for purposes of illustration, and for two hours remained on his feet and held the attention of his listeners. Those who know Mr. Robb will readily understand how difficult it would be to listen indifferently to an address from him on this subject. He has the faculty of easily conveying ideas to his hearers; and, taking into consideration the experience, both practical and theoretical which he has had in connection with steam engineering, it is not difficult to foresee the good which must ultimately result from lectures of this kind to practical working engineers.

The attendance at the meeting was not as large as it might have been, owing in a measure no doubt to the severity of the weather.

At the termination of the lecture a hearty vote of thanks to the speaker was unanimously carried. Mr. Robb in reply, as-

ured the members that he was very glad to be of service to them and while modestly claiming to be (like themselves) a student in steam engineering, would be most happy to meet them again in the near future.

CONVERTERS IN PARALLEL.

FOR the information of those whose experience has not extended so far that they are loth to do other than just what they are told to do when an alternating plant is purchased or installed, we desire to point out that it is possible in putting up converters for supplying a large number of lights in any vicinity, to connect one or more large converters or transformers, or a number of small ones in parallel or multiple, to accomplish such supply, and with the best results. This is known as "banking" them, or as a "bank of converters." If the current is being supplied by meters they can also be "banked," in which case it becomes necessary to connect the converters to what may be

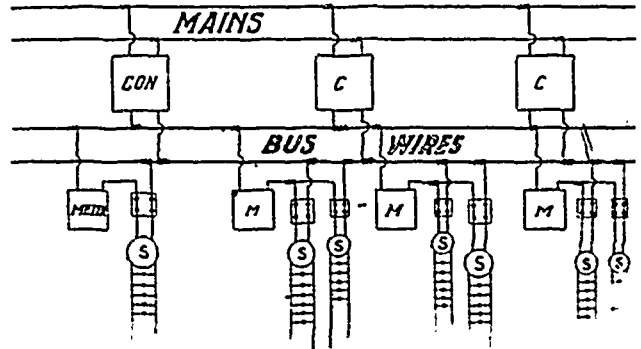

called bus-bars, and the supply is taken from the bus-bars through the meters, which may be arranged to supply any number of circuits. This is fairly well illustrated by the accompanying sketch, this arrangement being at present in use for supplying some 200 lights in a large church.

The example set by the Plymouth chamber of commerce has been followed by the Halifax and Bedford chambers, who have proposed resolutions calling upon the government to buy-up the telephones of the country

The Toronto Incandescent Electric Light Co. announce that with the object of securing satisfactory work, they have established a wiring department.

The report of the Citizens Committee on rapid transit for Chicago brought out the fact that Port Arthur, Ont., is the only city in America operating its own street railway.

The contract for lighting the city of Quebec being about to expire, the Quebec and Levis Electric Light Co. proposes to advance prices \$10 per lamp per annum, while the city talks of doing its own lighting.

An iron pulley on one of the dynamo machines in the new electric light station at Toronto Junction recently burst while running at full speed. The fragments flew in all directions, but the attendants miraculously escaped unhurt. The pulley was at once replaced by a Dodge Wood Split Pulley (ordinary stock), and the attendants now feel somewhat safe again. Moral—use Dodge pulleys.

SPARKS.

It is understood that a provincial tax will be placed on telephone and telegraph companies, by the government of New Brunswick.

An electric wire heated to the proper temperature is recommended as an efficient and economical improvement on present methods of cutting ice.

On the 2nd of February there was tested and operated at the Edison General Electric Co.'s works, Peterborough, Ont., a mining locomotive. The test was made amid a blinding snowstorm, and our informant states that the results were entirely satisfactory. This is the first and only electric locomotive manufactured in Canada.

Between 1887 and 1889 the number of telegraph offices in the United States was increased by 20 per cent., against an increase of 8 per cent. in England. In the United States there is one telegraph office to every 2,400 of the population; in England there is one to every 5,500. In England there is one office to every 17.27 square miles, in America one to every 171 square miles, the population per square mile being in the ratio of 100 to 5.6. The average mileage of a message in America is, however, 540 miles; while the longest possible distance in England is 600 miles.

A. ALLAN, President.

J. O. GRAVEL, Sec.-Treas.

F. SCHOLEN, Man.-Director.

THE CANADIAN RUBBER CO. OF MONTREAL

CAPITAL, - \$2,000,000.

MANUFACTURERS OF ALL KINDS OF

**HARD AND SOFT**

**RUBBER GOODS**

FOR ELECTRICAL PURPOSES,

—INCLUDING—

BLACK AND WHITE TAPES, TUBINGS,

ROD, SHEET, TELEPHONE RECEIVERS, ETC.

Rubber Bellings, all kinds of Hose, Packings, etc.  
Mould Goods of every description.

WESTERN BRANCH:

COR. FRONT AND YONGE STS.,

J. H. WALKER, Manager.

**- TORONTO.**

**A SUBSCRIBER'S SUGGESTION.**

PETROLIA, Jan. 21st, 1892.

Editor CANADIAN ELECTRICAL NEWS.

DEAR SIR,- Your note in this month's NEWS with regard to the bewilderment caused Mr. Justice Ferguson by the use of technical terms in his court, suggests to me to tell you that to many of your subscribers the greater part of the ELECTRICAL NEWS is utterly unintelligible. Many of us haven't what I suppose you would call the merest rudiments of electrical knowledge. There have been, it is true, explanations of the working of electricity, but they all assumed the reader to have some knowledge in the matter, and many words were used in a sense that conveyed no meaning to us. Now a dynamo, with the parts named and the use of each explained in simple language, would be a comfort to many of your readers. Hoping that you will accept the suggestion in as kindly a spirit as it is meant,

I am, yours respectfully,

J. A. L.

**SAFETY VALVES--THEIR HISTORY, ANTECEDENTS, INVENTION AND CALCULATION.**

By WILLIAM BARNET LE VAN.

(Continued from February number.)

AS will be noticed in Fig. 23, pins are not used for the fulcrum, but knife edges are used, as shown, to transmit the pressure of the lever to the safety valve through a pin pointed at the bottom end. This arrangement is far preferable to that generally adopted where joint pins are used, and should come more generally into use.

The lever safety valve recommended by the Board of Supervising Inspectors of Steam Vessels, is represented in fig. 24. The following directions are given regarding its construction:

All the points of bearing on the lever must be in the same plane. The distance of the fulcrum must in no case be less than the diameter of the

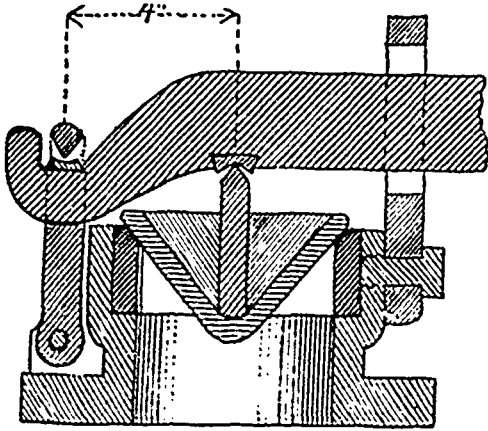

FIG. 23.

valve opening. The length of the lever should not exceed the distance of the fulcrum multiplied by 10. The width of the bearing of the fulcrum must not be less than 3/4 of an inch. The lever of the fulcrum link should not be less than 4 inches. The lever and fulcrum link must be made of wrought iron or steel, and the knife-edged fulcrum points and bearings for the points must be made of steel, and hardened. The valve sit, and bushings for the stem or spindle, must be made of composition (gun metal) when the valve is intended to be attached to a boiler using salt water, but when the valve is to be attached to a boiler using fresh water, and generating steam of a high pressure, the parts named, with the exception of the bushings for the spindle, may be made of cast iron. The valve must be guided by its spindle, both above and below the ground seat, and above the lever, through supports either made of composition (gun metal) or bushed with it. The spindle should fit loosely in the bearings or supports. When the valve is intended to be applied to the boiler of steamers navigating

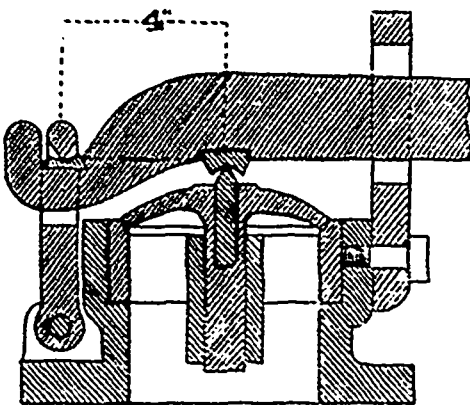

FIG. 24.

rough waters, the fulcrum link may be connected directly with the spindle of the valve, provided always that the knife-edged fulcrum points are made of steel and hardened, and that the object sought by the link is obtained--namely, the vertical movement of the valve, unobstructed by any lateral movement. In all cases, the weight must be adjusted on the lever to the pressure of steam required in each case by a correct steam gauge attached to the boiler. The weight must then be securely fastened in its position, and the lever marked for the purpose of facilitating the replacing of the weight, should it be necessary to remove the same.

**A PERFECT SAFETY VALVE.**

A perfect safety valve is one which will rise as soon as the pressure at which it is set is attained that will prevent the pressure increasing if the

boiler is forced to its utmost extent, and that will close promptly as soon as the pressure commences to fall. With all the experience of engineers, it seems impossible to design a valve possessing all the above features, but no doubt it can be closely approximated to.

**TABLE OF AREAS OF VALVES OF DIFFERENT DIAMETERS.**

Diameter of Valve-- Fractions.	Decimals.	Circumference of Valve in Inches. Decimals.	Area of Valve in Square Inches. Decimals.
1-32	0.03125	0.0981	0.00076
1-16	0.0625	0.1963	0.00306
3/64	0.125	0.3926	0.01227
3-16	0.1875	0.5890	0.02761
1/4	0.25	0.7854	0.04908
5-16	0.3125	0.9817	0.07669
3/8	0.375	1.1780	0.1103
7-16	0.4375	1.374	0.1503
1/2	0.5	1.57	0.1963
9-16	0.5625	1.767	0.2485
5/8	0.625	1.963	0.3067
11-16	0.6875	2.159	0.3712
3/4	0.75	2.356	0.4417
13-16	0.8125	2.552	0.5184
7/8	0.875	2.748	0.6013
15-16	0.9375	2.945	0.6902
1	1	3.1416	0.7854
1-1/16	1.0625	3.3379	0.8861
1 1/4	1.125	3.5343	0.9910
1 1/2	1.1875	3.7306	1.1075
1 3/4	1.1875	3.9270	1.2271
1 1/2 Full.	1.2011	3.9564	1.25
1 5/8	1.3125	4.1233	1.3529
1 3/4	1.3667	4.2915	1.4625
1 7/8	1.375	4.3107	1.4848
1 3/4	1.382	4.3394	1.5
1 7/8	1.4375	4.5160	1.6229
1 9/16	1.4912	4.6817	1.75
1 1/2	1.5	4.7124	1.7671
1 9/16	1.5625	4.9087	1.9175
1 5/8	1.5957	5.0083	2
1 3/4	1.625	5.1051	2.0739
1 11/16	1.6875	5.3014	2.2365
1 3/4	1.692	5.3128	2.25
1 3/4	1.75	5.4978	2.4052
1 3/4	1.7823	5.5954	2.5
1 13/16	1.8125	5.691	2.5821
1 3/4	1.86	5.8407	2.75
1 3/4	1.875	5.8905	2.7611
1 15/16	1.9375	6.0868	2.9483
2	1.9537	6.1324	3
2	2	6.2832	3.1416
2	2.034	6.3867	3.25
2 1-16	2.0625	6.4795	3.3411
2 1/8	2.1105	6.6251	3.5
2 1/8	2.125	6.6759	3.5465
2 1/8	2.1838	6.8452	3.75
2 3-16	2.1875	6.8722	3.7582
2 1/8	2.25	7.0686	3.9760
2 1/8	2.256	7.069	4
2 5-16	2.3125	7.2649	4.2001
2 1/8	2.3248	7.2848	4.25
2 1/8	2.375	7.4613	4.4302
2 7-16	2.3934	7.5040	4.5
2 7-16	2.4375	7.6576	4.6664
2 3/8	2.4416	7.6616	4.75
2 3/8	2.5	7.8540	4.9887
2 3/8	2.525	7.9280	5
2 9-16	2.5625	8.0503	5.1573
2 3/8	2.5842	8.1012	5.25
2 3/8	2.625	8.2467	5.4119
2 3/8	2.646	8.3084	5.5
2 11-16	2.6875	8.4430	5.6727
2 3/8	2.7049	8.4937	5.75
2 3/8	2.75	8.6394	5.9395
2 13-16	2.7636	8.6758	6
2 13-16	2.8125	8.8357	6.1226
2 3/8	2.82	8.8548	6.25
2 3/8	2.875	9.0321	6.4918
2 3/8	2.8764	9.0365	6.5
2 3/8	2.9305	9.20	6.75
2 15-16	2.9375	9.2284	6.7772
2 3/8	2.9835	9.3666	7
3	3	9.4248	7.0686
3	3.0365	9.5330	7.25
3 1-16	3.0625	9.6211	7.3662
3 1/8	3.0884	9.6963	7.5
3 1/8	3.125	9.8175	7.6699
3 1/8	3.139	9.8596	7.75
3 3-16	3.1875	10.0138	7.9798
3 1/8	3.19	10.0160	8
3 1/8	3.25	10.2102	8.2957
3 1/8	3.288	10.3243	8.5
3 5-16	3.3125	10.4065	8.6179
3 1/8	3.375	10.6029	8.9402
3 1/8	3.384	10.6257	9
3 7-16	3.4375	10.7992	9.2806
3 1/8	3.47	10.8958	9.5
3 1/8	3.5	10.9956	9.6211
3 1/8	3.77	11.8378	10
4	4	12.5664	12.5664
4	4.371	13.725	15
4 1/2	4.5	14.1372	15.9043
4 1/2	4.75	14.9226	17.7205
5	5	15.7080	19.6350
5	5.047	15.8475	20
5 1/4	5.5	17.2783	23.7583
5 1/4	5.642	17.7058	25
6	6	18.8496	28.2744
6	6.375	20.0175	30

**SPRING-LOADED SAFETY VALVES.**

I have in my former articles given a description of those safety valves which are held to their sits against internal pressure by weights, either act-

ing directly or through levers, and which are most generally in use on stationary and marine boilers. I now propose to give the history of those which are held to their seats against internal pressure by springs, either acting directly or through levers, used almost exclusively upon locomotives, and to a great extent on portable and marine boilers.

As before stated, safety valves were employed by Papin in 1680, and are therefore, two hundred years old, and, as shown, probably much older.

The objections to spring safety valves are, that the compression of the spring is increased with the lift of the valve, and therefore the pressure holding it down to its seat becomes greater the higher the lift, and as the weight of a dead load is constant for any height of lift, the amount of lift of a given valve for any pressure would be less with a spring than with a constant weight. Therefore, boilers with spring-loaded safety valves should be loaded at a certain per cent. below the blowing-off point; or, in other words, suppose a boiler should be allowed, according to law, to carry 100 pounds pressure per square inch, the spring on the valve, to lift the proper weight to free the boiler at that pressure, should be set at 95 pounds, as the accumulated pressure due to the increased compression of the spring will be 5 pounds, and as the valve would blow off at 95 pounds, that would be the working pressure of the boiler, although the limit to which the pressure could accumulate would be 100 pounds per square inch.

Looking at it in this way, the strength of the boiler should be increased on the load upon it reduced, as compared with the practice of dead-loaded safety valves.

The amount of pressure accumulated with spring-loaded valves is a less percentage of the pressure the higher the pressure rises, and there is soon reached a pressure at which the percentage of accumulation becomes so small as to be of little practical importance.

In the United States navy yard experiments, made with spring valves, it was found that the percentage of accumulation at 34 pounds, was 19 pounds, at 59 pounds it was 9.4 pounds; at 80 pounds it was 6 pounds; and at 90 pounds it was 5 pounds.

With the advanced state of boiler engineering, the majority of good boilers have a factor of safety of six—that is to say, the working pressure of the boiler is one-sixth the bursting pressure. At 75 pounds per square inch working pressure, we have a bursting pressure of  $75 \times 6 = 450$  pounds, and a percentage of accumulation upon the load pressure of the spring loaded valve of say 8 per cent.; that is,  $75 \times 8 = 600$  pounds;  $75 + 6 = 81$  pounds. The highest pressure to which steam can be carried in such a boiler, with a properly proportioned spring valve loaded to 75 pounds per square inch is

$$\frac{450}{81} = 5.62, \text{ the factor of safety.}$$

leaving still an enormously large margin of strength before reaching the point of explosion.

The makers of spring-loaded safety valves argue that the pressure of accumulation is the same in dead-weight valves as in spring-loaded valves. If they will but stop and think for a moment, they will see that in the dead-loaded valves the resistance is constant, regardless of the lift of the valve;

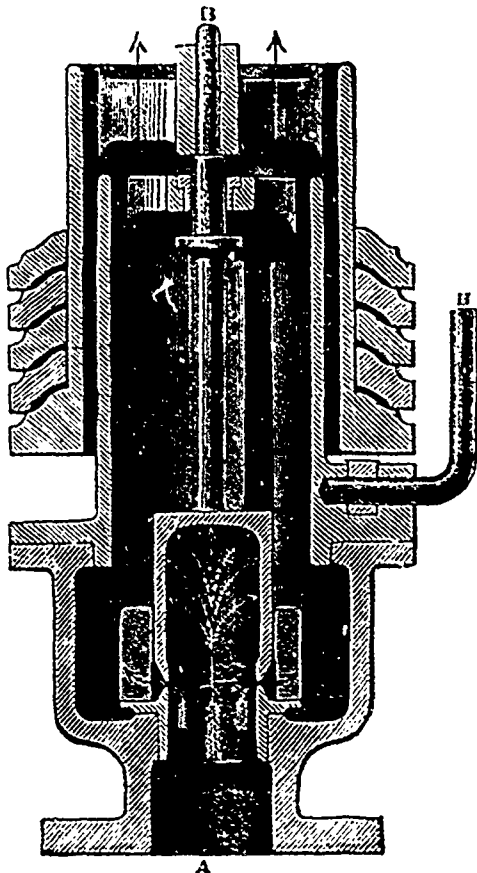

FIG. 25.—DEAD-LOAD OPEN FLOW VALVE.

ters, the area of the circle circumscribed by the outer border of the valve seat is materially larger than the area bounded by the inner border of the valve seat. The smaller area alone, wholly within the seat, is acted on by the confined steam while the valve is closed, the larger area, within the outer border of the seat, is acted on by the escaping steam while the valve is open. It was, therefore, not unnatural to suppose that a safety valve, once opened against a resistance nearly constant, would then open more widely, so as to give free outlet to the steam, and that it would remain open until a very sensible reduction of pressure in the boiler should enable a force, at first overcome by the higher pressure on the smaller area, to overcome in its turn the reduced pressure on the larger area.

That the reverse is true is well known. A safety valve, opened so as to permit the escape of a thin film of steam, can be further lifted so as to permit the free escape of steam, only by considerable increase of pressure, or by some special contrivance. It is usual to explain this phenomenon entirely by the increased resistance of springs due to increased tension, but this cannot be the sole cause, since the same thing is observed in a less degree where weights are used to close the valve. An additional cause is to be found in the expansion of a film of escaping steam between the valve and its seat, as in the familiar "pneumatic paradox," described by Bourne as "the tendency which escaping steam has to shut the valve down." There is also a little sluggishness and hesitancy about a movement produced by a very slight preponderance of nearly balanced forces. All motion is attended with some friction and some inertia, and decided preponderance is required to produce decided movement. To counteract this inertness, and to give promptness and decision—in a word, to give "prop!" to the action of a safety valve, both in opening and in closing, many expedients have been invented.

REACTIONARY SAFETY VALVES.

The construction of reactionary safety valves is such that the steam, after passing the ground-seat of the valve, and prior to its final exit into the atmosphere, is opposed by a "structure," so to speak, which structure generally consists of an extension of the valve beyond the ground seat, and curved downwards; but in some instances is either straight or beveled, and a corresponding extension of the casing curved upwards.

One of the first in this line of improvement was an Englishman named Charles Ritchie, whose patent is dated March 2, 1848, and numbered 12,078. Ritchie's safety valve (Fig. 26) shows an annular lip, or flange, extending all around the valve, an annular chamber for escaping steam ex-

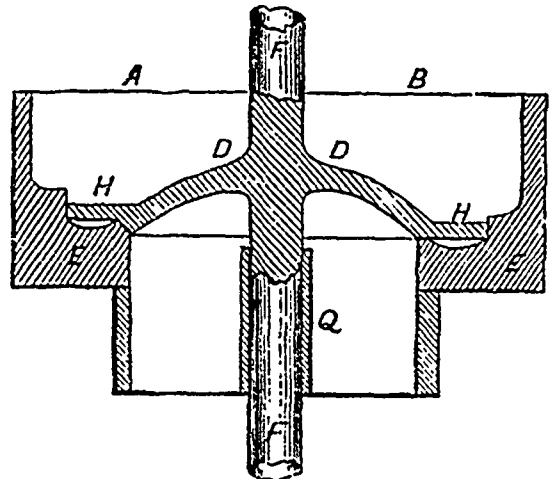

FIG. 26.—THE RITCHIE VALVE.

tending all around the valve seat under the lip of the valve, and a "structure," formed by a cylindrical ring rising from the outer border of the annular chamber, and encircling the lip, or "compensation flange," as its inventor calls it, so that steam, after passing in a thin film through the slightly-opened ground joint, is gathered, or "huddled," in the annular chamber, thereby soon acquiring the full existing pressure within the boiler, or nearly so, and pressing upon the entire area within the outer border of the lip, overcomes the increasing resistance of the spring, lifts the valve so high that its lip surmounts the constricting ring, and permits steam to escape all around a circle of larger periphery than that of the ground joint—the circumference, namely, of the constricting ring. When the desired relief has been obtained, and the pressure within the boiler has fallen by the amount provided for by the proportion of the lip to its valve, the spring closes the valve—slowly at first, and then promptly—giving the kind and degree of action to be desired.

The description of its operation, given in the specification, shows clearly a complete understanding of its principles on the part of the patentee. He says: "As soon as the pressure of the steam raises the valve from its seat, the flange H, being exposed to the pressure of the steam, presents an increased surface, which compensates for the increasing resistance of the helical spring (which surrounds spindle F, but not shown in cut), until the valve has been raised to a height equal to the area of the steam way, when it allows the steam or vapor to escape freely."

(To be Continued.)

Electric heaters have been successfully introduced in the electric street cars at Ottawa.

A portable telephonic apparatus for use in coal and other mines has been devised by M. Berthon. It consists of an oak box with handles. The box contains a magnet in connection, a "call" arrangement, an alarm bell, an induction coil, switch for the microphone battery, three cells in ebony cases, terminals for making connection with a wire conductor, and the well known Berthon-Ader apparatus. The whole is placed in a leather case provided with straps for convenience in carrying. With a well insulated conductor carried down the shaft, and with the employment of "flying" or portable wire, communication with those on the surface is possible with the Berthon apparatus for any part of a mine.

To show the capacity of incandescent lamps to withstand the weather, Mr. W. Claude Johnson writes to *The Electrician* as follows: "I have maintained one of these lamps for four years in a most exposed condition in my garden without any difficulty. The lamp is rigidly fixed at the top of a tubular shaft.

A concentric cable passes through a gland at the top of the shaft, where the lamp is fixed in a vertical position. The cable is connected directly to the platinum loops of the lamp, the joint being then neatly wrapped with pure para rubber strip, and over this a layer or two of compound tape, which encloses a small portion of the glass bulb."

but with the spring-loaded valve, as commonly made, the slightest proportion of lift compresses the spring, and the pressure, acting against this lift, varies directly with the amount of that lift. Therefore there can be no doubt that the pressure of accumulation is greater in the case of the spring loaded than the dead-loaded valve, all circumstances being the same.

To overcome this increase of pressure as the valve rises, it is necessary to increase the area of the valve with its lift, or to arrange that the increased compression of the spring may be compensated in some other way. The form of valve shown in Fig. 25 has been put on the market to overcome the above difficulty.

If the contact between a safety valve and its seat were the contact of two sharp edges, like two circular knives edge to edge, the action of a valve in opening and closing would be simpler than it can generally be in practice. In fact, the surfaces in contact must have, for constructive reasons, a breadth very considerable in proportion to the diameter closed by the valve; and since the areas of circles are to each other as the squares of their diam-



## THE STORAGE BATTERY FOR STREET RAILWAYS.

(Continued from page 35.)

thorough test at the Toronto Electric Light Company's works, including a compartment for the cells—such compartment being provided with two locks and a key to be given to each of the experts. By this means it will be impossible for one of the experts to open the compartment containing the cells without the presence and assistance of the other, and a guarantee of the fairness of the test will thereby be assured.

We are in a position to enter upon the test immediately on the acceptance by you of the above conditions, and the appointment of the expert whom you desire to represent you.

Such a test will result in bringing your battery prominently before public notice, and should its merits be what you claim, will undoubtedly bring you large financial reward.

We will be pleased to publish as fully and as widely as possible the results of the proposed test.

We will willingly make right any injustice, if such has been done to you, in our editorial of last issue.

Kindly let us hear from you on the subject of the above proposition at your earliest convenience, and oblige,

Respectfully yours,

C. H. MORTIMER.

TORONTO, 10th Feb., 1891.

C. H. MORTIMER, Esq., Toronto.

DEAR SIR,—Replying to your favor of the 9th inst., we beg to say that Mr. C. Gordon Richardson has consented to act for us in the matter of testing the battery. We think, however, that the test should take place on perfectly neutral ground, and beg to propose the School of Practical Science, Toronto University. Every appliance necessary for a thorough and exhaustive test will be placed at the disposal of Messrs. Wright and Richardson, and would, we think, be preferable in every way to the place you suggest.

Referring to the number of cells you propose, fifty seems entirely unnecessary to us. I think, perhaps, that had better be left to the experts to decide upon. Awaiting your reply.

Yours truly,

THE ROBERTS STORAGE BATTERY AND ELECTRIC CONSTRUCTION CO.  
By C. N. Sutherland.

TORONTO, Feb. 12th, 1891.

ROBERTS STORAGE BATTERY  
AND ELECTRICAL CONSTRUCTION CO., City.

DEAR SIR.—Replying to your letter of the 10th inst., I have no objection to the test of your storage battery being made at the School of Practical Science, provided the authorities of that institution are willing to furnish the necessary facilities for a sixty days test. Of course as this test is to be made with particular reference to the adaptability of the battery for street car work, the conditions will have to be made as similar as possible. Therefore I think that fifty cells would be required. It will be necessary to know the weight of cells you propose to use for an ordinary street car. The rate of discharge would then be proportioned to the number tested. The average number of amperes required in practice can be ascertained from companies operating electric railroads at present. The load would also be required to be thrown on and off the motor or other resistance at frequent intervals as would be the case in ordinary practice.

Kindly let me know if the management of the School of Practical Science are willing to provide facilities for this being done, and I will get Mr. Wright to meet your expert at once and arrange details.

Respectfully yours,

C. H. MORTIMER.

TORONTO, 13th Feb., 1891.

C. H. MORTIMER, Esq., Toronto.

DEAR SIR.—We beg to acknowledge receipt of your favor of the 12th inst., and learn for the first time that the test you propose making was with particular reference to the adaptability of our battery for street car work, any more than its ability to stand the heaviest charge and discharge rates, its capacity, efficiency and commercial return, and we are unable to see how you are to get any more information than this in the test you propose of 50 cells. As one cell or twelve if you wish will give this information, we are at a loss to know why you required fifty.

As we informed you the other day, we have now an exhibition storage car under way, and will place it on the tracks in this city as soon as possible, and we think we are justified in saying that this will be a more practical and in every way satisfactory test of the adaptability of our battery for street car work, than the test of 50 cells you propose.

We will be glad, however, to have a test made of our battery at the School of Practical Science, and will be pleased to know when and where Mr. Richardson may meet Mr. Wright to arrange details.

Yours truly,

THE ROBERTS STORAGE BATTERY AND ELECTRIC CONSTRUCTION CO.  
Per C. N. Sutherland.

ROBERTS STORAGE BATTERY  
AND ELECTRICAL CONSTRUCTION CO., City.

TORONTO, Feb. 17th, 1891.

DEAR SIR.—Replying to your letter of the 13th inst., I see no necessity for prolonging this correspondence by haggling over details. I made a proposition to you to submit your battery to a thorough test, stating the general conditions under which in my opinion the test should take place. I further offered to provide all the facilities for making such a test. It rests with you either to accept or reject my proposition. After finding all manner of fault with my conditions, you offer in the concluding paragraph of your letter to have a test made at the School of Practical Science. Again I ask to be informed whether you have satisfied yourselves that the management of the School of Science have it in their power to provide facilities for such a test as I desire, whether they are willing to place such facilities as would be necessary at your disposal, and at the disposal of the experts, for the purpose. Lastly be kind enough to state distinctly whether you are willing to submit 50 cells of your battery to a test of 6 days duration in accordance with my proposition. Life is too short to continue this correspondence indefinitely, therefore kindly facilitate matters by stating clearly and definitely what you are prepared to do with the proposition made to you, and oblige.

Respectfully yours,

C. H. MORTIMER.

TORONTO, Feb. 23th, 1891.

THE ROBERTS STORAGE BATTERY  
AND ELECTRICAL CONSTRUCTION CO. City

DEAR SIR. With regard to the objections made on behalf of your company by one of your representatives a day or two ago, to placing 50 cells at

our disposal for a period of 60 days test, and desiring the period of the test to be lessened, I have to say that I have consulted Mr. Wright on the matter and he is of opinion that anything less than a 60 day test would be valueless for the purpose of establishing the wearing qualities of the battery.

If you are not agreeable to our proposition as stated in our letter and through the ELECTRICAL NEWS, it only remains for you to say so. As you state that it is your intention to make a test of your battery on a street car fitted up for the purpose in this city within five or six weeks from this date, I would suggest that in the event of your declining to accept the proposition I have made to you for a test, that you should allow my expert free access to the street car on which your proposed test is to take place. Awaiting your early reply, I remain,

Respectfully yours, C. H. MORTIMER.

C. H. MORTIMER, Esq., Toronto.

TORONTO, 26th Feb., 1891.

DEAR SIR.—I have only this morning returned to the city, and am in receipt of your letters of the 17th and 23th insts. In each of your letters you ask us to state definitely what we are prepared to do. In answer to this I beg to refer you to our letter of the 13th inst., which I think fully answers this question. In regard to the street car test, we have on more than one occasion informed you that we are now getting a car ready to put on the tracks here; the idea of testing the practicability of our battery for street car work on a stationary motor has never for a moment occurred to us. As a general test of the efficiency of our battery we have offered to place the necessary cells in the School of Practical Science for as thorough and exhaustive a test as can be made, and under the direction of Messrs. Wright and Richardson. I quite agree with you as to life being too short to continue this correspondence indefinitely, but in view of the fact of our letter of the 13th inst to you having most fully and clearly stated just what we were prepared to do, I beg to suggest that any unnecessary correspondence is entirely due to either a desire upon your part to evade the question at issue or an entire misapprehension of the facts of the case. We shall be pleased to give Mr. Wright free access to our car at any time. I am, truly yours,

G. H. MACFARLANE, Man. Roberts Storage Battery Co.

ROBERTS STORAGE BATTERY  
AND ELECTRICAL CONSTRUCTION CO., City.

TORONTO, March 2nd, 1891.

DEAR SIR.—Replying to your letter of the 26th ult., in which you agree to place the necessary number of cells in the School of Practical Science for as thorough and exhaustive test as can be made of your battery, under the direction of Messrs. Wright and Richardson, nothing now remains to be done but that you should see that all the required facilities are provided at the School of Science for such a test as you describe. On receipt of your assurance that this has been done, we shall be happy to proceed immediately with the test. Awaiting your early reply, I remain,

Yours respectfully, C. H. MORTIMER.

C. H. MORTIMER, Esq.,

TORONTO, March 5, 1891.

DEAR SIR.—Immediately upon receipt of your letter of March 2nd, I wrote Mr. Richardson informing him that you were ready to accept our proposition of test being made in School of Practical Science, and have just learned that he is absent from the city, but that my letter has been forwarded to him. As soon as we hear from him as to the day he will be here, we will let you know at once.

Yours truly,

THE ROBERTS STORAGE BATTERY AND ELECTRIC CONSTRUCTION CO.  
By G. H. Macfarlane

TORONTO, March 6th, 1891.

ROBERTS STORAGE BATTERY CO., City.

DEAR SIR.—Your letter of the 5th inst. to hand and noted. It gives no assurance, however, that you have ascertained that the necessary facilities for such a test as we propose to make will be placed at the disposal of the experts by the authorities of the School of Science. I would suggest that you attain all information on this point at once, and by so doing prevent possible waste of time and perhaps the annoyance which would follow the discovery that owing to lack of necessary facilities, the test could not be satisfactorily carried out.

Yours truly, C. H. MORTIMER.

No reply has ever been received to our last communication on this subject, nor has the promised test of a street car ever taken place.

## THE RIVAL OF THE POLE STAR.

WE are indebted to a correspondent for the following description of the electric plant at Edmonton, N.W.T.: Edmonton, Alberta, a village of 600 or 700 inhabitants, and the terminus of the Calgary and Edmonton railway, is the proud possessor of an electric light plant—proud because of the excellency of the plant and light and the fact that it is the most northerly thing of the kind on this continent, at any rate east of the Rocky Mountains.

A contract was entered into with the Royal Electric Company, of Montreal, on the 17th September, 1891, and on the 22nd of December the light was turned on and so far the company have not had a "shut down," a common occurrence with some plants in the N.W.T.

The plant consists of a 500 light alternator, 50 H.P. Leonard-Ball engine and 60 H.P. boiler. Owing to the scattered nature of the town, it took nearly six miles of main line to reach all the consumers. Over 300 lights are installed now, but it is expected that the machine will be on full load next autumn, as a mild boom is on the town, filling up the blank spaces with new buildings, and the light is highly appreciated in a place where the sun sets in the winter before 4 p.m.

Coal costs only \$2.25 per ton, delivered at the furnace door, so dividends are confidently looked for by the shareholders even at the very low rates charged per lamp.

The place has just been incorporated and a contract for street lighting will shortly be entered into with the council.

An electric railway is to be built at Calgary, N.W.T.

Supplementary letters patent have been issued to the North American Mill Building Company of Stratford, Ont., giving the company power to operate works for the production of electricity for light, heat and power.

**SUSPENDED STREET RAILWAY.**

THE accompanying illustrations show a suspended or elevated street railway, the invention of Geo. R. Prowse, F. F. Kelly, J. Beaudry and Wm. Norris, of Montreal. The cut shows an end elevation of the post, with a suspended car having a single row of seats, for the city service, and an elevated car for fast suburban service. At suitable intervals an arched support may be affixed for electric light, so as to avoid disfiguring the streets with wooden posts.

The iron truss posts, firmly held under ground and placed at intervals along the centre of the street, support the whole combination. At the cross streets, an arched support of easy access may be provided for the electric light, in such a way as to not interfere with the passing of the cars. A double cross-arm extends on both sides of the post, supporting at its ends two longitudinal beams on which the cars run, going on one side and returning on the other; it carries on its centre the tracks of the fast suburban elevated electric car. Two longitudinal beams or girders span the distance between the posts, and support on the outer edge a single rail on which the car travels. There are two small guide rails on each girder to steady the car and prevent its lateral oscillation.

The suspended car being adjusted by regulators according to the amount of snow on the roadway, a small snow plough may be fixed to the front of the car so as to remove all the irregularities of snow drifting. The wheel is brought in contact with the live wire through mechanism in the hands of the driver,

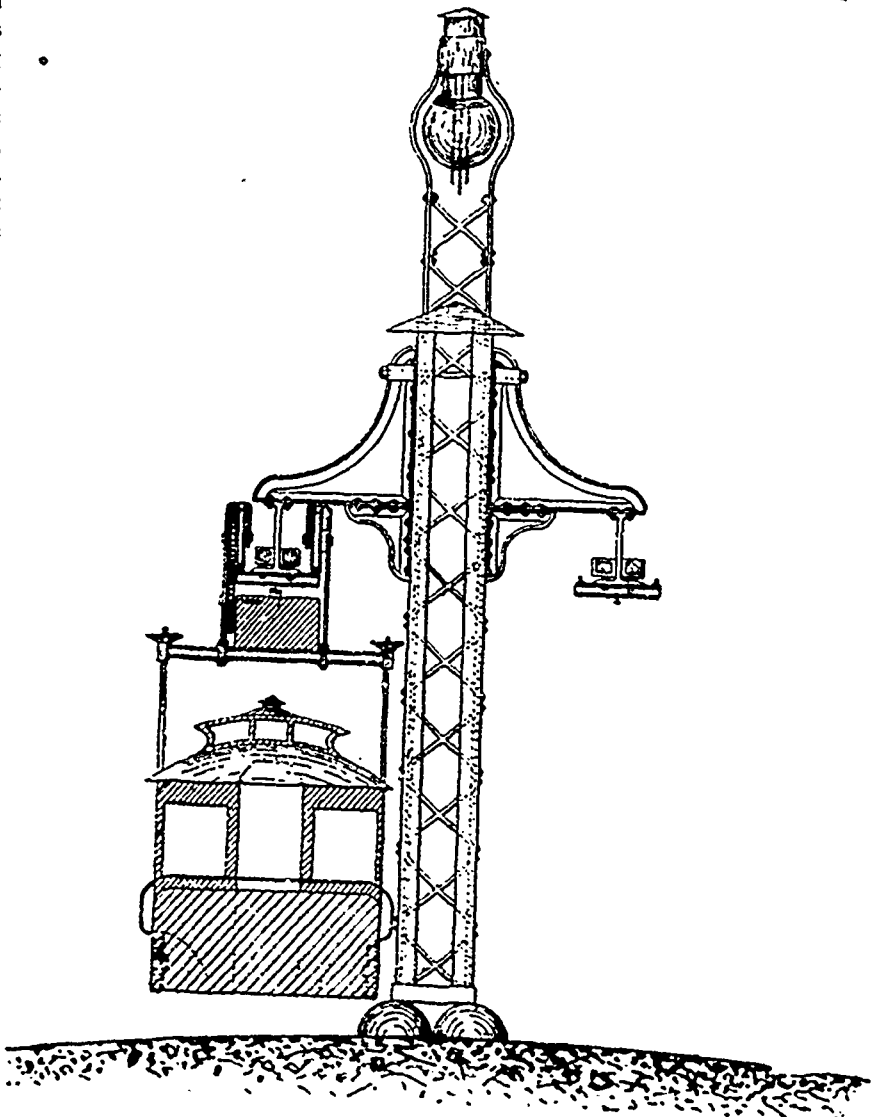
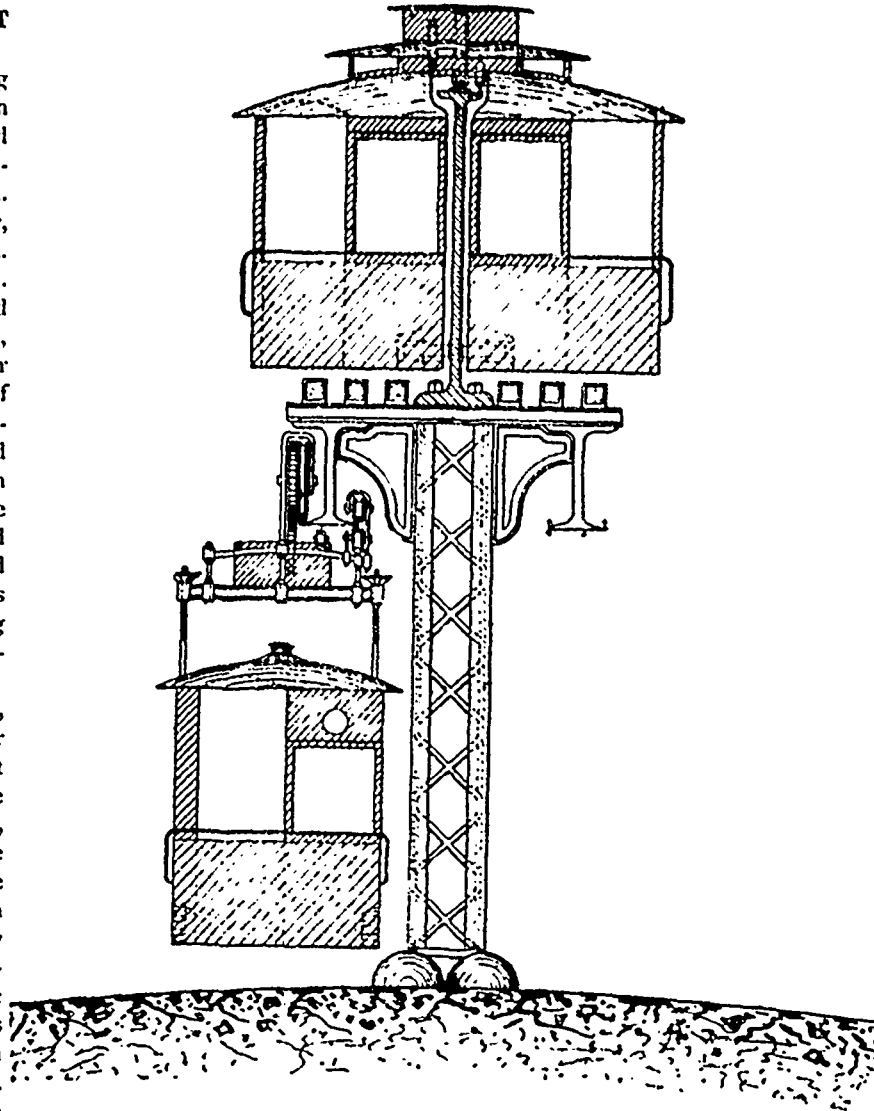

and the electricity transmitted to the motor, acting either in one direction or the other.

The elevated car rests only on longitudinal joists without ties, so as not to throw much shade on the street, the steel rails being held in their position by iron rods bolted to them at a convenient interval, the service being absolutely that of ordinary electric surface railways. Indurated wood pulp being lighter and incombustible may be adopted for these cars.

Electric wire conduits are placed along the girders or longitudinal beams so as to do away with the wooden posts in the streets of towns and cities, and also protecting the wires from induction or leaks.

The cost of construction of the suspended railway is supposed not to exceed \$35,000 per mile, and the suspended and elevated \$50,000 per mile.

A patent air brake, the invention of Major Chapleau, on something the same principle as the Westinghouse air brake, is being experimented with by the Ottawa Electric St. Railway Co.; if successful all that will be necessary to stop a car very quickly will be merely the moving of a controller similar to that used in turning on the electric current to start the car.

A new system of electric signalling, for marine and general use, has been shown at the Royal Naval Exhibition, by Mr. C. E. Kelway. A frame-work contains fifty-four incandescent lamps in six rows of nine each, and wires connect the lamps to a keyboard like that of a typewriter. On pressing the proper key, the letter A is shown by the glowing of thirteen of the lamps arranged to form that letter. The other letters and the numerals respond in a similar manner when the corresponding keys are pressed, and messages spelled out may be read at a distance at night with great facility.

### WHAT IS A DYNAMO?

THESE are no doubt quite a few men running electric light and power machinery successfully, who are at sea as to the manner in which each part of the dynamo performs its required duty, and also the relation which one part bears to the other, and how and why it produces an electric current for either supplying electric lighting by means of the lamps, or power by means of motors. The purpose of this article, then, is to make such an explanation as it is hoped will be the means of enlightening them in this particular. For this purpose there has been selected the plain Gramme ring armature machine; by Gramme ring is meant a type or pattern of one of the original dynamos built some 12 years ago by M. Gramme, of Paris, and which consisted of two electro-magnets, whose poles or extremities face each other, and between which is revolved a ring, consisting of either fine iron wires wound around a cast iron spider or frame, or laminas (layers) of sheet iron clamped together in the same position, and bolted to the spider or frame, this ring then being wound with insulated copper wire of proper size, for the current and voltage required, in a diametrically opposite direction to that occupied by the iron wire or laminas attached to the spider. This brings us to just what that armature has to accomplish in the part it plays, it is a well known fact that when a wire is passed over the face of a magnet, that a current is produced or generated in that wire, and as the armature in the above case is nothing more or less than a succession of wires lying side by side around the entire ring, which ring is revolved between the faces of the poles of the magnet, it will readily be seen that as they pass along the face of the magnets a current is continuously produced therein, which current will flow in either a positive or negative direction, accordingly as either the positive or negative pole is being passed by the wire or wires. Every one of these wires that are passing in front of the magnet being after all only a continuous winding around the iron wire or lamina, it also follows that each one of the windings is collecting, as it were, a certain amount of current from such magnets, and as this current must have an outlet to produce a commercial product, the segments of the commutator with the brushes bearing thereon are so arranged that as these wires one after the other are about to pass out of the magnet's influence, they make contact with the proper segment and take the discharge from the wires to the line.

The fields or magnets spoken of above, are simply a mass of iron, either cast, or wrought, or laminated, wound with insulated copper wire, through which is passed continuously a small part (or all) of the current that is being generated by the armature as explained above; this then produces an electro-magnet, or in other words charges the iron of the field magnets with magnetism to saturation, or nearly so, in consequence of which we have the wires of the armature which are revolving in front of it charged with a current, as explained in the first part of this article.

The next question from one who is not posted would be, "why and wherefore does it cause a current to be generated in the ar-

mature?" to which it can be answered—simply because there is a magnetic circuit established from pole to pole through the intervening air space, which for convenience sake is called the passage of lines of force—invisible to be sure, but nevertheless known to exist—these lines always taking a direction from positive pole to negative pole, the cutting of which by the wires of the armature being then the cause of the current produced in those wires. These lines of force would take an extended rotary path, or to be more explicit, a widely separated one, were it not that the iron wire or lamina of the armature has such an attraction for them, that they are concentrated or bunched, and brought into close relation with one another, the result of which is that the copper wire of the armature has the advantage of being able to cut through nearly all of them. We say nearly all, because it is a well known fact that some dynamos are so constructed that their pole projections are so close together that there is more or less of a leakage of magnetic current from pole to pole that should and otherwise would pass through the armature and do service in increased current at the brushes. From the brushes the current passes to the line. Of course there are different windings and arrangement of armature wire than those spoken of above, but the principle governing all of them is about the same, be the dynamo an arc or an incandescent, an alternator, or a generator, be it either for 10 volts *c.* 5000, or 1-100 ampere, or 1,000 amperes.

The electric magnet spoken of above is a mass of iron around which is placed spools of insulated copper wire, and through which is passed a current of electricity, either from a dynamo or a battery, which current makes the iron magnetic, but only as long as there is current passing through the wire; the moment the circuit is discontinued the magnetism in the wire ceases, hence the name electro-magnet, meaning a magnet produced by an electric current only.

The poles of a magnet is that part of the iron whose ends project through the spools of copper wire, so that some dynamos have two poles, others more, and as in the case of alternating current dynamos, some have quite a number, they being then known as multipolar (many poles) machines.

The commutator of a dynamo is that part of a machine on which the brushes bear for the purpose of collecting the current, and is, as in the above dynamo, composed of flat pieces of copper known as segments, which are built together in the form of a drum, and are clamped closely together around the shaft of the machine, being well insulated between each piece or segment by a layer of mica or some other non-conductor.

### PERSONAL.

Mr. James Baird has been appointed engineer of the new water works plant at Woodstock, Ont.

The death of Mr. Geo. Worthington, founder of the *New York Electrical Review*, to whose instrumentality was largely due the founding of the National Electric Light Association and the New York Electric Club, caused a widespread feeling of regret in electrical and journalistic circles.

## G. W. HENDERSON



### ELECTRICAL SUPPLIES

ESTIMATES FURNISHED FOR

Lighting, Power and General . . .  
Electrical Construction.

CANADIAN AGENT FOR

THE ECONOMIC

ELECTRIC

MFG. CO.

BOSTON.

251 ST. JAMES STREET,  
MONTREAL.

Please mention the ELECTRICAL NEWS when corresponding with advertisers.



AMERICAN IMPROVED

## ANTI-FRICTION METAL

The best metal for journal bearings of any kind, but

*Especially Adapted to High Speed Engines*

This metal is warranted not to heat or cut the journals, and its lasting qualities make it superior to any other metal.

**IT IS** *self-lubricating,*  
*tougher and more durable than all other metals.*  
*the best metal known where great pressure is required.*

It runs with less friction than any other metal.

It will stand the highest rate of speed and will not heat or cut.

SOLE AGENTS FOR CANADA:

**DRUMMOND, McCALL & Co. - MONTREAL.**

**SPARKS.**

At Perth, Ont., a scheme is on foot to build an electric railway between Perth and Lanark, outside parties to furnish capital and own the road.

The promoters of the proposed electric railway between Hamilton and Grimsby will take no steps towards building the road until the city council of Hamilton grants their application for permission to use the streets.

With the aid of electric snow sweepers the management of the Ottawa Electric Street Railway have succeeded in keeping the road in excellent working order, and more than this, the streets traversed by the road are said to be in good condition for sleighing.

A Ball plant has lately been installed in Weller Bros. furniture factory, Victoria, B. C. It consists of a Ball dynamo, wound for a low-tension circuit to carry fifty 16-c. p. incandescent lamps, switch boards, rheostats, meters, etc. Power for the dynamo will be supplied by the engine which operates the factory.

The courts have decided to suspend until April further proceedings in the case of Leonard vs. the Royal Electric Company, which is an action to recover \$8,000 as the price of machinery furnished the defendant to establish its system in Three Rivers. This is to allow of action being taken by the defendant against the city of Three Rivers, which refused to accept the machinery.

Messrs. Drake, Jackson and Helweken, and Mr. John Campbell, are applying to the Legislature of British Columbia on behalf of two distinct companies for incorporation for the privilege of building and operating tramway lines between and within the cities of Vancouver and New Westminster. The company which Mr. Campbell represents also proposes erecting and operating a telephone and telegraph system in each of the cities mentioned.

**THERE IS BUT ONE PORTLAND**

Oregon, and it is best reached via Chicago and St. Paul over the through Sleeping Car Line of the Chicago, Milwaukee & St. Paul and Northern Pacific Railways. For further information apply to the nearest ticket agent or address, A. J. Taylor, Canadian Pass. Agent, 4 Palmer House Block, Toronto, Ont.

The example set by the Plymouth Chamber of Commerce has now been followed by the Halifax and Bedford Chambers, who have proposed resolutions calling upon the government to buy up the telephones of the country.

The proposition is being made to construct an electric railway from St. Petersburg to Archangel, a well known port on the White Sea, and a distance of 800 kilometres, or 500 miles. The electric current is to be supplied by a series of generating stations, placed at intervals along the entire route. If 500 miles can be covered, why not 1,000 miles, or even across our own continent? Such will be the result before many years.

Two Edison phonographs have been placed in the Department of the Interior at Ottawa, and are being used there with great success for corresponding purposes. The letters are dictated into cylinders on the machine in the deputy's room and are reproduced on another phonograph in the correspondence room and typewritten. The transcripts can be verified, as the cylinders can be reproduced as often as may be desired. When the work of transcription is completed, the cylinders are pared off and are ready for use again.

**F. E. Dixon & Co.**

MANUFACTURERS OF

**LEATHER BELTING**

70 KING STREET EAST, TORONTO.

HEADQUARTERS FOR

**ELECTRIC LIGHT AND DYNAMO BELTING.**

We have the following Leather Belts in use in the works of the Toronto Electric Light Co. :-

- One 36 inch belt 98 feet long.
- One 36 inch belt 100 feet long.
- One 36 inch belt 123 feet long.
- One 38 inch belt 100 feet long.
- One 24 inch belt 100 feet long.

And over 1500 feet of 8 inch belting.

All of the above belts are DOUBLE THICKNESS. The 38 inch belt is the largest belt ever made in this Province.

We are prepared to furnish belts of any size, two or three ply, up to 48 inches wide. Every belt fully guaranteed.

SEND FOR DISCOUNTS.

Dixon's Belting Hand-Book mailed free on application.



**SPECIAL PULLEYS**

ANY DESIGN OR SIZE

**FOR ELECTRICAL PURPOSES**

Our Pulley is now in use in MOST PROMINENT STATIONS throughout United States and Canada.

SEND FOR ESTIMATES.

**DODGE WOOD SPLIT PULLEY CO.,**

Office, 83 King Street West, TORONTO, ONT.

**FIRSTBROOK BROS.**  
 King St. East, - TORONTO.  
 MANUFACTURERS OF  
**Toppins,**  
**Side-Blocks**  
 —AND—  
**Cross-Arms**  
 WRITE FOR PRICES.

Please mention the ELECTRICAL NEWS when corresponding with advertisers

SUBSCRIBED CAPITAL, \$100,100.  
 AMOUNT ON DEPOSIT WITH THE GOVERNMENT OF CANADA, \$54,724.  
 SIR ALEX. CAMPBELL, K.C.M.G. PRES. (Lieut. Gov. of Ontario)  
 JOHN L. BLAIRIE, ESQ. VICE PRES.

# THE BOILER INSPECTION and Insurance Company of Canada

JAMES-TORONTO  
**CONSULTING ENGINEERS.**  
 G.C. ROBB, Chief Engineer. A. FRASER, Secy. Treas.  
 HEAD OFFICE, 2 TORONTO ST. TORONTO.  
 Prevention of Accident our chief aim. Economy of fuel secured.  
 NOTE—The offices of the Company have been removed from above address to the Canada Life Building

## Lamkin's Patent PIPE AND BOILER COVERING

SAVES 1000 POUNDS OF COAL EVERY TWENTY-FOUR HOURS.  
 WHAT IT DOES FOR OTHERS IT WILL DO FOR YOU.

GAST & CO., Toronto, Ont. Windsor, Ont., Dec. 31st, 1889.  
 Gentlemen: In reply to your request for my opinion respecting Boiler Covering, I consider your covering good. You have done us a first-class job, and it saves us ten hundred pounds (1,000) of coal every twenty-four hours.  
 Yours respectfully,  
 JOSEPH HALL, Supt.  
 Windsor Water Works.

**GAST & CO.,** Manufacturers, - 30 ADELAIDE ST. WEST, TORONTO, ONT.



### COPPERINE

Superintendent's Office, Water Works Dept.  
 TORONTO, January 6th, 1891.  
 ALONZO W. SPOONER, Esq.,  
 Port Hope, Ont.

DEAR SIR: I am pleased to say that after nearly three years constant use day and night, on our largest engine your Copperine has stood its work well. I have not had to renew any of the heavy bearings yet, so I consider that speaks for itself. I am pleased to recommend it to any one in need of metal to stand heavy work.  
 I am, yours truly,  
 J. C. FERGUSON,  
 Chief Engineer Toronto Water Works



THE BROOKS MANUFACTURING CO., LTD.,  
 MANUFACTURERS OF

## CARBON POINTS FOR ALL SYSTEMS OF ARC LIGHT, PETERBOROUGH, ONT.

## Earle's Air and Steam Injectors

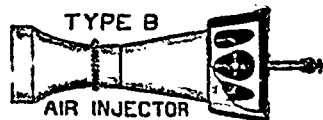
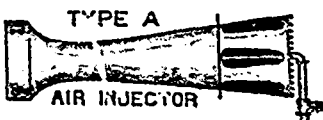
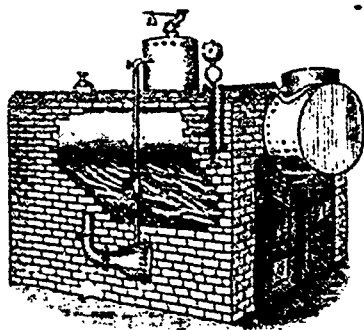

For burning hard or soft coal screenings under steam boilers, for working gas producers, &c., &c., exhausting gases from mines, ventilating ships, buildings, &c. Can be applied to any boiler without disturbing the present setting. Guaranteed to do the work satisfactorily. Can give the best of testimonials showing their efficiency. Fully covered by letters patent in Canada and the United States.

Testimonial from the Wilson Publishing Company,

TORONTO, CAN., Nov. 4th, 1891.  
 DEAR SIR,—Please find enclosed herewith cheque for the combined Air Injector and Exhauster purchased from you. I am very much pleased with your invention, we have used other air injectors, also a fan for burning hard and soft coal screenings under our steam boilers, and prefer your device to any of them. It requires less steam and makes less noise in operation. My engineer uses it in the morning to start the fire with less than five pounds of steam shown on the steam gauge. This, together with the fact that it is independent of the engine and machinery and can be operated to its full capacity without running either, gives it a decided advantage over fans. I can safely recommend it to any one requiring a first-class blower.

S. R. EARLE, Esq., Belleville, Ont. Yours truly, (Sgd) S. FRANK WILSON.

CIRCULARS AND PRICES GIVEN ON APPLICATION.

**S. R. EARLE,**

**BELLEVILLE, ONT.**