

*Canadian Westinghouse
Company, Limited
Hamilton, Ontario*

December, 1908

Circular No. 1118

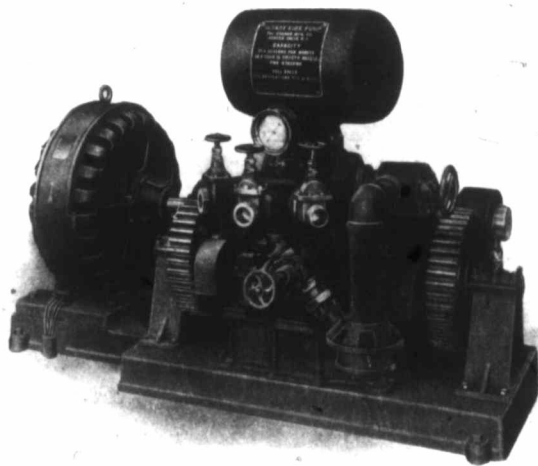

WESTINGHOUSE TYPE CCL MOTOR GEARED TO ROTARY FIRE PUMP

Type CCL Polyphase Induction Motors

Squirrel Cage Rotors—Constant Speed

INTRODUCTION

Like all other great modern industries the science of building electric motors has been a growth, and it would be folly to assert that no further improvements can be made. When the first crude device was made to move by the agency of electricity no one dreamed that electric motors would one day be produced in such perfection and in such vast numbers as at the present time. Their economical performance, ease of control, convenience, and cleanliness are chief among the reasons for their extensive adoption for all kinds of industrial operations.

So great is the variety of electric motors now available, that the problem of making the best selection for any given service often presents serious difficulties. This circular is issued with a view of giving in the least possible space an accurate idea of the merits of Westinghouse polyphase induction motors of the squirrel cage type. In publishing it, the aim has been to present clearly and concisely the essential facts regarding each separate part, as well as the operating characteristics of the complete motors, without giving confusing and unimportant details.

For information regarding other Westinghouse alternating current motors see the following publications, any of which will be supplied on request:

Type DA small motors.....	Circular No. 1128
Type A single-phase motors.....	" " 1153
Type HF polyphase (slip ring) motors.....	" " 1152

For ratings and dimensions, see descriptive and dimension leaflets.

Type CCL Polyphase Induction Motors

Squirrel Cage Rotors—Constant Speed

Polyphase induction motors of the squirrel cage type offer advantages for many installations superior to those of any other type of motor. The absence of sliding contacts makes possible extremely simple construction, with no wearing parts except the bearings. Absolute freedom from sparking is assured; these motors can be used with perfect safety in locations surrounded by inflammable or explosive material. The line connections are made to the stationary element when the motor is installed, and no further connections are necessary. The rotating element is practically indestructible. Simplicity of construction and operation, and low cost for attendance and maintenance are among the marked advantages of this type of motor.

Having been a pioneer in the field of alternating current motor production, and since the installation of the first motor a leader in promoting their use, the Westinghouse Company is especially qualified to produce thoroughly reliable polyphase induction motors. The Westinghouse type CCL motor possesses all the advantages inherent in this type. It is characterized by great strength of parts, large self-oiling bearings that seldom require attention, high starting and pull-out torque, large overload capacity, low operating temperature, practically constant speed, and high efficiency and power factor.

Ratings. Type CCL motors are built in all commercial sizes from one-half horse-power up to several thousand horse-power. Standard sizes for slow and moderate speeds on two and three-phase circuits are as follows:

From $\frac{1}{2}$ to 200 horse-power, inclusive, 25 and 60 cycles.

From 1 to 75 horse-power, inclusive, 40 cycles.

Standard CCL motor frames are numbered consecutively according to size from 1 to 16. The same general characteristics and the same general form of construction follow through the whole line.

Voltages. The smaller sizes are built for 100, 200, 400, and 550 volts; motors of 30 horse-power and larger are built also for 1000-1100 and 2000-2200 volts.

Complete rating and dimension leaflets for any of the foregoing standard frequencies will be supplied on request.

Modifications. A type CCL motor can drive its load through a belt or gear or can be direct connected. The motor can be arranged for operation

with a horizontal or a vertical shaft. The horizontal shaft motor can be equipped with back gears and a countershaft. Each of these modifications is more fully described on other pages of this circular.

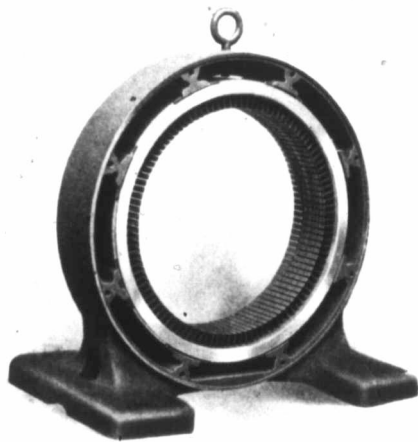

Stator Core of Type CCL Motor

Mechanical Features

The following description of the construction of a CCL motor applies in general to the whole line. A few exceptions to the general rule, most of which are herein noted, are made for some sizes. As shown by the illustrations, the general outline is graceful and attractive, the frame and bearing brackets are so formed as to protect all the delicate parts and at the same time allow ample ventilation.

An induction motor consists of two essential parts, the stationary part, or stator, often called the primary, and the rotating part, or rotor, often called the secondary. In a CCL motor the stator, or stationary primary, consists of a frame with two removable bearing brackets and bearings, and a core which carries the windings. The rotor, or rotating secondary, consists of a core with conductors, a spider, and shaft. The following descriptions of the parts will be better understood by reference to the accompanying illustrations.

Frame. The frame consists of a cylindrical cast iron ring having substantial supporting feet. Inside this ring are several lugs that support the stator core far enough from the frame to allow a good ventilating space between the frame and the core. The ends of the lugs and the frame are machined to receive the bearing brackets.

Bearing Brackets. Cast iron bearing brackets of the ventilated type are bolted to the ends of the frame in such a way that the brackets can be rotated through any 90-degree angle. This feature permits mounting the motor on the floor, wall, or ceiling.

The brackets of motors using frames larger than No. 5 (5 h.p. standard speed) are divided horizontally through the center line of the shaft, and the

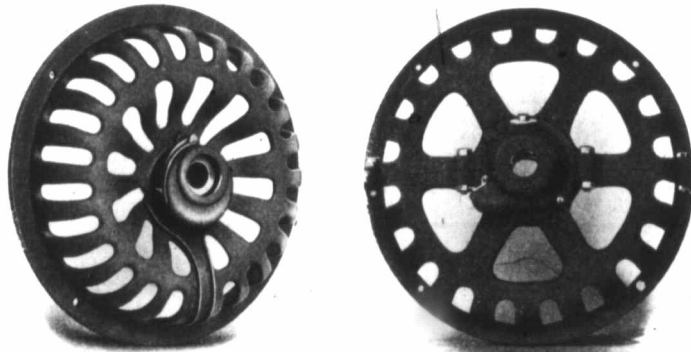

SOLID AND SPLIT BEARING BRACKETS

bearing housing is clamped between the two halves. This construction enables the removal of one-half of the bracket for inspecting the interior of the motor or removing the bearing. On frame No. 5 and smaller, each bearing bracket is in one piece.

Stator Core. The core of the primary, or stator, is built up of circular sheet steel laminations punched from thin plates. These punchings are assembled, clamped, and keyed between end rings inside the lugs on the frame. Dovetails or keys in one or more of the lugs prevent all circular movement of the laminations. The core is slotted on the inside to receive the stator windings; these slots are in most cases partially closed.

Stator Windings. The stator windings generally consist of coils of insulated wire wound on forms and temporarily fastened together by bands of tape. Before placing the coils in the slots, each slot is lined with a cell of insulating material, and the coils are then inserted by pushing a few wires at a time through the narrow openings. All the wires being in place, the cells are folded over, and fibre wedges are driven under the overhanging tips of the teeth so as to hold the windings securely in place. For some of the larger sizes copper strap or bar is used instead of wire, and for most of the high voltage motors formed coils are laid in open slots.

Rotor Core. The rotor core is also built up of circular sheet steel laminations assembled, clamped, and keyed between stiff end plates on the arms of the rotor spider. Partially closed slots are provided for the windings. The spider is pressed on to the shaft and keyed.

Rotor Windings. The rotor windings of all except the smallest frame



Stator With Windings in Place

currents of air between the rotor end rings and the core, and through all the openings in and around the stator windings and core, thus keeping all these parts cool. The direction of the air currents is such as to expel dust and other foreign matter from the motor, thus protecting the insulation and generally safeguarding the machine.

Clearance. The clearance between the rotor and stator is as large as is compatible with good operating characteristics. A reasonable clearance is essential, otherwise the least wear on the bearings will allow the rotor and stator to rub. On the other hand, a large clearance has a detrimental effect on the power factor and efficiency. In the Westinghouse type CCL motors good power factors and efficiencies are obtained without sacrificing the mechanical advantages of a safe clearance. The use of partially closed slots in the stator and rotor greatly reduces the electrical air gap, while allowing a larger mechanical clearance for a given effect on the operating characteristics than is possible with open slots.

consist of insulated copper bars, both ends of which are securely fastened to cast metal end rings by copper plated iron machine screws. The windings of the smallest size consist of insulated round copper rods riveted to the core end plates, which are also of copper. In all sizes the windings have the general form of the wheel of a squirrel cage, from whence comes the name "squirrel cage windings."

Ventilation. On the end plates of the rotor cores of all frames larger than No. 5, are vanes, or blades. When the motor is in operation, these blades drive powerful

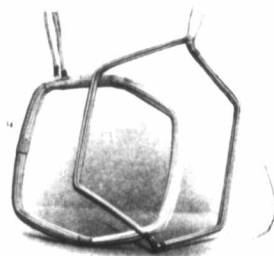

Stator Coils

Shaft. The size of shaft necessary for a given motor depends on the weight of the rotating element and on the distance between bearings. The rotor of a type CCL motor contains no useless material to add to its weight, and the distance between bearings is small. At the same time the shaft is unusually large and stiff, so that there is no appreciable bending at any load within the capacity of the motor. This is an important feature, since with the comparatively small clearance necessary in induction motors, the shafts must be absolutely rigid.

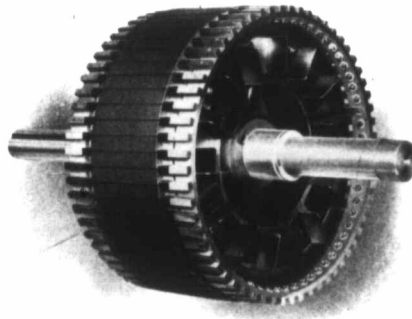

Rotor Complete With Winding

Oil thrower rings on the shaft intercept and return to the bearings all oil creeping toward the interior of the motor.

Bearings. The only wearing parts of a squirrel cage induction motor are the bearings, and experience has shown that the bearings of type CCL motors are capable of withstanding long and severe service without attention other than occasionally filling with oil.

These bearings are liberally proportioned and of the self-oiling form. Frames having split bearing brackets (larger than No. 5, standard 5 h.p.) also have split bearings. The interior of the housing forms the bearing shell, which, after being machined, is lined with the best grade of bearing metal. This design renders the bearing capable of withstanding the most severe

service, and also facilitates repairs, which may be made in any machine shop.

In assembling the motor, each half of the bearing housing is permanently attached to its part of the bearing bracket, and the two halves are held in perfect alignment by dowel pins.

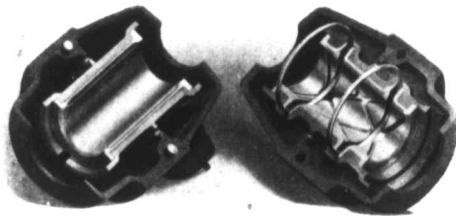

Bearing Housing Open—Showing Linings and Oil Rings

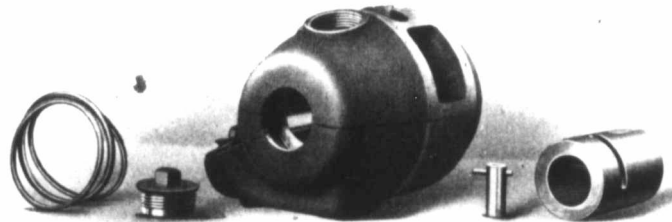

Oil Rings Oil Plug Split Bearing Steady Pin Solid Bearing

TYPE CCL MOTOR BEARINGS AND PARTS

Suitable recesses in the outside of the bearing housing receive portions of the bearing brackets, so that when the two halves of the bracket are clamped together, the bearings are held secure.

Motors with solid bearing brackets (No. 5 frame and smaller) have bronze bearing bushings. The bearing housing is a part of the bracket, and the bushing is pressed into the housing and held by a steady pin.

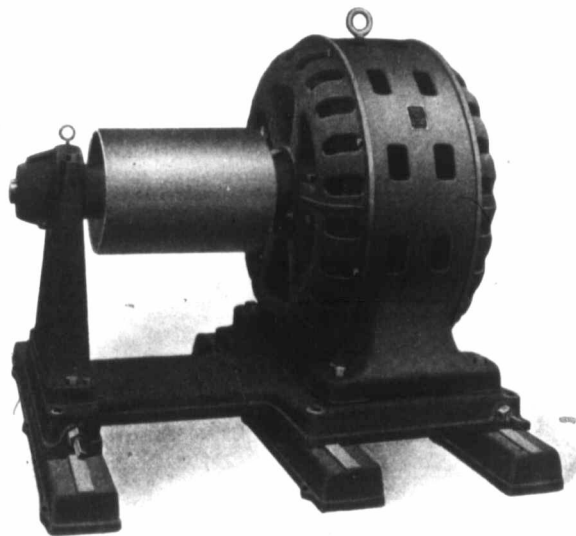

THREE BEARING TYPE CCL MOTOR

Lubrication. Each split bearing has two oil rings and each solid bearing one. The lower part of the housing forms an oil well from which the oil is carried by the rings to the top of the shaft, whence it is distributed through grooves in the lining to all parts of the bearing. While the motor is operating, the bearing is thus kept flooded with oil.

The oil well can be filled through a covered opening in the side of the housing. The lower edge of this opening is low enough to prevent filling the bearing too full. A split bearing has a threaded hole and an oil plug in the outer end of the upper bearing housing. By removing the plug the bearing can be inspected, and oil poured directly on to the shaft. On the smaller motors the opening in the side of the bearing answers the same purpose.

Outboard Bearing. When a large CCL motor is geared or when it drives by chain, an extended shaft and an extra pedestal type bearing is supplied. The pedestal can be mounted on the driven machine, and the motor bearing is thereby relieved from excessive stress. Each large belted motor also usually has an extra bearing mounted outside the pulley on an extension of the bedplate.

Pulleys. Paper pulleys are supplied with CCL motors using frames not larger than No. 13 (standard 75 h.p.), and iron pulleys with larger sizes. Paper pulleys, having a better adhering surface than iron pulleys, permit the use of smaller diameters and relatively lower belt speeds for given motor speeds, making paper pulleys often of considerable advantage with the smaller motors.

Bedplates. Cast iron bedplates for floor mounting with screws for adjusting the belt tension are regularly supplied with all sizes of CCL motors. Floor mounting bedplates for frames No. 6 to

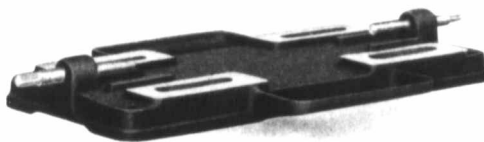

Bedplate for Floor Mounting

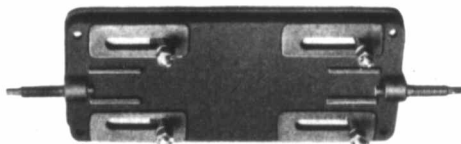

Bedplate for Ceiling Mounting

No. 13, inclusive, have extensions under the bearings to catch any dripping oil. Motor frames up to and including No. 5 have slotted feet permitting slight movement for adjusting the belt tension, so that these motors can be mounted without bedplates, if desired.

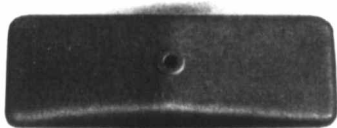

Oil Drip Pan

For wall or ceiling mounting the bedplate is slightly modified, and with frames larger than No. 5 oil drip pans are supplied.

Terminals. The only terminal leads from a CCL motor are those from the stator winding. These are brought out at one side of the motor and held in terminal cleats.

Connectors. The ends of the motor terminals are supplied with two-piece break-joint connectors. One half of the connector is soldered to the motor terminal and the other half can be soldered to the corresponding lead from the motor starter. These connectors interlock in a simple manner and when locked make a very secure connection of ample carrying capacity. By their use connections can be quickly made or broken without the use of tools.

Interchangeability of Parts. Under normal conditions, repairs for type CCL motors will seldom be needed. All parts are, however made with special jigs, dies, and templates, so that new parts can be ordered and substituted for broken or damaged parts with the least possible delay and expense. Corresponding parts on motors of the same size can also be interchanged. In any CCL motor the two bearing brackets and the two bearings are interchangeable.

Inspection and Tests. All material entering into a CCL motor is subjected to a close inspection and in many cases to rigid tests; material not of a fixed high grade is rejected. During the process of manufacture frequent inspections and tests of partially completed

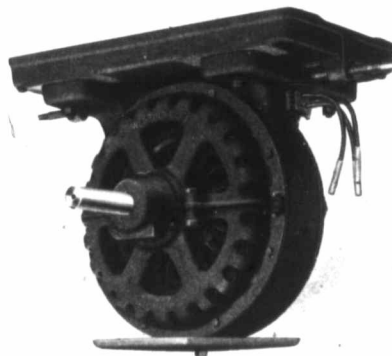

Type CCL Motor Arranged for Ceiling Suspension

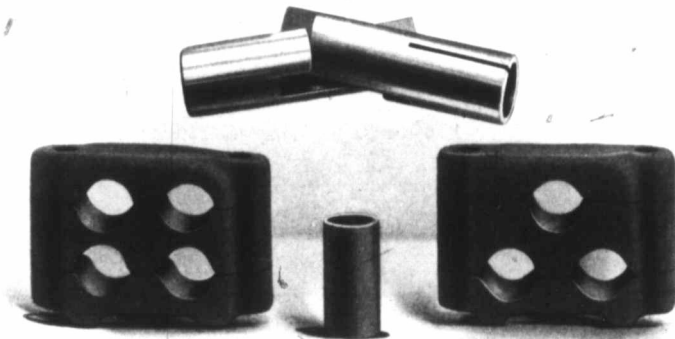

Interlocking Connectors
Two-Phase Terminal Cleats Three-Phase Terminal Cleats
Terminal Insulating Tube

parts are made, and after assembling the motors thorough tests are made to see that they fulfill all specifications. Every effort is made to insure the use of none but high grade materials and workmanship.

Finish. After the final tests have been made, all external surfaces, including the motor frame, bearing brackets, bedplate, etc., are covered with a brush filler, thoroughly rubbed, and then painted with a preparation that leaves a smooth, dull, gray-black finish. This finish has been found by long experience to be most suitable for general requirements; it also furnishes an excellent foundation for any desired color coat.

Mechanical Modifications

Vertical Motors

In order to supply a convenient method of driving certain types of machines, such as vertical shaft centrifugal pumps, a modified form of the

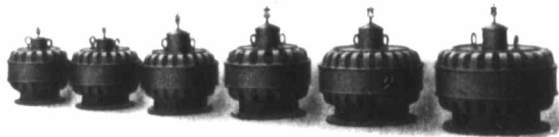

VERTICAL TYPE CCL MOTORS

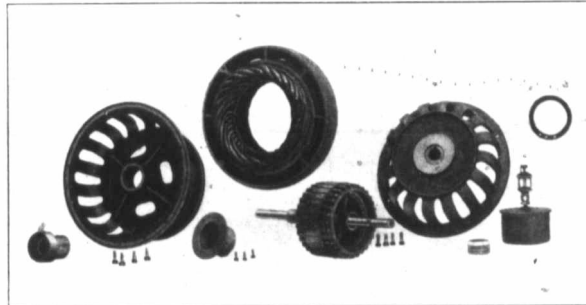

CCL NO. 3, THREE-PHASE, 60 CYCLE, VERTICAL MOTOR - COMPLETE PARTS

type CCL motor is arranged for operation with the shaft vertical. The electrical design and characteristics are identical with those of the horizontal form. The special mechanical features are as follows:

Frame. The frame is a cylindrical casting without supporting feet.

Bearing Brackets. Each bearing bracket has ventilating openings near its outer edge as on a horizontal motor. The upper bracket has a solid central section to prevent the entrance of foreign substances. This bracket carries the thrust bearing and a guide bearing. The lower bracket is cast with a flange, or base, for supporting the motor, and with ventilating openings in the central portion. This bracket also carries a guide bearing.

Bearings. The ball thrust bearing carried by the upper bracket is capable of carrying something additional to the weight of the rotor, the exact amount of the excess weight depending on the size and speed of the motor. The weight is supported by balls rolling in a raceway between hardened steel discs and spaced by a suitable brass cage. Attached to the upper end of the

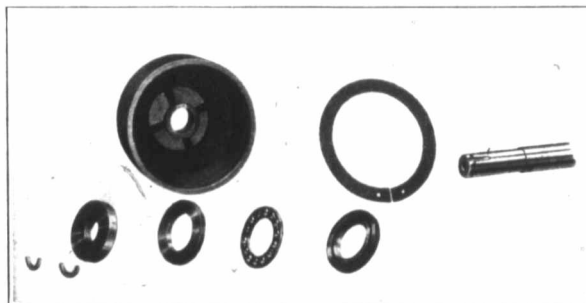

CCL VERTICAL TYPE MOTOR THRUST BEARING PARTS

shaft is a thick steel washer by means of which the weight of the rotor is transferred to the thrust bearing. The bearing is enclosed in a cup, or bearing pot.

Lubrication. The balls of the thrust bearing are immersed in oil. The cap over the top of the bearing pot carries a sight feed oil cup from which oil drops into a hole in the end of the shaft and is led to the upper guide bearing. After lubricating the upper bearing the oil flows into a receiving chamber,

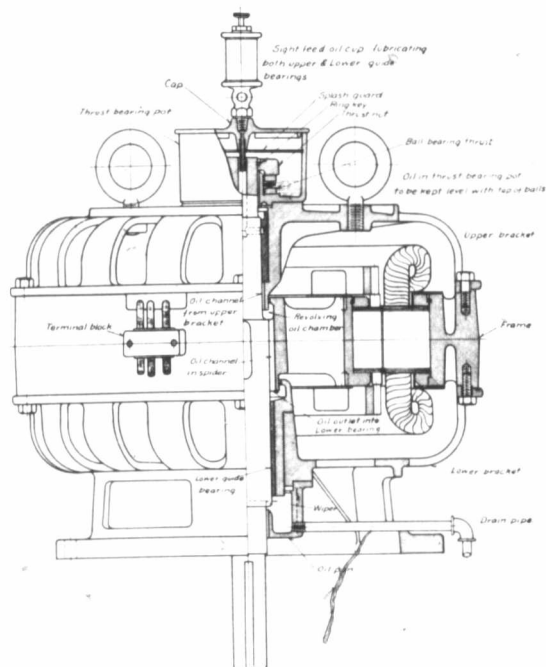

VERTICAL TYPE CCL MOTOR. SHOWING METHOD OF LUBRICATION

from which it follows a channel through the spider to the lower guide bearing. After being used in the lower bearing the oil gathers in an oil pan from which it is drawn by a drain pipe.

Driving Connection. The shaft extends below the lower guide bearing for belting, gearing or direct connecting to the load. Any of these methods of driving can be used with frames up to No. 8 (standard 15 h.p.), but larger motors are designed for direct connection only. Pulleys or pinions can, however, be used with the larger frames by placing an additional bearing

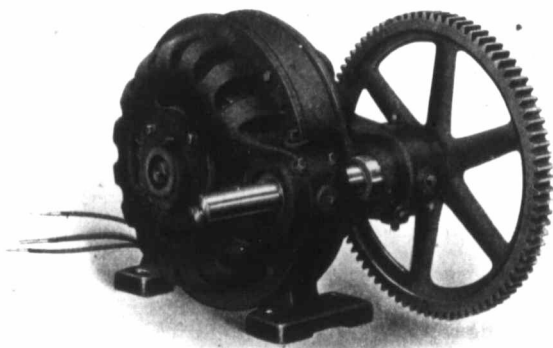

Back Geared Type CCL Motor—Driving End of Countershaft

gears and countershafts. The mechanical features and operating characteristics are the same as the standard horizontal shaft motors with the following exceptions:

Bearing Brackets. The bearing brackets are special and are cast with extensions for supporting the countershaft bearings. Dowel pins, in addition

below. No pulleys, pinions, or couplings are supplied with vertical shaft motors, except on order.

Back Geared Motors

To provide for very low driving speeds without using excessively large and expensive motor frames, all type CCL motor frames can be arranged with back



BACK GEARED TYPE CCL MOTOR—PINION END

to the regular bracket holding bolts, prevent movement of the bearing brackets relative to the frame. Each bracket for frame No. 6 (standard $7\frac{1}{2}$ h.p.) and smaller is cast in one piece, but for larger frames each bracket is split in a plane through the center of the shaft. The brackets can be rotated to bring the countershaft above or below or on either side of the motor. It necessarily follows that the motor can be mounted on the floor, wall or ceiling. The two brackets of a motor are interchangeable.

Shafts, Pinions, and Gears. The rotor shaft is standard and is regularly fitted with a steel pinion. The countershaft has ample strength and carries a cast iron gear wheel. Unless otherwise ordered, the pinion and gear will be supplied to give a speed reduction of approximately 5 to 1, but to meet special service conditions these parts can be supplied for other speed reductions. Rawhide pinions are recommended for pitch line speeds of 1200 feet per minute or more. The driving end of the countershaft is fitted with a keyway for holding the driving pulley or pinion.

Rawhide pinions, gear cases, and pulleys or pinions for the driving end of the countershaft are supplied only on special order.

Bearings. On back geared motors with split bearing brackets (frames larger than No. 6) the rotor bearings are the same as those of standard motors without back gears; the smaller motors with solid brackets have separate housings for the rotor bearings, bolted centrally in the brackets. The countershaft bearings of all sizes are brass sleeves pressed into the housings and each held in position by two bolts. These brass sleeves are provided with oil rings and the housings contain oil wells. Tap plugs are provided for inspecting, filling, and draining the countershaft bearings.

In changing the position of the countershaft relative to the motor frame, each rotor bearing housing and each counter shaft bearing sleeve can be rotated through the angle necessary to keep the oil rings riding on the shaft.

Outboard Bearings. When specially ordered, outboard bearings can be supplied for the rotor shafts of the four largest frames and for the counter-

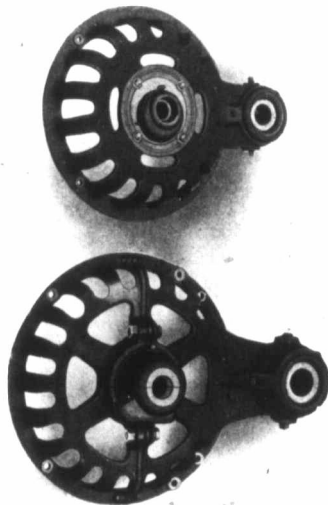

Solid and Split Bearing Brackets for Back Geared Motors

shafts of all sizes. These outboard bearings are carried in pedestals which can be mounted on the frame of the driven machine.

Outboard rotor bearings are especially recommended for the large frames where service conditions are severe. Outboard countershaft bearings are recommended in all cases where the countershaft drives through a pinion or gear, and for belt drive from frames larger than No. 9 (standard 20 h.p.).

Mounting. Back geared motors are usually mounted on the frames or extended bedplates of the driven machines, hence motor bedplates are not supplied except on order. Frames not larger than No. 5 can be bolted directly to a wall or ceiling; larger sizes can be supplied with suspension bedplates, and oil drip pans for wall or ceiling mounting.

Operating Characteristics

Squirrel cage induction motors are essentially constant speed machines. At no load, that is, running light, the speed is synchronous, depending on the frequency of the supply of the current and the number of poles for which the motor stator is wound. When the motor is driving a load the speed is less than synchronous, the decrease from synchronous speed being known as the slip. The slip of any induction motor varies with the load and depends on the resistance of the secondary, that is, of the rotor conductors and their short-circuiting end rings. The greater the load the greater the slip, and the higher the resistance of the secondary the greater is the slip at any given load. The slip is usually expressed in per cent. of synchronous speed; thus, 5 per cent. slip means that the speed is 5 per cent. less than synchronous speed.

The greater the slip of an induction motor the greater is the starting torque, or turning moment, per unit current. On the other hand, large slip is accompanied by increased losses and decreased efficiency. In the type CCL motors a conservative medium course has been adopted. The slip is high enough to give good starting torque without requiring excessive starting current, while at the same time good commercial efficiencies are obtained. The slip at full load varies with the size of the motors between the approximate limits, 7 per cent. in the smallest size down to 3 per cent. in the larger sizes.

Torque. The starting torque per ampere current input compares very favorably with that of any other squirrel cage induction motor on the market. The maximum running torque, or the pull-out torque, is from two to two and three-fourths times the full load torque. Type CCL motors are therefore especially adapted for service where they may be subjected to sudden and heavy overloads.

Efficiencies. The efficiency of any motor, or the ratio of the output to the input, varies with the load. For most economical operation this variation should be as little as possible over the working range of the load. The efficiency of a type CCL motor is very nearly constant at all loads from one-half load to one and one-fourth load, the maximum being attained at some point between three-fourths load and full load. Since motors usually operate at loads between the limits indicated, it will be seen that type CCL motors meet the conditions for most economical operation.

Temperature and Overload. Especial attention is called to the low temperature rises and large overload capacities of type CCL motors, as these features are better than are usually offered. At rated voltage and frequency the following temperature rises above the surrounding atmosphere can be guaranteed, all temperatures to be measured by thermometer.

Full load continuously.....	40° C.
Twenty-five per cent. overload continuously.....	50° C.
One hour at fifty per cent. overload.....	60° C.

Change of Voltage and Frequency. Type CCL motors will operate successfully on circuits of which the voltage is within ten per cent. of that at which the motors are rated. They will also operate successfully at some variation from normal frequency. For example, the 60-cycle motors can be operated at 66 $\frac{2}{3}$ cycles or at 50 cycles.

When an induction motor is operated at full rated output on a frequency other than normal, the voltage should also be varied proportionally to the square root of the change of frequency in order to keep approximately normal performance. For example, if a 60-cycle, 400-volt motor is to be operated on 50 cycles, the voltage should be made $\sqrt{\frac{50}{60}} \times 400 = 365$; and if operated on 66 $\frac{2}{3}$ cycles the voltage should be about 422. The voltage and frequency should never be changed in opposite directions from normal. Any variation from normal voltage and frequency will have some effect on the operating characteristics; but with CCL motors, if the foregoing limits are not exceeded and if the variations be made according to the rule given, the operation will be satisfactory.

Westinghouse Type CCL Motor Starting Devices

When polyphase alternating current flows through the stator windings of a squirrel cage induction motor, a rotating magnetic field is set up. That is, magnetic poles are established and the position of these poles constantly advances around the inner surface of the stator at an angular velocity depending on the frequency of the current and the arrangement and connections of the stator winding.

This moving magnetism in cutting across the rotor conductors generates in them an electromotive force which causes current to flow through the conductors and their short-circuiting end rings. The reaction of this current on the magnetic field produces the torque which causes the rotation of the secondary. In other words, the rotating magnetism may be said to drag the rotor conductors, and consequently the rotor, along with it. At no load, the rotor conductors soon attain and keep practically the same speed as the rotating magnetic field, that is, the speed is nearly synchronous.

In starting an induction motor with full primary voltage, the rapid motion of the field magnetism relative to the rotor conductors causes a large current in the motor secondary and a correspondingly large primary current. This condition causes a large starting torque, varying in the type CCL motors from approximately one and one-half to two and one-fourth times the full load torque, or that necessary to give the rated output at full speed. In most applications, however, especially where motors and lamps are supplied by the same circuit or transformer, large starting currents are objectionable because of the resulting disturbance to the line voltage. For this reason it is not practical to apply

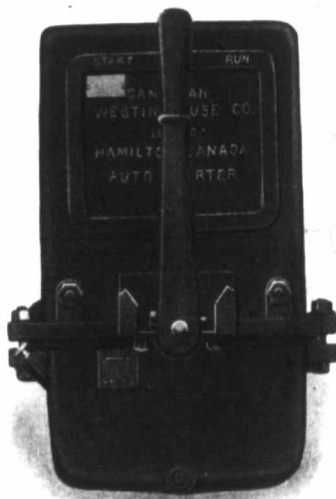

Auto-Starter—5 to 15 H.P.

full line voltage to the motor primary in starting any but small squirrel cage induction motors. An exception to this general rule may be made for motors having very high resistance secondaries with consequent low efficiencies.

Type CCL Auto-Starters

For the reasons just explained, each type CCL motor larger than five horsepower is provided with a device for reducing the voltage applied to the motor primary in starting. This device consists of two auto-transformers, and an oil-immersed switch for changing the connections, and is called an auto-starter. All the parts are enclosed in a dust-proof cast iron case.

Auto-Transformers. An auto-transformer consists of a transformer core having a single coil of wire to which both the primary and the secondary line wires are connected; any portion of the coil may constitute the primary winding of the transformer and any portion the secondary. In a CCL auto-starter on a two-phase circuit, one auto-transformer is connected to each phase; on a three-phase circuit the two coils are connected in V, or open delta. The ends of the coils are connected to their respective line wires, and by means of the switching device the terminals of each phase of the motor primary are connected between a line wire and a point on one of the auto-transformer coils. The motor primary then receives a percentage of the line voltage, depending on the selection of the connection points on the auto-transformer coils. If required by the starting conditions the selection of points and the switching device can be so made that the voltage is applied to the motor in several gradually increasing steps, constituting a multipoint auto-starter; but for most purposes two starting points are found to be sufficient.

In a CCL auto-starter the auto-transformer coils are wound of insulated wire, taped, thoroughly impregnated with insulating compound, and assembled on a laminated iron core.

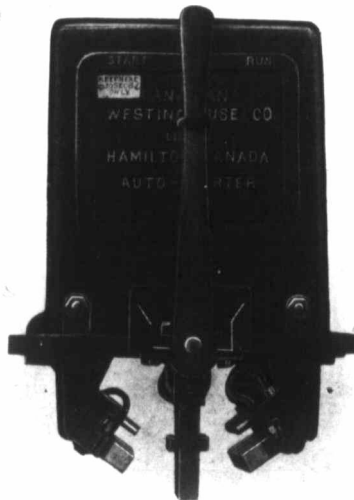

Auto-Starter—5 to 15 H.P.
Oil Tank Removed

Westinghouse two-point auto-starters are designed for the most severe service and are standard for use with all type CCL motors at all standard voltages and frequencies up to 100 horse-power, and for 60-cycle motors for 400, 550, 1000, and 2000 volts up to 200 horse-power. The auto-transformers are contained in the upper part of the cast iron case, and the switch mechanism is attached to the same part. The lower part of the case forms the oil tank in which the switch contacts are immersed. The case is provided with lugs for mounting against a wall or column.



Auto-Starter Panel

Switches. The switching device is of simple but substantial construction. It is a double throw knife switch with the addition of arcing tips to prevent burning at the switch contacts. When worn out the arcing tips can be removed with a pair of ordinary gas pliers and new ones substituted. Since the contacts are practically the only parts of the device liable to wear, and these are so simple, inexpensive, and easy installed, the cost of the repairs for these switches is almost inappreciable.

Operation. The switch is operated by means of a lever on a shaft running through the lower portion of the transformer case. This lever has three positions plainly indicated on the case; namely, "off," "starting," and "running." A locking device holds the lever securely in the off position and in the running position.

A mechanical device prevents moving the handle directly from off position to running position; it must first be moved to the starting position, the extreme left, and then moved quickly back past the off position to the running position at the extreme right. If this last movement is slow the handle will be caught and held in the off position. This feature is to prevent allowing time for the motor to slow down while passing from the starting position, where the motor receives a fraction of the full voltage, to the running position where full voltage is applied. These safety devices render the auto-starter practically fool-proof.

Connections. Each transformer coil is provided with three intermediate taps, any one of which can be selected for the starting lead. By this means

the starting voltage can be made approximately 50, 65, or 80 per cent. of the full line voltage. The standard connection is to the 65 per cent tap.

Each starter is provided with two sets of terminal leads, one for starting and one for running. If desired, fuses or circuit-breakers can be used in the running leads only, so that the circuit will not be opened while the motor is starting; or fuses or circuit-breakers can be so arranged that the starting current can exceed the running current and yet have the motor protected against an excess of either. The four starting leads, four running leads, and four motor leads make twelve leads issuing from the auto-starter.

Auto-Starter Panels

For starting large CCL motors and also for the smaller sizes where switch board type starters are preferred, auto-starter panels are used. The panel consists of a black marine finished slate slab on which is mounted an auto-starter switch. This switch is double-throw, the upward position being for starting and the downward position for running. The contacts are of the butt type and are immersed in oil. Auto-transformer coils mounted separate from the panel and connected with the line and the switch serve to reduce the starting voltage.

An overload tripping device is so arranged that, when in the running position, the auto-starter switch serves as a circuit-breaker. The overload tripping point is adjustable.

The auto-starter switch will not remain in the starting position unless held by the operator; if released it returns immediately to the off position. If inadvertently moved to the running position first, the circuit-breaker trips and prevents injury to the apparatus.

If desired, additional devices such as instruments, fuses, etc., can be mounted on the panel. A standard tubular supporting frame is supplied.

Multipoint Auto-Starters

In special cases, where CCL motors are required to start heavy inertia loads, more than two starting points may be advisable. For such cases multipoint auto-starters can be supplied. A Westinghouse

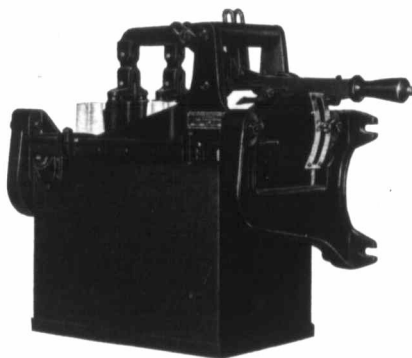

Auto-Starter Switch—Complete

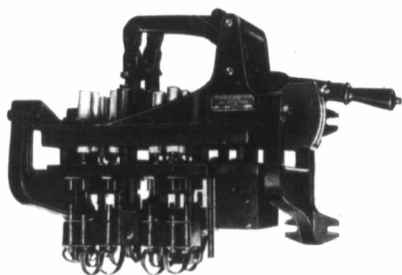

Auto-Starter Switch With Oil Tank Removed

multipoint auto-starter consists of two auto-transformers in connection with a drum type oil-immersed contact changing device. The arrangements are such that the starting points must be passed consecutively before the running point is reached, thus applying the voltage to the motor in gradually increasing steps. The contacts are made and broken under oil.

Connections. The auto-transformer coils are provided with taps to allow the starting voltages to be varied to suit the starting conditions. The auto-starter is provided with duplicate terminal leads, one set for starting and one for running, so that the fuses or circuit-breakers can be arranged to allow starting currents in excess of the running current, as explained in connection with two-point auto-starters.

Automatic Auto-Starters

For CCL motors up to 50 horse-power driving pumps or air compressors, automatic multipoint auto-starters can be supplied. These auto-starters differ from the multipoint auto-starters previously described chiefly in the method of operation. Each automatic auto-starter is equipped with an operating head which is actuated by the rise and fall of a liquid level or by the change of pressure in a closed tank system.

Float Type Auto-Starter.

The operating head of the float type auto-starter consists of a wheel and a weight on the operating lever attached to the shaft of the switch drum. A rope, moved by a float on the

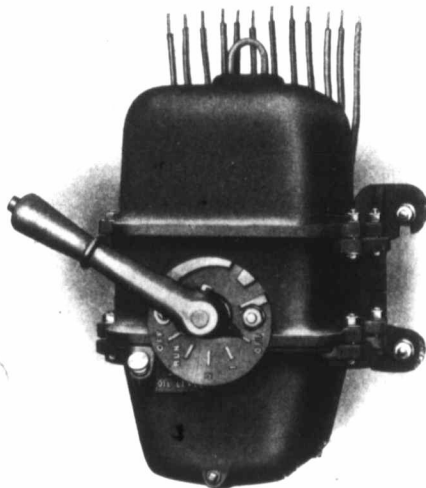

Multipoint Auto-Starter, 5-10 H.P.

surface of the liquid, rides in the grooved rim of the wheel and turns it as the liquid level falls or rises. The operating lever rides in a slot in the wheel, the slot being long enough to give the lever a movement independent of the wheel.

As the float nears the lower limit of its travel, the lever approaches a vertical position; when the lever is moved past the vertical, the weight falls and the arm, passing through the slot, is carried through the angle necessary to operate the switch. A dashpot controls the rate of motion of the weight in falling. As the pressure rises, the weight arm is again raised and forced past the vertical position, when it falls in the opposite direction and stops the motor.

The diameter of the wheel in which the rope rides is 9 $\frac{1}{4}$ inches, and the travel of the rope to operate the switch must be 12 inches. A pull of 45 pounds at the rim of the wheel is necessary.

The float mechanism is not supplied with the auto-starter. The float can be made of well seasoned wood or galvanized sheet steel properly weighted; it is placed on the surface of the liquid, and connected by levers and a rope to the auto-starter. Practical ways of making the float and connections will be suggested on request. With the request should be given information as full as possible regarding the motor characteristics or the serial number of the motor, the allowable rise and fall of liquid level, the relative locations of motor, pump, and tank, etc.

Pressure Type Auto- Starter. The operating head of a pressure type auto-starter consists of two cylinders, in one of which is a piston and in the other a dashpot and spring. The admission

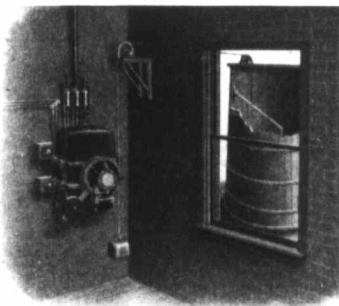

**Float Type Automatic Auto-Starter
In Service**

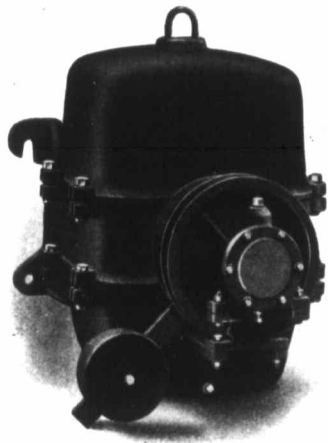

Float Type Automatic Auto-Starter

of pressure underneath the piston causes it to rise against the action of the spring and start the motor, the rate of motion of the piston being controlled by the dashpot. When pressure is removed, the spring forces the piston to the bottom, or off position, and the motor stops.

Pressure Regulator. A pressure regulator is supplied for use with the pressure type auto-starter. This regulator consists of an air chamber and a cylinder in which a piston is operated by the tank pressure to be controlled. The piston is held down by an arm carrying a weight, the position of which is adjustable along the arm. The operation of the piston valves is differential so as to compensate for friction of the moving parts. The

material under pressure can be gaseous or liquid, but should be stated when placing the order so that suitable valve packing can be provided.

The weight can be adjusted for any pressure up to 100 pounds per square inch, and the regulator will operate within 10 pounds either way from the point of adjustment.

When the pressure to be controlled falls to the lower limit, the piston of the regulator cylinder is forced down by the weight until pressure is admitted to the air chamber and the cylinder on the operating head of the auto-starter. The auto-

starter operates, the motor starts, and the pressure in the storage tank increases. At the upper limit of pressure the regulator piston rises, shuts off the connection of the operating cylinder with the tank, and opens an outlet from the operating cylinder, thus permitting the auto-starter to go to the off position and stop the motor.

By this arrangement a break in the pressure system resulting in complete loss of pressure will automatically cause the motor to stop.

Mechanical Features of Automatic Auto-Starters

In Westinghouse automatic auto-starters all bearings are bushed with brass to prevent rusting.

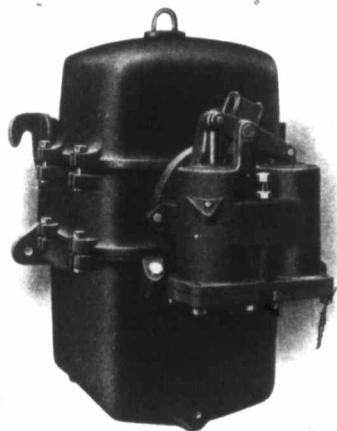

Pressure Type Automatic Auto-Starter

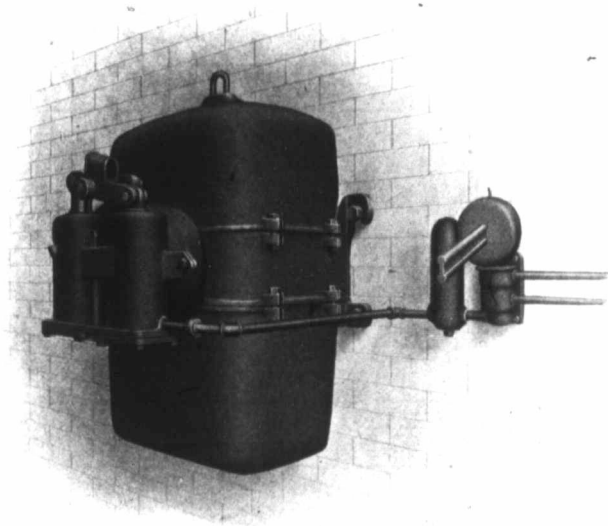

PRESSURE TYPE AUTOMATIC AUTO-STARTER IN SERVICE



UNIT SWITCH AUTO-STARTER FOR LARGE CCL MOTORS

The automatic device is entirely mechanical in operation. No magnet coils are in danger of burning out or grounding, and the operation of the starter does not depend on the line voltage.

The dashpot is filled with a mixture of glycerine and alcohol, so that freezing cannot occur under any temperature ordinarily encountered in practice.

The mechanical construction is substantial throughout, and there are no small parts to become bent or deranged.

Westinghouse Type HF Motors

For all classes of service where induction motors are required to start heavy loads frequently or to start such loads without disturbing the line voltage, Westinghouse type HF motors are recommended. These motors have wound rotors and collector rings, by means of which ohmic resistance is inserted in the rotor circuit at starting and cut out as the motor comes up to speed.

Type HF motors are constructed along the same general mechanical

lines as type CCL motors. The outside appearances of the two types are much the same, except that one bearing bracket of the type HF motors is extended to make room for the slip rings inside the bearing. Provisions are made for partially or wholly enclosing the collectors when the motors are to operate where coarse flying particles or dust might enter the collector. These motors are fully described in circular No. 1152.

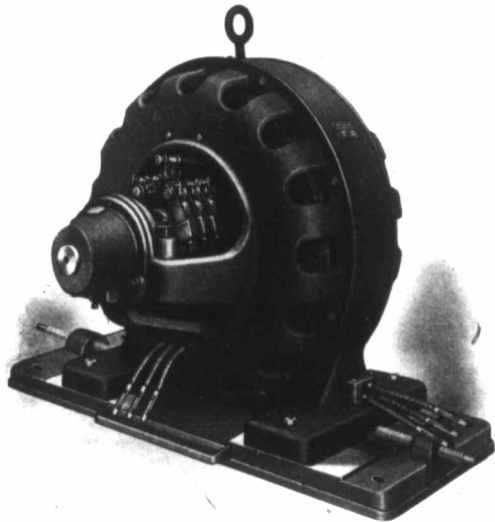

Type HF Motor (50 H.P.) With Bedplate

Type HF motors are very substantial, compact, and durable, and have excellent operating characteristics. They can be supplied for medium or high torque service. They are made for the same standard voltages as type CCL motors, and in a variety of sizes ranging from five horse-power up to several hundred horse-power. With each motor is supplied a starter consisting of a resistance and a suitable switching device, by which the resistance is cut out of the secondary circuit of the motor.

Westinghouse Polyphase Induction Motor Applications

Attention is here called to the remarks under the head "Selection of Motor Equipment" in Westinghouse circular No. 1008, describing types S and SA direct current motors. These remarks apply equally well to the selection and application of induction motors.

From what has been said in this circular (No. 1118) it is evident that for constant speed service with fairly infrequent starting or with frequent starting on circuits where close voltage regulation is not essential, no better selection of motors can be made than the Westinghouse CCL squirrel cage type; while for service frequently requiring considerable starting torque with low starting current, type HF motors are preferable. The absence of moving contacts make the operation of type CCL motors absolutely safe in the presence of the most inflammable or explosive material, while the effective way in which the type HF collectors can be closed make these motors almost equally safe.

Both types of motors have had a wide range of application in almost every industry. A number of typical applications of type CCL motors and a few of type HF motors are shown herewith. These illustrations are merely suggestive of the possibilities along several lines. Illustrations of other applications to machines in any line of industry will be sent on request.



Type CCL Motors Driving Surfacers and Grindstone

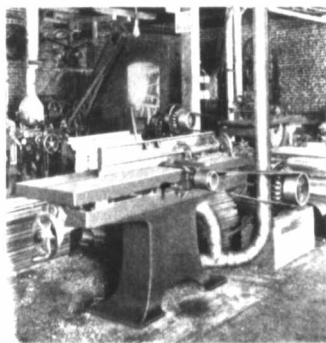

Type CCL Motor Belted to Jointer

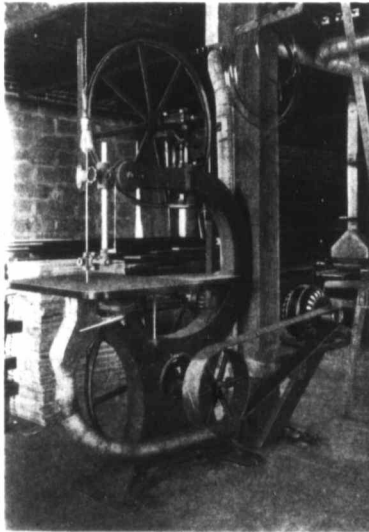

Type CCL Motor Belted to Band Saw

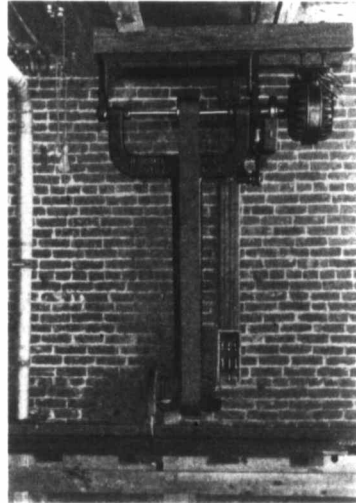

Type CCL Motor Belted to Swing
Cut-Off Saw



Type CCL Motor Belted to Pony
Planer

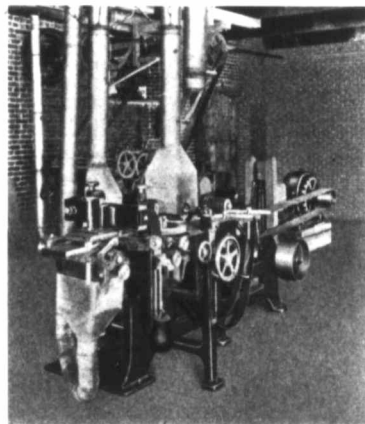

Type CCL Motor Belted to Moulder



Type CCL Motor Belted to Tenoning Machine

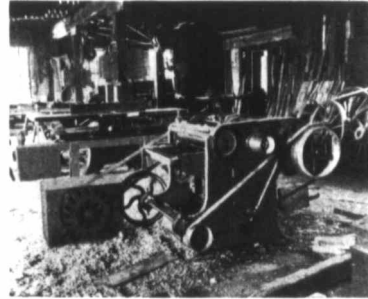

Type CCL Motors Operating Wood Planers

Motors box covered; position of one shown by shadow effect

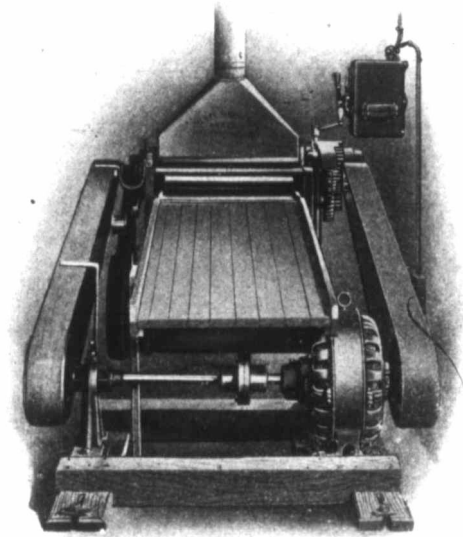

TYPE CCL MOTOR BELTED TO 26-INCH WOOD PLANER

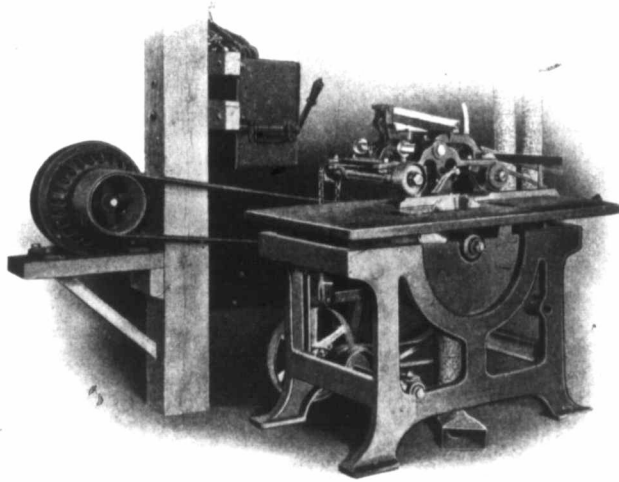

TYPE CCL MOTOR BELTED TO SELF-FEEDING RIP SAW

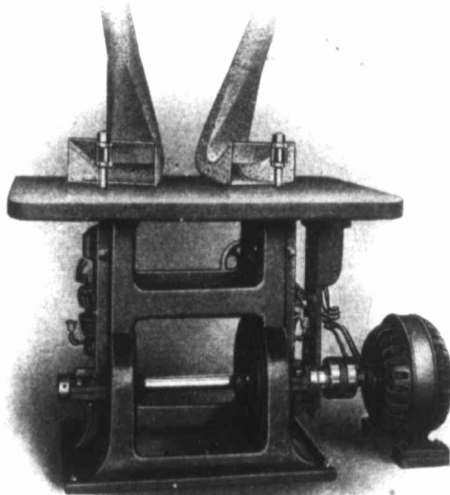

TYPE CCL MOTOR DIRECT CONNECTED TO TWO-SPINDLE SHAPER

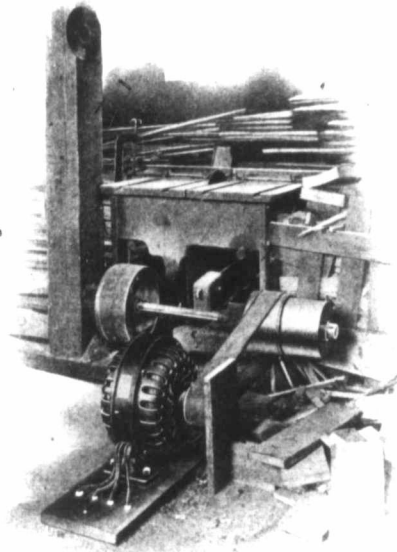

TYPE CCL MOTOR OPERATING CUT-OFF SAW

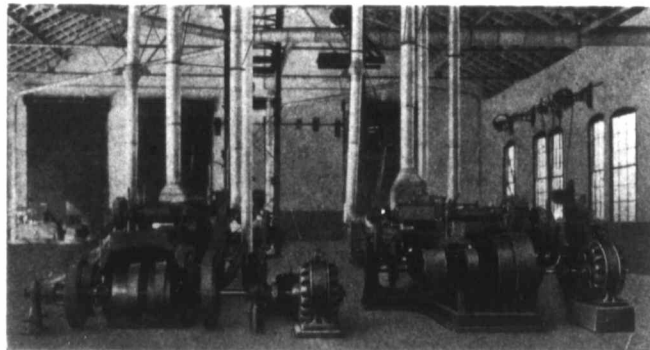

TYPE CCL MOTORS DRIVING WOOD PLANERS

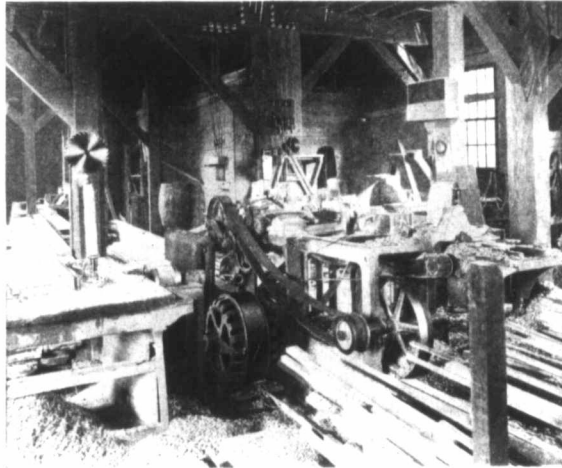

TYPE CCL MOTOR BELTED TO MOULDING MACHINE

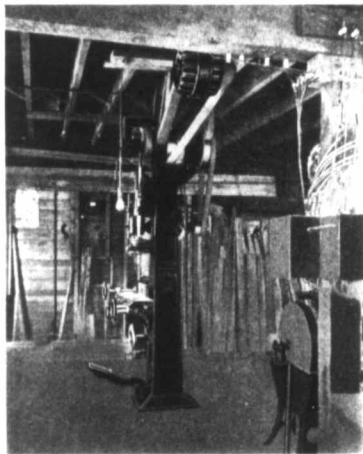

Type CCL Motor Operating Mortiser

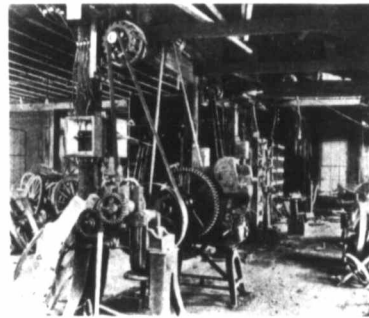

Type CCL Motors in Forge Room of
Wagon Works

34-1118 *Westinghouse Type CCL Polyphase Induction Motors*

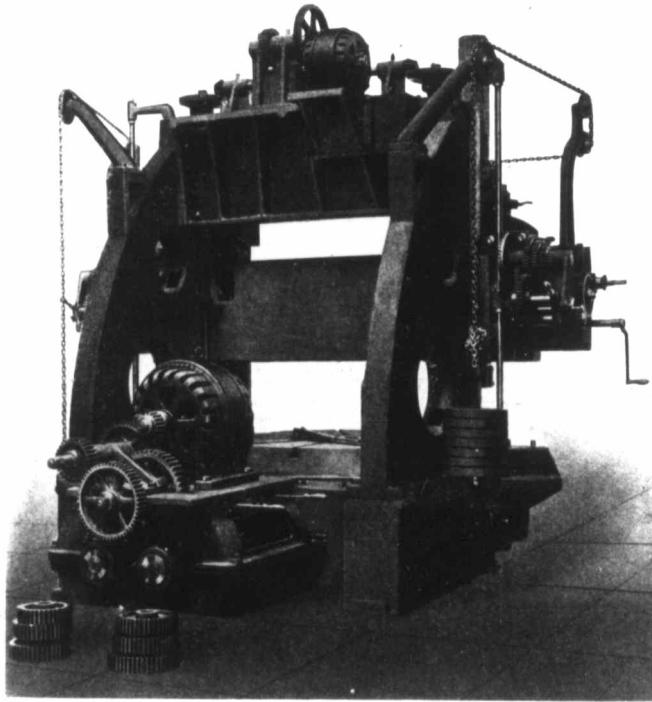

TYPE CCL MOTORS GEARED TO BORING MILL

Main motor 15 h.p. Elevator motor 3 h.p.

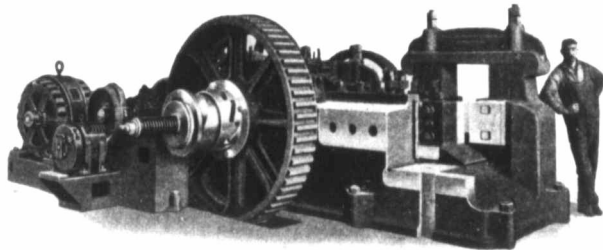

TYPE CCL MOTOR (75 H.P.) GEARED TO 10" x 10" HOT BLOOM SHEAR

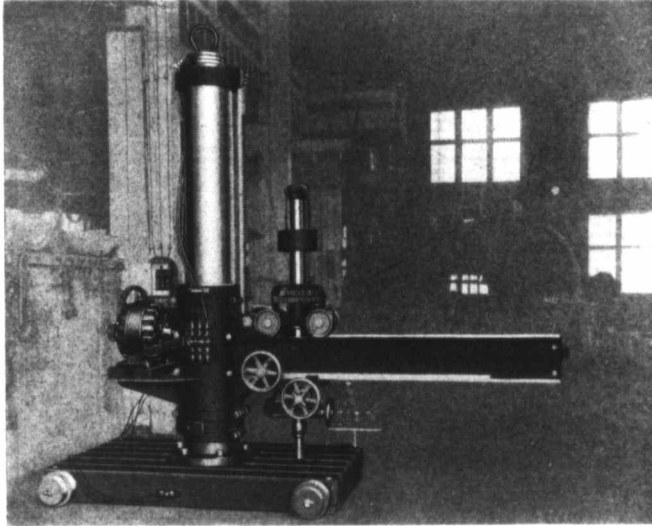

TYPE CCL MOTOR GEARED TO PORTABLE RADIAL REAMER

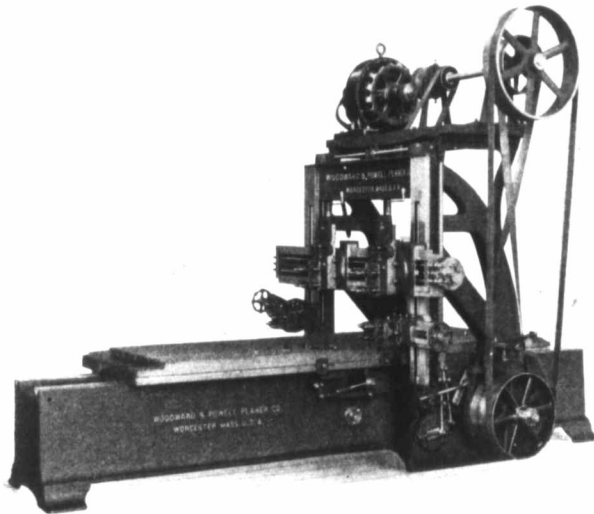

TYPE CCL MOTOR GEARED TO 36" x 36" PLANER

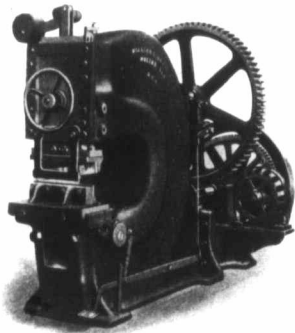

Type CCL Motor Geared to 30" Throat Punch

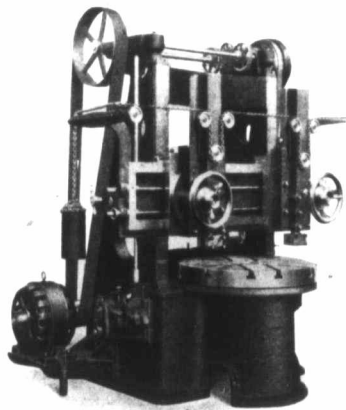

Type CCL Motor Belted to Boring Mill

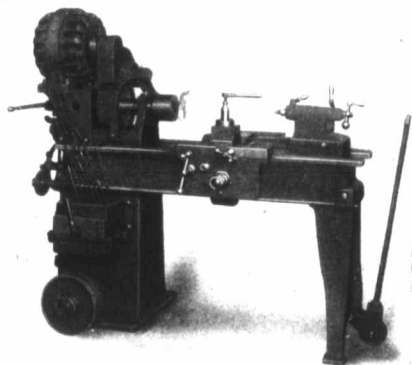

Type CCL Motor Geared to Portable Lathe

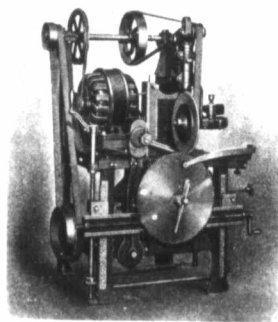

Type CCL Motor Driving Saw Sharpener

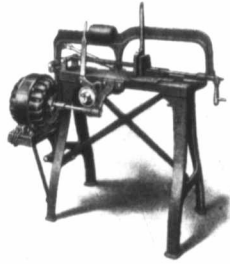

Type CCL Motor Driving
Hack Saw by Means
of Worm Gear

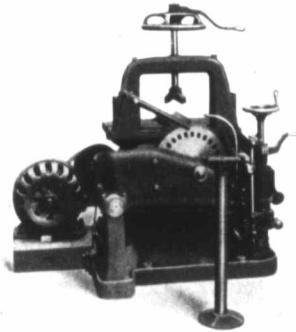

Type CCL Motor Driving Cold Saw

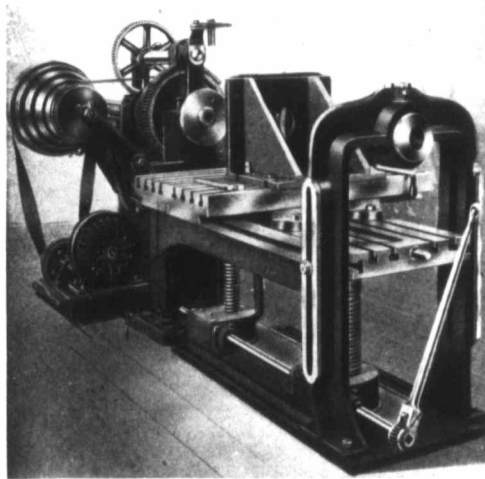

TYPE CCL MOTOR (5 H.P.) BELTED TO HORIZONTAL BORING MILL

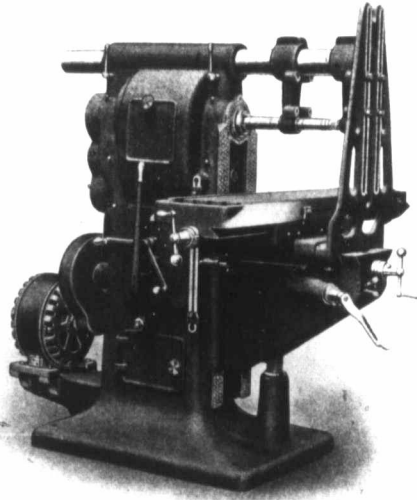

TYPE CCL MOTOR GEARED TO MILLING MACHINE

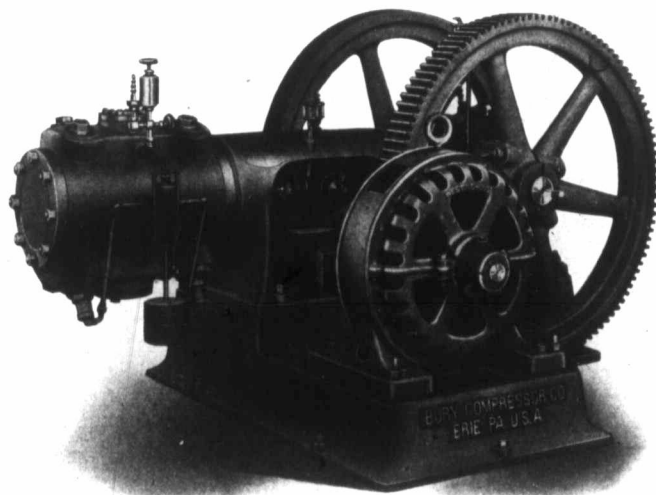

TYPE CCL MOTOR GEARED TO AIR COMPRESSOR

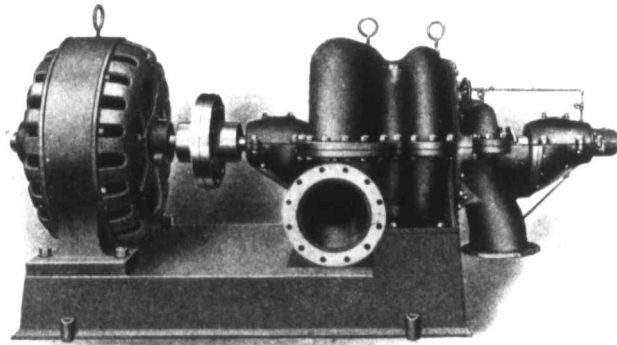

TYPE CCL MOTOR DIRECT CONNECTED TO TWO-STAGE PUMP

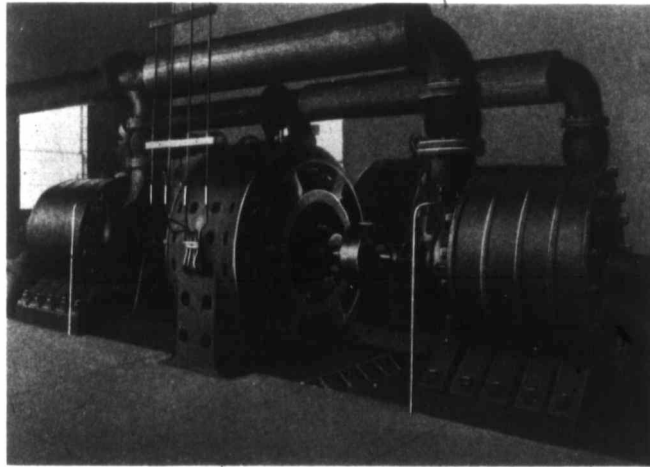

TYPE CCL MOTOR (650 H.P.) DIRECT CONNECTED TO TWO 5-STAGE PUMPS

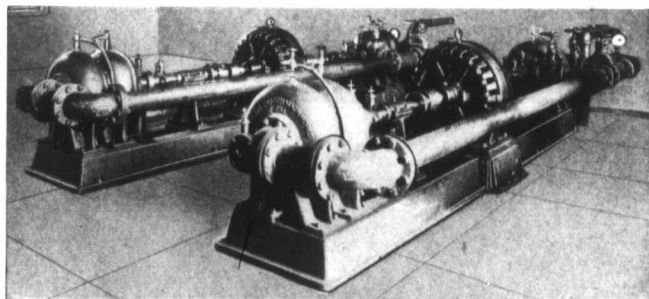

TYPE CCL MOTORS DIRECT CONNECTED TO CENTRIFUGAL PUMPS

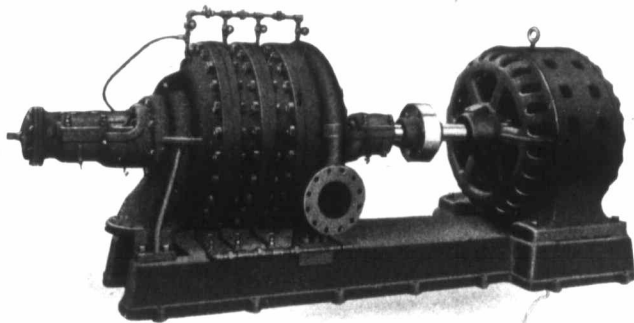

TYPE CCL MOTOR (250 H.P.) DIRECT CONNECTED TO CENTRIFUGAL PUMP

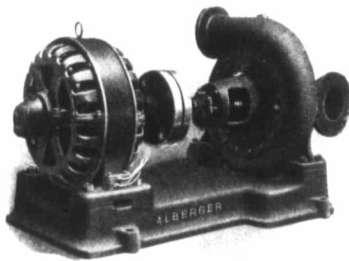

Type CCL Motor (7 1/2 H.P.) Direct
Connected to Volute Pump

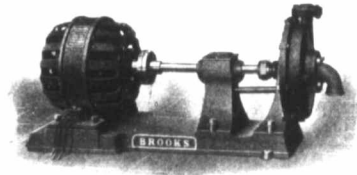

Type CCL Motor Direct-Connected
to Centrifugal Pump

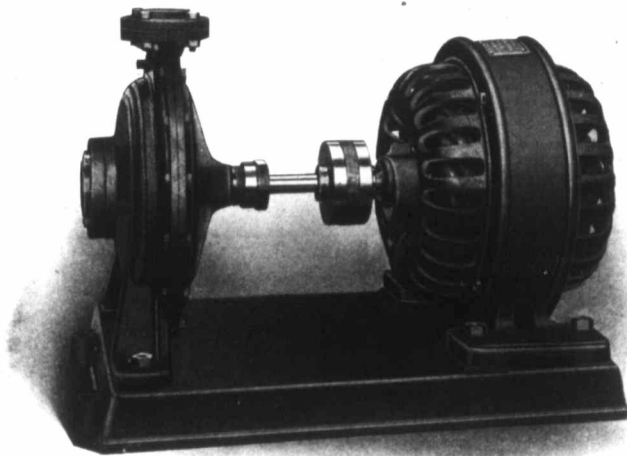

TYPE CCL MOTOR DIRECT CONNECTED TO TURBINE PUMP

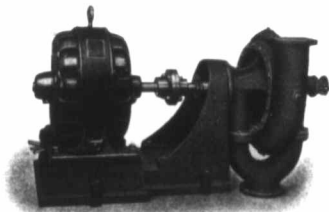

Type CCL Motor Direct Connected
to Centrifugal Pump

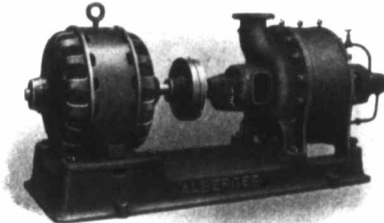

Type CCL Motor (50 H.P.) Direct
Connected to Turbine Pump



Type CCL Motor Geared to Deep Mine Sinking Pump

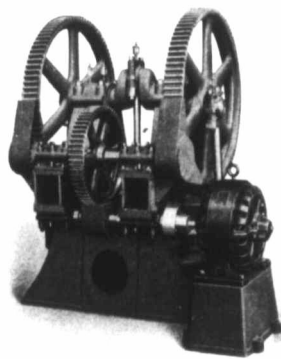

Type CCL Motor Geared to Deep Well Pump Head

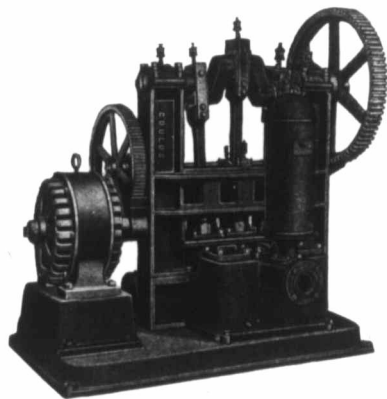

Type CCL Motor Geared to Vertical Triplex Pump

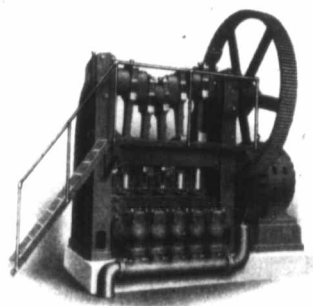

Type CCL Motor (150 H.P.) Geared to 6" x 12" Vertical Quintuplex Pump

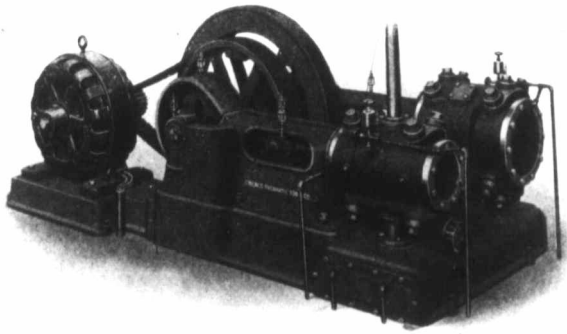

TYPE CCL MOTOR (50 H.P.) OPERATING AIR COMPRESSOR
SILENT CHAIN DRIVE

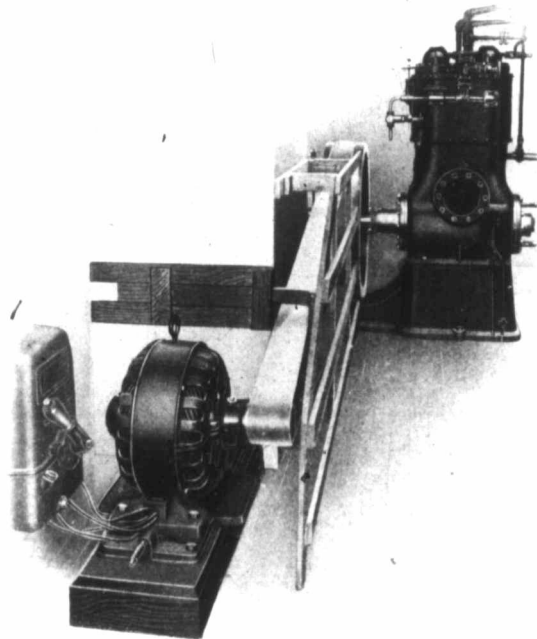

TYPE CCL MOTOR BELTED TO AMMONIA COMPRESSOR

44-1118 Westinghouse Type CCL Polyphase Induction Motors

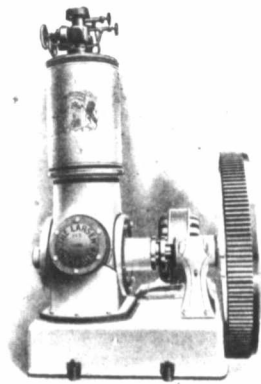

Type CCL Motor Geared to Refrigeration Compressor

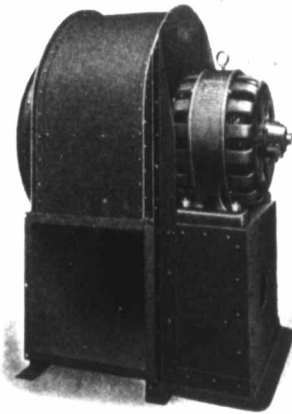

Type CCL Motor Direct Connected to Fan

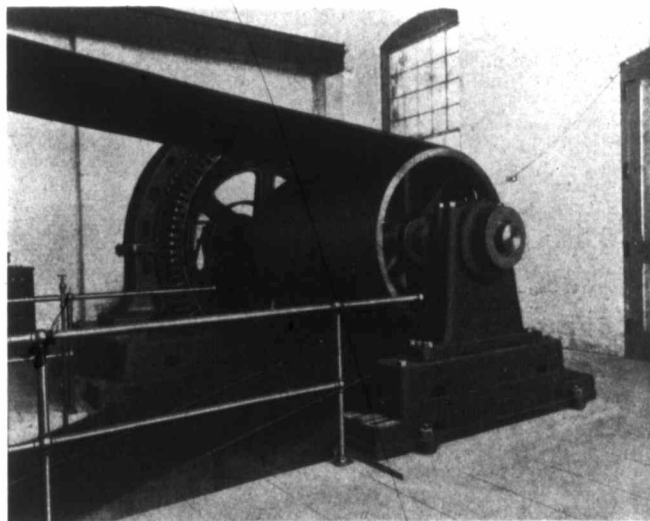

TYPE HF MOTOR (600 H.P.) BELTED TO AIR COMPRESSOR

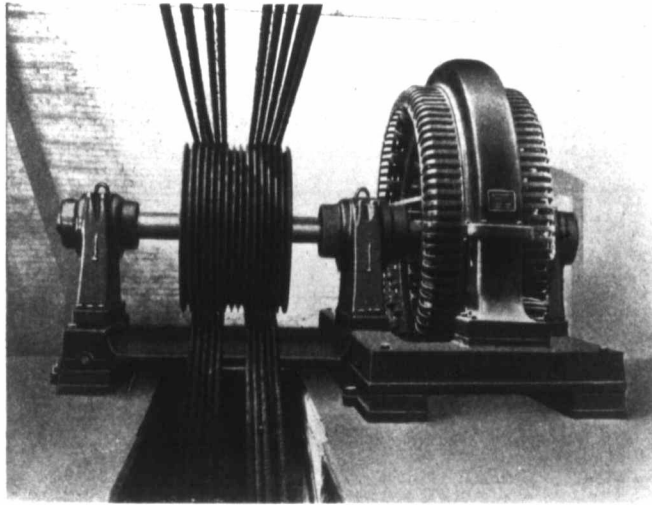

TYPE HF MOTOR (600 H.P.) OPERATING BLOWER BY ROPE DRIVE

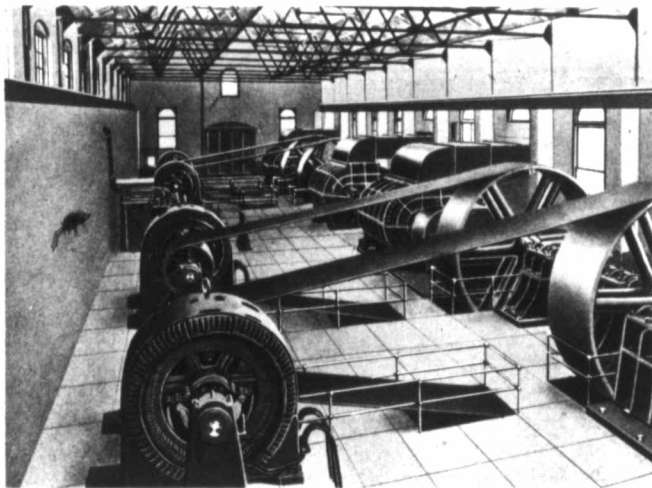

TYPE HF MOTORS (600 H.P.) BELTED TO ROOTS BLOWERS

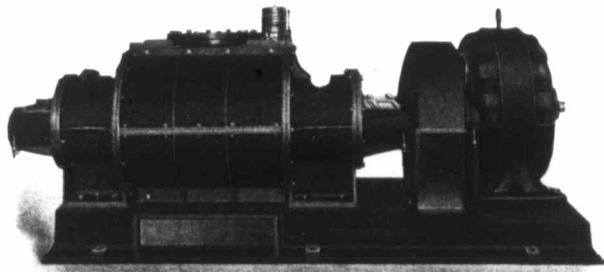

TYPE CCL MOTOR GEARED TO ROTARY PRESSURE BLOWER

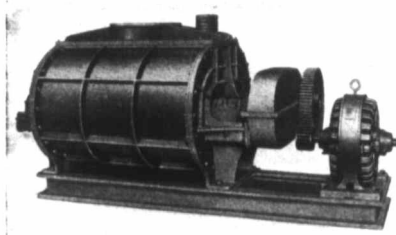

Type CCL Motor Geared to Blower

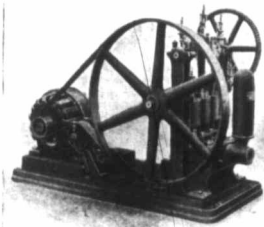

Type CCL Motor Belted to
Triplex House Pump

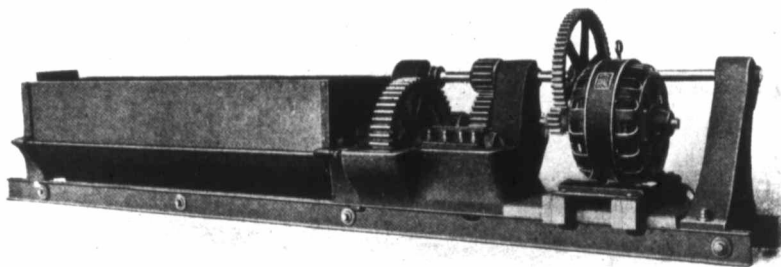

TYPE CCL MOTOR GEARED TO PUG MILL

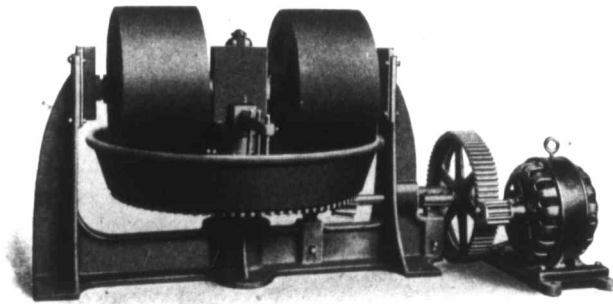

TYPE CCL MOTOR GEARED TO CINDER GRINDER

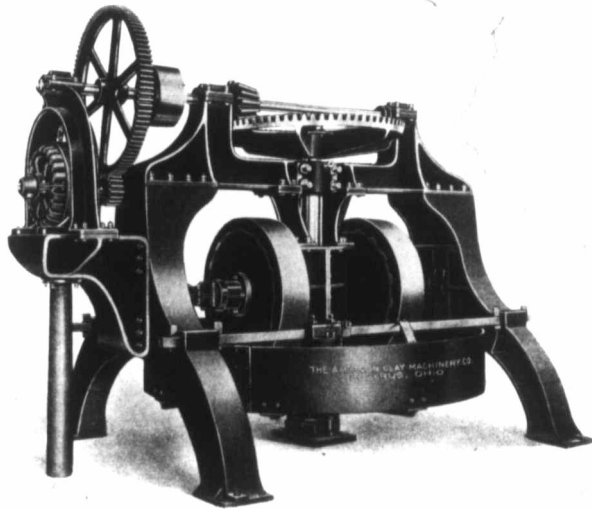

TYPE CCL MOTOR GEARED TO DRY PAN

48-1118 Westinghouse Type CCL Polyphase Induction Motors

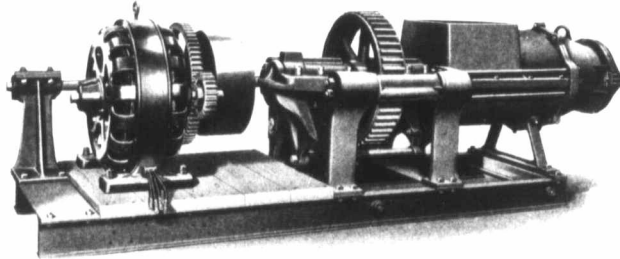

TYPE CCL MOTOR GEARED TO GIANT AUGUR

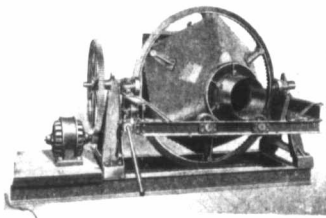

Type CCL Motor Geared to Concrete Mixer

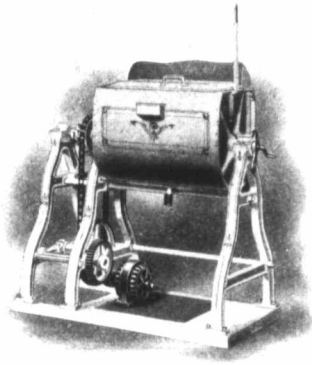

Type CCL Motor Geared to Egg Beater

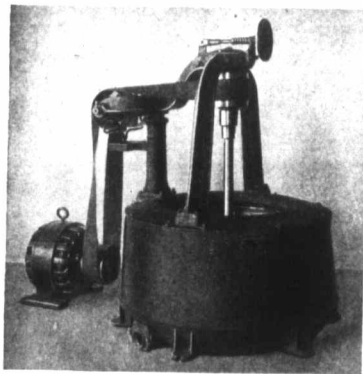

Type CCL Motor Belted to Centrifugal Extractor

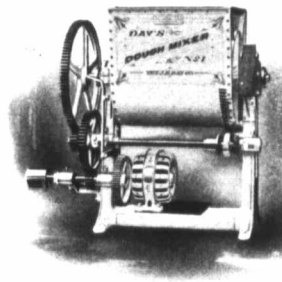

Type CCL Motor Geared to Dough Mixer

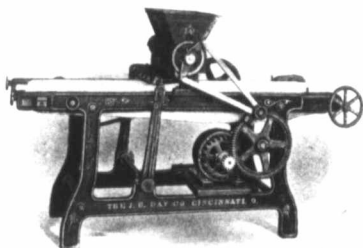

Type CCL Motor Geared to Cake Cutter

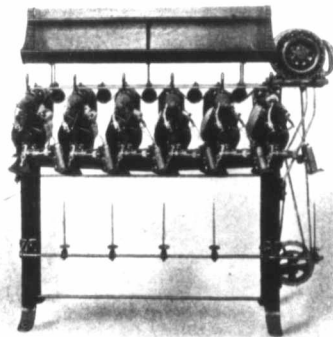

Type CCL Motor Driving Number 50 Universal Winding Machine

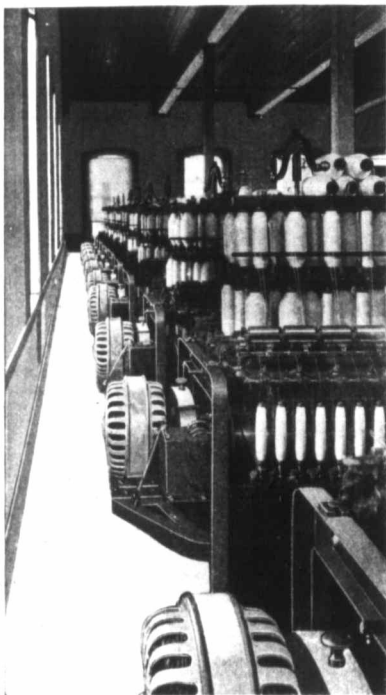

Type CCL Motors Driving Spinning Frames

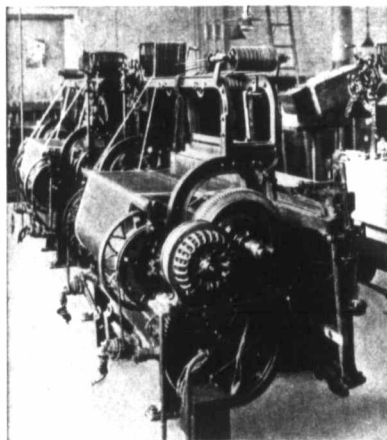

Type CCL Motors Geared to Looms

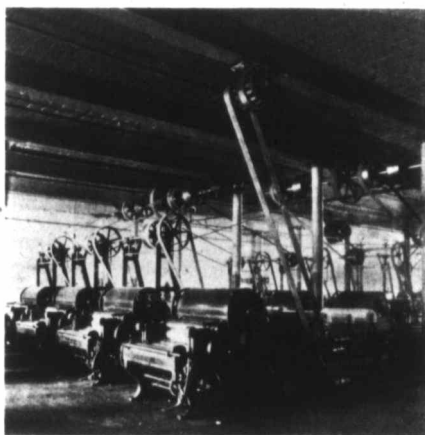

TYPE CCL MOTOR DRIVING COTTON PICKERS

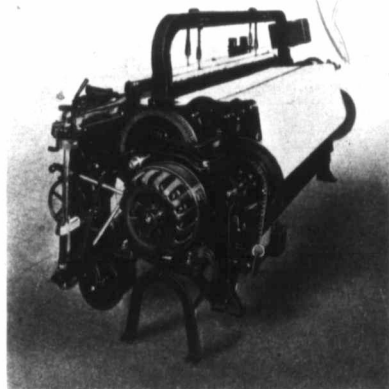

Type CCL Motor Geared to Loom

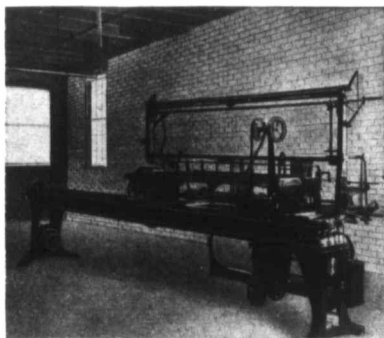

Type CCL Motor Driving Warp
Drawing Machine

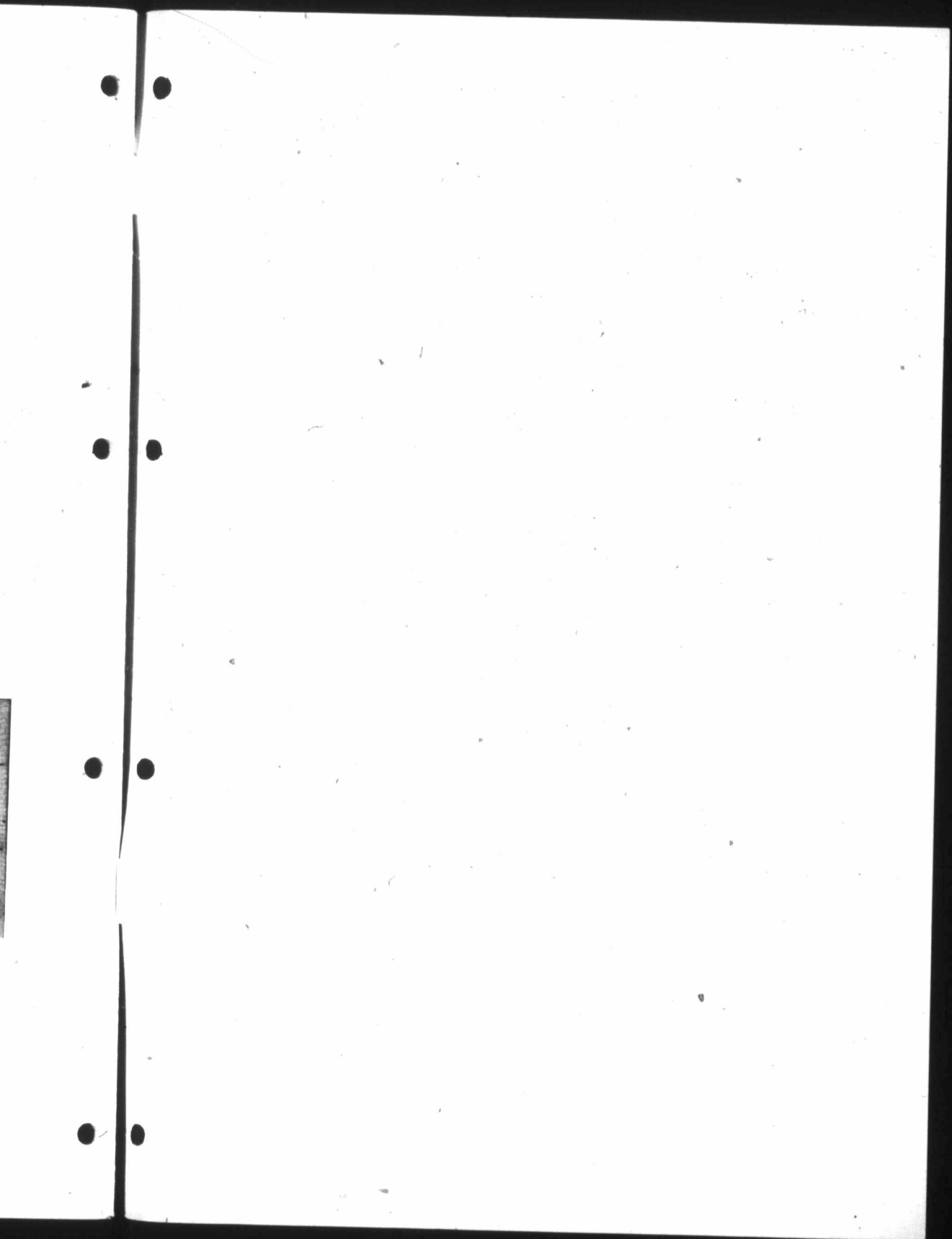

Canadian Westinghouse Co., Limited

GENERAL OFFICES AND WORKS: HAMILTON, ONTARIO

OFFICES:

Traders' Bank Building 232-236 St. James Street
TORONTO MONTREAL

Walsh Block, Pender St. 922-923 Union Bank Building 158 Granville St.
VANCOUVER WINNIPEG HALIFAX

THE BRITISH WESTINGHOUSE ELECTRIC & MFG. COMPANY, LIMITED

Registered Office—LONDON, Westinghouse Building, Norfolk Street, Strand, W. C.
Head Office and Works—MANCHESTER, Trafford Park

BRANCH OFFICES

BIRMINGHAM, Central House, New Street—CARDIFF, 102 St. Mary Street—GLASGOW, Castle Chambers, 67 Renfield Street—NEW CASTLE ON TYNE, Collingwood Buildings, Collingwood Street—MANCHESTER, Haworths Building, 5 Cross Street—SHEFFIELD, Market Place Buildings
For South Africa—JOHANNESBURG, Consolidated Bldg., Tel. Address "Converter Johannesburg"

AGENTS

For Australia, New Zealand and Tasmania—Noyes Bros.—SYDNEY, 109 Pitt Street—MELBOURNE 153-7 William St.—DUNEDIN, 1 Crawford Street—PERTH, Commercial Bank Chambers, St. George's Terrace—BRISBANE, 45 Adelaide Street—WELLINGTON, CHRISTCHURCH & DUNEDIN, Turnbull & Jones, Ltd., Selling Agents.

For India, Upper and Lower Burma—CALCUTTA, Jessup & Co. Ltd., 93 Clive Street.
MEXICO—G. & O. Braniff & Co., City of Mexico.
NEWFOUNDLAND—Reid Newfoundland Co., St. John's.
JAPAN—Takata & Co., Tokio.
CHINA—Takata & Co., Shanghai.
CUBA—Charles H. Thrall & Co., Havana.
BRAZIL—Trajano de Medeiros & Co., Rio de Janeiro.
CHILE, PERU, BOLIVIA AND ECUADOR—J. K. Robinson, Iquique, Chile.
SWEDEN—The Amalgamated Electric Co., Stockholm.
NORWAY—Elektrisk Bureau, Christiania.
EGYPT AND SUDAN—Orenstein & Koppel, Alexandria, Cairo & Kartoum.
ARGENTINE REPUBLIC, URUGUAY AND PARAGUAY—Agar, Cross & Co., 124 Calle Defensa 128, Buenos Aires.
BULAWAYO—Sykes & Co. (for Rhodesia)
BOMBAY—Bradbury, Brady & Co.

SOCIÉTÉ ANONYME WESTINGHOUSE

2 Boulevard Sadi Carnot, LE HAVRE, FRANCE

for France, Belgium, Spain, Holland, Switzerland, Italy, Portugal, their colonies and countries under their protectorate

WESTINGHOUSE ELECTRIC COMPANY, LIMITED

4 Rue Auber, Paris France

WESTINGHOUSE ELECTRICITÄTS-ACTIENGESELLSCHAFT

51 Dorotheenstrasse, BERLIN, N. W. 7—for Germany, Hungary (including Bosnia and Herzegovina), the Balkan States, Greece, Turkey in Europe and Asia

SOCIÉTÉ ÉLECTRIQUE WESTINGHOUSE DE RUSSIE

Nevsky Prospect No. 11, ST. PETERSBURG
for the Russian Empire in Europe and Asia

WESTINGHOUSE ELECTRIC & MFG. CO.

PITTSBURG, PA., U. S. A.

for North America, South America (except British and French Possessions), Cuba, Puerto Rico, Hawaiian Islands, China (except British Possessions and Dependencies), and Japan