

Technical and Bibliographic Notes / Notes techniques et bibliographiques

The Institute has attempted to obtain the best original copy available for filming. Features of this copy which may be bibliographically unique, which may alter any of the images in the reproduction, or which may significantly change the usual method of filming, are checked below.

L'Institut a microfilmé le meilleur exemplaire qu'il lui a été possible de se procurer. Les détails de cet exemplaire qui sont peut-être uniques du point de vue bibliographique, qui peuvent modifier une image reproduite, ou qui peuvent exiger une modification dans la méthode normale de filmage sont indiqués ci-dessous.

Coloured covers/  
Couverture de couleur

Coloured pages/  
Pages de couleur

Covers damaged/  
Couverture endommagée

Pages damaged/  
Pages endommagées

Covers restored and/or laminated/  
Couverture restaurée et/ou pelliculée

Pages restored and/or laminated/  
Pages restaurées et/ou pelliculées

Cover title missing/  
Le titre de couverture manque

Pages discoloured, stained or foxed/  
Pages décolorées, tachetées ou piquées

Coloured maps/  
Cartes géographiques en couleur

Pages detached/  
Pages détachées

Coloured ink (i.e. other than blue or black)/  
Encre de couleur (i.e. autre que bleue ou noire)

Showthrough/  
Transparence

Coloured plates and/or illustrations/  
Planches et/ou illustrations en couleur

Quality of print varies/  
Qualité inégale de l'impression

Bound with other material/  
Relié avec d'autres documents

Continuous pagination/  
Pagination continue

Tight binding may cause shadows or distortion along interior margin/  
La reliure serrée peut causer de l'ombre ou de la distorsion le long de la marge intérieure

Includes index(es)/  
Comprend un (des) index

Blank leaves added during restoration may appear within the text. Whenever possible, these have been omitted from filming/  
Il se peut que certaines pages blanches ajoutées lors d'une restauration apparaissent dans le texte, mais, lorsque cela était possible, ces pages n'ont pas été filmées.

Title on header taken from:/  
Le titre de l'en-tête provient:

Title page of issue/  
Page de titre de la livraison

Caption of issue/  
Titre de départ de la livraison

Masthead/  
Générique (périodiques) de la livraison

Additional comments:/  
Commentaires supplémentaires:

This item is filmed at the reduction ratio checked below/  
Ce document est filmé au taux de réduction indiqué ci-dessous.

10X	14X	18X	22X	26X	30X
<input type="checkbox"/>	<input type="checkbox"/>	<input type="checkbox"/>	<input type="checkbox"/>	<input checked="" type="checkbox"/>	<input type="checkbox"/>
12X	16X	20X	24X	28X	32X

Core Compound and Foundry Supplies Sand, suitable for all classes of work HAMILTON, ONT.

A. B. JARDINE & CO. MACHINISTS' TAPS REGISTERED TRADE MARK HESPELIER, ONT.

**CANADIAN MANUFACTURER**  
 AND INDUSTRIAL WORLD.  
 DEVOTED TO THE MANUFACTURING INTEREST OF THE DOMINION

VOL 36.

TORONTO, FEBRUARY 4, 1898.

No. 3.

**THE BARBER & ELLIS CO.**  
 Selling Agents for  
**Rolland's Superfine Writing and Ledger Papers.**  
 Prices and Samples on Application.  
 Nos. 43, 45, 47 and 49 BAY ST., TORONTO.

**ANILINE LIZARINES**  
 DOMINION DYEWOOD & CHEMICAL CO. TORONTO  
 PRODUCTS OF  
 THE FARBENFABRIKEN VON M. F. BAYER & CO.  
 DOMINION DYEWOOD & CHEMICAL CO. TORONTO  
 SELF AGENTS FOR CANADA

CHARLES F. CLARK, Pres. EDW. F. RANDOLPH, Secy.  
 ESTABLISHED 1819.  
**THE BRADSTREET MERCANTILE AGENCY**  
 THE BRADSTREET COMPANY - Proprietors  
 NEW YORK  
 Offices in the principal cities of the United States, Canada, the European Continent, Australia, and in London, England.  
 The Bradstreet Company is the oldest, and financially, the strongest organization of its kind—working in one interest and under one management—with wider ramifications, and more capital invested in the business, and it expends more money every year for the collection and dissemination of information than any similar institution in the world. Toronto Offices:—  
**MCKINNON BUILDING, TORONTO**  
 THOS. C. IRVING, Superintendent.

We are the only Manufacturers in Canada making **GENUINE OAK TANNED BELTING** in "Extra," "Standard" and "Dynamo."  
 We Manufacture **CARD CLOTHING** set in **OAK LEATHER, FLEXIFORT** and **RUBBER**  
**HEDDLES, LOOM REEDS, PICKERS, RUB. APRONS, Etc.**  
 Estimates for **LEATHER RUBBER "THISTLE" and GANDY BELTING** will be found favorable

MONTREAL \* **THE J. C. McLAREN BELTING CO.** \* TORONTO

**Fensom's Elevators**  
 ELECTRIC HYDRAULIC STEAM HAND-POWER  
 All made of the best material, and Finest workmanship.  
 The Fensom Elevator Works... 52, 51, 56 Duke Street, Toronto, Ont.

**RUBBER GOODS OF ALL KINDS.**  
  
 61 and 63 FRONT ST. WEST, TORONTO.

THE....  
**Walkerville Malleable Iron Co., (Limited)**  
 ..Manufacturers of..  
**REFINED AIR FURNACE Malleable Castings**  
 ALSO LIGHT GREY IRON CASTINGS.  
 WALKERVILLE, - ONTARIO.

**RIDOUT & MAYBEE**  
 Foreign members of the.... CHARTERED INSTITUTE OF PATENT AGENTS, ENGLAND

SOLICITORS of and EXPERTS in  
 PAMPHLET ON PATENTS SENT FREE  
 103 Bay Street, Toronto

**Patents**



MACHINISTS' TAPS SEND FOR CATALOGUE

# The Royal Electric Co'y

MONTREAL, QUE.

Western Office.... TORONTO, ONT.

## S.K.C. Two-Phase Alternators

Incandescent Light, Arc Light and Power from same Dynamo and Circuit.

Highest Efficiency

Best Regulation

Slow Speed

Least Attention

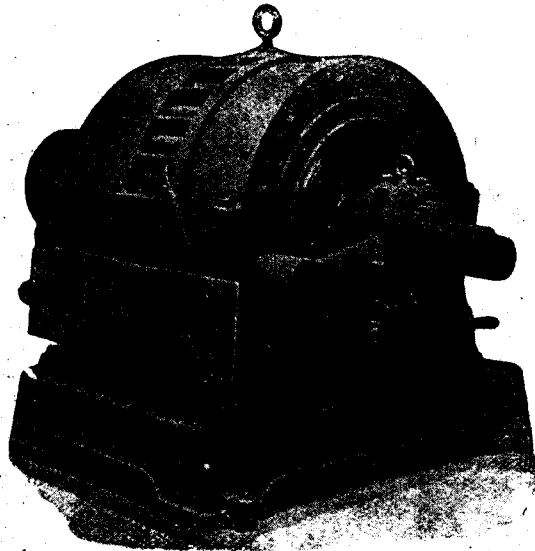

No Collector

No Moving Wire

No Exposed Parts

No Compounding

S.K.C. 50 Kilowatt Two-Phase Generator

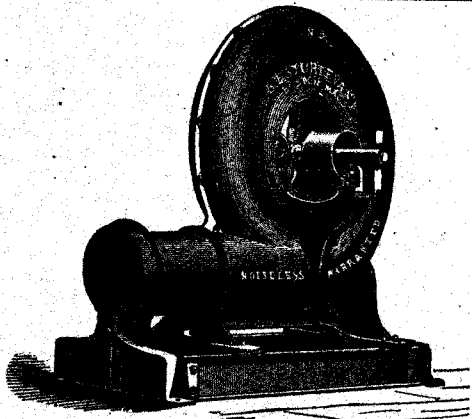

Blower on Adjustable Bed.

### The STURTEVANT STEEL

### Pressure Blowers

—FOR—

Cupola Furnaces and Forge  
Fires

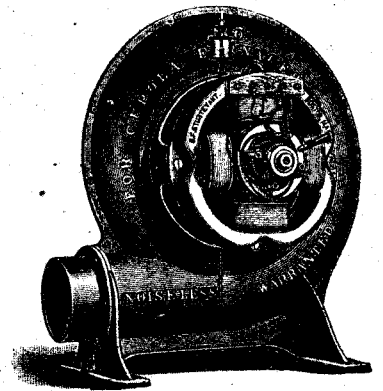

Blower with Electric Motor.

MANUFACTURED BY

**B. F. Sturtevant Co.**

BOSTON, MASS., U.S.A.

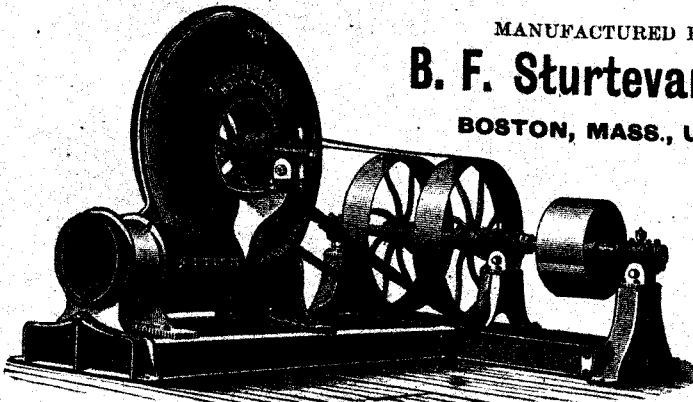

Blower on Adjustable Bed with Combined Countershaft.

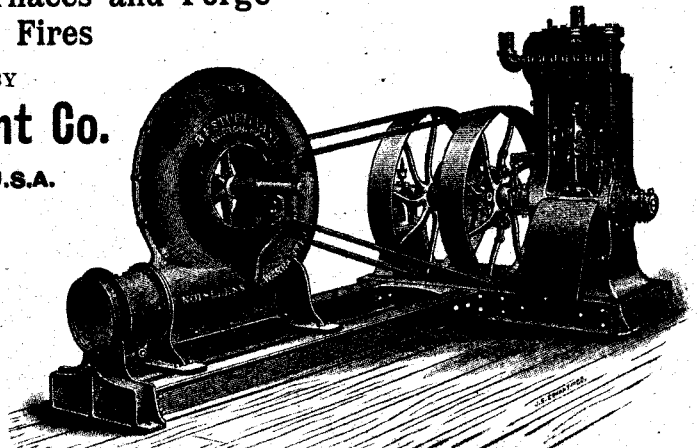

Blower on Adjustable Bed, with Double Enclosed Engine.

**A. R. WILLIAMS MACHINERY CO.,** General Canadian Agents, Toronto, Brantford, Montreal

# THE PLANSIFTER

This Machine Leads; Others try to Follow!

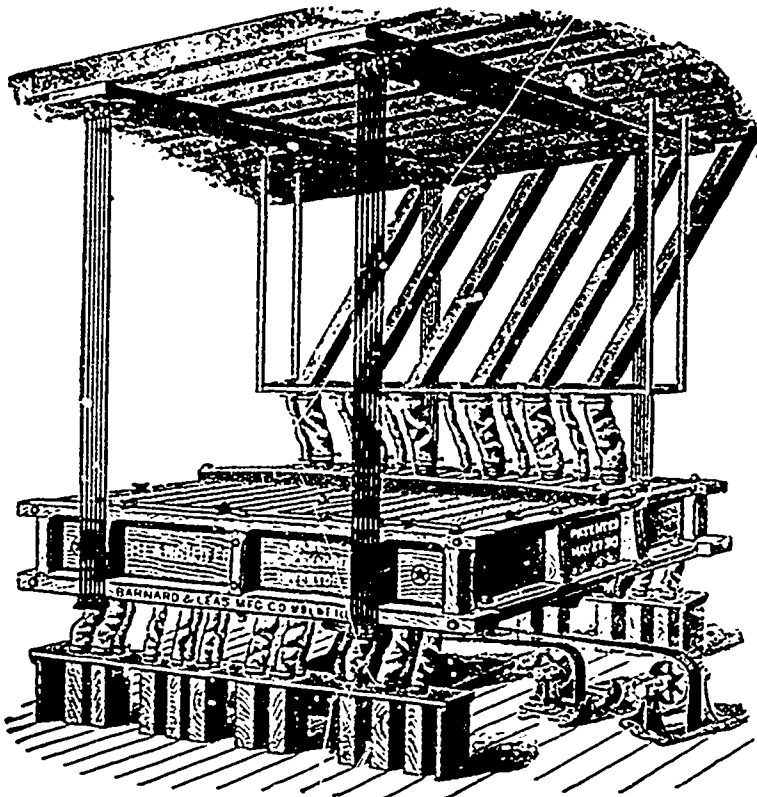

THE PLANSIFTER produces results far superior to any other machine or system.

POWER SAVED—The saving in power alone in steam mills will soon pay the cost of a PLANSIFTER.

THE PLANSIFTER is the most convenient machine to place in a mill.

THE PLANSIFTER MILL has lots of air, light and room, with easy access to every stock.

PRICE WITHIN REACH OF ALL.

The following is a partial list of millers who have adopted the Plansifter system within the last twelve months.

	Capacity, Barrels.
John Wason, Warsaw .....	50
Consolidated Milling Co., Peterboro'.....	250
C. E. Drewery, Colborne .....	35
G. S. Baldwin, Aurora .....	125
Robert Sugden, Holt.....	30
M. N. Stephens, Glencairn .....	150
Jos. Knox & Co., Stayner .....	75
E. W. B. Snider, St. Jacobs.....	150
Wm. Ross, Brussels.....	60
Smith & Scratch, Kingsville .....	35
Wray & Hawkshaw, Lucan .....	50
T. Mather, Tilbury .....	75
Lorenzo Marquerz Milling Co., Lorenzo Marquerz, South Africa.....	200
John Lockhart, Rainy River.....	50
Wolsley Milling Co., Wolsley, N.W.T .....	100
George Vick & Son, Orillia, Ont. ....	100
A. S. Bowen & Sons, Kemptville .....	125
H. Brown & Sons, Carlton Place .....	125
Hunt Bros., London .....	250
Wm. Mack, Cornwall .....	100
George Boxall, Embro.....	50
Hudson Bay Co., Winnipeg.....	350
J. L. Meek, Alton .....	50
Harold Barrett & Co., Port Hope.....	75
J. W. Cornish, Leskard .....	50
A. McKillop & Son, West Lorne .....	50
Donald Currie, Port Lock .....	30
Cookshire Flour Mill Co., Cookshire, Que.....	60
Sadler, Dupdas & Flavelle Milling Co., Lindsay....	400
Kerr Bros., Farran's Point.....	50
T. J. Bennett, Spencerville .....	60

## ITS ADVANTAGES ARE

It Saves Space	Makes Better Clean-up	No Dust
It Saves Power	Makes Closer Finish	Easily Controlled
It Saves Cloth	Makes Larger Yield	Insures Uniform High Grade
Makes Better Separations	Makes Milling Easier	Increases Capacity
Makes Purer Stock	No Vibration	Must Come into General Use
Makes Better Flour	No Noise	

Big Mills Cannot Afford to do Without them, and they do Charming Work in the Smallest Mills.

SOLE LICENSEES AND MANUFACTURERS FOR CANADA

# WM. & J. G. GREY, 2 Church St., TORONTO

# DOMINION BRIDGE CO.

(LIMITED)

MONTREAL AND LACHINE LOCKS, P.Q.

Steel Bridges for Railways and Highways,  
Steel Piers and Trestles, Steel  
Water Towers and Tanks, Steel  
Roofs, Girders, Beams, Columns,  
for Buildings.

A Large Stock of....

**ROLLED STEEL BEAMS, JOISTS, GIRDERS  
CHANNELS, ANGLES, TEES, Z BARS  
AND PLATES ALWAYS ON HAND**

IN LENGTHS TO THIRTY-FIVE FEET

Tables, giving Sizes and Strength of Rolled Beams  
on application.

Post Office Address, - - MONTREAL.

**GEO. E. EVANS,** Agent, 38 Canada Life Building,  
TORONTO, ONT.

THE

# CANADIAN MANUFACTURERS' ASSOCIATION

D. W. KARN, President.

J. J. CASSIDY, Secretary.

GEORGE BOOTH, Treasurer

Secretary's Office, **McKinnon Building**

Cor. Jordan and Melinda Streets, Toronto  
Tel. 1274.

**THE OBJECTS OF THIS ASSOCIATION ARE:**

To secure by all legitimate means the aid of both Public Opinion and Governmental Policy in favor of the development of home industry and the promotion of Canadian manufacturing enterprises.

To enable those in all branches of manufacturing enterprises to act in concert, as a united body, whenever action in behalf of any particular industry, or of the whole body, is necessary.

To maintain Canada for Canadians.

Any person directly interested in any Canadian manufacturing industry is eligible for membership.

Manufacturers desiring to hold meetings for the promotion of their business are invited to avail themselves of the Board Room of the Association for the purpose, which is offered to them free of charge.

J. J. CASSIDY, Secretary

# LAW BROS. & CO....



**Caledonia Foundry  
and Machine Shops.**

HYDRANTS, VALVES, WATER WORKS  
SUPPLIES, SPECIALS, SHAFTING  
and MILL MACHINERY.

Also Castings of Every Description.

OTTAWA . . . . . ONT.

Babbitt  
Metal.



BRASS, BRONZE, PHOSPHOR BRONZE, ALUMINUM  
BRONZE, COPPER, ZINC and ALUMINUM  
CASTINGS TO ORDER. Large or Small.

Write for Prices.... **DEAN BROS., 184 Richmond St. West, Toronto**

# MONTREAL PIPE FOUNDRY CO...

SUCCESSORS TO (Limited)

**DRUMMOND-McCALL PIPE FOUNDRY CO.**

Manufacturers of

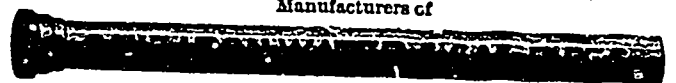

"Special," Hydrants, Valves, Etc.

Offices: - - - **Canada Life Building,  
MONTREAL**

R. C. Jamieson.

A. T. Higginson.

**R. C. JAMIESON & CO.**

Manufacturers of

**VARNISHES AND JAPANS** | Importers of Oils, Paints, Colors,  
SPIRITS, Shellacs, Rosins, Glucs, Turpentine, METHYLATED  
Gold Leaf, Bronze, etc.

Office—13 ST. JOHN STREET  
Factory and Warehouse—23 to 29 ST. THOMAS ST., | MONTREAL

# REDDAWAY'S PATENT



BREAKING STRAIN 6 IN CAMEL HAIR BELT—14,181 lbs  
6 IN DOUBLE OAK LEATHER—7,522'

**W.A. FLEMING.**

SOLE AGENT FOR CANADA.

57, ST. FRAS. XAVIER ST. (24 FRONT ST. E. VICTORIA CHAMBERS)  
MONTREAL. (TORONTO.) OTTAWA



WINN &  
HOLLAND,  
MONTREAL,  
SOLE  
AGENTS FOR CANADA.

### BRUNNER MOND & CO.'S

Pure Alkali,  
Bleaching Powder,  
Caustic Soda, ALL STRENGTHS.  
Bicarbonate of Soda,  
Concentrated Sal Soda,  
Soda Crystals.

## Wm. J. MATHESON & CO., LIMITED

NEW YORK  
BOSTON  
PHILADELPHIA  
PROVIDENCE  
CHARLOTTE, N.C.  
MONTREAL, CANADA

# DYE . . . STUFFS

## The Polson Iron Works, TORONTO CANADA.

THE BEST EQUIPPED BOILER AND ENGINE WORKS IN CANADA.

We Manufacture—

# STEEL BOILERS

The BROWN AUTOMATIC ENGINE, MARINE ENGINES (SINGLE, COMPOUND AND TRIPLE), Hoisting and Mining Engines  
STEEL STEAM VESSELS OF EVERY DESCRIPTION. STEAM YACHTS AND LAUNCHES  
GET OUR PRICES BEFORE ORDERING.  
ESPLANADE EAST, Foot of Sherbourne St., - - Toronto, Canada



Bicycle Plates in all the most  
desirable sizes and threads.  
Taps and Dies of Every Variety



# BUTTERFIELD & CO.

ROCK ISLAND, P.Q.

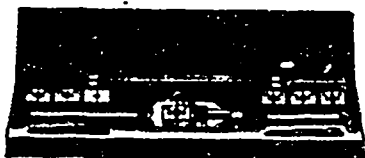

**ALBERT  
MANUFACTURING CO.**

Manufacturers of the  
well-known

"HAMMER BRAND"

**Calcined  
PLASTER**

—AND—

**Patent Rock Wall Plaster**

HILLSBOROUGH, N.B.,  
CANADA.

**A. B. FLEMING & CO.**

(Limited).

EDINBURGH, SCOTLAND

Sole Proprietors and  
Manufacturers of Fleming's Patent

**SOLIDIFIED OIL**

**FINEST LUBRICANT**

In the Market.

USED BY ALL THE PRINCIPAL STEAM-  
BOAT, RAILROAD AND MILL  
OWNERS THROUGHOUT  
THE WORLD.

**William G. Wilson & Co.**

TORONTO

SOLE AGENTS FOR CANADA.

**WELLAND VALE MANUFACTURING CO.**

Limited, ST. CATHARINES ONT.

Manufacturers of....

Axes, Edge Tools, Saws,  
Farming Implements  
and Bicycles.

**W. H. STOREY & SON**

ACTON, - - ONT.

Manufacturers of . . .

**Fine Gloves and Mitts**

In Every Variety and Style.

MOCCASINS

**CANADIAN OFFICE & SCHOOL FURNITURE CO. LIMITED**  
PRESTON ONT.



FINE BANK OFFICE, COURT HOUSE & DRUG STORE FITTINGS. OFFICE SCHOOL CHAIRS & LIGHT FURNITURE. SEND FOR CATALOGUE.

**THOUSANDS IN USE.  
THE WEBSTER FEED-WATER HEATER AND PURIFIER.**

**Points of Advantage.**

- 1—All back pressure from engines dispensed with.
- 2—Simple in construction and most durable.
- 3—All condensation from heating coils, machines, etc., can be returned to the Webster Heater.
- 4—The only heater in the market that the condensation from coils, etc., can be returned to.
- 5—Guaranteed temperature of feed water from 208 to 212 degrees, utilizing the waste exhaust steam.
- 6—We have Webster Heaters in operation for eight years that have never cost one cent for repairs.

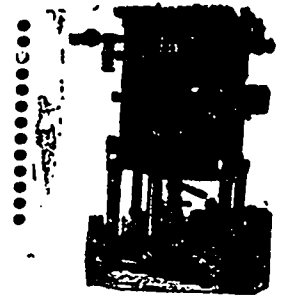

116 PAGE CATALOGUE MAILED ON APPLICATION.

**DARLING BROS.,** Queen and Ottawa Sts., MONTREAL

FRANK DARLING, Agent, NELSON, B.C.

J. HERBERT LARMONTH, B.A. Sc., Agent, CENTRAL CHAMBERS, OTTAWA, ONT.

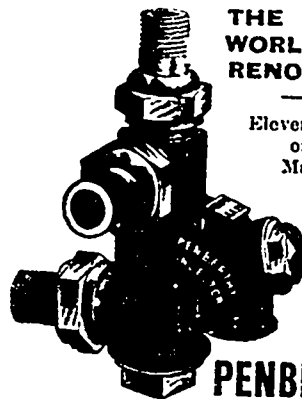

THE  
WORLD-  
RENOWNED

Eleven Years  
on the  
Market.

**PENBERTHY**

125,000  
Satisfied Users.

**AUTOMATIC  
INJECTOR.**

Works 22 to 150 lbs.  
of Steam.

Very Simple in Construction.

Circular on application.

Anyone can operate it

**PENBERTHY INJECTOR CO.,**

Largest Injector Manufacturers in the World.

132 Seventh Street, Detroit,  
Mich.; Branch Factory  
Windsor, Ont.

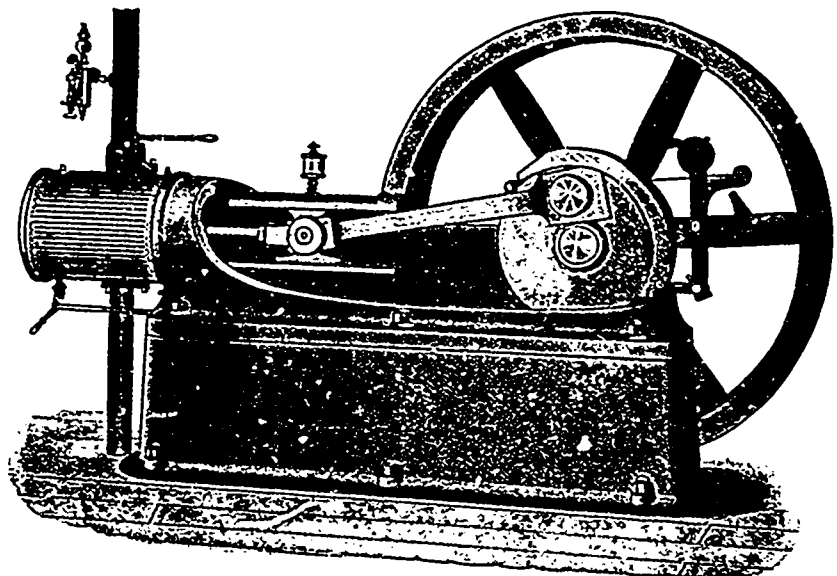

**Robb-Armstrong Automatic Engines.**

CENTRE OR SIDE CRANK.

SIZES UP TO 700 HORSE POWER.

**ROBB ENGINEERING CO., LIMITED, AMHERST, N.S.**

WILLIAM MCKAY, Seaforth, Ont., Traveller

# JOHN INGLIS & SONS

Manufacturers of

Corliss Engines, High Speed Engines, Water Works Machinery,  
Marine Engines, Condensers,  
Ice and Refrigerating Machines, Flour Mill Machinery.

## MINING MACHINERY

Boilers and Tank Work of all kinds.

Telephone 5333

HEAVY CASTINGS A SPECIALTY  
TORONTO, ONT.

# THE IMPERIAL OIL COMPANY, LIMITED

HIGHEST AWARDS AT THE WORLD'S FAIR, CHICAGO, UPON

Lubricating, W. W. Illuminating Oils, Paraffine Wax, etc.

WE MANUFACTURE ALL GRADES OF OILS, GREASES, SOAP STOCKS, CANDLES, WOOL STOCKS, LEATHER AND  
TANNERS' OILS, FUEL GAS, MACHINERY, CYLINDER OILS, ETC.,

And Solicit opportunity to compete against any Oil on the Market.

Write for Prices and Samples.

THE IMPERIAL OIL COMPANY, (Limited) Head Office, PETROLEA, CAN.

....BRANCHES....

HALIFAX, N.S. HAMILTON, ONT. QUEBEC, QUE. LONDON, ONT. TORONTO, ONT. WINNIPEG, MAN. ST. JOHN, N.B.  
GUELPH, ONT. MONTREAL, QUE. CHATHAM, ONT. PETERBORO', ONT. VANCOUVER, B.C. MONCTON, N.B.  
STRATFORD, ONT. KINGSTON, ONT. WINDSOR, ONT.

# JOHN BERTRAM & SONS,

DUNDAS, - - ONTARIO.

Offer for Sale

## A Foundry Cupola, NEW, Complete,

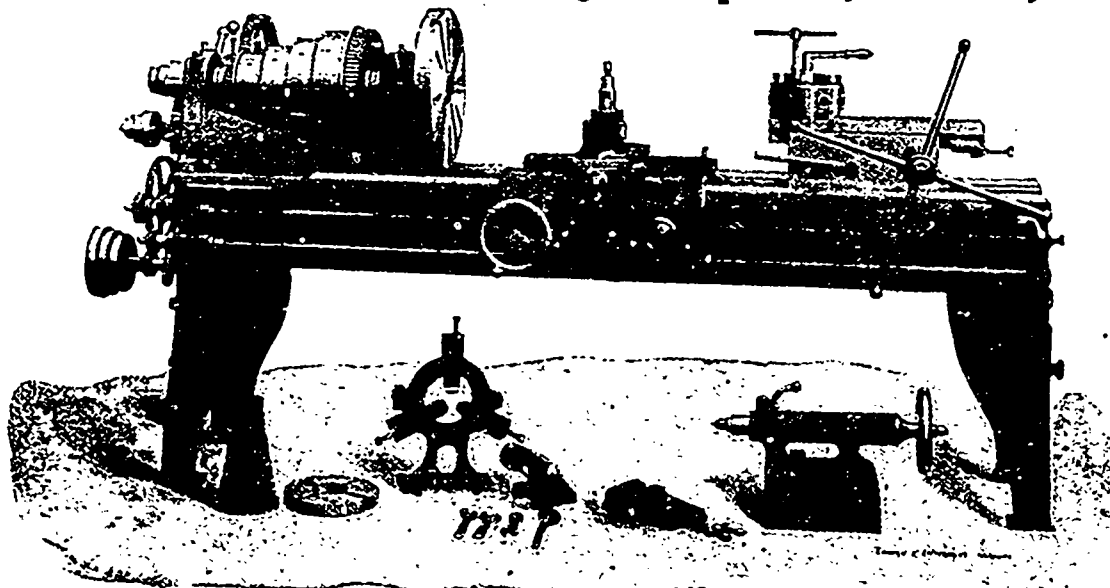

Engine Lathe, with Turret Attachment.

Shell, 52 in. Diam.,  
14 ft. long.

Stack, 20 ft. long,  
38 in. Diam.

Base plate, Columns  
Air Drum and  
Tuyers.

No. 7 Sturtevant  
Fan and all Con-  
ducting Pipes.

Also Complete Fire  
Brick for Lining.



THE ABOVE IS  
OFFERED AT  
A BARGAIN





# NORTHEY MFG. CO., LIMITED, TORONTO, - ONTARIO.

## Steam and Power

# Pumps

& HYDRAULIC MACHINERY

## FOR ALL DUTIES.

## MICA BOILER AND STEAM PIPE COVERING.

THE CHEAPEST IN THE MARKET. DURABLE, FLEXIBLE, AND A MAGNIFICENT NON-CONDUCTOR OF HEAT.

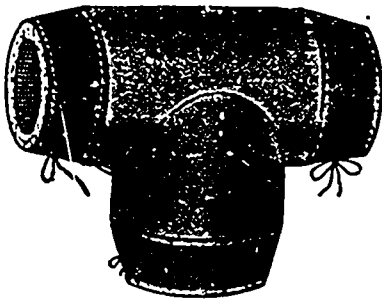

TEE

Made in Sections to fit all sizes of Pipe, and can be removed and replaced as often as desired.

Adjustable Mica Coverings for all kinds of fittings.

Mica Covering cannot be affected by vibration, and will not shift or sag.



Write for reports of trials, testimonials, etc., to

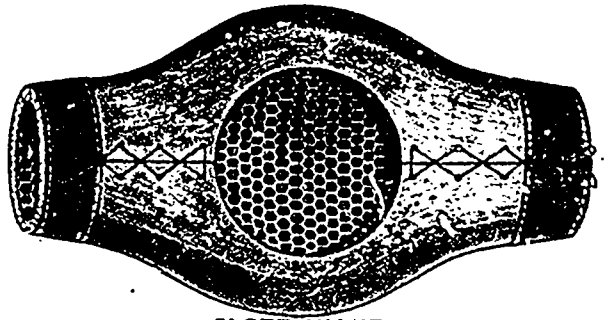

GLOBE VALVE.

### THE MICA BOILER COVERING COMPANY, Limited 9 JORDAN STREET, TORONTO.

## FETHERSTONHAUGH & CO.

PATENT BARRISTERS AND SOLICITORS

ELECTRICAL AND MECHANICAL EXPERTS AND DRAUGHTSMEN

Head Office: Canadian Bank of Commerce Bldg, Toronto, Ont.

**Patents** Procured in Canada and all Foreign Countries.

Offices in Montreal, Que., Ottawa, Ont., and Washington, D.C.

## THE Defiance Machine Works

### DEFIANCE, OHIO, U.S.A.

Established 1850

INVENTORS AND BUILDERS OF UP-TO-DATE NINETEENTH CENTURY

### AUTOMATIC Wood-Working Machinery

For Making

WAGON AND CARRIAGE WHEELS, HUBS, SPOKES, RIMS, FELLOES, SHAFTS, POLES, NECK-YOKES, SINGLE-TREES, BARREL HOOPS, Etc., Etc.

Send for 300-Page Catalogue—FREE  
GENERAL CANADIAN AGENTS

### ESTATE OF T. T. COLEMAN SEAFORTE, ONTARIO, CANADA

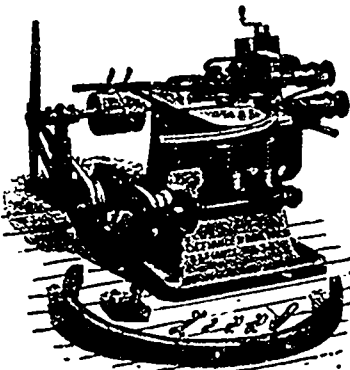

RIM PLANING MACHINE.

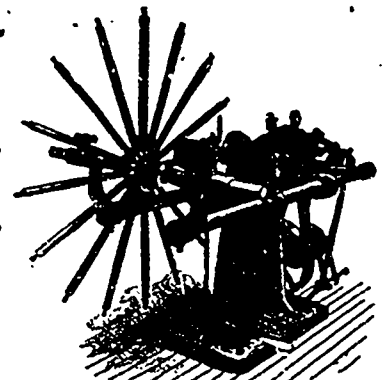

WHEEL TENONING MACHINE.



ESTABLISHED IN 1880.

PUBLISHED ON THE FIRST AND THIRD FRIDAYS OF EACH MONTH

J. J. CASSIDY, . . . . . Editor.  
 C. P. CLARK, . . . . . Associate Editor.

Subscription; \$1.00 per year.

ADVERTISING RATES;

\$12.00 Per Column inch per year; Thirty inches to Page.

**The Canadian Manufacturer Publishing Co., Limited.**

McKinnon Building, Cor. Melinda and Jordan Str., Toronto.

J. J. CASSIDY, . . . . . President and Treasurer.  
 J. C. GARDNER, . . . . . Manager and Secretary.

OFFICERS OF

THE CANADIAN MANUFACTURERS' ASSOCIATION

President, . . . . . D. W. KAIN.  
 First Vice-President, . . . . . J. F. ELLIS.  
 Second Vice-President, . . . . . JAMES KENDRY M.P.  
 Treasurer, . . . . . GEORGE BOOTH.  
 Chairman Executive Committee, . . . . . R. W. ELLIOT.  
 Chairman Tariff Committee, . . . . . W. K. McNAUGHT.  
 Secretary, . . . . . J. J. CASSIDY.

SECRETARY'S OFFICE: McKinnon Building, Cor. Melinda & Jordan Sts., Toronto.

CANADIAN INDUSTRIAL LEAGUE.

President, . . . . . JAS. KENDRY, M.P.  
 Secretary, . . . . . J. J. CASSIDY.

WOOLEN MANUFACTURERS' ASSOCIATION

President, . . . . . B. ROSAMOND, M.P.  
 Vice-President . . . . . JAS. KENDRY, M.P.  
 Secretary, . . . . . J. J. CASSIDY.

KNIT GOODS MANUFACTURERS' ASSOCIATION

President, . . . . . JOHN PENMAN.  
 Vice-President, . . . . . JOHN HEWTON.  
 Secretary . . . . . J. J. CASSIDY.

CARPET MANUFACTURERS' ASSOCIATION

President, . . . . . JAMES P. MURRAY  
 Vice-President, . . . . . ROBERT DODDS.  
 Secretary, . . . . . J. J. CASSIDY.

GLOVE MANUFACTURERS' ASSOCIATION

President, . . . . . W. H. STOREY.  
 Vice-President, . . . . . A. R. CLARKE.  
 Secretary, . . . . . J. J. CASSIDY.

REPRESENTATIVES TO

TORONTO INDUSTRIAL EXHIBITION ASSOCIATION

R. W. ELLIOT. . . . . GEORGE BOOTH.  
 W. K. McNAUGHT. . . . . A. E. KEMP.  
 J. J. CASSIDY.

CANADA'S MILITARY POSITION.

Sir Michael Hicks-Beach, Chancellor of the Exchequer of Great Britain, said in his Bristol speech that Canada should contribute toward the naval defences of the Empire. He ridiculed the idea of providing granaries against the day of war and expressed his conviction that the British navy was strong enough to hold its own, and in any war England would have many friends ready to supply corn. The budget estimates would show that the government were keeping up the standard of the army and navy, but it was not creditable to Canada

or fair to English taxpayers that such a colony should contribute nothing to the defences of the Empire. He hoped Canada would soon turn her attention to this matter, adding that he was convinced that if she did not the day would come when she would have "a rude awakening which would be entirely her own fault."

Opposed to Sir Michael Hicks-Beach are the opinions and ideas of Hon. Joseph Chamberlain, who has always encouragement to offer to the formation of an imperial customs union including the whole Empire. At Liverpool, not long since, the Secretary for the Colonies spoke out in no uncertain terms of Britain's isolation which might again become a feature of Europe should Great Britain find it necessary to take action alone in Eastern matters.

In the same speech he referred to the closer union of the Empire of which he spoke as follows:—"It may be in the shape of a commercial union or Imperial Zollverein, which I don't think so absurd as some political economists believe, or it may be in the shape of some Imperial council." Evidently he has made up his mind that the grain supply of England is not as certain as Sir Michael Hicks-Beach would have us believe. Mr. Chamberlain referred also to the Canadian Pacific Railway, which, he said, was a magnificent enterprise and one which provides Britain for the first time with a strong trump card in the interesting game of nations, now being played in the far East.

It is interesting to note the difference between these two great Englishmen. The Chancellor of the Exchequer must surely have spoken without thinking when he said that Great Britain would always have enough nations friendly to her to supply her with corn. Surely he is not so young that he has forgotten the bread riots among the British cotton-mill operators during the civil war in the United States. England learned a lesson from that and promptly established another source of supply, by government encouragement, in Egypt, whence large quantities of cotton are exported to England, and even to the United States to-day. But if England's working men suffered to such an extent, from the effect of a war in which England had no part, what would be the result in event of a war in which the United States prohibited the export to England, not only of cotton but of those grain, fruit, and meat supplies which Great Britain now secures from the United States? Sir Michael Hicks-Beach should at least have explained the food-producing status of the grain exporting countries of the world, and proved that he knew something of the actual conditions, instead of making a bald statement such as he is credited with.

It may be that Sir Michael Hicks-Beach does not consider it within the bounds of possibility that the United States will ever take up arms against England. That so close a student of affairs as Sir Michael should make such an egregious mistake seems scarcely possible, but his conclusions as to England's food supply seem to leave room for no other view of his reasoning. In the light of editorial and oratorical utterances in the United States there is no doubt that, if such be Sir Michael's opinion, he is entirely at sea with regard to the situation. The action of the present government at Ottawa may be considered, perhaps, as rather conducive to such a misunderstanding of the relations of Canada and the United States by the statesmen of Great Britain. It is not to be wondered at, if the presence of Sir Wilfrid Laurier, the

premier of Canada, and Sir Louis Davies, in the capital of the United States leads to curious misapprehensions regarding the relation of two countries between whom such action would hardly be expected unless they were on terms of the most intimate good will. Thus even Sir Michael Hicks-Beach may be pardoned if his remarks at Bristol were due to his misconception of the real state of affairs between the two nations that occupy the North American continent.

As a matter of fact, if a new regiment of volunteers is organized in Canada, the press of the United States shouts its displeasure at these hostile manifestations. If we have a quick-firing cannon, much less a battery of them, sent out to us by the War Office that our artillerymen may learn its use, we are planning an invasion into the United States. And when the Martini-Henry gave place to the Lee-Netford, General Miles (who is Uncle Sam's chief military shouter), appealed to Washington for permission to mobilize the regulars and put his volunteers into training in special drill in readiness for campaign.

Of course, if a company of American soldiers are allowed by the Canadian government to carry arms in Canada in an expedition to relieve suffering from starvation in the Klondike that is all right, although many Canadians insist that the American flag should not then have been carried by a force of armed men into our territory, yet no great outcry has been made about it in Canada, when there might well have been. Of course, when the Canadian authorities allowed the Yantic to reach Detroit and the Great Lakes by way of our canals that was a mere matter of courtesy which the United States had a right to expect of us. Of course, the two big steel cruisers of 900 tons each, which the United States is building on Lake Erie are not a menace to Canadian trade. They are merely for revenue purposes, even though they are a direct infraction of the lake navy treaty of 1812, under which one vessel of one hundred tons is all that either Canada or the United States may maintain on any of the Great Lakes. Of course, it does not mean any menace to Canada when American journals refer to these two vessels as armed commerce destroyers of a formidable type. Oh, no, the United States is not in the least degree unfriendly to us.

There is just one point more. Mr. Chamberlain referred to the Canadian Pacific Railway as a trump card for Great Britain in the game of nations now being played in the far East. In this he was undoubtedly correct if he referred to trouble between Great Britain and any of the European or Asiatic powers with the United States passive. But he reckoned without his host if he for one moment expected that the United States would for twenty-four hours delay to advance on Canada if Great Britain's attention were engaged by a declaration of war from some other quarter.

That the above statement is not foundationless is easily able of proof. A railway has been proposed to connect Toronto with James Bay, the extreme lower portion of the big body of water known as Hudson Bay. The railway is proposed as a measure of development which will open up and colonize a great new country and bring its trade down to Toronto instead of to Montreal. The city of Toronto supports it for the latter reason, and the Province of Ontario has granted it \$270,000 for the former reason. The first idea of the road as a military road never entered the heads of its

promoters. Immediately upon the announcement that the road would be built, what do we find? Simply this, that the United States has entered into negotiations with Denmark and proposes to secure a foothold for the Stars and Stripes upon the bleak shores of Western Greenland. Of course it is merely to establish a station for their whaling ships that cruise in Hudson Bay, but how is it that American ships have cruised this many a long year in those same waters and the American government has never seen fit to take such deep interest in their welfare before. Doesn't it seem rather peculiar that they should take this step immediately upon the announcement of the James Bay Railway?

The proposed railway would run at right angles to the other main railway lines in Canada. It would thus be practically out of the reach of United States invading troops. The north end of it would reach the salt water where Great Britain's ships could discharge their cargoes into the trains for five months of the year. Thus a very valuable route would be opened for the landing of a force of British regulars and munitions of all kinds within the Canadian lines and in such a central position that rapid mobilization to different parts of the Dominion would be possible. And the route that would admit shiploads of men would also serve to empty Canadian grain into the granaries of Britain.

Perhaps the action of the United States may be clearer now in the light of these facts when reference to the map shows plainly that the vantage ground the United States asks in Greenland is simply intended to serve to command the entrance to Hudson Bay. The friendliness of the United States to Great Britain, no less than to Canada, is plainly indicated by the rapid move the Washington Government made to secure this strategic point.

We are always glad to read the utterances of Hon. Jos. Chamberlain on Imperial and colonial trade. We regret that Sir Michael Hicks Beach does not seem to us to be correct in his conclusions. We have spoke thus much to mitigate the justice of our plea. We desire to take exception to Sir Michael Hicks-Beach's statement as to Britain's food supply, and at the same time to point out to Mr. Chamberlain the importance of the James Bay Railway in view of the attack which the United States will some day undoubtedly make upon Canada. If England confers upon Canada the benefit of an Imperial customs union Canada will supply her motherland with food and the question of our contributions to the naval fund of the Empire will be simplified so that Canada's purse will willingly be opened. British statesmen do not understand the conditions in North America and they should not for one moment deceive themselves into believing that Canada is safe without due preparations to oppose any interference with her by force of arms from the United States. Canadians realize the protection the British navy is to Canadian interests at home and abroad. Canada will not object to paying her share of the expense of the navy. The question of how that share shall be fixed—whether upon a basis of population or a basis of trade—will be the main point at issue. Sir Michael Hicks-Beach's position is, broadly speaking, sound on this question. But his theory as to the food supply is scarcely tenable. A conference between himself and his colleague, the secretary for the colonies, might be productive of good results in the change of Sir Michael's views.

## SAYS THE BEAR TO THE EAGLE.

The Grand Duke Paul, of Russia, is said to be at the head of a political party that aims to recover Alaska from the United States. Little was cared for or thought of Alaska in St. Petersburg until the startling news about Klondike burst upon the Russians. That an empire containing an unknown amount of gold should have been sold, or, rather given away, for \$7,000,000, is said to have made many of the Russians regret their bargain. Grand Duke Paul is said to be locking up the records of the deal very thoroughly, hoping to find a flaw in the transaction upon which to base a claim.

The present advancement of Russia and the well-known endeavors of her statesmen to help her along in the march of commerce is an argument for the truth of this statement. Russia is, and has been, sending men all over the world to study commercial, industrial, and agricultural systems. Her emissaries have visited Canada and, especially in the agricultural work, found much to interest them. Tremendous inducements are being held out to expert mechanics and electricians to establish in Russia, and protection is the weapon that the Czar uses to keep foreign competitors from hindering Russia's industrial progress.

With all this exertion for advancement it is not strange that Russia should cast covetous glances toward her one-time possession in North America. Alaska has never been explored until within the past few years. Travellers have described the arctic beauty of this rugged peninsula and told tales of the wealth supposed to lie concealed in its rocks, but not till within a year past has the hardy gold hunter revealed bleak Alaska to us as a treasure-house so rich that Klondike is a more pointed metaphor than Golconda or Eldorado. From every quarter of the earth bands of prospectors are wending their way to the golden rivers of the far north. Klondike was but the beginning and this Canadian gold country undoubtedly will be many times duplicated in Alaska as well as in Canadian territory. The Russian authorities have not by any means remained unaware of this, and so to-day the announcement that they are seeking to recover the prize that slipped from their grasp bears prima facie circumstantial evidence of its reliability.

The situation is charmingly uncertain. If Russia's mind is made up to obtain possession of Alaska then the slightest pretext will be seized upon to occupy that country. The United States may blow and bluster as much as it likes Russia has never been noted for that sort of conduct. The United States has made almost threats against Great Britain whose enemy Russia is by force of the policy of these two nations in Southern Asia. Russia's possible embroilment with Great Britain has been awaited by the United States as an opportunity to put Canada to the bother of teaching our southern neighbors a salutary lesson. With Russia antagonized to Uncle Sam, the case would be very much altered by the circumstances and the whole eastern question would have to be remodelled carefully before it would be at all possible to compute its reckoning. The relations of the great powers would be changed (save the word) beyond expression, and North America would become the centre of attraction.

In many ways it would be interesting to study the situation and the effect upon a certain North American republic

in the end would probably be very desirable. The country that preaches Monroe doctrine—sometimes without knowing what it is—and at the same time interferes in Venezuela and Hawaii and scarcely would keep its hands off Cuba, were it not for its fear of Spain, would have a chance to demonstrate its national importance to the top of its bent. The trouble would begin with Russia's statement of her claim. Then after its national custom, the United States would set up a cry against such proceedings and utter loud threats, or, perhaps, send an official ultimatum to the Czar condemning his infraction of the Monroe doctrine. After a time the Washington authorities would awaken to the necessity of more military protection in Alaska and troops would be forthwith despatched in great haste. It is more than probable that they would be welcomed by Russian cannon when they reached the north; that is the Bear's way of doing business.

Then there would be some fighting. Russian ships would bombard the cities of the Pacific coast and some fine morning the residents of Gotham would awaken to find their brown stone houses tumbling about their ears and great guns awakening the echoes from the Battery to Harlem. Where it would all lead to is a problem for a more prophetic pen. Invasion of the United States by Russia, or of Russia by the United States, would be scarcely to be expected by reason of the vast extent of territory of each. No other European nation has any great fondness for Russia and any assistance would not likely be forthcoming. Were it otherwise, the United States, like China, might be the cause of its own partition among the great nations. As it is, we would be far more likely to see Alaska handed over to Russia and the United States subside into its own "class" and cease for the next few years from its intermeddling in affairs that are not its own.

In event of difficulty over Alaska such occurrences might easily be precipitated by rash action at Washington, for it is scarcely likely that Russia would be as considerate for the United States as England has shown herself to be. We do not desire to be understood as indicating that Russia would have any just claim but simply as pointing out the effect that a war between Russia and the United States would have upon the eastern question, and that, comparatively speaking, much good might result if the seat of trouble were transferred from China to Alaska.

## OUR MINERAL WEALTH.

The points laid before the Ontario Cabinet, by the deputation of those interested in mines, who waited on them recently, are well worthy of careful consideration. In brief, the requests were to the effect:—

That the Department should issue quarterly, or oftener, an official report of the progress of mining development in the Province;

That the annual report of the Bureau of Mines, or a summary of it, be issued at an early period of the year;

That the mineral resources of the Province be advertised in Europe, and especially in London, through the medium of official information to be collected and supplied the leading newspapers there by a competent person;

That a representative exhibit of Ontario ores be located in a prominent place in London ;

That pamphlets be supplied for distribution among capitalists, investors, and the public generally ;

That statistics of producing mines, showing the actual output value and cost of production, be published by the Department from time to time.

Let us for a moment consider the questions raised by the deputation. The desire to have a more frequent statement of the progress of mining is natural and just. The last annual report of the Department of Mines was many months behind time in its issue to the public. It should be hastened, that those waiting for it may receive it on time. This, of course, will necessitate more help for the Department, but could not economy be effected by the excision of those portions of the report that cause experienced miners to smile at what they will tell you is very apparent lack of knowledge displayed in large type, with all the stamp of authority? If the summary of the report were issued there would be absolutely no need for the extended report which occupies four times as much space as is necessary.

Advertising the mineral resources of the country in Europe is a project with which we are thoroughly in accord. The more general knowledge of Canada becomes in the Old Land the better for Canada. Anyone reading British newspapers will appreciate the ignorance they display of Canadian affairs. Mining is not the only resource of Canada that should be laid before them accurately, but it is one that requires careful handling and that we cannot afford to allow to be misrepresented. Therefore, the idea of official advertisements in European advertising mediums would seem to be first-class. A natural complement of this is the establishment, in London, of an exhibit of our ores in more prominent thoroughfares and the announcement of this exhibit, so that the British public may easily become acquainted with our minerals. The exhibit should be in charge of a man who is both scientific and practical, that the fullest possible information should be at the command of all visitors.

The publication of pamphlets should be in connection with the exhibit, and the official information supplied to newspapers should direct attention both to the exhibit and to the pamphlets. Broadcast distribution of pamphlets is too indiscriminate to be of any use as an advertising expedient. The man who is the recipient of unsolicited pamphlets in his daily mail is more likely to pitch them into his waste basket than to read them. Connect the pamphlets with the exhibit. Interest people to send for them, and by such the pamphlets will be read. Otherwise they are absolute waste of paper and ink.

As to the last clause of the proposition. The statistics in question should be contained in the quarterly reports. There is no need to make separate provision for statistics apart from them. There is no reason for making it. And it should not be made.

To sum up. In a rough way the proportions indicate the lines along which there is need for work. There is just one caution necessary. Don't make any assertions that will cause the experienced miner to look askance at us. Don't let any inaccuracies creep in. Don't make any pretensions to anything out of reach. Don't exaggerate. Don't be nigardly. Don't be extravagant. What we want is, to have our mineral resources developed, and any deviation

from the truth, the whole truth, and nothing but the truth, is not going to aid our work in that development. Above all, impress upon everyone that it is absolutely necessary to find out, each for himself, the reliability of any mining concern, no matter what names are coupled with it. It is not within the province of Ontario to go further, but it would be well to point out that the investor need not expect to find an Eldorado, unless he couples business, judgment and common-sense with his investment. Many Ontarians who were badly bitten in the British Columbia boom harbor no kindest feeling toward the Ontario newspapers that led them into the speculation. Whatever the province does toward making our mineral wealth a productive asset, it should be careful to take no action that will ever result in the loss of the confidence of the investor.

#### NEW ROUTE TO THE YUKON.

Any difficulties that have arisen or may arise between Canada and the United States as to access to the Klondike district are shortly to be effectually cleared away. American miners object to paying duty on their outfits to the Canadian authorities and some American newspapers have threatened that the Alaskan ports would be closed to Canadians who desired access from that direction to the gold fields. The carrying out of the arrangement the Dominion Government has made with Messrs. McKenzie and Mann will entirely obviate any necessity for the use of the trans-Alaskan route, and, in fact, it is more than likely that American miners will journey by the Canadian route to the Klondike in preference to taking the route now used which takes so much time to travel and is so full of hardships.

A railway is to be constructed from Stickine River, near Telegraph Creek or Clear Water River, north to Tesline lake, a distance of about 150 miles. This will make connection by rail with the Lewis River which is in reality the Yukon. This will make an all Canadian line by railway and steamboat clear in to the gold fields, and it is to be in operation by the first of September of this year. A feature of the agreement is that a sleigh road equipped with shelters every twenty-five miles must be completed from the mouth of the Stickine River to Tesline lake within six weeks, and a steamboat line is to be established forthwith so that there may be no delay when navigation opens.

We are speaking, not as to the method by which the Government secured the arrangement, or to the condition of the arrangement, but with regard to the result of the completion of the work from the standpoint of benefit to Canada. The completion of such a through way to the Klondike was a necessity—and an immediate necessity. There was no time to lose and, whatever objection anyone may take to the mode of procedure, the end attained will surely receive general endorsement. It means simply this—that Canada by it wins a great point of vantage in the industrial campaign that the United States has chosen to inaugurate against us. The time from Toronto to Dawson City will be reduced to less than two weeks and the Chilkoot and White Passes may be erased from the map.

But the special beauty of the idea is apparent when we stop to consider that the great American republic have no route by which they can run a railway across Alaska country

to compete with ours. The only route possessing equal facilities for a comfortable trip is that by way of St. Michael and the Yukon. Inasmuch as that would be about equal to a steamer trip from Halifax to Vancouver, it is hardly likely to become a serious competitor to the Canadian route which can land you in Dawson City in a few days' time.

Canada is on the eve of a great march ahead. In these columns we have again and again said so. Here is another instance that substantiates our belief. Stand by to lay hold. Then a long pull, a strong pull and a pull all together, and we can land Canada away in front of her competitors.

### THE PRESBYTERIAN REVIEW AND THE MANUFACTURERS.

The columns of this journal are open for use in what we, rightly or wrongly, hold to be the best interests of the manufacturers of the Dominion of Canada. Practice, not ethics, is rather our aim, and it is noteworthy that a practical, rather than ethical, course, will often attain a better ethical result than the pursuit of the ethical method. Abstruseness is dear to the metaphysical mind and the Scotchman is essentially metaphysical. Thus we are not surprised to find The Presbyterian Review, under date of January 20th, dealing in its own abstruse and dignified style with the Lord's Day Act amendment that was laid before the recent session of the Ontario Legislature and with the opposition thereto by sundry gentlemen who do not see eye to eye with the Lord's Day Alliance.

In the course of its deliberate and dignified remarks The Review made some references to the manufacturers who opposed the bill. Now, as we premised, we are not given to dealing largely in abstractions. The Review's logical, analytical, argumentative method of handling the subject is on a plane which we scarce need say is far above our power of reply in like style, so our contemporary will pardon us if we deal with its remarks in our own plain, unpolished fashion. Were our ability great enough to warrant it we should scarce feel it becoming of us to attempt an argument upon the extremely high and liberal ground The Review has taken, but nevertheless, we propose to say something in our own quiet way.

To begin with, The Review speaks of the deputation as consisting of—

Advocates of the Amendment, representing the Lord's Day Alliance, and of opponents to that measure, representing various corporations—railways, breweries, blast furnaces, etc.

As a matter of fact the hearing was arranged for by Mr. Walter Barrick, Q.C., who acted on behalf of those opposed to the Amendment. The Lord's Day Alliance representatives were intruders upon their own responsibility and were present only by the toleration of the deputation and the Government. So much for the first inaccuracy. It pains us to point out such little things but they only go to show that even metaphysical minds are not always logical. The next remark of The Review is in reference to the representative of the blast furnaces at Hamilton, who happened to be Mr. A. T. Wood, M.P., and who pointed out to the Government that the blast furnace at Hamilton would have to be closed down if the proposed law were carried out. The Review says:—

The latter raised a hue and cry which not inaptly reminds

a contemporary of the scene at Ephesus when the silversmiths clamored against the Gospel preached by Paul, fearing it would wipe out the trade in silver shrines. The Diana of the corporations is influential in Ontario and the appeals of her interested votaries received an attention more respectful than their merits warranted.

The evident intention is that the Lord's Day Alliance shall be compared to Paul but the reference is rather not apt than not inapt, inasmuch as Paul would have suffered no personal loss or inconvenience had the trade in silver shrines been destroyed, while the Lord's Day Alliance might find difficulty in paying itself salaries for preaching were the manufactories suddenly stopped and the contributions of the employer and the employe subtracted from the collection plate. The logical process of reasoning by which The Review reaches the conclusion that the appeals of Diana's votaries "received an attention more respectful than their merits warranted" is, of course, beyond confutation, although we must confess that our ethics are not subtle enough to make us quite clear as to why any action of the community should not receive the most respectful attention whenever it became necessary to lay any matter before the Government. But our contemporary says "nay! not so," and we must defer to its conclusive argument.

The next portion of The Review's argument is so characteristically clear, so logical, and places the whole question before the reader in such moderate language and yet in such terms as leave no doubt of The Review's idea of the case that it scarce needs comment. We always like to see due moderation displayed in discussion, and dislike calling names. We are glad that The Review is so free from any imputation of dogmatism and looks upon this question so liberally. Its high literary character and the mollifying influence of the Church with which it is associated would naturally be expected to produce results of a very high class and we congratulate our contemporary on having kept itself so well in hand and dealt with the subject in such a way as it has. It is so eminently fair and so plainly desires to prove each statement that its work is refreshing to us and we would commend it as an example of brotherly love and toleration to other theological journals that they may not be tempted to use nasty epithets, to make insult and insinuation, or to make statements that are inaccurate and incapable of proof. Again we quote:—

The extreme position assumed by the corporations was nothing short of ridiculous. The indignation affected was absurd. The empty threats given utterance to were impertinent, and the patience of the ministers under the down-pour of unseemly tirade was simply surprising. For down-right audacity commend us to such corporations. The world and all that it contains was created for their exclusive use. Man was made to be their slave, without rights, liberties or privileges. From the scope and application of the moral law they have been excluded, and it would be preposterous to suppose that a mere Provincial Legislature should enact laws that would place them on a level with ordinary individuals. The dictatorial tone fits such supremely-endowed people, while lording it in the haunts of ignorance or oppression, but that it was affected before the Government of Ontario shows the lengths to which effrontery will go.

The Review's remarks would indicate that it is animated by a deep and lasting affection for the truth and a desire to get at the facts. Observe these words, evidently used deliberately and advisedly to make sure that no one could lay a charge of unfairness against it:—"Ridiculous," "impertinent," "unseemly tirade," "down-right audacity," "preposterous,"

"dictatorial," "effrontery." They display Christian charity and consideration for the faults of erring fellow-men, whom The Review desires not to scourge with harsh words and destroy with scurrilous diatribe, but rather in the spirit of fellowship, and as the good Samaritan, to rescue from those who would despoil them, and bring back into the fold. It is an oasis in the desert of human nature to find such kindly thought in the mind of one toward another. True, the situation of The Review warrants us in expecting the demonstration of such sentiments for peace on earth and good-will toward men. Perpetual Christmas-tide and a continued love for, and forbearance with, their fellow-men is what we expect from Christians. That it is so seldom found makes it the more beautiful when, as here, we find it so bountifully displayed. We do not propose to say much more on this matter. The rest of The Review's recital is in the same lofty strain, and in similar words continues the proof of the falsity of the arguments put forward by the gentlemen who opposed the amendment to the Lord's Day Act. It is as clear as a demonstration of a problem in Euclid. Its lucidity is simply amazing. Read it, and doubt no longer, unless you can upset such cogent logic:—

The statements made baffle comparison as to irrelevancy and silliness. It must, at least, have been humiliating to the legal profession to find men of standing at the bar resort to arguments before ministers of the crown, which, if used before a jury of street-sweepers would be an insult to their intelligence. The most of their contention was worse than frivolous; it consisted of mock-heroics on such subjects as the personal liberty of cooks and shoe-blacks, plagiarized from the columns of a morning paper, an almost incredible performance on the part of barristers and Queen's Counsel.

As we said at the very outset we do not consider that we can meet The Review on its own ground in the discussion of this matter. It is slightly beyond us—and we are not sorry. We have endeavored to make use of no language offensive to anyone, least of all to our friend, The Review, which has dealt so fairly and honorably with the manufacturers. We leave the case with our readers. Let them decide as they will. We are satisfied to abide by that decision.

#### NEED FOR ORGANIZATION.

The new syndicate organized in the United States, including most of the big firms and with a capital of \$45,000,000, to keep up paper prices in the United States will, it is expected, slaughter prices in the foreign market to keep up the domestic figure. The old trick of sacrificing surplus in Canada and, perhaps, in Great Britain, will likely be resorted to. Canadian manufacturers should make an organized movement to secure an export duty on pulp wood; it is the only method of heading off the contemplated American antagonistic operations. Canadian paper mill and pulp mill men should form a permanent organization to protect their interests. Intermittent disconnected work will not do. A standing organization is wanted and wanted forthwith.

Manufacturers who get together and make representations to the Government occasionally, are not so seriously considered by the Government as manufacturers who are known to be always organized, always in communication with each other, and, if possible, as having an official organ through which their ideas and desires are regularly announced. The

facts stated above in connection with the pulp and paper trade should be proof of this necessity. The development of the Canadian industry in these lines has been recent and rapid until to-day a large export trade is opening up for our mills, and the mills are capable of catering to it. With the present low price the Canadian manufacturers will be obliged to increase the capacity of their paper plants and put them on a basis where they can compete in Great Britain with the American paper products.

Just a word in a general way upon this matter of organization. The occasion for organization in the paper and pulp trade is woefully apparent. Meeting at long intervals to fix prices or take other concerted action is not sufficient. They give no impression of strength or importance when they are united in such a desultory fashion and work in such a haphazard way. To carry weight they must be permanent and appear at all times. Once the general public grasps the idea that in dealing with this branch of trade they are dealing with a solid, united, co-operative organization of men who will stand by each other to secure their rights in private and in public, at home and abroad, the desired end will have been reached and the trade will be in a better position than they have ever heretofore enjoyed.

The benefits of organization of this sort are indisputable. Everyone who has had practical experience with a manufacturer's association of the right kind, run in the right fashion, will attest the truth of that statement. The Buffalo Express, for example, makes the following remarks in its recent Saturday edition:

The third annual convention of the National Association of Manufacturers, which is being held in New York this week, should be an event of interest to the public as well as to the members of the organization. The association has been in existence for three years and it has grown in strength and importance during that time. Its objects are divided into two main divisions, domestic and foreign. Those which pertain to home interests are the conservation of the American market, the creation of a Federal department of commerce and industry, the improvement of patent laws, the unification of railroad freight classification, the enactment of a uniform bankruptcy law and the improvement of internal waterways. The foreign work is embraced under the following heads: The investigation of markets, the establishment of sample warehouses, the improvement of the consular service, the restoration of the American merchant marine and the negotiation of reciprocity treaties. This programme is well calculated to have a distinct influence upon the steady development of the manufacturing interests of our country. It is a comprehensive scheme, which does credit to the intelligence of the men who have formulated it.

As to the creation of a Federal department of commerce and industry we are a step in advance of our neighbors to the south, but in the other regards we could stand some organization for improvement. We, of course, have no consular service but instead of it we should have a widespread system of trade commissioners whose duty should be to send full particulars of every possible chance for increasing our export trade. These reports should be condensed and compiled at Ottawa and issued monthly so that they might be easily and quickly accessible to the manufacturers who desire to profit by their contents.

As to insolvency and waterways they are both live questions in Canada. The necessity of an insolvency law is very great and some have even gone so far as to say that British capita-

lists have been and are prevented from investing largely in Canada because of the very poor provisions we have in this regard. The question of deep waterways has been discussed from time to time in these columns and our readers are well aware of the importance we accord this problem. We see the National Association of Manufacturers of the United States convening even after an election which meant the enactment of proper protective laws and the return of prosperity. Although matters are moving well with them they are not satisfied. Their dissatisfaction is commendable. It is the sort of dissatisfaction that leads to action and action leads to results.

Canada wants more of that sort of action. The action that resulted five and twenty years ago in the organization of the American iron and steel manufacturers meant much. When that organization was effected none of its organizers would have dared prophesy the success that has rewarded its work. To-day its members look back with pride upon the splendid work it has accomplished in the past for the trade it represents, and look forward confidently to even better results from future work undertaken with an assurance derived from the experimental work which has led up to present results. In Canada we have the men. We have the material. We have every natural advantage that could be asked for. Give us not inertia but action.

"There is a tide in the affairs of men which, taken at the flood, leads on to victory."

Canada's era of development is at hand. She is just at the dawn of a day of prosperity which will grow as Canada successfully holds her own in the great industrial struggle. We must not forget that in the light of the experience of manufacturers associations in the United States we can obtain the best results only by organization. Indeed we do not need to go so far afield as that for evidence. The time is not so far distant as to be beyond memory when The Globe recognized the influence of the Canadian Manufacturers' Association in tariff matters—such an extent as to condemn it—unjustly of course—as corrupt. Organization means success. Disorganization means failure.

Pardon us if we revert for a moment to the National Association of Manufacturers and, by way of conclusion, present the following excerpts from Bradstreet's remarks with regard to it in the issue of January 29. Bradstreet's says:—

Nothing is more significant of the changed attitude toward this country's foreign trade, manifested by the American manufacturer to-day as compared with a few years ago, than the almost single devotion which he pays to the subject of possible export-trade extension. The discussion of ways and means for extending this country's trade, and more particularly its export business was, in fact, almost the single theme of the speakers at the third annual convention of the National Association of Manufacturers, held at New York this week. . . . The gain in exports of manufactures in 1896-97 over the preceding year was about \$48,000,000, or 21 per cent. Figures read showed further that, with the exception of the year 1865, the proportion of manufactured goods to total exports was larger in 1896-97 than in any preceding year in our history. . . . American manufacturers to-day, unlike some years ago, pay considerable attention to orders received from foreign countries and take pains to see that the goods supplied are in accordance with the orders given. It is only fair, in fact, to give to American manufacturers credit for learning something from adversity, and if, as seems probable, willingness to cater to foreign customers' wishes has been followed by substantial recognition in the shape of orders, the

American manufacturer stands in little need of self-congratulation. . . . The president's report showed a flourishing condition of the association itself. The membership was reported to be steadily increasing. The president pointed out, however, that what was originally a . . . association of manufacturers has gradually developed into a great business institution, conducting operations in many parts of the world, requiring a large staff of trained workers and ample funds for the conduct of its work. The president wished to impress upon the members the imperative need of more funds for carrying on the work of the association. The need of further increasing the membership was emphasized in this portion of the address.

The result of the work of the National Association of Manufacturers is apparent in the increased export of manufactured products. That it is not accomplished by talk is evident from the quotation above. It means hard work and heavy expense but surely that needs no more justification than the announcement that the past year's exports of manufactured products were valued at \$48,000,000 more than those of the year previous. If Canadians would work as hard they might attain as good returns. Once more let us impress the idea—organize, discuss, decide, work and you shall not need to wait long for a big dividend.

#### EDITORIAL NOTES.

Messrs. B. Tooke and J. C. Skelton, of Montreal, and W. A. Greer, of Berlin, recently waited on Hon. W. S. Fielding and pointed out that under the new tariff a duty of thirty-five per cent is placed on linens and cottons used in the manufacture of shirts while the duty on the manufactured collars and cuffs is at the same rate. This removes all protection from Canadian shirt makers and the deputation ask relief. The result of their request will be made known in the budget speech.

Reports received at Ottawa indicate that South Africa wants lumber and that Canada may find sale for a large amount of her finest products on the Dark Continent. And yet the United States keeps on telling us we cannot possibly manage to get along unless they buy our logs. Nothing but the blindness of their own conceit keeps them from appreciating such facts as the above.

It is interesting to note the rate war between the United States Railways and the C.P.R. on flour freight from Minneapolis to the seaboard. From ten cents the American roads cut the rate to seven. The C.P.R. also cut to the same figure. Then the American roads dropped another cent. To say they were surprised when the C.P.R. followed suit is putting it mildly. And the end is not yet, nor will be till the American lines understand that Canadians are not by any means taking a back seat with them in competition for the railway trade.

Canada is truly a great country, and has reason to be proud of being the birthplace of the patriot, Washington.—Le Petit Parisien.

Our French contemporary is even farther at sea in his knowledge of America than some of the journalists of Great Britain, which we would have deemed impossible had we not seen it.



# Mechanical, Electrical and Scientific Books

- A Practical Treatise on Hydraulic and Water-Supply Engineering.** By J. T. Fanning. 188 illustrations. 8vo, cloth, \$5
- First Principles of Electricity and Magnetism.** By C. H. W. Biggs. 12mo, cloth, illustrations.....\$1.40
- Handbook for Mechanical Engineers.** By Henry Adams. Fourth edition, revised and enlarged. 12mo, cloth.....\$2.50
- A Handbook on Modern Explosives,** Being a practical treatise on the manufacture and use of dynamite, gun cotton, nitro-glycerine and other explosive compounds, including the manufacture of Colloid-cotton, with chapters on explosives in practical application. By M. Eisler. 12mo, cloth.....\$5.00
- One Hundred and Fifteen Experiments** On the carrying capacity of large riveted metal conduits up to six feet per second of velocity of flow. By Clemens Herschel. 122 pages, cloth.....\$2.00
- Fetting Gold.** A practical treatise for prospectors, miners and students. By J. C. F. Johnson. Illustrated, cloth.....50c.
- Practical and Electrical Measurements.** An introductory manual for young engineers and students. By Ellis H. Crapper. 125 pages, cloth.....75c.
- Stamp Milling of Gold Ores.** By T. A. Rickard. Cloth, illustrated.....\$2.50
- The Manual of American Water-Works,** 1897. Containing the history and descriptions of the source and mode of supply-pumps, reservoirs, stand pipes, distribution systems, pressures, consumption, revenue and expenses, cost, etc., of the water works of the United States and Canada. By M. N. Baker. Compiled from special returns. 611 pages, cloth.....\$3.00
- Motive Power and Gearing for Electrical Machinery.** A treatise on the theory and practice of the mechanical equipment of power stations for electric supply and for electric traction. By Tremlett E. Carter. 8vo, cloth, illustrated, \$5
- The Mechanical Engineering of Power Plants.** By F. R. Hutton, E.M., Ph.D. 725 pages, cloth.....\$5.00
- Practical Application of the Indicator.** With reference to the adjustment of valve gear on all styles of engines. By Lewis M. Ellison. Second edition, revised. 8vo, cloth, 100 illustrations.....\$2.00
- Electric Transmission of Power.** By L. Bell. 448 pages, illustrated, diagrams, cloth.....\$2.50
- Machine Drawing and Design for Technical Schools and Engineer Students.** Being a complete course of instruction in Engineering Drawing, with notes and exercises on the application of principles to engine and machine design, and on the preparation of finished colored drawings. By William Ripper. Illustrated by 55 plates and numerous explanatory drawings. 4to.....\$6.00
- Concise and Practical Explanations for plumbers, tanners and hardware dealers on how to wire buildings for bells, alarms, annunciators, and for gas lighting from batteries.** Illustrated with twenty-two diagrams. By William A. Wittbecker. Price in paper 25 cts.; price in cloth.....50c.
- Electro-Plating.** By J. W. Urquhart. 226 pages.....\$2.00
- Steam Heating for Buildings, or Hints to steam fitters.** While this book bears the same title as the original book, by Mr. Baldwin, it is in fact an entirely new book having been re-written, reset, and brought up to date. 350 pages, 12mo, cloth, \$2.50
- First Principles of Mechanical and Engineering Drawing.** A course of study adapted to the self-instruction of students and apprentices to mechanical engineering in all its branches, and to the use of teachers in technical and manual instruction schools. By H. H. Butterfill. With upwards of 350 diagrams in illustration of the principles of the subject. 8vo, cloth, \$3.
- A Systematic Treatise on Electrical Measurements.** By Herschel C. Parker. 8vo, cloth, illustrated.....\$1.00
- Localisation of Faults in Electric Light Mains.** By F. C. Raphael. 8vo, cloth, \$2
- Hydraulic Machinery.** With an introduction to hydraulics. By Robert G. Blaine. 8vo, cloth.....\$5.00
- Motive Power and Gearing for Electrical Machinery.** A treatise on the theory and practice of the mechanical equipment of power stations for electric supply and for electric traction. By E. Tremlett Carter. 650 pages, illustrated, cloth.....\$5.00
- The Practical Management of Engines and Boilers.** Including boiler setting pumps, injectors, feed water heaters, steam engine economy, condensers, indicators, slide valves, safety valves, governors steam gauges, incrustation and corrosion, etc. A practical guide for engineers and firemen and steam users generally. By William Barnet Lo Van. 49 engravings. 268 pages.....\$2.00
- Steam Boilers.** By C. H. Peabody and E. F. Miller. From preface:—"In this book we have attempted to give a clear and concise statement of facts concerning boilers, and of methods of designing, making, managing and caring for boilers." 350 pages, 142 illustrations and folding plates, 8vo., cloth.....\$4.00
- A Complete Treatise on the Electro-deposition of Metals.** By G. Langbein. 430 pages.....\$4.00
- The New Metal-Worker Pattern Book.** A treatise on pattern cutting as applied to all branches of sheet metal work. 430 pages, 744 illustrations, 4to.....\$5.00
- Electro-Plater's Handbook.** By G. E. Bonney. 221 pages.....\$1.20
- Mining and General Telegraphic Code.** Arranged to meet the requirements of mining, metallurgical and civil engineers, directors of mining, smelting and other companies; bankers; stock and share brokers; solicitors, accountants, Financiers and general merchants. Safety and secrecy. By Bedford McNeill, F.G.S., Mining Engineer. Associate of the Royal School of Mines, Fellow of the Institute of Chemistry. 807 pages, cloth... \$7.50
- Gems and Precious Stones of North America.** A popular description of their occurrence, value, history, arche-
- ology, and of the collections in which they exist, also a chapter on pearls and on remarkable foreign gems owned in the United States. Illustrated with eight colored plates and numerous minor engravings by George Frederic Kunz. Price.....\$10.00
- Engineering Estimates and Coal Accounts.** By Francis G. Burton. 12mo, cloth.....\$1.50
- Art of Coppersmithing.** A practical treatise on working sheet copper into all forms. By John Fuller, Sr. 327 pages, \$3
- A Practical Workshop Companion for tin, sheet iron, and copper-plate workers.** By L. J. Blinn. 296 pages.....\$2.50
- The Press Working of Metals.** By Oberlin Smith. 276 pages. 433 illustrations.....\$3.00
- Gas, Gasoline and Oil Vapor Engines.** By Gardner D. Hiscox, M.E. A book designed for the general information of everyone interested in this new and popular motive power, and its adaptation to the increasing demand for a cheap and easily managed motor requiring no licensed engineer. The book treats of the theory and practice of gas, gasoline and oil engines, as designed and manufactured in the United States. It also contains chapters on horseless vehicles, electric lighting, marine propulsion, etc. About 300 pages. Illustrated with 220 handsome engravings. 8vo, cloth.....\$2.50
- A Text Book on Roads and Pavements.** By F. P. Spaulding. 213 pages....\$2.00
- Highway Construction.** A text and reference book for all engaged in the location, construction and maintenance of roads, streets and pavements. By Austin T. Byrne.....\$5.00
- American Foundry Practice.** Treating of loam, dry sand and green sand molding, and containing a practical treatise upon the management of cupolas and the melting of iron. By Thomas D. West. Fully illustrated. 408 pages; cloth.....\$2.50
- The Practical Electroplater.** A comprehensive treatise on electroplating, with notes on ancient and modern gilding and formulas for new solutions. By Martin Brunor. 8vo, half leather, illustrated. Price reduced to.....\$6.00
- The Metal Worker's Handy Book of Receipts and Processes.** Being a collection of chemical formulas and practical manipulations for the working of all the metals and alloys, including the decorating and beautifying of articles made therefrom, as well as their preservation. Edited from various sources by William P. Braunt, 530 pages, cloth.....\$2.50.
- Painter, Gilder and Varnisher's Companion.** Twenty-seventh Edition. Revised, enlarged and in a great part rewritten. By William T. Braunt, illustrated; 12 mo; 415 pages; cloth \$1.50. This volume comprises the manufacture and test of pigments, the arts of painting, graining, marbling, staining, sign-writing, varnishing, glass staining and gilding on glass, together with coach painting and varnishing, and the principles of the harmony and contrast of colors.

Any of the above Books sent, post-paid, on receipt of Price, by

**Canadian Manufacturer Publishing Co., Limited**  
TORONTO, - CANADA

Halifax is again a port of winter call for trans-Atlantic steamers. When the Beaver line got the mail subsidy from the Dominion Government, the Dominion line discontinued calling at Halifax, but Canadian trade is so profitable that they have resumed Halifax as a port. This speaks well for the growth of Canadian trade.

The Business Men's Association, of Black Rock, N.Y., recently adopted a resolution requesting two of their representatives to support any measure providing for reduction in the present duty of \$2 per thousand feet on Canadian lumber sent into the United States. The gentlemen composing this association well deserve the title "Business Men" for they have, in this resolution, shown themselves honest in their appreciation of the fact that the increase of the American tariff on our lumber is money out of American pockets and will not take a dollar out of the pockets of Canadian lumbermen.

Prof. Robertson, of the Ottawa Central Experimental Farm, stated at the recent annual meeting of the Western Ontario Cheese and Butter Association that during the past year Canada had lost some \$2,500,000 by damage in transit to goods sent to the European market. This loss, he claims, could have been prevented had there been a cold storage shipment possible. Surely we need seek no further for a reason for the establishment of trans-Atlantic cold storage. One year's gain under the change would more than reimburse the Government of Canada for any necessary outlay toward this end. Let us have cold storage forthwith as an indispensable adjunct to our transportation facilities for the export trade.

The Seattle people are persistent boomers, and have recently been lying in favor of their route at a rate which would shame Ananias. It is perfectly safe to disbelieve any alleged information about the Klondike which comes from Seattle.—Hamilton Spectator.

The Canadian route to the Klondike will become "the" routes as soon as the facts are known. Seattle has scored one itself in grasping for everything in sight. Recent newspaper despatches from Vancouver announced that a large party of Americans from Seattle had been purchasing supplies in Vancouver. Americans will do well to remember that they can purchase at least as cheaply in Canada and that by so doing they will avoid having to pay the duty which will be levied on such goods as they bring from the United States with them.

In Bulgaria a curious, albeit reasonable, law is in force under which every person in receipt of a salary from the Government must wear shoes and clothing of native manufacture and materials. Canadian free traders will insist that this is an injustice which would not be, and should not be, suffered by any self-respecting person. Let them look back to the history of those days in Great Britain whence arose Great Britain's commercial success and note how many more severe laws they will find in the British statute books of those days.

The decline in Great Britain's exports during 1897 was £5,795,000. Which we just mention in passing that our free trade friends may not overlook it in their search for arguments in support of Britain's continuance of her present policy.

Germany is rapidly forging to the front as an industrial country and no small part of her development is due to dexterous and unscrupulous imitations of standard articles. These imitations are scattered all over the world and sold for prices greatly in excess of their real value, and just at reduction enough from the value of the original article to pass with the in-expert as first-class goods at a bargain rate. The poor quality of the German imitation proves it worthless and in many instances tends to destroy the reputation of the standard article. The steamer City of Boston recently brought to Canada 60,000 pairs of German skates, most of which were imitations of the Acme skate of which the Starr Co., of Halifax and Dartmouth, are makers. This but adds force to our frequent contention that we should, by law, have "made in Canada" stamped on all manufactures, and make it a heavily penalized offence to import goods stamped with that mark, or to so stamp goods after they are imported.

The Board of Trade of Leamington, Ont., have acted wisely in their move to impress upon the Canadian government the many reasons why natural gas should not be, as it now is, exported from South Essex to the United States. About five hundred residents of Leamington, Kingsvills, Ruthven, Windsor, Chatham, and the townships of Gosfield South and Menga are expected to take part in the deputation. Those who understand the situation are very strongly of opinion that restriction should be placed on this export trade, and it is to be hoped that the deputation may be successful in inducing the Dominion government to take action toward this end.

## EMBOSSED . . . . METAL CEILINGS.

These Ceilings are made from mild annealed steel plates in a great variety of designs, suitable for every description of building, including

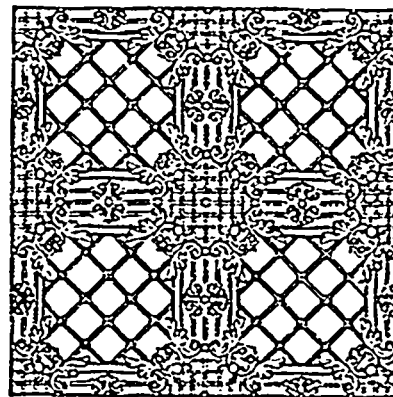

ONE OF OUR DESIGNS.

The many advantages of their use, as a modern substitute for wood and plaster, lies in the fact that they are light in weight, will not crack or drop off, consequently no danger of falling plaster; are unquestionably durable, have air-tight joints, are easily applied, are practically fire-proof, are highly artistic, do not harbor vermin or the germs of disease, and possess splendid acoustic properties in addition to many other points of excellence over any other form of interior decoration

Sole Manufacturers:

**The METALLIC ROOFING CO., Limited,**  
'Phone 5481.

Write for Prices:

TORONTO.

Hospitals,  
Churches,  
Schools,  
Convents,  
Opera Houses,  
Asylums,  
Offices,  
Stores,  
Residences,  
Etc., Etc.

In Wichita, Kansas, a club of farmers has been formed to investigate the possibilities of the Canadian Northwest as a place to emigrate to. There are 150 members and they will send representatives to examine the promised land. If the information obtained is satisfactory they will send a colony to Canada. Some of these prospective Canadians are men who are in good financial circumstances, and they will be a welcome accession as citizens of the Dominion. Canada's turn has come and we shall have many thousands more citizens in 1900.

Canadian manufacturers of paper have learned that easy is the descent to low prices. News paper, less than a year ago, was worth something nearer three cents per pound than two. Now the figure is slightly less than two cents at the mill. As a consequence of this descent, the new mills and those that have been recently equipped with new machinery, are doing about all the business, and the managers of some of the older establishments are wondering whether it was a cyclone or an earthquake that hit them. But Canadian prices will have to go a little bit lower still, if the Canadians attempt to build up an export trade in paper, and that is what they are hoping to do.—The Paper Mill.

If the necessity comes to the Canadian paper men they can do it. In the meantime if we can but succeed in preventing the supply of our pulp wood to American mills, except under

a heavy export duty, we shall go a long way towards developing Canadian paper export trade and the necessity for reduction of prices may not become so great as our contemporary appears to think.

The following despatch from Niagara Falls, N.Y., to The Montreal Star explains itself. The Star says:

The Canadian customs authorities have seized a carload of printing paper, about fifteen tons, consigned by the Otis Falls Paper Co., of Otis Falls, Me., to its Toronto, Ont., agent, Mr. Chism. The cause is undervaluation. It seems that for some time past American manufacturers of printing paper have been sending large consignments to Canada and underselling Canadian manufacturers. The market became so demoralized that the Canadians sought a means to stop this trespassing on the market; hence the step taken by the Canadian Government. The Otis Falls paper was entered at a valuation of \$30 a ton, on which duty was paid. This included freight at sixteen cents per hundred. At this rate the Americans were able to quote a price of \$42 per ton, when the Canadians were selling at \$48 to \$52 per ton. Mr. Chism offered to raise the valuation to \$32 a ton, but the Government refused to release the paper. He then raised the price to \$35, and the customs authorities at Ottawa are considering the matter. Canadian paper manufacturers are hot over the situation, and think they have succeeded in breaking up the undervaluing business.

THE - - - -

**WM. HAMILTON MANUFACTURING CO., Limited**

MANUFACTURERS OF

**THE "RELIANCE"**

**Mining, Milling**

AND

**Smelting  
Machinery**

FOR THE DOMINION  
OF CANADA

(Under License from **The E. P. ALLIS CO., Milwaukee, Wis.**)

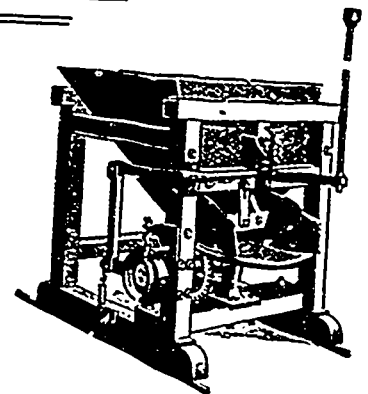
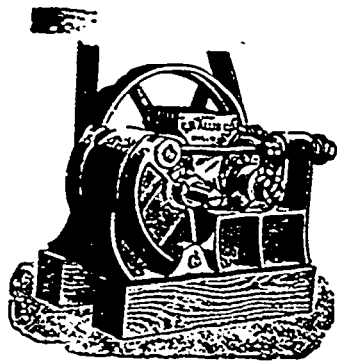

Crushers, Rolls, Jigs, Concentrators, Screens, Stamps, Pumps  
Compressors, Hoists, Boilers, Engines, Water Wheels, Etc.

Branch Office . . . .

**VANCOUVER, B.C.**

**PETERBOROUGH, ONT.**

The Export Iron and Steel Co., which is an organization of iron manufacturers of Pittsburg and vicinity, reports recent shipments of 300 tons of their wares into markets, a large part of it displacing other goods, the product of German and English mills. The company considers India its principal foreign market. How is it that the manufacturers in Canada are so difficult of impression with the necessity of organization to further their interests in foreign markets when this very practical proof of its benefits is put thus plainly before us?

Mr. Byron Brennan, the British special trade commissioner to the far East, in his most interesting report, points out a curious characteristic of the Chinese and Japanese merchants, which it will not be amiss for the Canadian exporter to remember in case he may sometime turn his attention to the Occident as a market. The Chinaman, according to Mr. Brennan, is remarkably faithful to his agreements, while his Japanese competitor is given to sneaking out of a contract upon the least pretext. Which condition of affairs appears decidedly the reverse of what one would naturally expect.

The Boston Chamber of Commerce are moving actively in the direction of securing a reciprocity treaty between the United States and Canada. The whole question has been discussed by these gentlemen and they have passed resolutions that strongly favor the enactment of a new treaty. They have memorialized the President, both Houses of Congress, and all the trade and commercial organizations they find accessible. The New Englanders always did have a reputation for being a trifle shrewder than their friends but this verifies their reputation for business keenness.

A well-known firm of American machine men write us that they do not find Canada a profitable field for trade as in their experience Canadian manufacturers seem to be wedded to the old methods while American manufacturers are always inquiring for the latest improvements and labor-saving machinery, which is a not very complimentary opinion of Canada. Such a state of affairs should not be, but a reputable and experienced firm make the statement and vouch for its proof by their own experience.

## MACHINERY and EQUIPMENT

FOR

# Mines

\*\*\*\*\*

MANUFACTURED BY

Canadian Rand Drill Co.,  
MONTREAL.

ATTENTION CENTRAL STATION MANAGERS!

A GOLDEN OPPORTUNITY!

Are you desirous of purchasing

ARC LIGHTING MACHINERY, LEATHER BELTING,  
WATER WHEELS, or SHAFTING?

If so, you cannot afford to miss this opportunity. Owing to extensions necessitated at our generating station we are obliged to discard the above-mentioned material. Communicate with us at once for all information and particulars.

THE MONTMORENCY ELECTRIC POWER CO., - - QUEBEC.

## Sulphur

ROCK  
ROLL  
FLOUR  
GROUND

English Recovered

- Sicilian -

Etc,

The Anglo-Sicilian Sulphur Co.,  
Limited.

Arthur P. Tippet & Co.,

CANADIAN AGENTS,

30 St. Francois-Xavier Street,  
MONTREAL.

ABBEY IMPROVED CHILLED SHOT CO.

(LIMITED)

NEWCASTLE, ENGLAND.

THIS SHOT IS NOW MADE BY A NEW PROCESS.

Samples sent on application.

Read the following Reports on our New Make of Shot:—  
*Sporting Goods Review* states:—"The size and shape of pellets are good and are exceedingly hard. We understand that the demand for this shot has considerably increased and gaining in favor with sportsmen, to whom its excellence of manufacture appeals."  
*Arms and Explosives* states:—"For soundness and general regularity of surface the pellets possess a very high degree of excellence."

W. W. GREENER, "the Great Authority on the Gun," speaks highly of Chilled Shot, and strongly recommends it in preference to soft shot.

The city council of the city of Toronto did a commendable deed when they passed Ald. Gowanlock's resolution to provide that only Torontonians and Canadians shall be employed on civic works. In view of the restrictions imposed by the United States against Canadian labor we cannot have too much of this feeling in Canada. We should like to see a similar resolution from every municipal body in the country.

The Minister of Finance and the Minister of Customs of Canada were waited on by a deputation of bicycle manufacturers recently at Ottawa. The gentlemen composing the deputation were:—Messrs. E. R. Thomas, Lozier Company, Toronto Junction; Mr. Dusseau of the Gendron Company, Toronto; Mr. Evans of the Canadian Typograph Company, Windsor; Mr. Saunders of the Henderson Bicycle Company, Goderich; and Mr. Buffon of the E and C. Stearns Company, Toronto. They asked the Government for a specific duty of \$9 to be collected on each bicycle imported into Canada, with a provision that this duty should in no case be less than twenty-five per cent. ad valorem. They desire to protect Canadian industries from the unfair competition of a million dollars worth of American wheels that are sent into Canada annually to sell at slaughter prices. The Ministers expressed no opinion in the matter.

This is a very heinous case and we desire to direct to it the attention of The Globe. The bicycle manufacturers went to Ottawa in a body and did their best to impress upon the Government the importance of the bicycle industry and what they considered was necessary to its best interests. The Globe will, of course, impugn the motives of the deputation

and deny their right to take such action as they did. In case it has forgotten the arguments, we would refer it to The Globe of March 1, 1895. After the trouble we took on January 7th to call The Globe's attention to certain little inconsistencies it has displayed along this line, surely we can count on it now to attend to such a matter as this.

The Liberals of Halton made a wise choice when they nominated Mr. John R. Barber, of Georgetown, to carry their standard in the coming election for the Legislature. He has large interests in the constituency. He is a member of the Canadian Manufacturers' Association, and a strong advocate of the National Policy for Canada. The interests of Ontario, no less than the interests of Halton, will be safe in his hands. Mr. Barber was chosen by a unanimous convention at Milton.

In the closing hours of the Ontario Legislature on Friday an alien labor law was passed. It provides "that no person shall be employed in the construction of subsidized railways in Ontario who are subjects of any country which has an alien labor law which practically excludes Canadians from employment upon public or other works therein." This is pure buncombe. Who is constructing "subsidized railways" in Ontario?—Buffalo News.

"Who's afraid?" said the small boy, as he hid his head under the bed-clothes. It is thus with our Buffalo contemporary. It either displays its ignorance by its remark, or else it deliberately attempts to keep from the American public the knowledge that the legislature of Ontario feels itself in no wise bound to allow citizens of the United States any privileges in Ontario which the law of the United States does

## BRYANT . . ELECTRIC . . SUPPLIES . .

By special arrangement with the manufacturers, we are placing in stock on Montreal, a complete line of Bryant specialties, including K. W. Rosettes, Bryant Sockets, Branch Blocks, etc., etc. Our catalogue B. showing Bryant goods is now ready, and is the most complete catalogue ever published for the Canadian trade. Write for one.

The **IMPERIAL INCANDESCENT LAMP** IS WINNING FAST FRIENDS  
WHEREVER USED.

# JOHN FORMAN, 644 CRAIG ST., MONTREAL.



## THE CROCKER IMPROVED ...TURBINE.

A HIGH-GRADE, MODERN WHEEL—ECONOMICAL  
AND EFFICIENT IN THE HIGHEST DEGREE.

The best combination of hydraulic science with practical results now on  
the market. Complete Water Power Plants built and installed.

The **JENCKES MACHINE CO.**, 28 Lansdowne St.,  
SHERBROGUE, Que.

SEND FOR OUR NEW CATALOGUE

JUST ISSUED.

It will interest you.

Our Prices will Please,  
and to Purchase

Our Machinery will Pay you.

not allow the Canadian in Inspector DeBarry's domain. My, but The News will feel itself and its country mightily insulted when it discovers that the law it laughs at as "buncombe" shuts out Americans from working on every railroad constructed in the province and allows the very foreigners its own labor organizations oppose to come over and work on these same railroads. The Italian, the Hungarian, the Pole—they all may come and earn their living by labor on those roads, but the American is shut out. Listen and hear what the jaws will have to say now.

The French Chamber of Deputies have adopted a motion to embody in the mail contract of the French Transatlantic Company the prohibition against crossing the Banks of Newfoundland during the fishing season. This clause is suspended contingent upon similar laws from other powers. It is a step in the right direction and other nations should concur to aid in a measure for the protection of human life from the death that so often meets fishermen, through being run down by steamers on the Banks.

LITERARY NOTES.

The Year Book of British Columbia is to hand, and it is a credit to its compiler, Mr. R. E. Gosnell, Librarian of the Legislative Assembly of British Columbia, which is saying a good deal. The Year Book is a handsomely bound volume of over five hundred pages and contains information upon almost every conceivable matter in connection with British Columbia that any one would ever require to investigate. It begins with the early history of the Province and is a regular compendium of its development and its present conditions. A feature of the volume is the maps of British

Columbia and the Yukon country which accompany it, and the valuable knowledge it contains for those who propose to go to the Klondike. To anyone who wants to obtain an intimate knowledge of the west, or to one who desires only to study one subject it is invaluable. Its digests of mining laws and many handsome illustrations also add to its interest.

The February number of The Ladies Home Journal, Philadelphia, contains much interesting matter. On the cover is portrayed by Charles Dana Gibson the ideal American baby. Among the interesting articles are "With Washington in the Minuet," "The Flower Fetes of California," "Getting good Pictures of Children," "Inside a Hundred Homes," "What Indigestion Means," and the Two Serials, "The Inner Experiences of a Cabinet Member's Wife," and "The Doctor."

"The First Election in Greater New York," is the leading article in Scribner's magazine for February. Other features are Howard Pyle's frontispiece, "The Battle of Bunker Hill," "The Naval Campaign of 1776 on Lake Champlain," "The Story of the Revolution," "The Key of the Fields," "The Unquiet Sex," "His Serious Doubts," "The Field of Art," and poems by Mrs. Dorr, Clinton Scollard, and Charlotte Perkins Stetson.

McClures' Magazine for February is just to hand. It contains the following especially interesting articles: "Abraham Lincoln in 1860," "Future North Polar Exploration," "The Wee Tay Table," "The Last Days of George Washington," "Rupert of Hentzau," "Some Great Portraits of Lincoln," "Reminiscences of Men and Events of the Civil War," "Firing a locomotive," "The Bride comes to Yellow Sky," "Henry George's New Book."

The February Cosmopolitan is a good number. Its contents are: "The Last of the Valois," "A Song of Subscriptions," "In the Realm of Woman's Dress," "How the Banana is Grown," "Personnel of the Supreme Court," "Gloria Mundi," "A Social Want," "The Great Electric Trust," "Great Business Operations," "Mrs. Clyde," "The Selection of One's Life Work," "Some Examples of Rusty Art," "A Brief History of our late War with Spain," "Modern Education," "In the World of Art and Letters."

THE IMPROVED AUTOMATIC INJECTOR,

Pat. by T. J. CARROLL.

PRICE LIST.

No.	PRICE.	GAL. PER MIN. 65 LBS. PRESS.	SIZE OF PIPE CONNECTION.	HOISE POWER.
				8 to 16 10 to 40 10 to 72 12 to 120 120 to 220 220 to 300
10	\$7 50	120	1"	
15	15 00	300	1 1/2"	
20	22 50	510	2"	
25	30 00	1000	2 1/2"	
35	38 00	1570	3"	
45		2870	4"	

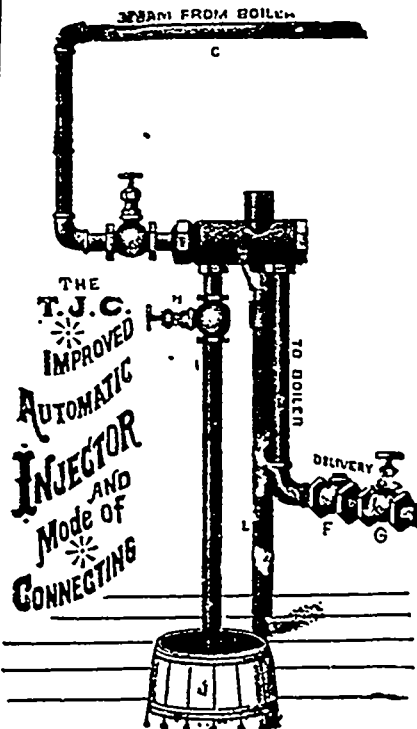

REDUCED PRICES OF Michigan, Eagle, and Queen Lubricators.

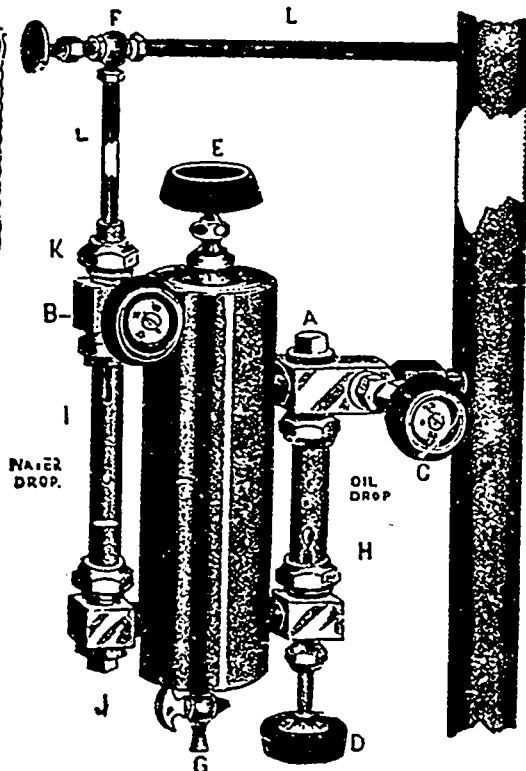

PRICE LIST.

SIZE.	BRASS.	NICKEL.
1 Pint	\$1 50	\$2 00
1 Pint	3 00	4 00
1 Quart	8 00	10 00
2 Quarts	11 00	14 00

For STATIONERY, MARINE, PORTABLE and LOCOMOTIVE BOILERS Simple, Reliable, and Durable. Range 20 to 150. Will lift 20 feet. A written guarantee with each Injector for two years.

HAMILTON BRASS MFG. CO., Limited, 259 to 265 James Street North, HAMILTON, ONT.

**WHO KILLED COCK ROBIN ?**

In thirty years Canada has never made us a proposal that we could accept without grossly sacrificing our farmers to the interests of her own. Within the memory of man Canada has never done an act which indicated either sympathy with us in trouble or satisfaction in our prosperity. Her newspaper press reflects the meanest jealousy and envy of our country. Her "statesmen" have been obstructionists of everything good in our international relations. It is not for such a country that we are going to tear down the protective tariff. —Robert E. Thompson.

**STORAGE BATTERIES.**

The subject of electric storage batteries is one that interests every electrician and the storage system stands high in the prophecies of electric experts who point out its many advantages for traction purposes and for economical purposes in continuous current central stations. Chloride accumulators in central stations will reduce the coal bill and allow the machinery to be run at the greatest economy while in service and shut down entirely during the slack hours. Accumulators also assist in pressure regulation during fluctuations in load, thus being valuable especially where elevators consume a large amount of the power used.

Electric light stations can often carry the

day load by the amount of otherwise superfluous electricity gathered by storage batteries after midnight when the tax upon the production is light, although the generating plant has to be run.

In the case of an electric railway the storage battery prevents those fluctuations which continually occur and bring a severe strain on the engines and generators. Storage batteries at suitable points along the line act as automatic auxiliary plants. They require little attention and are a source of supply in case of accident to machinery or to supply circuits. Early and late cars and all night lines may be run in this manner at very little expense.

On isolated plants a saving of from twenty-five to fifty per cent. is effected per annum on the cost of instillation. In an office building, for example, the night lights and elevator may be supplied by an accumulator. In the case of small plants electricity may profitably be used by calling the storage system to aid. There are many points of advantage in storage batteries and the Electric Storage Battery Co., Drexel Building, Philadelphia, will explain them to you.

Messrs. Curtis & Mitchener, mantle manufacturers, Toronto, have dissolved partnership. Mr. Curtis continues business at 30 Melinda street, and J. G. Mitchener continues at 70 Bay street.

**TANNERS!**

**Grinders and other parts for Tunkhannock Bark Mills.**

Guaranteed to be superior to the American in WEARING QUALITY and at LESS COST.

DAVILLE TANNING CO., write:—

"The Grinders LAST MUCH LONGER and GRIND MUCH BETTER than any we have ever had."

**J. FLEURY'S SONS,**

Founders and Machinists, - - - AURORA, ONT.

**The Packard Electric Co., Limited.**

MAKERS OF

**Lamps and Transformers**

Sole Agents for SCHEEFFER RECORDING WATT METERS  
ST. CATHARINES, ONT.

**CLEVELAND WIRE SPRING CO.,**  
CLEVELAND, OHIO, U.S.



Tempered Steel Machine Springs  
A Specialty.

SPECIAL SPRINGS of all description to order, and for Upholstery, Furniture, Beds, Chairs, etc. Close prices upon application.

**TEMPERED STEEL MACHINE SPRINGS.**

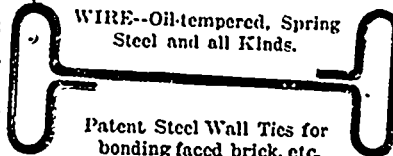

Patent Steel Wall Ties for bonding faced brick, etc.

A. C. NEFF, Chartered Accountant. JAMES WOOD, Late Sec. The T. Eaton Co., Ltd.  
**NEFF & WOOD**  
PUBLIC ACCOUNTANTS, AUDITORS ASSIGNEES, ETC.  
Room 600 Mc Kinnon Bldg., Toronto

**NOT TOO LATE**

BY ANY MEANS TO ENTER IN ANY DEPARTMENT OF THE

**Central Business College**

OF TORONTO, for the Current Session. Members may enter at any time.

Telegraphy, Business Practice, Shorthand, Typewriting, etc.;  
Write for Prospectus to Thoroughly Taught.  
W. H. SHAW, Principal,  
Yonge and Gerrard Sts.

**FOR SALE.**

**NEW AND SECOND-HAND WORSTED MACHINERY**

INCLUDING Wool-Washing, Drying, Combing, Back-washing, Gill Box, Drawing, Spinning and Twisting.

CHANGE WHEELS FOR WORSTED MACHINES KEPT IN STOCK.

Apply to **EDWARD JEFFERSON & BRO.**  
28 Strawberry St., Philadelphia Pa. U.S.A.  
Sole Agents for J. B. FARRAR & SONS, Halifax, England.

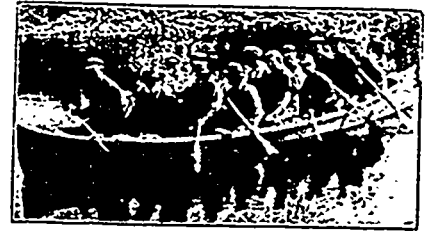

**Canoes for Alaska and Gold Regions**

This cut is one of our 19 foot, No. 69xx Canoes, and shows carrying capacity. Write for our catalogue and discounts.  
Peterborough Canoe Co., Limited, Peterborough

**ELECTRIC MOTORS, WATER MOTORS, DYNAMOS,**

Hand-Feed and Automatic. **ELECTRIC LAMPS,**

Cinematographs, Telephones and Graphophones

WRITE FOR PRICES.

**A. SCHNEIDER & CO.,**  
24 and 26 Pearl St., Toronto.

## CAPTAINS OF INDUSTRY.

The following items of information, which are classified under the title "Captains of Industry," relate to matters that are of special interest to every advertiser in these pages, and to every concern in Canada interested in any manufacturing industry whatever, this interest extending to supply houses also.

If a new manufacturing enterprise of any kind is being started, or an electric lighting plant instituted, or an electric railroad, or a telephone, or a telegraph line is being constructed; or a saw mill, a woolen, cotton, or knitting mill; or if any industrial establishment has been destroyed by fire with a probability of its being rebuilt, our friends should understand that possibly there may be something in the event for them. Do you catch on to the idea?

The starting of any such concern means a demand for some sort of machines, machinery, or supplies, such as steam engines and boilers, shafting, pulleys, bolting, lubricants, machinery supplies, wood or iron working machinery, ventilating and drying apparatus; pumps, valves, packing, dynamos, motors, wire, arc and incandescent lamps, and an infinite variety of electrical supplies, chemicals, acids, alkalies, etc. It is well worth the while of every reader of the Canadian Manufacturer to closely inspect all items under the head of Captains of Industry.

Niagara Falls Acetylene Gas Machine Company, Niagara Falls, Ont., have, within the last month, opened a branch factory at Niagara Falls, N.Y., and already the business on that side of the line has reached such dimensions that the company are contemplating enlarging the premises.

The Kensington Creamery Manufacturing Co., Woodstock, Ont., have enlarged and refitted their factory, putting in new machinery, engine and boiler, and started work last week.

A novel invention is a carbonizer which destroys burrs, etc., as efficiently as acid, and leaves the wool in fine condition. It is harmless to animal fibre or tissue. Merrimac Chemical Co., 13 Pearl St., Boston, Mass.

The Ontario Government have issued letters of incorporation to the John Goodison Thresher Company, of Sarnia, Limited, who will engage in the manufacture and sale of agricultural implements and threshing machines at Sarnia, Ont.

Niagara Falls Metal Works Company, Niagara Falls, Ont., have enlarged their works, and put in a larger engine and boiler.

The McEachren Heating and Ventilating Company, of Galt, have just put in a double dry kiln, and a blast heating system for the whole building of the Eckardt Casket Co., of Toronto. They also put in two planing mill fans which automatically carry away shavings to be burned.

A large fan, just put in by the T. Eaton Company, was supplied by the McEachren Heating and Ventilating Company, of Galt.

Button & Pessant, of Wingham, Ont., are putting in an improved dowelling machine, made by J. Ballantine & Co., of Preston.

J. Ballantine & Co., of Preston, are installing one of their automatic gauge lathes in Hallinger & Ball's factory at Hanover, Ont.

David Conklin, Kingsville, Ont., is putting in a large power, self-feeding rip saw, made by J. Ballantine & Co., of Preston, Ont.

The Globe Hat Works Co., of Montreal, have sold out to E. Percy Gordon, who will continue under the old name.

J. L. McKenzie & Co., manufacturers of electrical apparatus at Victoria, B.C., are succeeded by Wm. Watson.

The British Columbia Oil Company have been incorporated at Vancouver.

## The DRIER the STEAM the GREATER the POWER.



OUR SECTIONAL PIPE AND BOILER COVERING  
Almost Entirely Prevents Condensation of Steam when Passing Through the Pipes  
**EUREKA MINERAL WOOL & ASBESTOS CO.**  
132 BAY STREET, TORONTO.  
ASBESTOS GOODS. MINERAL WOOL. ENGINE PACKING.

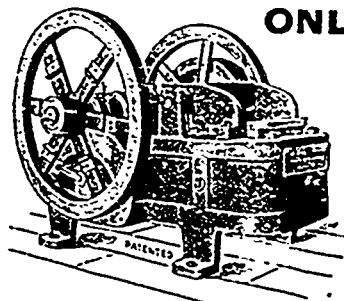

ROLL JAW CRUSHER.

ONLY

# FINE CRUSHER

BREAKS LARGE, or when set close  
Reduces to GRAVEL and SAND.

FOR ORES.

STURTEVANT MILL CO., BOSTON, MASS.

The name of  
**WESTINGHOUSE**  
is a guarantee.

**Westinghouse**

Electric & Mfg. Co.  
Pittsburgh, Pa.

**Westinghouse**

Everybody reads

Westinghouse Electric advertisements. That is why we print them. Everybody knows that we make all kinds of electric apparatus, large and small, from arc lamps, motors for machinery, lightning arresters, switches, meters, to electric locomotives.

New York, Boston, Chicago, Philadelphia, St. Louis, San Francisco, Buffalo, Syracuse.  
Atlanta, Tacoma, Mountain Electric Co., Denver. For Canada,  
Ahearn & Soper, Ottawa. Westinghouse Electric Co., Limited, 32 Victoria St., London.



The offices of the Montmorency Electric Power Company, of Quebec, have been destroyed by fire.

The Boissevain Rink Co., have been incorporated at Boissevain, Man.

Messrs. Milne & Turnbull have started a tent factory at Edmonton, N.W.T., where Merchants Bank have also opened a branch.

The Pipestone Elevator and Maltng Company, of Pipestone, N.W.T., have been incorporated.

The Dominion Brewery Company's Reference Annual, for 1898, has reached us. It is a neat and useful little compendium of the records in twenty-five different sports, and contains also the 2.15 pacing and trotting lists, games, fishing laws, and a lot of other valuable information. Mr. H. J. P. Good is the editor, and his name is a guarantee of the correctness of the Annual's contents.

Lord Douglas, of Hawick, and his family are at the Canadian "Soo," where they will reside for a time. Lord Douglas holds a

copper property at Iron Bridge, near The- salon, and represents an English syndicate who have an option on the Bruce copper mines. He is going to have extensive tests made, and is highly delighted with results already shown. He proposes also to work some gold claims at Michipicoten.

A. B. Jardine & Co., of Hespeler, Ont., manufacturers of blacksmiths' and machinists' tools, have sent out to their friends a neat calendar, decorated with a handsome reproduction of the photograph of a blacksmith, and bearing on every sheet the reminder that they manufacture many lines of first-class tools.

P. and P. Griffin, manufacturers of hair goods, Bloor west, Toronto, have added a dry kiln to their establishment. The kiln was put in by the McEachren Heating and Ventilating Company of Galt.

The Tudhope Carriage Company, Limited, has been organized with a capital of \$100,000, to carry on business at Orillia.

Messrs. Wm. J. Matheson & Co., of New York, have sent out folder No. 1822 which shows Diamine colors dyed on mercerised cotton yarn. The card shows ninety-six samples, and gives directions for dyeing. A sample case of twenty-eight colors is to hand. The samples are loose cotton dyed with Diamine colors by the coupling process and are fast to milling. Wm. J. Matheson & Co., Limited, 282-4 Front St., New York.

The Metropolitan Street Railway's car sheds at North Toronto were destroyed by fire Jan. 23rd.

The Dufferin Falls Lumber, Pulp and Paper Company (Limited) of Montreal, is applying for incorporation.

Universal Patent Developing Co.—A letter is in this office awaiting more definite address to reach the above firm.

The calendar issued by the Barber & Ellis Company, Limited, Toronto, this year is a dream of beauty, and compares favorably with many of those printed for sale.

## Jones & Moore Electric Company

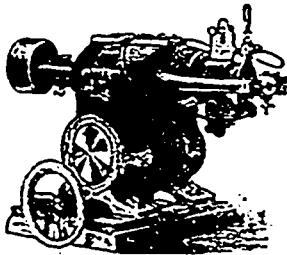

Manufacturers

### Dynamos and Motors

Direct Connected or Belt Driven.

COMPLETE PLANTS INSTALLED  
At Lowest Prices.

A few Second-hand Machines in stock.

22 ADELAIDE ST. WEST, TORONTO.

## METAL STAMPS,

SOAP DIES, AND BRASS SIGN  
MANUFACTURERS

PATTERSON & HEWARD  
40 WELLINGTON ST. WEST, TORONTO.

F. W. HORE'S SONS,  
HAMILTON, ONT.

Manufacturers of . . .

WHEELS, Wheel Materials, Shafts, etc.



For IRON FENCING,  
BANK and OFFICE RAIL-  
INGS and all kinds  
of IRONWORK

Address..

Toronto Fence & Ornamental Iron Works  
73 Adelaide St. West, Toronto.

## VALVES AND PIPE . . . FITTINGS

WRITE FOR LATEST PRICES

## RICE LEWIS & SON, Limited

Corner King and Victoria  
Streets

TORONTO

BROWN & CO.  
Manufacturers of  
Square and Hexagon  
HOT PRESSED NUTS.  
PARIS. - ONT.

Kemp Mfg. Co.  
TORONTO.

## Galvanized Steel Pails..

FOR FIRE PURPOSES ONLY.  
NO HOOPS TO FALL OFF.

PRICES ON APPLICATION.

ATLAS ATLAS FACTS  
METAL Speak  
louder  
than  
words  
and

ATLAS does not rely on empty  
talk for its UNSURPASSED  
REPUTATION.

It Has Been Undeniably  
Proved that ATLAS METAL  
is Superior to all and has  
stood under Enormous Pres-  
sures and Phenomenal Speed.

TRADE MARK. TRY ATLAS METAL  
WHERE  
ALL OTHERS HAVE FAILED.

WE CHALLENGE A TEST  
Against any Anti-Friction  
Metal on the Market.

THE ATLAS METAL CO., Limited  
75 Queen Victoria St., London, Eng.

H. G. McLAREN, General Agent  
for Canada,  
318 ST. PAUL ST., MONTREAL, QUE.

Pro-  
cras-  
ti-  
na-  
tion

Is unwise in not equipping your premises  
with Fire-Fighting Apparatus.

FIRE PAILS  
are always necessary. Those of Eddy's  
Indurated Fibreware have many advan-  
tages over others; do not leak—imper-  
vious to liquids—hoopless.

The E. B. EDDY CO. Limited  
HULL, MONTREAL, TORONTO.

**A POWERFUL MACHINE.**

The Sturtevant Patent Roll Jaw Crusher, illustrated in the cut, the only-Jaw Crusher made that is capable of taking in hard rock and reducing it at once to gravel and sand, thus one machine

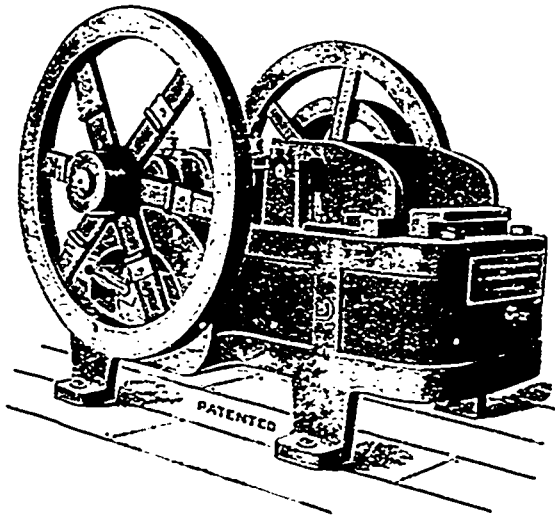

doing the work of a Jaw Crusher and one or two pair of Rolls, and without any auxiliary apparatus. It is strictly a Jaw and Toggle machine, but the jaws can be set

two inches apart, or to approach to  $\frac{1}{4}$  inch of each other. They do not clog in crushing any air dry material, for although the active jaw seems to approach and recede as in other crushers, it does not, really do so, but has a true rolling motion without any rubbing action whatever.

The two jaws are always at the same minimum distance apart, like a pair of Rolls, hence the crushing is as fine, and has the same uniform character. It is because of the roll-like clearance that the tendency to clog is avoided.

While all other Rock Breakers crush the rock by a direct pinch, the Roll Jaw rolls upon the material, which breaks down easily under moderate pressures, since no rock can withstand a crushing and rolling stress applied at the same time.

The jaw faces having, as before stated, a rolling action allowing no rubbing, the jaws of this crusher are the most durable of even this standard type of Rock Breaker.

The cut represents a 6x16 Roll Jaw Crusher, weighing about seven tons and requiring about ten horse power.

The moving jaw of this machine, like a Roll, is elastically mounted, hence the machine is not likely to be broken by gripping a sledge or other material accidentally dropped between the jaws.

The Sturtevant Roll Jaw Crusher is not a rough casting, but a carefully designed and well-constructed machine, made of the best materials, and like all Sturtevant productions, made to last and to give the least possible trouble.

The toggles of this Crusher are like those of the Blake, but the long Roll Jaw gives immense lever power. Upon coarse work the Roll Jaw Breaker has a larger capacity than any other jaw machine, and, as before stated, is the only one capable of reducing large rock at once to gravel and sand, thus doing the additional work of one or two pairs of Rolls.

This Crusher is manufactured only by the Sturtevant Mill Co. of Boston, Mass.

**PATENT LAW CHANGES.**

Messrs. Ridout and Maybee, patent solicitors, of Toronto, have furnished us with information about six important amendments to U. S. Patent Laws which came into force on January 1, 1898. In substance the amendments are as follows:—

1st. A patent will not be granted to an applicant if the invention has been patented or described in any printed publication in any country before his invention or discovery thereof, or more than two years prior to his application.

2nd. A U. S. patent will not be granted to an inventor who has obtained a foreign patent unless his U. S. application be made within seven months of the date of filing of the foreign application.

This clause, it will be noted, only applies when the foreign patent has actually issued, and is not merely applied for.

3rd. The application must be completed and prepared for examination within one year after the filing of the petition, and must be prosecuted within one year of the date of any official action thereon.

4th. The prior issue of a foreign patent will not now limit the U. S. patent to expire at the end of the legal term of the foreign patent.

5th. If an assignment, grant, or conveyance be duly acknowledged before a proper officer, the certificate of such acknowledgment under the hand and seal of such officer will be prima facie evidence of the execution of such instrument.

6th. No damage can be collected for infringements of a patent occurring more than six years previous to the filing of a bill of complaint or the issuing of a writ.

The second amendment referred to is of immediate importance to Canadian inventors and it is desirable that they thoroughly understand it, so that on one hand they may make their U. S. applications in due time, and on the other be prepared to meet the attempts of unscrupulous U. S. firms to

entice them into making worthless U. S. applications.

**GERMAN COMMON SENSE.**

In Germany schools of low and high grade for instruction in almost every art are scattered all over the country; boys are trained from early youth not only to do certain things but to understand them; their minds as well as their hands and eyes are trained. The average American believes that technical processes can only be learned in the shops; the German knows that they can be best learned in the technical school, where it is possible to get hold of the theory as well as the practice, and while he lacks the quickness and inventiveness of the American and exasperates the American manufacturer by imitating his wares, not forgetting occasionally to counterfeit the trade mark, yet wherever science can be harnessed to industry the German achieves results which worry his English competitors and inspire his American competitors to demand more protection.—Boston Journal of Commerce.

**DON'T WANT RECIPROCITY.**

Canada can never again have a reciprocity treaty with the States on the basis of the one previously enjoyed. The conditions of the two countries are changed. When this country enjoyed and prospered under reciprocity with our neighbors it was after the American war, when the United States was nothing but a great consuming country. To-day they are a great producing people, and of nearly everything we have to sell they raise a large surplus. Therefore their market is of little use to us. Their production is similar to our own, and then, under certain conditions of labor, area and climate, they are frequently able or forced to sell cheaper than ourselves. Nor does it take much further thought to show us that in natural products a reciprocal treaty can do no good, while on occasion it

might be decidedly harmful. The American politicians recognize these facts and appreciate them, and the danger is that, being deeply anxious to obtain entrance into Canada for their manufactures, they may readily concede some sort of reciprocity in natural products for the sake of gaining an entry for their manufactures; and once this is done we should soon see again Canada made a slaughter market for the goods of their great capitalists.—North Sydney (Cape Breton) Herald.

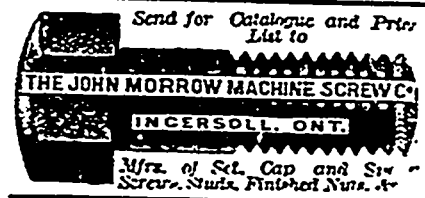

**A SNAP... 25 to 30 Light BALL ARC DYNAMO**

In first-class condition, 6 Ampere. Cash price, \$50. Address Box 12, Care THE CANADIAN MANUFACTURER, McKinnon Building, Toronto.

**GEORGE WHITE-FRASER.**

Member Can. Soc. C.E. Member Am. Inst. Elec. Eng. CONSULTING AND CONSTRUCTING Electrical Engineer. Railways, Lighting, Power Transmissions, Factory Plants, Reports, Specifications, Tests, 18 Imperial Loan Building, TORONTO.

ADVERTISE IN THE CANADIAN MANUFACTURER.

The Central Furniture Company, Limited, of Lucknow are giving up business.

The Londonderry Iron Company have been awarded a large contract for flanged steam pipe and fittings varying in size from six to twenty-four inches, for Messrs. T. McAvity & Sons, St. John, N.B. This class of work is a specialty of theirs and they contemplate putting in a tripple headed flange lathe and also a multiple drill for drilling a number of holes in flanges at the same time. With these tools they will be the best equipped shop in the lower provinces for all flanged pipe and fittings for steam, electric, pulp or similar establishments.

Ottawa capitalists propose to build a big pulp mill at Keewatin this summer.

The company that controls the Shawenagan water-power, on the St. Maurice, is negotiating with an English company, that manufactures chloride, to locate in Three Rivers. They would employ 40,000 horse-power, and the lime and salt they require for raw material are easily to be secured in Canada. The English company has a change in view, because American competitors use water-power, and can manufacture more cheaply than the English firm can with steam-power.

Several parties of Americans have recently purchased Klondike supplies in Toronto.

A number of Owen Sounders are negotiating with the Grand Trunk Railway Company for the erection of an elevator at Owen Sound.

The C.P.R. carried about 10,000 immigrants into Manitoba and the Northwest Territories during 1897.

It is expected that a weekly cold storage service from Canada to Liverpool and Glasgow will be added to the service to Bristol this summer.

Mr. E. M. Matchett is succeeded by Mr. R. Sardus, in the firm of Harris & Matchett, builders, St. Thomas.

The Canadian Furniture Manufacturers' Association have decided to discontinue their annual exhibition which they consider does not bring forth results sufficient to warrant its continuance.

The company that controls the Souris coal fields is about to make considerable extensions in its work, and has already received the report of Mr. Parsons, the mining engineer who has been laying out the changes.

About \$100,000 pounds of tobacco were grown in Essex last year. One grower reports a yield of \$2,500 worth from fourteen acres, which is decidedly remarkable, as \$100 worth to the acre is considered a fair average yield.

The Globe Hat Works Co., of Montreal, have dissolved partnership.

The Vancouver Power Company, of Victoria, B.C., has secured incorporation.

The Canadian General Electric Company have issued a very handsome calendar. The background is gold, and the design represents a female figure seated on a globe, and drawing aside a curtain with one hand, while with the other she uplifts an electric lamp that illuminates the company's factories. By way of reminder the calendar constantly informs us that the company manufactures all kinds of electric railway and lighting apparatus and supplies. A useful feature of this creditable production is that under the date pad is a table showing the dimensions and resistances of copper wire and the equivalents of wires.

J. McRae's sawmill at Ducks, B.C., has been removed to Salmon Arm.

# The Manufacturers' Life Insurance Company

	Income.	Assots.	Business in Forco.
December 31st, 1887,	\$37,964	\$155,877	\$2,536,000
December 31st, 1892,	230,281	536,067	8,136,980
December 31st, 1897,	448,000	1,308,466	11,808,000

HEAD OFFICE, - TORONTO.

GEO. GOODERHAM, President.

J. F. JUNKIN, Gen. Manager.

G. A. STERLING,

- Secretary.

## CUT NAILS

Bar Iron and Steel  
Railway Spikes  
Pressed Spikes  
Washers  
Rhode Island Horse Shoes.

ABBOTT & CO., - MONTREAL

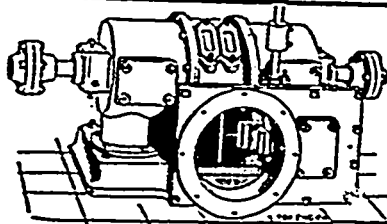

Horizontal Type.

Water Wheel Governor, Machine Dressed Gearing, Palleye, Shafting and Bearings.  
Catalogue and Gear List mailed on application.

"LITTLE GIANT" TURBINE

....FOR ALL PURPOSES....

HORIZONTAL AND VERTICAL  
BUILT IN 44 SIZES.

We guarantee a higher percentage of power from water used than any other wheel on the market.

Correspondence Solicited.

J. C. WILSON & CO., - - GLENORA, ONT.

J. ALEX. CULVERWELL,

DISTRICT AGENT

Toronto and District.

Royal-Victoria Life

(HEAD OFFICE MONTREAL)

5 King Street West, - TORONTO.

AULD MUCILAGE CO.

Manufacturers of the Celebrated  
Premium Mucilage, Lithogram Com-  
position, Lithograms Ready for Use.  
Printers' Premium Roller Composition.  
Write us for Quotations.

759 CRAIG STREET, - MONTREAL, P.Q.

Leitch & Turnbull

Canada Elevator Works,

Queen and Peter Streets, Hamilton, Ont.

Patent Safety Hydraulic Hand and POWER ELEVATORS  
Telephone Connection.

BOILERS.

YOU WANT THEM. WE MAKE THEM

WRITE FOR PRICES

BANNERMAN & FINDLATER,  
Boiler Makers, OTTAWA, ONT.

THE  
NIAGARA FALLS  
ACETYLENE  
GAS  
APPARATUS

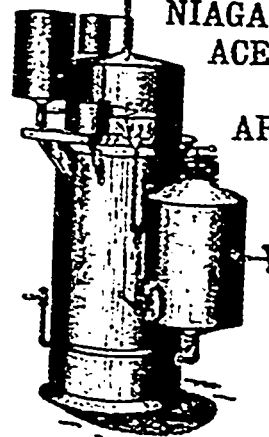

Patented in  
Canada, United  
States and  
Great Britain.

This is the  
only machine  
perfectly auto-  
matic in its ac-  
tion, requiring  
little or no atten-  
tion. Machines  
made in 10 sizes  
costing \$15 and  
upwards.

Acetylene Gas the Coming Light.

CHEAPER THAN ELECTRIC LIGHT  
COAL GAS OR COAL OIL

For Private Dwellings, Business Houses  
Churches, Public Halls and Offices.

For particulars write to the

NIAGARA FALLS ACETYLENE GAS MACHINE CO.  
NIAGARA FALLS, ONT. LIMITED.

Sub-  
scribe for The Canadian Manufacturer

The Empire Carpet Co., St. Catharines, Ont., are adding another three-yard art square loom and a three-ply loom to their works. They report business good—working overtime.

During the Liberal meeting in Kingston on the evening of January 31st, Mr. Harty read a telegram from Hon. Mr. Blair announcing that three locomotives were to be constructed for the Government at the Canadian locomotive works and another order would follow after Parliament votes the appropriation.

The organ factory of W. Doherty & Co., at Clinton, Ont., has been destroyed by fire.

A charter has been granted to the Canada Marble Co., of Toronto.

The Rand-McNally Business Atlas for 1898 is a valuable adjunct to your office equipment. It contains information of all kinds about any and every place you or your agents need to know about, and is more than useful in laying out routes for salesmen's trips.

Mr. John Simpson, a well-known Toronto boat builder, has contracted to build, for a Brockville company, an excursion steamer to carry 700 people. The cost will be about \$35,000.

The

# Queen City Oil Co., LIMITED,

TORONTO,

SAMUEL ROGERS, PRESIDENT.

WHOLESALE DEALERS AND MANUFACTURERS,  
AND SALES AGENTS FOR STANDARD OIL COMPANY'S

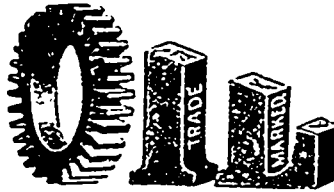

AND

# GREASES

OUR

# PEERLESS

BRANDS ARE FAVORITES

## TO BELT USERS :

IT IS NOT WIND YOU WANT.

RESULT OF MY TRIP :

GENUINE 

ENGLISH OAK

TANNED BELTING

D. K. McLAREN

24 Victoria Square, - MONTREAL

## FORD, RUTHVEN & CO.,

26 PITT ST., SYDNEY, AUSTRALIA.

Wool Buyers' on Commission.

Letters of Credit must accompany Orders.

BANKERS: Bank of Australasia, Sydney.

## Dominion Oil Cloth Co.,

Manufacturers of....

OIL-CLOTHS OF EVERY DESCRIPTION

Floor Oil-Cloth, Table Oil-Cloth, Carriage Oil-Cloth,  
Enamelled Oil-Cloth, Stair Oil-Cloth, etc., etc.

Office and Works

Cor. St. Catharine and Parthenais Sts., MONTREAL, Que.

ADVERTISE in  
...The Canadian Manufacturer

# THE DIFFERENCE

The difference in taking down a section of line shaft, removing couplings, etc., and putting on solid iron pulley and then putting all back in place, and in putting on a "REEVES" Patent Wood Split Pulley, leaving the shaft unmolested, will in nearly every case pay for the "REEVES" entire.

REEVES PULLEY CO., Pearl St., - Toronto, Ont.  
GET OUR CATALOGUE.

Kensington has passed a by-law to grant \$62,000 for site and bonus to the Abbott rolling mills, which will remove from Montreal and expects to be turning out iron in its new location in three months.

The Reeves Pulley Company, 16 Pearl Street, Toronto, Ontario, have issued a neat pocket catalogue of their patent wood split pulleys. Some of the advantages of this pulley are that its lightness reduces weight and, consequently, horse power and expense of keeping shafting true; ease of attaching pulley to shaft without taking shaft down and uncoupling it; saving in belt slippage. The Reeves Company supply pulleys up to thirty-two feet in diameter and their catalogue explains in detail the advantages of their pulleys. Machinery users will do well to investigate their merits.

A new club house is to be built this summer for the Royal Canadian Bicycle Club of Toronto. It will be located on Broadview avenue and the cost of the building is to be \$10,000. Ex-Ald. Russell is the contractor.

The Pipestone Elevator and Malting Company has been granted letters patent by the Manitoba Government. It will carry on business at Pipestone, Man.

A new skating and curling rink will be built at Boissevain, Man.

The Rogers Electric Company of London, Ont., have installed fifty-five alarm boxes in the Forest City.

The I. B. Kleinert Rubber Company, of West Virginia, has secured a license from the Province of Ontario to manufacture rubber goods and dress shields, etc., in Ontario. The Company has appointed W. H. Williamson, of Toronto, as its attorney in Canada.

The Royal Electric Company, Toronto and Montreal, are favoring their friends with a very neat blotting pad for desk use. It is handsomely bound in leather and measures about eighteen inches square. Features of it are the calendar and a novel arrangement for a memorandum. The pad is one of the best business announcements sent out this year.

The Royal Paper Mills Company's pulp mill at East Angus, Que., is rapidly nearing completion. Hon. W. B. Ives will be manager.

St. John's, N. B., will benefit by Mr. Spiro's new pulp mill which will likely be built at Indiantown or Carleton.

The T. & H. Electric Company, successors to Kay Electrical Manufacturing Company, reports that among their recent sales are the following twenty machines: Messrs. Hillman & Co., Berlin, one 12 h.p. motor; Toronto Cold Storage Co., one fifty light dynamo; Journal Pig Co., St. Catharines, one 5 h.p. motor; Geo. Mernbery, St. Catharines, one 3 h.p. motor; Toronto Ornamental Iron Co., one 1,000 gal. plater; Messrs. Meakins & Company, one 1 h.p. motor; R. N. Grundy, Guelph, one 200 gal. plater; Berlin Felt Boot Co., one 150 light dynamo; Victoria Wheel Wks., Galt, one 150 gal. plater; Messrs. A. R. Woodyat & Co., Guelph, one 250 gal. plater; J. C. Harris, Toronto, one 7 h.p. motor; McKinnon Bldg., Toronto, one 15 h.p. and one 10 h.p. Direct connected motors and controllers; Messrs. Garrioch & Goldard, Ottawa, one 2 h.p. and one 4 h.p. motor; Berlin Shirt & Collar Co., one 4 h.p. motor; Messrs. D. W. Karn & Co. Woodstock, one Automatic Organ Blowing machine, besides several machines in Victoria, B.C. and Woodstock, N.B.

Messrs. Gordon and Ironsides will establish an abattoir and cold storage warehouse in Winnipeg.

Contractor Tompkins, of Brockville, is in Vancouver constructing a new depot for the C. P. R. He says that the company's hotels along the line are to be enlarged.

A new rink is to be built at Ventnor.

The big show room building of the Alexandria Carriage Company collapsed recently and caused \$1,500 damage.

The St. Lawrence Blanket Company, Limited, of Gannoque, Ont., has obtained a charter.

A new enterprise at Hanover, Ont., is the Hanover Woolen Mills Company, Limited, to which a charter has been granted.

The Ontario Lead and Barb Wire Company, Limited, of Toronto, have changed their style and will in future be known as The Ontario Lead and Wire Company, Limited.

**CARBONIZER** A neutral substance, harmless to animal fibre or tissue, while it destroys burrs, etc., as efficiently as acid. It leaves the wool in fine condition. Manufactured by the Merrimac Chemical Co., 13 PEARL ST. BOSTON.

## ALBERT BELL ENGINE WORKS

DUNNVILLE, ONT. Makers of  
YACHT ENGINES, 1 H.P. to 50 H.P.  
Safety Water Tube BOILERS  
PROPELLER WHEELS  
Stationary Engines and Boilers

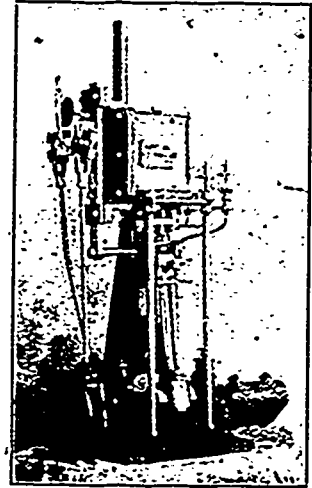

WRITE FOR CIRCULARS

HAMILTON, CAN. Catalogue on Application.

**THE B. GREENING WIRE CO. LTD.**

ALEX. GARTSHORE, President. J. G. ALLAN, Sec.-Treas. JAS. THOMSON, Vice-Pres. and Gen. Mng'r.

## THE GARTSHORE-THOMSON PIPE & FOUNDRY CO.

Limited



3 in. to 60 in. diameter.

For Water, Gas, Culverts and Sewers

Special Castings and all kinds of  
WATER WORKS SUPPLIES

FLEXIBLE AND FLANGE PIPE.

HAMILTON, ONT.

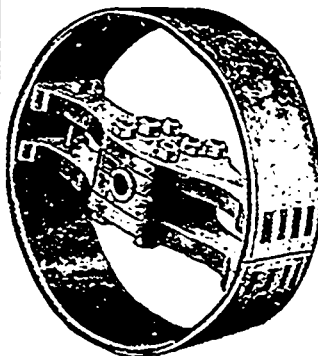

BENT WOOD SPLIT PULLEYS,  
RIM... (REID'S PATENT).

The Strongest, Lightest and Best Belt Surface in the World

No Glue, no Nails in Rim like Segment Rim Pulleys, to be affected by Steam, Dampness or Moist Temperature.

EVERY PULLEY GUARANTEED.

The Reid Bros. Manufacturing Co., of Toronto,  
102-108 Adelaide St., West, Toronto.

**GEO. REID & CO.** Successors to **The PAUL FRIND**  
 Woollen Machinery Co., Limited,  
 'PHONE 956 TORONTO.

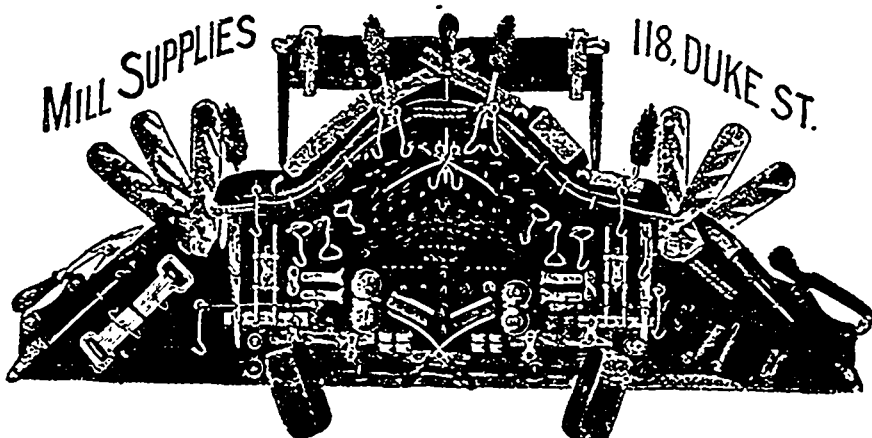

**SPECIALTIES:** Hamilton Cotton Co's Beam Warps.  
 Samuel Law & Sons H. and T. Steel Card Clothing.

All Kinds of Textile Machinery. Machine Shops in Connection.

**ECO** Magneto Watchman's  
 ELECTRIC CLOCK  
 Without Batteries. Write for descriptive circular to  
**Eco Magneto Clock Co.**

Room 71, 620 Atlantic Avenue, BOSTON, MASS.

**MONTREAL ELECTRIC CO.**, Agents for Province of Quebec,  
 302 St. James Street

**John Starr, Son & Co., (Limited), HALIFAX, N.S.**  
 Agents for the Maritime Provinces.

**JOHN J. KELLER & CO.**

104 and 106 MURRAY ST.  
 NEW YORK

220 Church St., Philadelphia.  
 135 Pearl Street, Boston.

**Aniline Colors,  
 Dyewood Extracts,  
 Sumac and  
 Nutgall Extracts.**

**FAST COLORS** for Wool Dyeing,  
 One Dip Cotton Colors, Novelties  
 and Specialties for Calico  
 Printing.

MANUFACTURED BY  
**JOHN R. GEIGY & CO.**  
 BASEL, SWITZERLAND

The **Dake Engine**

For Running Dynamos in

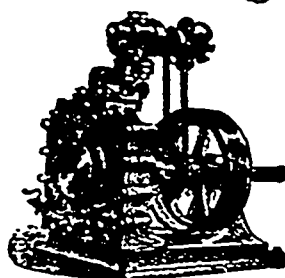

Small Isolated Plants.

**CONTRACTORS' HOISTS**

**STEADY AND EVEN MOTION,**  
 ALSO FOR

Attachment Direct to Fans, Blowers, Centrifugal  
 Pumps, Stokers, Steering Gear, Etc.

Correspondence Solicited.

**THE JENCKES MACHINE COMPANY**  
 SHERBROOKE, QUE.

Succeeding  
**THE PHELPS MACHINE CO., Eastman, Que.**

ESTABLISHED 20 YEARS.

**A. KLIPSTIEN  
 & CO.**

122 Pearl St., New York.

**ANILINES, DYESTUFFS,  
 AND  
 CHEMICALS**

Of every variety, of the best quality  
 and at the lowest prices.

Delivery made at New York, Montreal  
 or Hamilton.

**WRIGHT & DALLYN,**  
 AGENTS,  
 HAMILTON, ONTARIO.

Reproductions Made for Eight  
 Cents per Square Inch.



Half Tones Made Direct from  
 Photos.

**WM. BARBER & BROS.**  
 GEORGETOWN, ONT.

Manufacturers of  
**BOOK AND FINE PAPERS**

**C. G. ELRICK & CO.**  
 MANUFACTURERS OF

**HORN and RUBBER COMBS, Etc.**  
 FACTORY—Sheppard Street, Toronto.  
 MONTREAL OFFICE—Fraser Building.

**JOHN HALLAM**  
 TORONTO.

WHOLESALE DEALER IN  
**DOMESTIC  
 and FOREIGN WOOLS**  
 Sumac, Japonica, etc.

**SMITH WOOL-STOCK CO.**  
 219 FRONT ST. EAST, TORONTO

Makers of... **WOOL STOCK, SHODDIES, Etc.**  
 All lines of Graded Woolen Yarns, Carboniz-  
 ing and Neutralizing, Beavers of Wool Pickings,  
 All lines of Hard and Soft Waste.

Canadian Manufacturer \$1.00 a  
 Year.

## HEATING...

The Fan System of Steam Heating for Heating of factories and all classes of buildings.

## DRYING...

Drying apparatus for drying of

LUMBER, BRICK, WOOL, CLOTH  
HAIR, SOAP, GLUE, Etc.

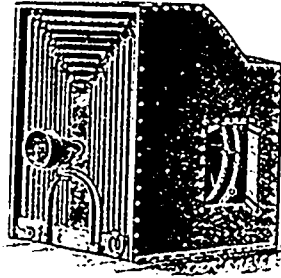

Heater and Housing.

## VENTILATING...

Ventilating Fans for removal of dust, foul air, etc.

Write for Catalogue and Prices.

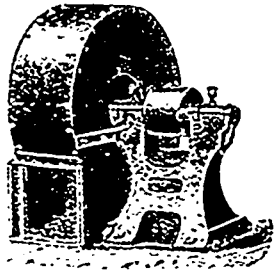

Fan.

**McEACHREN HEATING  
and VENTILATING CO.**  
GALT, ONT.

# Hamilton Blast Furnace Co.

HAMILTON, - - ONTARIO

(Limited)

Manufacturers of

# HIGH GRADE PIG IRON

## THE . . . DOMINION WATER

IMPROVED SPECIAL FEATURES

Economy in Use of Water, Great Power  
Equal Efficiency at any Gate-Opening  
Steadiness and Strength of Motion  
Sensitiveness to Change in Gate-Opening  
Ease for Regulation by Governor  
Strength and Durability  
Freedom from Trouble with Step  
Not Clogged by Ice  
Accessibility to all Parts

St. CATHARINES,  
February 9, 1897

Messrs. Wm. & J. G. Greey,  
Toronto.

GENTLEMEN.—Your favor of the 5th to hand. Have been away from home and hence delay in answering your letter. You ask us how your Dominion Wheel compares with the Well. Sir, the comparison is this—we have been using two . . . 35 inch diameter, double wheels, and your 31 inch Dominion wheel we put in December last gives us as much power as both, and does not use but very little more water than one of the 35 inch wheels. Yours truly,  
COOKE & SON

MANUFACTURED ONLY BY

**WM. & J. G. GREEY**  
TORONTO

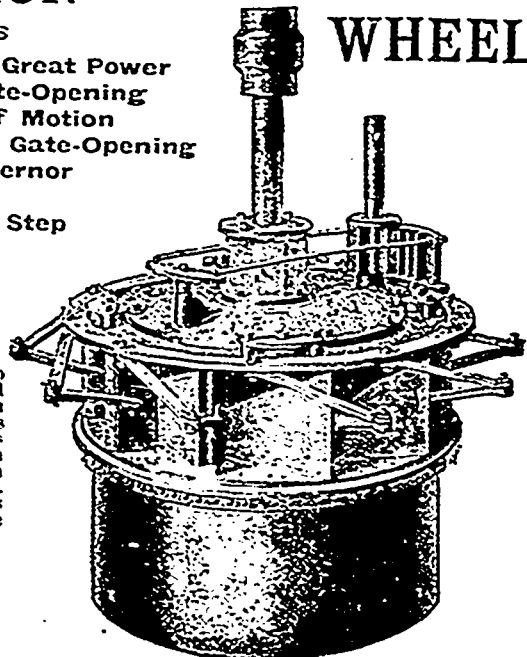

WHEEL

With its removal from Toronto, The American Rattan Company of Toronto, Limited, has changed its name to The American Rattan Company of Walkerton, Limited.

The Grand Trunk Railway is securing figures for the construction of twenty first-class coaches.

Experts are investigating the possibility of securing power from the Chambly works on the Richelieu to operate the Montreal Street Railway.

The offer of Mr. William Doherty to pay half the cost is the prime reason for the construction of a new Methodist church in Clinton, Ontario.

The Grand Trunk Railway Company are building a new iron bridge at Windsor Mills, and a bridge over the Richelieu River at Beloeil.

Messrs. Fulmer & White, of Banff, N. W. T., are getting out timber for a buffalo enclosure.

An attempt to establish a bicycle factory in China has resulted in the opinion of Mr. Perkins, who went out to Shanghai to superintend it, that the chances of bicycle-making in China are most remote.

The receipts for the sale of Dominion lands in the Northwest, during 1897, were \$20,000 in excess of the best previous record in the last five years. The sales were \$104,700 last year; in 1896 they were \$71,796; in 1895, 69,358; in 1894, \$70,533, and in 1893, \$83,734.

Col. Domville, of Nova Scotia, recently purchased, in Toronto, a light draft steamer, and a steam launch, for the Yukon-Klondyke trade. He represents an English syndicate, and is enthusiastic over the possibilities of the great gold region up in the Yukon country.

Mr. Bruce Price, a well-known New York architect, is in Montreal in consultation with the representative of an English syndicate that proposes to erect palace hotels in Halifax, St. John, N. B., Montreal, Ottawa, Toronto, Niagara Falls and Muskoka Lake. Other cities farther west will also be considered.

A charter has been granted to the Cardinal Electric Light Company, Limited, of Cardinal, Ontario.

The Page Wire Fence Company, of Walkerville, Ont., are filling an order for thirty carloads of their standard railway fencing for the Atlantic and Lake Superior Railway Company. This means no less than two hundred miles of fence, and it will keep the Page Company hustling to fill this big order and keep up with their regular trade.

Brockville, Ont., is likely to secure a manufactory to make a new kind of electric light carbons. The patents are controlled by a firm manufacturing the carbons at Sandusky, Ohio, and they propose to establish a plant to manufacture their products in Canada, with a capital stock of \$20,000.

The Electrical Construction Company, of London, Ontario, have taken the largest contract for electric lighting ever let in the Forest City. They will install from six to seven hundred lights in the Tecumseh House, under direction of Messrs. McGaw & Winnett, who are improving this popular hostelry.

Stormont and Glengarry propose to establish at Cornwall a cheese board to conduct the sale of cheese for the factories in that district.

# THE WEEKS-ELDRED CO. OF TORONTO, LIMITED

*Mechanical, Civil and Sanitary Engineers*  
GENERAL CONTRACTORS, STEAM POWER, HEATING and VENTILATING. Sewage Disposal Plants a Specialty

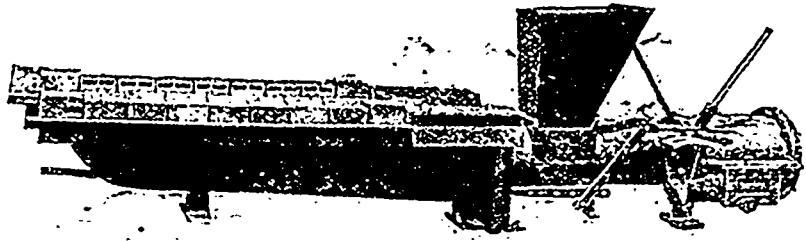

Sole Canadian Manufacturers of the  
**Improved Jones Under-feed Mechanical Stoker**

Perfect Combustion. No Smoke. No Ash.

Offices..  
80 CANADA LIFE BUILDING, TORONTO, ONT.  
Send for Illustrated Catalogue

**The KAY Electrical Manufacturing Co.**  
HAMILTON, ONT.,

Beg to announce that in future it will conduct its business under the name of

## The T. & H. Electric Co.

HAMILTON, ONT.,  
255-257 James St.  
'Phone 958

TORONTO, ONT.,  
58 Adelaide St. W.  
'Phone 1214

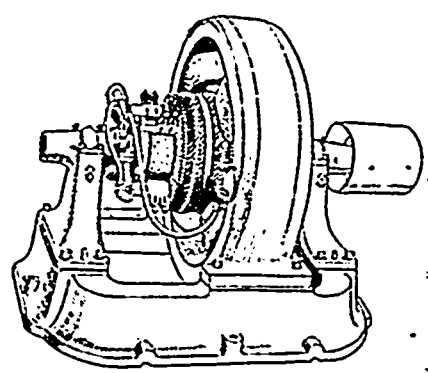

**TORONTO**  
**ELECTRIC**  
**MOTOR**  
**COMPANY**

From 8 to 100 K. W.  
103 105, 107, 109 Adelaide Street West, Toronto, or to  
R. E. T. PRINGLE, 216 St. James St., Montreal.

## The Pulsometer

STEAM PUMP

OFTEN IMITATED BUT NEVER EQUALLED ...

The handiest simplest and most efficient steam pump for general Mining, Quarrying and Contractors' purposes.

Muddy or Critty Liquids Handled without wear.

Descriptive Catalogue with prices, furnished on application.

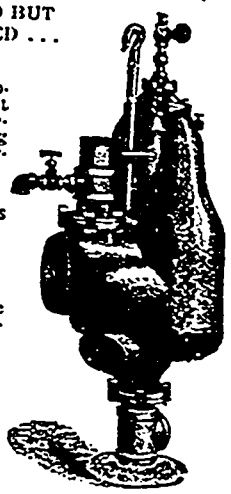

**PULSOMETER**  
Steam Pump Co.  
New York, U.S.A.

**A. R. Williams Machinery Co.**

Toronto and Montreal.  
Selling Agent for Canada.

## THE TORONTO PAPER MFG. CO.

CORNWALL, ONT.

Manufacturers of...  
Engine Sized Superfine Papers  
White and Tinted Book Papers  
Blue and Cream Laid and Wove Foolscaps, Account, Envelope and Lithographic Papers, etc.

## THE ... A. R. WILLIAMS MACHINERY CO. (Limited)

Head Office, - - SOHO MACHINE WORKS, TORONTO  
Manufacturers of and Dealers in  
High-Class Iron Tools,  
Wood-working Machinery,  
Engines, Boilers,  
Motors, Water Wheels,  
General Machinery  
and Supplies.

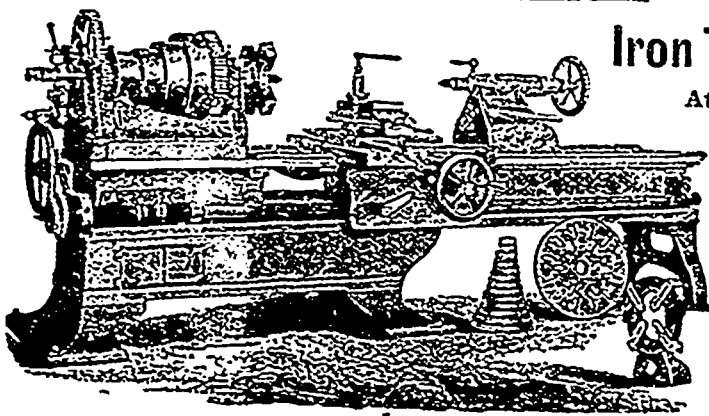
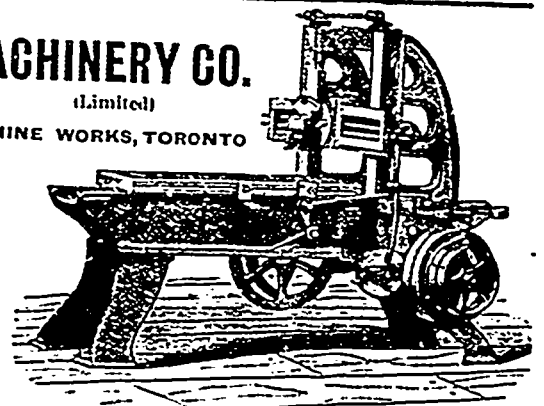

## Iron Tool Works

At London.  
BRANCHES  
193 Colborne St., BRANTFORD  
345 and 347 St. James St., MONTREAL

Send for Circular, Referring to this Advt.



# THE ELECTRICAL CONSTRUCTION CO., OF LONDON, LIMITED, LONDON, - - ONTARIO.

*DIRECT-CURRENT MULTIPOLAR LIGHTING MACHINES*, From 2 to 40 K.W.  
BELTED OR DIRECT-CONNECTED.

MULTIPOLAR MOTORS, up to 50 k.w.  
Knife Switches, all Sizes and Kinds.

**REPAIRS ON SHORT NOTICE.**

Two Second-hand 150 k.w. Multipolar, and two 80 k.w. Bipolar 500 Volt Generators for Sale at a Bargain.

DO YOU REQUIRE 

## Rubber Belting?

IF SO, BUY THE BRANDS MADE BY

The CANADIAN RUBBER COMPANY of MONTREAL

CAPITAL \$2,000,000.

Manufacturers of all Kinds of Rubber Goods

ONTARIO BRANCH—Cor. Front and Yonge Streets, TORONTO.

# Patent for Sale.

**JUBILEE**  
**SMOKE**  
**CONSUMER**

This new apparatus is the sole one which destroys completely smoke and gases of every kind.

It is the only one which can be adapted to locomotive and steamboat boilers, as well as to boilers used in factories, workshops, etc.

THE JUBILEE gives entire satisfaction, its work being perfect.

The Canadian, British and American outrights would be sold, if a reasonable offer was made, on account of the professional business of its owner.

APPLY TO

**ALBERT PAGNUELO,**

AGENT,

58 ST. JAMES STREET, - - MONTREAL, CAN.



**CANADA IRON FURNACE CO., LIMITED**  
*Montreal, Radnor and Three Rivers*

Manufacturers of the well-known

**"C.I.F." Three Rivers Charcoal Pig Iron**

Suitable for Car Wheels, Cylinders and Fine Castings, where the utmost strength is required.

UNSURPASSED IN STRENGTH BY SWEDISH, RUSSIAN OR AMERICAN CHARCOAL IRON.

Offices: *Canada Life Insurance Bldg., Montreal.*

**Cast Iron Water Pipes**

From 1 in. to 12 in. Diameter.

BELL AND SPICOT. FLANGED. TURNED AND BORED  
 And Everything Necessary for a

*Complete Water or Gas System*

Supplied by The

**Londonderry Iron Co., LIMITED,**  
 LONDONDERRY, NOVA SCOTIA.

The Most Complete Iron Works in Canada. } ... Established 1852.

SEND FOR DRAWINGS AND ESTIMATES OF OUR WORK.

ALL PIPES CAST VERTICALLY.

- We Make...**
- Pig Iron .. .. .
  - Water Pipes .. .. .
  - Bar Iron .. .. .
  - Puddled Bar .. .. .
  - Hydrants .. .. .
  - Valves .. .. .
  - Pipe Specials .. .. .
  - Heavy Castings .. .. .
  - Iron Rails .. .. .
  - Structural Work.. .. .
  - Architectural Work .. .. .
  - Machine Work .. .. .
  - Corporation Service and Valve Boxes .. .. .

**THE NOVA SCOTIA STEEL CO., LIMITED**

MANUFACTURERS OF

**BRIGHT COMPRESSED STEEL SHAFTING**

FROM 3/8 TO 5 INCHES IN DIAMETER. GUARANTEED STRAIGHT AND TRUE TO WITHIN 1/16 OF AN INCH.

Spring, Reeled Machinery, Tire, Toe Caulk, Sleigh Shoe, Angles, Special Sections and all Merchant Bar Steel. Sheet Steel up to 48 inches wide.

**RAILWAY AND ELECTRIC RAILWAY CAR AXLES**  
**FISH PLATES, SPIKES AND TRACK BOLTS**

Tee Rails, 12, 18, 24 and 28 lbs. per yard

**HEAVY FORGINGS a SPECIALTY.**

**"FERRONA" PIG IRON, For Foundry Use.**

Works—NEW GLASGOW, N.S., and FERRONA, N.S.

Head Office—NEW GLASGOW, NOVA SCOTIA

**FIRE PROTECTION.**

INDICATOR VALVES. CHECK VALVES.  
 INDICATOR POSTS.  
 FIRE HYDRANTS. CAST IRON PIPE.

For the modern equipment of your Mill with Automatic "Sprinkling System," write us.  
 We manufacture a full line of these goods.

**ST. LAWRENCE FOUNDRY CO.**  
 OF TORONTO (Limited),  
 TORONTO, - CANADA.

**The Wellington Mills, LONDON, ENGLAND**

**GENUINE EMERY**

Oakey's Flexible Twilled Emery Cloth.  
 Oakey's Flint Paper and Glass Paper.  
 Oakey's Emery Paper, Black Lead, Etc.  
 Prize Medal and Highest Award Philadelphia, 1876, for Superiority of Quality, Skillful Manufacture, Sharpness, Durability, and Uniformity of Grain.

Manufacturers....

**JOHN OAKEY & SONS, Ltd.,** Wellington Mills, Westminster Bridge Road, London, Eng.

Inquiries should be addressed to

**JOHN FORMAN, 850 CRAIG ST., MONTREAL.**

**SHUTTLES**



BOBBINS  
SPOOLS  
PICKER  
STICKS  
CLOTH  
ROLLS, Etc.

JOHN HOPE & CO., - - LACHUTE, QUE.

**Penman Manufacturing Co., Limited**  
PARIS, ONTARIO.

Manufacturers of

HOSIERY, SHIRTS, DRAWERS,  
GLOVE LININGS AND YARNS

Selling Agents: D. MORRICE, SONS & CO., Montreal and Toronto.

**ROSAMOND WOOLEN COMPANY**

ALMONTE, ONT.

FINE TWEEDS, CASSIMERES, AND FANCY  
WORSTED SUITINGS AND TROUSERINGS.

**FERGUSON & PATTINSON**

PRESTON, - - ONTARIO.

MANUFACTURERS OF

*FINE AND MEDIUM TWEEDS*

**Guelph Woolen Mill Co., Limited**

GUELPH, - - - ONTARIO

Manufacturers of

Underwear, Hosiery, Wheeling, Fingering and Worsted Yarns  
EIDERDOWN FLANNEL, ETC.

Selling Agents - Donald Fraser, Montreal F. H. Walsh & Co., Toronto.

**AUBURN WOOLEN COMPANY**

PETERBOROUGH, ONT.

Manufacturers of Fancy Tweeds, Etc.

Selling Agents, D. MORRICE, SONS & CO., Montreal and Toronto.

**GALT Machine Knife Works**

PETER HAY,



GALT, ONT.

Manufacturer of every  
description of...

**KNIVES**

For Wood-Working, Paper Cutting and

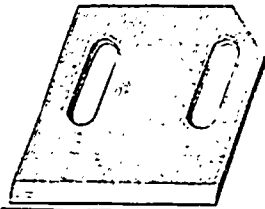

BARK  
KNIVES  
PULP  
KNIVES  
RAG  
KNIVES  
Etc., Etc.



Leather-  
Splitting  
Machines

Shear Blades,  
Straw Knives,  
Paper Knives,  
Etc., Etc.

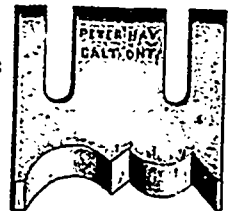

QUALITY GUARANTEED

SPECIAL KNIVES MADE TO ORDER

SEND FOR PRICE LIST

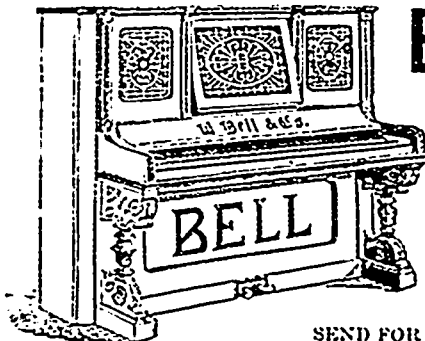

**BELL -**

HIGH-CLASS  
INSTRUMENTS

Used and  
Recommended by

Leading . . .  
. . . Musicians

SEND FOR CATALOGUE.

**The BELL ORGAN AND PIANO CO., Limited**

GUELPH, - - ONTARIO

**IT LEADS THEM ALL**

THE OLDEST  
THE LARGEST

THE SAFEST  
THE CHEAPEST

Canadian Life Insurance Company is

**The CANADA LIFE ASSURANCE CO.**

CAPITAL AND FUNDS OVER \$13,000,000

WRITE FOR PROSPECTUS

A. G. RAMSAY,  
President.

GEO. A. & E. W. COX,  
Managers for Toronto  
and Eastern Ontario.

**FIRSTBROOK BROS**

Dovetail and Packing Boxes

Top-Pins, Side Blocks and Cross Arms. Wood  
Printers, Etc.

Cigar Boxes. Shipping Cases.

TORONTO, - - ONTARIO

Write for Prices.

**THE PARIS ELECTRO-PLATING CO.**

Manufacturers of

Stove Trimmings, Organ and Piano  
Trimmings, also all kinds of  
Brass and Nickel Plating Done

Paris Station, - - Ontario

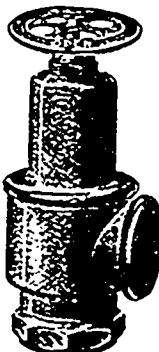

Underwriter

**CROSBY STEAM GAGE  
AND VALVE CO.**

Sole Proprietors and Manufacturers of

Cro-by Pop Safety Valves, for all kinds of Boilers, Water Relief Valves including  
the Underwriter, which is fully approved by the Associated Factory Mutual  
Insurance Companies; Crosby Steam Engine Indicators, with Sar-  
gent's Electrical Attachment; Crosby Improved Steam  
Gages, Recording Gages and Patent Gage Testers.  
Original Single Bell Chime Whistles.

BRANDEN PATENT PUMP VALVES

CLARK'S LINEN FIRE HOSE AND ADJUSTABLE COUPLINGS

All Kinds of Pressure and Vacuum Gages used in the Various Arts

Gold Medal Paris Exposition, 1889  
Ton Highest Awards Columbian Exposition, 1893

Main Office and Works..... BOSTON, MASS, U.S.A.  
Branch Offices at New York, Chicago, and London, Eng.

# The Goldie & McCulloch Co., (Limited)

GALT, - - - - - ONT.

MANUFACTURERS OF

## STEAM ENGINES, BOILERS, WATER WHEELS

Flouring and Saw Mill Machinery, Wood Working Machinery, Wool Machinery.  
 Fire and Burglar Proof Safes, Vault Doors. Wood Rim Split Pulleys,  
 Friction Pulleys, Friction Clutch, Couplings, etc.

**"Dumfries Foundry," - - Galt, Ontario, Canada.**

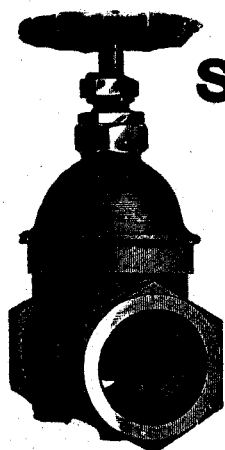

The WEBBER Patent  
**Straitway Valve**

For Steam, Water or Gas.

EVERY VALVE TESTED.

**The Kerr Engine Co. Limited**

WALKERVILLE, ONT.

SOLE MANUFACTURERS FOR CANADA.  
 SEND FOR PRICE LIST.

## HAMILTON COTTON CO.

HAMILTON, ONTARIO.

**Yarn Manufacturers  
 Dyers and Bleachers**

Warp Yarns of all descriptions, in Skein, Chain, or on Beams.  
 Hosiery Yarns in Single or Double; in Cop, Skein or Cone.  
 Yarns of all kinds for Manufacturers' use.

**Twines, Lampwicks, Webbing, Etc.**

Dyeing of all colors, including GENUINE FAST BLACK.

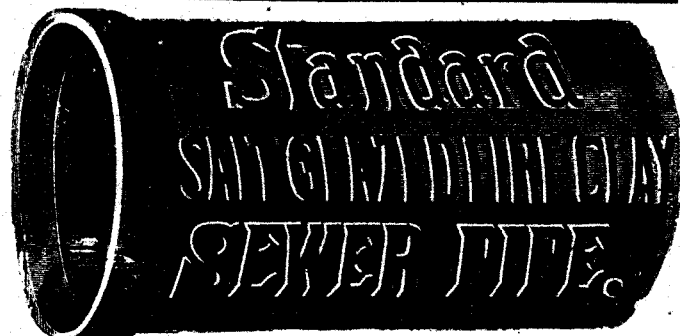

**THE STANDARD DRAIN PIPE COMPANY, ST. JOHN'S, P.Q.**

Manufacturers of Salt Glazed Vitrified Sewer Pipes, Double  
 Strength Railway Culvert Pipes, Inverts, Vents, and  
 all kinds of Fire Clay Goods.

The Standard Drain Pipe Co. of St. John's, P.Q., Ltd. *W. C. TROTTER  
 President.*

REGISTERED..... BRAND

**The Sampson Brand** IS A HIGH GRADE OF

**Portland Cement.**

..UNIFORM.. ..FINELY GROUND.. ..RELIABLE..

Quality equal to the best English and German Brands.  
 Manufactured by the

**Owen Sound Portland Cement Co., LIMITED**  
 SHALLOW LAKE, - - - - - ONTARIO.

The City of Toronto have contracted with us to supply  
 our Sampson Brand Portland Cement for the requirements  
 of the whole City for 1897 and 1898.

For Prices and further information address the Manager at Works,  
 Shallow Lake, Ont., or

**JOHN LUCAS, 377 Spadina Ave., Toronto, Ont.**  
 Correspondence Solicited.

## - PHOENIX - Assurance Company, OF LONDON, ENGLAND.

ESTABLISHED 1782. Agency Established in Canada, 1804.

**PATERSON & SON,**

General Agents for the Dominion,

35 St. Francois Xavier Street, Montreal.

LEWIS MOFFATT & CO., Agent at Toronto.

## Canadian Colored Cotton Mills Company

1897—FALL—1897.

...

**Cottonades, Tickings, Denims, Awnings, Shirtings,  
 Flannelettes, Gingham, Zephyrs, Skirtings,  
 Dress Goods, Lawns, Crinkles, Cotton  
 Blankets, Angolas, Yarns, etc.**

WHOLESALE TRADE ONLY SUPPLIED.

**D. MORRICE, SONS & CO., AGENTS**  
 MONTREAL and TORONTO.

USE THE MCGASKILL STANDARD VARNISHES

McGASKILL, DOUGALL & CO.

Montreal, Que.

SATISFACTION GUARANTEED

**BELLHOUSE,  
DILLON & CO.**

SOLE AGENTS FOR THE  
UNITED STATES AND CANADA.

The West Indies Chemical Works  
LIMITED, JAMAICA.

MAKERS OF THE FINEST QUALITY OF  
EXTRACTS OF  
**LOGWOOD.**

28 Colborne St., - - - TORONTO.  
30 St. Francois Xavier St., MONTREAL.  
20 Cedar St., - - - NEW YORK.



The Ontario . . .  
**Malleable Iron Co.**

(Limited)

....Manufacturers of....

**MALLEABLE IRON** . . . . . Castings to Order for all kinds of

**AGRICULTURAL IMPLEMENTS** .

....AND....

Miscellaneous Purposes . . . .

OSHAWA, - - - ONT.

**Canada Chemical  
Manufacturing Co.**

Manufacturers of

Sulphuric, Nitric, and Muriatic  
Acids - Commercial and  
Chemically Pure.

Mixed Acids for Explosives.

Liquid Ammonia, Glauber Salts,  
Copperas, Muriate Tin,  
Tin Crystals, Acetic Acid, Nitrate  
Iron, Bisulphite Soda,  
Acid Phosphate for Baking Pow-  
ders and General Chemicals.  
Fertilizers, etc

LONDON,  
ONT.

BRISTOL'S PATENT  
**STEEL BELT LACING**

— ONE HUNDRED SIZES —



READY TO APPLY FINISHED JOINT

Greatest Strength with Least Material

EASILY APPLIED and LOW IN PRICE

Saves Time, Saves Belts, Saves Money  
SAMPLES SENT FREE

THE **BRISTOL CO.**  
WATERBURY, CONN.

**SMITH'S FALLS**

**Malleable  
Iron . . . .  
Works . .**

00000

CAPACITY 2,000 TONS.

00000

**WILLIAM H. FROST**

PROPRIETOR,

SMITH'S FALLS,  
ONTARIO, CANADA.



Manufacturers of

**FINE VARNISHES**

Japans—Asphaltums—Shellacs

**Maple Leaf Brand Coach Varnishes**



**J. H. FARR & CO.**

**Armature Insulating Compound**

Insulating Compound for Weather-Proof Wire, Tube  
Compound, Mica Paste, etc., etc.

6 to 16 MORSE STREET  
TORONTO



**CARRIER, LAINE & CO.**  
LEVIS, P.Q.

ENGINEERS, FOUNDERS, MACHINISTS,  
BOILER MAKERS AND  
GENERAL CONTRACTORS

Montre  
147 t. James St.  
Quebec Br. sh....  
263 St. Joseph St.

PLUMBAGO FOR ALL PURPOSES. SILVER LEAF, FOUNDRY FACINGS, FOUNDRY SUPPLIES. THE DOMINION FOUNDRY SUPPLY CO. 22-24 St. George Street, MONTREAL.

OAK TANNED BELTING. TELLOW'S ENGLISH CARD CLOTHING. ROBERT S. FRASER, Reeds—Mill Supplies. Sheets and Fillet Stock in Montreal. 3 ST. HELEN STREET, MONTREAL.