

Technical and Bibliographic Notes / Notes techniques et bibliographiques

The Institute has attempted to obtain the best original copy available for scanning. Features of this copy which may be bibliographically unique, which may alter any of the images in the reproduction, or which may significantly change the usual method of scanning are checked below.

L'Institut a numérisé le meilleur exemplaire qu'il lui a été possible de se procurer. Les détails de cet exemplaire qui sont peut-être uniques du point de vue bibliographique, qui peuvent modifier une image reproduite, ou qui peuvent exiger une modification dans la méthode normale de numérisation sont indiqués ci-dessous.

- Coloured covers /
Couverture de couleur
- Covers damaged /
Couverture endommagée
- Covers restored and/or laminated /
Couverture restaurée et/ou pelliculée
- Cover title missing /
Le titre de couverture manque
- Coloured maps /
Cartes géographiques en couleur
- Coloured ink (i.e. other than blue or black) /
Encre de couleur (i.e. autre que bleue ou noire)
- Coloured plates and/or illustrations /
Planches et/ou illustrations en couleur
- Bound with other material /
Relié avec d'autres documents
- Only edition available /
Seule édition disponible
- Tight binding may cause shadows or distortion
along interior margin / La reliure serrée peut
causer de l'ombre ou de la distorsion le long de la
marge intérieure.

- Additional comments /
Commentaires supplémentaires:

Continuous pagination.

- Coloured pages / Pages de couleur
- Pages damaged / Pages endommagées
- Pages restored and/or laminated /
Pages restaurées et/ou pelliculées
- Pages discoloured, stained or foxed/
Pages décolorées, tachetées ou piquées
- Pages detached / Pages détachées
- Showthrough / Transparence
- Quality of print varies /
Qualité inégale de l'impression
- Includes supplementary materials /
Comprend du matériel supplémentaire
- Blank leaves added during restorations may
appear within the text. Whenever possible, these
have been omitted from scanning / Il se peut que
certaines pages blanches ajoutées lors d'une
restauration apparaissent dans le texte, mais,
lorsque cela était possible, ces pages n'ont pas
été numérisées.

The Canadian Patent Office

RECORD

Vol. XVII.—No. 6.

JUNE, 1889.

{ Price in Canada \$2.50 per An.
United States - \$2.50 "

INVENTIONS PATENTED.

NOTE—Patents are granted for 15 years. The term of years for which the fee has been paid, is given after the date of the patent.

No. 31,470. Tree and Plant Setting Machine. (*Machine à planter les arbres et arbrisseaux*)

Thomas A. Stratton, Lincoln, Neb., U.S., 1st June, 1889; 5 years.

Claim.—1st. The combination, with the main frame A, of the vertically adjustable beam D₂ and frame D₆, walking wheel F having levers G and provided with clamps G₃, and archway E having clamps I to hold and release the trees, substantially as set forth. 2nd. The combination, with the main frame A, of the vertically adjustable beam D₂, and frame D₆ having the rotary cutter C, flow D, sub-soil flow D₃, land sides D₄ and covers J for opening and closing the soil, substantially as set forth. 3rd. The combination, with the main frame A, of the lever N, crank shaft M, links M₃, M₆ and rod M₇ for adjusting the beam D₂ and frame D₆, substantially as set forth.

No. 31,471. Grooving or Routing Machine. (*Machine à rainure et languette.*)

James A. Harvey, Toronto, Ont., 1st June, 1889; 5 years.

Claim.—A cutter on the end of the vertically-adjustable spindle A, carried in suitable bearings on the jointed arm C, and actuated by the adjustable pivoted spring plate E, in combination with the pivoted guide plate I, arranged substantially as and for the purpose specified.

No. 31,472. Metal Wheel. (*Roue métallique.*)

Henry R. Bothwell, Toronto, Ont., 1st June, 1889; 5 years.

Claim.—An axle-box A, having a flange or axle B near each end, in combination with a concave cap D fitted over the axle A, and a collar B having a series of holes a separated by the curved seats b, substantially as and for the purpose specified.

No. 31,473. Elastic Draft for Vehicles.

(*Volée à ressort d'arrière de voiture.*)

Albert B. Webster, Manchester, N.H., U.S., 1st June, 1889; 5 years.

Claim.—In a tug holder, the combination, with an elongation spring a₃, having one end fastened to a stationary part of the vehicle, of a draw-bar b₁ extended through a bearing b₂ and connected to the said spring, whereby the said spring is elongated when the draw-bar is drawn upon, substantially as described.

No. 31,474. Truss. (*Bandage herniaire.*)

George W. Bell, St. Joseph, Mo., U.S., 1st June, 1889; 5 years.

Claim.—1st. In a truss, the combination of the band A, a plate E and the spring G, the set screw, the adjustable arm L pivoted on the set screw, and the pad attached to the arm L, all constructed and arranged substantially as specified. 2nd. In a truss, the combination, with the band A having the plate E, of the spring G having a series of perforations K, the adjustable arm L, the set screw I, the pin O on the arm L to engage the perforations K, and the pad attached to the arm L, substantially as specified. 3rd. In a truss, the band A having the spindle C, the socket D, the clamping device to hold the socket at any desired position, the arm L pivoted to the socket D and capable of angular adjustment independent of the socket, the collar V disposed on the arm L and provided with a set-screw, whereby the collar is capable of axial and longitudinal adjustment on the arm L, and the pad swivelled to the spindle U, connected to the collar V, so that the pad may be rotated or turned, as set forth. 4th. The herein described pad, comprising the body having an angular shoulder on its rear side, the flat coiled spring having its coils nested together, one within the other, in the same plane, the outer coils bearing on the pad within the shoulder, the plate secured to the body and projecting over the outer coils to confine them in place, and the spindle

U passed through the centre of the spring and swivelled, as set forth. 5th. In a truss, the combination, with the band having a spindle C on one end of the socket D mounted on the spindle, and having set screws to impinge at their ends against the spindle, the said socket having a plate E at its free end provided with a central tapped aperture F, the spring G mounted on the socket adjacent to the said plate, and having an aperture H therein aligning with the aperture F, the set-screw mounted in the aligned apertures, the movable arm L mounted on the said screw, and the pad attached to the arm L, substantially as and for the purpose specified. 6th. In a truss, the combination, with the band having a rigid spindle C on one end, and the socket D adjustably mounted on the spindle, and having a plate E provided with the central aperture F, of the spring G secured to the socket D adjacent to said plate, and having a central aperture H, aligned with the aperture F, and the semi-circular series of perforations K, arranged around the central aperture, the set screw I engaging the aligned apertures, the arm L mounted on the set-screw facing the spring and the plate, and having a pin O on its outer side engaging in one of the perforations K, and the pad attached to the said arm, substantially as and for the purpose specified.

No. 31,475. Finger Shield and Fountain Attachment. (*Garde-doigtet fontaine.*)

James Patmor, Pittsburg, Kan., U.S., 1st June, 1889; 5 years.

Claim.—1st. A combined fountain attachment and finger shield, comprising the coil of wire, and the shield adapted to slide upon a pen and close the base of the coil upon a pen and close the base of the coil, substantially as described. 2nd. A combined fountain attachment and finger shield, comprising the coil of wire, and the shield secured to the coil and closing the base thereof, and provided with a semi-circular slot to receive the pen, substantially as described. 3rd. A combined fountain attachment and finger-shield, comprising the wire coil and the shield having a semi-circular pen-slot, and provided with a projection fitting within the base of said coil, and affording means whereby the coil is secured to the shield, substantially as described.

No. 31,476. Musical Instrument.

(*Instrument de musique*)

Edwin R. Norcross and Mary M. Albright, Fayetteville, Ark., U.S., 1st June 1889; 5 years.

Claim.—1st. The combination, with the keys, of the bell-crank levers, the sliding head-blocks having elongated slots formed therein to one side of the centres thereof, the pickers connected with the head blocks and secured to slides below the same rods connecting the respective levers and keys and the wires, substantially as described. 2nd. The combination, with the casing, the wires and keys, of the bell-crank levers mounted near the upper end of the casing, rods connecting the same with the keys, the head-blocks F connected with the levers, the slides G on which the head-blocks are mounted, the guide strips e₂, the pickers H mounted loosely on the slides and having an eccentric connection with the head-blocks, and springs for forcing the slides back, substantially as described. 3rd. The combination, with the casing, the pedals and keys, of rods attached to the keys, bell-crank levers connected with the rods, slides connected to the levers, pickers on the slides, head-blocks for rotating the pickers, a series of oscillating shafts connected with the pedals, a series of rocking levers located above and connected with the shafts, levers having connections with said rocking levers, frets on said levers, and springs for forcing the frets and pickers out, substantially as described. 4th. The combination, with the casing and wires, of the keys, the rods d, the arms D, the rods d', the levers B, the head block F connected therewith, the slides G, the guides e₂, the pickers H mounted on the slides and concentrically connected with the head-blocks, said pickers being constructed with a rounded inner end and a finger A, and springs for drawing the slides back, substantially as described. 5th. The combination, with the keys and wires, of pickers operated by the keys consisting of a circular disk, having a finger extending out therefrom, and having a central and an eccentric opening therein, a slide for moving the picker forward and back, and a head-block for oscillating the same, substantially as described. 6th. The combination, with the casing of a musical instrument, of a series of pedals, a series of oscillating shafts connected with the

pedals, a series of rocking levers mounted on a cross piece, a connecting rod or cord between the same and the shafts, a lever having connection with said rocking lever and frets on said lever, substantially as described. 7th. The combination, with the keys and the rods connected therewith, of the bell-crank lever, a slide having an elongated slot formed therein on one side of the centre thereof, a finger on the slide and opening in the said finger, a connecting link between the bell-crank lever and the slide, a slide below said other slide, a picker on said lower slide having a connection with the upper slide and the strings or wires, substantially as described.

No. 31,477. Metallic Ladder. (*Echelle métallique.*)

Joseph R. Smith and James H. Connor, Ottawa, Ont., 1st June, 1889; 5 years.

Claim.—1st. In a flexible metallic ladder, consisting of cables A, hollow rungs B, provided with holes, as arranged and for the purpose hereinbefore set forth. 2nd. In a flexible metallic ladder, rungs B having nut or cap D, washer and collar C, in combination with pin H, as arranged and for the purpose hereinbefore set forth. 3rd. In a flexible metallic ladder, cables A, rungs B, in combination with cap C, provided with arms E and F, and eye Ft to receive arm G, the whole as arranged and for the purpose hereinbefore set forth.

No. 31,478. Device for Sharpening Razors.

(*Appareil pour aiguiser les rasoirs.*)

Peter J. Caesar, Fergus Falls, and Andrew B. Pedersen, Rothsay Minn., U.S., 1st June, 1889; 5 years.

Claim.—The combination in a razor or knife sharpener, with the handle, of a frame pivotally secured therein, and a shaft provided with a razor or knife-holder mounted in said frame, and adapted to be turned upon its axis of the frame is swung upon its pivot, substantially as described.

No. 31,479. Device for Killing Flies.

(*Appareil pour tuer les mouches.*)

John B. Kibler, Minneapolis, Minn., and Hugh Moore, Newburgh, N. Y., U.S., 1st June, 1889; 5 years.

Claim.—A device for poisoning flies, consisting of a suitable vessel containing the poison, a cover for such vessel provided with apertures, and suitable wicks therein having their ends exposed, substantially as set forth.

No. 31,480. Return-Vent Protector for Plumbers' Traps. (*Valve de protection contre la fuite des gaz des sièges d'absence.*)

William B. Ryan and Patrick Ryan, Boston, Mass., U. S., 1st June, 1889; 5 years.

Claim.—In a plumber's trap, the combination, with the return-vent pipe, of a buoyant ball placed within a cage beneath the open mouth of the vent-pipe, and adapted to close the same when the outlet pipe becomes obstructed and the water rises within the trap, substantially as set forth. 2nd. In a plumber's trap, the combination, with the vent-pipe D and the screw-cap C through which it passes, of the cage G depending from the under side of the cap C, and the buoyant ball *b* inclosed within said cage, and supported thereby beneath the open mouth of the vent-pipe, substantially in the manner and for the purpose described. 3rd. The combination, with a plumber's trap, provided with a casing or receptacle B connected therewith, of the screw-cap C fitting within the top of the casing B, and having the cage G secured to and depending from its under side, the vent-pipe D passing through the cap C, and the ball *b* inclosed within the cage G and supported thereby beneath the open mouth of the vent pipe, substantially as and for the purpose set forth.

No. 31,481. Sewing Machine Pedal.

(*Pédale de machine à coudre.*)

Alfred A. Laviolette (assignee of Odile Feher), St. Jérôme, Qué., 1st June, 1889; 5 years.

Claim.—The pedals D, D, G, G, joined to the connecting rods E, E by means of the pins F, F, in combination with the double-cranked shaft H, the cross-piece C and ordinary fly wheel J, all as above described and for the purposes set forth.

No. 31,482. Machine for Assorting Broom Corn. (*Machine à assortir la houque à balai.*)

The Hand Stitch Broom Sewing Machine Company, Pittsburgh, Penn. (assignee of Charles E. Lippe, Syracuse, N.Y.), U.S., 1st June, 1889; 5 years.

Claim.—1st. The improved broom corn assorting machine consisting of the table A formed with the successively enlarged openings O, O, two shafts *b, b* arranged respectively at opposite ends of the table, a series of pulleys on each of said shafts, and the conveying belts C, C, all carried on the pulleys for the aforesaid two shafts, and unsupported between their carrying pulleys to allow the belts to vibrate vertically, substantially as and for the purpose set forth. 2nd. In combination with the assorting table A formed with the successively enlarged opening O, O, conveyors C, C, over said table, chutes D, D under the said openings, and bins B, B beneath the respective chutes, the gates *a, a* interposed between the chutes and bins and inclined in opposite direction from the delivery sides of the chutes, substantially as described and shown. 3rd. In combination with the assorting table A formed with the successively enlarged openings O, O, conveyors C, C, over said table, chutes D, D each composed of two plates *d, d'* inclined toward each other, and having the bottom edge of the plate *d'* extending beneath that of

the plate *d*, and bins B, B beneath the said chutes, the gates *a, a* hinged at one edge under the plates *d, d'*, and their free edges adapted to swing toward the bottom edges of the plates *d, d'*, the rod *e* connected to the gates and the lever *l* connected to the said rod, substantially as described and shown.

No. 31,483. Compound for Coating Coffee.

(*Composition pour lustrer le café.*)

John T. Barnes (assignee of Frederick W. Moore), Philadelphia, Penn., U.S., 1st June, 1889; 5 years.

Claim.—1st. A compound for coating or glazing coffee, composed of milk, glue, glycerine, and lard, substantially as herein set forth. 2nd. A compound for coating or glazing coffee, consisting of milk, glue, glycerine and lard, with the addition of one or more other ingredients, substantially as set forth.

No. 31,484. Holdback for Vehicles.

(*Ragot de limonière.*)

George T. Wilson (co-inventor with John D. Hough), Lowville, N. Y., U.S., 1st June, 1889; 5 years.

Claim.—The combination, with the chambered body formed with hollow standard, and the spring secured at one end within said body, of the hook having a vertical position in said hollow standard, and a heel pivoted within said body, and formed with the flat sides *l* and *m* bearing on said spring, substantially as shown and described and for the purposes specified.

No. 31,485. Armature for Dynamos.

(*Armature de dynamo.*)

The Thomson Houston International Electric Company, Boston (assignee of Elihu Thomson, Lynn), Mass., U.S., 1st June, 1889; 5 years.

Claim.—1st. In a ring-armature for dynamo-electric machines or motors, a laminated core having a notch or gap at one side for the insertion of the coils, closed magnetically by a laminated plug or bundle fitted tightly into the notch or gap, to complete or restore the magnetic circuit after application of the coils, in combination with suitable fastening devices for holding said plug against displacement by revolution of the armature. 2nd. In a ring-armature, a laminated ring-core having a notch or gap at one side, filled by a laminated plug fitted tightly therein, with the ends of its laminae abutting against and closing the magnetic circuits for the laminae of the body of the core in combination with coils applied over said plug and binding-rings of wire for holding the coils and plug in place. 3rd. In a ring-armature a laminated ring-core having a gap or notch at one side closed by a tightly fitting plug or bundle of plates abutting against the ends of the plates of the body of the core so as to close the magnetic circuits of the latter, and form practically a uniform continuous laminated ring-armature, as and for the purposes described.

No. 31,486. Railway Rail Joint Fastener.

(*Arrête-écrou de joint de rail de chemin de fer.*)

Nelson Rowen and Robert Savage, Rookvale, Col., U.S., 1st June, 1889; 5 years.

Claim.—In a bolt and nut lock, the use of a cam lever for tightening the bolt, and adapted to have its end bent, whereby it is held from turning back, substantially as hereinbefore specified.

No. 31,487. Playing Card. (*Carte à jouer.*)

Robert F. Foster, Baltimore, Md., and Alexander J. Leith, New York, N.Y., U.S., 4th June, 1889; 5 years.

Claim.—1st. A pack of cards in which each card used in the game is provided with an indicator designating the order in which the cards for each player should be arranged, substantially as described. 2nd. A pack of cards in which each card used in the game is provided with an indicator designating the order of playing in a pre-arranged game, substantially as described. 3rd. A pack of cards in which each card used in the game is provided with two indicators, one distinguishing the card from those of other players, and the other designating the order in which the card should be played in a pre-arranged game, substantially as set forth. 4th. A pack of cards in which each card used in the game is provided with two series of indicators designating the cards of different players and the order of playing, in a series of pre-arranged games, substantially as set forth. 5th. A pack of cards in which each card used in the game is provided with an indicator designating the cards of the different players and the order of playing in pre-arranged games and with a third designating the order of the games, substantially as set forth.

No. 31,488. Tubular Lantern.

(*Lanterne tubulaire.*)

James Lind, Liverpool, Eng., 4th June, 1889; 5 years.

Claim.—1st. In a tubular lantern, forming the bottom of the globe with a flange fitting or its equivalent in order to hinge the same for the purpose of lighting or trimming the lantern, substantially as described. 2nd. In a tubular lantern, securing the globe to the globe rest by means of set screws, or set screw and clip operating in the flange moulded in the glass globe with corresponding provision in the globe rest, as set forth and as shown. 3rd. In a tubular lantern, the use of a band of spring metal or wire for the purpose of clasping and hinging back the glass globe, as set forth. 4th. In a tubular lantern, the combination of the spring globe holders C, C operating in the flange or groove A, the globe guards D, E, the hinge J and the spring X, substantially as described. 5th. In a tubular lantern, the attaching of a suitable hinge to the upper half or dome of the burner, as set forth. 7th. In a tubular lantern, the combina-

tion of the upper half or dome of the burner V hinged at L, with the globe rest T, the guards D, F, the set screw and clip S, S and the spring X, substantially as described. 8th. In a tubular lantern, the spring X for retaining the globe in position, as set forth. 9th. In a tubular lantern, the spring W attached to the top of the lantern, and operating upon the cross bar QI, of the wire guards D F at R for retaining the globe in position, as set forth and shown. 10th. In a tubular lantern, the removable guards D, F, as set forth and shown, acting in suitable grooves made either around the top or bottom of the globe. 11th. In a tubular lantern, the arrangement of metal O with part thereof cut away at Q, and the movable part P, substantially as and for the purpose specified. 12th. In a tubular lantern, the cranking or shaping of the handle S, S at R, R, substantially as and for the purposes specified. 13th. In tubular lanterns, the general arrangement and construction of the various parts herein described, consisting of the groove or flange A in the globe B, the set screw and clip S, S in the globe rest T, the guards D, F, the spring wires C, C, the cross bar QI, the hinge placed at J or L, the spring X, the clip spring W, the metal Q and O and the crank R, substantially as and for the purposes specified.

No. 31,489. Gate. (*Barrière.*)

Arthur J. Mercer, Islington, Ont., 4th June, 1889; 5 years.

Claim.—1st. The mode in which the gate is suspended with posts J, cross pieces H, braces I, I, I, pieces G, rods and chains M, M, M, arms K, K with slots L, L, braces P, P, combination of rope and weight N, N with upper part of gate. 2nd. The combination of rope V and pulley X with lever Q, substantially as and for the purpose hereinbefore set forth. 3rd. The cross pieces U, U, substantially as and for the purpose hereinbefore set forth.

31,490. Mortise Lock. (*Serrure cachée.*)

Osborne R. Cooke, Salem, Ohio, U.S., 4th June, 1889; 5 years.

Claim.—1st. The combination, with knob, spindle, hub and bolt, substantially as indicated, of links operatively connecting such bolt and hub, whereby the bolt is withdrawn by turning the hub in either direction, substantially as set forth. 2nd. The combination, with cylindrical casing in halves and securing screw, of vibrating tumblers fulcrumed on such securing screw, such tumblers operating in a central slot of the bolt, whereby the bolt is locked or released by elevating or depressing the tumblers, substantially as set forth. 3rd. In combination, slotted bolt vibrating tumblers operating therein, the bolt having an incline for engaging the end of the tumblers in the elevated position of the latter, substantially as set forth. 4th. In combination, bolt having inclined wall, vibrating tumblers for engaging such inclined wall, whereby the elevation of the tumblers locks the bolt and insures a full outward throw of the bolt, substantially as indicated, sliding yoke for blocking the tumblers in their elevated position, the tumblers and yoke having interlocking shoulders for holding the parts in position locking the bolt, substantially as set forth.

No. 31,491. Device for Moistening Tobacco.

(*Appareil pour humecter le tabac.*)

John McPherson, Wellsville, N.Y., U.S., 4th June, 1889; 5 years.

Claim.—The combination of a receptacle for tobacco and other material, with a vessel made of suitable material, of such a shape that one of its sides is adapted to impinge against the inner side of the tobacco-receptacle, and having formed in that side apertures, ductile straps having their upper and lower ends bent to form hooks, the lower ones of which engage the apertures in the side of the vessel, and the other ones engaging the upper edge of the tobacco-receptacle, and hooks struck up from the body of the straps and extending downward toward the hooks at the lower ends thereof, substantially as set forth.

No. 31,492. Washing Machine.

(*Machine à blanchir.*)

Henry O. Kelsey and David H. Gibson, Salamanca, N.Y., U.S., 4th June, 1889; 5 years.

Claim.—1st. A box supported on a semicircular frame B or rockers, in combination with the beater F supported on the guide-rods G, substantially as and for the purpose specified. 2nd. A box supported on a semicircular frame B or rockers, and having perforated false ends H and slats I, in combination with the beater F supported on the guide-rods G, substantially as and for the purpose specified. 3rd. A box supported on a semicircular frame B or rockers, and having perforated false ends H, and slats I from which vertical fingers J project, in combination with the beater F supported on the guide-rods G, substantially as and for the purpose specified.

No. 31,493. Sled Brake. (*Frein de traîneau*)

Jacob R. Hoyt, Forest Home, Iowa, U.S., 4th June, 1889; 5 years.

Claim.—The compound lever sled brake comprising a rockshaft a having lateral bends b, the knuckles f, the detachable, adjustable and self sharpening brake bars d, the arm h, the lever m and connecting rod n, constructed and combined with the bench, the runners and the box of a sled, substantially as shown and described to operate in the manner set forth.

No. 31,494. Finish for Plastered Walls.

(*Badigeon pour les murs crépis.*)

Thomas Jones, Ravenswood, Ill., U.S., 4th June, 1889; 5 years.

Claim.—A finish for walls consisting of lime, raw gypsum, over-calced gypsum, and alum or its equivalents, in substantially the proportions stated.

No. 31. 495. Medical Compound.

(*Composition médicale.*)

Augusta M. McLeod, Goderich, Ont., 4th June, 1889; 5 years.

Claim.—In a medical compound, the combination of saltpeter, carbonate of ammonia, acetic acid, water, tincture of senega, tincture of ginger, tincture of camphor, compound tincture of lemon, tincture of Peruvian bark, compound tincture of rhubarb, glycerine, syrup of sarsaparilla, syrup of Tolu Tolu, syrup of squills, clarified honey, sherry wine and muriate of ammonia, as and for the purposes set forth.

No. 31,496. Clasp. (*Agrafe.*)

Mayer Ruben, Chicago, Ill., U.S., 4th June, 1889; 5 years.

Claim.—1st. The clasp or gripper, comprising two jaws pivoted together, and each jaw provided with teeth, and one of said jaws having a turn-button i, which acts on the other and keeps them closed. 2nd. The clasp or gripper, consisting of two jaws, one having two side slots j, and a tang l adjoining each slot, and provided with a turn-button, and the other having an offset m, and two right angles and two slots n in the offset, and a tongue o between the said two offset slots, a portion of each end of the said offset on one jaw occupying one of said side slots on the other jaw, as shown and described.

No. 31,497. Igniting and Extinguishing Apparatus. (*Appareil pour allumer et éteindre.*)

Henry A. Chapin, New York, N.Y., U.S., 4th June, 1889; 5 years.

Claim.—1st. The combination, with a lamp or gas burner, of a tube, and a scratcher arranged within said tube, substantially as and for the purpose specified. 2nd. The combination, with a lamp or gas burner, of a tube, a scratcher arranged within said tube, and a spring arranged within said tube, substantially as specified. 3rd. The combination, with a lamp or gas burner, of a tube, a scratcher arranged inside the tube, and a spring made integral with said tube, substantially as specified. 4th. The combination, with a lamp or gas burner, of a tube, a scratcher arranged at an incline to said tube, and a spring within said tube, substantially as specified. 5th. The combination, with a lamp or gas burner, of a tube, a scratcher arranged at an incline to said tube and within the same, and a spring within the tube rearwards of the scratcher, substantially as specified. 6th. The combination, with a lamp or gas burner, of a tube having two springs made integral therewith, and a scratcher on one of said springs, substantially as specified. 7th. The combination, with a lamp or gas burner, of a tube, a throat formed at the inner end of said tube, and a scratcher arranged within said throat, substantially as specified. 8th. The combination, with a lamp or gas burner, of a tube extending out to a point where it will be accessible to blow through for extinguishing the flame, substantially as specified.

No. 31,498. Corset. (*Corset.*)

Catherine A. Williamson, St. Louis, Mo., U. S., 6th June, 1889; 5 years.

Claim.—1st. The detachable shoulder straps 7 removably attached to the corset by a lacing 8, as set forth. 2nd. In a corset having detachable shoulder straps 7, the top connecting strip 6, having a downwardly cut upper edge, as set forth. 3rd. The eyelets 11 near the middle and ends of the stays 2, for retaining the bones or steels to the fabric of the corset, as set forth.

No. 31,499. Blueing Package. (*Boîte à bleu.*)

Theodore F. Conklin, Chicago, Ill., U.S., 6th June, 1889; 5 years.

Claim.—1st. A blueing package for laundry purposes, comprising multiple layers or thicknesses of absorbent material to retain the blueing, and held within a receptacle having a water-tight portion to catch the drip, substantially as described. 2nd. A blueing package for laundry purposes, consisting of multiple layers or thicknesses of absorbent material to retain the blueing, and held within a suitable water-tight receptacle to catch the drip, said receptacle being considerably larger in size than the layers or thicknesses of absorbent material retained therein to permit the access of water around the edges or surface of such layers, substantially as described. 3rd. A blueing package for laundry purposes, consisting of multiple layers or thicknesses of lamp-wicking or like pervious material to retain the blueing, and held within a receptacle having a water-tight portion to catch the drip, substantially as described.

No 31,500. Means for Locking Nuts or Bolts.

(*Moyens d'assujétir les écrous et boulons.*)

Frederick Purbrick, East St. Kilda, and Robert H. Stone, North Brighton, Victoria, 6th June, 1889; 5 years.

Claim.—In a nut-lock, as described, a nut having ratchet-teeth A, and a washer provided with a flat B, dog or pawl D and catch D₁, for the purposes set forth.

No. 31,501. Machine for Separating, Trimming and Grooving Stereotype Plates. (*Machine à séparer, ébarber et canneler les plaques stéréotypes.*)

John R. Cummings, Chicago, Ill., U.S., 6th June, 1889; 5 years.

Claim.—1st. The combination, with a combined stereotype separating, trimming and grooving machine, of the separating and trimming saw, and the grooving saw arranged so that their cutting planes are parallel to each other, as set forth. 2nd. The combination, with a combined stereotype separating, trimming, and grooving machine, of the separating and trimming saw, and the grooving saw secured to,

and revolving concentrically with one and the same shaft, and said shaft, as set forth. 3rd. The combination, with a combined stereotype separating and trimming saw, and grooving saw which is of less diameter than, and whose cutting plane is parallel with said separating and trimming saw, as and for the purpose set forth. 4th. The combination in a combined stereotype separating, trimming and grooving machine, with the saws I and J, of the reciprocating bed frame A, rock shaft M and presser plate n, substantially as set forth. 5th. The combination in a stereotype separating, trimming and grooving machine, with the saws I and J, of the rock shaft M, oscillating frames N and presser plate n, substantially as set forth. 6th. The combination in a stereotype separating, trimming and grooving machine, with saws I and J, of the reciprocating bed frame A, rock-shaft M, oscillating frames N, presser plate n and gauge-strip o, substantially as set forth. 7th. The combination in a stereotype separating, trimming and grooving machine, with the saws I and J, of the reciprocating bed frame A, rock shaft M, oscillating frames N, presser-plate n, rock-shaft N1, having eccentrics q thereon and links O, substantially as set forth. 8th. In a combined stereotype separating, trimming and grooving machine, the combination, with the saws I and J, of the bed frame A, the rock-shaft M having the uppermost segment of its periphery reduced longitudinally to the horizontal plane of the said bed plate and presser plate n. 9th. In a combined stereotype separating, trimming and grooving machine, the combination, with the saws I and J, of the feeding devices, consisting of the carrier heads B and means for moving the same transversely, substantially as set forth. 11th. In a combined stereotype separating, trimming and grooving machine, the combination, with the saws I and J, of the carrier heads B, shaft C, crank C1, pinion c, bed frame A and rack b2, as set forth. 12th. In a combined stereotype, separating, trimming and grooving machine, the combination, with the saws I and J, of the carrier heads b1, the segmental rock shaft C, crank C1, segmental pinion c, bed frame A and racks b2, as set forth. 13th. The combination in a stereotype separating, trimming and grooving machine, with the saws I and J, of the bed frame A, the carrier heads B, plates F, having lugs f arising from their forward ends, jaws G pivoted between said lugs and shaft g, having eccentric g1, as set forth. 14th. The combination, with a stereotype separating, trimming and grooving machine, of the bed frame A, racks b on the transverse side pieces thereof, carrier head B, platform b' thereof having lug d arising therefrom, block E, screw D and adjusting plate F1, as set forth.

No. 31,502. Recording Thermometer.

(*Thermomètre à registre.*)

William F. Brewster, New York, N. Y., U. S., 6th June, 1889; 5 years.

Claim.—1st. In a recording thermometer, the combination, substantially as set forth, of a recording sheet, a mechanism for moving the same, a metallic thermometer with its free end connected to an arm, a stylus on said arm, a holder independent of the recording sheet, a marking medium mounted on said holder and disposed between the recording sheet and stylus, and a hammer connected with the mechanism for moving the recording sheet, and arranged to strike the stylus against the marking medium and recording sheet at stated intervals of time, whereby the recording sheet will be caused to move and receive upon it marks made by the marking mechanism and stylus, when the latter is forced against said sheet by the action of the hammer, and thus make a record of the temperature during a given period of time. 2nd. In a recording thermometer, the combination, substantially as set forth, of a recording sheet, a mechanism for moving the same, a metallic thermometer with its free end connected to an arm, a stylus on said arm, a holder independent of the recording sheet, a marking medium mounted on said holder and disposed between the recording sheet and stylus, and independent time indicating devices connected with the mechanism for moving the recording sheet, whereby the time at which a record of the temperature is being made on the recording sheet can be readily read without disturbing the holder and marking medium mounted on said holder. 3rd. In a recording thermometer, the combination, substantially as set forth, of a recording sheet, a mechanism for moving the same, a metallic thermometer, a shaft connected with the free end of said thermometer and thereby rotated, an arm secured at an angle to said shaft and provided with a stylus, a holder independent of the recording sheet, a marking medium mounted on said holder and disposed between the recording sheet and the stylus, and a hammer connected with the mechanism for moving the recording sheet and arranged to strike the stylus against the marking medium and recording sheet at stated intervals of time, whereby the recording sheet will be caused to move and receive upon it marks made by the marking medium and stylus, when the latter is forced against said sheet by the action of the hammer, and thus make a record of the temperature during a given period of time. 4th. In a recording thermometer, the combination, substantially as set forth, of a recording sheet, a mechanism for moving the same, a metallic thermometer with its free end connected to an arm, a stylus on said arm, a movable holder independent of the recording sheet, a marking medium mounted on said holder and disposed between the recording sheet and the stylus, and a hammer connected with the mechanism for moving the recording sheet, and arranged to strike the stylus against the marking medium and recording sheet at stated intervals of time, whereby the said holder can be moved from between the recording sheet and stylus, or away from said recording sheet when it is to be changed, and also return to its position for making a record. 5th. In a recording thermometer, the combination, substantially as set forth of a recording sheet, a mechanism for moving the same, a metallic thermometer with its free end connected to an arm, a stylus on said arm, a holder independent of the recording sheet and carrying a marking medium, the medium being disposed between the recording sheet and stylus, and a compound lever constructed substantially as described and connected to the mechanism for moving the recording sheet, whereby the stylus will be forced against the marking medium and recording sheet with a quick blow, and the stylus will be quickly

relieved from the pressure of the hammer portion of said lever, and the stylus be left free to be moved by the bi-metallic thermometer, and a clearer and more nearly correct record be made. 6th. In a recording thermometer, the combination, substantially as set forth, of a recording sheet, a mechanism for moving the same, a metallic thermometer with its free end connected to an arm, a stylus on said arm, a movable holder independent of the recording sheet, said holder moving on a knife blade spring joint, a marking medium mounted on said holder and disposed between the recording sheet and the stylus, and a hammer connected with the mechanism for moving the recording sheet, and arranged to strike the stylus against the marking medium and recording sheet at stated intervals of time, whereby the said holder can be moved from between the recording sheet and stylus, or away from said recording sheet when it is to be changed, and also return to its position for making a record, and when so moved said holder will be held in either of two positions by the action of the knife blade joint. 7th. In a recording thermometer, the combination, substantially as set forth, of a recording sheet, a support for such sheet, mechanism for moving the recording sheet to make a record, and a movable connection between the recording sheet support, and the mechanism for moving the recording sheet to make a record, whereby the recording sheet with its support can be moved to connect or disconnect the recording sheet support to or from the mechanism for moving the recording sheet. 8th. In a recording thermometer, the combination, substantially as set forth, of a recording sheet, a mechanism for moving the same, a metallic thermometer with its free end connected to an arm, a stylus on said arm, a holder independent of the recording sheet and carrying a marking medium, the medium being disposed between the recording sheet and stylus, a compound lever, constructed substantially as described, and connected to the mechanism for moving the recording sheet, and a buffer spring, whereby the compound lever is more quickly moved away from the arm connected to the bi-metallic thermometer, and a more perfect record is made. 9th. In a recording thermometer, the combination, substantially as set forth, of a recording sheet, a mechanism for moving the same, a metallic thermometer with its free end connected to an arm, a stylus on said arm, a marking medium disposed between the stylus and recording sheet, and a hammer connected to the mechanism for moving the recording sheet, one portion of which is forked or split, substantially as described, whereby the recording sheet and its support is permitted to move between such forked portions, while the hammer is operated by the mechanism for moving the recording sheet.

No. 31,503. Manufacture of Copper.

(*Traitement du cuivre.*)

Percy C. Gilchrist, London, Eng., 6th June, 1889; 5 years.

Claim.—The purification and treatment of copper and copper matter, in basic or neutrally lined vessels in the presence of a basic slag, substantially as set forth.

No. 31,504. Suspender. (*Bretelle.*)

Burkhard Goodman, New York, N. Y., U. S., 6th June, 1889; 10 years.

Claim.—1st. As an improved article of manufacture, a suspender consisting of shoulder straps formed of warp cords or threads, interlaced or interwoven with braids or threads to form ventilating interstices or reticulations, having adjustable buckles carrying tabs, and a rear tab centrally secured thereto, substantially as described. 2nd. As an improved article of manufacture, a suspender consisting of shoulder straps formed of elastic warp cords, interlaced with braids to form ventilating interstices or reticulations having adjustable buckles carrying tabs, and a rear tab centrally secured thereto, substantially as described.

No. 31,505. Manufacture of Watch Cases.

(*Fabrication des boîtes de montres.*)

Frederic Ecaubert, Brooklyn, N. Y., U. S., 6th June, 1889; 5 years.

Claim.—1st. The annular die A having upon its interior surface a screw thread, in combination with the die or chuck G having a face 2 adjacent to the screw thread of the die A, and a suitable roller for pressing the sheet metal of the watch case center, lid or bezel against the screw threaded portion of the die A, and forming a screw thread thereon between the face 3 of the die A and the face 2 of the die G, substantially as set forth. 2nd. The annular die A having a screw thread upon its interior portion, and a face at 3, in combination with the die or chuck G having a face 2 adjacent to the screw thread, the ring die D for forming the ornament or pattern upon the outer surface of the watch case center, and a roll for pressing the sheet metal of the watch case center into contact with the surface of the annular dies A and D, substantially as set forth. 3rd. The combination, with the annular die A having a screw thread upon its interior face and the die G, of the annular die D, the die E', having annular grooves and the chuck E and the series of rolls applied successively as described for pressing the metal of the watch case center into the annular dies and thickening and folding over such metal, substantially as set forth. 4th. The combination, with a die having a screw threaded interior surface, of a roll having a cylindrical surface and acting against the inner surface of the sheet metal of the watch case, lid, or other article to force such metal outwardly into the screw thread, substantially as set forth. 5th. A die having a screw threaded interior surface, and otherwise of the shape of the interior of the watch case center, bezel or lid, in combination with a roll having a cylindrical portion to act against the metal to force it into the screw thread, and peripheral ribs to press the metal into the other portions of the die, substantially as set forth. 6th. The combination, with an annular die having a screw threaded interior surface, a roller to act within the sheet metal article and press the same outwardly into the screw thread of the die, substantially as set forth. 7th. The combination, with a roll for rolling the interior of a watch case center, of a die having an interior surface corresponding to the exterior surface of the watch case center, and including one or more flat diagonal planes 13 against which the flat for the hinge is formed, substantially as set forth.

No. 31,506. Automatic Feed Gate for Roller Mills. (*Trémie automatique de moulin à rouleaux.*)

Hugh M. Whitney, Glasco, Kan., U.S., 6th June, 1889; 5 years.

Claim.—As an improvement in automatic feed gates for mills, the combination, with the yielding feed-gate, of the horizontally adjustable pivot-screws L, L, slotted supporters N, N for said screws, the nuts P, R on said screws and clamping the same to the supporters, and the screws a, a for vertical adjustment of the supporters N, N and gate, substantially as set forth.

No. 31,507. Device for Applying Heat to the Body. (*Appareil pour appliquer la chaleur au corps.*)

Dexter M. Small, Providence, R.I., U.S., 6th June, 1889; 5 years.

Claim.—1st. A device for making continuous warm or hot applications to the body, which consists of a receptacle for heating water, a hollow air-tight appliance suitable for contact with the person, and flexible tubes E and F connecting the appliance and receptacle, all constructed and combined so as to operate substantially as set forth. 2nd. The receptacle A constructed with an enlarged base, and top separated by an intervening neck, and having one or more sets of tubes C and D, all substantially as set forth. 3rd. The appliance B constructed with a shallow chamber having a central partition b therein extending nearly the entire length thereof, together with two tubes c and d, one on each side of this partition, all substantially as described.

No. 31,508. Re-agent for the Treatment of Sewage and other foul or Waste Waters, and for General Disinfecting, Preservative and Remedial purposes. (*Réactif pour le traitement des eaux d'égouts et autres eaux impures ou rîques, et pour des fins générales de désinfection, de préservation et d'hygiène.*)

Hugo Wollheim, London, Eng., 6th June, 1889; 5 years.

Claim.—1st. The production of the said novel antiseptic reagent from trimethylamine or isomers thereof, or salts, or combinations of the same, or compounds containing such, by the re-action thereon of lime or other alkali of similar re-action, substantially as described. 2nd. The improved means for clarifying, purifying and disinfecting sewage and other foul or waste waters, by the treatment thereof with trimethylamine or isomers thereof, or salts, or combination of the same, or compounds containing such, and with lime or other alkali of similar re-action to cause the generation in the said mass of sewage of the said novel and antiseptic re-agent, substantially as and for the purposes described. 3rd. The formation and utilisation of the special products obtained from the said process or treatment of sewage or other foul or waste waters, substantially as hereinbefore described. 4th. The application of the said novel antiseptic re-agent in its free gaseous condition mixed with other gases in solution in water or other liquids, or encompassed in semi-solid or solid substances for general disinfecting, preservative and remedial purposes, substantially as described.

No. 31,509. Garment Stay. (*Busc de corset.*)

Enoch C. Bowling, Ypsilanti, Mich., U.S., 6th June, 1889; 5 years.

Claim.—The herein described stay comprising the stiffening-blade having metallic end caps, and fabric coverings projecting beyond the edges and capped ends of the stiffening-blade, with interposed sheets of gutta-percha tissue, said parts adhering together and forming the textile fabric stitching edges ff, as and for the purposes specified.

No. 31,510. Tire Heating Apparatus.

(*Appareil de chauffage des bandages de roues.*)

William Hassman, Richmond, Va., U.S., 6th June, 1889; 5 years.

Claim.—1st. In a tire heating and cooling apparatus, the combination of a reservoir or tank, a valved air supply pipe communicating therewith and adapted to be connected with an air pump, an annular distributing pipe, a valved outlet pipe intermediate of the tank and distributing pipe, and a valved branch pipe connected to said air supply and outlet pipes at points on opposite sides of the valves thereof, as and for the purpose described. 2nd. In a tire heating and cooling apparatus, the combination of a tank or reservoir having an absorbent porous filling adapted to contain a liquid hydrocarbon, an air supply pipe passing through said filling within a short distance from the base of the tank, and having a cock or valve 10, an air pump connected to said pipe, an annular distributing pipe, an outlet pipe connected to said distributing pipe and the tank and having a check valve 11, and a branch pipe 12 connected to the air supply, and outlet pipes on opposite sides of the valves 11, 12, thereof, and having a cock 13, substantially as and for the purpose described.

No. 31,511. Overflow for Baths and Wash Bowls. (*Dégorgeoir pour baignoires et bassins de toilette.*)

Edouard Bellavance, Montréal, Qué., 6th June, 1889; 5 years.

Claim.—A movable overflow for baths and wash bowls made of the tube I, strainer H and plug J or L, substantially as described and for the purposes set forth.

No. 31,512. Process of Reducing Aluminium by Electrolysis. (*Procédé de réduction de l'aluminium par l'électrolyse.*)

Charles M. Hall, Oberlin, Ohio, U.S., 7th June, 1889; 15 years.

Claim.—1st. As an improvement in the art of manufacturing aluminium, the herein described process which consists in dissolving alumina in a fused bath composed of the fluorides of aluminium and a metal more electro-positive than aluminium, and then passing an electric current through the fused mass, substantially as set forth. 2nd. As an improvement in the art of manufacturing aluminium, the herein described process which consists in dissolving alumina in a fused bath composed of the fluorides of aluminium and sodium, and then passing an electric current by means of a carbonaceous anode through the fused mass, substantially as set forth. 3rd. As an improvement in the art of manufacturing aluminium, the herein described process which consists in dissolving alumina in a fused bath composed of the fluorides of aluminium, sodium and lithium, and then passing an electric current by means of a carbonaceous anode through the fused mass, substantially as set forth.

No. 31,513. Process of Reducing Aluminium from its Fluoride Salts by Electrolysis. (*Procédé de réduction de l'aluminium de ses sels fluoriques par l'électrolyse.*)

Charles M. Hall, Oberlin, Ohio, U.S., 7th June, 1889; 15 years.

Claim.—1st. As an improvement in the art of manufacturing aluminium, the herein described process which consists in dissolving alumina in a fused bath composed of the fluorides of aluminium and potassium, and then passing an electric current by means of an anode formed of non-carbonaceous material through the fused mass, substantially as set forth. 2nd. As an improvement in the art of manufacturing aluminium, the herein described process which consists in dissolving alumina in a fused bath composed of the fluorides of aluminium, potassium and lithium, and then passing an electric current through the fused mass, substantially as set forth.

No. 31,514. Process of Electrolyzing Crude Salts of Aluminium. (*Procédé pour électrolyser les sels bruts de l'aluminium.*)

Charles M. Hall, Oberlin, Ohio, U.S., 7th June, 1889; 15 years.

Claim.—1st. As an improvement in the art of manufacturing aluminium, the method herein described, which consists in fusing a combination of the fluoride of aluminium, the fluoride of calcium, and the fluoride of sodium, adding alumina to the bath so formed, and then passing a current of electricity through the fused mass, substantially as set forth. 2nd. As an improvement in the art of manufacturing aluminium, the method herein described, which consists in fusing a combination of the fluoride of aluminium, the fluoride of calcium, the fluoride of sodium and the chloride of calcium, adding alumina to the bath so formed, and then passing a current of electricity through the fused mass, substantially as set forth.

No. 31,515. Manufacture of Aluminium.

(*Fabrication de l'aluminium.*)

Charles M. Hall, Oberlin, Ohio, U.S., 7th June, 1889; 15 years.

Claim.—1st. As an improvement in the art of manufacturing aluminium, the herein described method which consists in fusing a combination of the fluoride of aluminium, and the fluoride of an alkaline earth metal, adding alumina to the bath so formed, and passing a current of electricity through the fused mass, substantially as described. 2nd. As an improvement in the art of manufacturing aluminium, the herein described method, which consists in fusing a combination of the fluoride of aluminium and the fluoride of calcium, adding alumina to the bath so formed, and then passing a current of electricity through the fused mass, substantially as set forth.

No. 31,516. Manufacture of Aluminium Alloys. (*Fabrication des alliages d'aluminium.*)

Charles M. Hall, Oberlin, Ohio, U.S., 7th June, 1889; 15 years.

Claim.—1st. As an improvement in the art of manufacturing alloys of aluminium with other metals, the method herein described, consisting in dissolving alumina in a fused bath of the double fluoride of aluminium, and a metal more electro-positive than aluminium, and then passing an electric current through the fused mass by means of electrodes submerged therein, the negative electrode being formed of the metal with which the aluminium is to be alloyed, substantially as set forth. 2nd. As an improvement in the art of manufacturing alloys of aluminium with copper, the method herein described, which consists in dissolving alumina in a fused bath of the double fluoride of aluminium, and a metal more electro-positive than aluminium, and then passing an electric current through the mass by means of copper electrodes, substantially as set forth.

No. 31,517. Process of Electrolyzing Fused Salts of Aluminium. (*Procédé pour électrolyser les sels fondus de l'aluminium.*)

Charles M. Hall, Oberlin, Ohio, U.S., 7th June, 1889; 15 years.

Claim.—1st. As an improvement in the art of manufacturing aluminium or alloys thereof, the herein described continuous method, consisting in dissolving alumina in a fused bath composed of the fluoride of aluminium, and the fluoride of a metal more electro-positive than aluminium, passing an electric current through the fused solution by means of suitable electrodes arranged therein, thereby

separating the alumina into its constituent elements, adding time to time or continuously a fresh supply of alumina to the bath and removing the aluminium, substantially as set forth. 2nd. As an improvement in the art of manufacturing aluminium, the herein described continuous method, consisting in dissolving alumina in a fused bath, composed of the fluorides of aluminium, sodium and calcium, and the chloride of calcium, passing an electric current through the fused solution by means of suitable electrodes arranged therein, thereby separating the alumina into its constituent elements, adding from time to time or continuously a fresh supply of alumina to the bath and removing the aluminium, substantially as set forth.

No. 31,518. Water or Liquid Elevator.

(Elevateur d'eau ou de liquide.)

David C. Batten, Florence, Kan., U.S., 7th June, 1889; 5 years.

Claim.—1st. The combination, with the cylinder A having the inlet and discharge pipes C, D, provided with valves c, d, of the operating lever E, the weighted arm H, the trip lever K and the plunger or float B, substantially as specified. 2nd. The combination, with a cylinder A, provided with inlet and outlet pipes C, D, having valves c, d, and the plunger or float B of the operating lever E, the weighted arm H, the extensible shaft G and the trip lever K, substantially as specified. 3rd. The combination, with the cylinder A provided with the pipes C, D, having valves c, d, of the operating lever E, the arm H provided with a weight I, the extensible shaft G, the trip lever K, the plunger or float B, a chain or flexible connection N and a socket n, substantially as specified. 4th. The cylinder A, provided with the inlet and outlet pipes C, D, having valves c, d, the operating lever E, the weighted arm H, the extensible shaft G and the trip lever K, in combination with the plunger or float B, a chain or other flexible connection N, the central socket n and the vertical bars or supports O, O, substantially as specified.

No. 31,519. Button Setting Machine.

(Machine à poser les boutons.)

Analdo M. English, Boston, Mass., U.S., 7th June, 1889; 5 years.

Claim.—1st. In a button setting machine, the combination, with an inclined vibrating fastener through and raceway, of a rocking arm U provided with a spring tongue u₁, a hinged fastener carrier h, h₁, a pivoted clinching bar L₁ and a reciprocating forked fastener carrier R₃, all constructed, arranged and operated substantially as and for the purposes herein described. 2nd. In a button-setting machine, the combination, with a fastener raceway, of a rocking arm U provided with a tongue strip v pivoted therein, and a hinged carrier consisting of a frame h, h₁, swinging on the pivot h₁, and provided with a fastener holder spring block h₂, whereby the fastener when removed from the raceway by the said rocking arm and transferred to the hinged carrier is held therein between the block h₂ and the part h₁, all of said parts being arranged and operated substantially as and for the purposes described. 3rd. A button feeding device, consisting of the combination of a trough peripherally grooved guide rollers provided with one or more radial recesses, a stationary feed wire partially embracing said rollers, whereby the said wire is held, and suitable guides whereby the button-heads are held in proper position, all arranged and operated substantially as herein described. 4th. In a button setting machine, the combination of two or more revolving grooved and recessed button guiding rollers, with a button feeding wire partially embracing said rollers, whereby the said wire is held stationary with its ends free, substantially as and for the purposes herein described. 5th. A button feed, consisting of a stationary wire bent around one or more revolving guide rollers, each provided with a circumferential groove r₃ and transverse grooves r₁, substantially as described. 6th. The combination, with a button feed wire, of a pair of spring gripper jaws M, M, reciprocating cheeks O, O, and the clinching die P, arranged and operated substantially as described. 7th. The combination, with the button-feeding wire D₂, of a pair of reciprocating spring gripper jaws M, and the clinching die P, whereby the said jaws strip the button from the wire and carry it under the die, substantially as and for the purposes herein described. 8th. In a button-setting machine, the combination, with a clinching bar, of reciprocating spring jaws M and cheeks O, having bevelled under sides o₅, whereby when the fastener is passed through the leather or fabric between the said clinching bar and the ends of the jaws, the latter are locked together, substantially as and for the purposes described. 9th. In a button-setting machine, the combination, with a hinged fastener carrier h, h₁, of a clinching bar L₁, a spring block L₆ provided with a fastener, retaining shouldered groove l₅, and a reciprocating carrier sliding on said clinching bar, provided with a forked bar l₃ and spring fastener holding jaws R₅, R₆, substantially as herein described. 10th. The combination with the bar L₁, of a fastener turning spring block L₆, provided with the bevelled under side l₄ and a reciprocating bar R₃, substantially as described. 12th. A button-feeding device, consisting of the combination of the feed wire D₂, revolving grooved and recessed button guiding rollers K, K₁, and a notched vibrating button separator T, substantially as herein described. 13th. In a button-setting machine, a cradle L pivoted at e₆ to the frame of the machine, and provided with the pins b, b₁₀, in combination with the slotted clinching bar L₁, the supporting bar L₂ and the cushioning springs S₄, substantially as and for the purposes described. 14th. In a button setting machine, the combination, with a reciprocating rack N, of a loose pinion N₁ meshing therewith, and provided with the pin n, the connecting cams F, F₁ and F₂, one of which is provided with the slot n₁, whereby the said cams are turned at each down stroke of said rack, the pivoted spring cradle L and the oscillating spring lever G, whereby motion is transmitted from the said cams to the various parts of the mechanism, substantially as described. 15th. A button-setting machine, consisting of the combination of revolving feeding drums, button, and fastener conducting troughs and raceways, a stationary button feeding wire mechanism, button and fastener separating devices, a clinching die, button, delivery jaws, a clinching bar and a sliding reciprocating fastener carrier, all arranged and operated substantially as and for the purposes described. 16th. In a button-setting machine, a movable clinching bar L₁ provided with reciprocating

fastener holding spring jaws R₅, R₆, sliding thereon, substantially as herein described. 17th. In a button-setting machine, a clinching die P, in combination with button-carrying reciprocating jaws M, which grasp the button by the eye, whereby one button at a time is carried automatically under said die, substantially as herein described. 18th. In a button-setting machine, the combination, with a button feed wire D₂, of a pair of reciprocating button-carrying spring gripper jaws M, whereby the button is stripped from the wire, substantially as herein described. 17th. In a button-setting machine, the combination of the clinching bar L₁ and the stationary die P, and a pair of reciprocating spring gripper jaws, whereby the leather is stripped down over the fastener and kept free from the end, substantially as herein described. 20th. In a button-setting machine, a movable clinching bar L₁ provided with a bevelled seat l₆, whereby the fastener is inclined to the line of motion during the operation of clinching, substantially as herein described.

No. 31,520. Machine for Inserting Diagonal Strips into Woven Fabrics. (Machine à insérer des bandes diagonales dans les tissus.)

Henry B. Morris, Geneva, N. Y., U.S., 7th June, 1889; 5 years.

Claim.—1st. In a machine for inserting diagonal threads in warp fabrics, the combination, substantially as hereinbefore set forth, of the separators for opening a diagonal passage in the fabric, means for actuating the separators, the needle which carries the diagonal thread through said passage and means for actuating the needle. 2nd. In a machine for inserting diagonal threads in warp fabrics, the combination, substantially as hereinbefore set forth, of the separators for opening a diagonal passage in the fabric between the warp and the weft threads, means for actuating the separators, the needle which carries the diagonal thread through said passage, means for actuating the needle and devices for holding the end of the diagonal thread during the backward movement of the needle. 3rd. In a machine for inserting diagonal threads in warp fabrics, the combination, substantially as hereinbefore set forth, of the separators for opening a diagonal passage in the fabric between the warp and the weft threads, means for actuating the separators, the needle which carries the diagonal thread through said passage, means for actuating the needle and devices for severing the diagonal thread inserted from the thread carried by the needle. 4th. The combination, substantially as hereinbefore set forth, of the separators for opening a diagonal passage in the fabric between the warp and weft threads, means for actuating the separators, the needle which carries the diagonal thread through said passage, means for actuating the needle, the feed-rollers for carrying the fabric through the machine, and means for actuating them. 5th. The combination, substantially as hereinbefore set forth, of the upper and lower dies formed with a longitudinal groove or race, means for raising and lowering the upper die relatively to the lower die, the feed rollers for carrying the fabric through the dies, the needle, and means for reciprocating the needle in the longitudinal groove or race. 6th. The combination, substantially as hereinbefore set forth, of the main frame, the upper and lower feed-rollers geared to revolve synchronously, and formed with projecting pins, and recesses corresponding with the interstices in the fabric and means for actuating the feed-rollers. 7th. The combination, substantially as hereinbefore set forth, of the main frame, the upper and lower dies, the main driving shaft connections between the driving shaft and upper dies, whereby they are raised and lowered relatively to the lower dies, the feed-rollers connections between the main driving-shaft and the feed-rollers for actuating them, the needle, the needle-carrying frame and connections between the needle-carrying frame and the main driving shaft. 8th. The combination, substantially as hereinbefore set forth, of the main frame, the upper and lower dies, the main driving shaft, the frame to which the upper dies are secured, the vertical rods secured to the die-supporting frame, the cams on the driving-shaft with which the vertical rods engage, the upper and lower feed-rollers geared to revolve synchronously, the feed-rod, actuating rod and the cam on the driving shaft with which said rod engages. 9th. The combination, substantially as hereinbefore set forth, of the lower die formed with alternate projections and recesses and longitudinal grooves, the upper die formed with alternate projections and longitudinal grooves, the recessed block on the outer end of the lower die, and the blade or plate on the upper die adapted to enter said recess, said block and plate being perforated, for the purpose specified. 10th. The combination, substantially as hereinbefore set forth, of the lower die, the upper die, the needle-carrying frame, the needle, the bell-crank lever pivoted to the lower die and projecting beneath it, a clamping device on the lower front portion of the lever, and a lug or projection on the front end of the lever engaging with a lug or projection on the upper die, for the purpose specified. 11th. The combination, substantially as hereinbefore set forth, of the separators, the clamping devices and the needle formed with a horizontal central opening, and tapered, split and provided with forwardly-projecting teeth at its front end.

No. 31,521. Transmitting Instrument for Electric Signalling Apparatus. (Appareil transmetteur pour les appareils électriques à signaux.)

Walter J. Dudley, Everett, Mass., U.S., 7th June, 1889; 5 years.

Claim.—1st. The controlling shaft, movable to and held in different positions, combined with a current interrupter controlled by the said shaft, and a lock for said current interrupter, and a releasing projection therefor connected with the said shaft, whereby the said interrupter is released and produces a number of electric impulses dependent on the point at which the said shaft has been stopped, substantially as described. 2nd. The main line and two branch circuits containing sources of different kinds of electric currents, as, for instance, a battery and magneto-generator, combined with a transmitting instrument comprising a movable signalling surface, having a definite cycle of movement, the same at each operation and an actuator therefor, and circuit-controlling contacts operate

thereby during said continuous movement controlling the connection of said branches with the main line, substantially as and for the purpose described. 3rd. The main line and three branch circuits, one containing a battery, one a magneto-generator and a third containing a source of currents of opposite polarity to that of the said battery, combined with a transmitting instrument, comprising a movable signaling surface, having a definite cycle of movement, the same at each operation, and actuator therefor, and circuit-controlling contacts operated thereby, by which the said branches are all connected to line each at different times during a single operation of said signaling surface, substantially as and for the purpose described. 4th. The actuating shaft and wheel, having a signaling surface loose thereon, and actuating spring connecting said shaft and wheel combined with a stop for said wheel released by said actuating shaft, and a second stop connected with said wheel-stop and operated thereby, the second stop being arranged to arrest the actuating shaft except when the first is engaged with the said wheel, substantially as described. 5th. The actuating shaft and transmitting wheel loose therein, combined with an actuating spring connecting the said shaft and wheel, an arm loose on said shaft and stops co-operating with said arm on said wheel, and a projection co-operating with said arm connected with said actuating-shaft, substantially as and for the purpose described. 6th. The actuating shaft and disk fixed thereon, having a portion of its periphery provided with ratchet-teeth, combined with a pawl to engage said teeth, a circuit-controlling wheel loose on said shaft, and an actuating spring connecting said shaft and wheel, and a stop for said wheel operated to release the wheel by the movement of the shaft, substantially as described. 7th. The actuating shaft movable to and held in different positions combined with a circuit-controlling wheel, having a signaling surface and electric contacts controlled thereby, a segment connected with said wheel, and a projection co-operating with the said segment connected with the actuating shaft, whereby the said segment is moved to prevent a portion of the signaling surface from operating the contacts, substantially as described. 8th. The combination of the main circuit and generator of electricity therein, with resistance in said circuit and contact points between different portions of said resistance, a switch movable over the said contact points, and an electro-magnet included in said circuit, and an armature therefor which engages and arrests the said switch when the attraction of the magnet overcomes the retractor of the armature, substantially as described. 9th. The combination of the actuating shaft, with a movable switch engaged by said shaft and an electro-magnet and its armature that arrests the said switch, a lock that retains the said switch in the position to which it has been moved, and a releasing device for said lock operated by said shaft before the latter engages the said switch, substantially as and for the purpose described. 10th. The combination of the actuating shaft with a movable switch engaged by said shaft and an electro-magnet and its armature that arrests the said switch, a hook that holds the said armature up to its magnet and an actuator for said lock on said shaft, by which the armature is released while the switch is engaged by the shaft, substantially as and for the purpose described. 11th. The main circuit and transmitting instrument, provided with a circuit-controlling wheel and electric contacts operated thereby, combined with a branch circuit containing a source of electricity which is connected to said main circuit during the movement of said wheel and another branch containing a telephone which is connected to said main circuit by the wheel controlled contacts when said wheel is arrested in its normal position, substantially as described.

No. 31,522. Bath or Solution for use in Separating Metals from their Ores and Process of Making the Same. (*Bain ou solution pour servir à la séparation des métaux de leurs minerais et procédé pour cet objet.*)

Jacob C. Wiswell, Medford, Mass., U.S., 7th June, 1889; 5 years.

Claim.—1st. A solution or bath for use in separating metals from their ores, consisting of aqua chlorine, soluble mercury, salt and muriatic acid, as set forth. 2nd. A solution or bath for use in separating metals from their ores, consisting of aqua chlorine, soluble mercury, salt, muriatic acid and iron salt, as set forth. 3rd. The process of producing a bath or solution for use in the separation of ores from their metals, consisting in subjecting salt water, muriate of ammonia, muriatic acid and liquid mercury to a current of electricity, as set forth. 4th. The process of producing a bath or solution for the separation of metals from their ores, consisting in placing aqua chlorine in a tank containing liquid mercury, and then subjecting the whole to a current of electricity, and adding iron salt to the solution thus produced, as set forth.

No. 31,523. Coin Operated Induction Coil.

(*Bobine d'induction actionnée par une pièce de monnaie.*)

Percy G. Williams and Alfred W. Roovers, Brooklyn, N.Y., U.S., 7th June, 1889; 5 years.

Claim.—1st. The combination, with a case, of an induction coil primary and secondary circuits therefor, a longitudinally movable part in electrical contact with the induction coil, electrodes outside the case, one of which is connected with the said movable part, a weight for moving said movable part in one direction, an arm adapted to be locked with said weight, a rod rigidly secured to said arm, time mechanism having a portion in one of said circuits, and a pin or projection on said rod adapted to contact with said portion of the time mechanism to close such circuit, substantially as specified. 2nd. The combination, with a case, of an induction coil primary and secondary circuits therefor, a longitudinally-movable part in electrical contact with the induction coil electrodes outside the case, one of which is connected with the said movable part, a weight for moving said movable part in one direction, an arm adapted to be locked

having a portion in one of said circuits, and a yielding pin or projection on said rod adapted to contact with said portion of the time mechanism to close such circuit, substantially as specified. 3rd. The combination, with a case, of an induction coil, primary and secondary circuits therefor, a movable part in electrical contact with the induction coil, electrodes outside the case, one of which is secured to said movable part, a weight for moving said movable part in one direction, an arm adapted to be locked to said weight, a rod rigidly secured to said arm, a lever, a receptacle for a coin mounted on said lever, a pin or projection on said rod, and time mechanism, whereby when a cam has been deposited in the receptacle, the lever will rock to close circuit, and when the said movable part for the induction coil is moved outwardly and the weight is raised, said rod will be elevated, to permit the operation of the time mechanism and to cause the breaking of the circuit, substantially as specified. 4th. In a coin-operated induction coil, the combination of an indicator two electrodes extending outside the case, one constructed to be longitudinally movable, a coin chute, a coin receptacle moved on receiving a proper coin from the chute, an electric circuit, circuit-changers operated upon the movement of the coin receptacle, gearing imparting movement to the indicator, and mechanism operated upon the movement of the coin receptacle to connect said gearing with the movable electrode, substantially as specified. 5th. In a coin-operated induction coil, the combination of an indicator, two electrodes extending outside the case, one constructed to be longitudinally movable, a coin-chute, a coin-receptacle moved on receiving a proper coin from the chute, an electric circuit, circuit-changers operated upon the movement of the coin receptacle, time mechanism gearing imparting movement to the indicator, and mechanism operated upon the movement of the coin receptacle to connect said gearing with the movable electrode, substantially as specified. 6th. The combination of an indicator, a rod connected therewith for operating the same, a movable electrode, a lever having at one end a coin-receptacle, and a catch operated by said lever to lock the movable electrode to the said rod, substantially as specified. 7th. The combination of an indicator, a rod connected therewith for operating the same, a movable electrode, a catch for securing the movable electrode to the rod, a lever and a sliding trip, substantially as specified. 8th. The combination of a coin chute, a lever carrying a receptacle for coin, a movable electrode, and a catch operated to be rocked, and locked to the said movable electrode by means of a working lever, substantially as specified. 9th. In a coin operated induction coil, the combination, with an electrode, of a weight secured thereto and elevated when said electrode is drawn outwardly, an arm adapted to be locked to said weight, a rod frictionally secured to said arm, a trip on said rod, a lever, a receptacle for coin composed of sections and mounted on said lever, and an opening and closing device operated by said trip upon the lowering of said weight to open said receptacle, substantially as specified. 10th. The combination, with a movable electrode, of a weight connected to said electrode, an arm connected to said weight, a rod having a sliding connection with said arm, an abutment for said rod, a receptacle for coin and an opening and closing device operated by said rod, substantially as specified. 11th. The combination, with a longitudinally movable electrode, of a weight secured thereto and elevated when the electrode is drawn outwardly, an arm adapted to be locked to said weight, a rod adapted to be locked to said arm and moved upwardly therewith, time mechanism and a pin or projection on said rod adapted upon the descent of said rod to rewind said time mechanism, substantially as specified. 12th. In a coin operated induction coil, the combination, with the weight A₃ provided with a groove c₃ of the arm H provided with a dog H² adapted to engage said groove, and the lever B₂ provided with a pin e₂, substantially as specified.

No. 31,524. Running Gear for Vehicles.

(*Train de voiture.*)

Targe G. Mandt, Stoughton, Wis., U.S., 7th June, 1889; 5 years.

Claim.—As an improved article of manufacture, the herein described running gear for vehicles comprising the following elements: the axles 1 and 2, head block 3, fifth wheel 4, rod 12 having perforated ears 13, springs 14, bar 16 having perforated ears 15, side bars 18, bifurcated king-bolt 42, shackle 44 having bolt 46, yoke 47, all constructed and combined substantially in the manner and for the purpose set forth.

No. 31,525. Gas Burner and Heater.

(*Bec et cuisinière à gaz.*)

Daniel S. Robilliard and Charles G. Davies, Québec, Qué., 7th June, 1889; 5 years.

Claim.—1st. The combination, with a bell-shaped air chamber and a mixing chamber immediately over the same, and connected therewith, of a gas supply pipe passing through the air chamber into the mixing chamber, substantially as specified. 2nd. The combination, with an air chamber open at bottom and top, and a mixing chamber immediately over the same and connected therewith, of an enclosing head provided with an inner cup-shaped concentric diaphragm, and a gas supply pipe passing through the air chamber and into the mixing chamber, substantially as shown and described, whereby a series of connecting chambers are formed outside the mixing chamber, and the gas and air superheated and expanded by the burning gas, as set forth. 3rd. The combination, with the base or body having air passages therein and a gas supply pipe entering said body, of a receptacle secured to said body constituting a mixing chamber, an apertured cap secured to the gas supply pipe penetrating the mixing chamber, baffle plates adjacent to the mixing chamber, and an apertured casing spaced from and surrounding the baffle plates and mixing chamber, substantially as and for the purpose specified, whereby a superheating chamber is obtained as set forth. 4th. The combination, with an open base, a gas supply pipe passing upward through the same, an annular plate resting upon said base, provided with a central collared opening constituting a mixing chamber, of an apertured cap secured to the gas inlet pipe extending in the mixing chamber, a ring resting upon the annular

plate, a cap of greater diameter than the mixing chamber connected with the ring, and supported above the said chamber, and a crown piece supported above the ring and cap, substantially as shown and described. 5th. The combination, with an open base, a gas supply pipe passing upward through the same, an annular plate resting upon the upper surface of the base having a central opening, and an upwardly projecting collar surrounding said opening, constituting a mixing chamber, of an apertured cap secured to the gas inlet pipe extending in the mixing chamber, a ring resting upon the annular plate near the periphery, a cap of greater diameter than the mixing chamber covering the same and projecting downward between the said ring and mixing chamber, a rib integral with the upper face of the cap and a crown piece resting upon the said rib extending over the ring, substantially as shown and described. 6th. The combination, with an open base, a gas supply pipe passing upward through the same, an annular plate supported upon the body having a central opening, and an upwardly extending collar surrounding said opening, constituting a mixing chamber, of an apertured cap secured to the gas inlet pipe projecting in the mixing chamber, a ring resting upon the annular plate near the periphery provided with a series of spaced lugs upon the upper edge, a cap of greater diameter than the mixing chamber supported above the same, having an annular rib produced upon the upper face, a crown piece resting upon said rib, and means substantially as shown and described for uniting the several parts of the burner as set forth.

No. 31,526. Support for Water Conductor. (*Gâche de conduit d'eau.*)

John Davis, Allegheny, Penn., U.S., 7th June, 1889; 5 years.

Claim.—1st. A support for water conductors having a head provided with a slot, arms curved outwardly at their free ends, and suitable means for securing it to a conductor, substantially as described. 2nd. A support for water conductors having a head provided with a slot, arms curved outwardly at their free ends, and a screw for securing it, in combination with a water conductor having a projection or fold on one side, substantially as described.

No. 31,527. Letter File. (*Serre-papier.*)

Zebulon A. Lash (assignee of John F. Lash), Toronto, Ont., 7th June, 1889; 5 years.

Claim.—1st. In a letter file of the above mentioned class, the arched transfer wire C fastened to the bed plate A, in such a manner that it may be folded flat upon or on a level with the bed plate A, substantially as described. 2nd. In a letter file of the above mentioned class, the arched transfer wire C fastened to the bed plate A in a separable manner, so that it may be readily attached or detached ostensibly for the purpose of packing the file in knock-down form, substantially as described. 3rd. In a letter file, the combination of the bed plate A, the filing wire B and the arched transfer wire C fastened to the bed plate, in such a manner that it may be folded flat upon or on a level with it as mentioned, substantially as described. 4th. In a letter file, the combination of the bed plate A and the filing wire B arranged to fold down flat, and the arched transfer wire C fastened to the bed plate A in a separable manner, substantially as described. 5th. In a letter file having a pair of filing wires arranged to form a continuous arched filing wire, the specific mode described in the above specification of keeping the wires in each pair in contact, viz.: by having a cavity hollowed out in the end of one wire of the pair, and in a narrow slot cut in the cavity, and the end of the other wire of the pair so constructed and arranged as to press against the inside of the cavity and interlock the two wires upon being inserted through the said slot, substantially as described. 6th. In a letter file, the combination of the bed plate A and the filing wire B, with the cavity and slot D therein, and the arched transfer wire C, substantially as described. 7th. In a letter file, the combination of the bed plate A and the arched transfer wire C, with the cavity and slot D therein, and the filing wire B, substantially as described. 8th. In a letter file, as described above, the combination of the socket G and the arched transfer wire C bent at a suitable angle, as at E, on the same side thereof, as the bend of the arched part, and constructed to turn in the socket or to be slid into it in setting up the file, substantially as described. 9th. The combination of the transfer wire C and the filing wire B, both fastened to the bed plate A in a separable manner, so that they may be readily attached or detached ostensibly for the purpose of packing the file in knock-down form, substantially as described.

No. 31,528. Letter File. (*Serre-papier.*)

Zebulon A. Lash (assignee of John F. Lash), Toronto, Ont., 7th June, 1889; 5 years.

Claim.—1st. The combination of the filing wires B, B', and the arched transfer wires C, C' having their points respectively constructed and arranged so that the wires in one pair will engage each other when pressed in contact by the closing of the file, and the wires of the other pair will engage each other when one is slipped past the other, and adjusted against it so as to interlock the four wires by their natural spring, substantially as described. 2nd. The combination of filing wires such as C, C' and B, B' (C, C' being rigidly connected together and working in unison when moved) having their ends sharpened respectively, as at D, E, viz.: one wire shaped to engage the other in such a manner as not to slip past it when pressed in contact upon the file being closed, and also respectively, as at D' and E', viz.: one wire being shaped so that when slipped past the other it will engage it in such a manner as to retain it in contact by the natural spring of the wires, substantially as described. 3rd. In a letter file, the combination of the filing wires B, B', and the arched transfer wires C, C' bent inwards as at F towards the filing wires B, B', and hinged to the bed plate much nearer to the filing wires than would be the case if they were not bent inwards as shown in the drawing, substantially as described.

No. 31,529. Semaphore. (*Sémaphore.*)

John M. Kirby, St. Thomas, and Robert Paxton, Otterville, Ont., 7th June, 1889; 5 years.

Claim.—In a semaphore, the combination, with a vertical support A and projecting arm B, the rods D having inner cranked ends d and outer looped and cranked ends d' hinged to the end of the arm B, the wings E secured to the ends d' of the rods D, the links F connecting the cranks d and the rod F, the rod F adapted to be secured to a stop and the stop or pin F', substantially as set forth.

No. 31,530. Saw. (*Scie.*)

Warren Bundy, Minnesota, Minn., Gilbert Montague, Chicago, Ill., and Otto Frost, Minnesota, Minn., U. S., 7th June, 1889; 5 years.

Claim.—As an article of manufacture, a saw provided with two kinds of teeth, two of which are cutting teeth and one a clearing tooth, the cutting teeth being divided and defined by an angular space, and provided with alternate cutting edges facing the blank rear edge of the opposite cutting teeth, the clearing teeth being in chisel form with parallel front and rear edges, the rear edge being shorter than the front edge placed at a slight angle with the radius and direct line across the body of the saw slightly chamfered at the end to form a cutting-edge next to the gully and directly across the travel of the saw and a little shorter than the cutting teeth, each set of teeth being divided by an oval ended loop formed gully extending deeper into the blade than the other divisions at the same angle with the radius and direct line across the blade of the saw capable of being filed or cut deeper into the blade as required, and the sides of which are not beveled but directly across the travel of the saw.

No. 31,531. Electric Signalling and Alarm Apparatus. (*Appareil à signaux et toc-sin électriques.*)

William L. Denis, Rochester, N. Y., and Robert H. Read, Washington, D. C., U. S., 7th June, 1889; 5 years.

Claim.—1st. A button for circuit changers laterally extended at one end, and provided with a spring pressed finger, said finger being normally retained under tension by a fusible seal. 2nd. A perforated push button for circuit changers, flanged at one end and provided with a spring pressed finger, said finger being held under tension by a fusible seal on the outer face of the button, whereby said button may be substituted for the customary porcelain button and will automatically transmit an alarm on a definite rise in temperature. 3rd. In a fire alarm or heat detector internally flanged at one end, a spring seated against said flange, a pin within the barrel engaging the spring, and a fusible seal for holding said spring under tension, whereby on the outbreak of a fire the seal will melt and the pin will be thrust out of the barrel. 4th. The combination, with circuit electrodes, of the barrel 5 provided with flange 9 spring 6 seated in said barrel, said spring when free extending out of the barrel, and pin 7 one end of which engages the free end of the spring, the other end being secured by a fusible seal to the other end of the barrel, whereby on the outbreak of a fire the seal will melt and the circuit will be changed. 5th. The combination of the casing, the hollow button movably secured in the casing, a pin in said button, a spring held under tension by said pin, a fusible seal for holding the spring, and the electrodes engaged by the button, whereby the device may normally be operated as a push button and on the outbreak of a fire will automatically turn in an alarm.

No. 31,532. Car Axle Lubricator.

(*Boile à graisse.*)

Theodore Saunders, Danbury, Conn., and Henry A. Hine, New York, N. Y., U. S., 7th June, 1889; 5 years.

Claim.—In a car axle lubricator, the combination of an absorbent pad G having pendant wicks H, of a pair of spring supports E, substantially as described.

No. 31,533. Felt and Felt Cloth.

(*Feutre et drap feutré.*)

William Stafford (assignee of James W. Eastwood), Lancaster, Ont., 7th June, 1889; 5 years.

Claim.—A combination of cam and felt, with the fabric of the cams uninjured in any way as by punching, tearing, cutting, etc., in its manufacture, thereby retaining the full strength of the fabric.

No. 31,534. Centrifugal Fluid Separating Machine. (*Machine centrifuge pour séparer les fluides.*)

David Hummel, Jr. (assignee of Waldemar Bergh), London, Eng., 7th June, 1889; 5 years.

Claim.—1st. A centrifugal fluid separating machine in which the driving power is applied over head to an upper guided rotating spindle, provided with a bottom recess fitted with an elastic bush for receiving the upper end of a lower or separator drum spindle and to which it is loosely connected, for the purpose of carrying round with it the spindle, being at its lower end fixed to the separator drum, which works in a bottom step bearing in such manner that it finds its true perpendicular or balanced position after the manner of a spinning top, substantially as set forth. 2nd. In a centrifugal fluid separating machine, the worm wheel E, in combination with the worm wheel C' on the said upper spindle C, which is provided with a bottom recess with elastic bush D for receiving the upper end of a lower or drum spindle A, and to which it is loosely connected by a pin a and notches, the spindle A being at its lower

end fixed to a diaphragm, L between the separating drum B and a lower compartment M, and resting with a pivot in a bottom step, so as to balance like a spinning top, substantially as set forth. 3rd. In a centrifugal fluid separating machine, the combination of the worm wheel gearing E, C, the spindle C, the bearings I and I' for said spindle, and a screw taking a bearing against its upper end, the spindle C having a bottom recess with elastic bush D for receiving the upper end of the lower or drum spindle A, to which it is loosely connected by a pin and notches, substantially as set forth. 4th. In a centrifugal fluid separating machine, the worm wheel E, in combination with a worm wheel C on a spindle C, to which the power is applied, in such manner as to tend to raise it, the bearings I and I' for said spindle, and with a casing wherein the said gearing is enclosed, and wherein the said bearings are formed in such manner that an oil chamber H¹ is formed adapted to lubricate the gearing and the bearings, substantially as set forth. 5th. In a centrifugal fluid separating machine, the worm spindle C provided with a collar C₂, in combination with the disk K, substantially as set forth. 6th. In a centrifugal liquid or fluid separating machine, the spindle A provided with bottom disc A₁ and pivot, in combination with the centre L, the diaphragm L with hole m for escape of the heavier fluid, the lower compartment M with flange M₁ and notch m for escape of the heavier fluid into a lower outer receptacle N, and the separator drum B with hole b for escape of the lighter fluid into an upper outer receptacle O, substantially as set forth. 7th. The centrifugal liquid or fluid separating machine consisting of the framing H with oil chamber H¹ and bearings I and I' for an upper worm wheel spindle C, the spur wheel G with handle for actuating it, its spindle being mounted in said framing, the pinion F driven by said wheel G, the worm wheel E for driving the said spindle C, the lower spindle A entering an elastically bushed recess, the spindle C and loosely connected thereto and adapted to be driven thereby, the separator drum mounted on lower end of the spindle A and supported by pivot in a step bearing in the framing, which bearing carries the receptacles for the separated heavy and light liquids and is adapted to be adjusted in height by the screw R, bevel wheels S, S₁, and hand wheel S₂, substantially as set forth.

No. 31,535. Transfer System of Electrical Distribution. (*Mode de régler la distribution électrique.*)

The Thomson-Houston International Electric Company, Boston (assignee of Elihu Thomson, Lynn), Mass., U.S., 7th June, 1889; 5 years.

Claim.—1st. An alternating dynamo, with regulating devices for keeping the potential constant, a set of wires led to a compensating system of two or more coils of about equal length, and wound upon a core of iron which is closed, the length of wire being such that at no time is the core fully saturated magnetically, and circuits leading therefrom, including in multiple arc a number of incandescent lamps with fuses interposed between the compensating coil and incandescent lamps. 2nd. The combination of an alternating current line, an equally wound induction coil on one whose sections are equal, and whose magnetic circuit is closed with several wires or circuits on which the work is done, such as incandescent lamps, or other devices arranged in multiple arc with means for varying the number of devices in use at any time. 3rd. The combination in a system comprising an alternating current dynamo with regulating appliances for keeping the potential constant, of a number of compensators or induction coils for furnishing alternating currents of equal potential in their respective sections, and connected at different points to a system or set of conductors feeding lamp in multiple arc or which induction coils are connected with a multiple series set of devices in multiple arc independent of the others.

No. 31,536. Window Ventilation.

(*Ventilation des croisées.*)

Neil McDonald and Joseph H. Townsend, Tangier, N. S., 7th June, 1889; 5 years.

Claim.—1st. The combination, with an ordinary sash window, of the boards E and F divided obliquely at P, having pins K engaging the sockets k in the window frame D, the link G, g, connecting the said boards E, F, the tongue M and groove N strengthening said connection, the groove K and rubber strip L in the said board E, F, and the spring catch I and slot c in the lower sash, substantially as and for the purposes set forth. 2nd. The combination, with a sash window, of the boards E and F divided obliquely at P, connected by the link G, g, and having pins K fitting in the sockets k in window frame D, the catch I engaging the slot c in the lower bar C of the lower window sash, substantially as set forth.

No. 31,537. Watch Case. (*Boîte de montre.*)

The American Watch Case Co. (assignee of Edward F. Hefferman), Toronto, Ont., 7th June, 1889; 5 years.

Claim.—1st. The combination, with the centre of a watch case, of a ring hinged to the said centre, and having the back or bezel revolvably connected to it, substantially as and for the purpose specified. 2nd. The combination, with the centre of a watch case, having a screw cut on it, of a screwed ring hinged to the centre, and of a back or bezel screwed to engage with the screws on the ring and centre, substantially as and for the purpose specified. 3rd. A watch case hinge, formed by one or more pins pivoted on the back, bezel, or ring, and longitudinally adjustably fitted into holes made in the centre, substantially as and for the purpose specified. 4th. In a watch case, having its back or bezel screwed to the centre by means of a screwed joint, a ring connected to the back or bezel, and having a thread cut on it to correspond with and form a continuation of the thread which forms a screw joint, in combination with a hinge designed to connect the screwed ring with the centre, substantially as and for the purpose specified. 5th. A ring B, having a thread b cut on it to correspond with and form a continuation of the thread a on

the centre A, and a hinge to connect it with the said centre A, in combination with a bezel or back D, having a thread cut on it to engage with the threads a and b, substantially as and for the purpose specified.

No. 31,538. Grain Scouring Machine.

(*Machine à nettoyer les grains.*)

Abram N. Pratt, Columbus, Ohio (assignee of Joab C. Fisher, Beloit, Kan.), U.S., 7th June, 1889; 5 years.

Claim.—1st. In a grain cleaning and scouring machine, the combination of an outer stationary scouring casing, heads 32 located at the ends of said casing, and provided with inlet and discharge openings, a revolving shaft, a disk secured on said shaft, a second disk having a central perforation larger than the shaft, and a series of horizontal bars which firmly connect the two disks, substantially as and for the purpose set forth. 2nd. The combination of an outer stationary scouring casing, heads for said casing, which are provided with inlet and discharge openings, a stationary partition plate provided with passages and located in said scouring casing, so as to divide it into two chambers, a movable valve having passages which register with the passages in said partition plate, a revolving shaft which extends longitudinally through both chambers, a disk provided with curved radial ribs and secured upon said shaft adjacent to said partition plate, a second disk having a central perforation, and a series of horizontal bars which firmly connect the two disks, substantially as and for the purpose set forth. 3rd. The combination of stationary outer scouring casing 23, provided at the head end with spirally-arranged ribs 19, a revolving shaft, a disk rigidly secured upon said shaft, a second disk having a central perforation, and a series of bars which firmly connect the two disks, substantially as and for the purpose set forth. 4th. The combination of a feeding hopper, having a vibrating bottom and a feed-opening in one side, a rock-shaft located parallel with said feed-opening arms, which extend at right angles from said shaft, a feed-valve carried by the outer ends of said arms, and having vertical movement adjacent to said feed-opening, a third arm at one end of said shaft and parallel with the other arms, a spring which normally urges the last-named arm upward, a vertical rod which depends from the free end of this arm, and a hopper having a discharge-opening and connected to the lower end of said vertical rod, substantially as set forth.

No. 31,539. Composition of Matter for Making Brick and Artificial Stone.

(*Composition de matières pour faire la brique et la pierre artificielle.*)

Offéré Leblanc, Ste. Cunégonde, and Alphonse C. Décarv, Montréal, Qué., 7th June, 1889; 5 years.

Résumé.—Une composition de matières formée de chaux, de sable ou terre jaune, de liquide de bronze, de "Magnetic Iron Ore," de ciment et d'eau, avec ou sans matières colorantes, dans les proportions et pour les fins décrites.

No. 31,540. Rectification of Alcohol.

(*Rectification de l'alcool.*)

André T. Christophe, Paris, France, 7th June, 1889; 5 years.

Claim.—1st. My improvements in the rectification of alcohol, consisting in the treatment of the dilute and impure spirit with sodium tin alloy, substantially as described. 2nd. My improvements in rectification of alcohol, consisting in the treatment of the dilute and impure spirit with an alloy or amalgam of sodium or other alkaline metal, substantially as herein described. 3rd. My improvements in the rectification of alcohol, consisting in the employment in this operation of an alloy or amalgam of sodium or other alkaline metal in conjunction with hypochlorite of lime or other hypochlorite, substantially as herein described. 4th. My improvements in the rectification of alcohol, consisting in mixing with the impure spirit suitably diluted, and in a cold state, hypochlorite of lime or other hypochlorite, in afterwards or simultaneously treating it with an alloy or an amalgam of sodium or other alkaline metal, and then, after a suitable interval, transferring the spirit to the rectifier and distilling it, substantially as herein described.

No. 31,541. Base Ball Bat.

(*Batte de jeu de balle.*)

Charles N. Morris, Cincinnati, Ohio, U.S., 7th June, 1889; 5 years.

Claim.—1st. A base-ball bat, which, from the inner circular grasp, gradually merges into an oval or approximately oval transverse section at the striking portion, substantially as and for the purposes set forth. 2nd. A base-ball bat, which, from a circular handle or inner grasp 1, becomes gradually of ovaling cross-section to outer grasp 2 and the striking portion 3, said handle being formed of gradually greater circular cross-section 4 to the guard or hilt 5. 3rd. A base-ball bat, which, from the inner circular grasp, gradually merges into an oval or approximately oval transverse section at the striking portion, and has a mark or sight 6 on its edge portion, as designated.

No. 31,542. Drill. (*Foret.*)

Thorwald Goserud, Sturgeon Bay, Wis., U.S., 7th June, 1889; 5 years.

Claim.—1st. In a drill, the combination of the worm-shaft A, having a head or shield D, the handle of sleeve T, the bit socket or stock L provided with a spring pawl P, a ratchet K and the set-screw S, substantially as specified. 2nd. In a drill, the combination of the worm shaft A, having a head D swivelled on its upper end, the handle or sleeve T, the extension H provided with a groove h, the ring I swivelled in the said groove, and the bit, stock, or socket L secured by screws to the said ring, and provided with a pawl P engaging a ratchet K, substantially as specified. 3rd. In a drill, the twisted or worm shaft A, provided with a collar G, and an extension H, provid-

ed with a peripheral groove *h*, the ring *I* mounted in the groove and provided with sockets *R*, *R*, the bit socket or stock *L*, the saws passing through the socket or stock and engaging the sockets *R* in the ring *I*, the spring pawl *P*, a peripheral ratchet *K* and the handle or sleeve *T*, substantially as specified. 4th. In a drill, the combination of the head or shield *D*, provided with a depending socket or bearing *E*, the worm shaft *A* provided with a spindle *B*, and having a collar *G* at its lower end, the nut *F*, the bit socket or stock *L* and the pawl *P* engaging a ratchet *K*, substantially as specified.

No. 31,543. Machine for Cutting Hoops.

(*Machine à tailler les cercles.*)

Otto Schimansky, Sandusky, Ohio, U.S., 7th June, 1889; 5 years.

Claim.—1st. The combination, with the frame *A* and feeding devices of a hoop-cutting machine, of a composite cutter-head consisting of an alternating series of saws *E*, and planer heads *G* upon a common arbor *F*, and secured together by clamping collars *a*, substantially as described. 2nd. The combination, with the frame *A* and feeding devices of a hoop-cutting machine, of a composite cutter-head consisting of an alternating series of saws *E*, and planer heads *G* secured upon a common arbor *F*, and a lower planer head *J* provided with cutters, substantially as described. 3rd. In a hoop-cutting machine, substantially as described, the combination, with the frame *A* and feeding devices *B*, of the feed-rolls *D*, the reversing clutch and drive-pulleys in the drive mechanism thereof, and the reversing lever *P*, all arranged to operate substantially as described.

No. 31,544. Machine for Pointing Hoops.

(*Machine à effiler les cercles.*)

Otto Schimansky, Sandusky, Ohio, U.S., 7th June, 1889; 5 years.

Claim.—1st. In a hoop-pointing machine, the combination, with the cutting block *M*, of stationary hoop centering guides *O* and *P*, and a stationary stop *L*, substantially as described. 2nd. In a hoop-pointing machine, the combination of the cutting block *M*, the hoop-rest *N*, the centering guides *O* and *P* and the stop *L*, all arranged to operate substantially as described. 3rd. In a hoop-pointing machine, the combination, with the cutting block *M*, of the reciprocating knife-head *F*, the knife-guide *K* and the combined knife-guide and stripper *K*, substantially as described. 4th. In a hoop-pointing machine, the combination of the cutting block *M*, the reciprocating knife head *F* and the knives *J*, substantially as described. 5th. In a hoop-pointing machine, the combination of the frame *A*, the shaft *C*, the drive-pulleys *D*, the crank *E*, the connecting rod *I*, the reciprocating shank *G*, the knife-head *F*, the knives *J*, the guides *H*, the knife-guides *K* and *K*, the cutting block *M*, the hoop-rest *N*, the centering guides *O* and *P* and the stop *L*, all arranged substantially as described.

No. 31,545. Process or Method of Treating Hides, Skins or Scraps in Liquids.

(*Procédé ou mode de traitement des peaux ou effluves dans les liquides.*)

Charles W. Cooper, Brooklyn, N.Y., U.S., 7th June, 1889; 5 years.

Claim.—1st. The method of agitating or treating hides in liquid, which consists in subjecting said hides in a receptacle through orifices in the sides or bottom of which the said liquid may flow in and out from a common liquid reservoir, to the action of currents of air introduced within and at or near the bottom of said receptacle, as specified. 2nd. The method of treating hides or glue scraps in water or other liquid in the chemical treatment thereof, or for the removal of impurities therefrom, which consists in feeding air or a suitable gas into and at or near the bottom of a vessel containing the mass to be treated, in such manner as to cause the hides or scraps treated to be agitated in contact with each other, and at the same time to cause the water or liquid in said vessel to flow or circulate from the upper part of said vessel to the lower part thereof and under the hides or scraps therein, as specified.

No. 31,546. Advertising Rack for Street Cars.

(*Porte-annonce pour chars urbains.*)

Isaac H. Randall, Boston, Mass., U.S., 7th June, 1889; 5 years.

Claim.—The combination of the curved body *A* and the longitudinal strips *D*, having the grooves *c*, substantially as and for the purpose hereinbefore set forth.

No. 31,547. Apparatus for Electrically Lighting Railway Trains.

(*Appareil d'éclairage électrique des trains de chemins de fer.*)

Illins A. Timmis, London, Eng., 7th June, 1889; 15 years.

Claim.—1st. The combination, substantially as hereinbefore set forth, of an independently driven dynamo or generator of electricity mounted upon a locomotive, an electric charging circuit running from the generator through all the cars, a secondary battery in each car and in said circuit lamps in the car in multiple arc circuit with the charging circuit and secondary battery, and a circuit-controlling device which simultaneously cuts out and lets in both the generator and storage battery. 2nd. The combination, substantially as hereinbefore set forth, of an independently driven dynamo or generator of electricity mounted upon a locomotive, an electric charging circuit running from the generator through the cars, a secondary battery in each car and in said circuit lamps in the car in the multiple arc circuit with the charging circuit and secondary battery, an electro-magnetic circuit-controlling device, which cuts the lamps in and out of circuit, and a controlling circuit which regulates the circuit-controlling device whereby the lamps may be lighted or extinguished from the locomotive, as well as from the car. 3rd. The combination,

substantially as hereinbefore set forth, of a railway train, a dynamo or generator, an electric charging circuit running from car to car, a secondary battery in each car in multiple arc with said circuit, lamps in each car also in multiple arc with said circuit and secondary battery, a circuit-controlling device which holds the lamps out of circuit in an independent circuit, and detachable circuit connections between the cars, whereby the lamps are automatically lighted by the separation of the cars and the consequent breaking of the circuit. 4th. The combination, substantially as hereinbefore set forth, of a train of cars carrying secondary batteries, a generator and a charging circuit and lamps, all in multiple arc in the same charging circuit with the secondary batteries, so that any inequality in condition of the storage batteries is rapidly compensated when the train is coupled up. 5th. The combination, substantially as hereinbefore set forth, of the generator, the charging circuit, the storage batteries and lamps in multiple arc in the charging circuit, their electro-magnetic circuit-controllers, the actuating mechanism thereof and a controlling circuit, of which one of the charging wires constitutes a portion.

No. 31,548. Broom Sewing Machine.

(*Machine à coudre les balais.*)

George F. McCombs, Allegheny, Penn., U.S., 7th June, 1889; 15 years.

Claim.—1st. In a broom sewing machine, the combination of a carriage fitted to slide upon ways or guides, a broom vise or clamp pivoted to said carriage, a rock-shaft *16* operated by the carriage in its inward traverse mechanism, substantially as described, for centering and clamping the broom vise in operative position, a rock-shaft *187*, a sliding head fitted to have a traverse on the rock-shaft at right angles to the axis thereof and operated by the vise centering and clamping mechanism, and a feed-rod connected to the broom vise or clamp and operated by the sliding head, substantially as set forth. 2nd. In a broom sewing machine, the combination of a pivotally mounted broom vise or clamp mechanism for centering and clamping the broom vise in operative position, a rock-shaft *16* operating such centering and clamping mechanism, and controlled thereby, a rock-shaft *187*, a sliding head fitted to have a traverse on said rock-shaft at right angles to the axis thereof, an adjustable connection between the sliding head, and an arm on rock-shaft *16*, and a feed-rod connected to the broom vise or clamp and operated by the sliding head, substantially as set forth. 3rd. In a broom sewing machine, the combination of a pivotally mounted broom vise or clamp, a plate *183* connected to said vise or clamp, and having a circular rim formed thereon, a feed bar having a groove formed therein for the reception of the circular rim, thereby forming a hinge joint between the plate and feed-bar mechanism, substantially as described, for moving the feed-bar, substantially as set forth. 4th. In a broom sewing machine, the combination of a pivotally mounted broom vise or clamp, a feed bar connected to the vise or clamp, a reciprocating automatically operating grip and an automatically operating detent, substantially as set forth. 5th. In a broom sewing machine, the combination of a pivotally mounted broom vise or clamp, a movable feed bar connected thereto, and a brake or hold-back for controlling the movements of the vise, substantially as set forth. 6th. In a broom sewing machine, the combination of a pivotally mounted broom vise or clamp, a feed bar connected thereto, a reciprocating automatically operating grip, an automatically operating detent, and a brake or hold-back for controlling the movements of the vise or clamp, substantially as set forth. 7th. In a broom sewing machine, the combination of a swinging block, having an opening therethrough, jaws arranged in said opening, and automatically adjustable shoes mounted in the adjacent faces of said jaws, and a feed bar having parallel edges passing between said shoes, substantially as set forth. 8th. In a broom sewing machine, the combination of a swinging block having an opening therethrough, jaws arranged in said opening, one of said jaws being adjustable automatically, adjustable shoes mounted in the adjacent faces of said jaws, and a feed-bar having parallel edges passing between said shoes, substantially as set forth. 9th. In a broom sewing machine, the combination of a swinging block having an opening therethrough, jaws arranged in said opening, automatically adjustable shoes mounted in the adjacent faces of said jaws, and shoes lying in different vertical planes, and a feed-bar having parallel edges passing between said shoes, substantially as set forth. 10th. In a broom sewing machine, the combination of a block having an opening therethrough, a feed-bar having a wedge-like portion on one side thereof and passing through said opening, a stationary and a movable shoe arranged on opposite sides of the feed-bar, the movable shoe having a yielding pressure upon the feed-bar, substantially as set forth. 11th. In a broom sewing machine, the combination, of a block having an opening therethrough, a feed-bar having a wedge-like portion on one side thereof and passing through said opening, a stationary and a movable shoe arranged on opposite sides of the feed-bar, and a spring-actuated plunger for forcing the movable shoes against the feed-bar, substantially as set forth. 12th. In a broom sewing machine, the combination of a block having an opening therethrough, a feed-bar, having a wedge-like portion on one side thereof and passing through said opening, a stationary and a movable shoe arranged on opposite sides of said feed-bar, a plunger bearing at one end against the movable shoe, a tension plate adjustably mounted on a stud on said block, and a spring surrounding the plunger and interposed between said plate and a shoulder on the plunger, substantially as set forth. 13th. In a broom sewing machine, the combination of a block having an opening therethrough, a feed-bar having a wedge-like portion on one side thereof and passing through said opening, a stationary and a movable shoe arranged on opposite sides of said bar, a spring-actuated plunger operative on the movable shoe lever connected to the plunger, a pin bearing against the free end of said lever, and a movable wedge for moving the pin, substantially as set forth. 14th. In a broom sewing machine, the combination of a block having an opening therethrough, a feed-bar, having a wedge-like portion and passing through said opening, a spring-actuated plunger for controlling the movements of the feed-bar, and a wedge for forcing the plunger away from the feed-bar, substantially as set forth. 15th. In a broom sewing ma-

chine, the combination of a carriage fitted to slide upon ways or guides, a broom, vise or clamp pivoted to said carriage, a feed-bar connected to the vise or clamp, a reciprocating automatically operating grip, an automatically operating detent and tripping arms for releasing the feed-bar from engagement with the grip and detent, substantially as set forth. 16th. In a broom sewing machine, the combination of a carriage fitted to slide upon ways or guides, a broom, vise, or clamp pivoted to said carriage, a feed-bar connected to the vise or clamp, a reciprocating automatically operating grip, an automatically operating detent, a brake or hold-back and simultaneously operating tripping levers for releasing the feed-bar from engagement with the grip detent and brake or hold-back, substantially as set forth. 17th. In a broom sewing machine, the combination of a wheel having a cam ring 233, said ring being provided with shoulders 235 on its inner face, in line, or approximately so with the front ends of the active portions of the cam ring, a rock shaft, an arm secured thereto and rollers mounted on said arm and adapted to engage the opposite faces of the cam-ring, the roller engaging the inner face being adjustable, substantially as set forth. 18th. In a broom sewing machine, the combination of a lever 146, having a roller mounted thereon, a cam 148, having a cam groove for the reception of said roller, an adjusting bolt having a flexible connection to the lever 146, whereby the roller on said lever may be adjusted and held in proper operative position, substantially as set forth.

No. 31,549. Fiber Digester.

(*Pourrissoir de fibres*)

John H. Brown, New York, N.Y., U.S., 7th June, 1889; 15 years.

Claim.—1st. In a digester, the combination of a central liquid-distributing chamber, having perforated walls, and outer liquid-distributing chambers having perforated inner walls opposite to said walls of the central chamber, substantially as shown and described. 2nd. In a digester, the combination of a central liquid distributing chamber having perforated walls, outer liquid distributing chamber, having perforated inner walls opposite to said walls of the central chamber, and a storage chamber communicating with said outer distributing chambers, substantially as shown and described. 3rd. In a digester, the combination of a central liquid-distributing chamber having perforated walls, outer liquid distributing chambers having perforated inner walls opposite to said walls of the central chamber, and heating pipes arranged in said chambers, substantially as shown and described.

No. 31,550. Fire Escape. (*Sauveteur d'incendie*.)

Valentine J. Klase and Timothy O'Connor, Guelph, Ont., 7th June, 1889; 5 years.

Claim.—1st. The fire-escape friction device H, having the holes E and E', the bar G, aperture F and F' and holes D and D', as shown and described for the purpose set forth. 2nd. The device H, as shown and described, in combination with the rope I having loops C and C', and the belt-fastening, as described and shown, the whole for the purpose set forth.

No. 31,551. Machine for Ornamenting Paper

(*Machine à décorer le papier*.)

Charles G. Mortimer and George W. Thompson, New York, N.Y., U.S., 10th June, 1889; 5 years.

Claim.—1st. In a machine for ornamenting paper, the combination of the reservoirs, the distributing tubes C communicating with the said reservoirs, the stop-cocks in these tubes, the depending tubes attached to these stop-cocks, the inking felts and shelf for supporting the same, the color-separating plates supported upon the said shelf and the impression roller, substantially as described. 2nd. The combination of the reservoirs, means for supplying colors to the inking felts, the shelf G for supporting the inking felts, the inking felts overlapping the impression roller and applying the colors thereto, the impression roller having raised ornamenting rings on its surface, and the color-separating plates supported upon the said shelf and extending down between the ornamenting rings upon the impression roller, substantially as described. 3rd. The combination of a shelf G, the impression rollers provided with raised ornamenting surfaces, the inking-felts overlapping the impression roller, means for supplying colors to said felts, and the color-separating plates mounted upon the said shelf G between the inking felts, and extending down to a point in close proximity to the surface of the impression roller, substantially as described. 4th. The combination of the impression roller having raised elastic ornamenting surfaces, the inclined shelf located above the same, the independent inking felts overlapping the said roller, means for supplying the colors to the said felts, and the removable and adjustable color-separating plates inserted between the said inking felts, whereby the different colors are prevented from blending, substantially as described. 5th. The combination of the impression roller and the inking-felts, the distributing tubes C arranged above the said inking felts, and the depending color-supplying tubes attached to and communicating with the said distributing tubes C, substantially as described.

No. 31,552. Envelope or Bag Machine.

(*Machine à enveloppes ou à sacs*.)

The Ajax Envelope Company, New York, N.Y. (assignee of George R. Clark, Montel, Texas), U.S., 10th June, 1889; 5 years.

Claim.—1st. The pneumatic-mechanical feeder for the blanks, comprising suction roller, the air exhauster connected therewith, the pressure roller bearing on said suction roller and the reciprocating blank platform, said platform being substantially on a level with the top of the suction roller, all combined and arranged substantially as set forth, whereby the blanks are fed from the bottom of the pile. 2nd. The combination, with a feeder that feeds the blanks to the endless carrier, of the said carrier provided with grippers for holding the advancing ends of the blanks, the gripper

openers, the folders for folding the lateral flaps of the blank and the folding blade, substantially as set forth. 3rd. The combination, with the gumming roller or disk *u* for applying a stripe of gum to the lateral flap of the blank, and the gum reservoir in which said disk rotates, of the rock shaft *z*, the arm *s* on said shaft for pressing the blank down upon said disk, the arm *u* on said shaft for lifting the blank free from said disk, the operating arm *v* on said shaft, and the wheel provided with lifting studs *w* arranged to take under and lift said arm *v*, substantially as set forth. 4th. The combination, with the suction roller and a pulley *C* fixed on the shaft of said roller, of the cylinder *z* mounted in said pulley and its piston, the interior of said cylinder being connected with the interior of the suction roller by a closed passage, the two bell cranks mounted in said pulley and having one arm of each crank coupled to said piston, the rollers on the other arms of said crank and the crank *T*, which actuates the piston in the cylinder through the medium of said cranks and rollers, substantially as set forth. 5th. The combination, with the pulley *C* and the air exhauster mounted therein, of the pivotally mounted cam *T* and its spring *G*, of the cam *r* and its shaft, said cam *r* being arranged to vibrate the cam *T*, substantially as and for the purposes set forth. 6th. The combination, with the reciprocating blank platform *J*, the upright *s* arranged in front of same, and the finger *r*, of the air exhausting device, the suction roller *I*, said blank platform being arranged substantially on a level with the top of the suction roller, and having a speed about equal to the peripheral speed of said roller, as set forth. 7th. The combination, with the carrier *G* and the shafts and sprocket wheels on which it is mounted, of the spring grippers *t* mounted on said carrier, the disks *R* bearing lugs *U* arranged in the path of the tails on the grippers, and the device for shifting the position of the disk and lug comprising a shaft *S* bearing an arm *p* on which is a stud *p* which engages a notch in the disk, substantially as set forth. 8th. The combination, with the shafts *D*, *D*' and the sprocket wheels and drums mounted thereon, of the endless carrier *G* consisting of two chains *d*, *d* connected at short intervals by rods *e*, *e*, and an apron *f* made up of sections secured at their advancing ends only to the carrier, substantially as set forth. 9th. The combination, with a gum reservoir *O* and a gum supply roller *O*' therein, of a hollow gumming roller *M* having a recessed face, a printing face *M*' mounted in said recess and provided with a retracting spring, and a stem *f* and a device for throwing out said printing face in order that it may receive gum from roller *O*', said device consisting of a rock shaft *h* in said roller provided with an arm *h*² which bears on the end of stem *f*, and an exterior arm *i* and a cam piece *j* secured to the machine frame exterior to roller *M* and arranged in the path of the arm *i*, substantially as set forth. 10th. The combination, with the folding rollers *z*, *z*', of the striker *b*₁, its cam *c*² and spring *c*₁ and the vibrating guard *a*₃, all arranged and adapted to operate substantially as shown. 11th. A pneumatic-mechanical feeder for the sheets or blanks comprising a revolving suction roller, an air exhauster connected with said suction roller and actuated intermittently, a pressure roller bearing on said suction roller and a reciprocating platform for the sheets or blanks arranged to move toward the section roller with a speed substantially equal to the peripheral speed of the suction roller, all combined and arranged substantially as set forth.

No. 31,553. Lamp Burner. (*Bec de lampe*.)

Stephen Ellis and Abram Wood, Jacksonville, U.S., 10th June, 1889; 5 years.

Claim.—1st. A lamp burner constructed with a perforated horizontal plate, with a wick tube projecting through the same, an air tube and gas tube, a guard casing resting on the perforated horizontal plate of burner and inclosing the wick tube, and open upper ends of air tube and gas tube with a closed top surrounding the wick tube, openings in its sides for the passage of air, and an air space between its walls and the wick tube and above the open upper ends of air tube and gas tube, and the perforated horizontal plate of lamp burner, substantially as shown and described. 2nd. A lamp burner constructed with a perforated horizontal plate, with a wick tube projecting through the same, an air tube and a gas tube, inlet air passages in the burner beneath the horizontal perforated plate, a guard casing resting on the perforated plate and inclosing the wick tube and upper ends of air tube and gas tube with a closed top surrounding the wick tube, openings in its sides for the escape of air and gas, and an air space between its walls and the wick tube and above the open upper ends of air tube and gas tube and the perforated plate, substantially as shown and described. 3rd. A lamp burner constructed with a perforated horizontal plate, with a wick tube projecting through the same, an air tube and a guard casing extending over the open upper end of air tube, inclosing the wick tube and forming an intervening air space with a closed top surrounding the wick tube, and openings in its sides for the passage of air, substantially as shown and described. 4th. In a lamp burner, the guard casing *6* formed with the vertical portion *9*, wick tube slot *10* in its top, air openings *11* in its sides, and a base portion *7* extending laterally therefrom with a depending flange *8*, substantially as shown and described. 5th. The combination, with a lamp burner *1* constructed with air inlet openings *13*, an air tube *2* and a gas tube *5* located adjacent to the wick tube *3* with their upper open ends in the perforated plate *4*, of a detachable guard casing *6* having a base portion *7* with depending flange *8* resting on plate *4*, and inclosing open ends of air tube *2*, and gas tube *5* and the vertical portion *9* with a slot *10* in its top inclosing wick tube *3*, and openings *11* in its sides for passage of air from the space between the wick tube *3* and casing *6*, substantially as shown and described.

No. 31,554. Fire Escape. (*Sauveteur d'incendie*.)

Homer Le R. Boyle, Grand Rapids, Mich., U.S., 10th June, 1889; 5 years.

Claim.—1st. In a fire escape, the combination of a friction block having transverse cord holes *I* passing through it, and a guide loop or eye at its upper side, cords passing through said loop or eye and transverse cord holes from opposite sides, and a strap or support attached to the block, substantially as described. 2nd. In a fire

escape, the friction block B having transverse cord holes passing therethrough, the bail A and loop E, in combination with the cord C passing through said loop and also the transverse cord holes, substantially as described. 3rd. The combination of the friction block B provided with the support A and loop E, the cords C, C adapted to pass through the openings in said block, the block D and the supporting strap U, and constructed as described. 4th. In a fire escape, a friction block provided with one or more openings for the cords, in combination with two cords, one cord passing through the opening in one direction, and the other cord passing through from the opposite direction, and said block adapted to be retarded in its sliding motion by means of the friction between the cords and the friction block, as set forth. 5th. The combination of a friction block B having transverse cord holes I, and the cords C passing through said holes from the opposite sides of said friction block, with the check block D arranged upon the cords below said friction block, and adapted to be moved up or down upon said cords for increasing or decreasing the frictional resistance thereon, substantially as described.

No. 31,555. Fastening for Roof Slates.

(*Agrafe pour ardoises de toitures.*)

Orlando W. Norcross, Worcester, Mass., U.S., 10th June, 1889; 5 years.

Claim.—A fastening device for roof plates comprising in combination a wire spring part bent in such a manner as to be hooked over or around the purlin, and adapted to bear upon the opposite side thereof, also to form a spiral coil or spring nut at or about right angles to the slate, and at a short distance above the purlin when fitted thereto, and a suitable screw adapted to be passed down through the slate and turned into the aforesaid spring nut, substantially as set forth and shown.

No. 31,556. Plated Ornamental Ring adapted for Jewellery. (*Anneau d'ornement plaqué propre à la bijouterie.*)

George H. Knight, Providence, R. I., U. S., 10th June, 1889; 5 years.

Claim.—1st. A jointless ring having plated inner and outer surfaces, and having thickened edges formed by an outwardly turned thinned portion or flange, which carries the inner plating outwardly and back against the surface of the outer plating over the edge of the ring and conceals the base metal, substantially as described. 2nd. A jointless ring having plated inner and outer surfaces, and having angular thickened edges formed by an outwardly turned thinned portion or flange, which carries the inner plating outwardly and back against the surface of the outer plating over the edge of the ring and conceals the base metal, substantially as described.

No. 31,557. Manufacture of Plated Rings adapted for Jewellery. (*Fabrication des anneaux plaqués propres à la bijouterie.*)

George H. Knight, Providence, R. I., U. S., 10th June, 1889; 5 years.

Claim.—1st. A plated ornamental ring formed from a plated seamless tube, and having the end portions of the tube turned backward to meet each other, and rest upon the middle portion, substantially as described. 2nd. A plated ornamental ring formed from a plated seamless tube, and having the end portions of the tube turned backward to meet each other and rest upon the middle portion, with the plating of the end portions turned to the middle portion, substantially as described.

No. 31,558. Cabinet Show Case.

(*Montre à marchandises.*)

Emmanuel Pifferling, Washington, D. C., U. S., 10th June, 1889; 5 years.

Claim.—1st. A cabinet for displaying merchandise consisting of a series of horizontally sliding open top compartments arranged in tiers, the compartments of each upper tier being successively shorter in length than the next underlying one, in combination with upright partitions dividing the compartments of each tier, said partitions being cut away at their front edges in successive steps equal or substantially so to the length of the respective compartments when extended upon cleats attached to the side surfaces of the partitions, substantially as described. 2nd. In a cabinet for displaying merchandise, the combination of the following elements: a show case having transparent top sides and front and rigid bottom and back frame, a series of transverse parallel partitions 4 firmly adjusted to the back and floor of the case, each of said partitions being cut away forwardly into a series of steps, cleats 6 extending horizontally along the sides of the partitions, tiers of sliding open top compartments 9 arranged to be moved forward and backward upon the cleats, each tier of said compartments being successively shorter in length than the next underlying tier of compartments, and arranged as described, whereby when said compartments are introduced their full length forwardly between the partitions 4, their front panels 9a will be in line with the respective risers 5 of said partitions, substantially as described. 3rd. In a cabinet for exhibiting goods, the combination with a casing having transparent panels and provided with a series of partitions having their forward edges cut away to form steps separated by inclined or sloping risers, of a series of compartments arranged in tiers, each underlying tier being of greater length than the one above it, the front ends of said compartments being in line with the risers of the partitions, and provided with suitable clips for detachably affixing advertising or other cards, substantially as described. 4th. In a cabinet for exhibiting goods, the combination, with a case having transparent panels and provided with partitions

cut away at their forward edges to form a series of steps separated by sloping risers, of a series of compartments sliding between said partitions and arranged in tiers, each underlying tier being of greater length than the one next above it, the forward end panels of said compartment being sloped to correspond with the incline of the risers, and provided with electric strips fastened at one end beneath the end of the compartment, and having their other ends lying upon the sloping front panel, substantially as described.

No. 31,559. Manufacture of Mill Stones.

(*Fabrication des pierres meulrières.*)

Charles J. Potter, Newcastle, Eng., 10th June, 1889; 5 years.

Claim.—1st. A mill stone built up of lumps of emery cemented together, substantially as described. 2nd. A mill stone built up of lumps of emery cemented together, the size of the lumps decreasing from the centre outwards, substantially as described. 3rd. A mill stone formed of a concrete of lumps of emery and cement cast into a metal cylinder, substantially as described. 4th. A mill stone having an inner ring of burr or other suitable stone, and an outer ring built up of lumps of emery, substantially as described.

No. 31,560. Envelope and Tag Fastener.

(*Ligature d'enveloppe et d'étiquette.*)

Frederick C. Mercer, Winnipeg, Mass., 10th June, 1889; 5 years.

Claim.—1st. A metallic envelope and tag fastener composed of two parts, one of which has a slit tube attached to a cap piece, the tube of one part being made to go inside the tube of the other, so that they may be clinched together, substantially as shown and described. 2nd. A metallic fastener composed of parts A and B having the tube C in which the slit E is made, and the tube D projected through the folds of an envelope or wrapper or tag and clinched together, substantially as described.

No. 31,561. Saw Gummer and Sharpener.

(*Machine à évider et affûter les scies.*)

Michael I. Welch, Waldosta, Ga., U. S., 10th June, 1889; 5 years.

Claim.—1st. The combination of a continuously rotating emery wheel, an oscillating frame or arm in which it is carried, a fixed plate attached to the frame or arm, an arm or plate pivoted at one end to the fixed plate, and extending below the lower edge thereof, a rocker shaft and crank operating against the lower edge of the plates, substantially as set forth. 2nd. The combination, with an oscillating arm, an emery wheel carried thereby, the rocker shaft and arm for causing the oscillation of the oscillating arm, a plate secured to the oscillating arm and operated upon by the arm of the rocker shaft, a pivoted arm attached to and extending below the bottom of the plate also operated upon by the rocker shaft, a feed lever connected to the pivoted arm, and a feed finger connected to the lever for moving the saw in the manner hereinafter set forth while the emery wheel is being revolved, as set forth. 3rd. The combination of an oscillating arm, a side plate fixed to the free end thereof, a plate pivoted to the fixed plate at one end and held in a guide at the other, and projections beneath the lower edge of the said fixed plate, an arbor carried by the free end of the oscillating arm, an emery wheel mounted on said arbor, a rocker shaft mounted beneath the oscillating arm having a roller crank for operating on the lower edge of the piston, a pivoted feed lever having a hook for feeding the saw, and connections from the pivoted plate to the feed lever, as and for the purpose set forth. 4th. The combination of the double arched standard bearing the main shaft gears crank and pulley arranged as described, the oscillating arm carrying the emery wheel, arbor and pulley, the steadying post on which it is guided, the rocker shaft having a slotted arm connected to the crank by a pitman which is detachable from the arm, and a roller arm, a plate on the oscillating arm under which the roller operates a pivoted arm carrying the slotted extension also resting upon the roller, the jointed rod and the feed lever, all substantially as and for the purpose set forth.

No. 31,562. Lever Attached to Vice or Tongs for the Purpose of Securely and Easily Closing the Jaws of the Same. (*Lever adapté aux étaux ou pinces afin d'en ouvrir les mâchoires sûrement et facilement.*)

Emmanuel Beauchamp, Ste. Cunégonde, Qué., 10th June, 1889; 5 years.

Claim.—In connection with tongs A, the combination of the fulcrum pieces B, pivot pin C, lever D, rigid arms E, pivot pins F and G, the whole constructed, arranged and operating substantially as set forth.

No. 31,563. Household Utensil.

(*Ustensile domestique.*)

Robert Lindsay, Montréal, Qué., 10th June, 1889; 5 years.

Claim.—The household utensil or milk storage vessel composed of the combination of the following elements, viz.: the cylinder A, lid B, movable strainer C, funnel shaped bottom D and discharge pipe E, all substantially as herein set forth and for the purposes described.

No. 31,564. Hoisting Machine. (*Vindas.*)

Timothy W. Lemieux, Duluth, Minn., U. S., 10th June, 1889; 5 years.

Claim.—1st. In a hoisting machine, the combination, with the power shaft, a drum loosely mounted thereon provided with a head having an annular brake seat, and a cogged surface on its outer face,

and a disk having a cogged inner face fixedly secured upon the power shaft, of a pulley loosely mounted on the said shaft between the drum head and the fixed disk, said pulley provided with an annular brake seat cog gears journaled in the web of the pulley M adapted to engage the cogged surfaces of the drum head, and fixed disk and brake mechanism substantially as shown and described for alternately braking the drum head and loose pulley, as and for the purpose described. 2nd. The combination, with the shaft E, the drum B and pulley M loosely mounted on said shaft, said drum provided with a band brake wheel C, said pulley M provided with band brake seat I, and the band brakes K, K' of the frame O, the screw shafts P, P journaled in said frame, said shafts provided with right and left hand screw sections p_1 , p_2 , sliding boxes p_3 , p_4 mounted on said screw sections p_1 , p_2 , the sliding boxes p_3 connected to the ends of the band brake K, the boxes p_4 being connected to the ends of the band brake K', the pulley P provided with a hand wheel N and a gear wheel p_7 engaging a similar wheel p_8 on shaft P', whereby the band brakes may be alternately engaged and disengaged from operation with their respective hand wheels, and means for revolving said drum b and the pulley M, substantially as shown and described.

No. 31,565. Pocket Fastener. (Agrafe-poche)

Bedford Woodsford, Chelsea, Eng., 10th June, 1889; 5 years.

Claim.—1st. A pocket fastener consisting essentially of a flexible steel band formed of two parts adapted to be locked together by a spring snap or its equivalent, and released by a spring push or button, as set forth. 2nd. In a pocket fastener, the combination, with the spring snap or hook, of the projection on the back of the operating push or button, as and for the purpose set forth. 3rd. In a pocket fastener, the combination, with the spring strap or hook and its operating button, of the guard surrounding the said button, as and for the purpose set forth. 4th. In a pocket fastener, the combination, with the flexible band, of the hook or snap B, the button B', the guard frame A z , the eye or catch C, and the spring b_1 , all constructed, arranged and operating, as and for the purpose set forth.

No. 31,566. Lifting Jack. (Cric.)

Charles T. Eddy, St. Catharines, Ont., 10th June, 1889; 5 years.

Claim.—In a lifting jack, the standards A secured and held apart by means of the top piece B, foot piece c and bolts the fulcrum holes e, the fulcrum pin D and the lever F with rod e having a T headed end and attached thereto at H, all formed, arranged and combined substantially as and for the purpose hereinbefore set forth.

No. 31,567. Sprinkler. (Arrosoir.)

Adam Weaver, Vinland, N.J., U.S., 10th June, 1889; 5 years.

Claim.—1st. The combination, with a tank or reservoir adapted to be carried on the back, of an inverted pump cylinder secured to the bottom of said reservoir, and connected with its interior by means of a valve port, an air chamber surrounding the pump cylinder and connected therewith by means of a valve port, a discharge pipe connected with the air chamber, a plunger rod in the pump cylinder and depending from the bottom of the main reservoir, a horizontal rock shaft connected with the said plunger rod, and a hand lever connected with the opposite end of the said rock shaft, substantially as specified. 2nd. The combination, with a reservoir adapted to be carried on the back and having a skirt flange as described, and also an aperture in its floor of the casting E removably secured in the said aperture and having valve ports and a discharge pipe, a pump cylinder and an air chamber respectively secured to the said fastening, whereby the whole may be removed from the reservoir for repair or the like, substantially as specified. 3rd. The combination, with a spray pipe having its forward end curved laterally, of the nozzle secured thereto, and the valve arranged in the said nozzle and having a reduced forward end adapted to clear the discharge substantially as specified.

No. 31,568. Vehicle Axle. (Essien de voiture.)

William H. Wright, Buffalo, N.Y., U.S., 10th June, 1889; 5 years.

Claim.—As an improved article of manufacture, a vehicle axle consisting essentially of the axle A having the fixed collar B, screw threaded portion a directly in front of said collar and shank B, the sleeve C having wrench section c, cylindrical portion c_1 and collar D, swivel nut E revolving upon said portion c_1 and engaging the enlarged portion f of the skein F, said skein having a screw threaded portion h of the skein F, said skein having a screw threaded portion k fitted with the nut H and bearing with its enlarged portion f against the web i, and with the nut H against the web k of the bands I, K respectively, as and for the purpose stated.

No. 31,569. Dry Closet. (Latrines sèches.)

Lucian B. Robb, Cincinnati, Ohio, U.S., 10th June, 1889; 5 years.

Claim.—1st. The combination in an cremating closet of a deposit chamber having means of leading sewage, etc., into the same, a furnace for drying the sewage, an exit for said furnace, and a diving flue communicating with said chamber, and discharging into the furnace at or near the front of the same, for the purpose described. 2nd. The combination in a cremating closet, of furnace E, diving flues F, F', openings f, f', deposit chamber G, doors H, K, exit I, inlet J and pits L, L', which latter are charged with a non-combustible absorbent bed as M, for the purpose described.

No. 31,570. Bureau. (Commode.)

Dwight C. Clapp, David M. Estey, Charles E. Rigley and The Essex Manufacturing Company, Owosso, Mich., U. S., 10th June, 1889; 5 years.

Claim.—1st. In a bureau wash-stand, or similar article of cabinet ware, a flat spring bulged outward at its middle, secured to the end

piece of a drawer at one end, and having a longitudinally-slotted straight end sliding upon a stud upon the end of the drawer and having the outermost end bent to form a lip, as shown and set forth. 2nd. In a bureau wash-stand, or similar article of cabinet ware, the combination of drawer guides at one panel, having spring cushioned guide blocks bearing against one end of the drawers, the drawers and flat springs bulged at their middles and secured at one end to the end pieces of the drawers, and having their longitudinally-slotted free ends sliding upon studs or pins upon the ends of the drawers, as shown and set forth.

No. 31,571. Bureau. (Commode.)

Dwight C. Clapp, David M. Estey, Charles E. Rigley, and The Estey Manufacturing Company, Owosso, Mich., U. S., 10th June, 1889; 5 years.

Claim.—1st. In a bureau, the combination, with the end panels, the inner faces of which are provided with horizontal grooves, of the combined guides and supports, each of which is composed of a bar and a strip, the outer side of each of which is provided with a tongue formed by rabbeting the lower outer edges, and the inner face of the bar is provided with a longitudinal groove the tongue of the bar fitting within the groove in the inner face of the end panel, and the tongue of the support fitting in the groove of the bar. 2nd. In a bureau, the combination, with the end panels, of drawers, guides upon the inner face of one panel, and supports upon the inner face of the other panel, strips upon the supports, each having a dovetailed recess in its inner face, and a spring-actuated dovetailed piece cut from said strip and fitting within the recess and bearing against the end of the drawer, as and for the purpose set forth. 3rd. The combination of an end panel, of a bureau having transverse grooves upon the inner side, bars secured in the grooves and having dovetailed recesses in their inner projecting faces, bars glued to the projecting portions of the under sides of the bars, and having their upper corners rabbeted to form grooves, supporting strips fitted with tongues into the said grooves, and dovetailed bars or pieces fitting into the recesses and forced outward in the same by suitable springs, as and for the purpose shown and set forth. 4th. In a bureau, the combination of the drawers, suitable end guides for the drawers upon one end panel, an end panel having horizontal grooves, bars secured with their outer sides in the grooves, and having dovetailed recesses in their inner sides, bars secured to the under sides of the former bars, and having their upper corners rabbeted to form grooves, strips having tongues fitting into the said grooves, and forming supports for the drawers, dovetailed pieces fitting in the recesses and projecting slightly out of the same, and flat springs secured with their inner ends in the inner sides of the recesses, and having their diverging and bulging ends bearing against the inner faces of the dovetailed strips or pieces, forcing them out of the recess, as and for the purpose shown and set forth.

No. 31,572. Apparatus for Calculating Multiplication Sums. (Appareil pour calculer des sommes de multiplication.)

Paul C. Illgen, Leipsig, Germany, 10th June, 1889; 5 years.

Claim.—1st. The improved apparatus for calculating multiplication sums, arranged and operating substantially as described. 2nd. In apparatus for calculating multiplication sums, arranging the numerals employed to represent the intermediate products, as also those showing the multiplicand in rows upon parallel and movable slides, such as b and g , the latter bearing the numerals appertaining to the multiplier and being arranged at right angles to the slides b , so that by setting the slides b to expose a given multiplicand, and setting the perforated slides g to expose a given multiplier, the figures from which the product is derived appear in the openings corresponding with the points of intersection of the slides. 3rd. In apparatus for calculating multiplication sums, constructed substantially as referred to in the last preceding claiming clause, arranging the numerals constituting respectively the units and the tens in such a manner that they appear through separate openings b_1 , b_2 , substantially as described. 4th. In apparatus for calculating multiplication sums, constructed substantially as referred to in the second claiming clause, the substitution for the slides b and g , of rollers b_1 operating substantially as described. 5th. In apparatus for calculating multiplication sums, the employment of grooves n , with which springs engage for holding the slides or the rollers or the parts whereby they are actuated in place, substantially as described.

No. 31,573. Regulator for Dynamo Electric Machines. (Regulateur pour machines dynamo-électriques.)

Jesse F. Kester and Joseph H. Briggs, Terre-Haute, Ind., U. S., 11th June, 1889; 5 years.

Claim.—1st. A dynamo regulator comprising adjustable commutator brushes, an electro-magnetic device to shift the same, a normally open regulating circuit, including the electro-magnetic device, a circuit controller and a speed governor carried by a rotating part of the machine, and connected with the circuit controller, as set forth. 2nd. In a regulator for an electric motor or generator, the combination of a movable brush holder for the commutator brushes, an electro-magnet to shift the brush holder and change the line of commutation, a regulating circuit, including the electro-magnet, a circuit controller in the circuit, and a speed governor attached to a rotating part of the machine for operating the circuit controller when the machine reaches a certain speed, as described. 3rd. In a regulator for an electric motor or generator, the combination of a movable brush holder, an electric magnet to shift said brush holder, a regulating circuit including the magnet and part of the field magnet coil, a circuit-controller in the circuit, and a centrifugal governor attached to a rotating part of the machine for operating the circuit controller when the machine reaches a certain speed, substantially as described. 4th. A dynamo regulator, comprising adjustable

commutator brushes, an electro-magnetic device to adjust the same, a regulating circuit including a source of electricity and the electro magnetic device, and a speed governor carried by a rotating part of the machine to close the regulating circuit when a predetermined speed is reached, and actuate the electro-magnetic device to adjust the commutator brushes. 5th. A dynamo regulator comprising shifting commutator brushes, an electro-magnetic device to adjust the same, a normally open regulating circuit including a source of current, and the electro-magnetic device and a centrifugal circuit controller to close the circuit and actuate the electro-magnetic device to adjust the brushes. 6th. A dynamo current regulator comprising shifting commutator brushes, an electro-magnetic device to adjust the same, a regulating circuit including a portion of the field magnet and the electro-magnetic device, a circuit controller in the circuit, and a speed regulator carried by the armature shaft, and connected with the controller to close the circuit and thereby shift the commutators when a predetermined speed is attained. 7th. A dynamo regulator, comprising a movable brush holder, provided with stops to limit its movements, a spring secured to one end of the same, to yieldingly hold that end depressed, an extension upon the opposite end of the holder, an electro-magnet located below the extension which forms the armature of the magnet, a normally open regulating circuit including the magnet, and a centrifugal circuit controller to close the circuit and actuate the magnet to move the brush holder. 8th. In a regulator, the combination of an armature shaft extension, a circuit closer carried by the same, a centrifugal governor to cooperate the circuit closer collars on the extension connected with the closer brushes bearing upon the collars, and a regulating circuit including the closer collars and brushes, substantially as described.

No. 31,574. Machine for Pointing and Lapping Hoops. (*Machine à effiler et encocher les cercles.*)

Alexander F. Ward and Thomas T. Christie, Detroit, Mich., U.S. 11th June, 1889; 5 years.

Claim.—1st. The combination, with the frame having the guide-rail K, of the horizontally-running saw A, the carriage J sliding on said rail, a horizontally-running circular saw A' journaled on said carriage, and a clamp bolt a carried by said carriage and engaging said rail for binding said carriage to said rail, substantially as described. 2nd. The combination, with the frame, the rock-shaft G, the hooked feed-arms D, D', carried by said shaft, of the oscillating arms H having slots k, shaft T, rock-arm n on the shaft G, the cam u, plate m and the cranks i on the shaft T engaging the slot, and means for operating said cranks, substantially as described. 3rd. In a machine for pointing and lapping hoops, the combination of the hooked feed arms D, D', the rock-shaft G, rock-arm n on said rock-shaft and running on the plate m, lever W having the bearing plate m, shaft T, cam U, constructed to lift the lever W, crank i on the shaft T and operating the arms H, and oscillating arms H having the curved slots k and carrying the rock-shaft G, all arranged to operate substantially as described. 4th. The combination, with the pointing shears, of the lever e, the presser-foot Y swung therefrom in proximity to said shears, the lever W and the rod t connecting said presser foot and lever W, substantially as described. 5th. The feed arms D, D', arranged to bear upon the hoops by their weight, and provided with hooks d' and d'1, in combination with the springs v, substantially as described. 6th. In a machine for pointing and lapping hoops, the combination of the shears L and inclined bed plate with the pivoted presser foot o, the same being provided with the indentation q upon its lower edge, substantially as described. 7th. In a machine for pointing and lapping hoops, the combination of the hooked feed arms D, D', the grooved guides I, I', the presser feet o, Y, the inclined beds B, B' and the presser rolls C, C', the horizontally running circular lapping saws A, A', the pointing shears E and the trimming shears L, all arranged to operate substantially as described.

No. 31,575. Hatchet for Shingling.

(*Assette à bardeau.*)

Benjamin C. Pettingell, Vancouver, B.C., 12th June, 1889; 5 years.

Claim.—The placing and arrangement of the slots A and B, substantially as and for the purposes hereinbefore set forth.

No. 31,576. Method of Manufacturing Belting. (*Mode de fabrication des courroies.*)

James E. Emerson and Thomas Midgley, Beaver Falls, Penn., U.S. 12th June, 1889; 5 years.

Claim.—1st. The method of manufacturing belting, herein described, which consists in forming a metallic body by intersecting coiled sections of wire, and elongating the links by passing it between rolls, then coating the surface of the body with rubber, or its equivalent, and finally passing the whole between heated metallic bodies, forcing the rubber into the interstices of the body and forming compound or metallic and plastic surface. 2nd. The method of manufacturing belting herein described, which consists in forming a metallic body by intersecting coiled sections of wire, and elongating the links by passing it between rolls, then coating the surface of the body with rubber, or its equivalent, then passing the coated body between heated metallic bodies under pressure, forcing the rubber into the interstices of the body, then applying canvas or rubber cloth to the surfaces of the filled body, and again subjecting the whole to heat and pressure.

No. 31,577. Rheostat. (*Rhéostat.*)

John N. Gish, Jackson, Mich., U.S., 12th June, 1889; 5 years.

Claim.—1st. The combination, with two resistance coils and their connection, of a movable contact point and a guide on which the contact point can be moved along each coil, and from one coil to the

other along their connection without breaking contact, substantially as set forth. 2nd. The combination, with two resistance coils and their connection, of a frame provided with a continuous way opposite said coils and their connection, and a movable contact point arranged in said way and adapted to bear against said coils and their connection, substantially as set forth. 3rd. The combination, with several resistance coils having their adjacent ends connected by flat metallic bars, of a frame provided opposite said coils, and bars with a continuous slot or way and a movable contact point arranged in said slot or way, substantially as set forth. 4th. The combination, with a resistance coil, of a stationary frame provided with a slot or way opposite said coil, a sliding frame I arranged in said slot or way, a binding post J provided with a socket j arranged in said sliding frame, and a contact bolt K and spring k arranged in said socket, substantially as set forth. 5th. The combination, with a resistance coil, of a stationary frame provided with a slot or way opposite said coil, a sliding frame I arranged in said slot and provided with a sleeve i² having a slot i², a binding post J provided with a socket j arranged in the sleeve i² and having a projection j¹ entering the slot i², a contact bolt K provided with an anti-friction roller k¹, and having a projection l entering a groove l¹ in the socket j, and a spring k arranged in said socket behind the contact bolt, substantially as set forth.

No. 31,578. Steam Trap. (*Purge de tuyau de vapeur.*)

John Corell, Brooklyn, N.Y., U.S., 12th June, 1889; 5 years.

Claim.—1st. In a steam trap, a vacuum chamber constructed and arranged between the steam tube, and the apparatus to which the trap is applied, substantially as described. 2nd. The combination of the steam tube E, the cross plate F, H, the stuffing box and the three rods I, I', said rods being relatively arranged substantially as described. 3rd. In a steam trap, one or more gauges applied to its steam tube, as and for the purpose set forth. 4th. The combination of the tube E, the cross plate G and the three set screws g, g, g, as and for the purpose described. 5th. The combination of the steam tube E, cross plate F, the rods I, I', and the nuts f, f, as and for the purpose described. 6th. The combination of the tubular valve seat e, the valve stem and the valve adjustable upon said stem, as and for the purpose described. 7th. The binding stem P having an extension and thimble, in combination with the valve stem and the valve stem holder, as described. 8th. The combination of the cross-plates G, H and the arms L, L, I, I', and levers M, said arms being rounded at the ends thereof, as and for the purpose described. 9th. The tapered pins S, in combination with the arms L, I, I', and levers M, substantially as described. 10th. The combination of the tube E, the cross plates F, G, H, the ties I, I', the arms L, L, the rods I, I', the levers M, M and the holder N, substantially as described.

No. 31,579. Faucet. (*Robinet.*)

Elijah W. Scoville, Manlius, N.Y., U.S., 12th June, 1889; 5 years.

Claim.—1st. The combination of the barrel B, provided with the channels a, a, having their adjacent ends a¹, a¹ deflected laterally to the exterior of the barrel, the convex seat b across the ends of said channels, the concave valve c provided with the port c¹ and the lever l pivoted to the barrel between the channels and carrying the valve, substantially as described and shown. 2nd. The combination of the barrel B, provided with the channels a, a, having their adjacent ends a¹, a¹ deflected laterally to the exterior of the barrel, the convex seat b across the ends of said channels, the concave valve c provided with the port c¹, the lever l pivoted to the barrel between the channels and carrying the valve, and the spring s¹ arranged to push the lever into a position to normally hold the valve in its closed position, substantially as described and shown.

No. 31,580. Process and Apparatus for Producing Shots or Spheres of Fragments or Pieces of Iron, Steel and Metal. (*Procédé et appareil de production des projectiles ou sphères avec des fragments ou morceaux de fer, d'acier et de métal.*)

Ludwig Keyling, Berlin, Germany, 12th June, 1889; 5 years.

Claim.—1st. A process for the manufacture of shot and metal spheres of all descriptions, consisting in placing pieces of metal of approximately or absolutely equal or uniform size between scoops, and beaters inclined in opposite directions, and rotating at different speeds whereby the pieces are alternately elevated by the scoops and thrown against the beaters, and then thrown back by the action of the beaters against the scoops, so that the angles or corners are gradually reduced until the pieces obtain a perfectly spherical form, substantially as hereinbefore described. 2nd. For the manufacture of shot and metal spheres of all descriptions from pieces of metal of approximately or absolutely equal or uniform dimensions, as hereinbefore described and claimed, a machine or apparatus constructed with drums or cylinders a and f, arranged one within the other, and rotating at different speeds in opposite directions, the outer drum a being provided with inclined arms or scoops e, and the inner drum f being provided with inclined arms or beaters e', a suitable space for the alternate falling and projection of, or movement of the pieces of metal being provided between the said drums or cylinders, all substantially as and for the purpose hereinbefore described with reference to the accompanying drawings.

No. 31,581. Sleeper. (*Traverse de chemin de fer.*)

Henry Hipkins, Birmingham, Eng., 12th June, 1889; 5 years.

Claim.—The improvements in sleepers made from one piece of metal, and having the jaws with their stiffening ribs or ribs cut out and raised therefrom, so as to leave a centre stiffening cross strip, substantially as and for the purpose herein set forth and shown upon the drawings.

No. 31,582. Car Coupling Link.*(Chaînon d'attelage de chars.)*

John Ptolemy, Winnipeg, Man., U.S., 12th June, 1889; 5 years.

Claim.—A car coupling link of the peculiar form shown in the drawing, having the slots 4, 4, increased thickness in the centre, and curved to correspond with the bell mouth of the draw-head, substantially as and for the purpose above set forth.

No. 31,583. Fanning Mill or Machine for*(Tarare-cribleur ou machine à nettoyer les grains.)*

Henry Bolton, Elizabethtown, Ont., 12th June, 1889; 5 years.

Claim.—1st. In a fanning mill, return leaf A, substantially as and for the purpose hereinbefore set forth. 2nd. In a fanning mill, wheel C, cogged with its periphery and on its inside, substantially as and for the purpose hereinbefore set forth.

No. 31,584. Lock Stitch for Securing Together the Soles and Uppers of Boots and Shoes.*(Point d'arrêt pour coudre les semelles aux empeignes des chaussures.)*

William Carey, Montréal, Qué., 12th June, 1889; 5 years.

Claim.—A lock stitch for uniting two or more thicknesses of substance formed of a continuous thread, alternately looped over the surface of one thickness of fabric, and into the substance of the other thickness, and lengths of wire or other stiff material driven into the latter substance and through the loops, all substantially as herein set forth.

No. 31,585. Bridge. (Pont.)

William Harman, Oak Park, Ill., U.S., 12th June, 1889; 5 years.

Claim.—1st. A draw-bridge composed of halves or two parts, each part consisting of sections, as A, B, hinged together, substantially as and for the purpose specified. 2nd. The combination of the sections A, B, hinged together, standards C, rods E and ropes F for raising the sections B to open the bridge, substantially as specified. 3rd. The combination of the sections A, B, hinged together, standards C, rods E and ropes G for lowering the sections B to close the bridge, substantially as specified. 4th. The combination of the sections A, B, hinged together, standards C, rods E, ropes F, G and winding shaft or drum H for raising and lowering the sections B to open and close the bridge, substantially as specified. 5th. In a draw-bridge, the hinged floor-sections A, B, supported and arranged to hold together, when lifting power is applied to the abutment section, substantially as described.

No. 31,586. Feed Water Heater and Purifier for Steam Boilers.*(Réchauffeur et épurateur de l'eau d'alimentation des chaudières à vapeur.)*

Julius T. Lee, Mattoon, Ill., U.S., 12th June, 1889; 5 years.

Claim.—1st. The combination of the water-jacketed diaphragm I connected to the feed pipes K, K, and the upper discharge pipes O, O, substantially as and for the purpose hereinbefore set forth. 2nd. The combination of the water-jacketed diaphragm I, connected to the feed pipes K, K, and upper discharge pipes O, O, and the lower discharge pipes J, J, J, substantially as and for the purposes hereinbefore set forth. 3rd. The combination of the water-jacketed diaphragm I connected to the feed pipes K, K, and the upper discharge pipes O, O, and the lower discharge pipes J, J, J, and the mud-drum J₁, substantially as and for the purpose hereinbefore set forth. 4th. The combination of the water-jacketed diaphragm I, connected to the feed pipes K, K, and the upper discharge pipes O, O, and the lower discharge pipes J, J, J, and the mud-drum J₁ and the discharge valve J₂, substantially as and for the purpose hereinbefore set forth. 5th. The combination of the water-jacketed diaphragm I connected to the feed pipes K, K, and the upper discharge pipes O, O and the lower discharge pipes J, J, J, and the mud-drum J₁ and the discharge valve J, and the cab links and levers J₃, substantially as and for the purpose hereinbefore set forth. 6th. The combination of the water-jacketed exhaust steam stand-pipe G, connected to the feed pipes K, K, and the upper discharge pipes O, O, substantially as and for the purpose hereinbefore set forth. 7th. The combination of the water-jacketed exhaust steam stand pipe G, connected to the feed pipes K, K, and the upper discharge pipes O, O, and the bells P, P, substantially as and for the purpose hereinbefore set forth. 8th. The combination of the water-jacketed exhaust steam stand pipes G, connected to the feed pipes K, K, and the upper discharge pipes O, O, and the bells P, P, and the lower discharge pipe N₁, substantially as and for the purpose hereinbefore set forth. 9th. The combination of the water-jacketed exhaust steam stand pipe G, connected to the feed pipes K, K, and the upper discharge pipes O, O, and the bells P, P, and the lower discharge pipe N₁ and the pipe L₃ and the four way connection L₂, and the stop-cock L₇ and the wash-out pipe L₄ and the cap L₅, substantially as and for the purpose hereinbefore set forth. 10th. The combination of the water-jacketed exhaust steam stand pipe G, connected to the feed pipes K, K and the upper discharge pipes O, O, and the bells P, P, and the lower discharge pipe N₁, and the pipe L₃, and the four way connection L₂, and the stop-cock L₇, and the wash-out pipe L₄, and the cap L₅ and the cinder blower nozzle L₆, substantially as and for the purpose hereinbefore set forth. 11th. The combination of the feed pipes K, K, with the water-jacketed diaphragm I and with the upper outlet pipes L, L, and with the four way connection L₂, and with the pipe L₃ and with the water-jacketed exhaust steam stand-pipe G, and with the pipes O, O, and with the bells P, P, substantially as and for the purpose hereinbefore set forth.

No. 31,587. Plough Handles.*(Mancherons de charrue.)*

Standhope I. Allen, Crossville, Ala., U.S., 12th June, 1889; 5 years.

Claim.—1st. In a plough, the handles C adjustably secured to the plough-beam, and having the adjustable brace D, constructed and arranged substantially as shown and described. 2nd. In a plough, the clamping plates B pivotally attached to the plough beam, and constructed and arranged substantially as herein shown and described.

No. 31,588. Apparatus for use in the Issue of Tickets and for Recording the Number of Tickets Issued.*(Appareil pour servir à la vente des billets et enrégistrer le nombre de billets vendus.)*

Robert J. H. Rastrick, Southsea, Eng., 12th June, 1889; 5 years.

Claim.—1st. The ticket-issuing and registering apparatus, substantially as herein described, wherein is arranged a counter D formed of a number of movable type wheels mounted upon a frame, to which a rocking motion is imparted by means of an eccentric *e* upon the spindle *d* during each revolution, or part of a revolution of the handle or knob C, as herein set forth and shown in the accompanying drawings. 2nd. The combination, with the type wheels D, of a shield so disposed as to allow only the types next to be used to be charged with ink from an inking roller, said shield during its rocking motion pressing against and passing over the surface of the inking roller, thereby ensuring an even distribution of the ink upon the types, substantially as set forth. 3rd. In combination with a number of type wheels D forming a counter, of a supplementary type wheel, the types upon which are letters, figures or other distinguishing symbols, substantially as and for the purposes described. 4th. The combination, with the supplementary type wheel, of a dial having figures, letters or other symbols corresponding with the types upon said supplementary type wheel, and an index pointer, said type wheel and index pointer being actuated by a handle, key, or equivalent G, substantially as set forth and shown. 5th. In a ticket issuing and registering apparatus, the employment of a roller upon which are formed types representing the unit value of a ticket, said value being impressed or imprinted upon the band of paper during its passage through the apparatus, substantially as set forth. 6th. The combination, with a continuous strip, band or ribbon of paper, of a pivoted flat guiding tube or channel, so arranged that at a certain point of a revolution, or partial revolution, of the handle C, said flat tube or channel is caused to approach the type wheels against the tension of a spring, thereby allowing the paper to be pressed against the types, substantially as set forth. 7th. In combination with the pivoted flat tube or channel herein described, the employment of a cam mounted upon the spindle *d*, and having a recess or slot formed therein, substantially as and for the purposes described. 8th. In a ticket issuing and registering apparatus, the employment of a continuous blank strip, band or ribbon of paper, in combination with means for impressing or imprinting thereon at each revolution, or partial revolution, of the handle C, a consecutive number distinctive figure, letter or symbol to represent a given section and the pecuniary value of each ticket previous to the issue of said ticket from the machine, substantially as described.

No. 31,589. Price and Inventory Check.*(Etiquette de marchandises.)*

Caleb S. Dewitt, Lockport, Ill., U.S., 12th June, 1889; 5 years.

Claim.—1st. A set or series of checks or tickets, having the letter and figures marked thereon in the manner substantially as set forth and numbered in consecutive order to represent the quantity of goods or articles in the box or package to which they attach, substantially as and for the purpose specified. 2nd. A set or series of checks or tickets, having consecutive inventory numbers, for constantly showing the quantity of goods sold from the package to which they attach, and also to represent at any time the quantity of goods remaining unsold in the package to which said checks or tickets are attached, substantially as set forth.

No. 31,590. Manufacture of Lime.*(Fabrication de la chaux.)*

Granville E. Carleton, Rockport, Me., U.S., 12th June, 1889; 5 years.

Claim.—1st. The method of calcining rock in the manufacture of lime, consisting of first, introducing an air blast underneath the fuel in the kiln to increase the draft, and, second, introducing a spray of steam or water above the bed of coal, substantially as and for the purpose described. 2nd. The herein described mode of calcining rock in a kiln, having a barrel to contain the rock, and arches leading thereto, consisting in applying the air blast below the grate to create a draft, and in applying steam or a spray of water within the arch above the fuel to regulate the heat, as and for the purpose set forth. 3rd. In combination with the barrel of the kiln and with the arch or fire box thereof, having a grate, and with the ash pit thereof, an air pipe communicating with the ash pit beneath the grate with air forcing mechanism therefor, and a steam or water pipe arranged to discharge steam or water within the arch or fire box and over the surface of the fuel, substantially as and for the purpose set forth.

No. 31,591. Wheel Tire. (Bandage de roue)

William B. Morris, Victoria, B.C., 12th June, 1889; 5 years.

Claim.—The combination of a tire with a section, as shown in figure 4, with ends B, C, rivet I and the casting G, and with rivets H, H, substantially as described.

No. 31,592. Vaporizing Apparatus.*(Appareil évaporatoire.)*

Herbert F. Williams, Brooklyn, N.Y., U.S., 12th June, 1889; 5 years.

Claim.—1st. A closed vaporizing chamber adapted to contain a liquid or other substance to be vaporized, a tube entering said chamber and terminating above said substance and arranged to deliver an air current upon said substance, and an exit opening in said chamber for the vapor produced therein. 2nd. A closed vaporizing chamber adapted to contain a liquid or other substance to be vaporized, means for heating or cooling said chamber, a tube entering said chamber and terminating above said substance, and an exit opening in said chamber for the vapor produced therein. 3rd. A closed vaporizing chamber adapted to contain a liquid or other substance to be vaporized, a tube entering said chamber and terminating above said substance, and arranged to deliver an air current upon said substance, a chamber communicating with said tube and means for heating or cooling the air passing from said tube through said chamber, and an exit opening in said vaporizing chamber for the vapour produced therein. 4th. The vaporizing apparatus herein set forth, containing inlet tube A, C, chamber D and means of heating the same, valves H, I, J, the vaporizing chamber K and a means of heating the same, and exit tube N, substantially as described. 5th. A hood or cone of flexible material for covering the mouth and nose of the patient, having on its edge a flexible non-elastic band, substantially as described.

No. 31,593. Trimming Attachment for Sewing Machines.*(Appareil servant à tailler pour machines à coudre.)*

John W. Dewees, Philadelphia, Penn., U.S., 12th June, 1889; 5 years.

Claim.—1st. The combination, with the feeding and stitch-forming mechanism of a sewing machine, and a cloth plate having an opened slot parallel with the line of feed, of trimming devices arranged transversely to said feed line and in a horizontal plane, said trimming devices including a jaw or cutter which moves horizontally and transversely to the feed line, and means for moving said jaw or cutter, substantially as shown and described. 2nd. The combination, with the cloth plate A of a sewing machine having intersecting slots D and D', of a stationary shoe or jaw F, and a movable cutter or jaw G located in the slot D', substantially as shown and described. 3rd. The combination, with cloth plate A, having intersecting slots D, D', of fixed shoe or jaw F and movable jaw G located in slot D', lever H, connecting rod K and eccentric C connecting the jaw G with the operating shaft, substantially as shown and described. 4th. In combination with a stitch-forming mechanism of a sewing machine, a trimming attachment, comprising a stationary jaw having a horizontal cutting edge located in a horizontal plane, and a moving jaw or chisel also having a horizontal cutting edge and located in a horizontal plane, said moving jaw being adapted and designed to be moved across the stationary jaw, the edges of both jaws passing, whereby a horizontal shear cut is obtained, substantially as shown and described. 5th. In combination with the stitch-forming mechanism of a sewing machine, a vibrating lever K adapted and designed to be moved in a horizontal plane, a cutting tool or jaw carried thereon, having a horizontal cutting edge, and a stationary jaw P having a horizontal cutting edge *pt*, said jaws being located in a horizontal plane, and the moving jaw being adapted and designed to move horizontally past the edge of the stationary jaw, substantially as shown and described. 6th. In combination with the stitch-forming mechanism and cloth plate of a sewing machine, a slide M, a cutting tool P mounted thereon and having a horizontal cutting edge *pt*, a moving jaw L₁ having a horizontal cutting edge and located in a horizontal plane, said jaws being adapted and designed to effect a horizontal shear cut, and means for vibrating said moving jaw, substantially as shown and described. 7th. The combination, with the cloth plate of a sewing machine and a movable trimming jaw L₁, of a slide M carrying a cutter or trimmer jaw P and a pivoted dog-bar N₁, substantially as shown and described. 8th. The combination, with the stitch-forming mechanism of a sewing machine, of a cloth plate C₁ having a depression or groove plate C₂ and two horizontally disposed trimming jaws, one of which is stationary and the other is provided with means whereby it is moved horizontally, the edges of said jaws being over said groove and adapted to trim the depending edge of the fabric in the latter, substantially as shown and described. 9th. The combination, with the cloth of a sewing machine and a movable trimming jaw L₁, of a slide M₁ having a trimming jaw P and an adjustable guide and gauge R on said slide, substantially as shown and described. 10th. The combination, with the stitch-forming mechanism, feed-bar and presser foot of a sewing machine, of trimming devices located in front of said foot and presser bar, said trimming devices being in a horizontal plane, and having horizontal cutting edges, and having means for imparting a horizontal motion transverse to the line of feed thereto, whereby fabric to be trimmed and hemmed has its superfluous edge or part outside the line of stitch removed by a horizontal cut in advance of the formation of the stitch, substantially as shown and described. 11th. The combination, with the stitch-forming mechanism and the trimming jaws of a sewing machine, of a cloth plate having a slot for the passage of the depending fabric and a depending shield or flange to protect the hook of the machine from coming into contact with the fabric, substantially as described.

No. 31,594. Machine for Stretching Carpets.*(Machine à tendre les tapis.)*

Thomas Sturdy, Goderich, Ont., 12th June, 1889; 5 years.

Claim.—The combination of the fork E, B, D, the teeth plate C and the teeth frame A, as shown in Fig. 1, substantially as and for the purpose hereinbefore set forth.

No. 31,595. Freight Car Door.*(Porte de char à marchandises.)*

John Montgomery, Jarvis, Ont., 12th June, 1889; 5 years.

Claim.—The combination of the different attachments hereinbefore set forth, by means of which the said car door can be opened to the inside or outside, or forced upwards with perfect ease and without injury to the car or door.

No. 31,596. Combined Curb and Gutter.*(Margelle et ruisseau combinés.)*

Augustus G. Parkhurst, Minneapolis, Minn., U. S., 12th June, 1889; 5 years.

Claim.—1st. A combined street curb and gutter, of substantially the described form, having its main body composed of cement in substantially the proportions, one part sand or broken stone three parts, and having its outer face or exposed surface made in substantially the proportions of cement two parts and sand three parts. 2nd. A combined curb or gutter of artificial stone, having its facing or exposed surface of harder and more durable material than its mass, and fitted with the rear projections 11 and 13, by means of which it is anchored and held in position by the surrounding and superincumbent earth. 3rd. In combination, the street pavement 1, sidewalk 3, the combined curb and gutter 7, having the rear projections 11 and 13, and a facing or outer surface 17 composed of harder and more durable material than the mass of the structure.

No. 31,597. Gear Wheel. (Roue d'engrenage.)

Martin T. Graf, Buffalo, N.Y., U.S., 13th June, 1889; 5 years.

Claim.—1st. A gear wheel, having two sets of teeth, one adjustable upon the other and provided with an open space between the two sets of teeth at their peripheries. 2nd. A gear wheel, having two sets of teeth, one integral with the hub, and the other adjustable thereon and provided with an open space between the two sets of teeth at their peripheries. 3rd. A gear wheel, having two sets of teeth, each having a sand chamber, one set adjustable upon the other, and provided with an open space between the two sets of teeth at their peripheries. 4th. A gear wheel, having two sets of teeth, each having a sand chamber, one set integral with the hub and the other adjustable thereon, and provided with an open space between the two sets of teeth at their peripheries. 5th. In a gear wheel, the combination, with the sleeve a, of the hub c secured thereto on each side by the leathers d and screw bolts and nuts, with a suitable non-vibrating packing material interposed between the contacting surfaces.

No. 31,598. Fluid Meter. (Compteur à fluide.)

Eliza B. Norfolk (executrix of the last will and testament of John R. Norfolk), Boston, Mass., U.S., 15th June, 1889; 5 years.

Claim.—1st. In a fluid meter, the combination, with the cylinders A, A, reciprocating piston a and the valve-chamber B, of the main valve L operated by the direct pressure of the fluid thereon, the supplemental valve S actuated by the piston and the latches P, P, operated by the said supplemental valve, and adapted to control the movement of the main valve, substantially as and for the purpose set forth. 2nd. In a fluid meter, the combination, with the main valve L operated by the direct pressure of the fluid, and the pivoted latches P, P, adapted to control the movement of the main valve, substantially as described, of the supplemental valve S, provided with inclines S₂, S₂ for operating the latches when the supplemental valve is moved by the piston, substantially as described. 3rd. In a fluid meter, the combination, with the cylinders A, A, reciprocating piston a and the valve chamber B, of the main valve L having the ports L₂, L₂, extending entirely through it, the valve-plate E having the ports H, H and outlet port G, the valve case I with its ports J, K, the cover O with its ports J₂, K₂, and openings or water-ways R, R, the supplemental valve S with its recesses 25 and inclines S₂, S₂, and the pivoted latches P, P, having lips or projections Q and spurs or projections Q₂, the latter adapted to pass through the openings R into the ports L₂ of the main valve, whereby the movement of the latter is controlled, all co-operating substantially in the manner and for the purpose set forth. 4th. In a fluid meter, the combination, with the main valve L, its casing I and the cover O with their ports and water-ways, substantially as described, of the latches P pivoted to the cover O, and having lips or projections Q and spurs or projections Q₂, and the supplemental valve S adapted when operated by the piston to alternately raise the latches to release the main valve, whereby the latter is prevented from completing its movement until the piston has been moved to its full extent, and the supplemental valve has admitted the water under full pressure to act upon the main valve, substantially as and for the purpose set forth. 5th. In a fluid meter, the combination, with the spindle T and ratchet wheel U secured thereto, of the reciprocating finger bar X, provided with a finger Y pivoted thereto and adapted to engage with the ratchet wheel, and the fixed cam W on the bar W for throwing the finger into engagement with the ratchet wheel, all constructed to operate substantially in the manner and for the purpose set forth.

No. 31,599. Motor Engine Operated by the Combustion of Hydro-Carbon Vapour. (Machine motrice à vapeur d'hydrocarbures.)

William D. Priestman and Samuel Priestman, Hull, Eng., 17th June, 1889; 5 years.

Claim.—1st. The improved construction of valve mechanism for controlling the supply of liquid hydro-carbon and air to the vaporiser or mixing apparatus, substantially as herein described and capable of being operated by the governor or by hand. 2nd. The im-

proved construction of valve mechanism, arranged or operating substantially as herein described and adapted for controlling the supplementary air supply to the vapour chamber in addition to performing the functions referred to in the preceding claiming clause. 3rd. The improved construction of valve mechanism, arranged substantially as herein described, and operating first to close the air and liquid hydro-carbon outlets from the petroleum reservoir, secondly, to admit air and liquid hydro-carbon to the heating lamp applied to the vapour chamber, and, thirdly, to close the communication last referred to and to admit air and liquid hydro-carbon to the vapouriser or mixing apparatus employed in the preparation of the working charge. 4th. The improved construction of vapouriser for mixing petroleum or other liquid hydro-carbon with air or other gas capable of supporting combustion, and comprising two concentric tubes the extremity of the outer one being so formed as to direct the fluid conveyed thereby at right angles, or at an obtuse angle against or across the stream of fluid escaping from the inner tube. 5th. In combination with the petroleum reservoir *a*, the improved construction of vapour-generating and burning lamp *h*, substantially as herein described, and comprising means *e* for straining the respective fluids, a nozzle *m*, *m'* for mixing the same, and an enclosing tube *h'* serving to heat the vapour produced. 6th. In combination with the vapour chamber *l*, to which a supplementary air supply is admitted, the annular passage *e* and perforated baffle plate *e'* surrounding the vapourizing nozzle *c* and serving to equally distribute the additional air amongst the vapour, substantially as herein described.

No. 31,600. Means for Producing Sparkling Effect, Ornamental and Other, for Advertising and General Display Purposes. (*Moyens de produire des effets brillants, d'ornement et autre pour des fins générales d'annonce et autres.*)

Edward Smith and Frederick Smith, London, Eng., 17th June, 1889; 5 years.

Claim.—1st. The combination, with material formed or provided with perforations, of a reflective surface disposed to direct light through the said perforations, substantially as described. 2nd. The combination, with material formed or provided with perforations, of a colored reflective surface disposed to direct light through the said perforations, substantially as described. 3rd. The combination, with material formed or provided with perforations, of a broken or crisoleoed reflective surface disposed to direct light through the said perforations, substantially as described. 4th. The combination, with material formed or provided with perforations, of a broken or crisoleoed colored reflective surface, disposed to direct light through the said perforations, substantially as described. 5th. The combination, with material formed or provided with perforations representing letters or figures, of a reflective surface disposed to direct light through the said perforations, substantially as described. 6th. The combination, with material formed or provided with perforations representing letters or figures, of a colored reflective surface disposed to direct light through the said perforations, substantially as described. 7th. The combination, with material formed or provided with perforations representing letters or figures, of a broken or crisoleoed reflective surface disposed to direct light through the said perforations, substantially as described. 8th. The combination, with material formed or provided with perforations representing letters or figures, of a broken or crisoleoed colored reflective surface disposed to direct light through the said perforations, substantially as described. 9th. The combination, with material bearing a transparent design on an opaque or translucent ground, of a reflective surface disposed to direct light through the said transparent design, substantially as described. 10th. The combination, with material bearing a transparent design on an opaque or translucent ground, of a colored reflective surface disposed to direct light through the said transparent design, substantially as described. 11th. The combination, with material bearing a transparent design on an opaque or translucent ground, of a broken or crisoleoed reflective surface disposed to direct light through the said transparent design, substantially as described. 12th. The combination, with material bearing a transparent design on an opaque or translucent ground, of a broken or crisoleoed colored reflective surface disposed to direct light through the said transparent design, substantially as described. 13th. The combination, with material formed or provided with perforations, of a colored surface and a reflective surface, the latter so disposed as to reflect the colors through the said perforations, substantially as described. 14th. The combination, with material formed or provided with perforations, of a colored surface and a broken or crisoleoed reflective surface, the latter so disposed as to reflect the colors through the said perforations, substantially as described. 15th. The combination, with material bearing a transparent design on an opaque or translucent surface, of a colored surface and a reflective surface, the latter so disposed as to reflect the colors through the said transparent design, substantially as described. 16th. The combination, with material bearing a transparent design on an opaque or translucent surface, of a colored surface and a broken or crisoleoed reflective surface, the latter so disposed as to reflect the colors through the said transparent design, substantially as described. 17th. The combination, with material formed or provided with perforations of a transparent backing or facing, and a reflective surface disposed to direct light through the said perforations, substantially as described. 18th. The combination, with material formed or provided with perforations, of a transparent backing or facing, and a colored reflective surface disposed to direct light through the said perforations, substantially as described. 19th. The combination, with material formed or provided with perforations, of a transparent backing or facing, and a reflective surface and a broken or crisoleoed reflective surface disposed to direct light through the said perforations, substantially as described. 20th. The combination, with material formed or provided with perforations, of a transparent backing or facing and a reflective surface, and a broken or crisoleoed colored re-

fective surface disposed to direct light through the said perforations, substantially as described. 21st. The combination of the perforated material 1, the reflective surface 4 and the transparent material 3, substantially as described with reference to the drawings.

No. 31,601. Churn. (*Baratte.*)

Silas Ward, Ridgetown, Ont., 17th June, 1889; 5 years.

Claim.—1st. The combination of the cog wheels C and J, with the shafts F and T and the crank H, in such a manner as to give a revolving motion to the platform S, the tub K, the lid L and the counter dasher M, substantially as and for the purpose hereinbefore set forth. 2nd. The combination of the stationary dasher, composed of the spindle N, the blade O and the cross-bars P and R, and the counter dasher M, substantially as and for the purpose hereinbefore set forth.

No. 31,602. Potato Digger. (*Arrache-patates.*)

Artemas Rigby, Upper Stillwater, Me., U. S., 17th June, 1889; 5 years.

Claim.—1st. A potato digger having side beams F, provided with swivel castor-wheels K, K, as shown and described. 2nd. In a potato digger, the colter L arranged in front of that of the lifting plough to open the top of furrow and remove the obstructions. 3rd. In a potato digger, the small ploughs I, I, arranged to run several inches less in depth than the lifting plough, and remove a large portion of the earth on each side of the potatoes, as set forth.

No. 31,603. Telephony and Telegraphy.

(*Téléphonie et télégraphie.*)

Charles L. Davies, London, Eng., 17th June, 1889; 5 years.

Claim.—1st. The combination of two telegraphic line wires and a bobbin on which two or more insulated wires are together wound, such line wires being connected each with one extremity of one of the wires on the bobbin, the other ends of the bobbin wires being unconnected, whereby without establishing metallic continuity between the line-wires, telephonic or harmonic impulses are enabled freely to pass, substantially as described. 2nd. The combination of the bobbin on which two or more insulated wires are together wound, the line wires connected each with one extremity of one of the wires of the bobbin, the other ends of the bobbin wires being unconnected, and sound transmitting and receiving instruments connected in open circuit with the line wires, whereby telephonic or harmonic impulses are enabled freely to pass while disturbing currents are arrested or prevented, substantially as described.

No. 31,604. Hydraulic Engine.

(*Machine hydraulique.*)

George Guest, Toronto, Ont., 17th June, 1889; 5 years.

Claim.—1st. In a hydraulic engine operated by reciprocating valves, the combination of buffers F placed at the ends of the valve-chambers and made of rubber or other compressible material, substantially as and for the purpose specified. 2nd. The combination, with the sectional main valve E, of pins *d* arranged to connect the said valves together, substantially as and for the purpose specified. 3rd. The sleeve H connected to the pumping lever I, and having a projection G extending from it, in combination with the forked end of the rod A provided with set-screws J, substantially as and for the purpose specified.

No. 31,605. Railway Switch.

(*Aiguille de chemin de fer.*)

Simon Cameron, Portage La Prairie, Man., 17th June, 1889; 5 years.

Claim.—Pivoted rail G, having bar F secured to it, rod E, connection *d*, long rod D, connection *b* and rod B, all combined substantially as and for the purpose hereinbefore set forth.

No. 31,606. Nut Lock. (*Ecrou de sûreté.*)

L. Arthur Dion, Québec, Qué., 17th June, 1889; 5 years.

Résumé.—La combinaison de la rondelle (washer) H, avec la cheville A et la rainure B de l'érou C, des coupes F, E, et des langués D, D, tel que ci-dessus décrite et pour les fins indiquées.

No. 31,607. Vending Apparatus.

(*Appareil de vente.*)

The Automatic Vending Box Company (assignee of James M. O'Kelly), New York, N. Y., U. S., 18th June, 1889; 5 years.

Claim.—1st. In a vending apparatus, the combination, with a casing having a coin slot, of an oscillating coin receptacle and an escapement connected therewith, a delivery plate and a merchandise delivery device engaged by said escapement, substantially as set forth. 2nd. In a vending apparatus, the combination of a coin receptacle, an escapement attached to and operated from said receptacle, a shaft provided with notched disks, stops on said shaft adapted to be engaged by said escapement, and a cigarette or merchandise way above the shaft carrying the notched disks, substantially as set forth. 3rd. In a vending apparatus, the combination, with a coin receptacle, of an escapement attached to and operated by said receptacle, a merchandise delivery mechanism adapted to be operated by the weight of the article and engaged by the escapement, and a cigarette or merchandise way above the merchandise delivery mechanism, substantially as set forth. 4th. The combination, with a box or casing, of a partition forming a cigarette or merchandise way, notched wheels at the lower end of the same mounted on a

shaft, which wheels serve for receiving and supporting a cigarette or other article, a coin operated escapement for releasing said notched wheels, and a pawl engaging one of said notched wheels, substantially as set forth. 5th. In a vending apparatus, the combination, with a merchandise delivery mechanism, of an escapement controlling said delivery mechanism, a rock shaft carrying said escapement, and a coin receptacle on said rock shaft, which coin receptacle is formed of two disks and curved partitions forming pockets between the disks, substantially as set forth. 6th. In a vending apparatus, the combination, with a merchandise delivery mechanism, of an escapement controlling said delivery mechanism, a rock shaft carrying said escapement, and a coin receptacle on said rock shaft, which coin receptacle is formed of two disks and curved partitions forming pockets between the disks and stops on one of said disks for limiting the oscillatory movement of the receptacle, substantially as set forth. 7th. The combination, with a casing, of an arm projecting parallel with the front of the casing from the inner surface of one side wall, and of a removable receptacle for the articles to be sold, which receptacle fits in between the front of the casing and said arm, and is provided with a projection on its rear wall, said projection resting on the above mentioned arm, substantially as set forth. 8th. The combination, with a box or casing, of a coin chute, a bar projecting into the upper end of said coin chute, a lever actuated by said bar and carrying a curved plate, the convex surface of which faces the front of the casing, and on which convex surface some of the cigarettes or like articles can rest, and which curved plate is swung upward every time a coin is inserted in the coin chute, substantially as set forth. 9th. The combination, with a box or casing, of a coin chute, a bar projecting into the upper end of said coin chute, a lever actuated by said bar, a curved plate on said lever, the convex surface of which plate faces the front of the casing, and a plate or partition extending downward and forming a cigarette way with the front of the casing, substantially as set forth. 10th. The combination, with a box or casing, of a coin chute, a bar projecting through the upper end of the same, a lever actuated by the lower end of said bar, a curved plate secured to said lever, an article adjusting plate pivoted to said curved plate and having prongs forming a pocket, which prongs project through slots in the curved plate, an arm on said pivoted article adjusting plate, and a fixed arm against which the arm on the pivoted article adjusting plate abuts, substantially as set forth. 11th. The combination, with a box or casing, of a coin chute, a bar projecting into the upper end of the same, a lever actuated by the lower end of said bar, a curved plate on said lever and an article adjusting plate pivoted on said plate, substantially as set forth.

No. 31,608. Suspension File Box.

(Case à papier à suspension.)

The Office Specialty Manufacturing Company, Toronto, Ont. (assignee of Major R. Jewell, Rochester, N.Y., U.S.), 18th June, 1889; 5 years.

Claim.—1st. The combination of the case or receptacle, the two slotted sliding bars provided with upturned hooked ends, screws passing through the slots in the bars and guiding and securing them to the bottom of the case, and the file-box provided with studs or trunnions on its edges to engage the said hooked ends of the slides, the file being recessed at its edges to admit the slides between it and the walls of the receptacle, as described. 2nd. In combination with the cabinet or receptacle, the sliding plates with upturned hooked ends, screws passing through the slots and guiding and securing the plates on the bottom of the receptacle, and the file box arranged to slide upon and receive support from the bottom of the receptacle and provided with studs or trunnions to engage the said hooked ends of the slides, as described. 3rd. In combination, with the receptacle provided with slides, substantially as described, the file box having the front board adapted to close the receptacle, and the base-board adapted at its rear end to bear against the side walls of the receptacle, reduced in width at its forward end to pass the slides and provided with studs or journals to engage said slides. 4th. In combination with the receptacle and the sliding plates therein, substantially as described, the file box having its under edges rabbeted to overside the slides, and provided midway of its length or thereabout with the lateral studs or journals to engage the slides.

No. 31,609. Safety Oil Burner.

(Foyer à huile de sûreté.)

Henry Schreiner and George W. Wright, Philadelphia, Penn., U.S., 18th June, 1889; 5 years.

Claim.—1st. In a stove, the combination of a burner trough having an elevated back, bridges placed therein, a foraminous plate and burner pipe supported on the bridges above the foraminous plates, and an impertorate plate T resting upon the front of the grate at its lower end and against the foraminous plate at the top, as set forth. 2nd. In a stove, the combination of a burner trough having ears resting in the walls of the stove, bridges in said trough, a foraminous plate supported on the trough and bridges, and a burner pipe supported on the bridges above the foraminous plate, as set forth.

No. 31,610. Machine for Multiplying Power.

(Machine à multiplier la puissance.)

John W. Scott, Listowel (assignee of David W. Carter, Palmerston), Ont., 18th June, 1889; 5 years.

Claim.—The spur-wheel C connected to a driving power and journalled on the spindle D, projecting from one end of the T-head E, which is fixed to the shaft F, in combination with the pinion G geared to the spur-wheel C, and fixed to the spur-wheel I which gears with the stationary internally-gearred wheel J, and is journalled on the spindle D which projects from the T-head E at the end opposite to that from which the spindle D projects, substantially as and for the purpose specified.

No. 31,611. Chain Fastener. (Accroche-chaîne.)

The Oneida Community, Community (assignee of Harry E. Kelly, Niagara Falls), N.Y., U.S., 18th June, 1889; 5 years.

Claim.—1st. A chain fastener, consisting of a body plate, a bar pivoted to the body-plate, a stop arranged to arrest the movement of the aforesaid bar in one direction, and a coil spring holding the bar normally resting on the stop, as set forth. 2nd. The improved chain fastener, consisting of a body plate, a bar pivoted to the body plate and provided with a chamber at its pivot, a stop in position to arrest the movement of the aforesaid bar in one direction, and a coil spring seated in the aforesaid chamber and holding the bar normally resting on the stop, as set forth. 3rd. The combination of the body-plate A, formed with the case A', the bar B pivoted in said case, a stop arranged to arrest the swinging of the aforesaid bar in one direction, and a coil spring enclosed in the aforesaid case and holding the bar normally resting on the stop, substantially as described and shown. 4th. The combination of the body plate A, formed with the case A', the disk d confined in the said case and provided with the projection e, the bar B formed with the eye b and pivoted thereby on the aforesaid disk, and provided with the elongated notch f for the reception of the projection e, and the coil-spring h seated in the eye b and connected at opposite ends respectively to the bar B and disk d, substantially as described and shown.

No. 31,612. Railway Brake Shoe.

(Sabot de frein de chemin de fer.)

Richard F. Whalen, Charles W. Case, Arthur O. Gardner, Erwin C. Case and William W. Driggs, Hannibal, Mo., U.S., 18th June, 1889; 5 years.

Claim.—1st. The combination of steel or iron, with any or all of the following metals, viz.: lead, antimony, tin and zinc, for the purpose of forming a railway brake shoe in the manner herein described. 2nd. A metal brake shoe body B, with cavities or slots in the wearing face extending partially through the body, substantially as and for the purposes described.

No. 31,613. Wrench. (Clé à écrou.)

William C. Worthen, Gurdon Pendleton and Otis M. Shaw, Boston Mass., U.S., 18th June, 1889; 5 years.

Claim.—A pipe wrench consisting of the body A, fixed jaw C, movable jaw D, rolls or projections P, H and straps R, all formed and combined as and for the purpose set forth.

No. 31,614. Coach. (Carrosse.)

Ernest M. Macdonald, Toronto, Ont. (assignee of James L. Dyer, Athens, Penn., U.S.), 18th June, 1889; 5 years.

Claim.—A coach shaped substantially as shown, and having doorways opposite to each other, near the front of the coach, each doorway having a vestibule formed by the side boards F, step D and projection E, arranged substantially as and for the purpose specified.

No. 31,615. Machinery or Apparatus for the Manufacture of Cards for use in Carding Cotton and Wool. (Machinerie ou appareil de fabrication des cartes à carder le coton et la laine.)

Joseph Moseley (assignee of the estate of Charles Moseley), Manchester, Eng., 18th June, 1889; 5 years.

Claim.—1st. In or for cards of the kind used for carding cotton or wool, forming the teeth of the said cards, or the lengths of wire to be used in the said cards with round or taper points, circular or approximately circular in cross-section, as hereinbefore explained. 2nd. In the manufacture of cards of the kind used for carding cotton or wool, the employment of lengths of wire corresponding to the length of wire in each of the teeth, and sharpened in the manner described and claimed, at both ends before being inserted into the backing or foundation, as hereinbefore described. 3rd. The manufacture of cards for use in carding cotton or wool by firstly cutting the wires into lengths to form each a tooth, afterwards sharpening both ends thereof, as hereinbefore described, afterwards bending them into U-shape, and then inserting the teeth so formed into the backing or foundation, substantially as hereinbefore explained. 4th. In machinery or apparatus for the manufacture of cards for carding cotton or wool, the combination of mechanism adapted for selecting lengths of already cut and pointed wires, and delivering them to the mechanism by which they are bent and inserted into the foundation material, substantially as hereinbefore described. 5th. In or for machinery or apparatus for use in or connected with the manufacture of cards for carding cotton and wool, or other fibrous materials, a hopper or receiver for lengths of wire, with an outlet for but one wire at a time, with a ranging or selecting bar for removing one wire at a time and bringing it into position to be brought under the operation of the bending and inserting devices, substantially as hereinbefore described and illustrated. 6th. In or for machinery or apparatus for use in or connected with the manufacture of cards for carding cotton and wool or other fibrous materials, a device for seizing lengths of wires and bringing them into position to be bent and inserted into the foundation material, substantially as hereinbefore described and illustrated. 7th. In machinery or apparatus for use in or connected with the manufacture of cards for carding cotton and wool and other fibrous materials, the combination of a hopper or receiver for lengths of wire, and means for removing one length at a time, and a device for removing the wires, one after the other, and bringing them into position to be acted on by the bending and inserting devices, substantially as hereinbefore described and illustrated. 8th. The several modifications of apparatus or devices, hereinbefore described and illustrated, for separating the needles and presenting them to the apparatus employed to seize and convey them to the bending and inserting mechanism.

No. 31,616. Sample of Paint, etc.*(Echantillon de couleur, etc.)*

Valentine and Company, New York (assignee of Frank H. Rose, Syracuse, N. Y., U.S., 18th June, 1889; 5 years.

Claim.—Color samples, consisting of concavo-convex glass plates A, having colors applied to the concave surfaces thereof, and the textile backings B covering the colors and conforming to the adjacent surfaces of the plates, the colors being visible through the convex faces of the plates, said samples being uniformly constructed as to size and curvature of surfaces, thus permitting the convex surface of each plate when the samples are placed in a stack to fit snugly within the concave surface of the backing of the plate next above it, substantially as and for the purpose described.

No. 31,617. Baby Walker. (Chariot d'enfant.)

William Lane and Alfred Doney, Pen Argyl, Penn., U.S., 18th June, 1889; 5 years.

Claim.—In a baby-walker, the combination of a chair or frame provided with the supporting rollers, and the extension arm projecting from one side thereof, and adapted to be pivoted to a fixed point, and thereby direct the baby-walker in circles of any desired radius, substantially as described.

No. 31,618. Coin Operated Calculating Machine. (Machine à calculer actionnée par une pièce de monnaie.)

Franklin W. Brooks, New York, N.Y., U.S., 18th June, 1889; 5 years.

Claim.—1st. The combination, with the casing having the vertically elongated openings *a*, of the movable plate located in said casing and having columns of figures thereon adapted to align with said openings, and also having the lug *d* and a pivoted bell crank lever engaging said lug when the plate is in its downward position, substantially as described. 2nd. The combination, with the box or casing having the vertically elongated openings, of the movable plate located in said casing and having columns of figures thereon adapted to align with said openings, and the spring *m* connecting the lower edge of said plate with the bottom of the casing and tending to draw the plate diagonally downward, substantially as described. 3rd. The combination, with the box or casing having the vertically elongated openings *a*, of the movable plate B, having columns of figures thereon adapted to align with said openings, a hand lever having its fulcrum in one side of the casing, and a link connecting said lever and plate whereby, when the lever is depressed, the plate will be caused to move slightly to one side and then upwardly, substantially as shown and for the purpose set forth. 4th. The combination, with the box or casing having the vertically elongated openings *a*, of the movable plate B having thereon columns of figures adapted to align with said openings, and also provided with the lug *d* of the pivoted bell crank lever engaging said lug when the plate is down, and the spring *m* connecting the lower edge of said plate with the bottom of the casing at diagonally opposite points, substantially as described. 5th. The combination, with the box or casing having the vertically elongated openings *a*, of the movable plate located in said casing, and having thereon columns of figures adapted to align with said openings, and also provided with lug *d*, the pivoted bell crank lever engaging said lugs when the plate is down, the spring *m* connecting the lower edge of the plate with the bottom of the casing, the hand lever having its fulcrum in one side of the casing, and a link connecting said lever and plate, substantially as shown and for the purpose described. 6th. The combination, with the box or casing having the vertical openings *a*, of a movable plate located in said casing, and having thereon columns of figures adapted to align with said openings, a spring tending to draw said plate diagonally downward, a lock for maintaining the plate in such downward position, and a hand lever and link connection for operating said plate, substantially as described. 7th. The combination, with the box or casing, having the vertically elongated openings *a*, of the movable plate B having the lug *d*, and provided with columns of figures adapted to align with said openings, a pivoted bell crank lever for engaging said lug when the plate is drawn downwardly, a rod connected to said lever and a weighted rocking lever connected to said rod, substantially as described. 8th. The combination, with the weighted rocking lever *t* mounted in V-shaped bearings, of the metal strip *r* formed to overlap the lever and retain it in its bearing, and having a portion turned under said lever to act as a stop therefor, substantially as shown and described. 9th. The combination, with the casing having in its bottom the posts *n*, of the movable plate B, and the links *o*, connecting said plate to said posts, substantially as described. 10th. The coin chute or conduit *D* constructed in two parts, the line of separation beginning a suitable distance from the bottom at one of the sides, and extending diagonally downward to or near to the lower edge at the opposite side, substantially as described. 11th. The combination, with the box or casing A, and the movable plate B, of the coin chute *D* constructed of two parts, the lower part *p* of which is connected to said plate, by which to be carried therewith when the same is moved, substantially as described. 12th. The combination, with the casing A and movable plate B having the stud or projection *y* and spring *m* drawing the plate downward diagonally, of pawl *x* operated by said stud, and the indicator dial and ratchet wheel, substantially as described. 13th. The combination, with the casing A having the upper openings *b*, and the movable plate provided with the series of lugs or teats *c*, and the spring bolts *e*, provided with spring catches for engaging said lugs or teats when the plate is up and said bolts are depressed, the same being also provided with the plates *t* having numbers thereon for registering with said openings *b*, substantially as described. 14th. The combination, with the box or casing A, having the vertical openings *a* and the upper openings *b*, of the movable plate B provided with columns of figures adapted to align with said vertical openings, having the series of teats *c*, the spring bolts *e* having the spring catches *u* and numbered plates *t*, and a hand lever and link for moving said

plate upward, substantially as described. 15th. The combination, with the box or casing having the vertical openings *a* and upper openings *b*, of the movable plate B, having the lug *d* and the series of teats *c*, and also provided with columns of figures adapted to align with said vertical openings, the spring bolts having the spring catches and numbered plates, a hand lever and link for moving the plate upwardly, and a lever for engaging lug *d* to maintain the plate locked in its downward position, substantially as described. 16th. The combination, with the movable plate B, having lug *d*, of the lever *f* engaging said lug, the rod *h* and the weighted rocking lever *i* connected to the rod, and adapted to release said lever *f* from lug *d* when depressed, substantially as shown and described. 17th. The combination, with the spring bolts *e*, having the plates *t*, of the movable locking strip *v*, having the projections *w*, which rest beneath the lower ends of said plates when the parts are in their normal positions, substantially as shown and for the purpose described. 18th. The combination, with the casing having strip *z*, provided with slot *v* and the spring bolts having the plates *t*, of the movable plate B, the strip *v* having projections *w* and provided with pin *x* and the sector *G* formed with slot *a* working on pin *x* and secured to the movable plate, substantially as shown and described.

No. 31,619. Apparatus for Liquid Purification. (Appareil de purification des liquides.)

William Oliphant, Jersey, N.J., U.S., 18th June, 1889; 5 years.

Claim.—1st. The herein described method of purifying liquid, consisting in subjecting the same to filtration through a bed of one grade of material, and subsequently through another bed of a different grade of material, said material being subjected to cross cleansing currents, substantially as described. 2nd. The method described of discharging and renewing the fouled portion of an up-current filter-bed, the same consisting in forcing a hydraulic counter current horizontally through the lower portion thereof, and replacing the portion so discharged by gravitation of the remaining portion, substantially as and for the purposes set forth. 3rd. A filtering vessel, composed of a horizontal cylindrical body, and comprising two separate filter beds containing compartments, said compartments separated by a vertical partition, terminating at its lower portion with an approximately horizontal apron extending partly across said vessel, beneath one of said compartments, the latter compartment provided at or near its lower portion with a perforated or porous bed suspending diaphragm, substantially as and for the purposes set forth. 4th. The herein described filtering vessel, embodying two separate filter bed compartments, the one adapted for downward and horizontal filtrate current, the other for upward filtrate current, each of said compartments having inlet and outlet washing pipes located at or near their lower section on opposite sides thereof, adapted to give a horizontal washing or cleansing current, as and for the purposes set forth. 5th. In a filtering apparatus, the combination of two or more filter bed compartments, the first or a portion thereof extending horizontally and terminating at its point of delivery beneath, the second bed or beds, and having a series of washing pipes and a blow-off pipe or pipes located as described to produce a current through the lower section of its horizontal portion in a direction common to the filtrate current, whereby the latter has uninterrupted access to the said second bed or beds, for the purposes set forth. 6th. In a filtering apparatus, the combination of a coarsely pulverized filter bed containing chamber, and a finely pulverized filter bed containing chamber, the latter located as shown to receive the upward filtrate discharge of the said coarsely pulverized bed, and having washing and blow-off pipes adapted to force a horizontal current therethrough, for the purposes set forth. 7th. The combination, with a filter bed chamber, of the herein described filtrate reduction pipe, having an extension within said chamber, composed of semi-cylindrical sections and interposed diaphragm, said diaphragm and one of said sections being perforated and adapted to receive and retain a granulate filling, for the purposes set forth. 8th. The combination, with a filtering apparatus, composed of a horizontal shell, subdivided in part by a depending partition, as B, and in part by a horizontal porous suspending diaphragm, as E, of the inclined diaphragm F located in the relation with the said parts, as shown, said diaphragm F having pores, meshes, or perforations, which vary in size in increasing order from the portion at which the filtrate current obtains first access thereto to the portion at which the filtrate obtains final access thereto, for the purpose specified. 9th. In a filtering apparatus of the class specified, the combination with the inlet pipes and filter bed, of connecting supplemental cleansing pipes, as described, and a blow-off pipe or pipes located at the lower portion of the filter case or beds, each having weighted valves, substantially as shown, which are held closed under the normal pressure of the filtrate to intercept the inflow of a cleansing current, or of an outflow current in said blow-off pipe or pipes, and which automatically open by an excess of said pressure of the filtrate above a given degree, as set forth.

No. 31,620. Combined Cultivator, Plough, etc. (Cultivateur, charrue, etc., combinés.)

Abram B. McBride, Medina, Texas, U.S., 18th June, 1889; 5 years.

Claim.—1st. The combination, with the frame A having the supporting wheels, and a supplementary detachable and removable frame carrying the implements and adapted to bear against the lower side of frame A, and the devices to detachably secure said frame to the frame A, whereby the machine is adapted for using various cultivating and cutting devices, substantially as described. 2nd. The combination, with the frame A having the supporting wheels, and a supplementary detachable and removable frame carrying the implements and adapted to bear against the lower side of frame A, said supplementary frame being provided with the vertical right angular brackets adapted to engage the sides and rear end of the frame A, and the bolts to secure the said supplementary frame to the frame A, whereby the machine is adapted for using various cultivating and cutting devices, substantially as described. 3rd. The combination, with the main frame A, having the driving or supporting wheels, of the frame B detachably secured thereto and having

the depending brackets, the rock-shafts journaled in said brackets, and having the ratchet-wheels and the rock-arms, the plough beams pivotally bolted to the lower ends of the rock-arms, the double-ended pawl or detent to engage said ratchet-wheels, and having the operating lever and the lever secured to one of the rock-shafts, substantially as described.

No. 31,621. Sole and Heel Plate.

(*Plaque de semelle et de talon.*)

Louis N. Beauchemin, San Diego, Cal., U. S., 18th June, 1889; 5 years.

Claim.—1st. The sole and heel plates A, B, provided with the openings *a*, *b*, *c*, the pointed prongs *d* and the screw holes *e*, substantially as specified. 2nd. As an improved article of manufacture, sole and heel plates of approximately the form of the sole and heel of a boot, provided with openings for reducing their weight, and furnished with pointed prongs, substantially as specified.

No. 31,622. Scarf Protector. (*Renfort de cravats.*)

Jeese H. Moyer, Temple, Texas, U.S., 18th June, 1889; 5 years.

Claim.—1st. A scarf protector consisting of two members U-shaped in cross-section, fitted one within the other, and having a pin-and-slot connection at the rear thereof, as and for the purpose described. 2nd. As a new article of manufacture, a scarf-protector, consisting of a central member, substantially U-shaped in cross-section, and two extensible members fitted within the central member at the ends thereof, and connected thereto by a pin and slot connection, substantially as described. 3rd. As a new article of manufacture, a scarf-protector, consisting of a longitudinally-curved central member, substantially U-shaped in cross-section, and having a transverse recess in its rear arm, and two extensible members fitted within and connected to the central member at the ends thereof and curved to correspond with the same, substantially as described. 4th. As a new article of manufacture, a scarf-protector, consisting of two extensible members connected to each other, and fastening hooks or claws permanently connected to one of the members, substantially as described.

No. 31,623. Vulcanization of Water-proofed Fabrics and other India Rubber Goods in Continuous Lengths and Apparatus Employed therefor. (*Vulcanisation des tissus imperméabilisés et autres étoffes de caoutchouc de longueur continue et appareil pour cet objet.*)

Harry H. Waddington, Manchester, Eng., 18th June, 1889; 5 years.

Claim.—1st. The improved method or process of vulcanizing India rubber fabrics or goods in a continuous manner, substantially as hereinbefore described, and 2nd. I claim the vulcanizing chamber, fitted with a series of rollers, and having an inlet and an outlet opening, so that the goods can be continually passing through, substantially as hereinbefore described and illustrated by the drawing annexed.

No. 31,624. Bicycle Clutch.

(*Embrayage à adents de bicyclette.*)

James E. Evans, Cincinnati, Ohio, U.S., 18th June, 1889; 5 years.

Claim.—1st. A ball clutch having an outer circular wall *a*, having a groove *a1* therein, in combination with a toothed disk *C* having a groove *a2* in its outer face, and suitable balls *E* interposed in said grooves between said wall and disk, substantially as set forth. 2nd. An anti-header for bicycles consisting of a circularly counter-sunk crank *A*, having an outer circular wall *a*, said wall having a groove *a1* therein, in combination with a toothed disk *C*, having a groove *a2* in its outer face, and suitable balls *E* interposed in said grooves between said wall and disk, the latter being attached to the fork *D* of the bicycle, substantially as set forth. 3rd. The cranks *A* rigidly connected to shaft *B*, said cranks being circularly counter-sunk in the inner faces, in combination with circularly-toothed disks *C* in said countersunk portions, and balls *E* interposed between walls *a* and the disk *C*, lugs *c* attached to said disks, and screws *c1*, substantially as set forth.

No. 31,625. Hub for Wheels.

(*Moyeu de roues.*)

Uldarique Gibeault, St. Isidore, Qué., 18th June, 1889; 5 years.

Claim.—In a hub for wheels, the two portions *A* and *B* provided with the slots *L* and secured by the bolts *N*, the flanges *E* and *F*, secured by the bolts *M* and the boxes *H* and *G*, substantially as described and for the purposes set forth.

No. 31,626. Steam and Hot Water Boiler.

(*Chaudière de calorifère à vapeur et à eau.*)

William W. Kelsey, Cortland, N.Y., U.S., 19th June, 1889; 5 years.

Claim.—1st. A steam or hot-water boiler comprising a plurality of hollow walls corrugated externally and internally and disposed side by side, with passages for the products of combustion between them, and with the corrugations of each parallel with those of the adjacent wall, and the water supply-pipe communicating with the interiors of said walls, as set forth. 2nd. A steam or hot-water boiler comprising a plurality of hollow walls corrugated vertically, externally and internally and disposed side by side, with the convex portions of each directly opposite the concave portions of the adjacent wall, and with

passages for the products of combustion between them, substantially as described and shown. 3rd. In a steam or hot-water boiler, the combination of a water jacketed fire pot, hollow walls rising from said water jacket at opposite sides of the fire pot and corrugated vertically, correspondingly corrugated hollow walls between the aforesaid walls, and each having its convex portions directly opposite the concave portions of the adjacent wall and forming between them serpentine fire passages, and having their bases forming the crown of the fire pot, and water ducts connecting said hollow walls, as set forth. 4th. A steam or hot-water boiler, composed of a series of vertical hollow walls corrugated vertically and arranged parallel side by side, with passages for the products of combustion between them, the outer walls extending beneath the intermediate walls, and the grate surrounded by the bases of the outer walls, water ducts connecting said walls, a case enclosing the aforesaid walls with passages for the products of combustion between said case and outer walls, and a smoke exit pipe connected to the said case, substantially as described and shown.

No. 31,627. Nail Driver. (*Chasse-clou.*)

John Patten, New York, N.Y., U.S., 19th June, 1889; 5 years.

Claim.—1st. The combination with the base-plate having the opening 2, of the rotating magazine *F* having the chambers 3 for containing the nails, and arranged to successively register with the opening in the base-plate, and the reciprocating driver working through said chambers, substantially as described. 2nd. The combination, with the rotating magazine having the chambers 3, of the reciprocating driver, and the magnet *H* arranged above the magazine, substantially as described. 3rd. The combination, with the magazine having the chambers 3 and the spring for rotating the same, of the reciprocating driver working through the chambers of the magazine, and the escapement mechanism operated by the driver to permit the magazine to be moved by the spring with a step-by-step movement, substantially as described. 4th. The combination, with the magazine having the chambers 3 and the spring for rotating the same, of the reciprocating driver working through the chambers of the magazine, the escapement mechanism operated by the driver, and the magnet *G* located above the magazine, substantially as described. 5th. The combination, with a rotating magazine having the chambers 3, of the spring *a*, and the pawl and ratchet mechanism for winding the spring, the reciprocating driver working through the chambers of the magazine, and the escapement mechanism operated by the driver, substantially as described. 6th. The combination, with the rotating magazine having the chambers 3, of the reciprocating driver working through the chambers, the magnet *G* located above the magazine, and the spring *a* for throwing the nails toward the magnet, substantially as described.

No. 31,628. Car Axle Box. (*Boîte à graisse.*)

Edward Best, Carleton Place, Ont., 19th June, 1889; 5 years.

Claim.—1st. In a car axle box, a removable oil vessel having the oil escape opening *G* and otherwise formed, substantially as herein shown and described. 2nd. In a car axle box, the combination of the oil vessel *F* with the springs *H*, substantially as herein shown and described. 3rd. The combination, in a car axle box, of the outer case *A* having the ribs *E*, with the oil vessel *F* having the opening *G* and oil creases *J*, and springs *H*, substantially as herein shown and described.

No. 31,629. Apparatus for Pressing Pulp.

(*Appareil à presser la pulpe.*)

Frank B. Howard, Montréal, Qué., 21st June, 1889; 5 years.

Claim.—1st. The combination in an apparatus for pressing pulp and forming upon it configurations as described, of a press provided with a drainage bed *n*, drainage plate *g*, wire cloth *u*, mould *h*, die *C*, with a plunger *f* having vacuum chamber *t*, perforated plate *l*, wire cloth *m*, and marginal edges *a2*, the whole constructed, arranged and operating together substantially as described. 2nd. The combination in an apparatus for pressing pulp and forming upon it configurations as described, of a press provided with a drainage bed *n*, perforated plate *g*, wire cloth *u*, mould *h*, and die *a* having wire cloth *h1*, and perforated plate *ct*, with a plunger having vacuum chamber *t*, perforated plate *l*, wire cloth *m*, die *a1*, having wire cloth *c*, and perforated plate *bt*, the whole constructed, arranged and operating together substantially as and for the purposes described. 3rd. The combination in an apparatus for pressing pulp and forming upon it configurations, of a vacuum chamber provided upon one side of the mould with a die, and having drainage on both sides of the body of pulp being pressed, the whole substantially as and for the purposes set forth. 4th. The combination in the construction of the die-plate *a1*, of the shell *g5*, with the openings that form the relief formed entirely through the thickness of the die-plate, and a filling or backing *g6*, the whole substantially as described. 5th. The process of forming the die-plate *a1* which consists in uniting two boards together, and carving in or through one of them the desired configurations, then making an impression of the carved side of the boards metalizing the said impression, and then electro-plating the same, and forming a shell thereon, filling the shell and forming it into a plate, and cutting it down until openings are formed completely through the same, the whole substantially as described. 6th. In a die for forming configurations on surfaces of pulp, the die-plate having the openings to form relief formed entirely through it, substantially as described. 7th. In a die for forming configurations on surfaces of pulp, the die-plate *a1* having relief openings completely through it, with a wire cloth having centre pieces *a1* attached thereon in proper relative position to act in unison with the said die-plate, the whole combined substantially as described for the purposes set forth. 8th. In a die for forming configurations on surfaces of pulp, a die-plate having relief openings completely through it, with a wire cloth *a1* having pieces attached thereto, of various heights of relief or elevation, said pieces being provided with wire cloth and having also perforations through their body to cause a drainage from the said heights of elevation, the whole combined and operating substantially as described. 9th.

In a die for forming configurations on surfaces of pulp, the die-plate *a* having relief openings completely through it, with a wire cloth *d* and having other height of relief provided with wire cloth and drainage perforations, the whole substantially as described and shown. 10th. In a die for forming configurations on surfaces of pulp, the die-plate having openings of relief completely through it, and having chambered edges *a* for setting out to prevent passage of pulp about its edges, with a wire cloth *b* and mould *h*, the whole combined substantially as described. 11th. In a die for compressing pulp and forming configurations thereon the openings that form the relief being also the openings that form the drainage, as described. 12th. In an apparatus for compressing pulp in dies, the combination, with the dies, of a system of drainage from both sides of the pulp, the one side being assisted by a vacuum, substantially as described.

No. 31,630. Apparatus for Grinding the Cards of Carding Engines. (*Appareil pour aiguiser les cartes des machines à carder.*)

James Leslie, Montréal, Qué., 22nd June, 1889; 5 years.

Claim.—In an apparatus for grinding card-teeth, a roller 1 having recesses 3, annulets 4, bolts 11 and disks 7, the whole substantially as described.

No. 31,631. Storage Battery Plate. (*Plaque de pile d'emmagasinage.*)

Charles D. P. Gibson, New York, N.Y., U.S., 22nd June, 1889; 5 years.

Claim.—1st. A storage-battery plate consisting of a sheet of metal having portions thereof raised above its surface in the form of loops. 2nd. A storage-battery plate consisting of a sheet of metal having loops raised from its surface, and active material covering the surface of said plate and extending under the loops. 3rd. The combination of the plate A having the rim B, the loops D, and the active material C covering the plate and secured thereto by extending under said loops, as described.

No. 31,632. Storage Battery Plate. (*Plaque de pile d'emmagasinage.*)

Charles D. P. Gibson, New York, N.Y., U.S., 22nd June, 1889; 5 years.

Claim.—1st. A storage-battery plate consisting of a sheet of metal having transverse openings, a button of the same material extending through each opening and having an enlarged head at each end, and active material filling the spaces in the openings about the buttons. 2nd. A storage-battery plate consisting of a sheet of metal having openings, buttons placed in each opening, consisting of a central stem and enlarged heads, and active material placed in each opening about the said buttons. 3rd. A storage-battery plate consisting of a sheet of metal having rectangular openings, buttons of metal extending through each opening and consisting of central stems and flattened ends of diamond shape, said ends being approximately flush with the respective surfaces of the plate, and active material about the buttons.

No. 31,633. Artificial Leg. (*Jambe artificielle.*)

Chancy A. Frees, New York, N.Y., U.S., 22nd June, 1889; 5 years.

Claim.—1st. The combination of leg A and foot B, with the bulged plate a forming a ball on one side and a socket on the other, and with a ball engaging the socket of said plate, and with a socket for receiving the ball of said plate, substantially as specified. 2nd. The combination of leg A and foot B, with bulged plate a, and with a forked bar provided with ball c and with spring h, substantially as specified. 3rd. The combination of leg A and foot B, with bulged plate a and with a forked bar, one arm of which carries a ball c, the second arm of which is connected to a fixed support, and the third arm of which is connected to a spring h, substantially as specified. 4th. The combination of leg A and thigh D, with bolt h⁵ having conical head h⁶ at one end, and with conical nut h⁷ that receives the other end of the bolt, and with the braces h⁸, substantially as specified. 5th. The combination of leg A and foot B, with the heel tendon h¹, and with the hook m connected therewith, and with the grooved plate n¹ engaging the hook, and with gasket n² within said grooved plate, substantially as specified. 6th. The combination of leg A, foot B and thigh D, with the pivot a traversing the thigh, and with the equalizing-bar n¹ turning on said pivot and adapted to be connected to the shoulder-strap, substantially as specified.

No. 31,634. Compressed Air Water Elevator. (*Élévateur d'eau à air comprimé.*)

Julius G. Pohlé, Georgetown, Col., U.S., 22nd June, 1889; 5 years.

Claim.—1st. In combination with the means for positively forcing or elevating water, and the rising eduction-pipe or passage thereof, means for injecting air directly into such rising pipe to mingle with the ascending column of water, substantially as and for the purpose specified. 2nd. In combination with power mechanism for positively forcing water up a rising eduction pipe or passage, means for introducing air into the eduction pipe to mingle with the ascending column of water, substantially as and for the purpose shown. 3rd. In combination with a device for positively elevating water by compressed air having the compressed-air inlet or supply-pipe, and the rising eduction-pipe, means for introducing air into the eduction-pipe from the air supply pipe, substantially as and for the purpose set forth. 4th. In combination with the rising eduction pipe or passage of a liquid elevating device provided with a check valve to prevent the downward flow of liquid in the eduction pipe, means for introducing air into the eduction-pipe above the valve, substantially as and for the purpose described. 5th. In combination with a device for elevating water by compressed air, having the compressed air inlet or supply pipe, and the rising eduction pipe, one or more connecting pipes between such inlet and eduction pipes adapted to inject air into the eduction pipe in a fine jet or jets, substantially as

and for the purpose specified. 6th. In combination with the collecting tank or chamber, and the compressed air and upright eduction pipes, one or more tubes or pipes connecting the air and eduction pipes above the tank or chamber, substantially as and for the purpose described. 7th. In combination with the upright water eduction pipe B and the compressed air pipe C, one or more tubes connecting such pipes, each provided with a plug having one or more small orifices connecting with the bore of the water eduction pipe, substantially as and for the purpose described. 8th. The improved method of raising water or other liquids, which consists in forcing the same up an upright eduction pipe, and introducing air into the column of water in the pipe to mingle with the ascending column of water, substantially as and for the purpose described. 9th. The improved method of elevating water or other liquids, which consists in forcing the water or liquid up in an upright eduction pipe by a suitable forcing or pumping device, and injecting into the column of liquid within the pipe, air in the form of a fine jet or jets, so as to form bubbles in the liquid, substantially as and for the purpose described.

No. 31,635. Tripod Head for Surveying Instruments. (*Chapeau de tripied pour instruments d'arpentage.*)

Willard D. Johnson, Washington, D. C., U.S., 22nd June, 1889; 5 years.

Claim.—1st. A tripod head for surveying instruments, in which is combined a leveling mechanism, and a mechanism for circumferential adjustment that acts independently, and the axes of whose motions intersect at a point within or above the instrument supporting table, substantially as and for the purpose specified. 2nd. A tripod head for surveying instruments, in which the axial bearing for the supporting table is in part formed by a spindle that is journaled within a bearing, which is fitted to and adapted to be moved upon or over the face of a relatively fixed concave plate, and is in part formed by the direct bearing of a convex boss upon the face of said concave plate, substantially as and for the purpose shown. 3rd. A tripod head for surveying instruments, in which the supporting table is independently journaled within a convex plate and a concave plate that are combined and adapted to bear upon and move over the opposite sides of a stationary concavo-convex plate, and by a relatively inward pressure to be engaged with and locked upon the same, substantially as and for the purpose set forth. 4th. A tripod head for surveying instruments, in which the supporting table is independently journaled within a movable concave plate that rests upon the concave face of a stationary concavo-convex annular plate is provided with a hollow axial spindle which extends through a central opening in the same, and is combined with a movable concave plate that fits over said spindle, and bears upon the convex face of said stationary plate, and a nut which fits upon a threaded portion of said spindle and is adapted to press said movable plates by a relatively inward movement firmly against and lock the same upon the faces of said stationary plate, substantially as and for the purpose shown and described. 5th. As an improvement in tripod heads for surveying instruments, the combination in one organization of the following elements, viz: a stationary annular concavo-convex plate that is adapted to be connected with and supported by pivoted legs, a movable concave plate provided with a hollow axial spindle, a movable concave plate which is fitted over and upon said spindle, means, substantially as shown, whereby said movable plates may be pressed toward each other, and caused to bear upon the opposite faces of said stationary plate, and an axial spindle that is adapted to pass into and rotate independently within said hollow spindle, and at its upper end is adapted to be attached to an instrument supporting table, substantially as and for the purpose specified. 6th. As an improvement in tripod heads for surveying instruments, the combination of the following elements, viz: a stationary annular concavo-convex plate, a movable concave plate and a movable concave plate that are adapted to bear upon the opposite faces of said stationary plate, and are combined by means of a hollow axial spindle having a peripheral thread and an encircling nut, and a spindle which is journaled within said hollow spindle and has its upper end adapted to receive an instrument supporting table, and at said end is provided with an annular convex boss that conforms to and rests upon the upper concave face of said plate, substantially as and for the purpose shown. 7th. As an improvement in tripod heads for surveying instruments, the combination of the following elements, viz: a stationary annular concavo-convex plate, a movable concave plate and a movable concave plate that are adapted to bear upon the relatively opposite faces of said stationary plate, and are combined by means of a hollow axial spindle, provided with a peripheral thread and encircling nut, a spindle which has its upper end adapted to receive an instrument supporting table, is journaled within said hollow spindle, and means, substantially as shown, whereby said journaled spindle may be locked in place and prevented from rotating when desired, substantially as and for the purpose set forth. 8th. As an improvement in tripod heads for surveying instruments, the combination of the stationary annular concavo-convex plate, the movable concave plate provided with the hollow peripherally threaded spindle and encircling nut, the movable concave plate adapted to fit over said spindle, and the table-supporting and journaling spindle which has a threaded lower end and an encircling nut, and at its upper end is provided with an annular boss that has a convex lower side, and at its upper side is adapted to be connected with an instrument supporting table, substantially as and for the purpose shown and described.

No. 31,636. Method of Dealing with the Effluent of Drains and Sewers for its Purification. (*Mode de traitement de l'effluent des drains et égouts pour sa purification.*)

Harry R. Newton, Weybridge, Eng., 22nd June, 1889; 5 years.

Claim.—The herein described method of dealing with sewage effluent by causing it to overflow at such a level that the channels conveying it are kept always full, and a body of it is kept quiescent while undergoing chemical treatment, filtration or subsidence.

No. 31,637. Receptacle for Poisons.*(Réceptacle pour les poisons.)*

Theophilus Mayhew, New York, N. Y., U. S., 22nd June, 1889; 5 years.

Claim.—1st. In a case or receptacle for poisons, the combination of a series of detachable slides adapted to support receptacles and locking mechanism, substantially such as described, to control the removal of said slides, as and for the purpose set forth. 2nd. In a case or receptacle for poisons, a series of detachable slides carrying receptacles, and locking mechanism for retaining the same in their closed positions, adapted to permit one only of said slides to be removed from the case at a time, and preventing the removal of a second slide till such time as the first shall have been returned, as set forth. 3rd. In a case or cabinet for poisons, the combination, with two or more sliding receptacles, of a locking device for each of said receptacles, and a lock-operating mechanism common to all of said receptacle locking devices, the combination being such, as described, that it is impossible to have removed from the case or cabinet more than one receptacle at a time, all as set forth. 4th. In a case or receptacle for poisons, a receptacle consisting of a base piece adapted to slide in guide-ways formed in the case, and having attached to it a bottle or receptacle, in combination with an electro-magnetic locking device for retaining or releasing said slide, as and for the purpose set forth. 5th. In a case or receptacle for poisons, the combination of two or more sliding receptacles, a pivoted latch lever for each slide, an armature attached to each latch lever, electro-magnets located in position each to operate one of the pivoted latch levers, contact plates bridging over the spaces between the sliding receptacles, electric conductors arranged on each sliding receptacle, and provided with contact points to bear upon the bridging contact plates on opposite sides of the receptacles when the latter are closed, an electric generator, a number of circuits extending from one pole of the generator, each passing through one or more controlling switches, one of the electro magnets, all of the bridging contact plates and the conductors on the receptacles through a circuit-closer common to all, and back to the other pole of the electric generator, as and for the purpose set forth. 6th. In a case or receptacle for poisons, the combination of a slide carrying a receptacle and working within guide ways in a supporting frame or shelf, a lock or latch for said slide operated by an electro-magnet and adapted to engage a stop on said slide, two insulated contact plates bearing upon the slide when closed and connected across the slide by an electric conductor arranged thereon, and adapted to make said connection after the slide has been latched or locked, and to break the said connection during the withdrawal of the receptacle from the case, an electric circuit passing from an electric generator through a governing switch, the electro-magnet coils to and through the contact plates across the conductor on the receptacle and back to the electric generator, and two auxiliary contact plates connected one to each of the main contact plates and arranged over the pivoted latch lever in position to make contact with the latter, when it is raised by the electro-magnet, all as and for the purpose set forth. 7th. In a case or receptacle for poisons, the combination, with two or more receptacles locking mechanism for said receptacles, and electro-magnets adapted to operate said locked mechanism, of an electric circuit for each of said electro-magnets passing through one or more controlling switches, all as and for the purpose set forth. 8th. In a case or receptacle for poisons, the combination, with a series of receptacles, an electro-magnetic locking device for retaining each of said receptacles in the supporting case, and an electric circuit for each of said locking devices, of two or more switches connected in each of the electric circuits, the switches of the several circuits being interspersed or intermixed on the switch board, substantially as and for the purpose set forth.

No. 31,638. Treating Timber with Antiseptic or Preservative Fluid, and Apparatus therefor. *(Traitements du bois par un fluide antiseptique ou préservatif et appareil pour cet objet.)*

Samuel B. Boulton, London, Eng., 22nd June, 1889; 5 years.

Claim.—1st. The herein described improved method of treating timber with antiseptic or preservative fluids, wherein the timber, while enclosed in one and the same receptacle is firstly subjected to the action of a solution of metallic salts introduced into the receptacle from a tank connected thereto, and, secondly, after the discharge of the solution that has not been absorbed back into the tank, the timber is subjected to the action of creosote introduced into the receptacle from a second tank in connection therewith, and heated to above the boiling point of water, the watery vapour being exhausted at the same time by an air pump. 2nd. In apparatus for treating timber with antiseptic or preservative fluids, the combination of the cylinder A containing the timber to be treated, the tank D containing solution of metallic salts, and tank E containing creosote, which tanks are alternately put, in combination with cylinder A, the condenser G, receiver H and air pump I for exhausting air and vapour from the cylinder A, and the boiler O for supplying steam to coils P, Q, contained in the cylinder A and tank E, arranged and operating as herein set forth.

No. 31,639. Pneumatic Water Elevator.*(Élévateur d'eau pneumatique.)*

Julius G. Pohlé and David Hill, Georgetown, Col., U. S., 22nd June, 1889; 5 years.

Claim.—1st. In a water elevator, in combination with the pipe for supplying compressed air or steam to the receiving and collecting chamber, the valve in the pipe for regulating the admission of the air or steam to the chamber, and a motor operated and driven by air or steam taken from the supply pipe above such valve, substantially as and for the purpose described. 2nd. In a pneumatic water ele-

vator, in combination with the supply pipe and the valve adapted to admit compressed air to the collecting tank or chamber, and to allow the escape of air therefrom, the pipe connected with the supply pipe above such valve, the motor adapted to be operated and driven by the air taken from the supply-pipe by such connecting pipe, and mechanism, substantially as described, driven by the motor and adapted to operate the valve, substantially as and for the purpose described. 3rd. In a water elevator, in combination with the collecting or receiving tank, the pipe for conveying compressed air or steam thereto, the three-way cock or valve in the pipe, a motor continuously driven by compressed air or steam taken from the supply-pipe above the valve, and connecting means or gearing, substantially as described, whereby the valve is intermittently operated from the motor, all substantially as and for the purpose described. 4th. In a water elevator, in combination with the pipe from the source of supply of compressed air or steam, and the pipe connected with the collecting tank or chamber, the rotary valve between the pipes adapted to alternately establish communication between the two pipes, and between the pipe to the tank and an exhaust opening, the slotted crank on the valve stem, the rotating shaft, the crank thereon, the pin on the crank engaging the slot in the valve crank, a motor driven by the compressed air or steam from the source of supply, and connecting gearing between the motor and crank shaft, substantially as and for the purpose described. 5th. In a pneumatic water elevator, the rotary valve for admitting the compressed air or steam to the collecting tank, and for shutting off the same and allowing the air or steam in the tank to escape, the slotted crank on the valve-stem, the shaft, the crank on the shaft, the pin on the crank engaging the slot in the valve crank, the worm wheel on the shaft, the shaft provided with a worm meshing with the wheel, the motor driven continuously by the compressed air or steam from the source of supply, and connecting means, substantially as described, between the motor and the worm-shaft, as and for the purpose set forth. 6th. In a pneumatic water elevator, in combination with the rotary valve adapted to admit the compressed air or steam to the collecting tank, and to shut off the same and allow the air or steam to escape from the tank, the motor having the reciprocating piston and rod and the slide valve the pipe between the air or steam supply pipe and the valve chest of the motor, the pitman, the shaft, the pitman wheel or crank thereon, the eccentric on the shaft, the eccentric rod connected with the slide valve, the balance wheel, the worm on the shaft, the counter-shaft, the worm wheel and the crank thereon, the crank pin and the slotted crank on the rotary valve stem, substantially as and for the purpose described.

No. 31,640. Automatic Air Supply for Propelling Cars. *(Alimentation d'air automatique pour la propulsion des chars.)*

The Auto-Pneumatic Car Motor Company, (assignee of Leonidas C. Pressley), San Francisco, Cal., U. S., 22nd June, 1889; 5 years.

Claim.—1st. The reservoir carried upon the traveling car having the flexible tube with one end opening into the reservoir, and the other provided with a bell-mouthed nozzle which will connect with corresponding valve-seats, and valves upon a tube fixed under ground and parallel with the line of rails, in combination with horizontal guides upon the car, and slides or rollers, whereby the nozzle at the end of the flexible tube is held in position and caused to travel from end to end of the guides while connection is made with the fixed street-tube, substantially as herein described. 2nd. The car provided with an air-reservoir, a flexible tube having one end connected with said reservoir, and the other traveling upon horizontal guides beneath the car, and provided with a bell-mouthed nozzle by which connection is made with the corresponding valve-seats in a compressed-air pipe beneath the street, so that, when such connection is made, a valve will be opened to allow air to pass into the reservoir, in combination with a spring or weighted cord connected with the movable end of the air-pipe, so as to return it to the front end of the guides after connection has been broken with the street-pipe, substantially as herein described. 3rd. The under ground tube or tunnel parallel with and between the rails, and having an open slot in the top, a compressed-air pipe supported within the tube and having semi-globular projecting valve-chambers at intervals with inwardly-opening valves, in combination with a bell-mouthed nozzle fitting over the valve-seats, and a flat hollow disk extending up through the tube-slot so as to form a connection with the lower end of a flexible tube connecting with a reservoir upon the car, substantially as herein described. 4th. The bell-mouthed nozzles fitting the correspondingly-shaped valve-seats upon the air-pipe, and the flexible conveying-tube with which they are connected, in combination with the traveling slides or rollers fixed to the lower end of the flexible pipe, and the guides upon which these rollers travel fixed to the car and having the ends inclined, substantially as herein described.

No. 31,641. Combined Box and Cooking Stove. *(Poêle de chauffage et de cuisine combinés.)*

Henry Cunningham and Charles D. Chown, Kingston, Ont., (assignees of John McMaster, Dayton, Ohio, U. S.), 22nd June, 1889; 5 years.

Claim.—1st. A stove having substantially flat sides and ends, the sides cut away at their upper edge to provide for a heating-chamber, and a plate of greater width than the body of the stove forming the front and sides of said chamber with a flat stove-top covering the entire stove, substantially as set forth. 2nd. A box-stove having sides extending its entire length and cut away at *a*, in combination with a plate resting on said cut-away sides extending laterally beyond the same, and having its sides and front turned up to form walls for the heat-chamber, and a flat stove-top of irregular width to cover said heat chamber and the front of the stove, substantially as set forth. 3rd. In a box-stove having a heat-chamber formed there-in separate from the stove-body, the following elements in combination: straight sides cut away along their upper edges, as at *a*, a plate with upwardly-curved front and side portions, wider than the stove-

body and resting on the cut-away side portions, and flush on top with the uncut edge thereof, said plate having an opening, as c. for the passage of heat into the heat-chamber, a flat stove-top covering the entire stove and plates to direct the heat into the body of the heat-chambers, substantially as set forth.

No. 31,642. Harvester. (*Moissonneuse.*)

The Massey Manufacturing Company, (assignee of John McLachlan), Toronto, Ont., 22nd June, 1889; 5 years.

Claim.—1st. The pivoted bracket D supporting the worm pinion C, which is connected to the rod A, in combination with a bar J arranged to support the said bracket, substantially as and for the purpose specified. 2nd. The pivoted bracket D supporting the worm-pinion C, which is connected to the rod A by a flexible joint B, in combination with a bar J provided with a spring L, and arranged to support the said bracket D, substantially as and for the purpose specified.

No. 31,643. Non-Eccentric Valve Gear.

(*Garniture de soupape non-excentrique.*)

Michael I. Welch, Valdosta, and John J. McDonough, Savannah, Ga., U.S., 22nd June, 1889; 5 years.

Claim.—1st. In a valve gear, the combination, with a projection upon the cross-head, of a rocking oscillator block having a groove in which the projection works, and a reverse link operated by the block, as set forth. 2nd. In a valve gear, the combination, with a pin or projection carried by a sliding cross-head, of a rocking oscillator block having a groove of approximately the shape of a figure 8 in which the pin or projection moves, and a reverse link, and link pin adjustable in said link, as set forth. 3rd. In a valve gear, the combination, with a pin or projection upon a sliding cross-head, said pin being vertically adjustable, of a rocking oscillator block having a groove as described, in which the pin or projection works, and a link operated by the block, as set forth. 4th. In a valve gear, the combination, with a sliding cross-head, a pin or projection carried thereby, a grooved oscillator block, a link carried and operated thereby, and a rod having a link pin working in the link, and connections from said rod to a main valve and to a reverse lever, as set forth. 5th. In a valve gear, the combination of the cross-head, a check F carried thereby, a vertical slot in said check, a pin F' carried therein, and a set-screw F" for adjusting the height of the pin, and a rocking oscillator block having a groove in which the pin works, and a link carried and operated by the block, as set forth.

No. 31,644. Equalizer for Car Vestibules.

(*Régulateur pour les vestibules des chars.*)

The Pullman's Palace Car Company, Chicago, (assignee of Henry H. Sessions, Pullman), Ill., U.S., 22nd June, 1889; 10 years.

Claim.—1st. In a car-vestibule, shafts located at the sides and at the upper portion of the vestibule, adapted to longitudinal movement, their front or outer ends bearing against the abutting plates of the flexible vestibule portion, and their rear or inner ends being connected by a lever or system of levers, with buffer-springs interposed between said levers and shaft as a resistance to the inward movement of the latter. 2nd. In a car-vestibule, shafts located at the sides of the vestibule adapted for longitudinal movement having at their inner or rear ends, lever attachments connecting one shaft with the other and being provided with spherical outer ends, a spring interposed between the shaft and lever as a resisting medium for said shaft, in combination with the abutting plate, of a flexible vestibule, said plate being provided with sockets adapted in conjunction with the spherical shaft ends to form ball and socket joints. 3rd. In a car vestibule, shafts at each side of the upper portion of the vestibule bearing against the abutting plate of a flexible connection, and having connected therewith springs affording yielding resistance to inward movement thereof, in combination with a system of equalizing levers consisting of vertical bars at the sides, and a horizontal equalizing-bar attached to the end of the car to which said vertical bars are pivotally or flexibly attached. 4th. In a car-vestibule, the shafts a, and abutting plate I provided with ball and socket joints K, L at their bearing one with the other, in combination with springs R, vertical levers F, and horizontal lever H, substantially as and for the purpose set forth. 5th. In a car-vestibule, the combination of the flexible vestibule portion D, shafts a, springs R, vertical levers F and horizontal lever H, substantially as and for the purpose set forth.

No. 31,645. Manufacture of Refractory Crucibles, Pots, Bricks and Lumps for Furnaces. (*Fabrication des creusets, pots, briques et massés réfractaires pour les fourneaux.*)

Adam Mosyoiensky, St. Petersburg, Russia, 22nd June, 1889; 5 years.

Claim.—1st. The method of manufacturing refractory crucibles, pots, bricks, and lumps for furnaces, consisting in the admixture of fire clay, blast furnace slag, broken glass and crude sulphur, substantially in the proportions set forth, and after adding shredded asbestos to the pasty mass, running the same into moulds lined with asbestos, which are then subjected to the necessary heat for baking or firing, substantially as herein described. 2nd. Refractory crucible, pots, bricks, and lumps for furnaces, compounded of fire clay, blast furnace slag, glass, sulphur, and shredded asbestos, substantially in the proportions and for the purposes set forth. 3rd. Refractory crucibles, pots, bricks, and lumps for furnaces, faced with a layer of shredded asbestos, substantially as herein described.

No. 31,646. Manufacture of Watches and other Mechanism. (*Fabrication des montres et autres mécanismes.*)

Frank Leman, Elgin, Ill., U.S., 22nd June, 1889; 5 years.

Claim.—1st. As an improvement in the manufacture of watches and other mechanisms, an organization in which is combined means,

substantially as described, whereby all of the different operations between roughing out and completion may be simultaneously carried on upon a number of like parts, means, substantially as described, whereby each of said parts may be successively subjected to each of said operations, and means, substantially as described, whereby as each of said parts is completed it may be removed and replaced by a blank without suspension of, or interference with, the action of the operative mechanism, substantially as and for the purpose specified. 2nd. As an improvement in the manufacture of watches and other mechanisms, an organization in which is combined means, substantially as described, whereby a number of the same parts may be simultaneously presented to a series of tools that by successive action are adapted to rough out and finally complete each of the same, means, substantially as described, whereby each of said parts may be successively brought into contact with each tool of the series, and means, substantially as described, whereby the removal of completed parts and the substitution thereof of blanks may be effected while the partially completed parts are being operated upon, substantially as and for the purpose shown. 3rd. As an improvement in the manufacture of watches and other mechanisms, an organization in which is combined a series of tools that by successive action are adapted to rough out and finally complete one of the parts of a mechanism, a series of devices which exceed said tools in number, and are each adapted to receive and hold one of the parts to be operated upon, means, substantially as described, whereby said parts while incomplete may be simultaneously brought into contact with said tools, means, substantially as described, whereby after each of said parts has been operated upon by one of said tools it may, if incomplete, receive the action of the next tool of the series, and means, substantially as described, whereby after a part has been completed it may be removed and replaced by a blank without suspension of action upon the partly completed parts, substantially as and for the purpose set forth. 4th. As an improvement in the manufacture of watches and other mechanisms, an organization in which is combined a series of tools that by successive action are adapted to rough out and finally complete one of the parts of a mechanism, a series of devices which are each adapted to receive and hold one of the parts to be operated upon, means, substantially as described, whereby said parts and tools may be simultaneously brought into contact, and means, substantially as described, whereby, after each of said parts has been operated upon by one of said tools, it may be caused to receive the action of the next tool of the series, substantially as and for the purpose specified. 5th. As an improvement in the manufacture of watches and other mechanisms, an organization in which is combined a series of tools that by successive action are adapted to rough out and finally complete a part of a mechanism, a series of devices which are each adapted to receive and hold one of the parts to be operated upon and which exceed said tools in number, means, substantially as described, whereby said parts and tools may be simultaneously brought into contact, and means, substantially as described, whereby after each of said parts has been operated upon by one of said tools, it may be caused to receive the action of the next tool of the series, substantially as and for the purpose shown.

No. 31,647. Manufacture of Scythes.

(*Fabrication des faux.*)

Henry H. Warren, Massena, N.Y., U.S., 22nd June, 1889; 5 years.

Claim.—1st. As an improved manufacture of scythes, a bar rolled to the desired configuration of cross-section for the cross-section of the scythe required, and cut into the desired lengths for scythe-blanks, substantially as described. 2nd. As an improved manufacture of scythes, a bar rolled to the desired configuration of cross-section for the cross-section of the scythe required, the said bar being furthermore cut diagonally into the desired lengths to give the length of blade required and "rough-out" the point and tang, the whole substantially as described.

No. 31,648. Reed Organ. (*Orgue.*)

Thomas G. Masson and Vincent M. Risch, Toronto, Ont. (assignees of Reginald Fry, Morristown, N.J., the assignee of Morris S. Wright, Worcester, Mass., U.S.), 22nd June, 1889; 5 years.

Claim.—1st. The combination, in a reed pan of a reed organ, of the separate tube or cell pieces A, C, D and E, arranged horizontally one above the other, as shown, and extending from front to back and from end to end of the reed pan, with a series of separate dividing boards B, C1 and D1, arranged horizontally above their respective air chambers, as shown, and extending from front to back and from end to end of the reed pan without a break or opening, and all securely fastened together in the relative positions described and for the purposes stated. 2nd. The combination and arrangement, in a reed organ, of a series of air chambers A, C, D and E, one above the other in the order named, a series of qualifying tubes N extending horizontally toward the front of the organ and securely fastened to the air exit ends of the air chambers pieces, and having communicating ports or openings with their respective air chambers but smaller than the qualifying tube, and a series of hinged stops N2, at the outer ends of the qualifying tubes N, at the front of the organ, all arranged relatively as described and for the purposes set forth. 3rd. The combination, in a reed organ, with three communicating air chambers and a single qualifying tube or pipe, and three reeds and the air chambers above the same, of a stationary out-off interposed or arranged between air chambers and reed chambers above described, and the air chambers next above the same, substantially as and for the purposes set forth. 4th. The combination and relative arrangement, in a reed organ, of a reed pan having its induction air ports and air valves thereof, and mechanism for operating the same located and arranged in the large wind-chest or chamber O on the back of the organ or reed pan, in combination with openings for the insertion and removal of the reeds with their respective plugs located and arranged in the front of the reed pan and between the horizontal qualifying tubes, as shown and described and for the purposes set forth. 5th. The combination, in a reed organ, of a series of reeds and induction air passages leading from a single large air chest O and arranged one above the other, of a

single long perpendicular or pendulum air valve P for the whole series, the lowest reed giving the lowest note, and its induction air port opened and closed by the part of the valve having the greatest swing or motion while the ascending scale of notes is produced by reeds, the air ports of which are closed and opened by the parts of the valve having a gradually decreasing motion, as and for the purposes set forth. 6th. The combination, in a reed organ, with the perpendicular air valve P and series of air induction ports *a*, of recessed seat 9, substantially as described. 7th. The combination, with the pendulum P, of pin *f*, guide pins *h*, operating spring *O*, and buffer *b*, substantially as and for the purposes set forth. 8th. The combination, with the lower end of valve P, of the adjustable screw stemmed metal eye P₃, substantially as and for the purposes set forth. 9th. The combination, with valve P, screw stemmed metal eye P₃, padded bell or knee crank P₁ and rod P₂, arranged in relation to each other as and for the purposes set forth. 10th. The combination, in a reed organ, of a series of reeds *d* arranged one above the other and located in respect to their respective air chambers, as described, with a series of horizontal qualifying tubes N extending from the ends of the air chambers toward the front of the organ, and arranged one above the other, with open spaces extending in between them from the front of the organ for the passage of the reeds, and with air exit openings N₁ and hinged stops N₂, all relatively arranged as and for the purposes stated. 11th. The combination, in a reed organ, with a series of reed air chambers F, G, H, I, J, K and L, M, arranged one above the other, and a series of reeds *d*, one reed each set of air chambers and inserted therein from the front of the organ and supported in horizontal positions in grooves formed in the sides of the air chamber pieces, of a series of plug pieces B, C, D, and E, arranged and securely fastened on the front side of the reed pan, and a series of qualifying tubes N secured to the front ends of the air chambers, and extending to the front of the organ with horizontal open spaces between them for the insertion and removal of the reeds, without opening the wind-chest or moving the air valves or mechanism for operating the same, substantially as shown and described.

No. 31,649. Method of Supplying Oil for Lamps at different levels and Apparatus for that purpose.

(*Mode d'alimentation de l'huile aux lampes à des niveaux différents et appareil pour cet objet.*)

Joseph B. Fenby, Sutton, Eng., 22nd June, 1889; 5 years.

Claim.—1st. The herein described method of supplying oil for lamps at different levels from a pipe supplied with oil at sufficient pressure to command the highest of the lamps by interposing between the supply pipe and each lamp or set of lamps at any level, a liquid pressure regulator which maintains the oil in the said lamp or set of lamps at a constant level, substantially as described. 2nd. For regulating the oil level in a lamp or set of lamps, a pressure regulator consisting of an oil vessel containing a cup or basin of mercury or other heavy liquid in which the end of an oil supply pipe is immersed to a depth adjusted to the pressure of the oil in the pipe relatively to that in the vessel, substantially as described. 3rd. A pressure regulator for oil lamps wherein an oil vessel containing a mercury cup is adjustably suspended from an oil supply pipe, the mouth of which pipe is more or less deeply immersed in the mercury, substantially as described. 4th. A pressure regulator for oil lamps wherein a mercury cup is suspended by a float in an oil vessel attached to an oil supply pipe, the mouth of which pipe is more or less immersed in the mercury according as the float rises or sinks, substantially as described. 5th. A pressure regulator for oil lamps wherein a plunger attached to a float in an oil vessel, by its greater or less immersion in mercury in the said vessel raises or lowers the level of the mercury in which the mouth of the oil supply pipe is immersed, substantially as described.

No. 31,650. Driving Gear for Table Machines for Sewing, Knitting and the like. (*Commande des machines sur tables pour coudre, tricoter et autres choses semblables.*)

Prosper A. Dohis, Paris, France, 22nd June, 1889; 5 years.

Claim.—1st. As driving gear for a table machine, the combination of the swinging pedals and levers A and B, arranged to actuate by silent feed a spindle C, the spindle E geared to c, the spring F fixed at its one end on the spindle E and at its other end to the wheel G, and suitable intermediate gear driving the pulley H. 2nd. As means of retarding or stopping the driving gear of a table machine, the knee plate K and spring M, in combination with a friction cone.

No. 31,651. Manufacture of Charcoal.

(*Fabrication du charbon de bois.*)

Owen Bowen, Alfred S. Tomkins and John Cobeldick, London, Eng., 22nd June, 1889; 5 years.

Claim.—The herein described process for the manufacture of charcoal rich in hydrogen, by subjecting carbonaceous material to the action of highly heated air mixed with hydrogen.

No. 31,652. Hydraulic Shaping Press.

(*Presse hydraulique à shéper.*)

Arthur E. Hobson, Isaac J. Steane and John L. Dalglish, Hartford, Conn., U.S., 22nd June, 1889; 5 years.

Claim.—1st. In a hydraulic shaping press, the combination, with a ram carrying a die holder, of a head block provided with a bearing surface and arranged above the die holder, whereby the edge of the blank may be clamped to the surface beneath it, substantially as described. 2nd. In a hydraulic shaping press, the combi-

nation, with a die holder, of an apertured head block provided with a bearing surface and arranged above the die holder, whereby the edge of the blank may be clamped to the surface beneath it, substantially as described. 3rd. In a hydraulic press, the combination, with a ram, of a die holder carried thereby, and an apertured plunger arranged to enter the die holder, substantially as described. 4th. In a hydraulic press, the combination, with a ram, of a die holder carried thereby, and another ram arranged above the die holder, substantially as described. 5th. In a hydraulic press, the combination, with a ram, of a die holder carried thereby, an apertured plunger above the die holder and a ram above the die holder, substantially as described. 6th. In a hydraulic press, the combination, with a ram, of a die holder carried thereby, an apertured plunger arranged to enter the die holder, and a ring surrounding the plunger, substantially as described. 7th. In a hydraulic press, the combination, with a ram, of a die holder carried thereby, an apertured plunger, and an annular ram surrounding said plunger, as and for the purpose stated. 8th. The combination, with a ram, of a die holder and a rotary cylindrical part having an inclined face and arranged beneath the cavity for die, substantially as described. 9th. The combination, with a ram, of a die holder and a wedge-shaped block mounted within the holder, substantially as described. 10th. The combination, with a ram, of a die holder supported thereby, a wedge shaped block mounted within the die holder and provided with a downwardly extending pin, and an outwardly extending lever arm or handle, substantially as described. 11th. The combination, with a ram, of a die holder carried thereby, dies adapted to fit said holder, a blank-holding plate arranged to fit within the die holder above the die, and a head block provided with a centrally apertured plunger that is in connection with a water supply, substantially as described. 12th. The combination, with a ram, of a die holder 13, dies 20 mounted therein, a plate holder 22, a head block, a plunger 31 supported thereby and formed with a bore 32, a ram 35 mounted about the plunger, and a water supply, substantially as described. 13th. In a hydraulic press, the combination, with a ram, of a die holder carried thereby, another ram arranged above the die holder, a water supply pipe common to both rams, branch pipes leading to the rams and stop cocks in said branch pipes, substantially as described. 14th. In a hydraulic press, the combination of a die holder, a blank holding die arranged to fit within the die holder, a seat for a packing flange formed on the die and over which an integral flange on the blank is adapted to project, the plunger and the joint packing device overlying said flange seat and whereby the joint is packed by the transmission of pressure through the medium of the liquid within the blank, all substantially as described.

No. 31,653. Spring Rocker Gear and Center Bearing Spring for Rockers, etc. (*Mécanisme à ressort de bascule et ressort de centre de suspension de bascule, etc.*)

Henry G. Portmann and William W. Portmann, St. Louis, Mo., U.S., 22nd June, 1889; 5 years.

Claim.—1st. Rocking mechanism consisting of axle or track platform 1, standards 5, rockers 7 and C spring 19, all formed, arranged and combined substantially as and for the purpose hereinbefore set forth. 2nd. The means for locking and unlocking the rockers consisting of connecting bar 10 and bell cranks 11, formed and combined with rocking mechanism, substantially as and for the purpose hereinbefore set forth.

No. 31,654. Rolls for Converting Old Rails into Angle Iron. (*Rouleaux pour convertir les vieux rails en fer carré.*)

Firman Nippert (assignee of Amaziah Vaughan), Terre Haute, Ind., U.S., 22nd June, 1889; 5 years.

Claim.—A pair of rolls for reworking old rails and stub ends into angle irons, the said rolls having passes of the shapes designated at 1, 2, 3, 4, 5, 6 and 7, substantially as shown and described.

No. 31,655. Motor Engine worked by Combustible Gas or Vapour and Air. (*Machine motrice à gaz combustible ou vapeur et air.*)

Friederick A. Hasenclever, Dusseldorf, (assignee of Edward Quack, Cologne), Germany, 24th June, 1889; 5 years.

Claim.—1st. In gas motor engines working with a four stroke cycle, the combination of two cranks E, F, on separate axes coupled together by gearing, whereby the one is made to revolve twice as fast as the other, the one crank being made to shift the fulcrum of a beam I or equivalent device through which the engine piston D imparts motion to the other crank, substantially as and for the purpose herein set forth. 2nd. In gas motor engines working with a four stroke cycle, the combination of two cranks E, F, on separate axes coupled together by gearing, whereby the one is made to revolve twice as fast as the other, the one crank being made to shift the fulcrum of a beam I or equivalent device through which the engine piston D imparts motion to the other crank, and the valve for admitting the combustible charge to the cylinder being actuated by the slower revolving crank F, substantially as herein described. 3rd. In a gas motor engine, the combination of two admission valves *a, b*, for the combustible charge having a space between them for containing a firing charge of the combustible mixture, the valve *b* nearest the cylinder being raised by the other valve, but being also free to rise and fall independently thereof, and having a small hole for the passage of a portion of the compressed cylinder charge into the space between the two valves, substantially as herein set forth. 4th. In a gas motor engine, an apparatus for producing combustible vapour from a combustible liquid and for mixing the same intimately with air, consisting of a plate *a* on to which the liquid is made to drip, such plate being enclosed in a casing *c* having a central opening through which air enters so as to pass in a thin film over the plate,

thus vaporizing the liquid, and in passing with the same through a very restricted passage round the edge of the plate becoming intimately mixed therewith, substantially as herein set forth. 5th. In combination with apparatus for vaporizing combustible liquid for use in gas motor engines, a supply pipe or conduit S, for the combustible liquid having an escape opening S₁ through which the liquid drips, which is raised above the bottom of the pipe or conduit, so that a layer of the liquid is always retained in the same, substantially as herein set forth. 6th. In combination with apparatus for vaporizing combustible liquid for use in gas motor engines, a heating apparatus for vaporizing the liquid on starting the engine, consisting of a perforated conduit or pipe *w* from which combustible liquid continuously issues on to a woven covering *w* of refractory fibre or wire, with which a current of air is brought in contact so as to enter into combustion therewith, substantially as herein described with reference to Fig. 19. 7th. In a gas motor engine, the combination, with a vaporizing apparatus for producing a mixture of combustible vapour and air for working the engine, of an escape pipe Z₁ for the products of combustion from the cylinder having a double seated valve Z₂ moved by hand, the products of combustion being made to escape into the atmosphere when the valve is seated on the seat Z₂, and to pass in contact with the vaporizing apparatus so as to heat it when the valve is seated on the seat Z₃, substantially as herein described with reference to Fig. 13.

No. 31,656. Apparatus for Electrolysing Bleaching Solutions. (*Appareil pour électrolyser les solutions de blanchiment.*)

Eugene Hermite, Charles F. Cooper and Edward J. Paterson, Dalston, Eng., 24th June, 1889; 5 years.

Claim.—1st. In an apparatus for electrolyzing bleaching solutions, a cell in which are suspended a number of platinum or platinized plates electrically connected to one terminal of a source of electricity, a series of zinc disks arranged to revolve between the platinum plates and connected electrically to the other terminal, stationary inclined scrapers adapted to cleanse said disks, pipes by which the solution is caused to circulate through said cell, and a pump with which said pipes are connected, substantially as described. 2nd. In apparatus for electrolyzing bleaching solutions, a cell partly divided by a longitudinal vertical partition into two compartments in each of which is journaled a horizontal shaft carrying a number of zinc disks between which are suspended platinum or platinized plates, all these plates being connected to one terminal of an electric generator, while all the zinc disks are connected to the other terminal, and have inclined scrapers bearing against their faces and bosses, substantially as and for the purpose set forth.

No. 31,657. Watch and Transparent Body.

(*Montre à caisse transparente.*)

La Société Armand Schwob et Frère, Strasburg, Germany, (assignee of Hugues Rime, Paris, France), 24th June, 1889; 5 years.

Claim.—1st. A watch with transparent body consisting of a glass disc B fixed on a central spindle S which runs in bearings carried by two fixed glass discs D, D, and imparts motion to the minute and hour hands *d, e* on the glass dial C, motion being imparted to the disc B by enclosed clockwork mechanism A, E, situated at any point of the metal rim G outside the disc B, substantially as herein described. 2nd. In combination with the disc B, spindle S, and minute and hour hands *d, e*, the toothed gearing *i, f, g, h*, for imparting motion from the minute hand to the hour hand, such gearing being of such small dimensions as to be concealed behind the central discs of the hands, substantially as herein described.

No. 31,658. Watch. (*Montre.*)

The New Haven Watch Company, Trenton, N.J., U.S., (assignee of Albert H. Potter, Geneva, Switzerland), 24th June, 1889; 5 years.

Claim.—1st. As an improvement in watches, a combined front movement-plate and case-centre which upon opposite sides is adapted to receive a bezel and a case-back, substantially as and for the purpose specified. 2nd. As an improvement in watches, a combined front movement-plate and case-centre, which is adapted upon its front side to receive a bezel, and upon its rear side to receive a rear movement-plate, and a case-back, substantially as and for the purpose shown. 3rd. As an improvement in watches, a combined front movement-plate and case-centre, which is adapted to receive upon its front side a bezel, and upon its rear side a rear movement-plate, and a case-back, and within its periphery is adapted to receive a case-pendant, substantially as and for the purpose set forth. 4th. As an improvement in watches, a combined front movement-plate and case-centre, which is provided within its front side with a peripheral rebate, and within its rear edge with a peripheral rebate, in combination with a bezel, a case-back and a rear movement-plate, substantially as and for the purpose specified. 5th. As an improvement in watches, a combined front movement-plate and case-centre, which is adapted to receive upon its front side a dial and bezel, and upon its rear side a rear movement-plate and a case-back, substantially as and for the purpose shown. 6th. As an improvement in watches, a combined front movement-plate and case-centre, which is provided within its front side with a peripheral rebate, and within its rear edge with outer and inner peripheral rebates, in combination with a bezel, a case-back and a rear movement-plate, substantially as and for the purpose set forth. 7th. As an improvement in watches, a combined front movement-plate and case-centre, which is adapted to receive upon its front side a dial and bezel, and upon its rear edge a rear movement-plate and a case-back, in combination with said parts and with a time train, substantially as and for the purpose shown and described. 8th. As an improvement in watches, a combined front movement-plate and case-centre, which is adapted to receive upon its front side a dial and bezel, and upon its rear edge a rear movement-plate and a case-back, in combination with said parts and with a time train, substantially as and for the purpose shown and described. 9th. As an improvement in watches, a combined front move-

ment-plate and case-centre which is adapted to receive upon its front side a dial and a bezel, and upon its rear edge a rear movement-plate and case-back, in combination with said parts, a time-train and a pendant, substantially as and for the purpose specified. 10th. A watch in which the front movement-plate and case-centre are constructed from one piece, and are combined with a dial, bezel, rear movement-plate, case-back pendant, and time-train, substantially as and for the purpose shown. 11th. As an improvement in watches, a combined movement-plate, case-back and case-centre constructed from one piece, substantially as and for the purpose set forth. 12th. As an improvement in watches, a combined movement-plate, case-back, and case-centre, constructed from one piece and having its inner edge adapted to receive a front movement-plate, substantially as and for the purpose shown and described. 13th. As an improvement in watches, a combined movement-plate, case-back and case-centre, constructed from one piece, and provided within its outer edge, with a rebate for engagement by a bezel, substantially as and for the purpose specified. 14th. As an improvement in watches, a combined movement-plate, case-back and case-centre, constructed from one piece, and having its inner edge adapted to receive a front movement-plate, case-back and case-centre, constructed from one piece, and provided within its outer edge with a rebate for engagement by a bezel, substantially as and for the purpose shown. 15th. As an improvement in watches, a combined movement-plate, case-back and case-centre, constructed from one piece, and having its inner edge adapted to receive a front movement-plate, and provided within its outer edge with a rebate for engagement by a bezel, and having a radial opening for the reception of a pendant, substantially as and for the purpose set forth. 16th. As an improvement in watches, a combined movement-plate, case-centre and case-back, constructed from one piece, and having its inner edge adapted to receive a front movement-plate, in combination with a front movement-plate which is adapted to fit over and engage with said edge, substantially as and for the purpose shown and described. 17th. As an improvement in watches, a combined movement-plate, case-centre and case-back constructed from one piece, and having its inner edge adapted to receive a front movement-plate, and provided with a rebated outer edge, in combination with a front movement-plate which fits over and engages with the rebated outer edge, and a bezel that engages with the rebated outer edge, substantially as and for the purpose specified. 18th. As an improvement in watches, a combined movement-plate, case-centre and case-back constructed from one piece, and having its inner edge adapted to receive a front movement-plate, and provided with a rebated outer edge, in combination with front movement-plate which fits over and engages with the said inner edge, a bezel that engages with the rebated outer edge, and a pendant which fits into and is secured within a radial opening in the periphery of said part, substantially as and for the purpose shown. 19th. As an improvement in watches, a combined movement-plate and case-centre constructed from one piece, and provided with an inner edge which is adapted to receive a front movement-plate, in combination with a front movement-plate which fits over and engages with said inner edge, and with a movement-train that is placed between and journaled within said parts, substantially as and for the purpose set forth. 20th. As an improvement in watches, a combined movement-plate and case-centre constructed from one piece, and provided with an inner edge which is adapted to receive a front movement-plate, in combination with a front movement-plate which fits over and engages with said inner edge, and a movement-train that is placed between and journaled upon said front movement-plate and extends radially to or near the edge of the same, substantially as and for the purpose shown and described. 21st. As an improvement in watches, a combined movement-plate and case-centre constructed from one piece, and having its inner edge adapted to receive a front movement-plate, and provided upon its upper edge with a regulator index scale, in combination with a front movement-plate which fits over and engages with said inner edge, a dial that is super-imposed upon said front movement-plate, and a regulator arm which projects from beneath said dial over said index scale, substantially as and for the purpose specified. 22nd. As an improvement in watches, a combined movement-plate and case-centre, constructed in one piece from base metal, and having the periphery of the case-centre portion covered by a shell of precious metal, which is super-imposed upon and secured to the same, substantially as and for the purpose shown. 23rd. As an improvement in watches, a combined movement-plate and case-centre, constructed in one piece from base metal, and having the periphery of the case-centre portion covered by a super-imposed plate of precious metal, in combination with a bezel and a case-back which are constructed from precious metal, and are fitted to and adapted to engage with said case-centre portion, substantially as and for the purpose set forth. 24th. As an improvement in watches, a combined movement-plate, case-centre, and case-back, which are constructed in one piece from base metal, and have the outer surfaces of the case-centre and case-back portions covered by a super-imposed and attached plate of precious metal, substantially as and for the purpose shown and described. 25th. As an improvement in watches, a combined movement-plate, case-centre and case-back, which are constructed in one piece from base metal, and have the outer surfaces of the case-centre and case-back portions covered by a super-imposed and attached plate of precious metal, in combination with a bezel which is constructed from precious metal, and is adapted to engage with said case-centre portion, substantially as and for the purpose specified. 26th. As an improvement in watch cases, a case-centre provided with a radial rectangular opening, in combination with a pendant which has its inner end fitted into and through such opening, and headed down upon the inside of said case-centre, substantially as and for the purpose shown. 27th. As an improvement in watch escapements, a vibratable lever which at one end is provided with two locking faces that are formed upon lines that are substantially concentric with its pivotal centre, and two impulse faces that are formed upon lines which are substantially radial thereto, in combination with an escape pin that is adapted to revolve around the centre, and to engage alternately with the locking and impulse faces of said lever as the same vibrates upon its pivotal bearing, substantially as and for the purpose set forth. 28th. A watch escapement composed in part of an escape pin which is adapted to revolve around a centre, in combination with a vibratable lever that is provided within one end with two pairs of locking and im-

pulse faces which are alternately engaged by the escape pin, whereby, at each double vibration of said lever, said escape pin will make one complete revolution around its centre, substantially as and for the purpose shown and described. 29th. As an improvement in watch escapements, a pivoted lever which, by means of a vibratory balance, is adapted to be oscillated upon a pivotal bearing, and is provided at one end with two pairs of locking and impulse faces, and means whereby said escape pin may be given a step-by-step rotation in one direction, and such motion may be transmitted to time indicating mechanism, substantially as and for the purpose specified.

No. 31,659. Valve for Steam Engines.
(*Soupape pour machines à vapeur.*)

Walter J. Allen and Lawrence J. Hickey, Springfield, Ohio, U. S., 24th June, 1889; 5 years.

Claim.—1st. A cylindrical valve having a reduced portion about which is formed an exhaust chamber, circular ports at each end of said valve in the periphery thereof, and a longitudinal passage connecting said ports through the reduced portion, said valve being formed without lap between said ports and the exhaust chamber, substantially as specified. 2nd. A balanced valve, substantially as set forth, having a longitudinal passage provided at either end with small openings or ports adapted to register with the main cylinder ports, said valve being formed without exhaust lap between the small openings or ports and the exhaust chamber in said valve, whereby the terminal pressure of each piston stroke is transferred from the front to the back of the piston to produce an automatic cushion, substantially as set forth. 3rd. A cylindrical balanced valve provided with piston-shaped ends adapted to open and close the main ports, as described, the reduced central portion adapted to form the exhaust chamber with which the cylinder ports are adapted to register as the valve moves in either direction, premature exhaust ports in said piston ends, connected together through said reduced central portion, said premature exhaust ports being adapted to register with the main cylinder ports without lap between the premature exhaust ports and the main exhaust ports, substantially as specified.

No. 31,660. Boot and Shoe. (*Chaussures.*)

Joseph Godin, Montréal, Qué., 25th June, 1889; 5 years.

Résumé.—Dans l'empeigne d'une chaussure, la combinaison des patrons A et B avec les lignes de couture à A', A'', tel que décrit et pour les fins indiquées.

No. 31,661. Hip Belt. (*Sangle.*)

William H. Bevinger, Middleton, Ohio, U. S., 25th June, 1889; 5 years.

Claim.—1st. A hip belt for trousers, consisting of an inner and an outer strip of material, the inner strip having button holes produced therein, and the outer strip being attached to the inner strip transversely between the button holes, substantially as shown and described. 2nd. A hip belt for trousers, consisting of two parallel strips of elastic material, the inner strip being provided with a series of button holes produced therein, and the outer strip attached to the inner strip transversely between the said button holes, and a guide strip attached to the belt at the centre, all combined for operation substantially as shown and described. 3rd. In a hip belt for trousers, the combination, with an inner strip of material, provided with a series of button holes produced therein, of an outer cover strip of equal length with the inner strip, and attached to the inner strip between the button holes to form a series of pockets, and clamps secured to the outer ends of both strips and adapted to slide upon the body of the belt, substantially as described, whereby the belt may be lengthened or shortened to terminate at the forward suspender buttons of the waist band, as set forth. 4th. In a hip belt for trousers, the combination, with an inner strip of material of less length than the waist band, and provided with a series of button holes produced therein, of an outer cover strip of equal length with the inner strip and attached to the inner strip between the button holes to form a series of pockets, a guide strip rigidly secured to the centre of the belt transversely of the same, a cord attached to the belt near its ends, and a clip attached to said cord, and clamps secured to the outer ends of both strips and adapted to slide upon the body of the belt, substantially as shown and described, whereby the belt may be lengthened or shortened, as set forth.

No. 31,662. Railway Spike and Method of Making the Same. (*Chevillette et mode de fabrication des chevilletes de chemins de fer.*)

Thomas A. Davies, New York, N.Y., U. S., 25th June, 1889; 5 years.

Claim.—A railroad spike, formed substantially as shown and described for the purposes set forth.

No. 31,663. Car Truck. (*Châssis de char.*)

Frank E. Pettengill, Chatham, N.Y., and Thomas F. Chappell, Pawtucket, R.I., U.S., 25th June, 1889; 5 years.

Claim.—The railway truck herein shown and described, consisting of the side bars J provided with outer journal boxes, and bars K, N₂, intermediate cross-bars L, M and cross-bars H, each provided with a journal-box, in combination with the axles A having reduced ends B, and the sleeves C, and wheels D secured to said sleeves, ends of said sleeves running in journal-boxes at each side of the wheels, substantially as described.

No. 31,664. Manufacture of Hollow Skew Backs. (*Fabrication des culs de sommiers creux.*)

William Lenderoth, Deseronto, Ont., 25th June, 1889; 5 years.

Claim.—1st. In skew-backs made from clay or clay mixtures, I claim making the recess for the beam flange in such manner that the

core of material of the same composition as the skew-backs is expressed from the machine, etc., remain as part of the skew-back until after drying and burning processes are completed, as herein described and for the purpose specified. 2nd. In skew-backs made from clay or clay mixtures, I claim the drying and burning of the skew-backs with a core protecting and supporting the part of the skew-back which covers the flange of the iron beam, and which core is removed after the burning process, as herein described and for the purpose specified. 3rd. I claim the knife D used in connection with dies in a machine expressing a plastic material to be afterwards cut, dried, and burned in a kiln, and used as a building material, as herein described and for the purpose specified.

No. 31,665. Method of Drying Porous Hollow Ware. (*Mode de séchage des ustensiles creux poreux.*)

William Lenderoth, Deseronto, Ont., 25th June, 1889; 5 years.

Claim.—In combination with a drying room arranged to have ascending currents of warm air, and used for drying composition of clay previous to burning them to produce a building material, I claim the pallets made of similar section of the blocks, but with the openings slightly less and the external dimensions slightly greater than the blocks to be dried, as herein described and for the purpose specified.

No. 31,666. Apparatus for Regulating the Flow of Plastic Mixtures of Clay, Saw-dust and other Ingredients from Presses. (*Appareil pour régler le cours des mélanges de terre, bran de scie et autres ingrédients plastiques sortant des presses.*)

William Lenderoth, Deseronto, Ont., 25th June, 1889; 5 years.

Claim.—I claim in a machine used to express plastic mixtures of clay and saw-dust and similar mixtures for the production of a building material, the friction blocks B, B, B, placed inside the mouth-piece of the machine and adjusted to regulate the flow of the plastic material from the machine, as hereinbefore described and for the purpose specified.

No. 31,667. Manufacture of Flat Blocks and Slabs from any Clay or Clay Mixture. (*Fabrication des blocs et barres avec toute sorte de terre ou mélange de terre.*)

William Lenderoth, Deseronto, Ont., 25th June, 1889; 5 years.

Claim.—1st. In a machine used for expressing in a plastic condition clay or clay mixtures, for the purpose of producing a building material, I claim the cutting knives A, A', A'', which sever the expressed column into two or more divisions, as herein described and for the purpose specified. 2nd. I claim producing thin slabs made from clay or clay mixtures expressed in a plastic condition from a machine by severing the column into two or more divisions, so that, after being thus severed, they flow on together and are treated as if such severance had not been made, as herein described and for the purpose specified.

No. 31,668. Construction of Casks or Barrels and Box Barrels or Packages and Machinery or Mechanism used in the Manufacture of Barrels and Packages. (*Fabrication des futailles ou barils et des barils-boîtes ou paquets et machinerie employée dans la fabrication des barils et des boîtes.*)

Samuel Wright, Glasgow, Scotland, 25th June, 1889; 5 years.

Claim.—1st. In a cask or barrel trussing, crozing and finishing machine, the traversing of the end frame A₁, or frames A, A₁, by horizontal screw spindles C, C₁, and nuts A₂ rotated by spur gearing, consisting of a spur wheel c₁, on the ends of each spindle C, C₁, both in gear with an intermediate spur wheel c₂, working loosely on a central spindle c₃ or F between them, motion being primarily transmitted to the gearing from open and cross-reserving bands and pulleys from any adjacent rotating shaft, substantially as and in the manner herein described. 2nd. In a machine for trussing, crozing and finishing barrels or box-barrels, the rotating of these by a central hollow shaft F, on which is mounted a boss with movable rack radial segmental arms F₁, actuated and adjusted by a central spur wheel F₂, on a shaft F₃ passing out through the hollow driving shaft F, carried and driven in a double stock-head frame D, D₁, at one end of machine, and actuated by belt and pulley gearing, substantially as and in the manner herein described. 3rd. In a machine for trussing, crozing and finishing barrels or box-barrels, the mounting of an oscillating frame on the driving shaft G in the bed plate B₁ outside each of the two end trussing frames A, A₁, and carrying on their upper ends two horizontal rotating spindles E, with bosses e on their projecting ends, and with saws e₁ and cutters e₂, e₁, with guide discs e₃ for projecting within the ends of the barrel or box-barrel to cut the ends of the staves Z or Z₁ to the proper length, and chime and groove them, said rotating cutting spindle E being driven by belt and pulley gearing, and moved longitudinally by hand screw spindles e₄, substantially as and in the manner herein described. 4th. In a round cask or barrel trussing, crozing and finishing machine, the chiming, crozing and finishing of the ends of barrels while being held stationary by lance or edge cutters and knives mounted on radiating expanding cross arms and spindles in a boss on a hollow spindle rotated by bands at each inner end of the machine in the axial line of the barrel, said arms being formed with rack teeth working into a pinion or pinions on a spindle passing through the hollow driving spindle of boss, and actuated by hand, so as to be shifted radially within the barrel, to chime and croze it as the cutters and arms are rotated, substantially as and in the manner herein described.

No. 31,669. Belt Punch. (*Emporte-pièce à courroie.*)

Hugh L. T. Overbery, Summerville, Ga., U.S., 25th June, 1889; 5 years.

Claim.—A machine for punching holes in leather consisting of a frame 2 mounted on the base 3, having a bearing block 18 and arms 4, 5, with a brace rod 11 passing through the arms 4, 5 and into the frame 2, and riveted thereto, and having an extension provided with a stop pin 12, in combination with the vertically reciprocating rod 1 having a spring 6, a screw threaded end 14, securing nut 15 and punch 16, and the lever 7 with slotted end 10, substantially as described.

No. 31,670. Snow Plow. (*Charrue à neige.*)

John W. Haughwout, Omaha, Neb., U.S., 25th June, 1889; 5 years.

Claim.—1st. In a rotary snow plow, the combination of a series of blades rotated by a common shaft sloping from their forward edges outward and backward in a double curve, substantially as described. 2nd. In a rotary snow plow, a series of blades rotated by a common shaft sloping from their forward edges outward and backward in a double curve, in combination with a series of reversible cutting edges extended forward to enter the snow at an angle or with a boring movement, substantially as described. 3rd. In a rotary snow plow, a series of blades rotated by a common shaft, in combination with wings hollowed out inwardly and rearwardly, and forming an extension of the case upwardly and forwardly, whereby the snow is directed towards one side or the other of the track and discharged at a sufficient distance therefrom, substantially as described. 4th. In a rotary snow plow, a series of blades rotated by a common shaft sloping from their forward edges outward and backward in a double curve, in combination with an enclosing cylindrical case, substantially as described. 5th. In a rotary snow plow, a series of blades rotated by a common shaft, in combination with a cutting apron clearing the rails of the track at its front edge and resting thereon at its rear, and arched on its under side between the rails.

No. 31,671. Snap-Link. (*Chaînon à ressort.*)

Vincent A. Coleman, Port Hope, Ont., 25th June, 1889; 5 years.

Claim.—A snap-link consisting of a body A of the form specified, and a spring B connected to the body A, as set forth and shown.

No. 31,672. Attachment for Lawn Mowers.

(*Disposition aux faucheuses de pelouses.*)

Henry Peterson, Berkeley, Cal., U.S., 25th June, 1889; 5 years.

Claim.—The combination, with the lawn mower, of the rearwardly projecting longitudinally adjustable hooks secured to the sides thereof, of the tray or grass receptacle having the runner on its under side, and a concave front end to fit over the ground roller of the mower, and forwardly projecting arms detachably secured to the sides of the tray and having each two eyes arranged as described, and adapted to be engaged by the hooks secured to the mower, as specified.

No. 31,673. Belt Fastener. (*Agrafe-courroie.*)

William G. Avery, Cleveland, Ohio, U.S., 25th June, 1889; 5 years.

Claim.—The detachable sheet metal belt fastener consisting of the piece A having a T-slot, and the opposing piece B having a T-head formed integral therewith, both pieces being provided with inwardly projecting teeth and rivet holes, substantially as shown.

No. 31,674. Convertible Suspending Chair.

(*Fauteuil hamac convertible.*)

Martin E. Schutt, Chesaning, Mich., U.S., 25th June, 1889; 5 years.

Claim.—1st. The convertible suspending chair comprising the pendent rods, the central section supported by said rods, the front section attached to the center section by hinges at the lower side, and the projections and notched bars at the upper side, the rear section hinged to the center section the collars with set screws on the vertical rods and the oblique rods jointly attached to said collars and the rear section, substantially as set forth. 2nd. The chair sections hinged together, the pendent rods supporting the center section, the sliding collars on said rods and their set screws, the rods jointly attached to said collars and to the rear sections, and springs elastically suspending the whole, and substantially as set forth. 3rd. The combination of the convertible chair sections hinged together, the upper cross pieces, the series of vertical springs between the cross pieces and attached thereto at their ends, the pendent rods attached to the lower cross piece and suspending the center section, the sliding collars on said rods and their set screws and the oblique rods jointly attached to the collars and to the rear section of the chair substantially as set forth.

No. 31,675. Cut-off and Reversing Gear for Engines. (*Appareil de déteinte et de renversement de marche pour les machines.*)

Charles Fox, Stamford, Conn., U.S., 26th June, 1889; 5 years.

Claim.—1st. In a cut-off and reversing mechanism, the combination, with the valve, valve stem, eccentric and eccentric rods, of an arc-shaped link, a block connected to the valve stem upon which said link slides, a reach rod connected to the link rods 25, pivoted to the opposite ends of the link and each pivoted to one of the eccentric rods, and rocker arms pivoted to a fixed point and to the eccentric rods, and rods 25 at their pivotal points to each other, substantially as set forth. 2nd. The combination, with the eccentric rods, an arc-shaped link and link block 17, of rods 25 pivoted to opposite

ends of the link and to the eccentric rods, and rocker arms pivoted to a fixed point and to the eccentric rods, and rods 25 at their pivotal points to each other. 3rd. The combination, with the eccentric rods, rods 25 and rocker arms pivoted to a fixed point and to the eccentric rods, and rods 25 at their pivotal points to each other, of a link to the opposite ends of which rods 25 are pivoted and which is an arc of a circle, of which the pivotal point of the rocker arms, eccentric rods and rods 25 is the center. 4th. The combination, with the eccentric rods, an arc-shaped link having saddle 19 and link block 17, of rods 25 pivoted to opposite ends of the link and to the eccentric rods, rocker arms pivoted to a fixed point and to the eccentric rods, and rods 25 at their pivotal points to each other, and a reach rod pivoted to the saddle. 5th. The combination, with the eccentric rods, an arc-shaped link and link block 17, of rods 25 pivoted to the opposite ends of the link and to the eccentric rods, rocker arms pivoted to a fixed point and to the eccentric rods, and rods 25 at their pivotal points to each other, a reach rod pivoted to the link, a valve and a valve stem connected to link block 17.

No. 31,676. Can Opener.

(*Machine à ouvrir les boîtes métalliques.*)

Josiah F. French, Philadelphia, Penn., U.S., 26th June, 1889; 5 years.

Claim.—In a can opener in combination with a pointed blade attached to a handle, a guide parallel to, and a short distance from, the said blade, and extending substantially the whole length of said blade, and side pieces between the said blade and said guide, said side pieces being constructed concave, and a projection located at the fixed end of the blade extending beyond and at an angle to the plane of the blade, substantially as shown and described.

No. 31,677. Coin Receptacle and Register.

(*Réceptacle et compteur à monnaie.*)

Elwood Headley and William G. Horton, New York, N.Y., U.S., 26th June, 1889; 5 years.

Claim.—1st. In a coin receptacle, the combination, with a series of concentric dials representing different values, of the dogs E, E' engaging with said dials, the pivotal plates or guards F, F' and the slide H, substantially as described. 2nd. The combination, with the concentric dials representing different values and having notched flanges, of the dogs E, E', the pivotal plates or discs having tail pieces, and the slide H, having head h and notched cross bar g', substantially as described. 3rd. In a coin receptacle, the combination, with the registering dials and the dogs E, E' engaging therewith, of the plates or discs formed with the flanges i and tail pieces d, and the slide H having the head h and notched bar g', said parts being so arranged as to be conjointly operative only when the space between the head h and flange i is occupied by an independent body such as a coin of given diameter, substantially as described. 4th. In a coin registering or counting apparatus, the combination of a registering dial a dog E, whereby the same is moved step-by-step, a pivotal plate or disc to which said dog is attached having a flange i on its face and a tail piece d, and a slide H having a head h and notched cross piece g' to control the movement of the parts when a coin is placed between the head of the slide and the flange on the disc, substantially as described. 5th. In a registering apparatus, the combination of the dials comprising the plate D having the bent lugs and the interiorly and exteriorly flanged rings D¹, D², substantially as described.

No. 31,678. Plow Colter. (*Coutre de charrue.*)

Levi Walker, Delhi, Ont., 26th June, 1889; 5 years.

Claim.—A reversible plow colter comprising a flat blade B having a convex cutting edge b and a concave cutting edge b¹, meeting below at a point b² and joined above by a wide top provided with straight shoulders or edges b¹¹, b¹¹¹, and provided with bolt holes B¹, B¹¹, B¹¹¹, said blade adapted to be secured to a shank A, substantially as set forth.

No. 31,679. Snow Plough. (*Charrue à neige.*)

Orange Jull, Orangeville, Ont., 26th June, 1889; 5 years.

Claim.—1st. In a snow-plough, the excavating and lifting cone E placed in an inclined position and obliquely to the vertical and horizontal planes so that its apex points forward and downward and laterally, substantially as described. 2nd. In a snow-plough, a cone having curved blades which are narrower toward the apex of the cone than toward its base, substantially as described. 3rd. In a snow-plough, the cone E provided with curved scoop-shaped blades for lifting and throwing the matter excavated by centrifugal force. 4th. In a snow-plough, the inclined cone E provided with curved scoop-shaped blades f for lifting and throwing the matter excavated by centrifugal force, as described. 5th. The cone E having curved lifting-blades f, the curvature of said blades being greater toward the apex than toward the base of the cone, as described. 6th. The combination of the cone E and its blades, with the hood D, having openings l, o, and gates m, p, substantially as and for the purpose described. 7th. The combination, of the cone E, and its lifting-blades, with the hood D, having opening o, door p, and top deflector q, substantially as and for the purpose specified. 8th. The cone E having scooped blades f that are narrower toward the apex than toward the base of the cone, as and for the purpose described. 9th. The hood D of the snow-plough, the same being provided with the downwardly and backwardly inclined front shield r, and overhanging lip s, as and for the purpose specified. 10th. In a snow-plough, the hood D having inclined front shield r, snow-discharge opening o, and deflector q, said deflector being connected to said shield, as described. 11th. A rotary snow-plough consisting of the cone E, having a series of scoop-shaped curved blades, said cone being located to have its apex point downward and forward, said blades forming slicing-knives and lifting-chutes, substantially as and for the purpose described. 12th. The

combination of the rotary cone E, having slicing and lifting blades *f*, with a hood D having oblique-edged bottom plate *t*, opening *l*, and door *m*, as and for the purposes specified. 13th. The combination, with the cone E which is placed diagonally downward and forward across the forward end of the truck, of blades *f* carried by said cone and arranged to extend from side to side transversely across the face of the truck, as specified. 14th. The combination of the hood D having discharge-opening, with a revoluble cone E, and blades *f* carried by said cone, said blades being arranged so that they will assume positions transverse to the track, as specified.

No. 31,680. Feed Heating and Water Circulating Apparatus. (*Réchauffeur d'aliments et calorifère à eau.*)

Robert Fraser, Liverpool, Eng., 26th June, 1889; 5 years.

Claim.—1st. In a feed heater and circulator combined, the pipe G in the furnace or heating chamber connected at one end to the feed pump or bottom of the boiler by a valve Q, and to the upper part of boiler by a valve J, and arranged with safety valve I also the peculiar automatic feed, and circulating valve E also, the peculiar automatic shut-off valve H or H₁, also the short-cut pipe G₂. 2nd. The reversible filter F united to the feed pump and bottom of boiler on one side, and heater G or upper part of boiler on other side.

No. 31,681. Drag Sawing Machine.

(*Scierie à scie traînante.*)

Garretton A. Hughes, Ashland, Ohio, U.S., 26th June, 1889; 5 years.

Claim.—1st. The combination, with an elongated frame having legs at one end, the opposite end of said frame adapted to rest on the tree or log, of a crank-wheel journaled in said elongated frame, a balanced beam mounted on the crank-wheel shaft, a saw having a sliding movement on said beam, a pitman connecting the saw and crank-wheel, and gearing for rotating the crank-wheel, substantially as set forth. 2nd. The combination, with an elongated frame having a rigid leg and an adjustable leg at one end, the opposite end of said frame being constructed to rest on the log, of a crank-wheel, a beam pivotally secured on the crank-wheel shaft, a weight attached to the beam on one side of said shaft, a saw mounted in bearings on the beam on the opposite side of the shaft, a pitman connecting the saw, and crank-wheel and gearing for operating the crank-wheel, substantially as set forth.

No. 31,682. Furniture Drawer.

(*Tiroir de meuble.*)

Dwight C. Clapp, Charles E. Rigley, David M. Estey and The Estey Manufacturing Company, Owosso, Mich., U.S., 26th June, 1889; 5 years.

Claim.—A drawer having the upper edges of its end inclined from the front to the back, and having upwardly-projecting shoulders on the inclined edges, the height of which is equal to the highest point of the inclined edge, substantially as described.

No. 31,683. Medical Compound.

(*Composition médicale.*)

John F. Lindgren and Andrew Eiken, Cookston, Minn., U.S., 26th June, 1889; 5 years.

Claim.—The herein described medicinal compound composed of water senega (Polygala senega), root castor oil, cooking soda, sirup salt peter lemon juice, blue-berry juice, (Vaccinium corymbosum), red pepper, and essence of peppermint, compounded in the proportions substantially as set forth.

No. 31,684. Fire Grate. (*Grille de foyer.*)

Hammond P. Evans, (co-inventor with John H. Allyn), Whitesborough, N.Y., U.S., 27th June, 1889; 5 years.

Claim.—The combination of the frame A, the journaled grate C having lug F, the cut-off D having cam G and lug H, and the pawl I to engage said lug, substantially as described.

No. 31,685. Saw. (*Scie.*)

Warren Bundy, Minnesota, Minn., Gilbert Montague, Chicago, Ill., and Otto Troost, Minnesota, Minn., U.S., 27th June, 1889; 5 years.

Claim.—The cutting teeth of a saw having their cutting or front edges set out to the right and left beyond the plane of the side of the saw blade, substantially as shown.

No. 31,686. Motor. (*Moteur.*)

Annie W. Pearce and Laura H. Johnson, Greenwood, S.C., U.S., 27th June, 1889; 5 years.

Claim.—1st. A spring motor consisting of a casing, spring-actuated gearing mounted therein, one of the gear shafts projected at each side of the casing, provided at one end with a disk J having arms adapted to detachably connect the motor with the drive-wheel of the machine to be driven, a ratchet wheel at its opposite end, and an adjustable pawl for engaging the same, substantially as shown and described. 2nd. The combination, with the casing A, the shaft E, the intermediate gearing for operating it, and the ratchet wheel B mounted thereon on the adjustable pawl F, the spring G and the diagonally adjustable nut I operating upon the spring G, substantially as and for the purposes specified. 3rd. The combination, with the shaft E, the intermediate gearing for operating it, the ratchet and pawl mechanism connected therewith and operated as specified, of the disk J secured upon the inner projecting end of said shaft,

provided with projecting arms J₁, J having boxes L at their outer ends, said boxes provided with adjustable elastic bearing blocks, whereby said arms are detachably secured to the rim of the drive-wheel, substantially as and for the purpose hereinbefore described.

No. 31,687. Bundle Carrier for Harvester Binders. (*Porte-gerbe pour moissonneuses-lieuses.*)

The Massey Manufacturing Company, (assignee of William F. Johnston and John C. Campbell), Toronto, Ont., 27th June, 1889; 5 years.

Claim.—1st. In a harvester, a bundle-carrier pivoted on a frame, the inner side of which is hinged to the frame of the harvester below the binding-table, and the outer side is supported by a ground wheel in combination with mechanism by which the bundle-carrier is held in a horizontal position and is tilted when required, substantially as and for the purpose specified. 2nd. The bundle-carrier A pivoted on the trunnions H and J, which are fixed to the frame formed by the angle-bar B and bar F, the said frame being supported at its outside by the wheel E and hinged at its inner side to the harvester-frame G in combination with the bar K, jointed bar O, crank-arm M and rod P, substantially as and for the purpose specified. 3rd. The bar B hinged at a to the frame C, and having a crank formed at its other end from which the axle D of the wheel E extends, in combination with the bars F hinged at b to the frame C, the brace G, trunnions H and J, and carrier A, substantially as and for the purpose specified.

No. 31,688. Anti-friction Journal.

(*Tourillon sans frottement.*)

Francis T. Wheeler (assignee of William S. Sharpneck), Chicago, Ill., U.S., 27th June, 1889; 5 years.

Claim.—1st. The combination, with a timber A, of a car truck, an equalizing bar B, a spring C between the two and the journal box thereof, of a reversed pedestal E supported by the journal and receiving the timber A, and the equalizing bar B, substantially as described. 2nd. The combination, with the timber A, of a car truck, an equalizing bar B, a spring C between the two, and the journal box thereof, of a reversed pedestal E supported by the journal and receiving the timber A, and equalizing bar B, and the saddle D embracing said timber, and forming a guide for said pedestal, substantially as described. 3rd. The combination, with a timber, of a car truck and the journal box thereof, and a saddle fastened to the timber, of a yoke receiving the saddles and supported on a roller resting on said journal box; and constructed to allow the timber to rise and fall therein under the pressure of the car, substantially as described. 4th. The combination, with a journal box having a recessed support, as the bracket H, having an inwardly projecting rib, of a roller resting in said support and having a groove receiving said rib, and supporting a pedestal having a downwardly projecting rib fitting into the groove in said roller, substantially as described. 5th. The combination, with the shell I, of the spider M, the bearing block secured in the hub *m* thereof, the cap P and a fastening device as the wedge Q, substantially as described. 6th. The combination, with the saddle I, and spider M having a threaded aperture in its centre, of the bearing block N having a threaded and slotted shank, a cap P and the wedge Q, substantially as described. 7th. The combination, in a journal box, and with the axle and shell thereof, of a bearing block having a wearing block set therein, and provided with a groove partly formed in said wearing block, and a ball running in said groove, substantially as described.

No. 31,689. Gas Engine. (*Machine à gaz.*)

Newton Rogers and James A. Wharry, Terre Haute, Ind., U.S., 28th June, 1889; 5 years.

Claim.—1st. The combination, with a gas engine, a main shaft thereof, a worm thereon, a wheel gearing with said worm rigidly secured to a way shaft, an exhaust cam on said way shaft, and a sleeve adapted to move longitudinally on, and revolve with the way shaft, an inlet valve cam on said sleeve, and revolving bearing in which the ends of the way shaft are secured, and in which the sleeves move longitudinally in the bearings and on the way shaft upon a change of speed of said engine, substantially as described. 2nd. In a gas engine, the combination of a way shaft operated from the main shaft, revolving bearings in which the ends of the way shaft are secured, a sliding sleeve on said way shaft and in said revolving bearings, an exhaust valve cam on the way shaft, inlet cam on the sleeve, a cap secured to the end of the revolving bearings, and an igniter cam on said cap, substantially as described. 3rd. In a duplex gas engine, the combination, with a main shaft, a way shaft operated thereby, revolving bearings in which the ends of the way shaft are secured, a sleeve sliding on said way shaft and in said revolving bearings, exhaust cams on the way shaft, inlet cams on the sleeve, caps secured to said bearings containing springs bearing on the ends of the sleeve, igniter cams on said caps, and connections with a governor for sliding said sleeve independently of the way shaft, whereby the positions of the inlet cams may be altered without altering the positions of the exhaust cams, substantially as described. 4th. In combination with the two gas engines, connections therewith, and with a single crank pin, and crank shaft, a way shaft operated by this shaft, two exhaust cams on the way shaft, a sleeve on the way shaft, two inlet cams on this sleeve, the distance between them being less than the distance between the respective inlet valve, levers operated by said cams, means for shifting the sleeve lengthwise as the speed of the engine varies, whereby the inlet valve of one engine is rendered inoperative in advance of the other, revolving bearings and caps secured to the way shaft in which the sleeve slides having igniter cams thereon, and operating a reciprocating electric igniter, substantially as described. 5th. A gas engine cylinder provided with heat radiating surfaces surrounded by a water jacket, whereby the cooling contact with the air circulating water is increased, substantially as described. 6th. In combination with the two cylinders, of a duplex

gas engine, inlet valves therefor, connections between said valves and a carburetor exhaust valve, connected with the cylinders, and connections therewith, and with a jacket surrounding the air suction pipe of the carburetor, a common outlet from said jacket, and a cold air valve in said suction pipe for varying the temperature of the heated air to the carburetor, and controlling the temperature of the charge admitted to the cylinders, air valves connected with the engine inlet, substantially as described. 7th. In a gas engine ignitor, the combination of a reciprocating spring held-rod, a rocker-arm secured thereto, and vibrating electrode attached to said rocker-arm, and a fixed electrode secured to the cylinder, substantially as described. 8th. In combination with the main shaft of a gas engine, a worm wheel on said shaft gearing with a worm wheel on a way shaft which operates the engine valves, a centrifugal governor on the main shaft, bell crank connections between the governor sleeve, and a sleeve surrounding the way shaft and revolving with it but capable of sliding longitudinally thereon, and a cam rigidly secured to said sleeve for operating the engine inlet valve, substantially as described. 9th. In combination with the fly-wheel of a gas engine, a friction wheel mounted adjustable, and a speed pulley on a dynamo shaft, said friction wheel being adapted to transmit motion from the fly-wheel to said speed pulley, and to be thrown out of gear by movement in said slot, substantially as described.

No. 31,690. Apparatus for Raising Quick Sand. (*Appareil pour enlever le sable vif.*)

Henry Stoltze, Sr., Maintoroc, Wis., U.S., 28th June, 1889; 5 years

Claim.—1st. The combination of the tapered case having the outwardly opening valves at its upper end, the rod revoluble in the case, and the boring-bit attached to the said rod and arranged in the lower end of the case, substantially as described. 2nd. The combination of the tapered case having the valves at its upper end, the rod revoluble in the case and having the boring-bit at its lower end, means substantially as set forth to rotate the said rod, the plate N pivotally connected to the said rod, and the elevating-rod attached to said plate, substantially as described. 3rd. The combination, in apparatus for raising quick-sand, of the case having the valves at its upper end, the rod G extending through an opening in the upper end of said case and revoluble therein, said rod having the collar I adapted to bear under the top of the case, and the opening K above said collar, the boring-bit attached to the lower end of the rod and arranged in the bottom of the case, and the pin or key adapted to be inserted in the opening K, substantially as described. 4th. The combination of the tapered case having the outwardly-opening valves at its upper end, the rod revoluble and longitudinally movable in the case, and the boring-bit attached to the rod, and arranged in the lower end of the case, substantially as described.

No. 31,691. Tablet for Indelible Ink Marking. (*Tablet pour marquer à l'encre indélébile.*)

William A. Wesd, Chicago, Ill., U.S., 28th June, 1889; 5 years.

Claim.—1st. A tablet for the purpose described, having its body portion provided with ribs, and having a removable band adapted to pass over the ribs and snap upon the tablet-body, substantially as set forth. 2nd. The herein described tablet A, comprising the sheet-metal bottom having a bottom *a*, for the purpose set forth, a cover, and a set of longitudinally arranged compartments of different depths, substantially as described. 3rd. The tablet provided with a removable band having spring edge portions, as and for the purpose described.

No. 31,692. Machine for Pulling Hairs from Skins of Fur Animals. (*Machine à débouurrer les peaux.*)

Emil Schroeder, San Francisco, Cal., U.S., 28th June, 1889; 5 years.

Claim.—1st. A hair-pulling-machine having a revolving head or block carrying fingers with flexible ends, a stationary plate adapted to turn up the ends of the hairs, and to present them in the path of the fingers, and a bed-roller beneath said plate, substantially as described to operate as set forth. 2nd. In a hair-pulling machine, a stationary separating plate, and a revolving finger having a flexible edge which is adapted to impinge and run against the nose or front edge of said plate, combined and arranged for operation as set forth. 3rd. The stationary separating plate C, having a roller C₂ in its top face behind the nose, and a revolving finger B having a flexible or yielding end B₂, and a pressure-regulating device combined for operation therewith, as set forth. 4th. A hair-pulling machine having a vertically movable bed-roller E, a stationary separating plate C, and a revolving head B carrying fingers that are adapted to impinge against and run over the end of said plate, the said parts having adjustment with respect to one another, as described for operation as set forth. 5th. The combination of the revolving stripping fingers, stationary separating plate C, and the bed-roller E having vertical adjustment in an arc from one end, as described for operation as set forth. 6th. A hair-pulling machine having a heating device to keep the skin warm while being pulled, substantially as described. 7th. In a hair-pulling machine, the combination of a hair-pulling device adapted to seize and pull the coarse hairs from the fur, and a self-feeding frame in which the skin is stretched, and mechanism by which said frame is moved progressively to carry the skin forward through the hair-pulling mechanism, substantially as described. 8th. A machine for pulling hairs from skins consisting of the following elements and parts, to wit: a hair-pulling device, a skin-supporting roller E, a self-feeding frame R, a skin-warming device V and a suction-apparatus, constructed and combined for operation as set forth.

No. 31,693. Kind of Fabric.

(*Espèce de tissu.*)

John J. Ashworth, Manchester, Eng., 28th June, 1889; 5 years.

Claim.—1st. The manufacture of the series of processes such as those hereinbefore described, of a fabric composed of cotton and wool, or linen and wool, as and for the purposes set forth. 2nd. The new kind of fabric having one surface of cotton or linen, or other smooth material, and the other surface of wool or imitation flannel manufactured, as and for the purposes described.

No. 31,694. Pilot and Engineer's Signal for Steamboats. (*Signal pour pilote et mécanicien de steamboat.*)

Cyrenius C. Roe, Wales, N.Y., U.S., 28th June, 1889; 5 years.

Claim.—1st. The dial boats A, A₁, one placed in the pilot-house and the other in the engine-room of a steamboat, the bow of the dial-boat indicating the bow of the vessel, the two lever indicators B, B₁, pivoted in front of the dial boats and connected by rods c, c, so that, when one lever-indicator is moved, the other lever indicator is moved simultaneously in the same direction and in combination with an alarm, all substantially as specified. 2nd. The two lever indicators B, B₁, suitably connected together, the dial-boats A, A₁, one set in the pilot-house, and the other in the engine-room, place in connection therewith, and having notches *b, b*, and pointers *a, a*, and all in combination with bells, gongs or other suitable alarms, all substantially as and for the purpose specified.

**CERTIFICATES OF THE PAYMENT OF FEES FOR FURTHER TERMS HAVE BEEN ATTACHED TO
THE FOLLOWING PATENTS.**

143. J. E. WILSON, 2nd 5 years of No. 19,509, from the 7th day of June, 1889. Improvements in Flour Dressing Machines, 4th June, 1889.
1444. W. LAWRIE and J. McMILLAN, 3rd 5 years of No. 31,086, from the 10th day of April, 1890. Improvements in Hydro-Carbon Furnaces, 4th June, 1889.
1445. R. GRATZEL, 2nd and 3rd 5 years of No. 22,779, from the 5th day of November, 1890. Method of Producing Haloid Compounds of Metals, 6th June, 1889.
1446. J. T. TUSSAUD, 2nd and 3rd 5 years of No. 30,332, from the 5th day of December, 1893. Improvements in Applying Fur, Hair, Wool or other Fibre or Feathers to Woven Fabrics or other Receiving Surfaces, 6th June, 1889.
1447. L. A. CHESTER (executrix) 2nd 5 years of No. 19,641, from the 25th June, 1889. Improvement on Grapnels, 6th June, 1889.
1448. G. A. CONANT, 2nd 5 years of No. 19,538, from the 9th day of June, 1889. Improvements on Bluing Compounds, 6th June, 1889.
1449. G. VALIANT, 2nd 5 years of No. 19,551, from the 10th day of June, 1889. Improvement in Boot or Glove Fasteners, 7th June, 1889.
1450. J. T. SCOFFER, 2nd 5 years of No. 19,554, from the 10th day of June, 1889. Improvement on Buffers for Railways, 10th June, 1889.
1451. M. MANNESMANN, 2nd and 3rd 5 years of No. 29,454, from the 6th day of July, 1893. Improvements in the Art of Enlarging Metallic Tubes and Apparatus therefor, 10th June, 1889.
1452. J. H. EARLE, 2nd 5 years of No. 19,810, from the 17th day of July, 1889. Improvements in Bed Spring Connections, 12th June 1889.
1453. W. E. SNEDIKER, 2nd 5 years of No. 19,612, from the 19th day of June, 1889. Improvements in Metal Moulds for Casting Vises, 12th June, 1889.
1454. H. E. CLARKE & CO., (assignee), 2nd 5 years of No. 19,781, from the 14th day of July, 1889. Improvements in Steam Trunk Lid Presses, 12th June, 1889.
1455. D. A. J. GILMOUR and J. D. GILMOUR, 2nd and 3rd 5 years of No. 21,645, from the 12th day of May, 1890. Improvements in Doors and Shutters, 12th June, 1889.
1456. S. C. ROGERS, 2nd 5 years of No. 19,583, from the 16th day of June, 1889. Improvements in Machines for Gumming and Sharpening Saws, 12th June, 1889.
1457. P. TERONHIOTON, 2nd 5 years of No. 20,043, from the 19th day of August, 1889. Improvements in Apparatus for the Manufacture of Lacrosses, 15th June, 1889.
1458. H. FLOWERS, 3rd 5 years of No. 10,153, from the 24th day of June, 1889. Improvements in the Form and Construction of Sails, both for Square Rigged and Fore and Aft Vessels, and in Apparatus for Setting, Reefing and Furling the Same, 17th June, 1889.
1459. J. J. C. TRAHER, 2nd 5 years of No. 19,699, from the 28th day of June, 1889. Improvements on the Art or Process of Perforated Stencil Painting and Printing, 17th June, 1889.
1460. THE BYFIELD MANUFACTURING CO. (assignee), 2nd 5 years of No. 19,632, from the 21st day of June, 1889. Improvements in Knitting Machines, 19th June, 1889.
1461. L. K. JEWETT, 2nd 5 years of No. 19,742, from the 5th day of July, 1889. Improvements in Car Trucks, 19th June, 1889.
1462. W. BUCK, 3rd 5 years of No. 10,140, from the 24th day of June, 1889. Improvements in Sad Irons, 19th June, 1889.
1463. J. H. W. BIGGS, 2nd 5 years of No. 10,129, from the 23rd day of June, 1889. Improvements on the Manufacture of Salt and Plant Therefor, 21st June, 1889.
1464. H. S. SCADDING, 2nd 5 years of No. 10,202, from the 9th day of July, 1889. Improvements on Blast Furnaces, 21st June, 1889.
1465. THE MAHLE BORING MACHINE CO. (assignee), 3rd 5 years of No. 10,143, from the 24th day of June, 1889. Improvements in Brush Block Boring Machines, 22nd June, 1889.
1466. THE WASHBURN & MOEN MANUFACTURING CO. (assignee), 2nd 5 years of No. 19,717, from the 30th day of June, 1889. Improvements in Machines for Manufacturing Barbed Wire, 22nd June, 1889.
1467. S. J. INGALLS, 3rd 5 years of No. 10,116, from the 23rd day of June, 1889. Improvements on Apparatus for Assisting the Separation of Cream from Milk, 22nd June, 1889.
1468. J. J. LAMB, 2nd 5 years of No. 19,909, from the 2nd day of August, 1889. Improvements in Door Catches, 24th June, 1889.
1469. N. R. FROST, 3rd 5 years of No. 10,144, from the 24th day of June, 1889. Improvements in Heel Stiffeners, 24th June, 1889.
1470. J. WARREN and E. BURRITT, 2nd 5 years of No. 19,695, from the 28th day of June, 1889. Improvements in Car Coupling Links, 25th June, 1889.
1471. THE SMYTH MANUFACTURING CO. (assignee) 3rd 5 years of No. 10,188, from the 3rd day of July, 1889. Improvements in Machinery for Sewing Together Sheets of Paper, or other Material, into Books or Pamphlets, 25th June, 1889.
1472. M. B. HURLY, 2nd 5 years of 19,687, from the 28th day of June, 1889. Improvements in Bill and Letter Files, 27th June, 1889.

JUNE LIST OF TRADE MARKS.

Registered at the Department of Agriculture—Copyright and Trade Mark Branch.

3468. HENRY THORNE & COMPANY, Limited, of Leeds, Co. of York, and 46 St. Mary Axe., London, England. Cocoa, 3rd June, 1889.
3469. JOHN MADDOCKS, of 26 Booth Street, Bradford, York, England. Textile goods, stuffs or fabrics, 3rd June, 1889.
3470. GEORGE C. HENRY, of Burlington, Iowa, U.S.A. Soda Water and other Carbonated Beverages, 4th June, 1889.
3471. HENRY GORDON SMALL, of Manchester, Lancaster, England. Engine Packing, 4th June, 1889.
3472. J. A. GIBBONS & COMPANY, of Toronto, Ont. A Toothache Specific, 5th June, 1889.
3473. A. W. ALLEN, of Toronto, Ont., trading under the name and style of the ALLEN MANUFACTURING COMPANY. Articles laundried by the Swiss Steam Laundry, 5th June, 1889.
3474. FRANCIS R. ARNOLD & COMPANY, of New York, U.S.A. Perfumery, 5th June, 1889.
3475. M. M. L. VAN LANGENHOVE et E. STEINKUHLER, domiciliés respectivement à Alost et à Gand, et agissant en leur qualité d'Administrateur de la SOCIÉTÉ ANONYME FILATURE ET FILTERIES REUNIES à Alost, Belgique. Fils de lin et de coton à coudre, 8 Juin, 1889.
3476. WARREN GRAY, of Halifax, N.S. Baking Powder, 10th June, 1889.
3477. } THE COMPANIA GENERAL DE TABACOS DE FILIPENAS, of Barcelona,
3478. } Spain, and Fenchurch Street, London, England. Tobacco manufactured and unmanufactured, including Cigars and Cheroots, 11th June, 1889.
3479. S. DAVIS & SONS, of Montreal, Que. Cigars, 13th June, 1889.
3480. EMMET DENSMORE AND HELEN DENSMORE, of New York, U.S.A. Herb Medicine, 21st June, 1889.
3481. A. C. MILLER & CO., of Picton, Ont. Canned Fruits, Vegetables, Meats and Poultry, 21st June, 1889.
3482. W. H. SCHWARTZ & SONS, of Halifax, N.S. Spices, 21st June, 1889.
3483. JANE ROGERS FRIGGE AND SARAH AGNES PEARSON, of Hamilton, Ont. A farinaceous food for Infants and Invalids, 22nd June, 1889.
3484. DELAFIELD, McGOVERN & COMPANY, of New York, U.S.A. Canned goods (fish, fruit, including raisins in boxes or cans, and vegetables), 24th June, 1889.
3485. HENRY HANNIBAL CHURCH, of Dunham, Que. Medical Preparation, 24th June, 1889.
3486. ALEXANDER JAMES McLELLAN, of Victoria, B.C. Salmon, 24th June, 1889.
3487. YOUNG & SON, of Montreal, Que. A preparation for dyeing, 25th June, 1889.
3488. YOUNG & SON, of Montreal, Que. A certain description of dye, 25th June, 1889.
3489. CHAPUT ET COMPAGNIE, Montreal, Que. Cigares, 27 Juin, 1889.
3490. LOUIS OVIDE GROTHÉ, Montreal, Que. Cigars, 28th June, 1889.

COPYRIGHTS.

Entered during the month of June at the Department of Agriculture—Copyright and
Trade Mark Branch.

4911. } SO FARE THE WELL! (I've sought the brake and bracken).
4912. } THE JUG OF BEER. Songs from the Comedy Opera "Doria." Words by B. C. Stephenson. Music by Alfred Cellier. The Anglo-Canadian Music Publishers' Association (L'd.), London, England, 1st June, 1889.
4913. } THE FOG PRINCES. By Florence Warden (book).
4914. } THE PRETTY SISTER OF JOSÉ. By Frances Hodgson Burnett (book). The National Publishing Co., Toronto, Ont., 5th June, 1889.
4915. JOHNSON'S CANADIAN SCHOOL SHORTHAND. George W. Johnson, Hamilton, Ont., 5th June, 1889.
4916. THE FATAL PHYRNE. By F. C. Philips and C. T. Wills (book). John Lovell & Son, Montreal, Que., 6th June, 1889.
4917. LEO, THE ROYAL CADET. Libretto by George Frederic Cameron and Charles J. Cameron, A.M. Music by Oscar F. Feigmann, Charles J. Cameron, O. F. Feigmann, Kingston, Ont., 6th June, 1889.
4918. } THAT FRENCHMAN. By Archibald Clavering Gunter (book).
4919. } UNDER A STRANGE MASK. By Frank Barrett (book). The National Publishing Co., Toronto, Ont., 6th June, 1889.
4920. THE MERCANTILE TEST & LEGAL RECORD. Vol. XIX., No. 23, June 6, 1889 (periodical). Dun, Wiman & Co., Toronto, Ont., 7th June, 1889.
4921. THE IMPERIAL SHOPPING CARD. Edmund Francis Stephenson, Park Hill, Ont., 8th June, 1889.
4922. THE FAMILY PHYSICIAN; or, EVERY MAN HIS OWN DOCTOR. Rose Publishing Co., Toronto, Ont., 11th June, 1889.
4923. HARRISON'S MUNICIPAL MANUAL. Fifth Edition. By F. J. Joseph, Esq., Toronto, Ont., 13th June, 1889.
4924. LA TARANTELLE DU CARNIVAL ROMAIN. (Poème Symphonique pour Piano) par Clarence Lucas. I. Suckling & Sons, Toronto, Ont., 13th June, 1889.
4925. } DORIS WALTZ. By P. Bucalossi. Comedy Opera.
4926. } DORIS QUADRILLE. By B. C. Stephenson and Alfred Cellier. The Anglo-Canadian Music Publishers' Association (L'd.), London, England, 13th June, 1889.
4927. CALL YE FOR MEN (poem). Llewellyn Abraham Morrison, Toronto, Ont., 14th June, 1889.
4928. } THE LAST COUP. By Hawley Smart (book).
4929. } LORD AND LADY PICCADILLY. By the Earl of Desart (book).
4930. } A TROUBLESOME GIRL. By The Duchess (book). The National Publishing Co., Toronto, Ont., 14th June, 1889.
4931. THE KING OF KINGS. Words by A. Horspool. Music by A. Rawlings.
4932. THE MALADOR. Words by A. Horspool. Music by Ed. St. Quentin. A. & S. Nordheimer, Toronto, Ont., 14th June, 1889.
4933. THE MERCANTILE TEST AND LEGAL RECORD. Vol. XIX. No. 24, June 13, 1889 (periodical). Dun, Wiman & Co., Toronto, Ont., 15th June, 1889.
4934. FANTASIE. Valse pour Piano par Charles Coots. Hopwood & Crew, London, England, 15th June, 1889.
4935. SECOND ORATION OF CICERO AGAINST CATILINE, with Notices, Notes and Complete Vocabulary. By John Henderson, M.A. The Copp, Clark Co. (L'd.), Toronto, Ont., 18th June, 1889.
4936. } THE TENTS OF SHEM. By Grant Allen (book).
4937. } A BABE IN BOHEMIA. By Frank Danby (book). Wm. Bryce, Toronto, Ont., 21st June, 1889.
4938. GOD BLESS OUR BROAD DOMINION. Composed by R. S. Knight. I. Suckling & Sons, Toronto, Ont., 21st June, 1889.
4939. THE MERCANTILE TEST AND LEGAL RECORD. Vol. XIX. No. 25, June 20, 1889 (periodical). Dun, Wiman & Co., Toronto, Ont., 21st June, 1889.

4940. } CLEOPATRA. By H. Rider Haggard (book).
4941. } FLAMENKA. By B. L. Farjeon (book). Wm. Bryce, Toronto, Ont., 24th June,
1889.
4942. THE KETTLEDRUM. Military Parade by Paul Sohmer. I. Suckling & Sons,
Toronto, Ont., 27th June, 1889.
4943. GRAY AND PHILPOTT'S MEDICAL FORM for the rendering and collection of
Physicians' Accounts. Henry Searle Gray, and Frederick V.
Philpott, Toronto, Ont., 27th June, 1889.
4944. THE MERCANTILE TEST AND LEGAL RECORD. Vol. XIX. No. 26, June 27,
1889 (periodical). Dun, Wiman & Co., Toronto, Ont., 28th June,
1889.
4945. THE NEW PAPACY. Behind the Scenes in the Salvation Army. By an ex-Staff
Officer (pamphlet). Albert Brinell, Toronto, Ont., 28th June,
1889.
- 

THE

CANADIAN PATENT OFFICE RECORD.

ILLUSTRATIONS.

Vol. XVII.

JUNE, 1889.

No. 6.

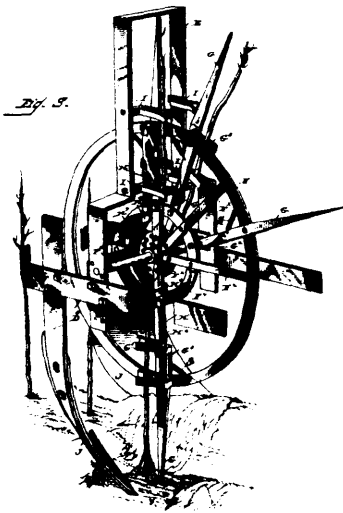

31470 Stratton's Tree and Plant Setting Machine.

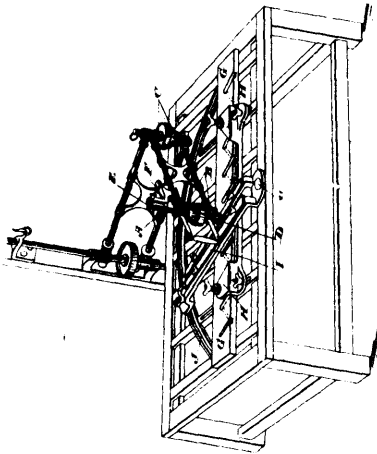

31471 Harvey's Routing Machine.

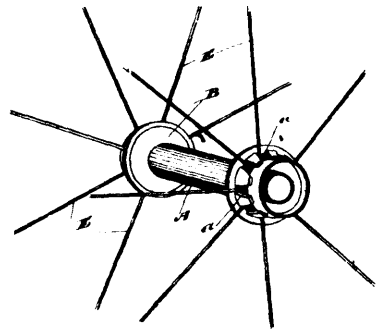

31472 Bothwell's Wheel.

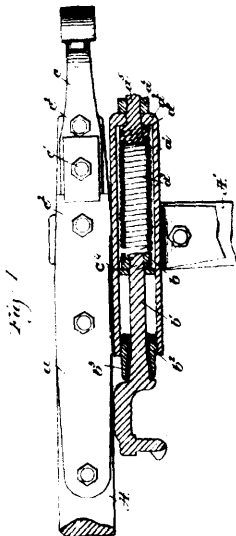

31473 Webster's Draft for Vehicles.

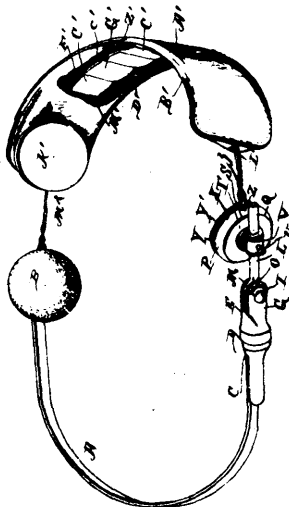

31474 Bell's Truss.



31475 Patmor's Finger Shield and Fountain Attachment.



31476 Norcross' Musical Instrument.

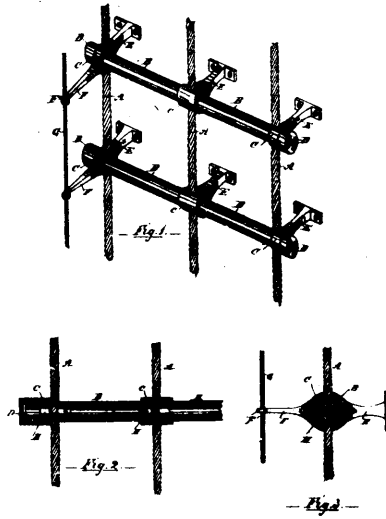

31477 Smith's Ladder.

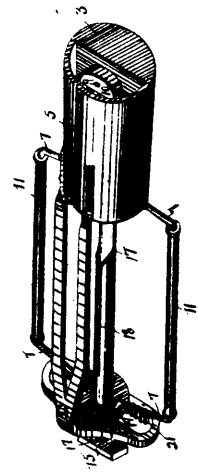

31478 Caesar's Device for Sharpening Razors.

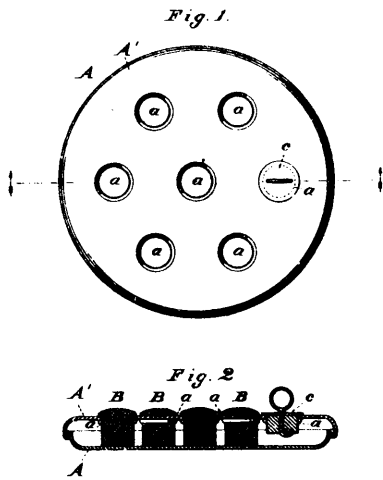

31479 Kibler's Device for Killing Files.

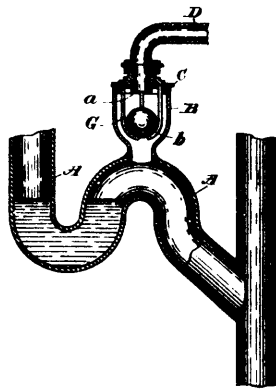

31480 Ryan's Return Vent Protector.

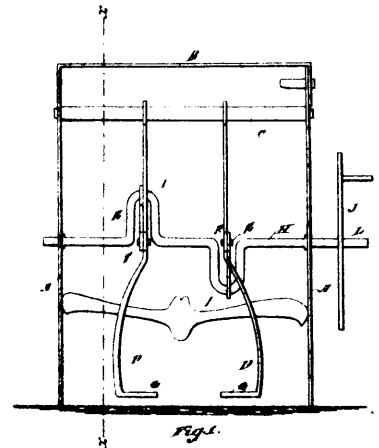

31481 Feher's Sewing Machine Pedal.

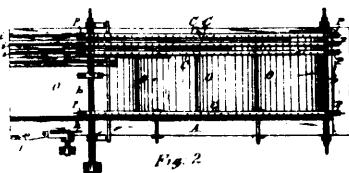
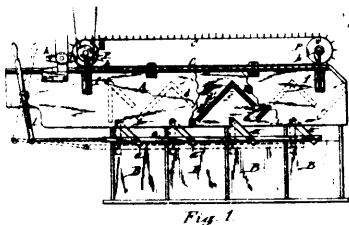

31482 Lipe's Machine for Assorting Broom Corn.

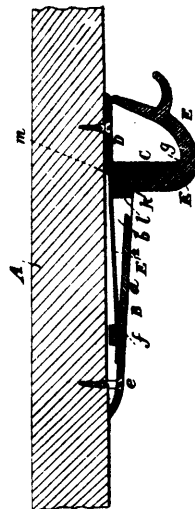

31484 Wilson & Hough's Holdback.

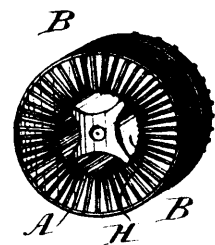

31485 Thomson's Armature for Dynamos.



31486 Rowen's Rail Joint Fastener.

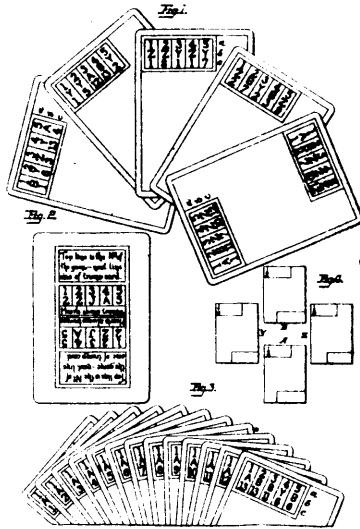

31487 Foster's Playing Card.

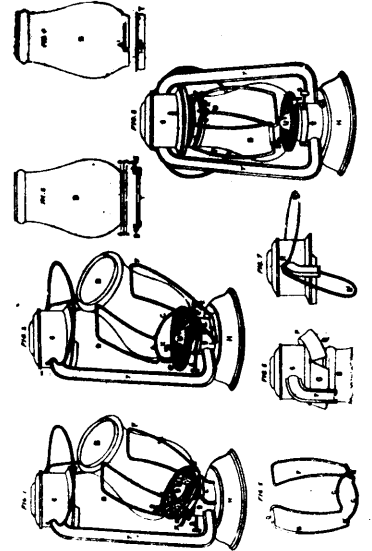

31488 Lind's Lantern.

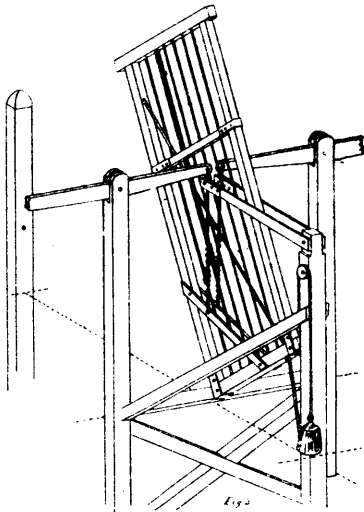

31489 Mercer's Gate.

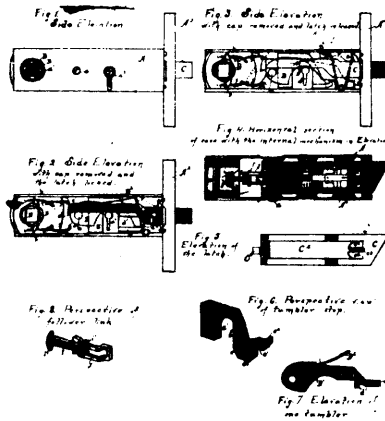

31490 Cooke's Mortise Lock.

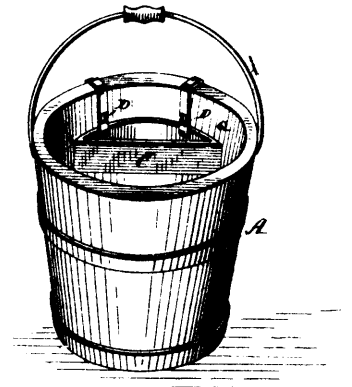

31491 McPherson's Device for Moistening Tobacco.

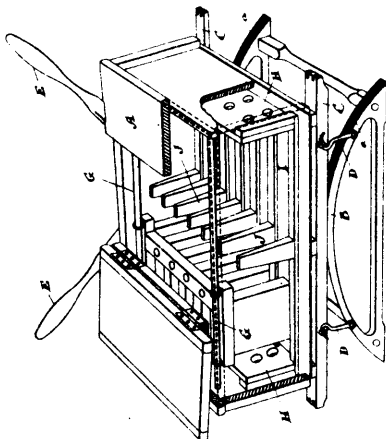

31492 Kelsey & Gibson's Washing Machine.

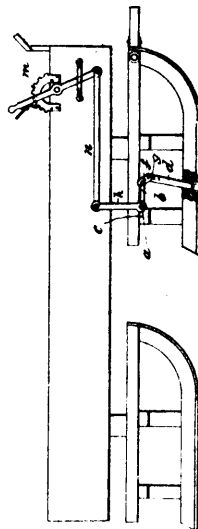

31493 Holt's Sled Brake.

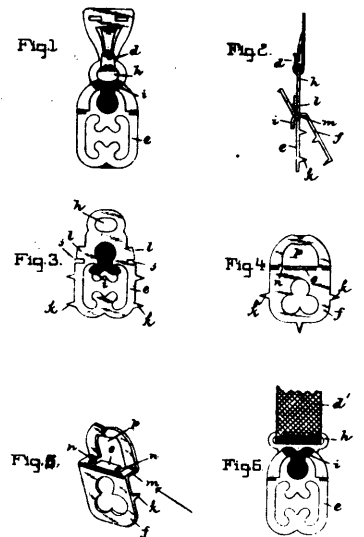

31496 Rubin's Clasp.

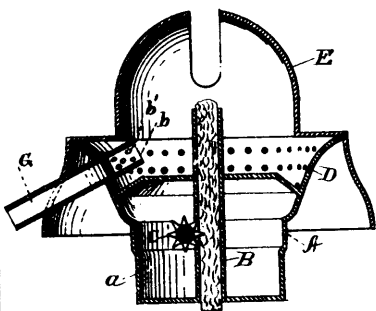

31497 Chapin's Igniting and Extinguishing Apparatus.

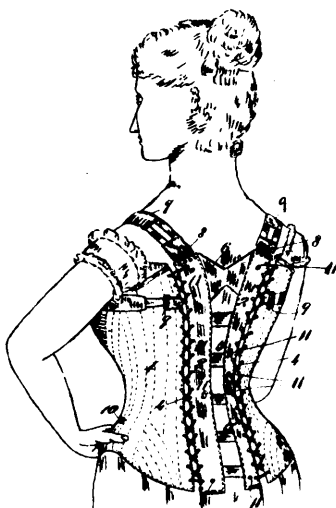

31498 Williamson's Corset.

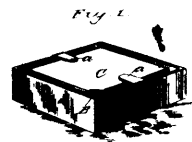

Fig. 2.

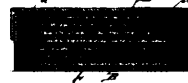
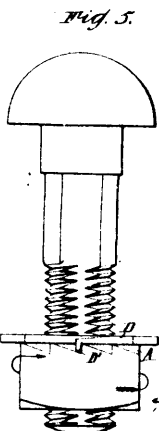

Fig. 3.



31499 Conklin's Bluing Package.



31500 Purbrick & Stone's Means for Locking Nuts.

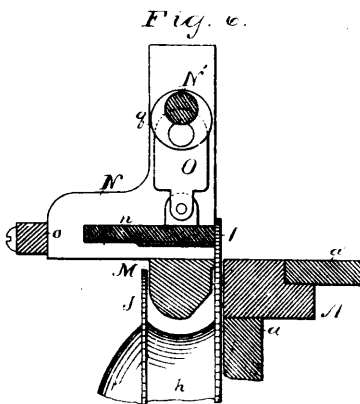

31501 Cummings' Machine for Separating, etc., Stereotype Plates.

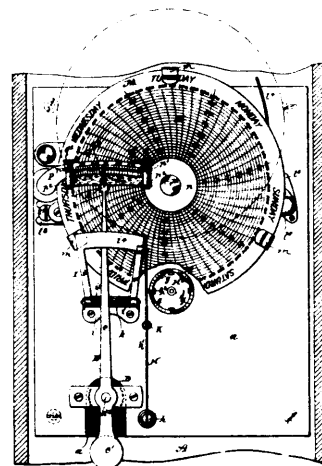

31502 Brewster's Thermometer.

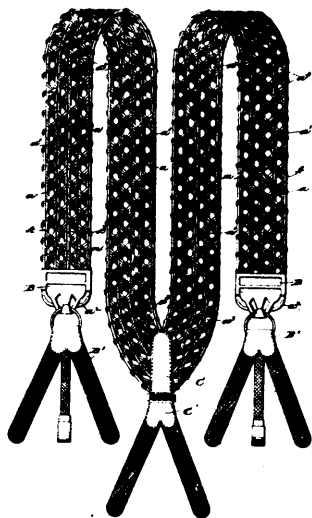

31504 Goodman's Suspender.

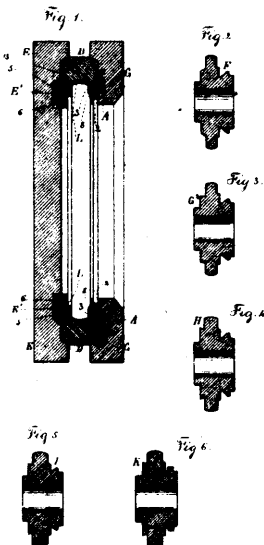

31505 Ecaubert's Watch Case.

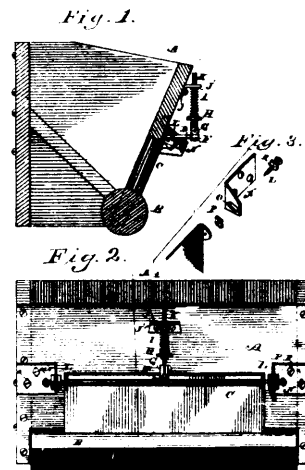

31506 Whitney's Feed Gate for Roller Mills.

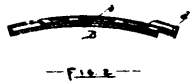
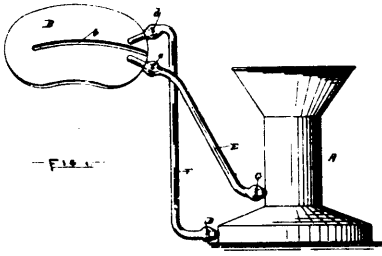

31507 Small's Device for Applying Heat to the Body.

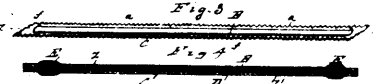
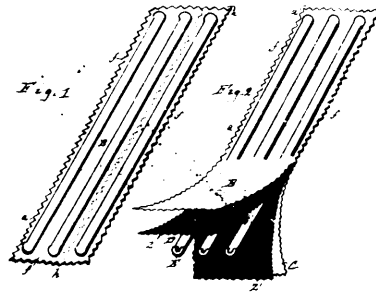

31509 Bowling's Garment Stay.

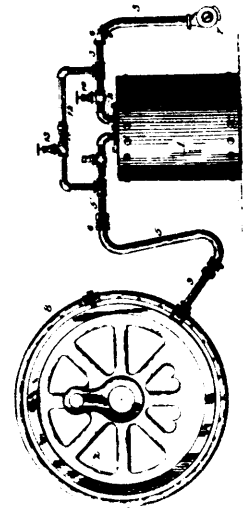

31510 Hassman's Tire Heating Apparatus.

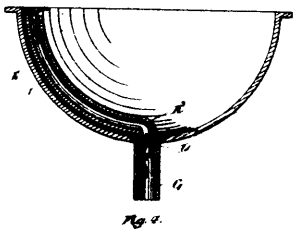
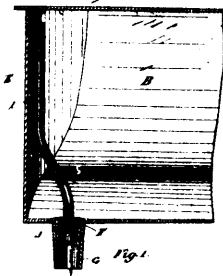

31511 Bellavance's Overflow for Baths, etc.

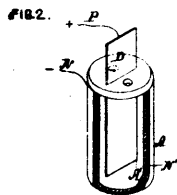
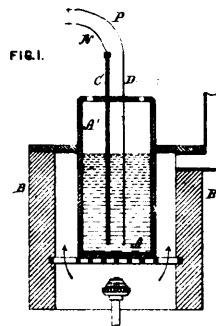

31512 Hall's Process of Reducing Aluminium.

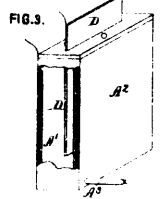
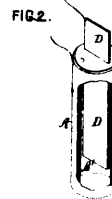
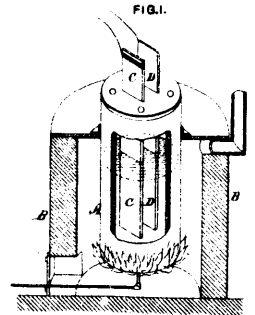

31513 Hall's Process of Reducing Aluminium from its fluoride Salt.

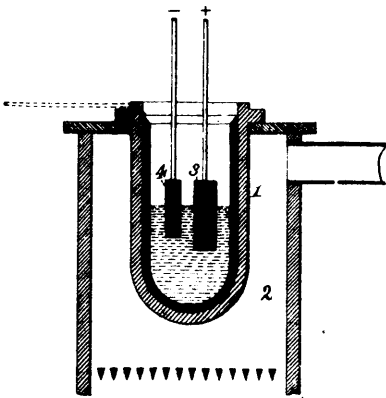

31514 Hall's Process of Electrolyzing Crude Salts of Aluminium.

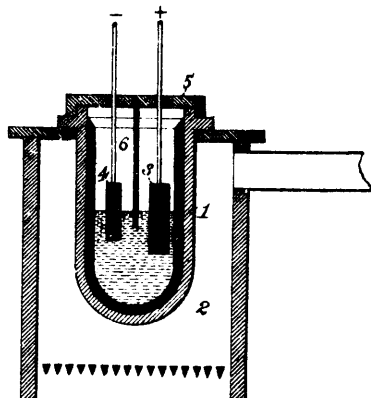

31515 Hall's Manufacture of Aluminium.

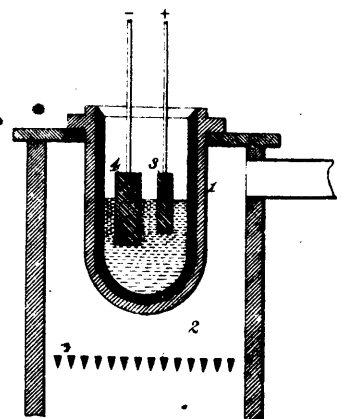

31516 Hall's Manufacture of Aluminium Alloys.

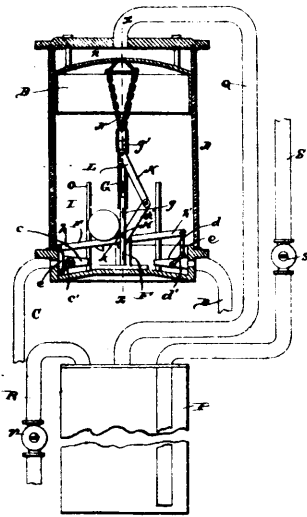

31518 Battey's Liquid Elevator.

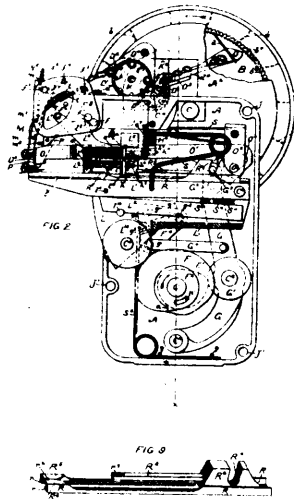

31519 English's Button Setting Machine.

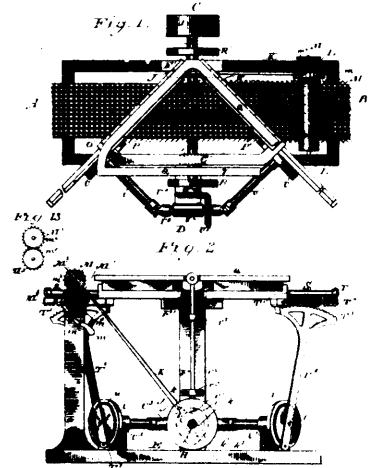

31520 Morris' Machine for Inserting Diagonal Strips into Fabrics.

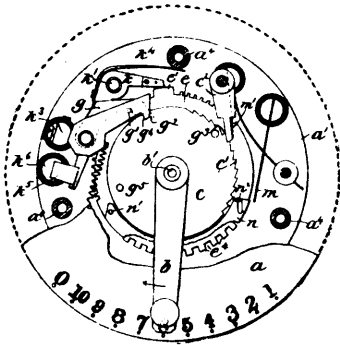

31521 Dudley's Transmitting Instrument for Electric Signalling Apparatus.

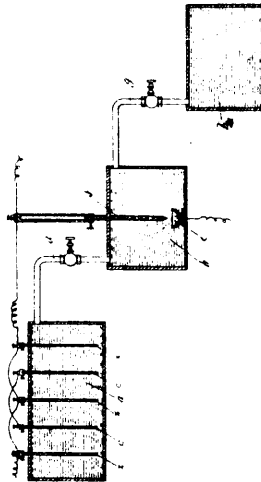

31522 Wiswell's Bath for Separating Metals from their Ores, etc.

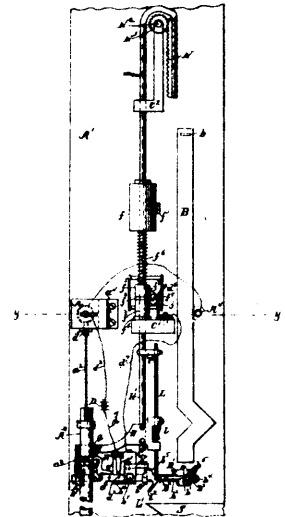

31523 Williams & Roover's Coin Operated Induction Coil.

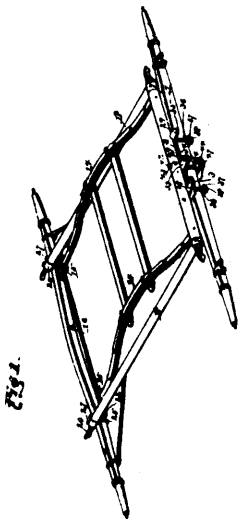

31524 Mandt's Gear for Vehicles.

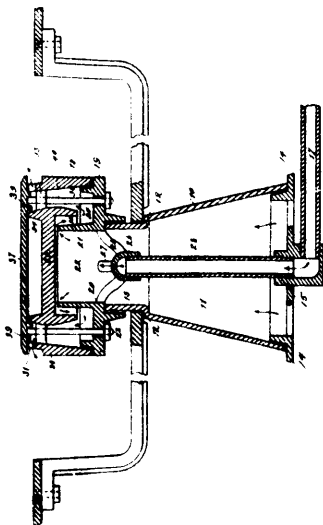

31525 Robilliard & Davies' Gas Burner, etc.

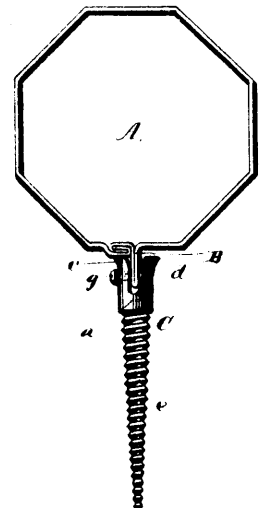

31526 Davis' Support for Water Conductors.

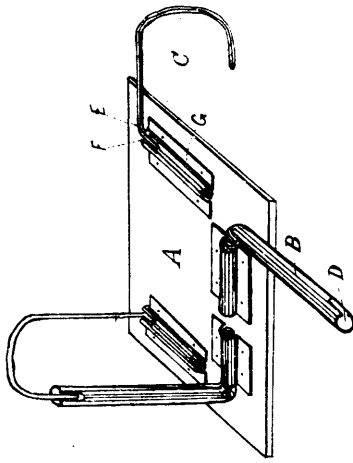

31527 Lash's Letter File.

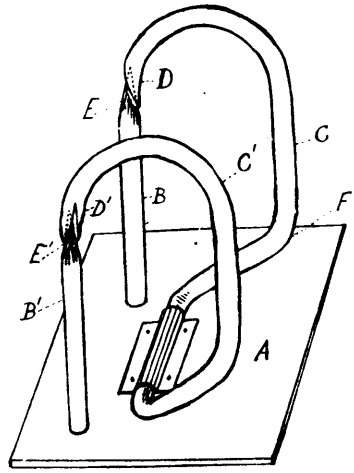

31528 Lash's Letter File.

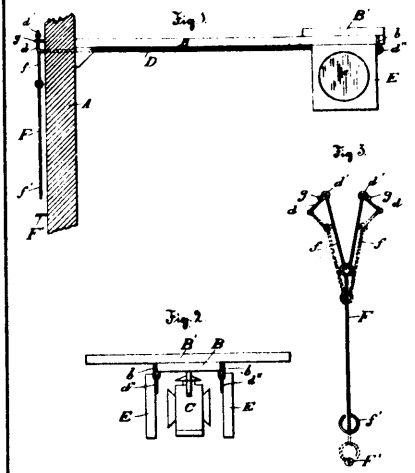

31529 Kirby's Semaphore.

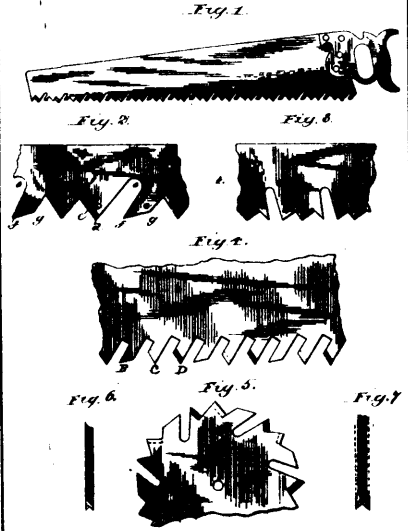

31530 Bundy's Saw.

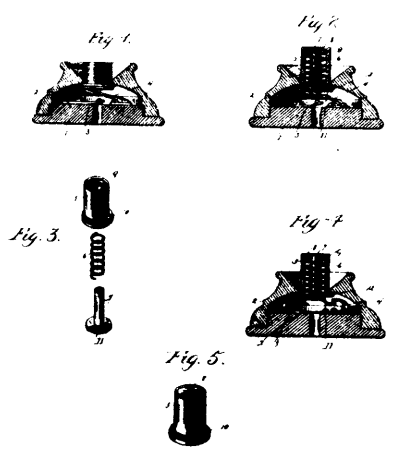

31531 Denio's Electric Signalling and Alarm Apparatus.

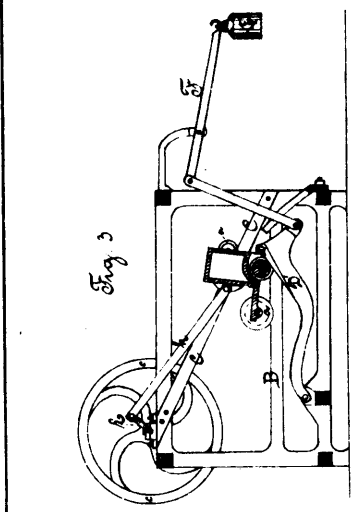

31532 Saunders' Car Axle Lubricator.

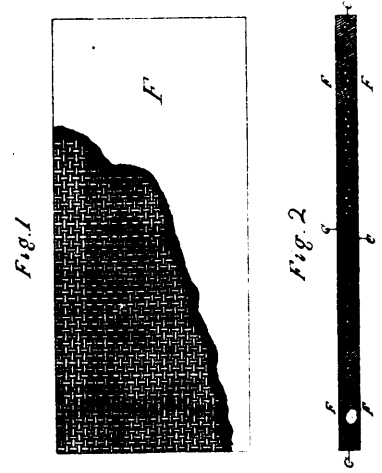

31533 Eastwood's Felt and Felt Cloth.

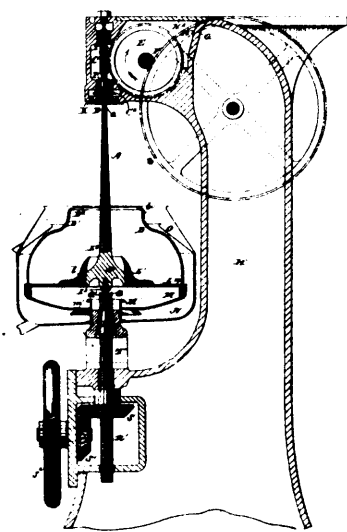

31534 Bergh's Centrifugal Fluid Separating Machine.

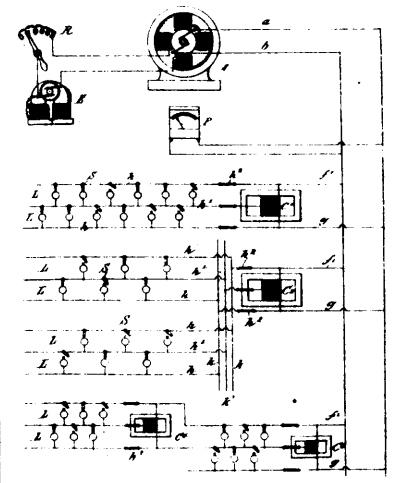

31535 Thomson's Transfer System of Electrical Distribution.

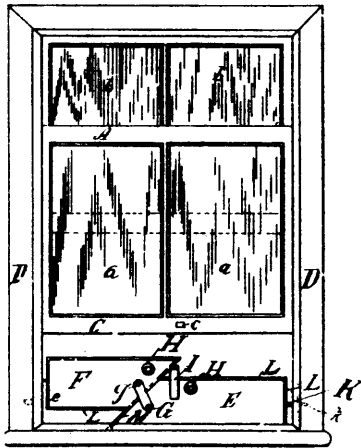

31536 McDonald's Window Ventilation.

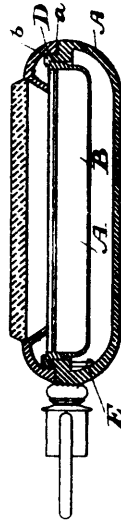

31537 Heffernan's Watch Case.

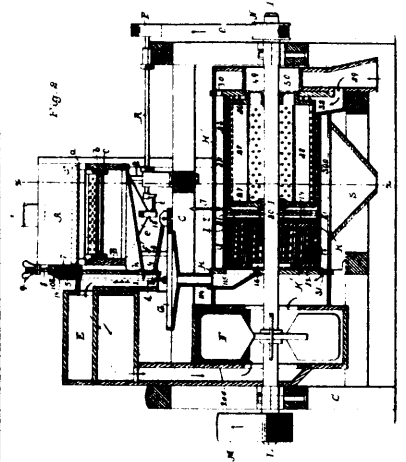

31538 Fisher's Grain Scouring Machine.

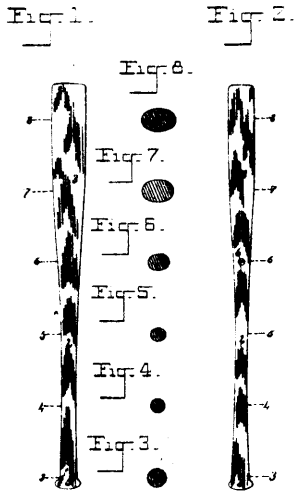

31541 Morris' Base Ball Bat.



31542 Goserud's Drill.

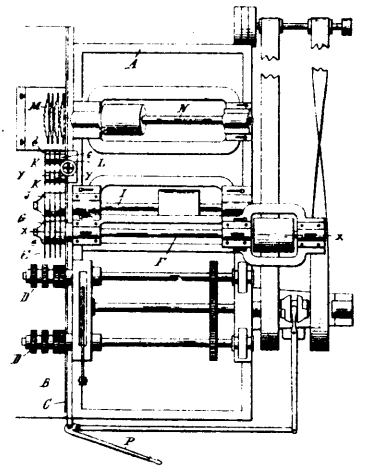

31543 Schimansky's Machine for Cutting Hoops.

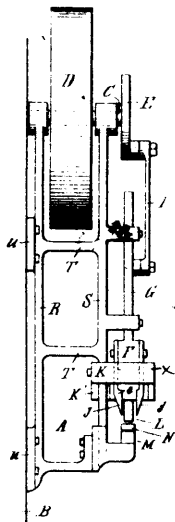

31544 Schimansky's Machine for Pointing Hoops.

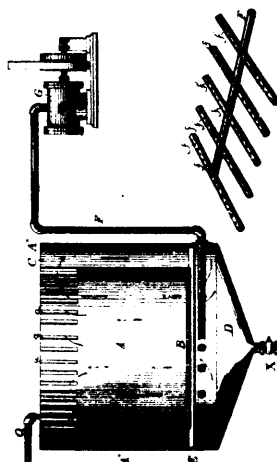

31545 Cooper's Method of Treating Hides, etc.

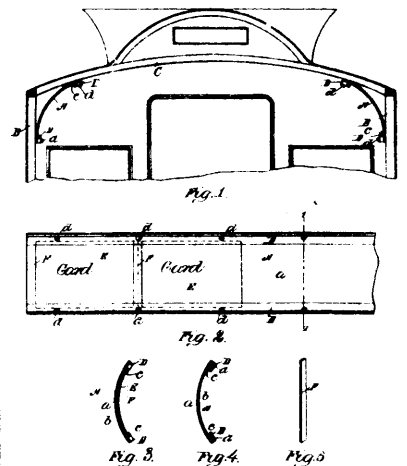

31546 Hand all's Advertising Rack for Street Cars.

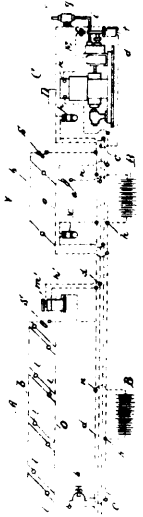

31547 Timmis' Apparatus for Electrically Lighting Trains.

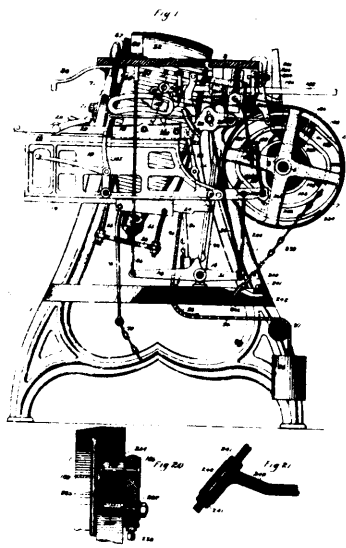

31548 McCombe's Broom Sewing Machine.

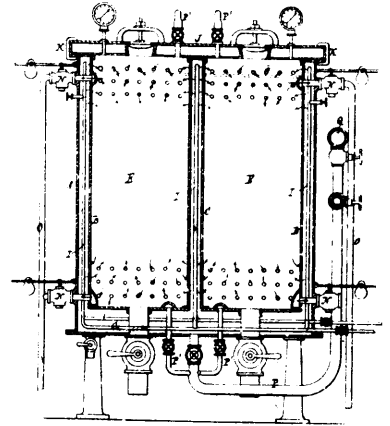

31549 Brown's Fibre Digester.

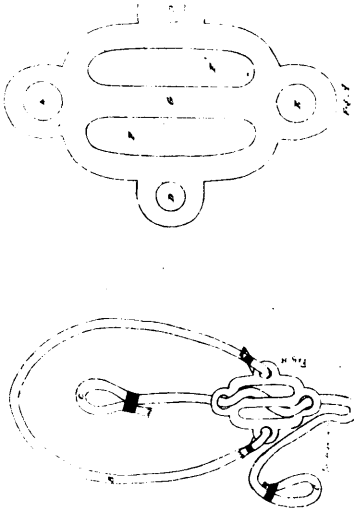

31550 Klase's Fire Escape.

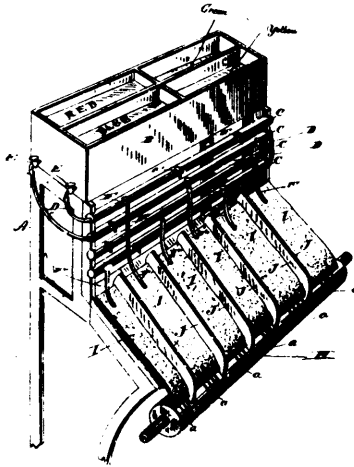

31551 Mortimer's Machine for Ornamenting Paper.

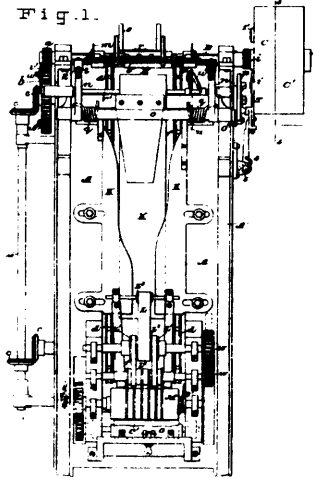

31552 Clarke's Envelope or Bag Machine.

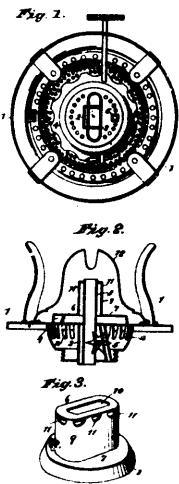

31553 Ellis' Lamp Burner.

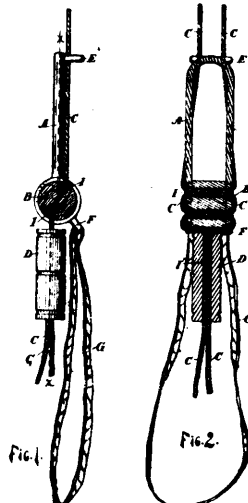

31554 Boyle's Fire Escape.

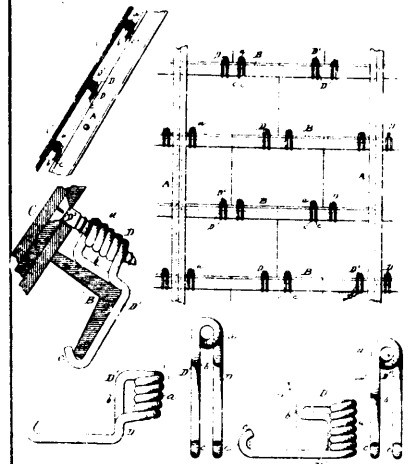

31555 Norcross' Fastening for Roof Slates.

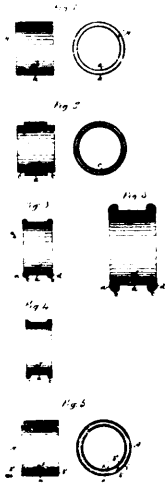

31556 Knight's Ornamental Ring.

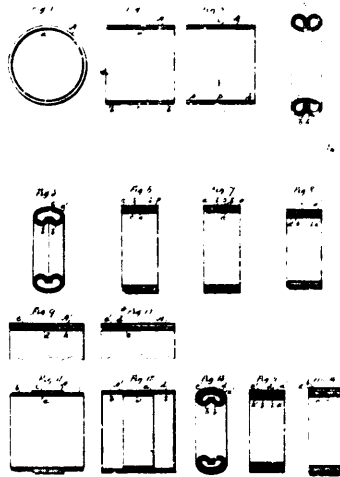

31557 Knight's Manufacture of Plated Rings.

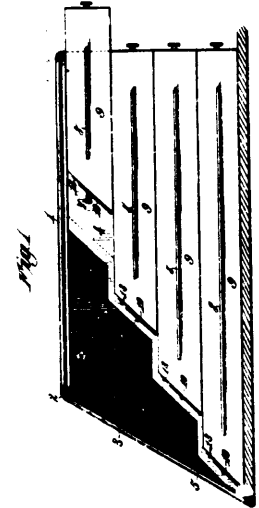

31558 Piferling's Show Case.

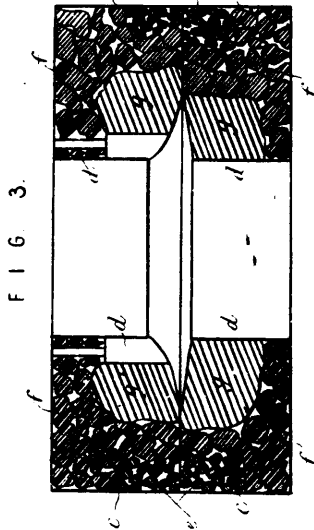

31559 Potter's Mill Stone.

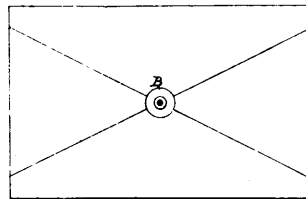

31560 Mercer's Envelope and Tag Fastener.

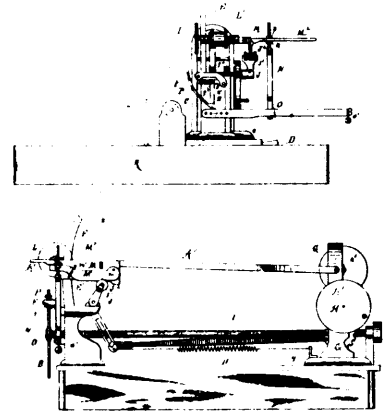

31561 Welch's Saw Gummer, etc.

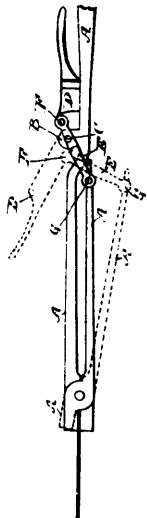

31562 Beauchamp's Lever for Vices or Tongs.

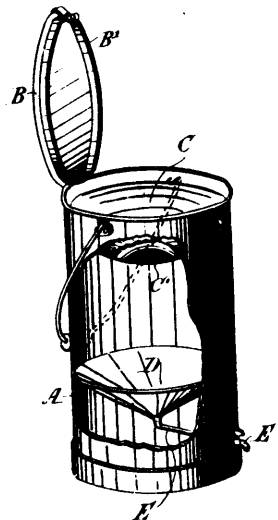

31563 Lindsay's Household Utensil.

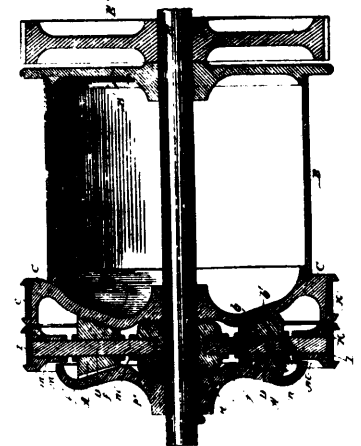

31564 Lemieux's Hoisting Machine.

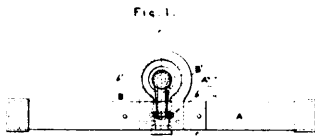

Fig. 1.



Fig. 2.



31585 Woodsford's Pocket Fastener.

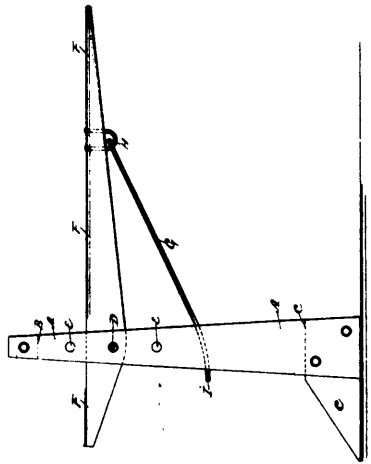

31568 Eddy's Lifting Jack.

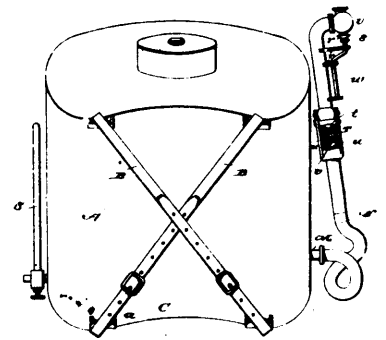

31567 Weaber's Sprinkler.

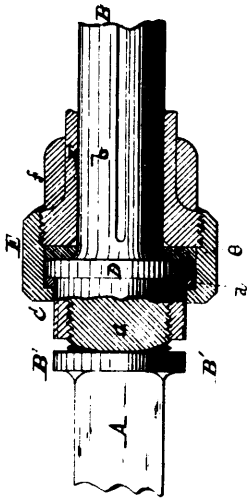

31569 Wright's Vehicle Axle.

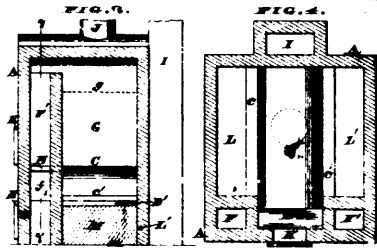
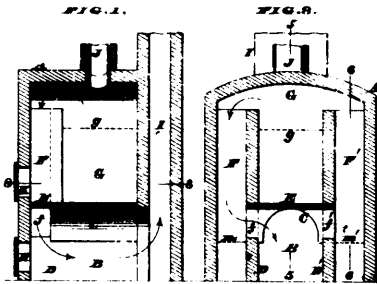

31569 Robb's Dry Closet.

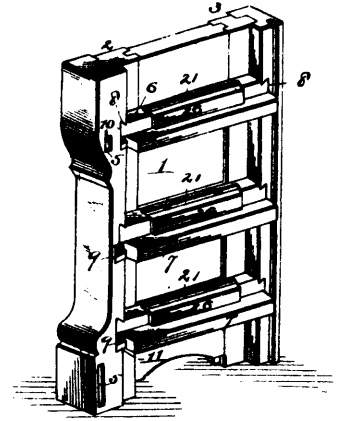

31570 Clapp's Bureau.

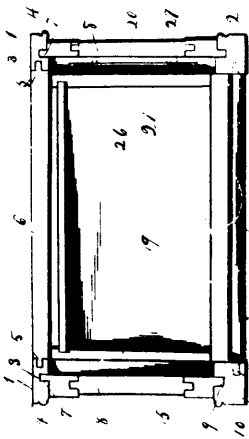

31571 Clapp's Bureau.

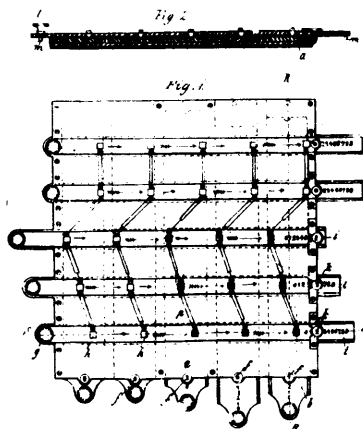

31572 Illgen's Apparatus for Calculating

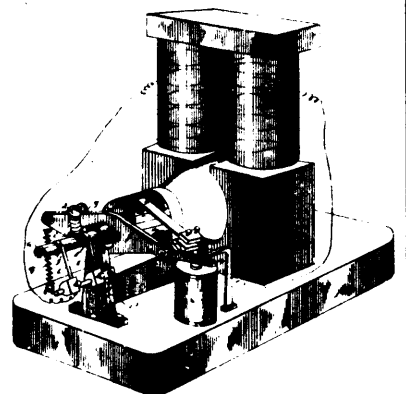

31573 Kester's Regulator for Dynamo Electric Machines.

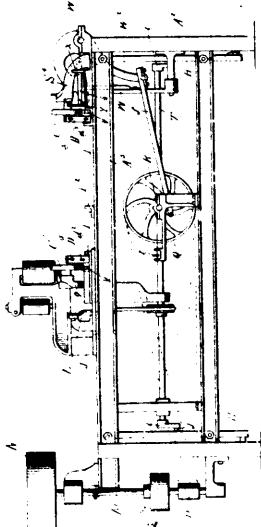

31574 Ward's Machine for Pointing and Lapping Hoops.

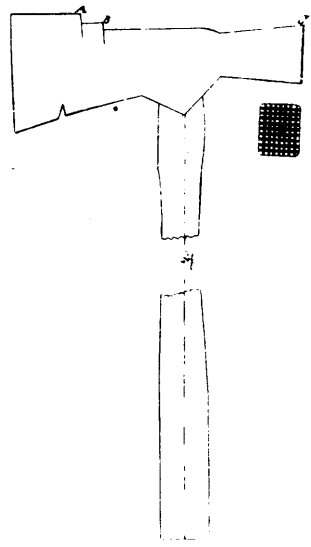

31575 Pettingell's Hatchet for Shingling.

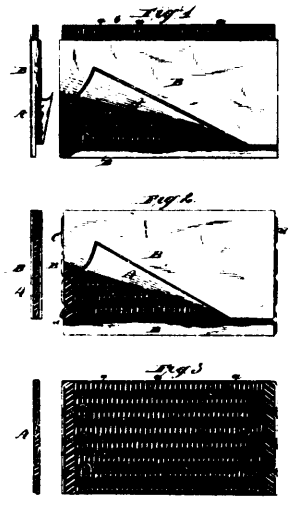

31576 Emerson & Midgley's Manufacture of Belting.

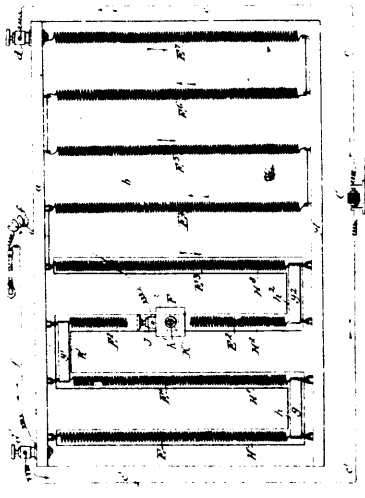

31577 Gish's Rheostat.

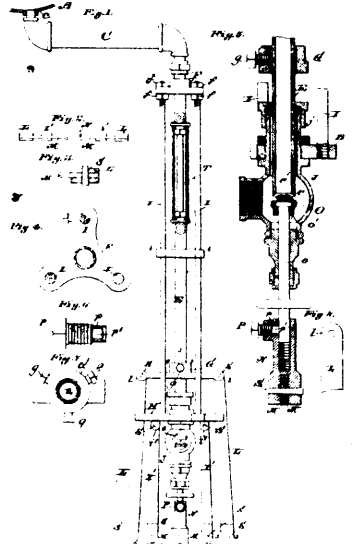

31578 Correll's Steam Trap.

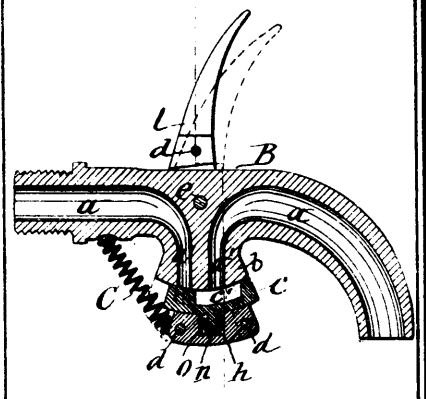

31579 Scoville's Faucet.

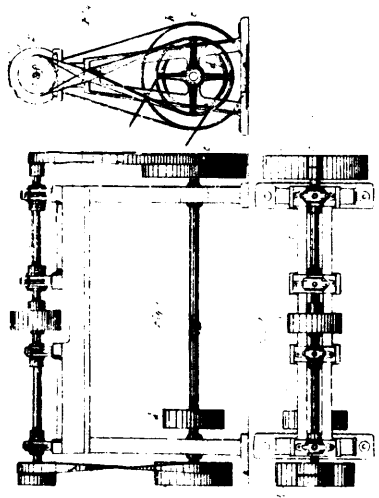

31580 Keyling's Apparatus for Producing Shot.

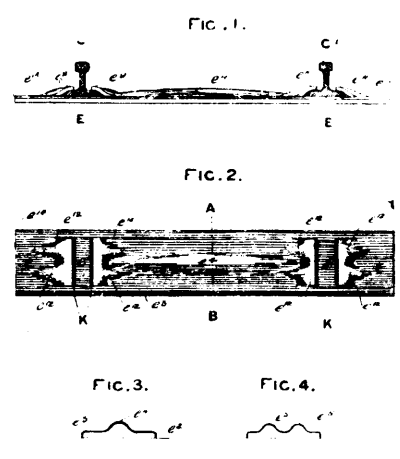

31581 Hopkins' Sleeper.

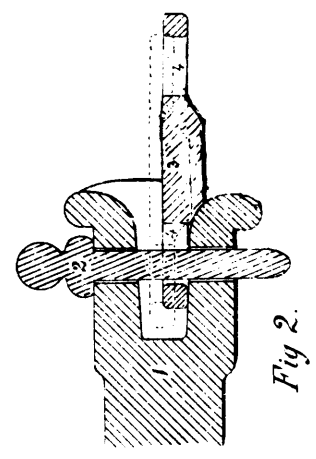

31582 Ptolemy's Car Coupling Link.

Fig. 2.

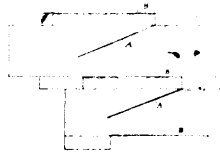
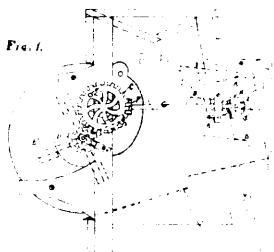
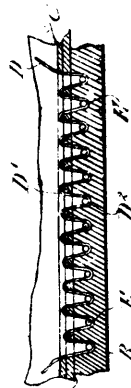

Fig. 1.



31583 Bolton's Fanning Mill.



31584 Cargy's Lock Stitch for Securing Soles and Uppers.

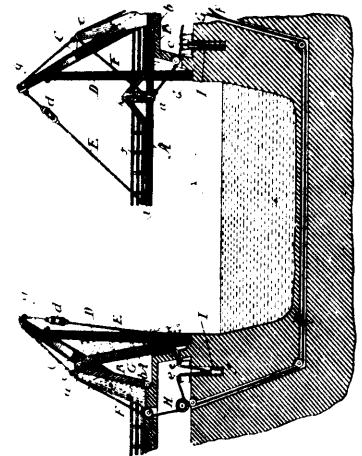

31585 Harman's Bridge.

Fig. 2

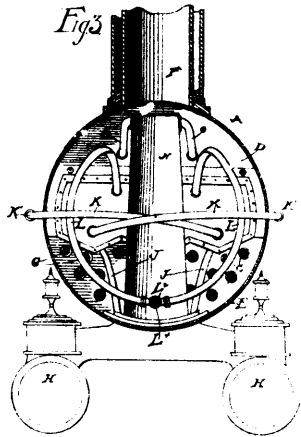

31586 Lee's Feed Water Heater and Purifier

Fig. 1

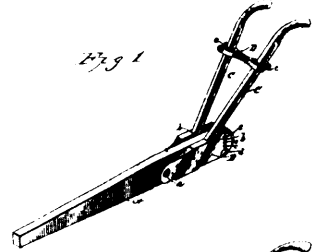

Fig. 2.

Fig. 3.



Fig. 3.

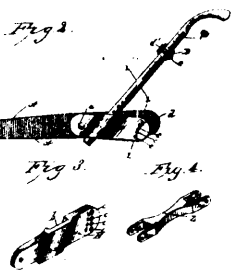
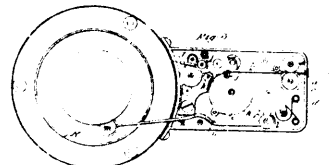
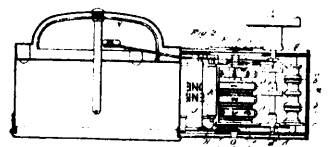
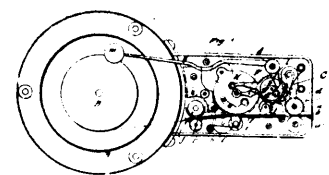

Fig. 4.

31587 Allen's Plough Handle.



31588 Rastrick's Apparatus for Issuing Tickets, etc.

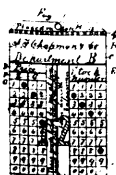

Fig. 2

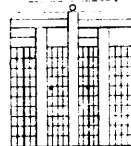

Fig. 1

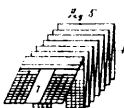
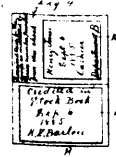

Fig. 5

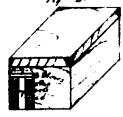

Fig. 4

31589 DeWitt's Price and Inventory Check.

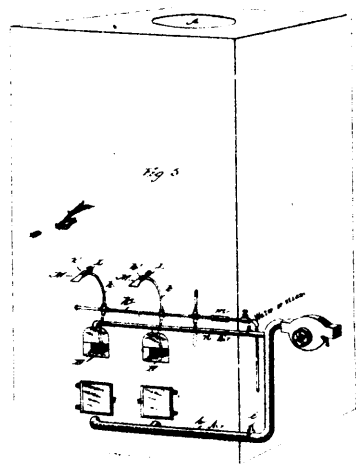

Fig. 1

31590 Carleton's Manufacture of Lime.

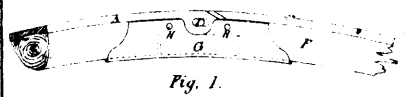

Fig. 1.

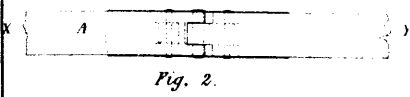

Fig. 2.



Fig. 3.

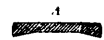

Fig. 4.



Fig. 6.

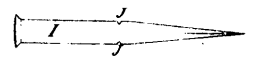
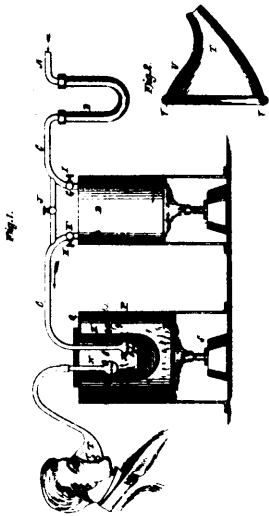
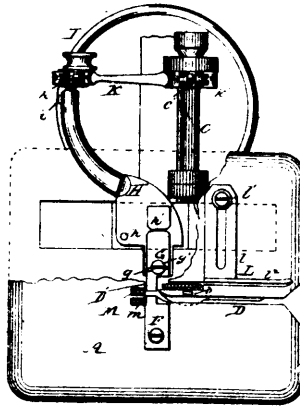

Fig. 5.

31591 Morris' Wheel Tire.



31592 Williams' Vaporizing Apparatus.



31593 Dewees' Trimming Attachment for Sewing Machine.

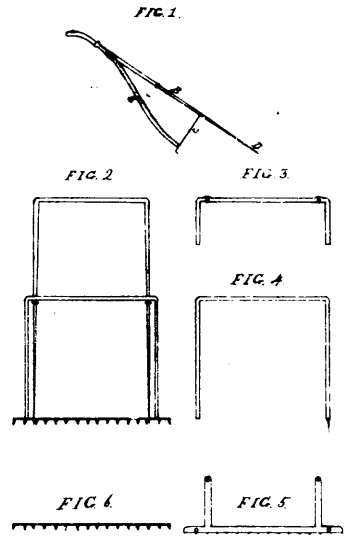

31594 Sturdy's Machine for Stretching Carpet.

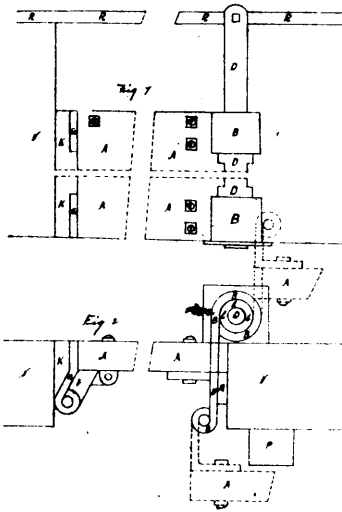

31595 Montgomery's Freight Car Door.

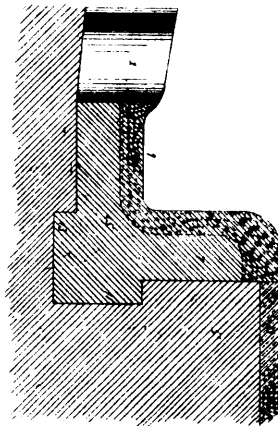

31596 Parkhurst's Curb and Gutter.

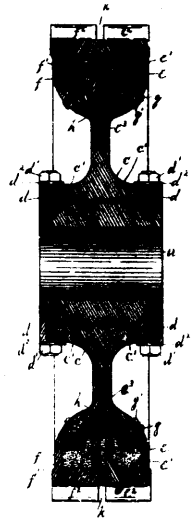

31597 Graf's Gear Wheel.

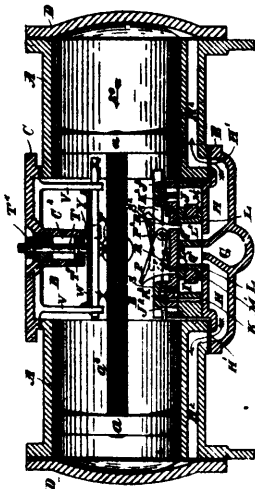

31598 Norfolk's Fluid Meter.

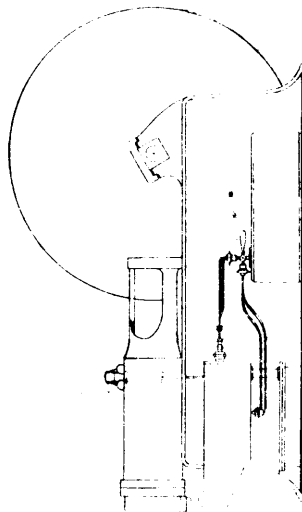

31599 Priestman's Motor Engine.

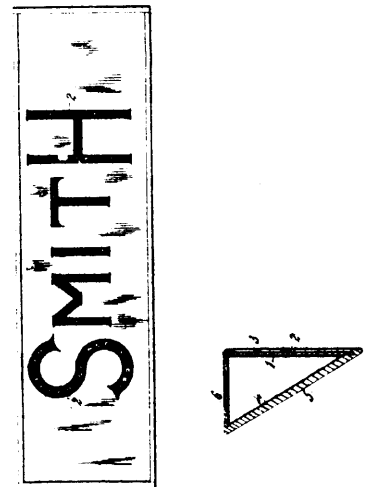

31600 Smith's Means for Producing Sparking Effect. &c.

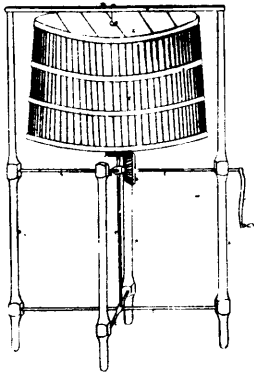

Fig. 1

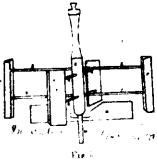

Fig. 2

31601 Ward's Churn.

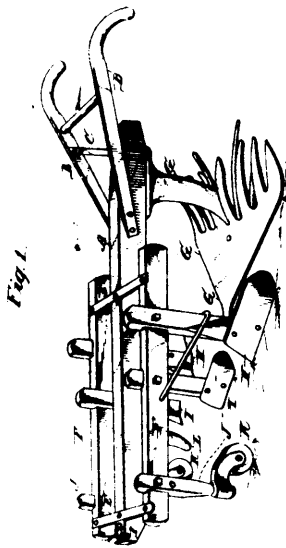
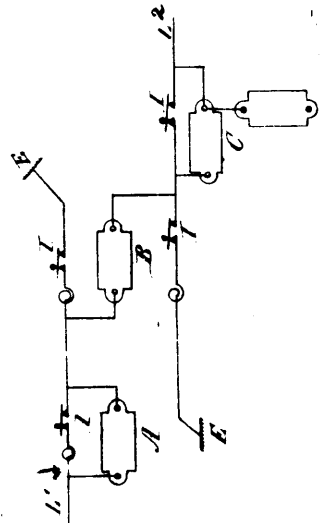
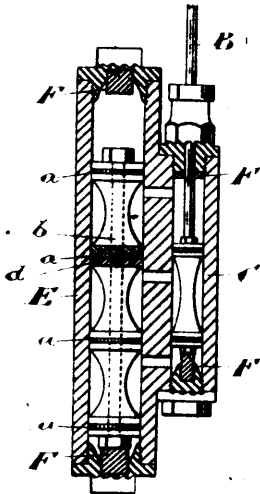

Fig. 1

31602 Rigby's Potato Digger.



31603 Davies' Telephony and Telegraphy.



31604 Guest's Hydraulic Engine.

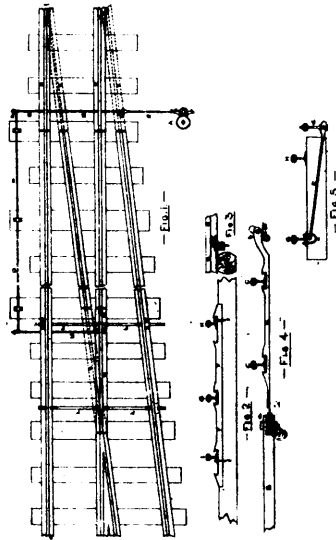

31605 Cameron's Railway Switch.

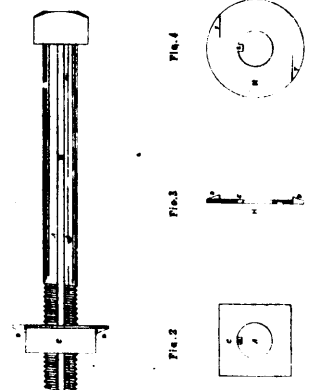

31606 Dion's Nut Lock.

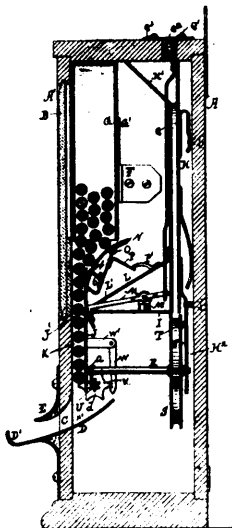

31607 O'Kelly's Vending Apparatus.

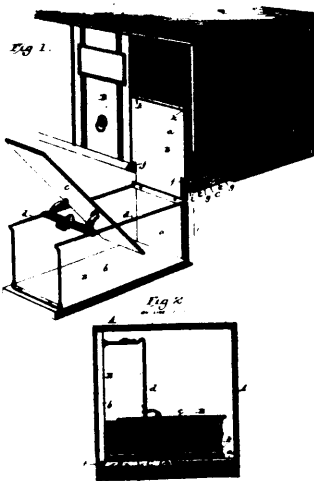

31608 Jewell's File Box.

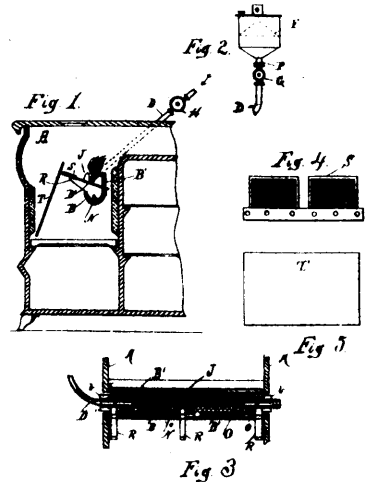

31609 Schreiner's Oil Burner.

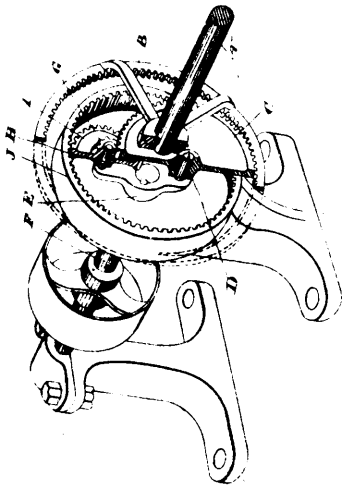

31610 Carter's Machine for Multiplying Power.

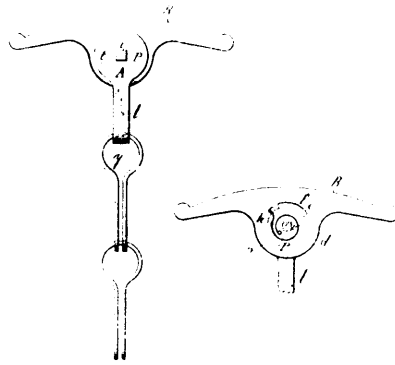

31611 Kelsey's Chain Fastener

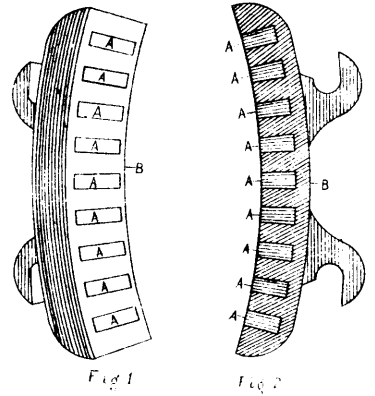

31612 Whalen, Case and Gardner's Railway Brake Shoe.

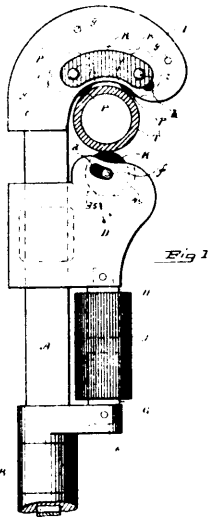

31613 Worthen & Pendleton's Wrench.

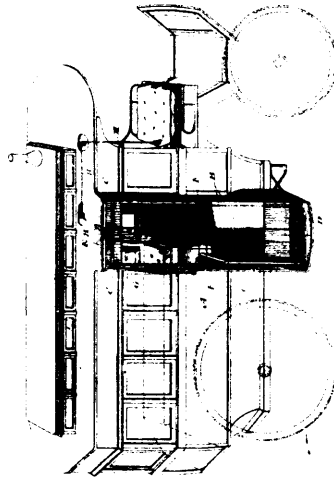

31614 Dyer's Coach

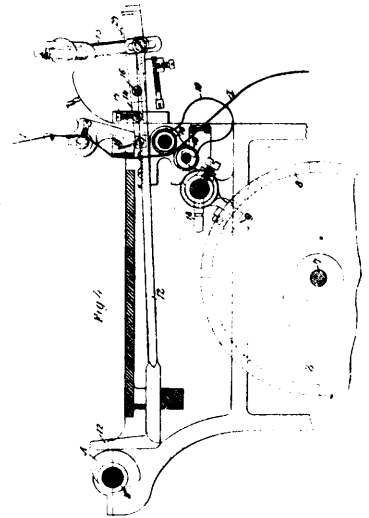

31615 Moseley's Card for Carding Cotton, etc.

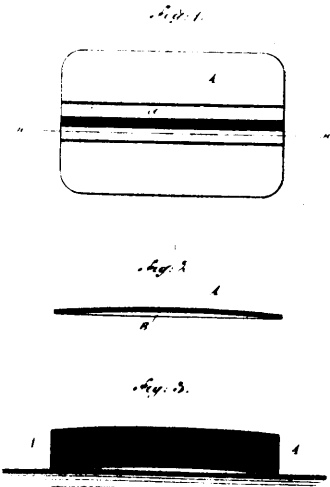

31616 Rose's Samples of Paints, etc.

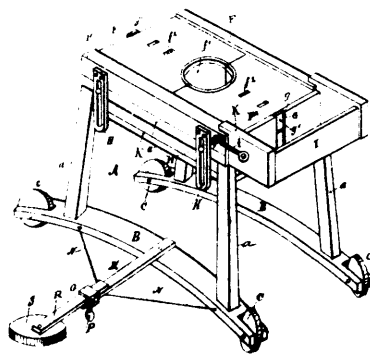

31617 Lane & Doney's Baby Walker.

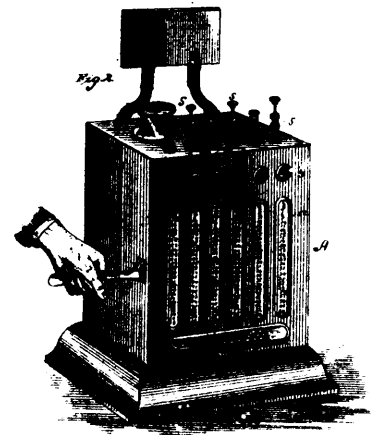

31618 Brooks' Calculating Machine

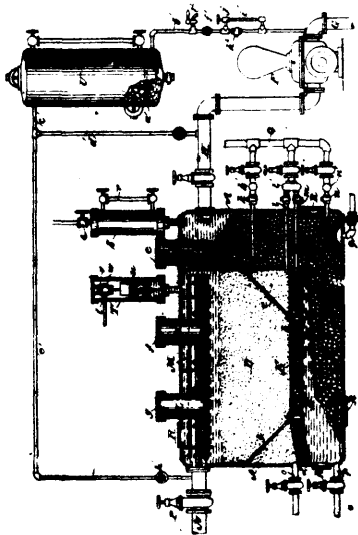

31618 Oliphant's Apparatus for Liquid Purification.

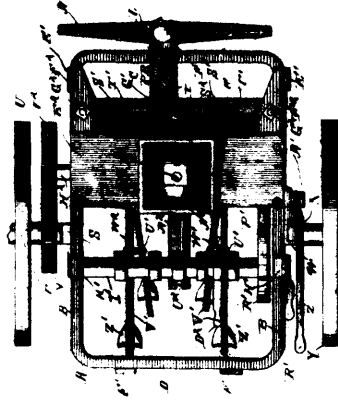

31620 McBride's Cultivator, Plough, etc.

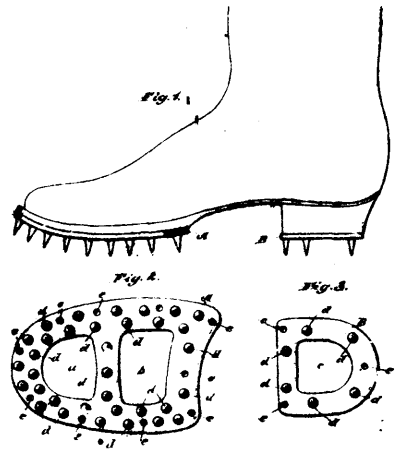

31621 Beauchemin's Sole and Heel Plate.

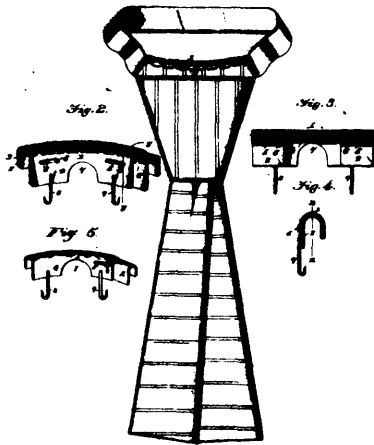

31622 Moyer's Scarf Protector.

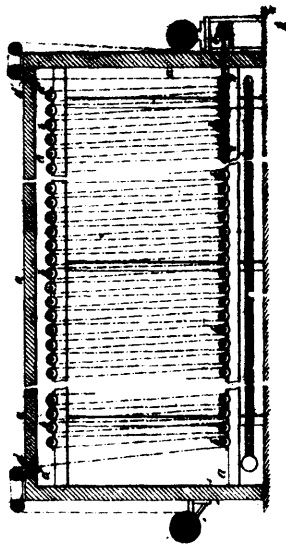

31623 Waddington's Vulcanisation of Water-proofed Fabrics, etc.

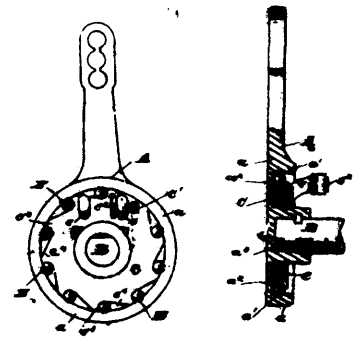

31624 Evans' Bicycle Clutch.

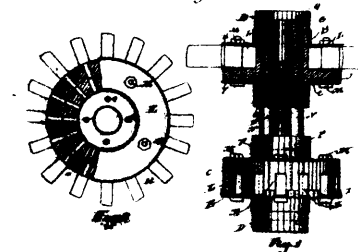
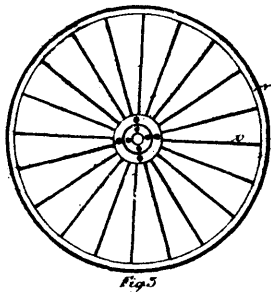

31625 Gibeault's Hub for Wheels.

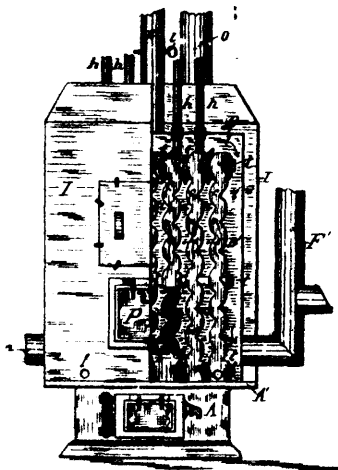

31626 Kelsey's Steam and Hot Water Boiler.

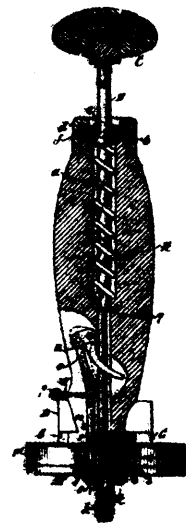

31627 Patten's Nail Driver.

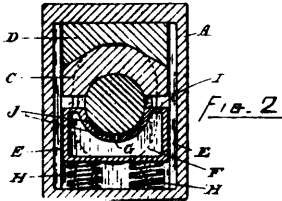
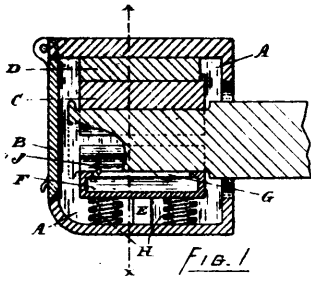

31628 Best's Car Axle Box.

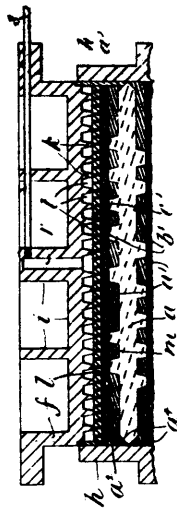

31629 Howard's Apparatus for Pressing Pulp.

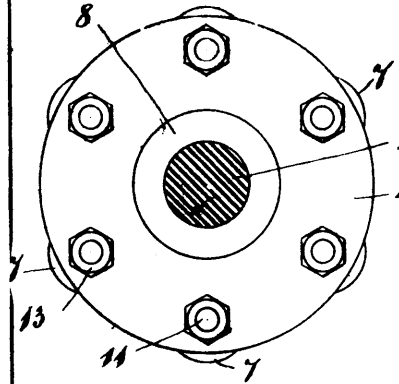

31630 Leslie's Apparatus for Grinding the Cards of Carding Engines.

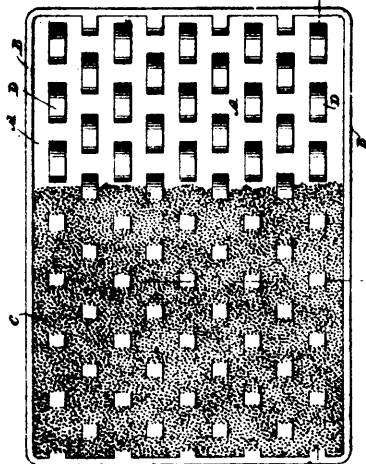

31631 Gibson's Storage Battery Plate.

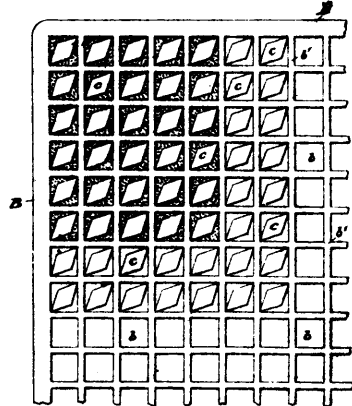

31632 Gibson's Storage Battery Plate.

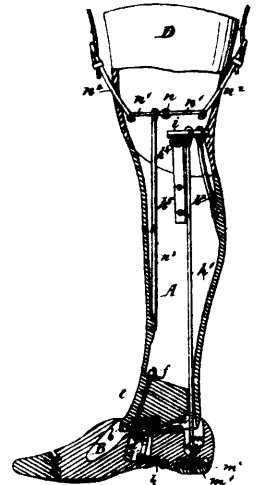

31633 Frees' Artificial Leg.

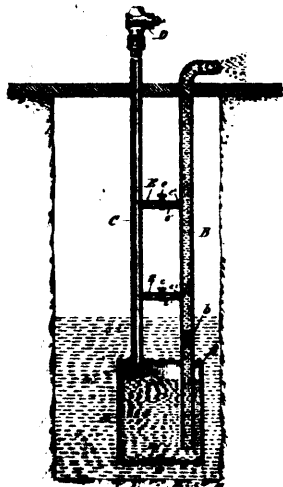

31634 Pohl's Water Elevator.

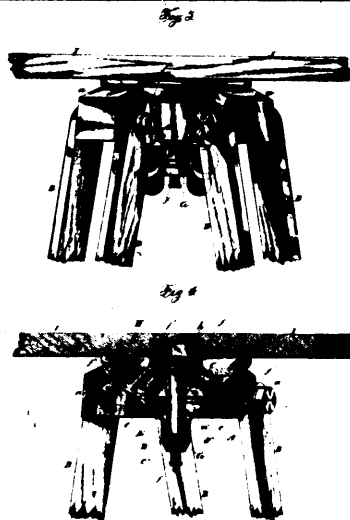

31635 Johnson's Tripod Head for Surveying Instruments.

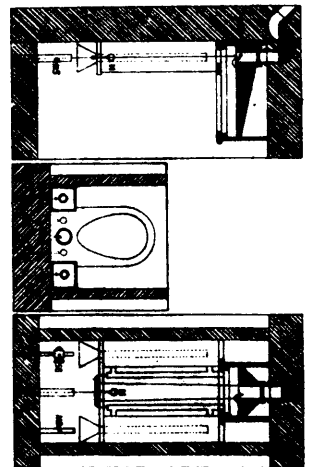

31636 Newton's Method of Dealing with the Effluent of Drains, etc.

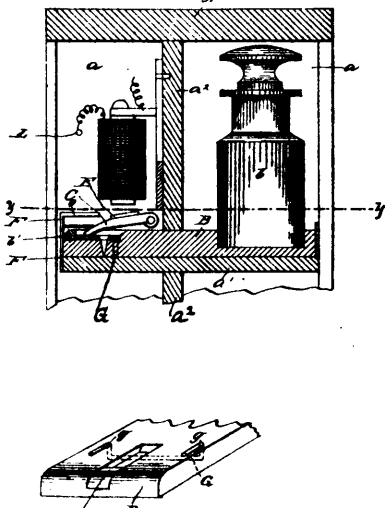

31637 Mahew's Receptacle for Poison

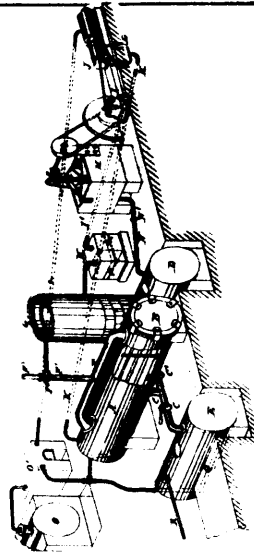

31638 Boulton's Apparatus for Treating Timber with Antiseptic or Preservative Fluid.

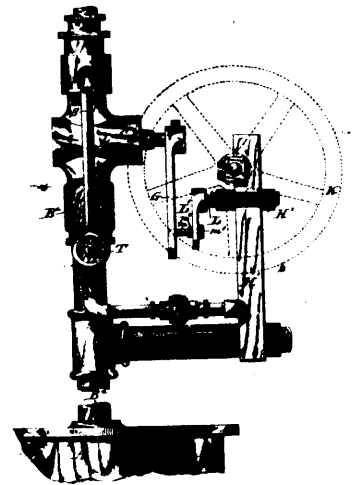

31639 Pohlé & Hill's Pneumatic Water Elevator.

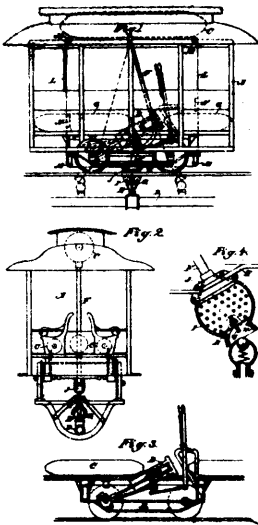

31640 Pressley's Air Supply for Propelling Cars.

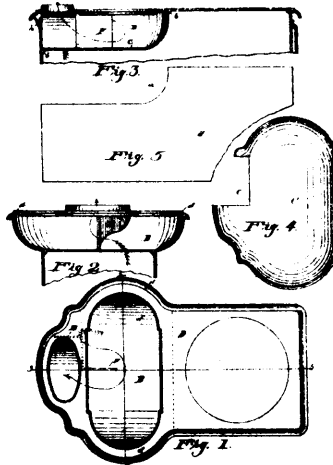

31641 McMaster's Stove.

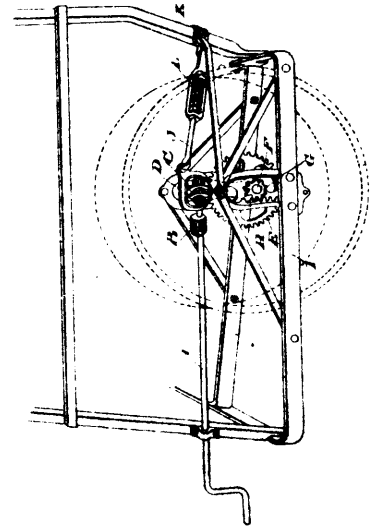

31642 McLachlan's Harvester.

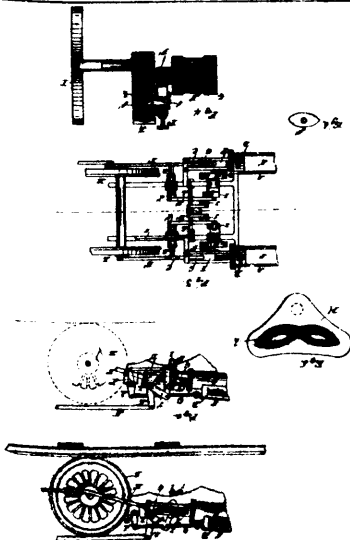

31643 Welch's Valve Gear.

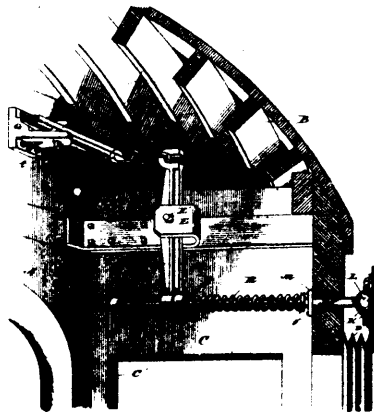

31644 Sessions' Equalizer for Car Vestibules

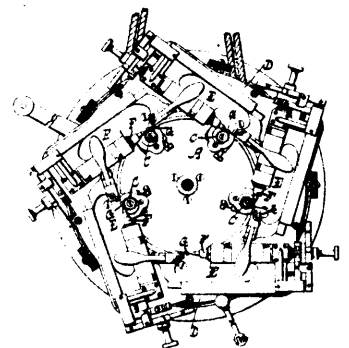

31646 Leman's Manufacture of Watches, etc.



31647 Warren's Manufacture of Scythes.

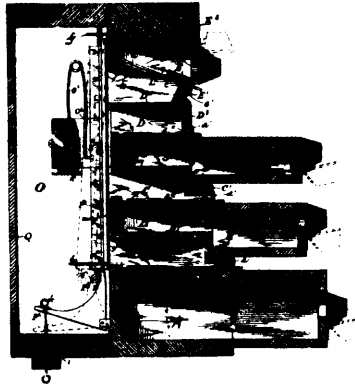

31648 Wright's Reed Organ.

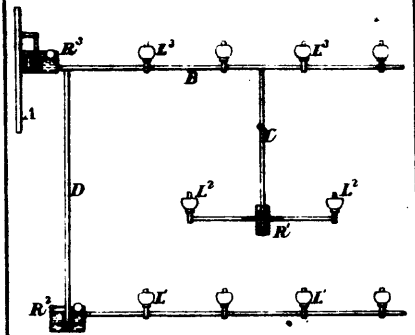

31649 Fenby's Apparatus for Supplying Oil for Lamps.

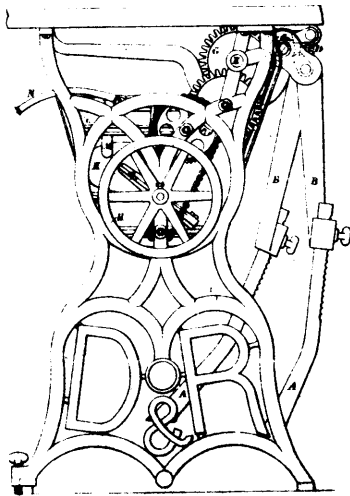

31650 Dohle's Driving Gear for Table Machines for Sewing, etc.

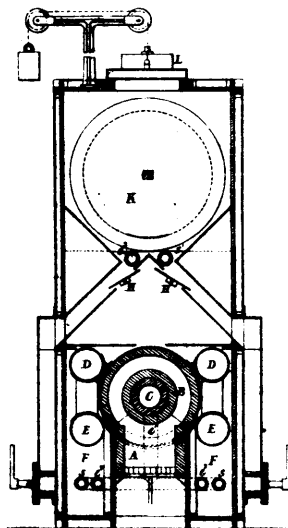

31651 Bowen, Tomkins & Cobeldick's Manufacture of Charcoal.

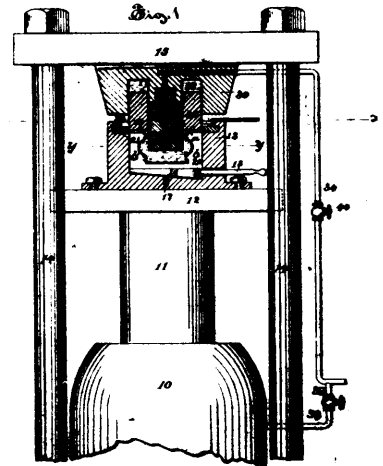

31652 Hobson's Hydraulic Shaping Press.

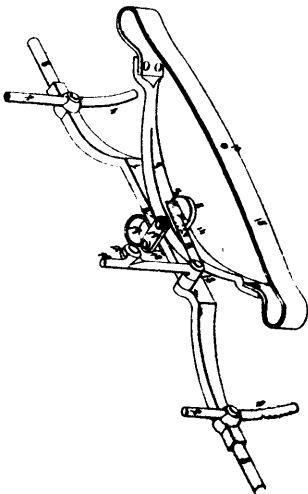

31653 Portmann's Spring Rocker Gear, etc.

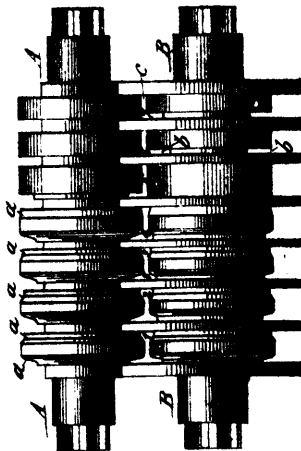

31654 Vaughan's Rolls for Converting Old Balls into Angle Iron.

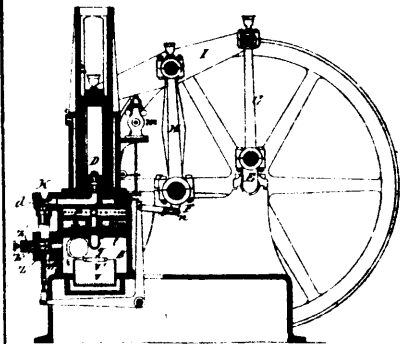

31655 Quack's Motor Engine.

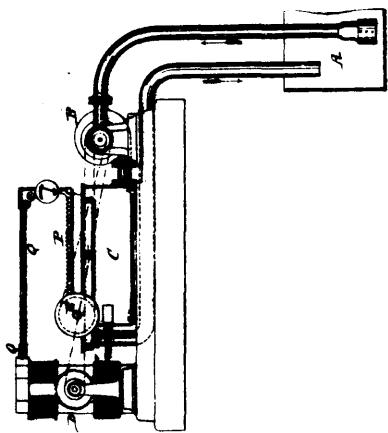

31656 Hermits & Cooper's Apparatus for Electrolyzing Bleaching Solutions.

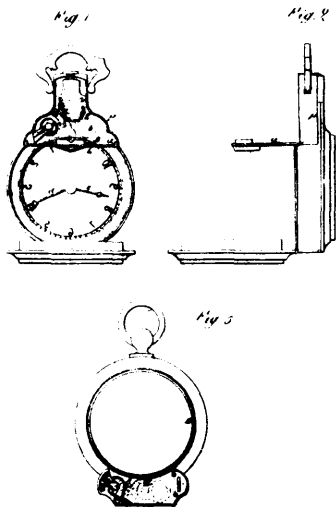

31657 Rime's Watch.

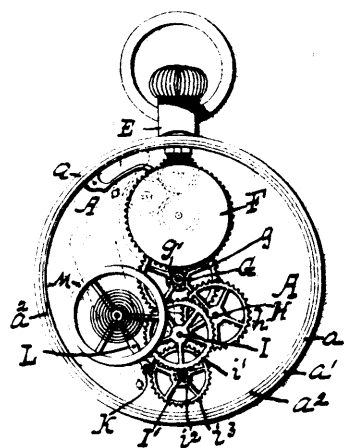

31658 Potter's Watch.

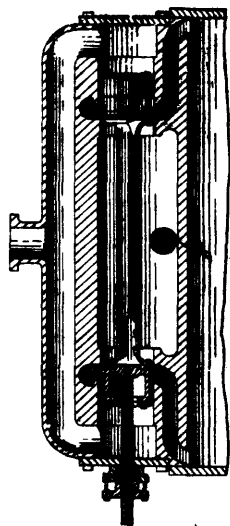

31659 Allen's Valve for Steam Engines.

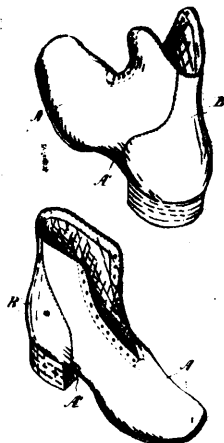

31660 Godin's Boot

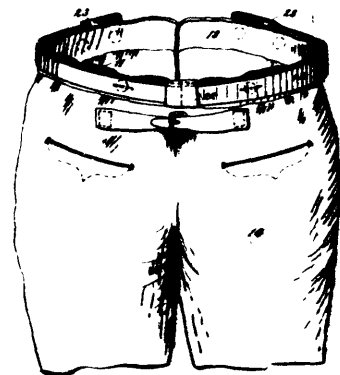

31661 Bevinger's Hip Belt.

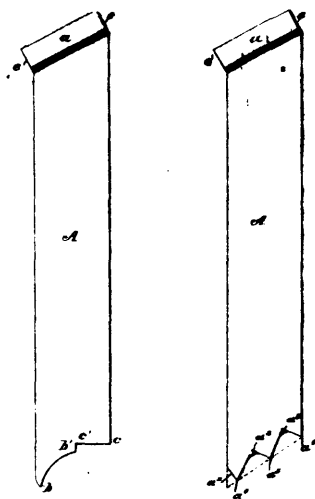

31662 Davies' Railway Spike.

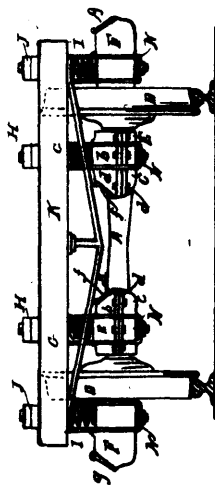

31663 Pettengill & Chappell's Car Truck.

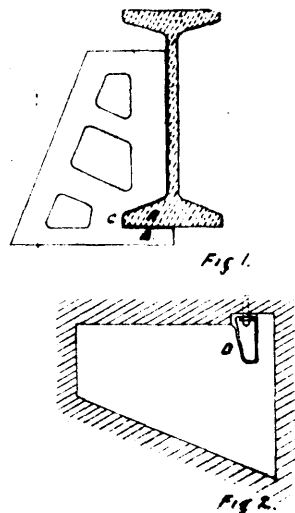

31664 Landeroth's Skew-back.

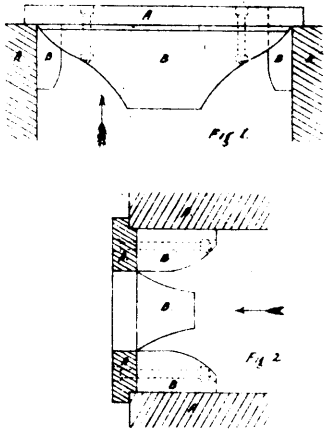

31666 Lenderoth's Apparatus for Regulating the Flow of Plastic Mixtures of Clay, etc.

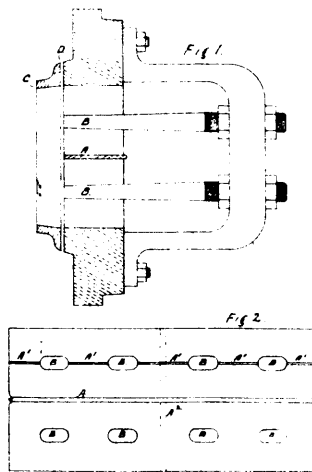

31667 Lenderoth's Manufacture of Flat Blocks and Slabs from Clay.

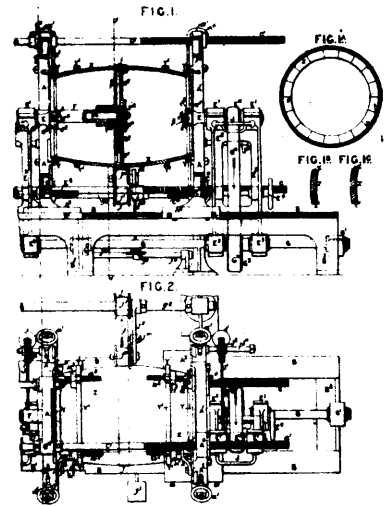

31668 Wright's Barrel and Package, etc.

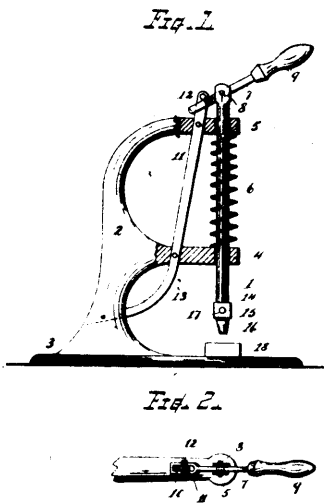

31669 Overbey's Belt Punch.

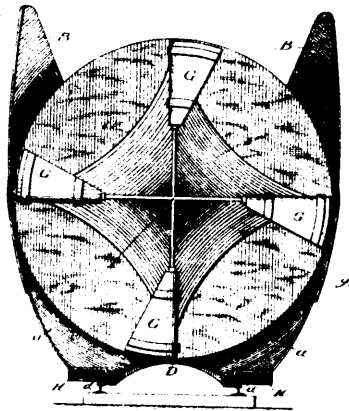

31670 Haughwout's Snow Plough.

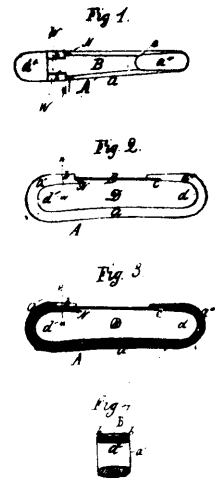

31671 Coleman's Snap Link.

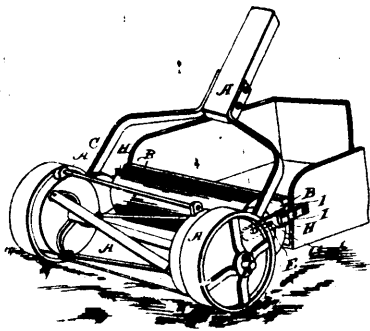

31672 Peterson's Lawn Mower.

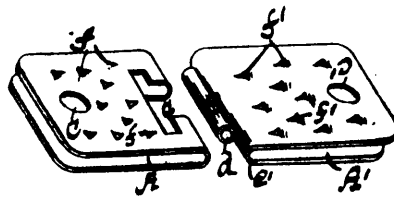

31673 Avery's Belt Fastener.

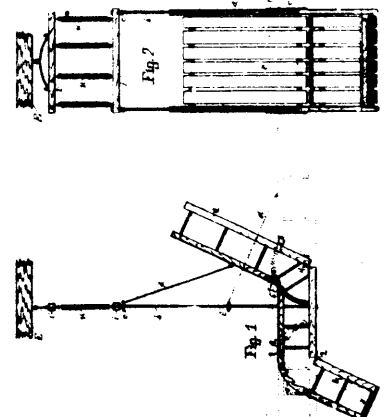

31674 Schutt's Chair.

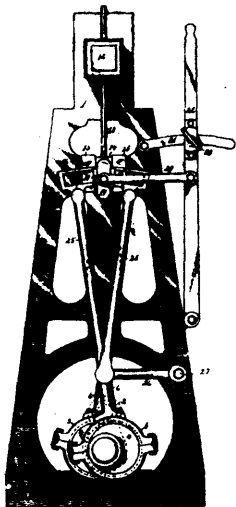

31675 Fox's Gear for Engines

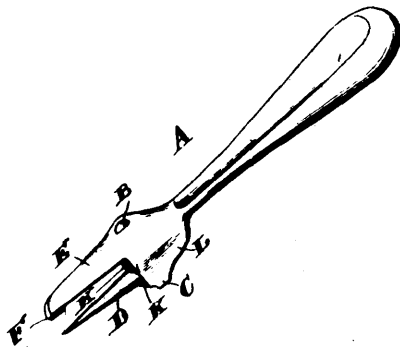

31676 French's Can Opener.

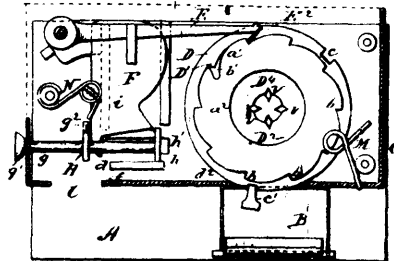

31677 Headley & Horton's Coin Receptacle, etc.

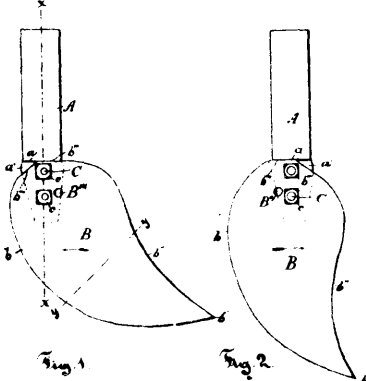

31678 Walker's Plough Colter.

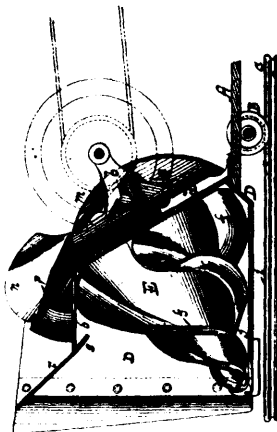

31679 Jull's Snow Plough.

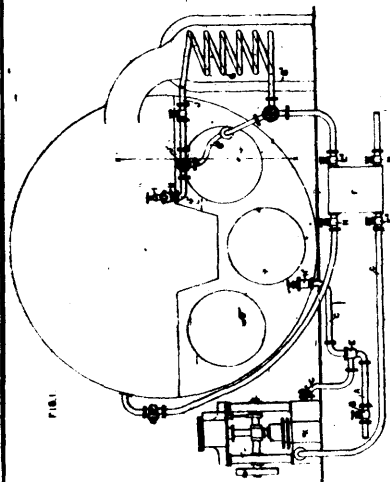

31680 Fraser's Feed Heating and Water Circulating Apparatus

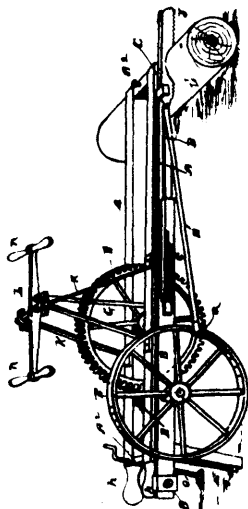

31681 Hughes' Drag Sawing Machine.

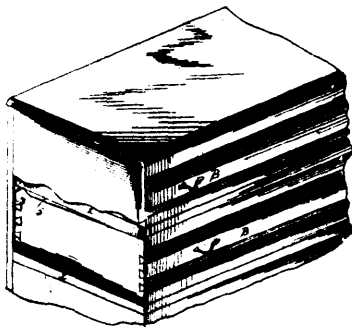

31682 Clapp's Furniture Drawer.

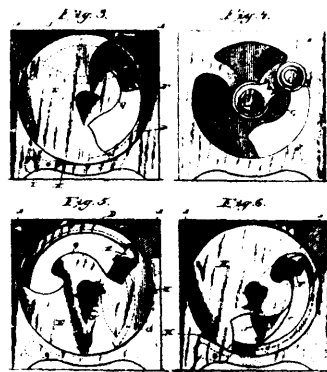

31684 Allyn & Evans' Fire Grate

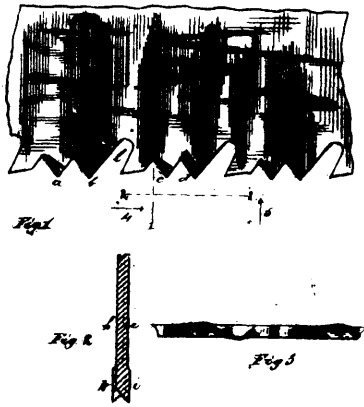

31685 Bundy's Saw.

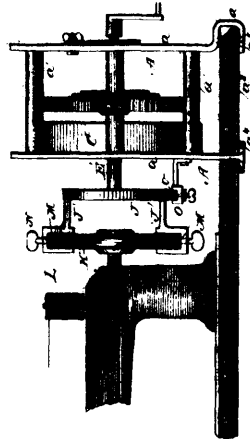

31686 Pearce's Motor.

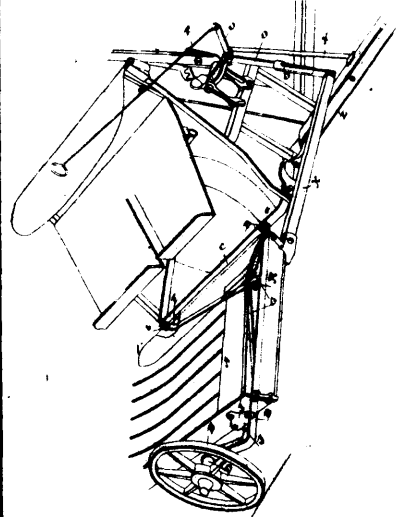

31687 Johnston & McLachlan's Bundle Carrier for Harvesters.

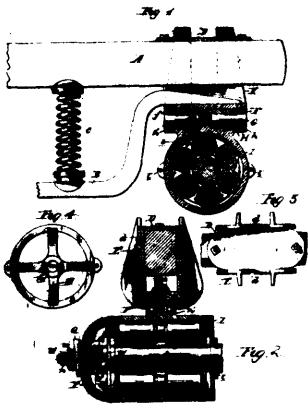

31688 Sharpneck's Journal Box.

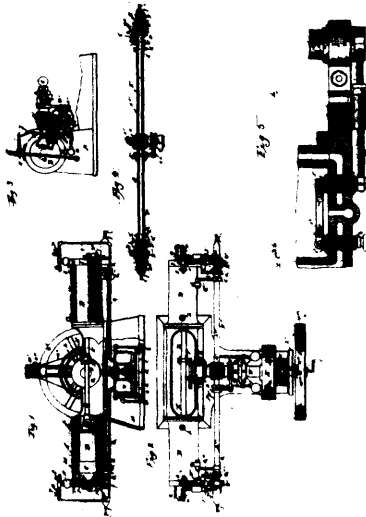

31689 Rogers & Wharry's Gas Engine.

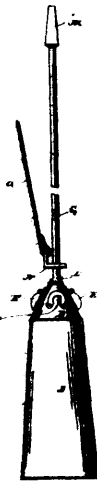

31690 Stoltze's Apparatus for Raising Quick Sand.

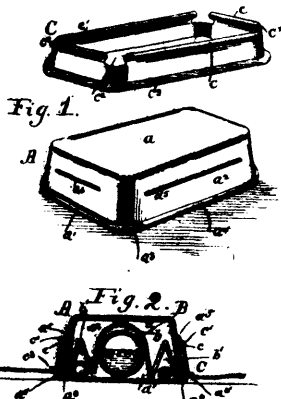

31691 Weed's Tablet for Indolible Ink Marking.

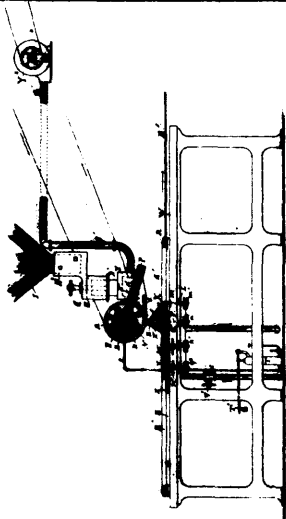

31692 Schroeder's Machine for Pulling Hairs from Skins.

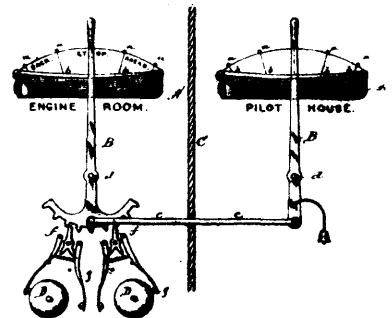

31694 Roe's Signal for Steamboats.

INDEX OF INVENTIONS.

Advertising : see Sparkling.		
Advertising rack. I. H. Randall.....	31,546	
Air supply for propelling cars. L. C. Pressley.....	31,640	
Alarm : see Electric.		
Alcohol. Rectification of. A. T. Christophe.....	31,540	
Alloys : see Aluminium.		
Aluminium alloys. Manufacture of. C. M. Hall.....	31,516	
Aluminium. Manufacture of. C. M. Hall.....	31,515	
Aluminium : see Electrolysing.		
Aluminium : see Electrolysis.		
Armature for dynamos. E. Thomson.....	31,485	
Armature for dynamos. Thomson-Houston International Electric Co.....	31,485	
Artificial leg. C. A. Frees.....	31,633	
Baby walker. W. Lane et al.....		
Bag : see Envelope.		
Base ball bat. C. N. Morris.....	31,541	
Bat : see Base.		
Bath or solution for separating metal from their ores. J. C. Wiswell.....	31,522	
Baths and wash bowls. Overflow for. E. Bellavance	31,511	
Belt : see Hip.		
Belt fastener. W. G. Avery.....	31,673	
Belt punch. H. L. T. Overbey.....	31,669	
Belting. Method of manufacturing. J. E. Emerson et al.....	31,576	
Bicycle clutch. J. E. Evans.....	31,624	
Blider : see Bundle.		
Blocks and slabs from clay mixtures. Manufacture of flat. W. Lenderoth.....	31,667	
Bluing package. T. F. Conklin.....	31,499	
Boot and shoe. J. Godin.....	31,660	
Boiler. Steam and hot water. W. W. Kelsey.....	31,626	
Box : see Car. Journal, Suspension.		
Brake : see Sled.		
Brick and artificial stone. Composition for. O. Leblanc et al.....	31,539	
Bridge. W. Harman.....	31,585	
Broom corn. Machine for assorting. C. E. Lipe.....	31,482	
Broom corn. Machine for assorting. Hand-Stitch Broom Sewing Machine Co.....	31,482	
Broom sewing machine. G. F. McCombs.....	31,548	
Bundle carrier for binders. W. F. Johnston.....	31,687	
Bureau. D. C. Clapp et al.....	31,570	
Burner : see Gas. Lamp. Safety.		
Button setting machine. A. M. English.....	31,519	
Cabinet show case. E. Pifferling ..	31,558	
Calculating : see Coin.		
Can opener. J. F. French.....	31,676	
Car axle box. E. Best.....	31,628	
Car axle lubricator. T. Saunders et al.....	31,532	
Car coupling link. J. Ptolemy.....	31,582	
Car truck. F. E. Pettengill et al.....	31,663	
Card for carding cotton, wool, etc. C. Moseley.....	31,615	
Card : see Playing.		
Cards of Carding engines. J. Leslie.....	31,630	
Carpets. Machine for stretching. T. Sturdy.....	31,594	
Casks, barrels, box barrels or packages. Manufacture of. S. Wright.....	31,668	
Chain fastener. H. E. Kelly.....	31,611	
Chair. M. E. Schutt.....	31,674	
Charcoal. O. Bowen et al.....	31,651	
Check : see Price.		
Churn. S. Ward.....	31,601	
Clasp. M. Rubin.....	31,496	
Closet : see Dry.		
Clothes : see Felt.		
Clutch : see Bicycle.		
Coach. J. L. Dyer.....	31,614	
Coffee. Compound for coating. F. W. Moore.....	31,483	
Coffee. Compound for coating. J. T. Barnes.....	31,483	
Coin operated calculating machine. F. W. Brooks.....	31,618	
Coin operated induction coil. P. G. Williams et al.....	31,523	
Coin receptacle and register. E. Headley et al.....	31,677	
Copper. Manufacture of. P. C. Gilchrist.....	31,503	
Corn : see Broom.		
Corset. C. A. Williamson.....	31,498	
Cultivator plough, etc. A. B. McBride.....	31,620	
Curb and gutter. A. G. Parkhurst.....	31,596	
Digger : see Potato.		
Digester : see Fibre.		
Door : see Freight.		
Drag sawing machine. G. A. Hughes.....	31,681	
Drains and sewers. Method of dealing with. H. R. Newton.....	31,636	
Drawer : see Furniture.		
Drill. T. Goserud.....	31,542	
Dry closet. L. B. Robb.....	31,569	
Drying porous hollow-ware. Method of. W. Lenderoth.....	31,665	
Dynamo electric machine. Regulator for. J. F. Keaster.....	31,573	
Dynamos : see Armature.		
Electric signalling and alarm apparatus. W. L. Denio et al.....	31,531	
Electric signalling apparatus. Transmitting instruments for. W. J. Dudley.....	31,521	
Electrically lighting railway trains. Apparatus for. I. A. Timmis.....	31,547	
Electrolyzing bleaching solutions. Apparatus for. E. Hermite et al.....	31,656	
Electrolyzing crude salts of aluminium. Process of. C. M. Hall.....	31,514	
Electrolyzing fused salts of aluminium. Process of. C. M. Hall.....	31,517	
Electrolysis. Process of reducing aluminium by. C. M. Hall.....	31,512	
Electrolysis. Process of reducing aluminium from its fluorid salts by. C. M. Hall.....	31,513	
Elevator. D. C. Baitey.....	31,518	
Elevator. J. G. Pohlé.....	31,639	
Engine : see Gas. Hydraulic. Motor.		
Engines. Cut-off and reversing gear for. C. Fox.....	31,675	
Envelope and tag fastener. F. C. Mercer.....	31,560	
Envelope or bag machine. G. R. Clarke.....	31,552	
Equalizer for car vestibules. H. H. Sessions.....	31,644	
Extinguishing : see Igniting.		
Fabric. J. J. Ashworth.....	31,693	
Fabric : see Waterproof. Woven.		
Fanning mill. H. Bolton.....	31,583	
Fastener : see Chain. Railway.		
Faucet. E. U. Scoville.....	31,579	
Feed heating and water circulating apparatus. R. Fraser.....	31,680	
Feed water heater and purifier. J. T. Lee.....	31,586	
Felt and felt cloth. J. W. Eastwood.....	31,533	
Fiber digester. J. H. Brown.....	31,549	
Finger shield and fountain attachment. J. Patmor.....	31,475	
Finish for plastered walls. T. Jones.....	31,494	
Fire escape. H. LeR. Boyle.....	31,554	
Fire escape. V. J. Klase et al.....	31,550	
Fire grate. J. H. Allyn et al.....	31,684	
Flies. Device for killing. J. B. Kibler et al.....	31,479	
Fluid meter. J. R. Norfolk.....	31,598	
Fluid separating machine. W. Bergh.....	31,534	
Fountain : see Flinger.		
Freight car door. J. Montgomery.....	31,595	
Fur animals. Machine for pulling hairs from skins of. E. Schroeder.....	31,692	
Furnaces. Refractory crucible, pot, brick and lump for. A. Mozczynsky.....	31,645	
Furniture drawer. D. C. Clapp et al.....	31,682	
Gas burner and heater. D. S. Robillard et al.....	31,525	
Gas engine. N. Rogers et al.....	31,689	
Garment stay. E. C. Bowling.....	31,509	
Gate. A. J. Mercer.....	31,489	
Gear : see Valve.		
Gear wheel. M. T. Graf.....	31,597	
Grain scouring machine. J. C. Fisher.....	31,583	
Grate : see Fire.		
Grooving or routing machine. J. A. Harvey.....	31,471	
Gutter : see Curb.		
Handle : see Plough.		
Harvester. J. C. McLachlan.....	31,642	
Hatchet for shingling. B. C. Pettingell.....	31,575	
Heater : see Gas.		
Heat to the body. Device for applying. D. M. Small.....	31,507	
Hides, skins or scraps in liquids. Method of treating. C. W. Cooper.....	31,545	
Hip belt. W. H. Bevinger.....	31,661	
Hoops. Machine for cutting. O. Schimansky.....	31,543	
Hoops. Machine for pointing. O. Schimansky.....	31,544	
Hoops. Machine for pointing and lapping. A. F. Ward.....	31,574	
Hoisting machine. T. W. Lemieux.....	31,564	
Holdback for vehicles. G. T. Wilson.....	31,484	
Household utensil. R. Lindsay.....	31,563	
Hub for wheels. U. Gibeault.....	31,625	
Hydraulic engine. G. Guest.....	31,604	
Hydraulic shaping press. A. E. Hobson et al.....	31,652	
Igniting and extinguishing apparatus. H. A. Chapin.....	31,497	
Induction coil : see Coin.		
Jack : see Lifting.		

Journal box. Anti-friction. W. S. Sharpneck.....	31,688	Sewers: see Drains.	
Ladder: see Metallic.		Sewing machine pedal. A. A. Laviolette.....	31,481
Ladder. J. R. Smith et al.....	31,477	Sewing machine pedal. O. Feher.....	31,481
Lamp burner. S. Ellis et al.....	31,553	Sewing: see Broom. Trimming.	
Lamps. Method and apparatus for supplying oil to. J. B. Fenby.....	31,649	Sharpener: see Saw.	
Lantern: see Tubular.		Shoe: see Railway.	
Lawn mowers. Attachment for. H. Peterson.....	31,672	Shots or spheres of fragments of iron, steel and metal. Process and apparatus for producing. L. Keyling.....	31,580
Letter file. Z. A. Lash.....	31,527	Show case: see Cabinet.	
Lever for operating the jaws of vices or tongs. E. Beauchamp.....	31,562	Signal for steamboats. C. C. Roe.....	31,694
Lifting jack. C. T. Eddy.....	31,566	Signalling: see Electric.	
Lighting: see Electrically.		Skewback. W. Lenderoth.....	31,664
Lime. G. E. Carleton.....	31,590	Skins: see Hides.	
Link: see Car.		Slabs: see Blocks.	
Liquid purification. Apparatus for. W. Oliphant.....	31,619	Slate: see Roof.	
Lock: see Mortise. Nut.		Sled brake. J. R. Holt.....	31,493
Lock stitch. W. Carey.....	31,584	Sleeper. H. Hipkins.....	31,581
Lubricator: see Car axle.		Snap link. V. A. Coleman.....	31,671
Medicinal compound. J. F. Lindgren et al.....	31,683	Snow plough. J. W. Haughawout.....	31,870
Medicinal compound. M. McLeod.....	31,495	Snow plough. O. Jull.....	31,679
Metal wheel. H. R. Bothwell.....	31,472	Sole and heel plate. L. N. Beauchemin.....	31,621
Metallic ladder. J. R. Smith et al.....	31,477	Sparkling effect for advertising, etc. Means for pro- ducing, E. and F. Smith.....	31,600
Meter: see Fluid.		Spike: see Railway.	
Mill: see Fanning. Roller.		Spring rocker gear and centre bearing spring for rockers, etc. H. G. and W. W. Portman.....	31,653
Millstone. C. J. Potter.....	31,559	Sprinkler. A. Waeber.....	31,567
Motor. W. Pearce et al.....	31,686	Stay: see Garment.	
Motor engine. E. Quack.....	31,655	Steam trap. J. Carell.....	31,578
Motor engine operated by hydrocarbon vapour. W. D. and S. Priestman.....	31,599	Stereotype plates. Machine for separating, trimming and grooving. J. R. Cummings.....	31,501
Mortise lock. O. R. Cooke.....	1,4903	Stone: see Brick.	
Mower: see Lawn.		Storage battery plate. C. D. P. Gibson.....	31,632
Multiplication sums. Apparatus for calculating. P. C. Ilgen.....	31,572	Stove. J. McMaster.....	31,641
Musical instrument. E. R. Narcoss et al.....	31,476	Suspender. B. Goodman.....	31,504
Nail driver. J. Patten.....	31,627	Suspension file box. M. R. Jewell.....	31,608
Nut lock. L. A. Dion.....	31,606	Surveying: see Tripod.	
Nuts or bolts. Means for locking. F. Purbrick et al.....	31,500	Switch: see Railway.	
Organ: see Reed.		Table machine for sewing and knitting. Driving gear for. P. A. Dohis.....	31,650
Paint. Samples of. F. H. Rose.....	31,616	Tablet for indelible ink marking. W. A. Weed.....	31,691
Paper. Machine for ornamenting. C. G. Mortimer.....	31,551	Telegaphy: see Telephony.	
Pedal: see Sewing.		Telephony and telegraphy. C. L. Davies.....	31,603
Plastic mixtures of clay, sawdust, etc. Apparatus for regulating the flow of. W. Lenderoth.....	31,666	Thermometer. W. F. Brewster.....	31,502
Plate: see Storage.		Tickets. Apparatus for issuing, recording and num- bering. R. J. H. Rastrick.....	31,588
Playing card. R. F. Foster et al.....	31,487	Timber. Method and apparatus for treating with an- tiseptic or preservative fluid. S. B. Boutin.....	31,638
Plough colter. L. Walker.....	31,678	Tire heating apparatus. W. Hassman.....	31,510
Plough handle. S. I. Allen.....	31,587	Tire: see Wheel.	
Plough: see Cultivator. Snow.		Tobacco. Device for moistening. J. McPherson.....	31,491
Plumber's traps. Return vent protector for. W. B. and P. Ryan.....	31,480	Transfer system of electrical distribution. E. Thomson.....	31,535
Pocket fastener. B. Woodsford.....	31,565	Trap: see Steam.	
Poisons. Receptacle for. T. Mayhew.....	31,637	Tree and plant setting machine. T. A. Sutton.....	31,470
Potato digger. A. Rigby.....	31,602	Trimming attachment for sewing machines. J. W. Dewees.....	31,593
Press. Machine for multiplying. J. W. Scott.....	31,610	Tripod head for surveying instruments. W. D. John- son.....	31,635
Press: see Hydraulic.		Truck: see Car.	
Price and inventory check. C. S. De Witt.....	31,589	Truss. G. W. Bell.....	31,474
Protector: see Plumber's Traps.		Tubular lantern. J. Lind.....	31,488
Pulp. Apparatus for pressing. F. B. Howard.....	31,629	Utensil: see Household.	
Punch: see Belt.		Valve for steam engines. W. J. Allen.....	31,659
Quick sand. Apparatus for raising. H. Stoltze.....	32,690	Valve gear. Non-eccentric. M. I. Welch et al.....	31,643
Rack: see Advertising.		Vaporizing apparatus. H. F. Williams.....	31,592
Railway brake shoe. R. F. Whalen et al.....	31,612	Vehicle axle. W. H. Wright.....	31,568
Railway rail joint fastener. N. Rowen et al.....	31,486	Vehicles. Elastic draft for. A. B. Webster.....	31,473
Railway spike and method of making same. T. A. Davies.....	31,662	Vehicles. Holdback for. G. T. Wilson.....	31,484
Railway switch. S. Cameron.....	31,605	Vehicles. Running gear for. T. G. Mandt.....	31,524
Razors. Device for sharpening. P. J. Cesar et al.....	31,478	Vending apparatus. J. M. O'Kelly.....	31,607
Reed organ. M. S. Wright.....	31,648	Ventilation: see Window.	
Rheostat. J. L. Gish.....	31,577	Wall: see Finish.	
Ring. G. H. Knight.....	31,557	Washing machine. H. O. Kelsey et al.....	31,492
Roof slates. Fastening for. O. W. Narcross.....	31,555	Watch. A. H. Potter.....	31,658
Roll for converting old rails into angle iron. A. Vaughan.....	31,654	Watch case. E. F. Heffernan.....	31,537
Roller mills. Feed gate for. H. M. Whitney.....	31,506	Watch case. F. Ecaubert.....	31,505
Routing: see Grooving.		Watch mechanism, etc. F. Leman.....	31,646
Salts: see Aluminium.		Watch with transparent body. H. Rime.....	31,667
Safety oil burner. H. Schreiner et al.....	31,609	Water conductors. Support for. J. Davis.....	31,526
Sand: see Quick.		Waterproof fabrics, etc. Vulcanization of. H. H. Waddington.....	31,623
Saw. W. Bundy et al.....	31,530	Wheel. Metal. H. R. Bothwell.....	31,472
Saw gummer and sharpener. M. I. Welch.....	31,561	Wheel: see Gear.	
Sawing: see Drag.		Wheel tire. W. B. Morris.....	31,591
Scarf protector. J. H. Moyer.....	31,622	Window ventilation. N. McDonald et al.....	31,536
Scraps: see Hides.		Woven fabrics. Machine for inserting diagonal strip into. H. B. Morris.....	31,520
Seythe. H. H. Warren.....	31,647	Wrench. W. C. Worthen et al.....	31,613
Semaphore. J. M. Kirby et al.....	31,529		
Setting: see Tree.			
Sewage, etc. Treatment of. H. Wollheim.....	31,508		

INDEX OF PATENTEES.

Ajax Envelope Co. Envelope or bag machine.....	31,552
Albright, M. M., et al. Musical instrument.....	31,476
Allen, S. I. Plough handle.....	31,567
Allen, W. J. Valves for steam engines.....	31,659
Allyn, J. H. Fire grate.....	31,684
American Watch Case Co. Watch case.....	31,537
Ashworth, J. J. Fabric.....	31,693
Automatic Vending Box Co. Vending apparatus.....	31,607
Auto-Pneumatic Car Motor Co. Air supply for propelling cars.....	31,640
Avery, W. G. Belt fastener.....	31,673
Barnes, J. T. Compound for coating coffee.....	31,483
Batty, D. C. Elevator.....	31,518
Beauchamp, E. Lever for operating the jaws of vices or tongs.....	31,562
Beauchemin, L. N. Sole and heel plate.....	31,621
Bell, G. W. Truss.....	31,474
Bellavance, E. Overflow for baths and wash bowls.....	31,511
Bergh, W. Fluid separating machine.....	31,634
Best, E. Car axle box.....	31,628
Bevinger, W. H. Hip belt.....	31,661
Bolton, H. Fanning mill.....	31,583
Bothwell, H. R. Metal wheel.....	31,472
Boulton, S. B. Method and apparatus for treating timber with antiseptic or preservative fluid.....	31,638
Bowen, O., et al. Charcoal.....	31,651
Bowling, E. C. Garment stay.....	31,509
Boyle, H. Le R. Fire escape.....	31,654
Brewster, W. F. Thermometer.....	31,502
Briggs, J. H. Regulator for dynamo electric machines.....	31,573
Brooks, F. W. Coin operated calculating machine.....	31,618
Brown, J. H. Fiber digester.....	31,549
Bundy, W., et al. Saw.....	31,530
Caesar, P. J., et al. Device for sharpening razors.....	31,478
Cameron, S. Railway switch.....	31,605
Carey, W. Lock stitch.....	31,584
Carleton, G. E. Lime.....	31,590
Carter, D. W. Machine for multiplying power.....	31,610
Case, C., et al. Railway brake shoe.....	31,612
Chappell, T. F., et al. Car truck.....	31,663
Chapin, H. A. Igniting and extinguishing apparatus.....	31,497
Chown, C. D., et al. Stove.....	31,641
Christie, T. T. Machine for pointing and lapping hoops.....	31,574
Christophe, A. T. Rectification of alcohol.....	31,540
Clapp, D. C., et al. Bureau.....	31,571
Clapp, D. C., et al. Furniture drawer.....	31,682
Clark, G. R. Envelope or bag machine.....	31,552
Cobeldick, J., et al. Charcoal.....	31,651
Coleman, V. A. Snap link.....	31,671
Conklin, T. F. Bluing package.....	31,499
Connor, J. H., et al. Metallic ladder.....	31,477
Cooke, O. R. Mortise lock.....	31,490
Cooper, C. F., et al. Apparatus for electrolyzing bleaching solutions.....	31,656
Cooper, C. W. Method of treating hides, skins, or scraps in liquids.....	31,545
Coreil, J. Steam trap.....	31,578
Cummings, J. R. Machine for separating, trimming and grooving stereotype plates.....	31,501
Cunningham, H., et al. Stove.....	31,641
Davies, C. G., et al. Gas burner and heater.....	31,525
Davies, C. L. Telephony and telegraphy.....	31,603
Davis, J. Support for water conductors.....	31,526
Davis, T. A. Railway spike and method of making same.....	31,662
Décary, A. C., et al. Composition for brick and artificial stone.....	31,539
Denis, W. L., et al. Electric signalling and alarm apparatus.....	31,531
Deweese, J. W. Trimming attachment for sewing machines.....	31,593
Dewitt, C. S. Price and inventory check.....	31,589
Dion, L. A. Nut lock.....	31,606
Dohis, P. A. Driving gear for table machines for sewing, knitting, etc.....	31,650
Doney, A., et al. Baby walker.....	31,617
Driggs, W. W., et al. Railway brake shoe.....	31,612
Dudley, W. J. Transmitting instrument for electric signalling apparatus.....	31,521
Dyer, J. L. Coach.....	31,614
Eastwood, J. W. Felt and felt cloth.....	31,533
Ecaubert, F. Watch case.....	31,505

Eddy, C. T. Lifting jack.....	31,566
Elken, A., et al. Medicinal compound.....	31,683
Ellis, S., et al. Lamp burner.....	31,563
Emerson, J. E. Method of manufacturing belting.....	31,576
English, A. M. Button setting machine.....	31,519
Estey, D. M., et al. Bureau.....	31,570
Estey, D. M., et al. Furniture drawer.....	31,682
Estey Manufacturing Co. Bureau.....	31,571
Estey Manufacturing Co. Furniture drawer.....	31,682
Evans, H. P. Fire grate.....	31,684
Evans, J. E. Bicycle clutch.....	31,624
Feher, O. Sewing machine pedal.....	31,481
Fenby, J. B. Method and apparatus for supplying oil to lamps.....	31,649
Fisher, J. C. Grain scouring machine.....	31,583
Foster, R. F., et al. Playing card.....	31,487
Fox, C. Cut-off and reversing gear for engines.....	31,675
Fraser, R. Feed heating and circulating apparatus.....	31,680
Frees, C. A. Artificial leg.....	31,683
French, J. F. Can opener.....	31,676
Gardner, A. O., et al. Railway brake shoe.....	31,612
Gibeault, U. Hub for wheels.....	31,625
Gibson, C. D. P. Storage battery plate.....	31,631
Gibson, D. H. Washing machine.....	31,492
Gilchrist, P. C. Manufacture of copper.....	31,503
Gish, J. L. Rheostat.....	31,577
Godin, J. Boot and shoe.....	31,660
Goodman, B. Suspender.....	31,504
Goserud, T. Drill.....	31,542
Graf, M. T. Gear wheel.....	31,597
Guest, G. Hydraulic engine.....	31,604
Hall, C. M. Manufacture of aluminium.....	31,515
Hall, C. M. Manufacture of aluminium alloys.....	31,516
Hall, C. M. Process of electrolyzing crude salts of aluminium.....	31,514
Hall, C. M. Process of electrolyzing fused salts of aluminium.....	31,517
Hall, C. M. Process of reducing aluminium by electrolysis.....	31,512
Hall, C. M. Process of reducing aluminium from its fluoride salts by electrolysis.....	31,513
Hand Sutch Broom Sewing Machine Co. Machine for assorting broom corn.....	31,482
Harman, W. Bridge.....	31,585
Harvey, J. A. Grooving or routing machine.....	31,471
Hasenlever, F. A. Motor engine.....	31,656
Hassman, W. Tire heating apparatus.....	31,510
Haughawout, J. W. Snow plough.....	31,670
Heailey, E., et al. Coin receptacle and register.....	31,677
Heffernan, E. F. Watch case.....	31,587
Hermite, E., et al. Apparatus for electrolyzing bleaching solutions.....	31,656
Hickey, L. J. Valve for steam engines.....	31,659
Hill, D., et al. Elevator.....	31,639
Hine, H. A., et al. Car axle lubricator.....	31,532
Hipkins, H. Sleeper.....	31,581
Hobson, A. E., et al. Hydraulic shaping press.....	31,652
Holt, J. R. Sled brake.....	31,493
Horton, W. G., et al. Coin receptacle and register.....	31,677
Hough, J. D. Holdback for vehicles.....	31,484
Howard, F. B. Apparatus for pressing pulp.....	31,629
Hughes, G. A. Drag sawing machine.....	31,681
Hummel, D. Fluid separating machine.....	31,534
Ilgen, P. C. Apparatus for calculating multiplication sums.....	31,572
International Electric Co. Transfer system of electrical distribution.....	31,535
Jewell, M. R. Suspension file box.....	31,608
Johnson, L. H. Motor.....	31,686
Johnson, W. D. Tripod head for surveying instruments.....	31,635
Johnston, W. F. Bundle carrier for binders.....	31,687
Jones, T. Finish for plastered walls.....	31,494
Jull, O. Snow plough.....	31,679
Kelsey, H. O., et al. Washing machine.....	31,492
Kelsey, W. W. Steam and hot water boiler.....	31,626
Kester, J. F. Regulator for dynamo electric machines.....	31,573
Keyling, L. Process and apparatus for producing shots or spheres of fragments of iron, steel and metal.....	31,580
Kibler, J. B., et al. Device for killing flies.....	31,479
Kirby, J. M., et al. Semaphore.....	31,529
Klase, V. J., et al. Fire escape.....	31,550
Knight, G. H. Ring.....	31,558
Lane, W., et al. Baby walker.....	31,617
Lash, Z. A. Letter file.....	31,527
Laviolette, A. A. Sewing machine pedal.....	31,481
Lebian, O., et al. Composition for brick and artificial stone.....	31,539

Lee, J. T. Feed water heater and purifier.....	31,586	Read, R. H., et al. Electric signalling and alarm apparatus.....	31,531
Leith, A. J., et al. Playing card.....	31,487	Rigby, A. Potato digger.....	31,602
Leman, F. Watch mechanism, etc.....	31,646	Rigley, C. E., et al. Bureau.....	31,571
Lemieux, T. W. Hoisting machine.....	31,564	Rigley, C. E., et al. Furniture drawer.....	31,882
Lenderoth, W. Manufacture of flat blocks and slabs from clay mixture.....	31,667	Rime, H. Watch with transparent body.....	31,657
Lenderoth, W. Method of drying porous hollow ware.....	31,665	Risch, V. M. Reed organ.....	31,648
Lenderoth, W. Skew back.....	31,664	Robb, L. B. Dry closet.....	31,569
Leslie, J. Apparatus for grinding the cards of carding engines.....	31,630	Robilliard, D. S., et al. Gas burner and heater.....	31,525
Lind, J. Tubular lantern.....	31,488	Roe, C. C. Signal for steamboats.....	31,694
Lindgren, J. F., et al. Medicinal compound.....	31,683	Rogers, N., et al. Gas engine.....	31,689
Lindsay, R. Household utensil.....	31,563	Roovers, A. W. Coin operated induction coil.....	31,523
Lipe, E. C. Machine for assorting broom corn.....	31,482	Rose, F. H. Samples of paint.....	31,616
McBride, A. B. Cultivator plough, etc.....	31,620	Rowen, N., et al. Railway rail joint fastener.....	31,486
McCombs, G. F. Broom sewing machine.....	31,548	Rubin, M. Clasp.....	31,496
McDonald, N., et al. Window ventilation.....	31,536	Ryan, W. B. & P. Return vent protector for plumbers' traps.....	31,480
McDonough, J. J. Non-eccentric valve gear.....	31,643	Saunders, T., et al. Car axle lubricator.....	31,632
McLachlan, J. C. Harvester.....	31,642	Savage, R., et al. Railway rail joint fastener.....	31,486
McLeod, M. Medicinal compound.....	31,495	Schimansky, O. Machine for cutting hoops.....	31,543
McMaster, J. Stove.....	31,641	Schimansky, O. Machine for pointing hoops.....	31,544
McPherson, J. Device for moistening tobacco.....	31,491	Schreiner, H., et al. Safety oil burner.....	31,609
Macdonald, E. A. Coach.....	31,614	Schroeder, E. Machine for pulling hairs from fur animals.....	31,692
Mandt, T. G. Running gear for vehicles.....	31,524	Schutt, M. E. Chair.....	31,674
Massey Manufacturing Co. Bundle carrier for harvesters.....	31,687	Scott, J. W. Machine for multiplying power.....	31,610
Massey Manufacturing Co. Harvester.....	31,642	Scoville, E. U. Faucet.....	31,579
Mason, T. S. Reed organ.....	31,648	Sessions, H. H. Equalizer for car vestibules.....	31,644
Mayhew, T. Receptacle for poisons.....	31,637	Sharpneck, W. S. Anti-friction journal box.....	31,688
Mercer, A. J. Gate.....	31,489	Shaw, O. M., et al. Wrench.....	31,613
Mercer, F. C. Envelope and tag fastener.....	31,560	Small, D. M. Device for applying heat to the body.....	31,507
Migley, T. Method of manufacturing belting.....	31,576	Smith, E. & F. Means for producing sparkling effect for advertising, etc.....	31,600
Montague, G., et al. Saw.....	31,585	Smith, J. R., et al. Metallic ladder.....	31,477
Montgomery, J. Freight car door.....	31,595	Société Armand Schowb & frère. Watch with transparent body.....	31,657
Moore, F. W. Compound for coating coffee.....	31,483	Stafford, W. Felt and felt cloth.....	31,533
Moore, H., et al. Device for killing flies.....	31,479	Steane, J. J. & Co. Hydraulic shaping press.....	31,652
Morris, C. N. Base ball bat.....	31,541	Stoltze, H. Apparatus for raising quick sand.....	31,690
Morris, H. B. Machine for inserting diagonal strips into woven fabrics.....	31,520	Stone, R. H., et al. Means for locking nuts or bolts.....	31,500
Morris, W. B. Wheel tire.....	31,591	Stratton, T. A. Tree and plant setting machine.....	31,470
Mortimer, C. G. Machine for ornamenting paper.....	31,551	Sturdy, T. Machine for stretching carpets.....	31,594
Moseley, C. & J. Card for carding cotton, wool, etc.....	31,610	Thompson, G. W. Machine for ornamenting paper.....	31,551
Moszczenky, A. Refractory crucible, pot, brick and lump for furnaces.....	31,645	Thomson, E. Armature for dynamos.....	31,485
Moyer, J. H. Scarf protector.....	31,622	Thomson, E. Transfer system of electrical distribution.....	31,585
New Haven Watch Co. Watch.....	31,658	Thomson-Houston International Electric Co. Armature for dynamos.....	31,485
Newton, H. R. Method of dealing with effluent of drains and sewers for its purification.....	31,636	Timmis, I. A. Apparatus for electrically lighting railway trains.....	31,547
Nippert, F. Rolls for converting old rails into angle iron.....	31,654	Tomkins, S., et al. Charcoal.....	31,651
Norcross, E. R., et al. Musical instrument.....	31,476	Townsend, J. H., et al. Window ventilation.....	31,536
Norcross, O. W. Fastening for roof slates.....	31,555	Troost, O., et al. Saw.....	31,530
Norfolk, J. R. Fluid meter.....	31,598	Valentine and Company. Samples of paint.....	31,616
O'Connor, T., et al. Fire escape.....	31,550	Vaughan, A. Roll for converting old rails into angle iron.....	31,654
Office Specialty Manufacturing Co. File box.....	31,608	Waddington, H. H. Vulcanization of water-proof fabrics, etc.....	31,623
O'Kelly, J. M. Vending apparatus.....	31,607	Waerber, A. Sprinkler.....	31,587
Oliphaunt, W. Apparatus for liquid purification.....	31,619	Walker, L. Plow colter.....	31,678
Oneida Community. Chain fastener.....	31,611	Ward, A. F. Machine for pointing and lapping hoops.....	31,574
Overbey, H. L. T. Belt punch.....	31,609	Ward, S. Churn.....	31,601
Parkhurst, A. G. Curb and gutter.....	31,566	Warren, H. H. Scythe.....	31,647
Paterson, E. J., et al. Apparatus for electrolyzing bleaching solutions.....	31,656	Webster, A. B. Draft for vehicles.....	31,473
Patmor, J. Finger shield and fountain attachment.....	31,475	Weed, W. A. Tablet for indelible ink marking.....	31,691
Patten, J. Nail driver.....	31,627	Welch, M. I. Saw sharpener and gummer.....	31,561
Paxton, R., et al. Semaphore.....	31,529	Welch, M. I., et al. Non-eccentric valve gear.....	31,643
Pearce, W., et al. Motor.....	31,686	Whalen, R. F., et al. Railway brake shoe.....	31,612
Pedersen, A. B., et al. Device for sharpening razors.....	31,478	Wharry, J. A. Gas engine.....	31,639
Pendleton, G., et al. Wrench.....	31,613	Wheeler, F. T. Anti-friction journal box.....	31,688
Peterson, H. Attachment for lawn mowers.....	31,672	Whitney, H. M. Feed gate for roller mills.....	31,506
Pettengill, F. E., et al. Car truck.....	31,663	Williams, H. F. Vaporizing apparatus.....	31,592
Pettengill, B. C. Hatchet for shingling.....	31,575	Williams, P. G., et al. Coin operated induction coil.....	31,523
Pifferling, E. Cabinet show case.....	31,558	Williamson, C. A. Corset.....	31,498
Puhlé, J. G., et al. Elevator.....	31,634	Wilson, G. T. Vehicle holdback.....	31,484
Pratt, A. N. Grain scouring machine.....	31,583	Wiawell, J. C. Bath or solution for separating metals from their ores.....	31,522
Presley, L. C. Air supply for propelling cars.....	31,640	Wood, A., et al. Lamp burner.....	31,553
Priestman, W. D. & S. Motor engine operated by hydro-carbon vapour.....	31,599	Woodsford, B. Pocket fastener.....	31,565
Portmann, H. G. & W. W. Spring rocker gear and centre bearing spring for rockers, etc.....	31,653	Wollheim, H. Treatment of sewage, etc.....	31,508
Potter, A. H. Watch.....	31,658	Worthen, W. C., et al. Wrench.....	31,613
Potter, C. J. Mill stone.....	31,559	Wright, G. W., et al. Safety oil burner.....	31,609
Ptolemy, J. Car coupling link.....	31,582	Wright, M. S. Reed organ.....	31,648
Pullman's Palace Car Co. Equalizer for car vestibules.....	31,644	Wright, S. Manufacture of casks, barrels, box barrels or packages.....	31,668
Purbrick, F., et al. Means for locking nuts or bolts.....	31,500	Wright, W. H. Vehicle axle.....	31,568
Quack, E. Motor engine.....	31,655		
Randall, I. H. Advertising rack.....	31,546		
Rastrick, R. J. H. Apparatus for issuing, recording and numbering tickets.....	31,588		