

**CIHM
Microfiche
Series
(Monographs)**

**ICMH
Collection de
microfiches
(monographies)**

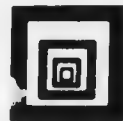

Canadian Institute for Historical Microreproductions / Institut canadien de microreproductions historiques

© 1999

The copy filmed here has been reproduced thanks to the generosity of:

Engineering Sciences Library
Queen's University

This title was microfilmed with the generous permission of the rights holder:

Forbes Tad Rickard

The images appearing here are the best quality possible considering the condition and legibility of the original copy and in keeping with the filming contract specifications.

Original copies in printed paper covers are filmed beginning with the front cover and ending on the last page with a printed or illustrated impression, or the back cover when appropriate. All other original copies are filmed beginning on the first page with a printed or illustrated impression, and ending on the last page with a printed or illustrated impression.

The last recorded frame on each microfiche shall contain the symbol → (meaning "CONTINUED"), or the symbol ▼ (meaning "END"), whichever applies.

Maps, plates, charts, etc., may be filmed at different reduction ratios. Those too large to be entirely included in one exposure are filmed beginning in the upper left hand corner, left to right and top to bottom, as many frames as required. The following diagrams illustrate the method:

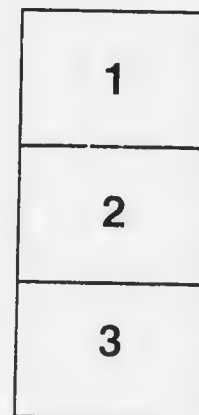
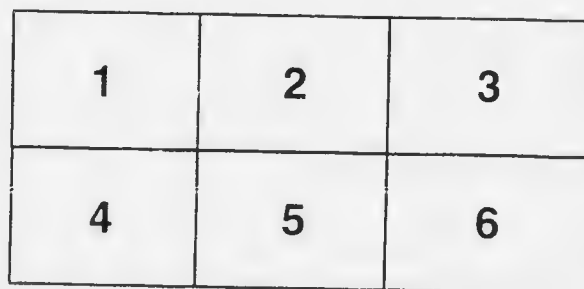
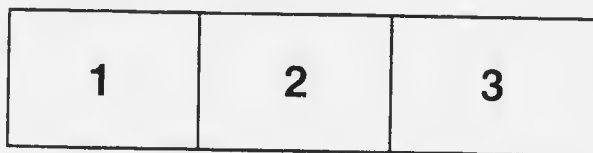

L'exemplaire filmé fut reproduit grâce à la générosité de:

Engineering Sciences Library
Queen's University

Ce titre a été microfilmé avec l'aimable autorisation du détenteur des droits:

Forbes Tad Rickard

Les images suivantes ont été reproduites avec le plus grand soin, compte tenu de la condition et de la netteté de l'exemplaire filmé, et en conformité avec les conditions du contrat de filmage.

Les exemplaires originaux dont la couverture en papier est imprimée sont filmés en commençant par le premier plat et en terminant soit par la dernière page qui comporte une empreinte d'impression ou d'illustration, soit par le second plat, selon le cas. Tous les autres exemplaires originaux sont filmés en commençant par la première page qui comporte une empreinte d'impression ou d'illustration et en terminant par la dernière page qui comporte une telle empreinte.

Un des symboles suivants apparaîtra sur la dernière image de chaque microfiche, selon le cas: le symbole → signifie "A SUIVRE", le symbole ▼ signifie "FIN".

Les cartes, planches, tableaux, etc., peuvent être filmés à des taux de réduction différents. Lorsque le document est trop grand pour être reproduit en un seul cliché, il est filmé à partir de l'angle supérieur gauche, de gauche à droite, et de haut en bas, en prenant le nombre d'images nécessaire. Les diagrammes suivants illustrent la méthode.

MICROCOPY RESOLUTION TEST CHART

(ANSI and ISO TEST CHART No. 2)



APPLIED IMAGE Inc

1653 East Main Street
Rochester, New York 14609 U.S.A.
716-482-3333 Phone
716-488-5949 Fax



THE INSPIRATION MILL AND INTERNATIONAL SMELTER, AT MIAMI, ARIZONA

THIS BOOK
is
Dedicated
to
FRANCIS EDWARD ELMORE
and
ALEXANDER STANLEY ELMORE
in Recognition of
Their
Courageous Persistence and Engineering Skill
in the
Development of the Flotation Process



THE FLOTATION PROCESS

Compiled and Edited

by

T. A. RICKARD

A. R. S. M., M. I. M. M., M. A. I. M. E.

FIRST EDITION

SECOND PRINTING

Published by the
MINING and Scientific PRESS
San Francisco

TN 523. RE

COPYRIGHT, 1916,
BY
DEWEY PUBLISHING CO.

PREFACE

This book has been prepared to meet the need of the hour. Flotation is engaging the attention of a rapidly increasing number of metallurgists, mill-men, and mine-owners. Information on the subject is lacking. The only book heretofore issued was written four years ago, and is now out of date. In 1912 the flotation process had hardly won a foothold in the United States; today fully 50,000 tons of ore is being treated daily by the frothing or bubble-levitation method. In July 1915 the *Mining and Scientific Press* began to publish a series of articles describing current progress in this new branch of metallurgy. These were followed by a number of interesting contributions on the theory of the subject. All of them are reproduced in this volume. They claim no finality. The physics of flotation is still a riddle unsolved; but the beginnings of investigation have been made. In the pages that follow will be found the rudiments of a connected theory explaining the phenomena underlying the life and activity of the metallurgic bubble.

In preparing this volume, I am under pleasant obligation to the various contributors; it will not be deemed invidious if I express special indebtedness to Messrs. O. C. Ralston, C. T. Durell, Dudley H. Norris, and Will H. Coghill. The reader will be particularly grateful to Mr. Ralston, of the U. S. Bureau of Mines, for his invaluable article on the testing of ores by flotation and for his résumé of preferential methods. Messrs. Durell, Norris, and Coghill have helped to clarify many obscure points. To the anonymous metallurgist who wrote on the experiments at the Mexican mill and on the effects of soluble salts, I tender special thanks; also to Messrs. Butters and Clennell for their detailed account of experimental work on flotation concentrate. To all of these and to the other contributors, I extend my hand.

T. A. RICKARD,

Editor of the *Mining and Scientific Press*.

San Francisco, March 1, 1916.



TABLE OF CONTENTS

	Page.
A Glossary of Flotation	7
The Flotation Process	<i>T. A. Rickard</i> 9
Flotation Tests at Mount Morgan.....	<i>William Motherwell</i> 53
Oils Used in the Flotation Process	<i>Occasional Contributor</i> 60
Flotation of Copper Ores.....	<i>J. M. Callow</i> 65
Preferential Flotation	<i>O. C. Ralston</i> 71
Flotation at the Inspiration Mine, Arizona.....	<i>William Motherwell</i> 83
Flotation in a Mexican Mill.....	<i>Special Correspondent</i> 91
Froth and Flotation....	<i>W. F. Copeland, Drury Butler, and Jas. H. Wise</i> 102
Flotation at Washoe Reduction Works, Anaconda.....	<i>E. P. Matheson</i> 106
Flotation at the Central Mine, Broken Hill.....	<i>James Hebbard</i> 110
What is Flotation?—I.....	<i>T. A. Rickard</i> 126
Why is Flotation?—I.....	<i>Charles T. Durell</i> 135
What is Flotation?—II.....	<i>T. A. Rickard</i> 144
Surface Tension and Salts in Solution.....	<i>Will H. Coghill</i> 154
Air-Froth Flotation—I.....	<i>W. A. Scott</i> 159
Why Do Minerals Float?.....	<i>Oliver C. Ralston</i> 175
Why is Flotation?—II.....	<i>James A. Block</i> 187
Air-Froth Flotation—II.....	<i>H. D. Williams and W. H. Kenyon</i> 189
Cyanide Treatment of Flotation Concentrate	<i>Charles Butters and J. E. Clennell</i> 203
Flotation on Gold Ores	<i>A. E. Drucker</i> 224
The Electrical Theory of Flotation—I.....	<i>Thomas M. Bains, Jr.</i> 225
Notes on Flotation	<i>J. M. Callow</i> 231
Disposal of Flotation Residue.....	<i>W. Shellshear</i> 248
The Electrical Theory of Flotation—II.....	<i>Thomas M. Bains, Jr.</i> 258
Effects of Soluble Components of Ore on Flotation.....	<i>Occasional Correspondent</i> 263
Flotation—A Paradox	<i>Dudley H. Norris</i> 267
Flotation of Gold Ores	<i>Charles Butters</i> 276
Testing Ores for the Flotation Process—I.....	<i>O. C. Ralston and Glenn L. Allen</i> 277
Testing Ores for the Flotation Process—II.....	<i>O. C. Ralston and Glenn L. Allen</i> 293
Molecular Forces in Flotation.....	<i>Dudley H. Norris</i> 308
Flotation-Tests in Separating Funnel	<i>Special Correspondent</i> 318
Flotation Principles	<i>C. Terry Durell</i> 319
The Electro-Statics of Flotation.....	<i>F. A. Fahrenwald</i> 335
On the Science of a Froth.....	<i>Will H. Coghill</i> 344
Smelting Flotation Concentrate	351
Flotation on Dump Ore	<i>V. F. Stanley Low</i> 354
Simple Problems in Flotation.....	<i>T. A. Rickard</i> 356
Index	361



A GLOSSARY OF FLOTATION

ABSORB. To drink in, suck up, like a sponge.

ABSORB. To condense and hold a gas on the surface of a solid, particularly metals. From L. *ad*, to, and *sorbeo*, suck in.

AGITATION is the act or state of being shaken, stirred, or moved with violence. From L. *agitatus*, *agito*, the frequent of *ago*, to drive.

BAFFLE. That which defeats or frustrates, hence the projections or wings that divert or interrupt the flow of pulp in a vessel.

BUBBLE. A globule of air or other gas rising in a liquid; also a vesicle of water or other liquid inflated with air or other gas.

BUOY. To keep from sinking, to keep afloat in a liquid.

COAL-TAR is a thick, black, viscid, and opaque liquid condensed when gas is distilled from coal. Such products consist of soluble and insoluble substances.

COAGULATION. The state of a liquid resulting from clotting or curdling, the act of changing to a curd-like condition.

CONCENTRATE. To draw or gather together to a common centre. To reduce to a purer state by the removal of non-essential matter. From L. *con* and *cum*, with, and *centrum*, a centre.

CONTAMINATE. To make impure by contact or admixture.

ELECTRO-STATICS. That branch of electrical science devoted to the phenomena of electricity at rest or of frictional electricity.

EMULSION. Milkification. A liquid mixture in which a fatty or resinous substance is suspended in minute globules. From L. *emulgeo*, to drain out, in turn from *e*, out, and *mulgeo*, milk.

EUCALYPTUS OIL. The oil distilled from one of the Australian gum-trees, the *eucalyptus amygdalina*.

FAT is a white or yellowish substance forming the chief part of adipose tissue. It may be solid or liquid; it is insoluble in water; when treated with an alkali, the fatty acid unites with the alkaline base to make soap.

FILM. A coating or layer, a thin membrane.

FLOCCULENT means resembling wool, therefore woolly. Coalescing and adhering in flocks. A cloud-like mass of precipitate in a solution. From L. *floccus*, a lock of wool.

FLOTATION is the act or state of floating, from the French *flottaison*, water-line, and *flotter*, to float, to waft.

FLOTATION-FEED. The crushed ore, pulp, or other mill-product that goes for treatment to the flotation plant.

FROTH. A collection of bubbles resulting from fermentation, effervescence, or agitation.

GANGUE. The non-metalliferous or non-valuable metalliferous minerals in the ore; veinstone.

GRANULATION is the state or process of being formed into grains or small particles. From L. *granum*, a grain.

GREASE. Animal fat when soft. Also anything oily or unctuous. From the French *graisse*.

LEVITATION. The act of rendering light or buoyant. L. *levitas*, lightness, from *levis*, light.

METALLIC. Of or belonging to metals, containing metals, more particu-

larly the valuable metals that are the object of mining. From L. *metallum*, ore.

MINERAL. Inorganic constituent of the earth's crust. As used in flotation the terms 'mineral' or 'metallie' particles hark back to the French (*minerais*, ore) and Spanish (*metal*, ore) meanings. Both terms refer to those valuable constituents in the ore that it is the object of the process to separate from the non-valuable constituents, or gangue. Sometimes 'metallie' has reference to metallic lustre, one of the chief characteristics of metals and more particularly of those metallic sulphides that are especially amenable to flotation.

MODIFY. To change in character or properties.

MOLECULE. The smallest part of a substance that can exist separately and still retain its composition and characteristic properties; the smallest combination of atoms that will form a given chemical compound. From F. *molécule*, diminutive from L. *moles*, mass.

NASCENT. Coming into being, beginning to develop. From L., *nascens*, being born.

OCCUDE. To shut or close pores or other openings. From L., *ob*, before, *claudo*, close.

OLIC ACID is fatty acid contained in olive oil combined with cresoline. Although called 'acid' it is an oily substance and functions as oil in flotation operations; it is contained in most mixed oils and fats, from which it is obtained by saponification with an alkali. From L. *oleum*, oil.

OIL includes (1) fatty oils and acids, (2) essential oils, mostly of vegetal origin, such as eucalyptus and turpentine, (3) mineral oils, such as petroleum products, including lubricating oils.

OILY and **GREASY** are substantially equivalent terms. All oils are greasy. Greasiness suggests more viscosity than oiliness.

OSMOSE. The tendency of two liquids or gases to mix by passing through a membrane or porous wall separating them. From G. *osmos*, pushing.

PINE-OIL is a derivative of wood-tar, as phenol and cresol are derivatives of coal-tar.

PULP is powdered ore mixed with water.

SAPONIFICATION. Conversion into soap; the process in which fatty substances form soap, by combination with an alkali. From L. *sapo* (*n-*), soap.

SCUM. Impure or extraneous matter that rises or collects at the surface of liquids, as vegetation on stagnant water, or dross on a bath of molten metal.

SKIN. An outside layer, coat, or covering. From A. S. *scinn*, lee.

SPITZKASTEN. A pointed box or inverted pyramidal vessel, with an outlet at its point for the separation of the components of an ore by gravity. German, *spitze*, point, *kasten*, chest.

SURFACE TENSION is the contractile force at the surface of a liquid where resistance is offered to rupture.

VESICLE. A small bladder-like cavity or hollow sphere of liquid. From *vesicula*, diminutive from *vesica*, bladder.

VISCOSITY is the property of liquids that causes them to resist instantaneous change of their shape or of the arrangements of their parts; internal friction; gumminess. From L. *viscum*, birdlime.

THE FLOTATION PROCESS

By T. A. RICKARD

(From the *Mining and Scientific Press* of March 4, 18, and April 1, 1916)

*INTRODUCTORY. It is not yet four years since the starting of the first American mill using the frothing method of flotation, yet 55,000 tons of ore is being treated daily by this process in the United States today. This means 20,000,000 tons per annua. The larger part of these metallurgical operations began within the last two years. It is evident therefore that the process is gaining ground so rapidly as to command the intelligent attention of all those engaged in mining. In the present writing upon the subject I have tried to supply such information as is required by those newly interested in flotation, either as students or as operators. Of course, what I have written makes no claim to finality, for I am conscious of possessing only an elementary understanding of the extremely abstruse set of phenomena underlying the process. My contribution is that of a detached observer, eager to be helpful to the workers in this new branch of metallurgy.

THE PHYSICS. In a recent reminiscence my friend Ben Stanley Revett has recorded¹ how he bet "a bottle of bubbles" with that peripatetic philosopher Thomas F. Criley, the partner of Carrie Jane Everson in an oil process of concentration whereby the valuable sulphides were made to float above the worthless gangue in a pulp of crushed ore. Mr. Revett says that he bet his bubbles against Criley's, but we suspect that in saying so he was interpreting the prior art in terms of latter-day metallurgy, for it is doubtful whether any of the persons concerned in that early experiment at Baker City, Oregon, had a clear understanding of the function of the bubbles in assisting the oil to give buoyancy to the sulphides. However, in staking his bubbles of carbon dioxide dissolved under pressure in the vintage of Champagne against the performance predicated by Criley, Mr. Revett must be credited with successful anticipation, for 27 years after the

*This article was presented as a paper at the March (1916) meeting of the Canadian Mining Institute.

¹*Mining and Scientific Press*, October 16, 1915.

incident we know that the key to the flotation process is to be found not in the oil, the acid, or the apparatus, but in the bubbles.

The man who understands the physics of a soap bubble has mastered the chief mystery of flotation. The small boy, who, as pictured by Millais, watches the birth, ascent, and bursting of the iridescent sphere of his own making, is the type of our modern metallurgist who makes the multitudinous bubbles constituting a froth and then wonders to what laws of physics this filmy product owes its existence.

To put it briefly, the boy, having dissolved soap in water, holds a little of it in the bowl of his clay pipe while he blows through the stem. The soapy water forms a film that is distended by the boy's warm breath into a lovely sphere, which is lighter than the surrounding air and therefore rises, while the sunshine undergoes refraction into the colors of the spectrum. When the boy blows through his pipe into pure water, he makes bubbles likewise, but they break instantly. It is the soap that lengthens their life. In the language of physics we say that high 'surface tension' causes the pure-water bubbles to burst immediately, while the addition of soap introduces a contaminant that lowers the tension so as to enable the bubbles to last longer.

The basic factor in the making of bubbles is surface tension. This is the force that causes the surface of a liquid to resist rupture. The particles at the surface have a greater coherence than the similar particles within the body of the liquid. In other words, each molecule within the interior of the liquid may be pictured as surrounded by molecules like itself in being attracted toward each other equally in all directions: while the molecules at the free surface of the liquid are attracted only by those internal to themselves, the result being to constrict the free surface to the least area. In consequence, the surface acts as if it were elastic. Hence the attachment of water to the sides of a tube and the drawing of that water upward—which is called 'capillarity' because it is most marked in a tube as small as *capillus*, a hair.

Numerous manifestations of surface tension on water could be cited. Fill a tumbler a little more than full and the water will have a convex surface, indicating that there is some force at work to prevent the water from spilling. Note the cohesion between two plates that have been wetted. Dip a camel's-hair brush into water and the hairs cling together; immerse the wet brush in the water and the hairs separate. Watch the formation of a drop of water and note that it behaves as if enveloped by a stretched membrane. Water-spiders can

be seen running over the surface of a pond in summer, as small boys run over a pond covered with ice in winter. The ice bends under their weight without breaking; so also the spider² makes a visible dimple without wetting his feet. The surface is not ruptured.

The force of surface tension has been measured by ascertaining the weight that can be suspended from a film of water in air.³ It has been stated as $3\frac{1}{2}$ grains per inch⁴ or 81 dynes per centimetre.⁵ The most recent determination is that of Theodore W. Richards and Leslie B. Coombs,⁶ who found it to be 72.62 dynes per centimetre at 20°C. Many disturbing factors enter into the measurement of this force, so that divers figures, ranging from 70.6 to 81, have been announced at different times.

Surface tension differs as between various liquids and fluids in contact; for example, the tension separating mercury from water amounts to 418 dynes per centimetre, while that separating olive oil from air is only 36.9 dynes. A drop of pure water will spread over the surface of pure mercury as oil will spread over water. The surface tension of an oil-water surface is only 14, as compared with the 73 of an air-water surface at a temperature of 18°C.⁷ While the film of oil on water may be only one molecule thick, or one twenty-five millionth of an inch, it will suffice to reduce the effective pull of the water surface from 73 to 43. This latter figure represents the effective surface tension of water modified by oil as used in flotation. It is the main factor in the formation and persistence of a bubble. Heat lowers the surface tension of water. Place powdered sulphur on the surface of the water on a horizontal plate of clean metal; apply heat locally; the sulphur is pulled away by the cold liquid as against the feebler tension of the warmer liquid.

This elastic force at the surface of a liquid tends to draw it into the most compact form. That is why a drop assumes the form of a sphere, in which shape it presents the smallest surface in relation to its volume. Surface tension is a contractile force. This is shown in a simple way by blowing a soap bubble on the large end of a pipe and then holding the other end of the pipe to a candle, when the air escaping from the shrinking bag of the bubble

²In New England the boys call them 'skaters.'

³'A Text-Book of the Principles of Physics.' By Alfred Daniell, 1911.

⁴C. V. Boys in 'Soap Bubbles.'

⁵Clerk Maxwell in the *Encyclopædia Britannica*, under 'Capillarity.'

⁶'The Surface Tension of Water, Alcohols, etc.' *Jour. Amer. Chem. Soc.*, July 1915.

⁷'A Text-Book of Physics.' By J. H. Poynting and J. J. Thomson, 1913.

extinguishes the flame, as in Fig. 1.* When water is spilled on a stove, it assumes a globular form and dances on the hot iron until it flashes into steam. When water is sprinkled on a dusty floor, the dust forms a layer upon the drop of water, which draws itself together into rolling spherules. The smallest drops are the most nearly round; in the larger ones the weight causes a flattening, because gravity overcomes the elasticity of the surface film. That is



FIG. 1. THE CONTRACTING BUBBLE BLOWS THE FLAME.

shown even more clearly in the case of drops of mercury, and by the beads of gold on an assayer's cupel.

This contractile force at the surface, whereby a portion of liquid gathers itself together into spherical form, explains why the pure-water bubble bursts so readily. The high tension shatters it. It does not burst explosively, by expansion of the gas within the envelope, but by lateral displacement of the substance of the elastic film. It collapses because the surface tension draws it together. To prevent such immediate collapse it is necessary to lessen the tension, that is, diminish the contractile force in the elastic membrane constituting the film of the bubble. This can be done by introducing an impurity or contaminant, which lowers the surface tension, that is, diminishes the contractibility of the bubble-film. Water has the highest surface tension of any common liquid except mercury, so that the addition of another liquid usually lowers its surface tension.

Oil in emulsion and organic substances in solution can be used for this purpose. Soap will have the same effect, and that is why a soap

*C. V. Boys in 'Soap Bubbles,' page 49.

bubble lasts longer than a pure-water bubble, the film of the former consisting of water having some soap in solution. When water has been modified by such a contaminant, the components of the film can so dispose themselves that the superficial forces will be the same everywhere, that is, tend to remain in equilibrium, including the force of gravity, which otherwise would pull the film apart.

When two bubbles come in contact they tend to coalesce because the two of them have an aggregate area greater than that required to include the same amount of air within a single bubble. In pure water the bubbles coalesce with a violence that is mutually destructive. Even when a survivor is left, the violence of coalescence of such bubbles in a pulp unhorses any mineral particles that may be riding the bubbles. When, however, the water is modified by oil, the contractile force of surface tension is diminished, the bubbles are less fragile, and they survive long enough to perform their metallurgical duty of buoying the metallic particles to the surface of the liquid pulp. In practice the 'modification' of the water is effected by emulsification or minute subdivision (as in a mayonnaise) of an insoluble oil, such as cotton-seed and oleic; or it may be done by means of a soluble oil or derivative, such as cresol and amyl acetate.

The presence of a contaminant in water may also affect its viscosity or internal friction, whereby it offers resistance to a change of shape. This strengthens the film of a bubble generated in such water. Moreover, it has been asserted⁸ that a concentration of the contaminant occurs in the surface of a liquid, causing the viscosity to be highly magnified as compared with the body of the liquid. It is also known that the films made of any definite liquid are of the same strength, irrespective of their thinness; so that the attenuation of the skin of a bubble does not decrease its strength. This again follows from one of the most remarkable properties of a bubble: the ability, within small limits, of adjusting its tension to the load.⁹ Briefly, the tension at the surface of a contaminated liquid is able to adjust itself within fairly wide limits. Thus a film of such a liquid can remain in equilibrium when a film of pure liquid¹⁰ would have to break.

⁸Samuel S. Sadtler in *Minerals Separation v. Miami case*, 1915.

⁹'Thermodynamics,' by Willard Gibbs. Page 313. "In a thick film, the increase of tension with the extension, which is necessary for its stability with respect to extension, is connected with an excess of soap (or some one of its components) at the surface as compared with the interior of the film."

¹⁰In a chemically pure liquid it is impossible to form froth or multiple bubbling. Some differentiation of the components of a liquid is required to make a film.

In his book T. J. Hoover¹¹ states how the presence of a mere trace of saponine will kill the froth in the flotation cell. He does not explain why. It happens that saponine, which can be dissolved out of horse-chestnuts, is an aid to the blowing of big bubbles. But they are weak and tender. Why? Because saponine *increases* the tension.¹² When a saponine bubble is brought into contact with a soap bubble, the former contracts and blows air into the soap bubble. Rayleigh proved that the tension of the soap-film is only two-thirds of that blown from a saponine solution of equal strength. One part of saponine in 100,000 parts of water will suffice to make a liberal froth. But the bubbles are flimsy. They are so fragile as to render them of no use as carriers of mineral. Hence they spoil the normal working of a flotation-cell, in which it is necessary to employ a contaminant that lowers the surface tension so as to yield bubbles that are both persistent and sufficiently robust to buoy mineral particles.

In approaching the rationale of the process under discussion it may now be assumed that we are dealing with a pulp consisting of ore and water, modified by oil, the ore having been crushed sufficiently to separate the metallic sulphides from the associated gangue in a pulp consisting of minute particles of each. In ordinary water-concentration the lower specific gravity of the gangue permits the mill-man to wash it away from the heavier metallic sulphides, but in the flotation process this action is reversed, the metallic particles being lifted above, and away from, the gangue particles. Apparently, it is a metallurgic anomaly.¹³

To this crushed ore we have added oil. The oil serves as a contaminant that lowers the surface tension; also it augments the viscosity of the liquid. These two effects unite in facilitating the formation of strong and persistent bubbles. The necessary air is introduced by agitation or by direct injection. Sea-weed contaminates sea-water and makes foam in the breakers, as oil makes froth in fresh water that is agitated.

Air has a marked adhesiveness for metallic surfaces: this attachment is supposed to be enhanced by the presence of oil or grease on the metallic surface. In other words, the metallic surface, such as that of a sulphide mineral, when in the presence of both oil and water, will exhibit a preference for the oil. Hence the sulphide is not wetted.

¹¹'Concentrating Ores by Flotation.' Page 99, Second Edition.

¹²'Soap Bubbles.' By C. V. Boys. Page 115.

¹³Mr. Ingalls has called it 'concentration upside down;' Mr. Norris has called it a 'paradox.'

This characteristic is less marked on the part of the heavy silicates, such as rhodonite or garnet, and still less evident in the case of the lighter silicious minerals, such as quartz and orthoclase.¹⁴ The addition of acid lessens the oil attachment to the gangue particles without decreasing the selectiveness of the oil and the air for the sulphide particles. Thus we can understand why the bubbles attach themselves to the metallic particles and buoy them to the top, while ignoring the gangue particles, which sink to the bottom of the vessel in which the pulp is undergoing stirring or agitation. This preference of air for metals and metallic surfaces must be emphasized. It is the decisive factor in the process of flotation. Most minerals when pulverized, and then sprinkled on water, will float, particularly if they are in flakes or plates, as gold often is and as minerals with a highly developed cleavage usually are. Such flotation is due to air, which forms a discontinuous film under the mineral particles. Mickle proved this by taking a magnetic mineral, like pyrrhotite, and pulling it out of the water by a magnet, when it could be seen that the water was dragged up with the mineral. These minerals float for the same reason as an ungreased needle will float, namely, the resistance to rupture of the surface of the water and the aid of the air attached. It used to be supposed that the needle must be greased in order that it may float. That idea, like the general exaggeration of oil as a factor in flotation, has been disproved by experiment.*

If, to water in which mineral dust is floating, an addition of alcohol or caustic soda be made, or even the vapor of alcohol be allowed to play on the surface of the water, the mineral particles will sink.¹⁵ The contamination of the water has decreased its surface tension.

The bubbles collect the metallic particles, that is agreed; but whether the selection is dependent upon the previous oiling is a disputed point. Apparently the adhesiveness of air for metallic surfaces is greater than that of oil, and it would appear probable that in the flotation process the first phenomenon suffices without the aid of the second. It used to be an accepted canon of flotation that the oil coated the metallic particles, which therefore were not 'wetted' and did not sink, while the gangue particles were not oiled and therefore were wetted, especially in acidulated water, so that they sank. Testimony has been given by a keen observer that "the distribution of the

¹⁴Kenneth A. Mickle. Proceedings of the Royal Society of Victoria. Vol. XXIV, part 2, 1911.

*See pages 327 and 356 of this book.

¹⁵*Ibid.*

oil in the concentrate and the gangue is entirely fortuitous.¹⁶ It is even asserted now that instead of the oil residing with the metallic particles exclusively, and leaving the gangue untouched, it is distributed throughout the mixture. When the larger proportions of oil were employed, it is likely that such promiscuous oiling of all the particles of the pulp did take place, but now that the quantity has been reduced to a proportion so small that the presence of oil on the concentrate is not discernible by the senses, we may assume a preference for the metallic particles in accordance with laboratory observation. This appears to be confirmed by experiments showing that in the case of specific minerals, such as chalcocite, it is necessary to oil the mineral in order to lift it by an air bubble.¹⁷

When using the, at present, minimum quantity of oil—say, one-third of a pound per ton of ore—it would appear that the oil forms a coating of microscopic thinness upon the metallic particles. The minimum thickness is the thickness of a molecule.¹⁸

Metallie surfaces have a selective adhesion for air and for oil, as we have seen. Therefore the molecular forces of the oil and of the metallie surface may be supposed to unite in attracting the bubbles. What the nature of those forces may be is yet a matter of conjecture, although the idea that they are electro-static is suggested by the fact, among others, that the metallie sulphides most amenable to flotation, are good conductors of electricity.¹⁹

The foregoing statement of physical principles applies more particularly to the frothing method. The history of the 'prior art,' as it is called in patent litigation, shows that the first stage of the flotation process as now in vogue was performed by the use of a large proportion of thick oil. This is typified by the bulk-oil method of the Elmore brothers. It depends upon the lower specific gravity of oil as compared with water, so that when mixed in a pulp of crushed ore the oil rises to the top, dragging the metallie sulphides with it. This also was explained formerly as due mainly to the selective adhesive-

¹⁶Bertram Blount, testifying for Minerals Separation in the Elmore appeal before the Privy Council. I might add that 'fortuitous' is a word that describes other things in the history of flotation besides the oiling.

¹⁷Experiments of B. H. Dosenbach in the Minerals Separation v. Miami suit, at Wilmington, 1915.

¹⁸'Oil Films on Water and on Mercury.' By Henri Devaux. *Mining and Scientific Press*, July 31, 1915, page 156.

¹⁹'The Electrical Theory of Flotation.' By Thomas M. Bains, Jr. *Mining and Scientific Press*, November 27 and December 11, 1915. See also page 225 of this book.

ness of oil for metallic surfaces, which prevents them from being wetted, while the lack of a similar affinity on the part of the gangue particles enables them to be so wetted as to cause them to sink to the bottom. All of this is measurably true, but the underlying fact seems to be that an excess of viscous oil causes the oiled particles to adhere or stick together so that they are rafted to the top. It is probable that when thus collected in groups they are more readily floated on account of their ability to hold more oil, as compared with individual particles, because the oil fills the spaces between the members of a group.

The lighter oils have a specific gravity ranging from 0.8 to 0.9, as compared with the 1.0 of water, so that the margin for flotation is small. For instance, in the case of a mixture of an oil having a specific gravity of 0.9 and of zinc-blende, having a specific gravity of 4, it is necessary to use 6.7 parts by weight of oil to one part by weight of blende in order that the mixture may have a specific gravity equal to that of water. Thus an ore containing 20% blende, or 400 lb. per ton, would require the use of over 2680 lb. of oil in order to float all the blende in the ore.

In true bulk-oil flotation, which, as a matter of fact, was rarely performed, the phenomenon of surface tension does not play a prominent part. It is mainly a question of raising a mineral heavier than water by aid of a liquid lighter than, and not soluble in, water. The emulsification of the oil was carefully avoided by Elmore. In the later phases of flotation, in which the proportion of oil becomes steadily less, it is aimed to emulsify the oil and air. The oil produces a 'micro-emulsion of air,' as Leverrier expressed it. Thus the air is thoroughly distributed in the pulp and the oil is brought into intimate mixture with the water, which is thereby modified and prepared for the making of persistent bubbles.

THE PROCESSES. The application of the various physical principles outlined in the foregoing paragraphs has taken diverse forms, as expressed in scores of inventions, only a few of which have been developed into workable processes. The phenomenon of surface tension is used directly in the so-called skin-flotation methods of Hezekiah Bradford, Arthur P. S. Macquisten, and Henry E. Wood. In the first of these, invented in 1886, the pulp flows down an inclined plane onto the quiet surface of water in a vessel, so that the sulphide particles float forward under the impetus of their descent while the gangue particles sink. See Fig. 2. The explanation is that sulphides, by exposure to the atmosphere, attach films of air to themselves, so

adopted in the Adelaide mill, at Golconda, Nevada. The ore contained 2.2% copper as chalcopyrite, with pyrrhotite and pyrite, as well as some blende and galena. The gangue was quartzose, containing spinel and garnet. The tubes were of cast-iron, 6 ft. long, 1 ft. inside diameter, and each weighed 450 lb. See Fig. 3. Externally

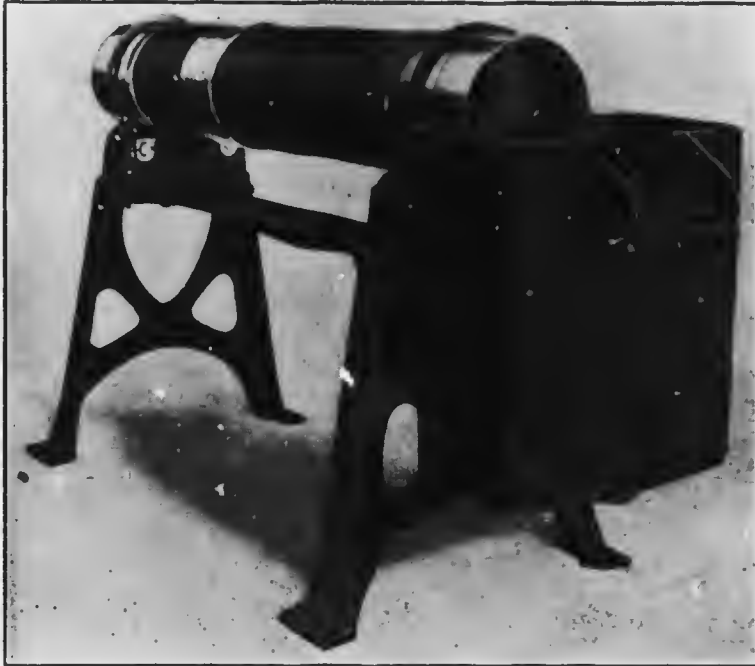

FIG. 3. THE MACQUISTEN TUBE.

these tubes were cast with two tires, which rested upon supporting rollers. The discharge-end was entirely open. The feed-end was closed except for a hole in the centre large enough to admit the pipe through which the pulp entered. Internally the tube was cast with a helical groove of $\frac{3}{4}$ -inch pitch, which was changed subsequently to $1\frac{1}{2}$ -inch pitch. The discharge-end was connected with a separating-box, the joint between this and the tube being water-tight, while the tube was free to revolve. At the side of the separating-box, directly opposite the discharge from the tube, an opening or lip was cut for the overflow of the surface layer of water, carrying the floating mineral. This opening regulated the depth of water in the tube. The bottom of the opening was three inches above the inside bottom of the

tube, so that there was three inches of water in the tube; the feed and the discharge were so regulated that the water passing over the lip was about $\frac{1}{32}$ inch deep. The tube was rotated at 30 r.p.m. in a direction corresponding with the helix of the interior. As Mr. Ingalls said:³³ "The pulp is thus serewed through the tube and in its advance is repeatedly given an opportunity to slide upon the surface of the water, where it may be retained by surface tension." The ore was crushed to pass 30 mesh. The capacity of each tube was 5 tons per 24 hours, and 25 tubes were in use. A concentration of 11:1 was effected on a 2.2% copper ore, the tailing assaying 0.2%; but this refers only to the deslimed ore, that is 70% of the supply, so that the actual extraction was only 63%. The inability to treat slime is a notable defect of this ingenious method of flotation.

Wood's method is equally interesting. The ore is crushed dry to 30 or 40 mesh and is then fed in a thin stream from a vibrating plate onto the surface of water in a tank to the surface of which a forward movement is given by small jets, also of water. By a combination of the capillary attraction and the pressure of a constant feed, the sulphides are caused to move forward as a definite elastic film on top of the water. This film of mineral passes over an endless canvas belt, which emerges from the tank at a particular angle, varied according to the kind of mineral to be saved. The belt with its film of sulphides passes over three rollers so that its motion is reversed when it strikes the water-level of a second tank, where it releases its valuable burden.³⁴ Very little gangue in suspension comes over, as the water drains back into the main tank. Any submerged particles that have been accidentally wetted or are so heavy that they have penetrated the surface-film, pass to standard concentration-tables, on which they are separated by gravity in the ordinary way. In the case of molybdenite and graphite, the film concentrate is still further cleaned by being passed over a nearly vertical screen. Gangue in suspension passes through, while the flat crystals of the valuable minerals slide over the screen, which largely dewater them. The flotation concentrate is collected and dried as usual. See Fig. 4.

Mr. Wood is using his own process to commercial advantage in the treatment of molybdenite ore, at Denver. The Macquisten tube is

³³The whole of the above description is taken from the admirable technical article by W. R. Ingalls in 'Concentration Upside Down.' *Eng. & Min. Jour.*, October 26, 1907.

³⁴From particulars given to me by Mr. Wood himself. See also *Trans. A. I. M. E.*, Vol. XLIV (1912), pp. 684-701.

still in use at Mullan, Idaho; but the Bradford patent is only of academic interest. These methods have been confused with the more recent flotation processes; they ought to be differentiated. I suggest therefore that they be classed under 'film-suspension,' for it may be

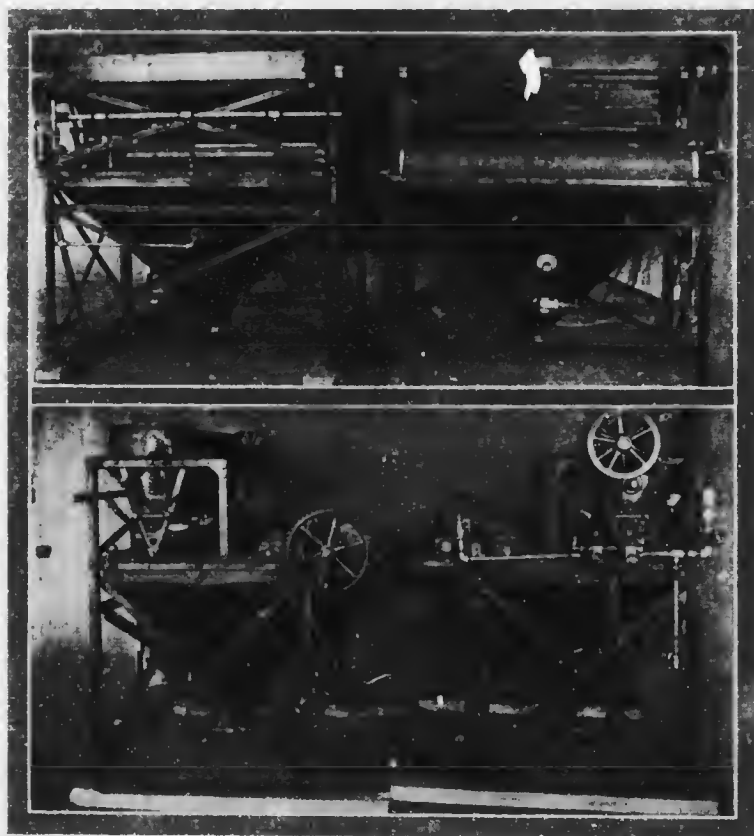

FIG. 4. THE WOOD MACHINE.

taken that in every case the sulphides are carried with air over the tensional film on the surface of the water.

Incidentally, it may be well to point out that although it is convenient to speak of the 'water-skin' and of 'skin-flotation,' the use of either 'skin' or 'film' is inaccurate. A skin is a thing of definite thickness, which therefore can be 'peeled' off, like the epidermis, for

example. The phenomenon of surface tension involves nothing of the kind. It refers to a condition of molecular forces at the surface of a liquid, the effect of which can be only one molecule thick. Thus,

No. 776,145.

PATENTED NOV. 29, 1904.

C. V. POTTER.

PROCESS OF SEPARATING METALS FROM SULFID ORES.

APPLICATION FILED JAN. 14, 1902.

NO MODEL

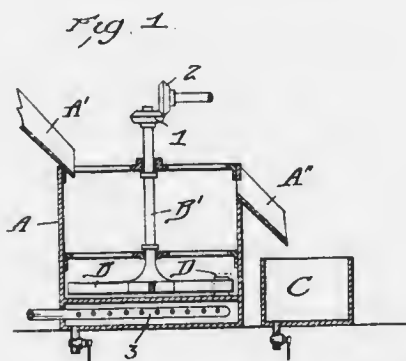
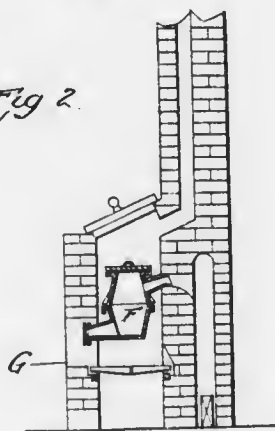
*Fig. 2.*

Attest:
 C. J. Middleton
 J. B. Middleton

Inventor
 Charles V. Potter
 Richard A. C. ...
 by ...
 Attys

FIG. 5. THE POTTER PATENT.

'water-skin' and 'skin-flotation' stand for water-surface and surface-suspension.

Neither Bradford nor Wood uses oil or acid, but in the later applications of the Macquisten tube both have been introduced. As the ore contains carbonates that would react with the sulphuric acid so as to liberate carbon-dioxide gas, it is obvious that another factor is introduced, namely, the bubble idea, which has proved so potent in the more recent phase of flotation. The further addition of oil marks a distinct departure from the first idea of the inventor, causing the process to resemble those of Potter, Delprat, and De Bavay.

The methods of these three Australians were alike designed to treat Broken Hill tailings, containing zinc-lead sulphides in a gangue composed partly of carbonates, notably calcite, siderite, and rhodochrosite. Charles V. Potter used water containing from 1 to 10% sulphuric acid, which was added to crushed ore placed in a vessel (see Fig. 5) provided with stirrers (*B'* the shaft and *B* the arms.) Heat was then applied by gas (3); whereupon the metallic particles rose to the surface of the liquid. It has been said that "it is clear that he (Potter) had in view a surface tension process."³⁵ If this is meant as a reference to the surface-suspension method, say, of Bradford, it is incorrect. Surely Potter used bubble-levitation as his principal effect. The gas generated by the action of the acidulated water on the carbonates joined with the air entrained by the ore is furnishing gas for making bubbles, this result being assisted further by the stirring of the pulp and the heating of it. See also Fig. 10.

G. D. Delprat had an apparatus suggesting the employment of surface suspension, but he also used chemicals to induce flotation. See Fig. 6. By the addition (through the pipe 5) of a hot solution of acid salt-cake to the crushed ore as it was fed (from the chute 1) upon a pan having a sloping bottom (4) heated by a Bunsen burner (14), the sulphides were made to rise to the surface of the vessel (at 3, passing forward along 13), while the gangue collected in a sump (10). In this case also the flotation was the result of forming bubbles of carbon-dioxide gas and of air by chemical action and heat.

Auguste J. F. de Bavay described a process in which a thin stream of freely flowing pulp was delivered upon the surface of a vessel of water, after the style of Bradford. The description of the method as used subsequently on the North Broken Hill mine does not correspond with this, for in that plant the mill-tailing, relieved of slime, is said³⁶

³⁵'Concentrating Ores by Flotation.' Page 9.

³⁶*Ibid.* Page 115.

to have been fed into a vessel provided with a mixing device, run at a high speed, so as to agitate the acidulated pulp. The sulphides rose to the surface, much in the same way as in the preceding methods of Potter and Delprat. That of Potter was used, in a modified form, at the Block 14 mine at Broken Hill in 1905 and 1906, while the Delprat

No. 763,662

PATENTED JUNE 28, 1904.

F. D. DELPRAT.

APPARATUS FOR USE IN CERTAIN PROCESSES OF EXTRACTING SULFIDS FROM ORES.

APPLICATION FILED MAR 9, 1903

NO MODEL

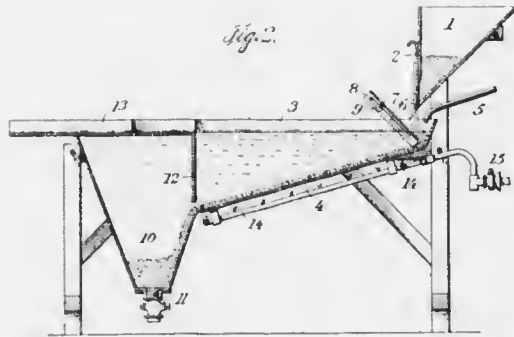
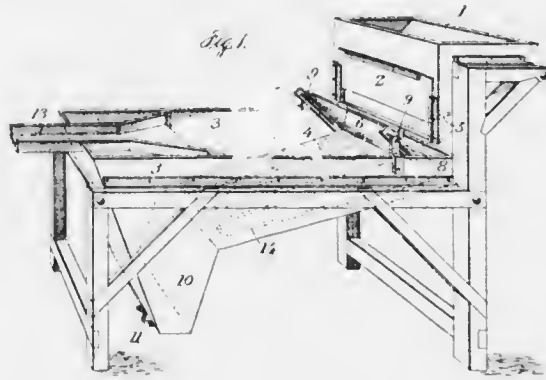

Witness
Arthur
A. L. Sommers

Inventor
Guillaume Daniel Delprat
Henry [unclear]

FIG. 6. THE DELPRAT PATENT.

process has been in use for several years successfully at the Broken Hill Proprietary mine. It is proper to add, however, that all of these acid-flotation methods are now only of academic interest. In the chief application of these processes it has not been customary to use oil, but as the material treated came from old dumps of tailing it may be assumed that there was some substance present capable of modifying the water sufficiently.³⁷

The first application of any of the oil-flotation processes on a working scale in a mill was that made at the Glasdir mine, near Dolgelly, in Wales, by Francis E. Elmore in 1899. The mixture of crushed ore and water was fed³⁸ at the upper end of a slowly revolving drum, provided with annular helical ribs and transverse blades, so as to effect the mixing of the pulp and the oil without producing emulsification. See Fig. 7. The oil was introduced through a separate pipe. The mixture was discharged into a V-shaped vessel, where the water and sand subsided while the oil buoyed the sulphides to the top. An oil-residuum having a specific gravity of 0.89 was used in equal parts by weight with the ore, ton for ton. The oil was so viscous as to require the aid of small rotary pumps to propel it forward. The temperature of the oil and water was kept between 54° and 57°F. The loss of oil was 2 gallons per ton of ore. A concentration of 14:1 was achieved with a recovery (in the concentrate) of 69% of the gold, 65% of the silver, and 70% of the copper from a pyritic and chalcopyritic ore assaying 1.12% copper, 0.049 oz. gold, and 0.8 oz. silver per long ton. The process was described as "a somewhat dirty and nasty process." It did not work on oxidized or earthy ores, nor upon tarnished sulphides.

In the course of the discussion following the reading of the paper by Mr. Rolker from which these facts are gleaned, it was acknowledged that the process developed by Mr. Elmore was based on previous experimental work done, at the same mine, by George Robson, who used petroleum in even larger proportion, as much—I have been informed—as three tons of oil to one of ore. But the most interesting fact elicited by the discussion was the statement made by Mr. Elmore, and confirmed by the superintendent of the mill, John Bevan, that the

³⁷This suggestion is made by Mr. Hoover in his book. On page 101 he says that "there may be organic substances in the ore which, upon the addition of acid, yield gummy compounds that selectively adhere to the ore." By 'ore' here he probably means 'sulphides,' that is, the blende and galena.

³⁸Charles M. Rolker. 'Notes on the Elmore Concentration Process.' Trans. Inst. M. & M., Vol. VIII (1899-1900) pp. 379-384.

actual load of mineral carried by the oil was 25%, as against the theoretical load of 10% inferred by Mr. Rolker. In short, the oil did 150% more than anybody could explain. The 'prior art' was in the dark, but the posthumous art of today can make a confident guess.

No. 676,679

F. E. ELMORE.

Patented June 18, 1901.

PROCESS OF SEPARATING METALLIC FROM ROCKY CONSTITUENTS OF ORES

(Application filed Apr. 10, 1899)

No Model.

2 Sheets—Sheet 1

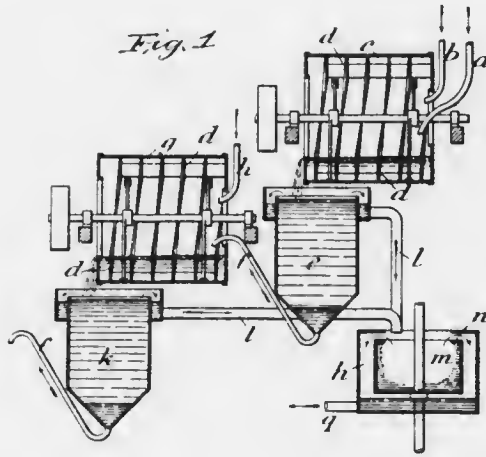

*James
Elliott*
Bruce J. Elliott

Inventor
James E. Elmore
James L. Morris
att.

FIG. 7. THE ELMORE PATENT.

Of course, the larger part of the levitation was done by air, entangled previously in the ore particles and entrained subsequently during the mixing of the pulp with the oil in the drum. Later investigators can testify how difficult it is to prevent the indrawing of air under such circumstances. Therefore even in this beginning of flotation as a practical process the agency of air was utilized, although unwittingly. Four years later Walter McDermott, who has been a consistent supporter of the Elmore brothers in their flotation business, acknowledged that "the agitation with the pulp results in the oil taking up a very appreciable quantity of air."³⁹

This fact was not recognized at first, but in 1904, six years after the first bulk-oil patent of 1898, Francis E. Elmore took out his patent for vacuum-oil flotation. See Fig. 8. In this he subjected the oiled and acidulated pulp to a vacuum, thereby releasing the air dissolved in the water. The air thus held in solution amounts to 2.2% by volume, at sea-level and 60°F. By lowering the pressure and raising the temperature this air is released, thereupon attaching itself, in the form of bubbles, to the oiled sulphide particles, which rise to the surface. For example, the air in a pulp of 1 ton of ore to 6 of water suffices to lift 360 lb. of zinc-lead sulphides in a Broken Hill ore.⁴⁰ In actual practice, however, the weight of sulphides floated is considerably greater than the theoretical capacity, as based on the efficiency of the air released from solution in the water. Part of the work is done by the gaseous carbon dioxide liberated by the reaction between the acid and the carbonates, such as calcite, either in the gangue or added in the form of limestone. Part of it is entangled in the ore particles and part of it is entrained into the pulp during mixing. In this process the quantity of oil added to the pulp was reduced to 10 lb. per ton and finally, in some cases, to as little as 3 lb. per ton of ore. The machine devised by Elmore was remarkably ingenious and to it the success of the process was largely due. It was applied at many mines, notably the Sulitelma copper mine, in Norway.⁴¹

The Potter-Delprat and the Elmore vacuum processes are clearly based on the activity of bubbles of carbon dioxide or air, or both. Next, mention must be made of Aleide Froment, who, although he

³⁹'The Concentration of Ores by Oil.' *E. & M. J.*, February 14, 1903, page 262.

⁴⁰T. J. Hoover. 'Concentrating Ores by Flotation.' Page 102.

⁴¹'Vacuum-Concentration at Sulitelma.' Holm Holmsen and H. N. Rees. *The Mining Magazine*, May 1910.

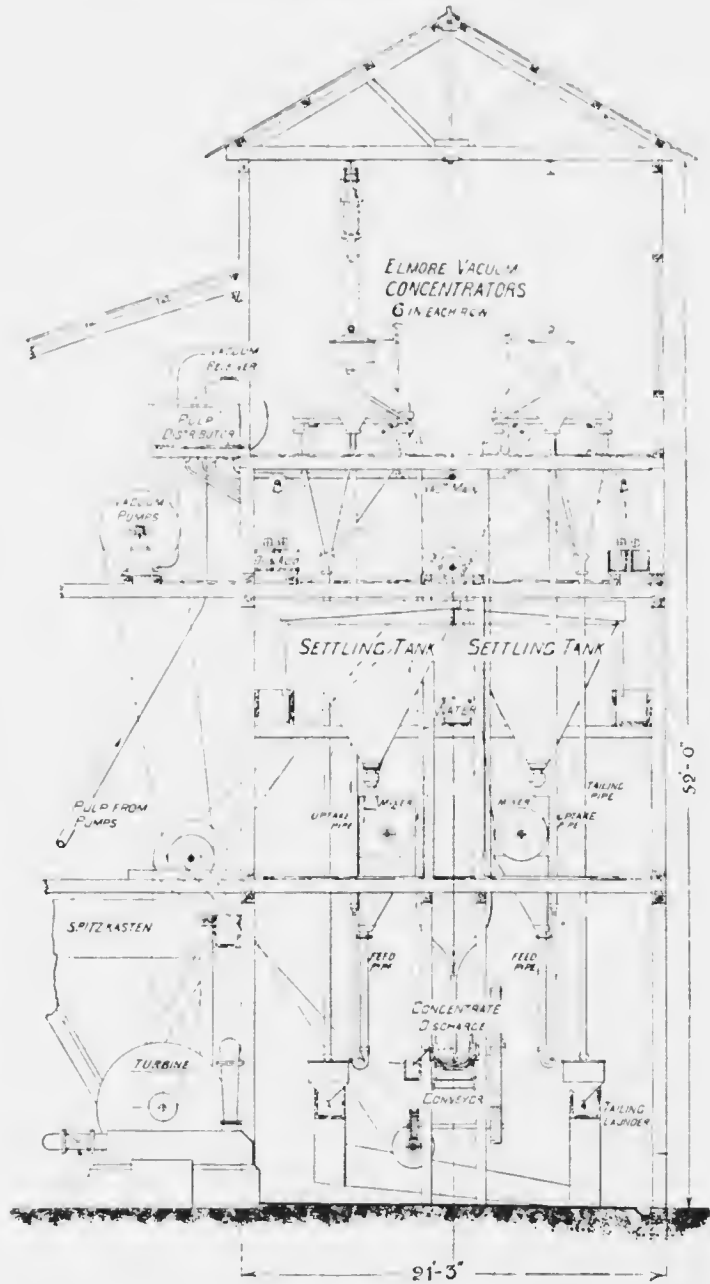

FIG. 8. THE SULITELMA PLANT.

was not the inventor of a working process, introduced the idea of violent agitation for the purpose of producing bubbles of gas rapidly from a pulp containing both calcite and acid. While he looked to carbon dioxide as the gas from which to make his bubbles, he did undoubtedly entrain lots of air and obtained the use of it in generating the bubbles that attached themselves to the oiled particles. He did not recommend much oil: only "a thin layer." In his later instructions to the Minerals Separation company, which bought his British patent in 1903, he specified that the oil was to be from 1 to 3½% on the ore.

The next method was that invented by Arthur E. Cattermole, also in 1902. It was to buy his patents that the Minerals Separation company was organized in 1903 by John Ballot, J. H. Curle, W. W. Webster, S. Gregory, H. L. Subnan, and H. F. K. Picard. Cattermole departed from the prior art. Instead of floating the sulphides, he sank them, while the gangue was assisted to rise in an upward current of water. He added oil in the proportion of 4 to 6% "of the weight of metalliferous mineral present in the ore," together with 2% of soap, so as to obtain an agglomeration of flocculent sulphide particles, which, being heavily oiled, stuck to each other, in groups or granules that sank to the bottom. He used a Gabbett,* or cone-mixer, to obtain a violent agitation of the pulp, and followed it by a gentler stirring during which the separation into "shotty granules" was effected in the presence of as little air as possible.

This process was only put to work in one mill, on the Central mine at Broken Hill, where it must have seemed a metallurgical abortion during the very short time it was in use. The oil was emulsified with soft soap and then fed into the mixers, where the crushed ore underwent agitation with acidulated water. From the very start a considerable proportion of mineral was floated on the froth incidental to violent mixing in the presence of air. Apparently only a part of the sulphides was 'rammulated,' so as to sink according to program. The remainder was floated unintentionally. The description given by the manager, James Hebbard, indicates that he and his staff stumbled upon the so-called agitation-froth process almost immediately. He records⁴² how he discovered that more froth was made by using less oil, and that the frothing and floating proved a better method than the granulating and sinking of the sulphide particles. He also states that the discovery was made concurrently by the metallurgist⁴³ of

⁴²'Flotation at the Central Mine, Broken Hill.' By James Hebbard. *Mining and Scientific Press*, September 4, 1915.

⁴³The actual operator was Arthur H. Higgins.

*See Fig. 41.

the Minerals Separation company in the London laboratory. They hit upon the same idea by varying the quantity of oil, in March 1905, so we are told. Yet the plant at the Central mine was allowed to start on the Cattermole process in July. Successful tests with the frothing process were not made until September, the proportion of oil being reduced from 3% when granulating to between 0.15 and 0.2% when frothing. The plant was gradually changed until granulation was completely ousted, by decreasing the quantity of oil and increasing the violence of agitation. The ore from the mixers was passed with "a good splash" into spitzkasten, thereby accentuating the need for aeration.

So the failure of the Cattermole method is stated to have led to the Minerals Separation process of today, the proprietary rights to which are based primarily on U. S. patent No. 835,120, dated May 29, 1905. This is a process "wherein, by the use of a frothing agent, and in the presence of such agitation as will maintain or produce distribution of the ore particles through the pulp, and dissemination of bubbles of air through the pulp and into contact with the metallic particles through the pulp, the air bubbles will seize the metallic particles and will carry them to and through the surface of the pulp, so as to permit of their delivery at or above the surface of the pulp separate from the gangue particles." This description is taken from the complainant's brief in the suit of Minerals Separation, Limited, v. Miami Copper Company, 1915. It is further explained that in this process "the frothing agent is an oil or immiscible liquid, and the discovery was that this mode of operation in the concentration of ores was attainable with small quantities of oil, quantities so small that although the oil coated the metallic particles in the exercise of the well known preferential affinity of oils for metallic substances, the coating was so minute, so nearly infinitesimal, that the oil disappeared from sight and sense. In this process the oil coats the metallic particles, modifies the water so as to produce minute and persistent air-bubbles, and increases the attraction of the metallic particles for the air-bubbles; and the persistency of the air-bubbles is such that the air-bubbles cling to the metallic particles and carry them to and through the surface of the pulp, and when the air-bubbles escape from their water environment in the body of the pulp and are exposed at or above the surface of the pulp, their water-films carrying a mineral load are maintained intact until at least their separation from the body of the pulp has been effected, by overflowing or otherwise. The air-bubbles with their mineral load form a froth floating upon the surface of the

pulp, which, if allowed to remain there in a quiescent condition will float for days and weeks. This froth has therefore been properly called a persistent or permanent froth. It will always form a coherent mass of bubbles pressed against each other and frequently several inches in thickness."

This description, lacking adequate punctuation, as is usual in legal statements, may be accepted as official, being the product of a joint effort on the part of counsel and experts representing Minerals Separation in the lawsuit at Wilmington. In the basic patent, No. 835,120, the proportion of oil is given as "a fraction of 1% on the ore." W. H. Ballantyne, patent lawyer for Minerals Separation, testified, in the Hyde suit, that "an ideal standard for the agitation-froth process is 1½ to 2 lb. oil per ton of ore." Much less is used now in the big mills of the copper mining companies.

The process was first introduced on a working scale in the Central mill of the Sulphide Corporation, at Broken Hill, as already mentioned. Two years later, in 1907, it was adopted by the Zinc Corporation, to be discarded during 1909 in favor of the Elmore vacuum process, and to be restored again to favor in 1911. See Fig. 9.

The next important application was made in 1912 at the Braden Copper mine, in Chile, where a 200-ton plant was erected. The extraction of copper (as concentrate) was 80 to 85%. But when a larger mill of two 600-ton units was built the recovery became poor, being no better than it had been in the old water-concentration mill, namely, about 65%. Whereupon the oil was added to the ore in the tube-mill and the extraction improved at once. The mill has now been enlarged to seven 600-ton units, treating 3500 tons per day.⁴⁴ The extraction last year was 77 per cent.

In February 1915 the Anaconda Copper Mining Company took a license from Minerals Separation, and at that time also the Inspiration Consolidated Copper Company made an agreement for the same purpose. Both companies built large mills for the operation of the process during last year.⁴⁵ The Anaconda now treats 12,000 tons and the Inspiration 8000 tons of ore daily by flotation.

The first mining company in America to ignore the Minerals Separation patents was the Butte & Superior, in Montana. Under the technical guidance of James M. Hyde, this company built a 150-ton

⁴⁴'The Braden Mill.' *Mining and Scientific Press*, December 18, 1915.

⁴⁵'Flotation at the Inspiration Mine, Arizona.' *Mining and Scientific Press*, July 3, 1915. Also 'Flotation at the Washoe Reduction Works, Anaconda.' By E. P. Mathewson. *M. & S. P.*, August 28, 1915.

unit in their mill during 1912. This provoked the first test case,⁴⁹ which is now before the Supreme Court of the United States.

Other companies charged with infringement are the Utah Copper, Nevada Consolidated, Magma Copper, and the Miami. The first three

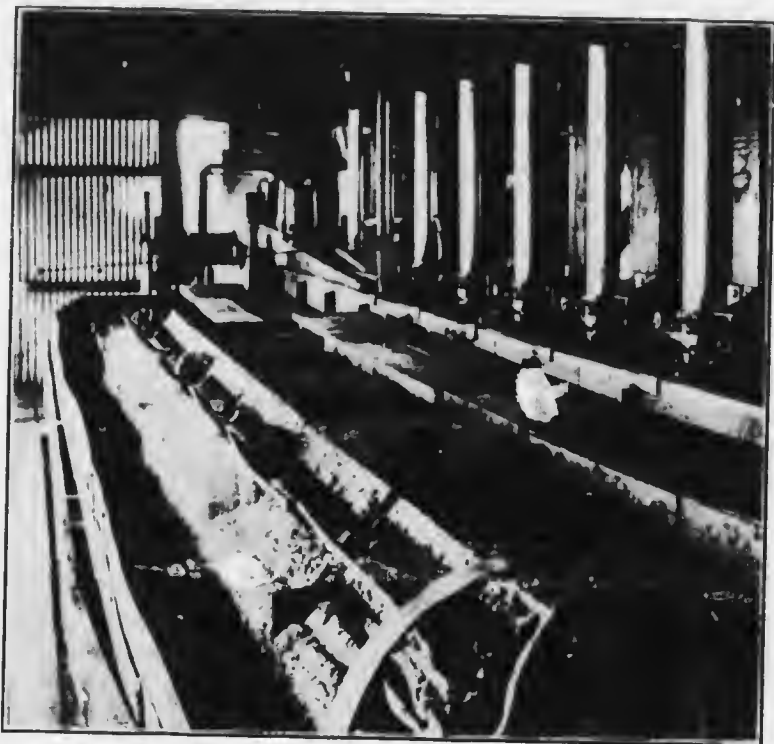

FIG. 9. THE FROTHING PROCESS IN THE CENTRAL MILL.

use the Janney machine and the last one the Callow pneumatic launder. In each case it is stated that the Minerals Separation machine—in which violent agitation is effected by blade-impellers—was tried first and then discarded as ineffective. The pneumatic flotation plant at Miami was commenced in August 1914 and remodeled in the early part of 1915. Suit for infringement was brought at once by Minerals Separation, the trial commencing on March 29 and ending on May 27, 1915. The decision of the Court is not yet known.

⁴⁹Minerals Separation, Limited, and Minerals Separation American Syndicate, Limited, v. James M. Hyde.

As applied at Miami the flotation process is simplified by the use of a launder having a canvas bottom through which air is forced under pressure. This gives the gas required for the generation of bubbles in a pulp previously modified by the addition of oil, which is mixed with the ore while being pumped into a Pachnea tank, or Brown agitator, where it undergoes further emulsification before entering the Callow launder constituting the flotation-cell. It is claimed that the froth produced in this way is different from that made in the mechanical mixer of the Minerals Separation machine. In the one case, according to R. C. Canby, the froth consists of a mass of delicate, fragile, and evanescent bubbles, which rise to the surface in rapid succession and maintain a froth only because they are being generated slightly faster than they break, so that the uppermost layer overflows, with its burden of mineral, over the lip of the vessel. In the other case the froth is said to be "thick, coherent, and persistent," as Mr. Picard phrased it. "It appears as if the minerals were protecting the tender air-bubble like an armor, and instead of destroying it, were actually guarding it. The froth has a long life. I have myself seen a froth standing for 24 hours without the least change having taken place." So testified Dr. Adolf Liebmann. Mr. Ballantyne stated that this agitation-froth of the Minerals Separation machine was so dense that it would support a spade. Mr. Canby showed that the air-froth of the Callow machine would not support a match-stem.

From the foregoing summary it is clear that three processes are covered by the general term 'flotation,' and that to clarify the discussion of the subject it will be well to distinguish between

1. Film-suspension, as in the Wood and Macquisten methods.
2. Oil-flotation, as in the Robson and Elmore bulk-oil methods.
3. Bubble-levitation, as in the Elmore vacuum, Delprat, Froment, and Sulman-Picard methods.

The third class can be further sub-divided according as carbon dioxide or air is the principal gas utilized for making bubbles.

Finally, the air-bubble methods can be classified according to the way in which the air is introduced:

- (1) From the bottom of the vessel, as in the Callow and Owen cells.
- (2) By being entrained or dragged into the pulp by the beating of paddles or some other form of impeller, as in the Gabbett and Hoover mixers.
- (3) By escape from solution in water, as in the Elmore vacuum machine and the Norris apparatus.

It remains to emphasize the fact that from the high ratio of 3 tons of oil per ton of ore, the proportion of oil used in flotation has decreased, by reason of the recognition of the part played by air, to one-third of a pound per ton of ore; that is, one eighteen-thousandths of the quantity used by Robson. Concurrently the acid used has decreased to a minus quantity, namely, alkalinity.

THE PATENTS. This is the part of the subject of which we have heard the most; indeed, until recently the literature of the flotation process was closely identified with the records of patent litigation. That is why the scientific principles are as yet so little understood and the technology of the process has made such scanty progress. The aim of a patent specification is to disclose just enough to prove originality. In many cases this has been done to the apparent satisfaction of the Examiner of Patents without conveying all the facts essential to a clear understanding of the operations involved. The description given in a modern patent is cryptic; it is couched in a quasi-legal jargon that assists obfuscation. I refer to processes only, for the disputes over flotation patents have arisen over methods not machines. The apparatus required had already been used in other branches of wet metallurgy, so that we have been spared one source of trouble, at least.

The litigation, which is now a serious obstacle to the free development of the process, has arisen largely from confusion of ideas as to the underlying causes of flotation. The patentees did not understand the phenomena with which they played. Those to whom they sold their patents knew even less. The interpretations of attorneys and judges have elucidated the law but confused the physics. No clear adjudication of rights is possible so long as claims and counter-claims are based on an ignorance of the rationale of the process.

As the flotation process of today is essentially that of making a mineral-buoying froth in modified water, it is not necessary for me to make further reference to the patents granted for the use of purely surface-tension effects. It would seem permissible also to omit further consideration of the bulk-oil methods, but, as a matter of fact, none of these operated without the aid of air, although the patentees were quite unaware of it, and it was from these bulk-oil methods that the frothing process was developed fortuitously.

The first patent for the use of oily substances and coal-tar products in the concentration of ores was that granted to William Haynes, an Englishman, in 1860; but this is now only of academic interest. Next comes the patent of Carrie J. Everson, dated August 24, 1886, the

application having been filed on August 29, 1885.²⁰ The Everson patent refers to the selective action of oil for "metallie substances" and the increase caused in that selectiveness by the addition of acid. The pulp is stirred so as to bring "the mineral" in contact with the oil and acid, producing a "stiff mass." The use of "about a barrel of oil to the ton of ore" is mentioned, indicating a ratio of about 17%. Other statements indicate that she used as little as 5% of oil per ton of ore. The separation of the oiled mineral from the unoled gangue is described thus: "In practice, the concentrate, after thorough agitation of the mass and detachment of the sand, will in this case be preferably removed by means of a constant overflow of water from a washing-out vessel, by which overflow the concentrate will be floated off." These last words constitute the only direct reference to the floating of the concentrate.

A great deal more has been read into this patent than could ever have been in the mind of the patentee. It is difficult to read her description without cocking one eye at the present practice of flotation, whereby some of Mrs. Everson's phrasing is given a significance to which it had no possible claim 30 years ago. The proportion of oil used, even the maximum, would not suffice for the operation she had in mind, namely, the floating of the heavy sulphides by direct aid of the buoyancy of oil. Her maximum proportion of oil represents a mere fraction of the quantity required for this operation. She disclosed no notion of the assistance to be obtained from air, in the form of bubbles, although, of course, this was her principal flotative agent. The process described by her is quite impracticable on a large scale, and it never was operated save in a crude experimental way. Nevertheless the exigencies of patent litigation have caused the opponents of Minerals Separation to idealize both Mrs. Everson and her metallurgical adventure, as they have also created a romantic story of the supposed epoch-making discovery. She is represented as a school-teacher, a Miss Everson, who, as the sister of an assayer, washed some greasy ore-sacks and saw the sulphides floating on the contaminated water. Even the idea of agitation was suggested by the activity of her hands in the wash-tub. Therefore "it only required the customary acuteness of observation of the Western lady school-teacher to grasp the essential facts of sulphide flotation."²¹ This is pretty, but not scientific. The "essential facts" are a bit too slippery to be grasped

²⁰The date of application is the more important, as being the one from which priority of invention is measured.

²¹'Concentrating Ores by Flotation.' Page 5.

firmly even today. In thinking acid necessary, she was wrong. It is known now not to be an essential. Even the use of oil as a direct means of buoyancy has receded into the background; if she had understood the rationale of her own operations she would have known that it was not so much the selective adhesion of the oil to the mineral particles that gave her the requisite buoyancy as the greater selectiveness of the air bubbles made by agitation in water modified by the oil. Carrie Jane Everson had no idea of the frothing process. Her methods may have involved bubble-levitation, but she did not know it, and her description would not suggest it to anyone not versed in much later knowledge. The effort to feature this lady as the inventor of the frothing process cannot commend itself to an unprejudiced student of the subject.

It is interesting to add that the "Miss Everson" of the story was really a Mrs. Everson; the wife of a Chicago doctor; she was not a school-teacher; her brother was not an assayer; and there is no reason for regarding the story of the ore-sacks as anything more than the fiction of an irresponsible scribe.²² Mrs. Everson died at San Anselmo, California, on November 3, 1914.²³

Next comes the British patent of January 8, 1894, granted to George Robson,²⁴ an Englishman, who did his experimental work at the same place and on the same ores as the Elmore brothers, at the Glasdir mine, near Dolgelly, in Wales. He disclaimed "the use of acids or salts and also the method of washing away the gangue with water," effecting "the separation of the metallic matter by the mixture of oils alone." He does not specify the quantity of oil, but I am informed that it was in the ratio of 3:1, three tons of oil to one of ore. This was true bulk-oil flotation and it proved an abject failure.

Then came Francis Edward Elmore, on April 10, 1899, duplicating his British patent of October 18, 1898. His method has been described already. It only remains to say that in so far as this method proved more practicable than that of Robson, the result was due to the fact that the Elmore brothers were capable engineers and therefore designed a more suitable plant. The patent ignored the use of air; the intention was not to emulsify the oil and not to aerate the pulp, but this theoretical condition was never fulfilled, as is clear from the fact that the flotative action was 150% more than that calculable from the

²²In the *Financial Times*, March 2, 1902.

²³'The Everson Myth.' *Mining and Scientific Press*, January 15, 1916.

²⁴His American patent is dated January 19, 1897.

difference of specific gravity between the oil and the water. On January 3, 1903, A. Stanley Elmore took out a British patent for an apparatus for excluding the air during the operation. He effected his purpose by sealing all the open vessels with a ring or surface of oil; from which it is evident that at that time he and his brother endeavored to base their method wholly on bulk-oil flotation.

In January 1902, Charles V. Potter, an Australian, obtained a British patent for the flotation of sulphides in a hot acid solution. He used a stirrer, and he claimed that the solution would "react on the soluble sulphides present to form bubbles of sulphuretted hydrogen on the ore particles and thereby raise them to the surface."²⁵

In November of the same year, 1902, Guillaume D. Delprat, the manager of the Broken Hill Proprietary mine, applied for a similar patent, except that he used salt-cake instead of sulphuric acid. Litigation ensued, followed by a compromise, eliminating Potter. In later patents both Potter and Delprat introduced the use of oil, finding it beneficial.

In his first American patent, No. 735,071, filed on January 2, 1903, Delprat states that the process "depends upon the ore particles being attacked by the acid to form a gas. Each ore particle so attacked will have a bubble or bubbles of gas adhering to it, by means of which it will be floated and can be skimmed or floated off the solution." ("Ore particles" means blende and galena at Broken Hill.) Here is a pretty good recognition of bubble-levitation, only he supposed the sulphides, not the gangue, to be attacked by the acid. In another place he says specifically: "The sulphides in the ore are rapidly attacked by the acid and gas-bubbles formed on them, that quickly carry them to the surface." In this patent he claimed the use of nitric acid and a suitable nitrate, such as sodium nitrate, the latter being intended "to increase the specific gravity of the bath." What reaction was to follow between the sulphides and the dilute nitric acid is not clear. It has been recorded²⁶ that in the early days of the Potter-Delprat methods it was supposed that the acid liberated hydrogen sulphide from the sulphides, when sulphuric acid was used, without attacking the gangue. Those who first scouted this idea suggested that carbon dioxide was generated by decomposition of a carbonate coating on the sulphides, due to weathering of the ore, arguing therefrom that it was necessary for the gas to be produced at the surface of

²⁵U. S. patent No. 776,145. Claim 3.

²⁶'The Physics of Ore Flotation.' By J. Swinburne and G. Rudolf. *Mining and Scientific Press*, February 24, 1906.

the sulphide particles themselves. All of these explanations²⁷ are now on the scrap-heap of discarded theories.

These patents of Potter and Delprat have been labelled variously

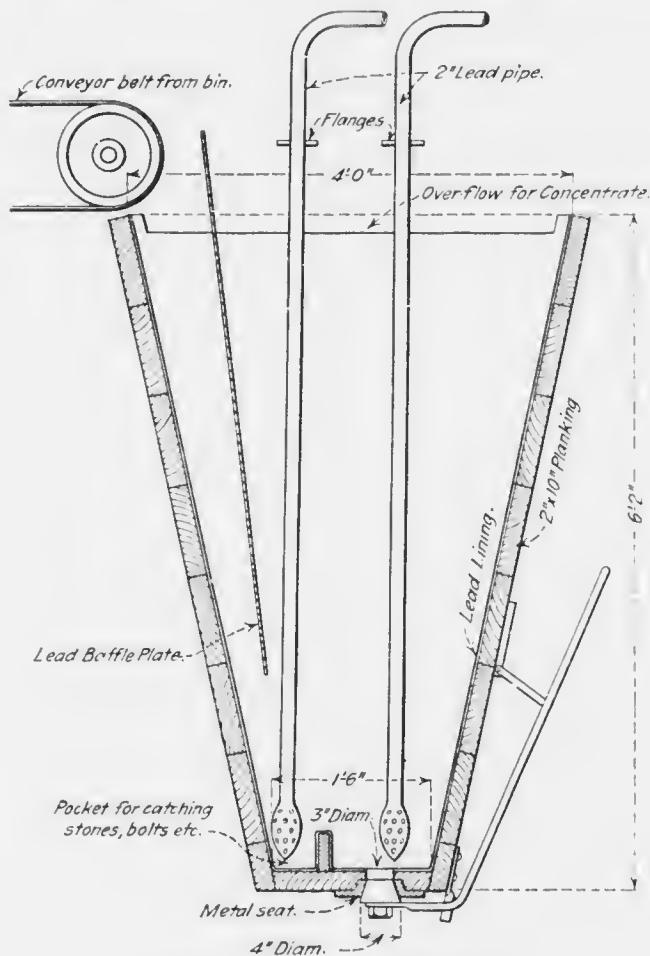

FIG. 10. THE POTTER APPARATUS.

under 'acid-flotation' and 'surface tension' methods. Delprat's apparatus does indeed suggest a process of the Bradford or Wood type, but, of course, both he and Potter depended for their results on the

²⁷In his book Mr. Hoover states (page 13, second edition) that Goyder & Laughton, in their patent of July 31, 1903, "were the first to disclose the

liberation of carbon-dioxide gas from the gangue, which, at Broken Hill, contains a large proportion of carbonates, notably calcite, siderite, and rhodocerosite. From any of these a hot sulphuric-acid solution would release the gas that promptly attached itself to the metallic surfaces of the galena and blende.

Meanwhile Alcide Froment, in Italy, had got hold of the bubble idea, which is the real basis of the flotation process as it is understood today. He invented his method in 1901 and filed his claim for a British patent on June 9, 1902. This patent was duplicated in Italy, but *not* in the United States. The fact last mentioned is important. Froment claimed that his process was "a modification of what is known as the oil process of ore concentration," meaning that of Elmore, for the bulk-oil method had been tried at the Traversella mine, in Italy, where Froment was engaged as an engineer. His plan was to generate bubbles of gas by the reaction between sulphuric acid and the carbonates in the gangue, adding limestone when the ore did not contain enough carbonate. He argues that "if a gas of any kind is liberated in the mass, the bubbles of the gas become coated with an envelope of sulphides and thus rise readily to the surface of the liquid where they form a kind of metallic magma." It will be noted that he says "gas of any kind." As the children say, in a familiar game, he was "very warm" just then, for he had only to invoke the aid of air to have described the essential principle of the later phase of flotation. He also states that the sulphide particles when "moistened by a fatty substance" have a tendency "to unite as spherules and to float upon the surface of the water." His brief description closes with the statement that "the rapidity of the formation of the spherules and their ascension is in direct ratio to the quantity of gas produced in a given time." As to the oil, the only mention of quantity is made in describing a test-tube experiment in which he uses "a thin layer of oil." This phrase has been variously interpreted, according to the exigencies of litigation, but it refers obviously to a minute proportion.

principle governing Potter's and Delprat's acid-flotation process, namely, that the action of the acid on the ore generated gas-bubbles to which the sulphide particles attach themselves, and were floated to the surface." What they said was that "the physico-chemical action develops the formation of gas-bubbles adhering to particles of certain of the finely-divided minerals and causing such particles of certain minerals to rise to or near the surface of the solution." But this does not make it clear that the bubbles are obtained by the decomposition of the carbonates in the gangue; it is more nearly compatible with Delprat's idea that they were generated by the action of the acid on the sulphides themselves.

In the directions given by him to the Minerals Separation people when they bought his patent rights on November 17, 1903, he specified 1% of mineral engine-oil for ore containing up to 5% of metal, $1\frac{1}{2}$ of oil for ore containing 10%, and so on, up to ores containing 50% of metallic lead, which would require $3\frac{1}{2}$ % of oil. As oil flotation was understood at that time, this marked a great reduction in the proportion of oil. However, the more interesting point is Froment's failure to perceive the possibility of using air as the gas for making his bubbles. He depended upon chemical action to furnish him with the necessary gas. Nevertheless Froment deserves a high place in the roll of flotation pioneers, for he made an important step forward. He furnished the link between bulk-oil and air-froth flotation.

The next chapter in the story marks a retrogression. Under date of November 28, 1902, Arthur E. Cattermole obtained British patents No. 26,295 and 26,296, both of which were acquired by John Ballot and associates in December 1902, preparatory to the formation of the company—Minerals Separation, Ltd.—organized to exploit them. In August 1903 Cattermole revised and amplified his previous claims in British patent No. 18,589, which was duplicated in the United States under date of September 28, 1903, as No. 777,273. This last is the principal patent covering the so-called granulation process.

Cattermole prefaces his description by reference to the selectiveness of oil, when emulsified, for sulphide particles, such selective action being intensified by the acidulation of the water. He then proceeds to say that if the mixture be thoroughly agitated, there is a tendency for the metalliferous particles, now coated with oil, to adhere together, forming granules²⁸ that sink and are readily separated from the lighter gangue by an up-current of water. In his description of the operation he says that "the granules, with a certain amount of heavy sands, sink to the bottom and are discharged [see Fig. 11] through a pipe G¹ into the vessel A⁵, while the lighter sands are carried away by the upward current and discharged through outlet G² to a light-sands tank J." In the drawing, A¹, A², A³, A⁴, A⁵, and A⁶ are mixing vessels; G and K are classifiers; E is a tank containing oil emulsion. He refers to the quantity of oil several times in vague terms, explaining, however, that it should be "insufficient to materially lessen the specific gravity of the metalliferous mineral particles." Finally, he specifies the proportion as "usually an amount of oil varying from 4% to 6% of the weight of metalliferous mineral matter present in the ore." This can be interpreted variously; if it refers to the sul-

²⁸The 'granules' may be contrasted with Froment's 'spherules.'

phides to be concentrated, then an ore containing 20% blende would require from 0.8 to 1.2% of oil, equivalent to from 16 to 24 lb. oil per ton of ore. On the other hand a 2% chalcocite ore would need only 1.6 to 2.4 lb. of oil per ton of ore, which is as little as is now used.

This Cattermole process was the subject of lengthy experiment in the London laboratory of the Minerals Separation company, where all

No. 763,259.

PATENTED JUNE 21, 1904.

A. E. CATTERMOLE.

CLASSIFICATION OF THE METALLIC CONSTITUENTS OF ORES.

APPLICATION FILED SEPT. 29, 1903

NO MODEL.

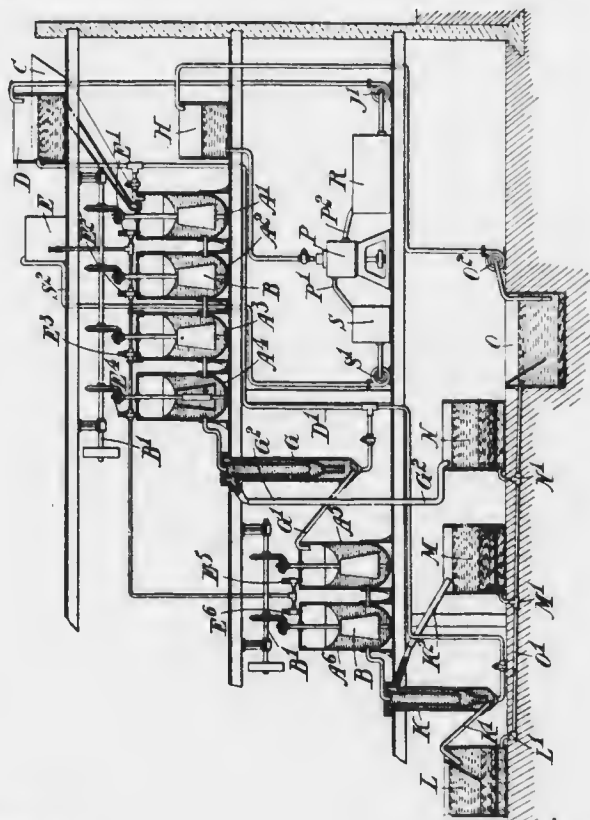

Witnesses:
[Signature]
[Signature]

Inventor:
 Arthur E. Cattermole,
[Signature]
 Attorney

FIG. 11. THE CATTERMOLE PATENT.

sorts of variations in temperature, acidification, oiling, and mixing were tried by Arthur H. Higgins under directions from H. L. Sulman and H. F. K. Picard. It was not until March 1905, that is, nearly 2½ years subsequent to the patenting of the Cattermole method, that it was found advisable to float the 'granules' rather than sink them, whereupon ensued "the startling discovery of the agitation-froth process," as W. H. Ballantyne has described it. A similar discovery was made contemporaneously at Broken Hill, but there, according to James Hebbard, it was not so "startling;" it was the result of strenuous efforts to make a workable process out of the impracticable method devised by Cattermole. See Fig. 12 and 14.

This 'discovery' led to Minerals Separation's basic patent U. S. No. 835,120, of May 29, 1905, which duplicated the British patent No. 7803 of April 12, 1905, taken out in the names of H. L. Sulman, H. F. K. Picard, and John Ballot. In this patent the aid of chemically-generated gas is discarded definitely, in favor of air-bubbles. This seems to me a matter of far greater importance than the reduction in the proportion of oil. The patentees say: "It is to be understood that the object of using acid in the pulp according to this invention is not to bring about the generation of gas for the purpose of flotation thereby, and the proportion of acid used is insufficient to cause chemical action in the metalliferous minerals present." This differentiates the method from those of Potter, Delprat, Froment, and De Bavay, the addition of acid being therefore presumably to assist the selective oiling of the sulphides. The patentees also state that "a large proportion of the mineral present rises to the surface in the form of a froth or scum which has derived its power of flotation mainly from the inclusion of air-bubbles introduced into the mass by the agitation, such bubbles or air-films adhering only to the mineral particles which are coated with oleic acid." The last clause had better have been omitted, for it is only conjecture, as to the truth of which there is room for plenty of doubt, but the clear description of air as the main agent of flotation is most important—far more important as regards the rationale of the process, than the diminution in the proportion of oil.

As to this, it is stated that if the proportion of oil mentioned in the previous Cattermole patents "be considerably reduced—say to a fraction of 1% on the ore—granulation ceases to take place, and after vigorous agitation there is a tendency for a part of the oil-coated metalliferous matter to rise to the surface of the pulp in the form of a froth or scum." One per cent on the ore is equal to 20 lb.

of oil per ton; a 'fraction' of 1% is anything between 20 and 0 pounds per ton. In enforcing the right to the collection of royalties, the Minerals Separation company has rested its claim mainly on the reduction of oil, claiming that it produces a series of phenomena quite different from any of the other methods employing larger proportions of oil, and, concurrently, insisting that such superior effects as are produced by the use of the reduced quantity of oil are un-

No. 835,120.

PATENTED NOV. 6, 1906.

H. L. SULMAN, H. F. KIRKPATRICK-PICARD & J. BALLOT.

ORE CONCENTRATION.

APPLICATION FILED MAY 29, 1905

3 SHEETS—SHEET 2

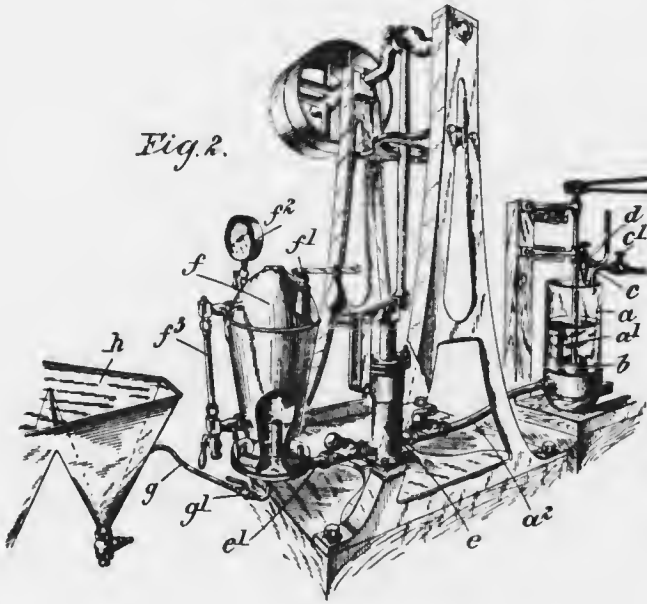

Fig. 2.

Witnesses
Al Knight
J. T. Jones

Inventors
Henry L. Sulman
Hugh F. Kirkpatrick-Picard
John Ballot
 by *Wright & Co.*
 Attorneys

FIG. 12. THE CHIEF MINERALS SEPARATION PATENT.

obtainable when the larger proportions of oil are used. Thereupon, of course, it has been claimed, by those desiring to ignore the Minerals Separation basic patent, that neither the Cattermole nor the Froment methods demanded a quantity of oil notably larger, for the minima prescribed by these earlier inventors come under 20 lb. of oil per ton of ore. However, this matter is still *sub judice*, so it is best let alone for the present.

Between the Froment patent of 1902 and the Sulman-Picard Ballot patent of 1905 comes the Kirby patent U. S. No. 809,959 of December 14, 1903, granted on January 16, 1906. This is interesting as specifying gentle agitation and the use of a gas, making it possible to use thin oils instead of the viscous oils of the prior (Elmore) art. The claim is made that "the injection of gas, preferably air, into the mass, assists in the flotation of the hydrocarbon-coated particles." The mention of air, as an assistant flotative agent, is more important than the reference to the kind of oil.

The actual part played by the oil has been misapprehended from the very first, the earlier investigators using not enough to produce bulk-oil flotation, while the later metallurgists have employed much more than was needed for bubble-levitation. The relative importance of the part played by air was persistently ignored until a late date and even then it was under-estimated. It is interesting to note that the two first patents in which air was specified as a gas suitable for flotative effects were those of F. E. Elmore and the firm of Sulman & Picard. Francis E. Elmore obtained a British patent for his vacuum-oil method under date of August 16, 1904, and duplicated it in the United States as No. 826,411 of July 10, 1905. Sulman & Picard obtained a British patent for their perforated-coil patent under date of September 22 1903, duplicating it in the United States as No. 793,808 of October 5, 1903.

The Sulman & Picard patent just mentioned has been claimed by the Miami Copper Company as the one covering their operations with the Callow pneumatic cell.²⁹ In No. 793,808 the inventors "utilize the power which is possessed by films or bubbles of air or other gas of attaching themselves to solid particles moistened by oil or the like." They also state that they add oil "in quantity insufficient to raise the oiled mineral by virtue of the flotation power of the oil alone. A suitable gas is generated in or introduced into the mixture, such as air, carbonic-acid gas, sulphuretted hydrogen, or the like. For example, bicarbonates or carbonates, either soluble or insoluble in

²⁹Note the sloping launder-like vessel used by both. See Fig. 15 and 33.

water (preferably the latter) or easily decomposable sulphides and the like may be used with acid solution." Thus they lessen the emphasis on air as the prime agent. The description also refers to the oiled metalliferous particles as "attaching to themselves, with a greater comparative strength than the gangue particles, the films or

No. 873,586

PATENTED DEC. 10, 1907

D. H. NORRIS.

APPARATUS FOR SEPARATING THE METALLIC PARTICLES OF ORES FROM THE ROCKY CONSTITUENTS THEREOF.

APPLICATION FILED AUG 7 1907

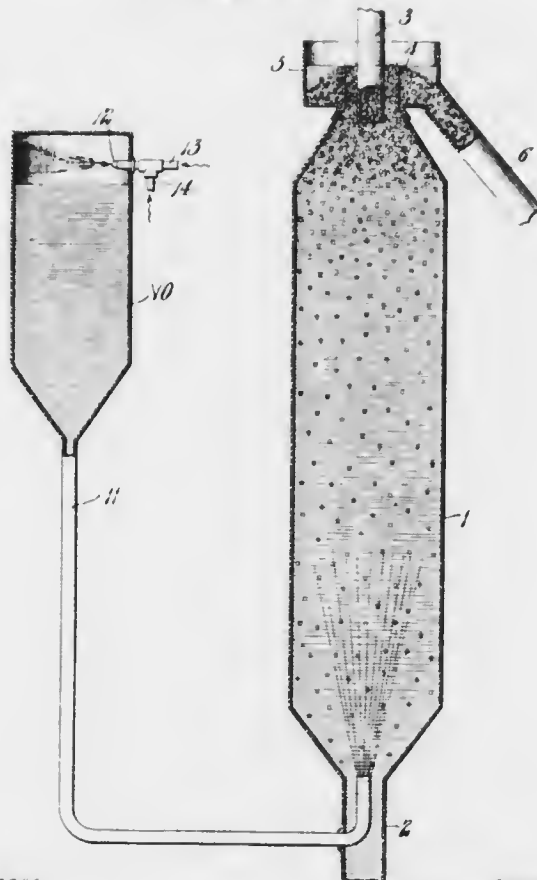

Witnesses:
Geo. P. ...
Wells & Clark

Inventor
Dudley H. Norris.
 By *Peckwood & ...*

FIG. 13. THE NORRIS PATENT.

bubbles of gas which exist in the mass and are thus raised to the surface of the liquor by gaseous flotation." Yet we are told that the metallurgists who prepared this excellent description of the bubble-levitation method made "a startling discovery" of the frothing process eighteen months later. This U. S. patent 793,808 is more than a year junior to Froment's British patent, and contains an echo of it in the introductory announcement.

Elmore's vacuum-oil process marked another inadvertent step toward the recognition of air as the most important flotative agent. He utilizes the air naturally dissolved in water, releasing it for his purpose under a vacuum. The patent states that "under a vacuum or partial vacuum, air or gases dissolved in the milling water are liberated. These liberated gases may be augmented by the generation of gases in the pulp, or by introduction from an external source." Elmore invented a most ingenious machine for his purpose. In so far as he depended upon the air in a pulp that had undergone mixing with a quantity of oil relatively small (as compared with his bulk-oil method) he furnished a notable metallurgic sign-post, but it is necessary to remember that he mixed his crushed ore in acidulated water and that the acid would cause the generation of carbon-dioxide gas, thus explaining his reference to "air or gases."

The first inventor to break away from the use of either acid or oil and to make a clear claim for air as his sole flotative agent is Dudley H. Norris, in U. S. No. 864,856, under date of November 19, 1907, also in No. 873,586, of December 10, 1907. See Fig. 13. In his first patent he described a method for "introducing water containing air in solution into the lower end of an open-ended receptacle into which is introduced a flowing mixture of pulverized ore mixed with oil and water, thereby exposing said mixture to the continuous action of infinitesimally small nascent bubbles of air." He does not specify the use of acid and he distinctly says that he does not wish it to be understood that his method "is limited to the use of oil, as the method can be practised successfully without mixing oil with the pulverized ore and water." Incidentally, his method is worthy of friendly interest, for he has declared his intention to render the use of it free of tonnage royalty.*

Having got rid of acid and oil, we have now reached the point where modified water mixed with the crushed ore in the presence of air suffices to form bubbles sufficiently lasting to buoy the metallic particles to the surface of the liquid.

*See page 274 of this book.

THE PSYCHOLOGY. A potent factor in the history of flotation has been the psychology of the persons concerned in the invention, improvement, and application of the process. To understand the scanty and contradictory literature of the subject it is necessary to read between the lines with some knowledge of the personal equations that have rendered the problem so confusing to the later student. For example, it is an interesting fact that the first workable method was that of the Elmores, who, however, simply carried forward the ineffective research of Robson and Crowder, at the Glasdir mine. The Elmores knew of the experiments made by Robson, more particularly, for his simple apparatus was left on view at the mine when Francis Elmore and his brother came there in 1897 and became interested in the problem. Next there is the fact that in 1902 the Elmores placed their Australian rights to the bulk-oil process under option to the group headed by Messrs. Webster and Ballot, by whom Messrs. Sulman and Picard were employed. The latter were given every facility for becoming completely familiar with the operations of the Elmore process, but the Australian option was not exercised, and the group that had rejected the option formed the Minerals Separation company and proceeded to exploit another method themselves. Whereupon, not unnaturally, there arose charges and counter-charges of bad faith, provoking the lawsuit of 1907,³⁰ which decided nothing, but left a lot of ill feeling in its wake.

The atmosphere amid which the various processes were tried at Broken Hill is illustrated by the fact that in the course of a successful, but misleading, test of the Potter method, the workmen in the Zinc Corporation's plant made it a practice to add lubricating oil to the hot-acid solution in order to improve the result. This fact was not ascertained until several years after the test had been finished. At that time feeling ran high between the various process companies and "the Zinc Corporation's experimental work was subjected to many unfavorable arguments of an extremely substantial nature, such as a varied assortment of scrap-iron, dropped into agitators, gearing, or pump-sumps."³¹

In order to understand the later developments, it should be stated that Theodore J. Hoover joined Minerals Separation Ltd. as technical adviser and general manager in October 1906 and resigned in December 1910. Unpleasant misunderstandings ensued. The first edi-

³⁰'Concentrating Ores by Flotation.' Pages 46-48.

³¹D. P. Mitchell. 'Flotation at Zinc Corporation, Ltd.' *E. & M. J.*, November 18, 1911.

tion of Mr. Hoover's book appeared two years later, in December 1912. James M. Hyde was in the employ of the Mexican syndicate organized by Minerals Separation for one year, from January 1910 to January 1911. At the instance of Herbert C. Hoover he went to Montana on an inspection of the Butte & Superior mine. Mr. Hoover withdrew from this business, but Mr. Hyde proceeded to test the ore and erect a trial flotation plant, in disregard of the Minerals Separation patents. Suit was brought against him by Minerals Separation in October 1911. E. H. Nutter was engaged by T. J. Hoover for Minerals Separation in 1910; he has been in the United States for that company since 1911, most of the time as its representative in San Francisco.

J. M. Callow's American patent for his pneumatic launder is No. 1,104,755 of July 21, 1914. It covers the same idea as appears in T. J. Hoover's British patent No. 10,929 of 1910. I am informed that Mr. Callow was unaware of Mr. Hoover's invention, which was not patented in this country and is now the property of the Minerals Separation company. However, priority of invention as regards this apparatus is a matter of academic interest only. R. S. Towne used the same idea earlier than Mr. Callow in the form of a carborundum wheel, the central hole of which he plugged, so that the wheel served as a porous bottom.

No American application of the bubble-levitation phase of flotation to the concentration of ore was made until long after the Minerals Separation's basic patent had been registered. As previously related, the early trials were made at Broken Hill. The first introduction of this method in the United States occurred six years after the date of patent No. 835,120. It is claimed by Minerals Separation that "if the directions of the patent are followed, the operation of the process is inevitable," yet many years of trial and experimentation were required before flotation was used successfully in this country. The Utah Copper and the other Jackling companies made successful application of the process by aid of their own research and persistent effort. Up to 1911 the Minerals Separation metallurgists thought chalcocite could not be treated by flotation, and said so. In Mr. Hyde's report of January 8, 1911, given as an exhibit by Minerals Separation in their suit against Hyde, it is stated that the tests carried out in the company's London laboratory proved that "the copper ores of a good part of the Southwest and also of at least a portion of the Utah region contain chalcocite, which is not floatable by any of the methods so far tested." This opinion epitomizes the experience gained up to that

time in the London laboratory. Even in the 1914 edition of his book, Mr. Hoover mentions* the presence of bornite and chalcocite as likely to limit the successful operation of the process. It is now recognized that chalcocite is easier to float than pyrite. It is fair to add that, at

T. J. HOOVER.
 APPARATUS FOR ORE CONCENTRATION,
 APPLICATION FILED MAR. 17, 1909.

953,746.

Patented Apr. 5, 1910.

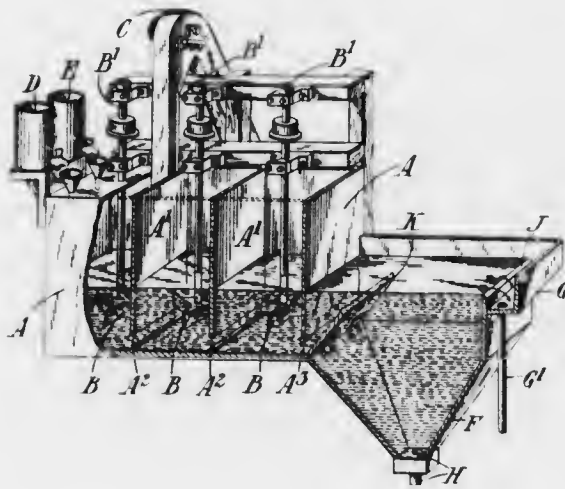

Witnesses
J. W. Myerhoff
Geo. P. Stanley

Inventor
T. J. Hoover
 134
Knight
Attorney

FIG. 14. THE HOOVER APPARATUS PATENT.

*Page 190. 'Concentrating Ores by Flotation.'

a later date, one or two important copper companies obtained an increased revenue thanks to the insistence of Minerals Separation in recommending the use of their method. This insistence resulted in valuable contracts.

It is well to warn the reader against the inferences attempted to be made from experiments in court, or elsewhere, intended to prove that sundry effects can be obtained or cannot be obtained by following the descriptions in various patents. As a matter of fact the results depend largely upon the manipulation, performed usually by an operator who knows a great deal that was not known at the time the description was written. Moreover, the improvement in apparatus enables a later-day operator to apply recent knowledge in the course of an experiment supposedly based upon an old method. By aid of Herodotus[†] and a slide machine it is possible to produce a performance that might well perplex a philosopher, or a judge.

In Mr. Hoover's book the average royalty levied by the process-mongers is given as 1 shilling or 25 cents per ton. Writing in July 1912, this author stated that the combined capital of all the companies controlling flotation processes was about \$5,000,000. As the companies had then been in existence for 7 years, they should have treated 38,000,000 tons in order to return their capital and 10% per annum. Up to that time they had treated, he says, only 8,000,000 tons. Thus he drew a melancholy picture. But the adoption of the process by the big copper mining companies in this country is going to make those figures of four years ago look small indeed. This year 20,000,000 tons will be treated in the United States alone; next year, the tonnage may well increase to 30,000,000, taking no count whatever of the operations in Australia, Chile, British Columbia, Korea, Mexico, and other parts of the world. Soon it will be 100,000 tons per day in the United States alone. The process-mongers have a prize worthy of a big fight and the users have an incentive to curb any attempt to impose an excessive royalty accompanied by an embargo upon knowledge. That is where Minerals Separation has antagonized so many. They have claimed royalties where previously they had reported that the ore was unsuitable to flotation. Some of the companies that are now operating successfully went first to Minerals Separation for guidance and obtained so little assistance that they

[†]Who has told us about the maidens dwelling upon a mysterious island on which there was a lake of pitch. The maidens went to this lake, dipped their feathers in the pitch, and then proceeded to another lake where they extracted gold from the sand by trailing their pitchy feathers.

had to solve their own difficulties for themselves. One or two big companies have won reasonable terms; for instance, it has been disclosed that the Anaconda and Inspiration companies have guaranteed that if the Supreme Court reverses the Hyde case, or if they do not exercise their option to surrender their license in case of affirmance, they will treat 25,000,000 tons of ore by the Minerals Separation method by 1923, and will pay the agreed royalty thereon, this royalty being $\frac{2}{3}$ cent per pound of copper, but not less than 12 cents per ton of ore; and meanwhile, whatever the decision of the Supreme Court, they have agreed to pay a royalty of \$300,000 to Minerals Separation within a year from date—nine months ago. Having regard to the fact that the extraction by flotation, as compared with ordinary water concentration has been improved from 63 to 95%, at no greater cost in plant or of operation, it is obvious that the copper companies can well afford to pay such a royalty, if the improvement is due to the use of patents owned by Minerals Separation. That point the Supreme Court will decide at an early date.

But, as I have said, it is not the amount of the royalty but the method of levying tax and the attempt to place an embargo on all information concerning the technique of the process that has aroused opposition. The type of contract made with licensees has caused many operators to refuse to come to terms; but the more objectionable practice has been the enforcement of binding contracts on the metallurgists employed by the licensees, such contracts being legally invalid and representing an attempt to bluff the profession.³²

For the most part, until quite recently, the information available on the flotation process has come from patentees, their friends, and their enemies; a good many of the facts available have been elicited in the course of litigation, which has now been in progress for ten years; therefore a vast amount of non-science has been mixed with the little science that has survived amid thoroughly uncongenial surroundings. Anybody familiar with the bitter business feuds and personal vendettas generated during the course of quarrels over patent rights needs not to be told that keen prejudice, amounting in some cases to malice, has been injected into the ragged literature of flotation. The warping of scientific vision is astounding to the detached observer. Much that has got into print and more that has escaped a permanent record has been written with a jaundiced eye on the law-courts. On top of this the metallurgy of the subject has been placed

³²'Minerals Separation Contracts with Metallurgists,' *Mining and Scientific Press*, February 5, 1916. Also 'A Professional Matter,' in the same issue.

under an embargo of secrecy by the owners of the chief patents, and this has been effective to the extent of preventing the technical men in the employ of the process-mongers from contributing to current knowledge. Only recently has there been any considerable contribution from independent sources of information.

Another important element in retarding the technology of the process is the ignoring of the fact that it depends far more on physical than on chemical considerations. To the physicist, not the chemist, we must look for guidance. The metallurgist hitherto has depended upon chemistry to guide him; he must now go back to school and acquire something more than a smattering of physics, if he expects to understand the problems of the new process. To most of us chemistry comes more easily because it has a sign language, that of the formula, to convey ideas, while physics depends upon the use of terms, half of which beg the question. Hence the student must begin by rejecting the use of terms that he does not understand and when he has learned to understand them he must take pains to define them whenever he undertakes to convey his ideas to others. By such sincerity of thought it will be possible to make real progress, and to apply science to industry with results far transcending any hitherto achieved in this field of human activity.

FLOTATION TESTS AT MOUNT MORGAN

By WILLIAM MOTHERWELL

(From the *Mining and Scientific Press* of June 27, 1914)

The Mount Morgan gold mine in Queensland, Australia, which was discovered about 30 years ago, is believed to be the richest individual gold mine ever found, having produced over \$70,000,000 worth of gold to date, besides copper. In its early stage, the ore, which carried hundreds of ounces to the ton, was crushed with stamps and amalgamated, but the recovery was not especially good. Subsequently, and until seven years ago, all the ore was dry-crushed in ball-mills, roasted, and leached with chlorine solution in open brick vats and the gold precipitated on charcoal. At that time the copper content of the ore was negligible. This is one of the few large gold mines in the world that never had a cyanide plant.

About eight years ago, a large body of rather silicious cupriferous sulphide ore was found in the mine. Blast-furnaces were erected, and the less silicious ore, which contained about \$10 gold, 4% copper, and 45% silica, was, and still is, being smelted. The more silicious or so-called 'mundie' ore, carrying about \$15 gold and 1% copper, was then dry-crushed, roasted, leached with sulphuric acid, the copper being precipitated on scrap-iron, subsequently leached in the same vats with chlorine solution, and gold precipitated as before mentioned. About 18 months ago the gold content of this 'mundie' ore began to decrease, and the copper content to increase. For this and other reasons it was deemed advisable to cease this method of treatment, and the last of the chlorination works was shut down.

It now became necessary to find a profitable method of handling this class of ore. As iron-bearing flux has to be brought a long distance, and as the ore carries about 70% of insoluble, smelting would be too expensive. There is believed to be at least 2,500,000 tons* of this class of ore in the mine, assaying roughly \$6 gold and 2% copper. This is in addition to the so-called 'copper ore' which is being smelted. It may be explained that there is no 'carbonate zone' in this mine. All the copper is in the form of chalcopyrite. The gold is very fine.

MINERALS SEPARATION EXPERIMENTS

A few years ago some experiments were made by crushing in

*The long ton, 2240 lb., is used throughout this article.

ball-mills and concentrating on Wilfley tables, but they were not successful. Last year it was decided to make a thorough trial of the Minerals Separation process, and a small testing plant was erected in the laboratory. At the same time a full-sized experimental unit, capable of treating 300 to 400 tons per 24 hours, was erected in one of the abandoned chlorination plants. Both sets of experiments were carried out by the metallurgical staff of the Company. After they were finished, a representative of the Australian branch of Minerals Separation, Ltd., paid a visit to the mine and conducted a few tests, which confirmed the results obtained by the mine staff.

As mentioned in the Company's annual report, these flotation experiments were successful, the extraction being higher and the costs lower than expected. The company is now building the first unit of a plant to treat 1000 tons per 24 hours. The ore will be crushed by rock-breakers, Symons disc crushers, rolls, and tube-mills. It will then be concentrated on Wilfley tables, after which it will go through a second set of tube-mills, thence to the flotation machines. It is presumed that no royalty will be payable on the Wilfley concentrate. This concentrate will either be briquetted or sintered in a Dwight-Lloyd machine, and smelted in blast-furnaces along with the 'copper ore' and ironstone and limestone fluxes. The Company has no reverberating furnaces.

APPLICATION OF FLOTATION TO GOLD ORE

A flotation plant is being erected at the Falcon mine, Rhodesia, to treat ore containing gold and copper. With the exception of the Mt. Morgan, the Etheridge, and the Great Fitzroy mines, Queensland, I have not heard of the flotation process being used successfully to treat ore containing an appreciable amount of gold. The Elmore thick oil process was installed at the Lake View Consols gold mine, Kalgoorlie, several years ago, but was not successful, as the ore was not suitable, and unsuccessful experiments were made by Minerals Separation, Ltd., on ore from the Lancefield mine, Western Australia, which contains mispickel. The Elmore vacuum process was installed at the Cobar gold mines, New South Wales, and at the New Ravenswood gold mines, Queensland. Both these mines contain copper in the form of sulphide, as well as gold, but the plants only ran a few weeks. I was informed that the plant at the former mine (where the ore contains about $\frac{1}{8}$ gold and 1.5% copper) gave a fair recovery of copper, but left too much gold in the tailing or left enough copper in the tailing to prevent profitable cyanidation of the gold.

To return to the Mt. Morgan mine, the laboratory apparatus had a capacity of one pound of ore at a time, and the results now being obtained in the experimental mill approximate closely those obtained in the laboratory. The object of concentration was, of course, to obtain a concentrate containing as much gold, copper, and iron, and as little silica as possible, commensurate with a good extraction of the gold, because it was found that the less silica the concentrate contained the poorer was the extraction of gold. It costs 13 cents to flux one unit of silica, and it was necessary to steer a middle course. Experiments made with Sonstadt solution on ore from one part of the mine showed that clean quartz (after separation by specific gravity from all mineral) contained not less than \$1.50 gold per ton. In practice, of course, it is impossible to float all the mineral and sink all the gangue.

The agitator in the laboratory plant was at first run at 1100 r.p.m., but was afterward reduced to 800. Tests were made with pulps of different proportions, each separate pulp being agitated for the same length of time, that is, 6 minutes, and it was found that there was not much difference, in the extraction of gold and copper, between a pulp containing three parts solution to one of ore, and a pulp containing seven parts solution to one of ore. A pulp of 1 to 1 was too thick and gave poor results. In practice, the thinner the pulp the smaller the capacity of the flotation machine. Tests were also made to ascertain the effect of agitating for different lengths of time. Two tests were made in the laboratory of which I have a note: one for 10 minutes and one for 15 minutes. The ore contained \$6.50 gold and 2% copper; 12% of this sample would remain on a 60-mesh screen. The first one gave a concentrate containing \$22.70, 9.4% copper, and 18% insoluble, with an extraction of 51% of the gold and 84.5% of copper. The second gave a concentrate containing \$20.20 gold, 7.8% copper, and 27% insoluble, with an extraction of 64.5% of gold and 91.8% copper. The gold left in the tailing was probably in the gangue, as the extraction was poorer than usual. As a rule, the longer agitation and separation are continued, the more silicious the concentrate is. In practice, the length of treatment is regulated by the thickness of pulp and the number of boxes in the flotation machine. Tests made to ascertain to what degree fine crushing was necessary showed emphatically that the ore must all pass through a screen of 60 holes to the linear inch if a good extraction is to be obtained, and that the finer it was crushed, at any rate down to 120-mesh, the better the extraction

was. Tests showed that when using eucalyptus oil there was no advantage in using an acid solution, but that, on the other hand, slight acidity did no harm. Much of the copper pyrite in the ore readily floats on water without any previous agitation. On treating ore containing \$25 gold direct by agitation and flotation, without amalgamating or concentrating on tables, it was proved that fine free gold can be floated by using eucalyptus oil.

USE OF ESSENTIAL OILS

Many oils were tested, and, generally speaking, it was found that only essential oils gave a coherent froth and good extraction, other oils like petroleum, oleic acid, and lubricating oils tending to form granules which sank. The best results were obtained from eucalyptus, closely followed by 'Essential C' and *Pinus laurus vulgaris*. Oleic acid, which was used for years at Broken Hill on zinc ore with hot solution, and gave good results when tried on this ore with neutral and acid solutions, gave an enormous froth and floated most of the silica. A mixture containing 95% of eucalyptus and only 5% of oleic acid gave a concentrate containing 47% silica, showing the power of the oleic to float silica. Experiments were afterward made with a mixture of oils, and one combination (known as Mt. Morgan mixture) was found to give a better extraction of both gold and copper than any of the individual oils, and at less expense. When the sample was all crushed to pass 80 mesh, an extraction of 80% of the gold and 90% of the copper could be obtained every time, with a concentrate containing about 25% insoluble, which can be reduced to 10% by re-treatment. Hot solutions and a solution containing 1% of common salt were found to be detrimental to good recoveries.

RECOVERY BY FLOTATION

A test on a sample, crushed to pass a screen of 120 holes per linear inch, containing \$37 gold and 4.8% copper, gave a recovery by flotation alone of 90% of the gold and 98.5% of the copper, but left \$8 gold in the tailing. The concentrate carried 44% insoluble matter, which could be reduced by re-treatment. A different oil (eucalyptus) would have given a poorer recovery and a cleaner concentrate.

Tests made on ore containing \$9 gold, 3.5% copper, and 45% insoluble, showed that after crushing to pass 60 mesh and treating by direct flotation, an extraction of 82% of the gold and 96% of

the copper could be obtained, with a concentrate containing only 21% insoluble. No doubt with finer crushing even better recoveries would be had. These results leave tables and vanners far behind. It was found decidedly advantageous to re-use the solutions.

A Wilfley table was erected in the mill, some tests made, and the tailing treated by flotation in the laboratory. Sometimes these tailing samples were dried before flotation, and sometimes they were not. It was invariably found that a better extraction was obtained from those which had not been dried, as no matter how carefully the operation was conducted, some of the iron pyrite got sufficiently oxidized to resist flotation, and it carried some of the gold.

In some of the tests the crushed ore was concentrated by panning in the laboratory, and afterward subjected to flotation. In this case the water in the laboratory was used, which did not come from the same source as the water used in the mill. It was noticed that the longer the sample was allowed to remain in the water after panning, the worse the subsequent flotation was. For example, where flotation took place immediately after vanning, the residue assayed \$2.60 gold and 0.30% copper, but where tailing from panning was allowed to remain under water for 6 hours before flotation, the residue assayed \$3.10 gold and 0.67% copper. An analysis of this water was made, and this incident shows what might happen in a mill where the ore is in contact with bad water for some hours before reaching the flotation machine, such as the time it is going through rolls, Chilean mills, tube-mills, and classifiers, over tables and through thickening devices, and perhaps through secondary tube-mills. The water in question was neutral, both before and after coming in contact with the ore.

Some tests were made both in mill and laboratory in which air was drawn into the agitation boxes through pipes fixed vertically in the corner with the top open to the air and the bottom ending in a bent pipe terminating under the impeller of the agitator. No improvement was, however, noticeable.

Grading tests were conducted on crude ore and flotation products. They showed that as regards crude ore, after crushing either in mill or laboratory, the finest grade of concentrate or ore was the richest and the coarsest grade of tailing was richest, both in gold and copper. The fact that the finest grade of tailing was the poorest shows that this process will float the finest sulphides successfully.

CRUSHING PLANT

In the experimental mill the ore is crushed in rock-breakers and

Krupp dry-crushing ball-mills without drying. This plant was formerly used to crush oxidized ore for chlorination and, being on the spot, it was naturally utilized in preference to buying new machinery. The crushed ore drops into a bin at the bottom of which are two Challenge feeders. These deliver the ore into a launder where it is met by a stream of water which carries it direct to a six-compartment Minerals Separation machine. Each spindle is driven by a half-crossed belt, thus eliminating the noise and grease incidental to the old Broken Hill method of gearing. The machine is of the Hoover single-level type, by which one man can attend to all the flotation boxes. The concentrate was collected at first in circular wooden vats with filter-bottoms of cocoa matting, and later in shallow rectangular concrete tanks which formed part of the old chlorination works. The whole plant is extremely simple and requires very few men to run it. It has not been found practicable to use a screen finer than 35 mesh on the ball-mills. It is found that the gold, copper, and iron contents are greater in the concentrate overflowing from No. 1 box and that they gradually decrease until No. 6 is reached, while the silica content increases from 10% in the concentrate from No. 1 box to about 50% in that from No. 6. About 56 hp. is required to drive the agitators at 350 revolutions per minute.

As it is intended to use Wilfley tables in the new mill to assist in recovering the iron pyrite in the ore for fluxing and other purposes, two of these machines were placed in the experimental mill and some tests made to find out what results may be expected of them. Taking an average of several tests on ore from different parts of the mine, the grading of the 'table feed' was as follows: 10% remained on 60 mesh, and 19% passed through 60 but remained on 120 mesh. It contained \$4.50 gold, 1.8% copper, 9% iron, and 76% insoluble. The concentrate assayed \$17 gold, 2.9% copper, 34% iron, and 18% insoluble; the recoveries were 33% of the gold, 13% of the copper, and 38% of the iron. No doubt, had the pulp been classified and the fine material passed over slime tables or vanners, better results would have been obtained, but the Company does not intend to use mechanical concentrators for the slime, preferring to rely on the flotation process, so it was not worth while experimenting with them.

During the flotation experiments with eucalyptus oils some tailing was produced which contained a fair amount of gold, and attempts were made to recover some of this by amalgamating and cyaniding.

It was found that no extraction by amalgamation was possible, nor was any extraction by cyaniding possible without either roasting or finer grinding. On unroasted tailing assaying \$3 gold and 0.44% copper, after crushing to pass 120 mesh, separating the slime, and leaching the sand for 9 days, an extraction of only 60c. per ton was obtained with a consumption of 3.6 lb. of cyanide per ton. On a different tailing crushed to pass 80 mesh, which after slime was separated assayed \$2.90 gold and 0.30% copper, an extraction of \$1 was obtained in 5 days with a consumption of 2 lb. of cyanide.

Samples of slime were treated by agitation and washed by decantation, and gave slightly better extractions, but the consumption of cyanide went up to 6 or 7 lb. The strength of solution used in these tests was 0.10% KCN. It should perhaps be noted that all samples of flotation tailing had been dried before being tested by cyanidation.

EFFECT OF ROASTING

Two samples of sand from tailing were roasted and treated by percolation. The value was \$3. The roasting reduced the sulphur to 0.5%. Although the copper and iron were oxidized by roasting, the consumption of KCN was less than in treating the unroasted tailing, which was contrary to expectation. With three days treatment, the residue was reduced to \$1 per ton, and about one-third pound of copper was dissolved from each ton of tailing by the cyanide. The consumption of cyanide was 1.4 lb. per ton, so that the extraction was higher and the loss of cyanide less than in treating unroasted tailing. Speaking from memory, I think that attempts to regenerate the cyanide in solution by means of sulphuric acid and lime were not very successful. The solution contained 0.05 gram copper per litre.

These cyaniding tests were merely done for information, as it is not expected that the tailing from the new mill will be profitable for cyaniding. The subject of extracting gold from flotation tailing arose a few years ago at the Cobar gold mines, as already mentioned, but in that case the difficulty was overcome by selling the mine, which contained highly silicious ore, to a company which owned a smelter, and had, or thought it had, plenty of basic ore for flux. Unfortunately, the amount had been overestimated and the problem is still unsolved—but that is another story.

OILS USED IN THE FLOTATION PROCESS

By AN OCCASIONAL CONTRIBUTOR

(From the *Mining and Scientific Press* of May 1, 1915)

INTRODUCTORY.—The work of the past two years at many mills in the United States, Mexico, and South America, has done much to prove the suitability of flotation processes to the recovery of the sulphide ores of copper, and to indicate the best reagents. In a general way, it may be said that oils of mineral origin, such as coal-tar and fuel-oil, give better results on copper ores, while oils of vegetal origin, such as the terpenes, pinenes, wood-tars, etc., are better adapted for the treatment of zinc and lead ores.

COAL-TAR PRODUCTS.—Among these cresylic and carboic acids are the best known reagents. Commercial cresylic acid is an oily refractive liquid, generally with a red or yellow tinge, has a specific gravity of about 1.044, and consists of approximately 40% meta-cresylic, 35% ortho-cresylic, and 25% para-cresylic acids, the properties of these three isomers being, according to Lunge and Keane:¹

Acid.	B.P.	Solubility in 100 parts water, ordinary temperature.
Ortho-cresylic	191°	2.50 vol.
Meta-cresylic	203°	0.53 "
Para-cresylic	202°	1.80 "

This acid is much less soluble in water than its homologue, carboic acid, and is still more easily broken down by sulphuric, which probably accounts for the statement that sulphuric acid may not be used along with either of these weaker acids. My own experiments give conflicting results, and I cannot speak with confidence on this point.

I have found a marked difference in the behavior of different brands of cresylic acid, and I suggest that, in conjunction with tests run, the different brands be analyzed to see what bearing the differing amount of the three constituents has on the action of the various acids. I had very poor success in treating a certain chalcocite ore with a dark colored cresylic acid, and on changing over to a light colored brand, I had immediately surprisingly good results.

Lunge and Keane give a method (Rascheg's) for the estimation of the three isomers of cresylic acid. For the benefit of those who may not have access to this book, I give it in full:

¹ *Technical Methods of Chemical Analysis*, 1911.

On treating *m*-cresol with excess of HNO_3 , at 100° it is quantitatively converted into trinitrocresol, while its isomers are completely oxidized to oxalic acid. The following directions, which must be most carefully observed, give reliable results: Exactly 10 grammes of the cresol mixture are weighed into a small conical flask mixed with 15 c.c. ordinary H_2SO_4 (1.84), then treated for 1 hour in a steam-oven, and the contents poured into a wide-necked flask of 1 litre capacity. The flask is cooled under the tap, shaking it round meanwhile in such a manner that the sulphonic acid, which is a mobile liquid while hot, settles as a thick syrup on the sides of the flask during cooling. 90 c.c. of HNO_3 (1.38) are then first poured into the small flask in which the sulphonation was conducted, in order to remove any sulphonic acid adhering to its sides, r'ed well round, and then poured, all at once, into the larger flask. The contents of the latter are well shaken immediately, so that all the sulphonic acid is dissolved, which takes about 20 seconds. The flask is then placed in a draught-cupboard. After one minute a violent reaction occurs, red fumes are evolved, and the liquid boils; then it suddenly becomes turbid; oily drops of trinitrocresol form and collect on the bottom of the flask; and after five minutes the reaction is apparently ended. The whole is allowed to stand for at least another five minutes, then poured into a dish containing 40 c.c. water and the flask rinsed out with a further 40 c.c. water into the same dish. On mixing with water the trinitro-*m*-cresol solidifies with liberation of nitrous fumes to a crystalline magma. It is allowed to stand for at least two hours while the liquid cools; then it is crushed with a pestle, and filtered on the pump through a filter that has been tared against another one. The crystals of trinitrocresol are washed with 10 c.c. H_2O , dried at 95 to 100° and weighed. If these instructions are carefully followed, 1.74 gm. of trinitro-*m*-cresol are obtained for each gramme of meta-cresol present in the mixture whatever the composition of the latter. The presence of even 10% phenol does not diminish the accuracy, as the picric acid that is formed remains in solution, but the method must not be applied to mixtures containing large amounts of phenol. This, however, does not often occur in practice. In such samples the presence of phenol is detected by the B.P. and also by the fact that the nitro compound does not remain solid in the steam-oven at 95 to 100° , but melts, or, at any rate, forms a soft paste. But a cresol that distils for the most part between 190 and 200° and, therefore, contains scarcely any phenol, always yields a pale yellow crystalline mass, the weight of which divided by 1.74 gives the weight to within

1% of the *m*-cresol in the mixture. It may be well to repeat that not less than 90 c.c. of HNO_3 is used, and poured all at once into the flask as quickly as possible, a flask having a very wide neck being used.

To determine all three isomers Rascheg separates the *o*-cresol completely by repeated fractional distillation; the distillates being composed roughly of 60% *m*- and 40% *p*-cresol in which the *m*-cresol is determined as above. This operation, however, is entirely beyond the skill and resource of the average chemist. It is rendered unnecessary from the fact that the three acids mentioned bear a fairly constant ratio, as before stated, in any commercial cresylic acid; from the percentage of meta-cresylic acid formed, the others may be calculated. These three acids can be obtained in a pure state. I suggest a trial of them on a small scale, and I venture the opinion here that the ortho-cresylic acid is the one that does the work.

Cresylic acid should be handled carefully, as it gives rise to painful skin-wounds, and may easily splash into the operator's eyes. It is well to keep a bottle of olive-oil handy as a remedy.

COAL-TAR CRESOLS.—Cresylic acid is an expensive reagent, cost at least \$1.25 per gallon delivered at Western American mills in peace-time. It comes principally from Germany and England. A search for a cheaper substitute has shown that crude coal-tar creosote, which is a by-product of gas-works, blast-furnaces, and gas-producers, is promising. Samples from different sources vary greatly in liquidity and chemical composition (proportion of phenols and cresols present); they well merit investigation. Being generally viscous they emulsify imperfectly, especially in the cold, and while some solvent like pine-oil or cresylic acid can be employed, such solvents are expensive and tend to mask the effect of the original reagent. It is probable that the employment of the more liquid blast-furnace creosotes, with preliminary heating, would be attended with good results.

Carbolic acid (phenol) is a homologue of cresylic acid. It is difficult to distinguish between them, the smell and color being so much alike. Carbolic acid has a solubility varying from 4.83% at 11° to 11.83% at 77° in 100 parts of water. It is easily broken down by sulphuric acid, yielding oxalic acid. It appears to be much less selective than cresylic acid in its action on metallic sulphides, and a slight excess brings over a concentrate high in insoluble matter.

FUEL-OILS.—My investigations cover Mexican, Texan, and Californian crude oils. From the known difference in composition, it is not surprising that on any particular ore the results are widely different. The metallurgist should have samples of all three on hand when

running tests. Fuel-oils are not highly selective like cresylic acid, pine oils, etc., but are strongly emulsive; they serve the purpose of giving body and mineral-carrying power to the relatively weak but more selective froths; they are cheap, quickly obtainable, and, when used in moderation, bring over little gangue. It is well to increase their fluidity by steam-jacketting the container from which they are fed to mixing-compartments.

Gas Oil (stove-oil).—This is one of the distillation products of crude oil. It is a strong emulsifying agent, which is, at times, most useful. It is worth a trial in running tests. It must be used in very small quantities.

Crude Wood Turpentine.—This is not the ordinary spirits of turpentine. It is a dark reddish-brown liquid with a pungent smell. On gravity-flow machines I have found it of little use, as its action in slight excess is to bring over gangue freely. As an emulsifier, I much prefer fuel-oil or tar-oil. On machines through which the flow of pulp is maintained by mechanical means, it has been found a valuable reagent for the purpose of controlling the levels of pulp, through its physical action on froths, but this result is achieved at the expense of impure concentrate, unless the agent is used in the strictest moderation.

PINE-OILS, WOOD-TAR OILS, FIR-OILS, WOOD-CREOSOTES, ETC.—The destructive distillation of soft woods yields a large number of products, and possible reagents. I have found the oils derived from pine and fir to be more selective on chalcopyrite than on chalcocite ores. Wood-tars and tar-oils are excellent emulsifiers, but it appears that the series in general gives better results on zinc and lead than on copper sulphides. I have found pine-oil used in conjunction with crude sulphuric acid to give excellent recoveries on weathered chalcopyrite ores where cresylic acid had been a complete failure. There may be some significance in the fact that the action of sulphuric acid on terpenes (turpene-oils) and phellandrenes (crude eucalyptus-oils) is to give in both cases dipentenes and terpinenes.² I mention this, as eucalyptus-oils, which are prohibitive in cost in America, are, I understand, universally used in conjunction with sulphuric acid on zinc and lead ores in Australia.

APPLICABILITY OF THE PROCESS.—T. J. Hoover in the latest edition of his book on flotation³ repeats the statement made in the first edition, that there is a doubt if chalcocite can be recovered success-

²'Thorpe's Dictionary of Applied Chemistry,' 1913.

³'Concentrating Ores by Flotation,' 1912.

fully by flotation. This surely is an oversight; no one is more cognizant than Mr. Hoover of the recent work done in flotation, and I have only here to refer to the very high recoveries that have been made on a working scale on chalcocite ores, in Arizona, at several large mills.

Cuprite is considered a difficult mineral to recover by flotation. In the case of one ore that has come under my notice, in which the cuprite occurred as a subsidiary mineral, the saving amounted to a small percentage only, certainly not as much as an efficient slime-table would have recovered. On the silicate and carbonate ores there is probably no appreciable recovery.

MECHANICAL SIDE OF THE PROCESS.—In my opinion, the development of what may be termed pneumatic-flotation processes by Callow, Flynn, Towne, and others, constitutes the most distinct advance of recent years. They consist of a directly and cheaply applied supply of air-bubbles in a finely divided state, to assist in bringing to the surface of the pulp the already prepared sulphides. The agitation is cheaply and easily performed, and is quite subsidiary to the action of aeration discussed above. I have found a shallow trough-agitator, with beaters only partly submerged, quite sufficient. The introduction of a jet of live steam into the mixing compartment is an advantage. The pulp may flow through the mixing and aeration compartments by gravity at the expense of a trifling loss of head-room. This loss is more than compensated by decreased power and labor costs, and simplicity of working. Finely divided air-bubbles can be directly and perfectly applied through many forms of porous media such as canvas, corundum stones, silica-tiles, sandstone slabs, etc. The mineral particles are seized upon and at once removed as concentrate, without having to be repeatedly subjected to a sort of 'fractional distillation' as in the older systems. It is, in a way, the converse of Elmore's vacuum process, and has the merit of being positive in action and under perfect control. Remarkable results have been shown in the economy of reagents, power, and labor; also in the ease with which such machines can be started after any of these sudden stops incidental to milling operations.

FLOTATION OF COPPER ORES

(From the *Mining and Scientific Press* of May 29, 1915)

The Editor:

Sir—The mention of my name in your recent article on this subject tempts me to offer a few remarks that may be of general interest.

Pneumatic flotation is already fully established in a number of places and the results in comparison with the other and older schemes fully justify the opinion of your correspondent that it constitutes the most distinct advance in flotation in recent years.

The first pneumatic-flotation plant in this country was erected by me in February 1914 for the National Copper Company at Mullan, Idaho, a description of which has already been published. The results were fully up to expectations from the very start. This plant consists of 8 rougher and 2 cleaner cells and treated 500 tons per 24 hours. A 30-hp. motor furnished power for all the air necessary for both mixing and separating, and the oil consumption averaged as low as 0.13 lb. of refined pine-oil per ton of ore. It was an ideal floating ore. Since then the Callow scheme has been adopted by nearly all the other mills in the Coeur d'Alene for the treatment of their lead-zinc fine sand and slime-feed, and has been a means of simplifying their plants and adding greatly to their recoveries.

The other plants that I have since erected have followed the same general lines as were laid down at the National, namely, air or tube-mill mixing and emulsifying of the feed followed by the separatory cells run in parallel. Recent results at the Inspiration mine would indicate some advantage (on that ore, at least) in running the cells in series of two instead of parallel, and without any sacrifice in capacity for a certain set number of cells. On an ore carrying a large percentage of mineral there is not much doubt that the series plan will give the best results and possibly dispense with the necessity for cleaning the concentrate.

The various elements that compose the scheme in general are illustrated in the accompanying diagram. The preparation of the pulp by any form of violent or propeller agitation is not necessary for good results with the pneumatic process. Where the oil can be introduced into the tube-mill no further refinement in mixing is necessary. This, of course, cannot always be done and in such cases air-mixing with the Pachuca becomes necessary.

A standard separatory cell has a capacity that will vary from

35 to 75 tons of feed per 24 hours when run in parallel, depending of course upon the characteristics of the feed. Two cells in parallel will have about the same capacity as two cells in series, but a slightly lower tailing may be expected with the series treatment.

The porous medium in the bottom of the cell is a loosely woven canvas-twill four layers thick, secured to the upper surface of a perforated plate with bifurcated rivets and washers. This is the present standard construction and has been adopted after a great many disappointing experiments with other materials. It is good for a three or four months' continuous campaign, and becomes inoperative only through the filling up of the pores by dust that has been introduced by way of the blower. Four or five pounds of air-pressure is ample in all cases to give the proper aeration, the quantity of air varying from 6 to 10 cu. ft. per square foot of blanket-surface. When the cell is properly adjusted and doing its best work there should be no violent agitation with the cell, but only such agitation as is incident to proper aeration. Any violent agitation producing a surging of the liquid contents has proved detrimental to good results.

A slope of 3 in. per foot on the bottom has been found sufficient to treat all ordinary ores after crushing through 30 or 40-mesh. Treating coarser material or ores that contain a large percentage of heavy gangue (such as in the Cœur d'Alene), it has been found advantageous to increase this to as much as $4\frac{1}{2}$ in. per foot to prevent the blanketing of the porous medium by coarse sand collecting on the bottom.

The air from the separatory cells has so far been furnished from positive blowers, but turbine-blowers would be preferable where the size of the installation justifies their adoption. An air-pressure of 15 lb. is ample for the Pachner mixer and 25 cu. ft. of free air per minute is sufficient volume for mixing 250 tons of minus 48-mesh pulp, and of course should be furnished from a low-pressure compressor.

The density of the pulp may vary from $2\frac{1}{2} : 1$ on a sandy feed up to $7 : 1$ on a strictly slime-feed. The particular density is not a matter of so much importance as that the supply of pulp shall be uniform as to its density, since each variation in the density requires a readjustment of the oil-supply, the quantity of oil required increasing in proportion to the increased volume of the pulp independent of its solid content.

The advantages of the pneumatic scheme are greater recoveries,

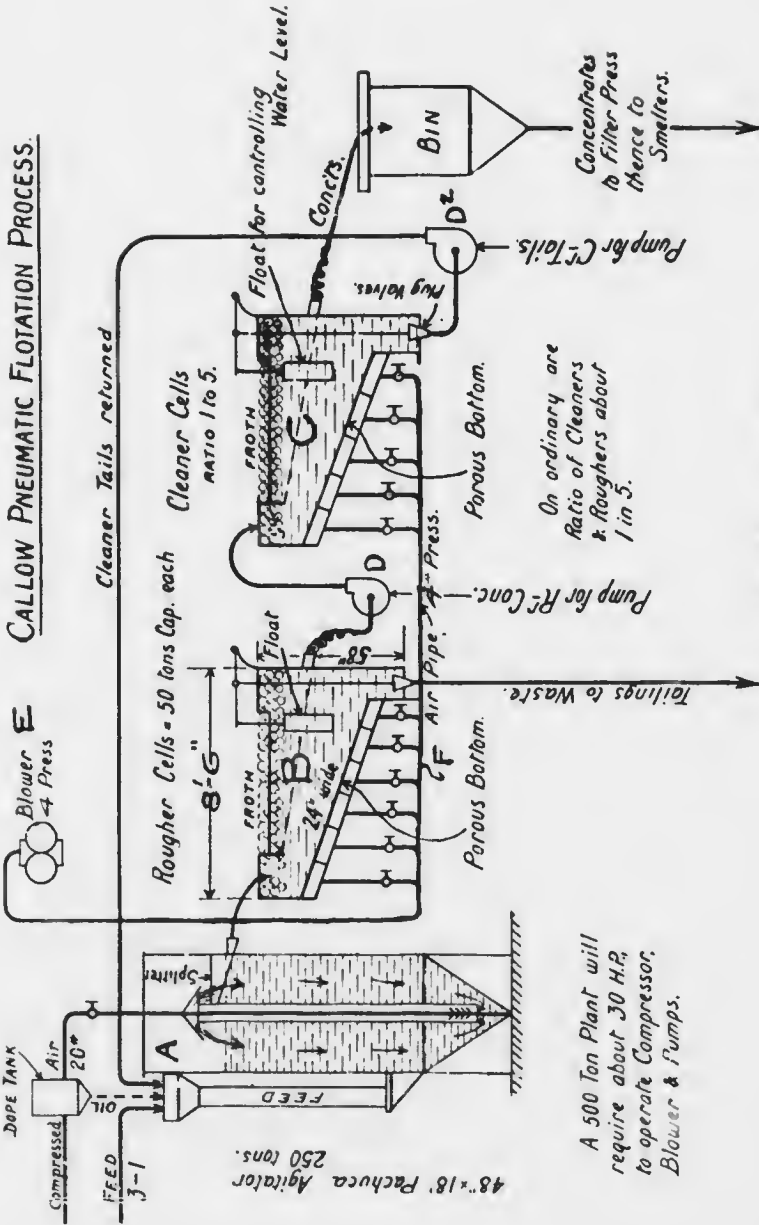

FIG. 15. (NO SCALE)

less oil, greater simplicity, and less skill required to operate. The difference in wear and tear is obvious.

Proof of the increased recoveries is shown in Table I, which represents a 30-day competition. It is noticeable that this increase in recovery lies principally in the finer and slime portions of the feed.

TABLE I
ANALYSIS OF TAILING—THIRTY-DAY PERIOD

Mesh,	Weight, %	Total copper, Flotation tailing,		Table tailing,		Copper oxide in combined tailings.
		A.P.	P.P.	A.P.	P.P.	
		%	%	%	%	%
+ 65	7.0	0.38	0.37	0.30	0.29	0.13
- 100	15.0	0.43	0.44	0.29	0.24	0.13
- 150	12.0	0.44	0.50	0.30	0.25	0.16
+ 200	9.8	0.54	0.44	0.34	0.26	0.22
- 200	56.2	0.58	0.42	0.56	0.43	0.33
Average, all sizes, 100.0		0.44	0.35	...

TABLE II
ANALYSIS OF CONCENTRATES

	For the same period			
	Cu, %	Insol., %	Fe, %	S, %
Agitating process	32.34	26.50	15.01	22.79
Pneumatic process	31.24	23.70	16.79	23.84

The resulting concentrates from the same competition are shown in Table II, which indicates that the slightly lower grade of copper is more than offset by the lower insoluble and higher iron contents.

The proof of lower power-consumption is that the 10 cells of the National Copper Co. were run with a 30-hp. motor and treated 500 tons per day; the same tonnage treated by a propeller machine would have taken close on to 100 hp. This figure has also been confirmed at other places. The power required will vary from 2 to 3 kw.-hours per ton.

The froth produced from the pneumatic process is much more ephemeral than that produced by propeller-agitation machines, a self-evident advantage when it comes to collecting and handling the resulting concentrates.

Regarding oils the remarks of your contributor with regard to cresylic acid and the methods of analysis given are extremely interesting and valuable. So far as my own experience goes, I have

not found cresylic acid indispensable; at the present time and price it is out of the question as a flotation agent; it would seem, moreover, that the same results can be obtained by the use of less refined and expensive reagents. In the Coeur d'Alene on the zinc-lead ores, wood creosote seems to give the best results. The Inspiration uses a mixture of 80% El Paso coal-tar and 20% creosote. At one time we used a 2½ to 5% addition of pine-oil, but this has since been found unnecessary. A mixture of 20% pine-oil, 20% cresol, and 60% carbolic was tried experimentally at the Miami mine, but just as good results were obtained by substituting Salt Lake creosote for the cresol and carbolic. These are both chalcocite ores with some pyrite; the chalcocite is easier to float than the pyrite. The pulp is neutral. The recoveries will approximate 95% of the sulphide-copper contents.

I have tried a great many of the wood-oils, both the steam-distilled refined products and also the destructively distilled crude tars and creosotes, but have generally come back to the coal-tar mixtures. The pine-tar products are excellent frothers but the coal-tar products seem to act as collectors, and a combination of the two is often necessary. Acid sludge has been used with good success on Butte copper ores, but the disadvantages of this are that it requires heat and also additional quantities of acid to get the best results. This means working with an acid pulp and prevents the introduction of the oil into the crushing plant because of the destructive effect of the acid on anything but a siliceous-lined mill. Some ores work best in an alkaline pulp and others in a neutral one. My own opinion is that in most cases the same results can be obtained in alkaline or neutral pulp as can be obtained in an acid one and the advantage of an alkaline or neutral pulp is self-evident.

In one plant we had an interesting experience of this kind. The water-supply was limited and all the milling-water was returned back to the mill. The flotation results gradually deteriorated as the mill-water accumulated acid; the more acid it got, the poorer the results. Lime was then added in the tube-mill and the pulp made alkaline; this produced a tremendous increase in the volume of froth made, but without any definite improvement in the tailing. By reducing the lime and allowing the pulp to work back to the neutral point the results again became normal; and it is at the neutral point that we now do our best work.

There is a great deal of work yet to be done with oils, especially in compounding, modifying, and in making them miscible without

heat. The right combination of oil is everything; the quantity per ton has less influence on the results than the right mixture. The effect with too much oil is mechanical rather than metallurgical; too much oil produces so much froth that it overflows everything and cannot be handled in the plant. Some experiments made in this direction gave the following results:

Oil per ton, lb.	Grade of concentrate, %	Extraction, %
2	15.55	90.08
30	9.82	95.91
100	7.95	93.46

But this is a large subject and altogether beyond the scope of these random remarks.

J. M. CALLOW.

Salt Lake City, April 23.

PREFERENTIAL FLOTATION

By O. C. RALSTON

(From the *Mining and Scientific Press* of June 26, 1915)

*INTRODUCTION. 'Preferential' flotation is a specialized application of the flotative principle in the separation of minerals from their ores. It gained its first wide use as a name for certain methods of floating minerals in connection with the Horwood process mentioned below. 'Selective' flotation has come to mean (by common consent) the flotation of valuable minerals (generally the metal sulphides) in the presence of undesirable gangue-minerals. 'Preferential' flotation is the flotation of one of the ordinary selectively flotative minerals in the presence of another similar mineral. Thus, a mixture of galena and sphalerite can be floated 'selectively' from a gangue of granite, limestone, or other common gangue-material, while galena may be floated 'preferentially' from a mixture of galena and sphalerite.

On account of the great interest manifested in this subject of late, I have thought that the following review of proposed or operating processes might be of interest. This review is largely a compilation of patent literature, but it might be well to call attention to the fact that, at present, patent literature is one of the best sources of information on the subject of flotation for one who does not have the opportunity to visit at first-hand the localities where the practice of flotation is being used or tested.

CATTERMOLE. In 1904 Cattermole (U. S. Patent 763,259) made one of the earliest proposals for the preferential flotation of minerals. The method, as he described it, was not exactly a flotation method, but it involved most of the underlying principles of flotation, and hence is of interest in this connection. As stated by Cattermole: "The invention relates to the classification of the metalliferous constituents of ores which have been separated from gangue by oil or similar matter." and "consists in fractionally removing the different constituents from the agglomerated masses by freeing the constituents in turn from oil, and thus obtaining them in a separable condition by the use of emulsifying agents of varying strength and activity, preferably in conjunction with an alkali." "In carrying out the

*Contributed by the Department of Metallurgical Research, University of Utah. D. A. Lyon, metallurgist in charge; O. C. Ralston, assistant metallurgist. Published by permission of the Director of the U. S. Bureau of Mines.

process, the metalliferous matter agglomerated by oil is mixed and agitated with a solution of an emulsifying agent, such as a soluble soap-alkaline oleate, for example, to which a certain proportion of soluble alkali, preferably caustic potash or soda, has been added." "It is found that the minerals vary in their affinity for oil employed in the above manner, and thus by treating the oily masses or granules in the first place with an alkaline emulsifying solution of a certain strength, the mineral of least affinity can be separated therefrom, and by increasing the strength or modifying the proportions of the breaking down solution step by step, the various constituents can be thrown out in the order of their increasing affinity."

Cattermole's patent came at a time when the process was truly 'oil flotation,' as the use of small amounts of oil had not been made successful, and the particular method of flotation which he had in mind in this patent was probably that described in one of his other patents, in which the minerals desired were flocculated or granulated by the use of oil in larger amounts than the present methods of flotation, that is, in amounts up to 5% by weight of the ore, and these granules would sink of their own weight in an upward moving current of water, such as that of a classifier, while the unflocculated gangue would rise. He made the wording of his patent, however, broad enough to cover the treatment of products as obtained by true flotation.

As an example of the working of his process he uses an ore consisting of a silicious gangue, zinc-blende, copper pyrite, and galena, which has been treated with an oil for the granulation of the mineral sulphide particles, and the latter separated. The oil is preferably one that is not readily emulsified, such as a hydro-carbon oil, which will give a wide range of strength in the solutions used later in the breaking down of the granules. The compound granules are run into the first agitation apparatus where they are agitated with a solution containing, say, 0.75% alkali, by which the zinc-blende is "dropped out." The remaining granules are passed into the next similar apparatus, in which a solution containing 1.5% soap and 1.5% alkali is used. Here the copper pyrite is freed and only the granules of galena remain. As Cattermole proposed the use of so much oil, it had to be recovered by the use of strong alkali solutions.

The rules for proportioning the solutions took into account the fineness of the ore, the relative proportions of the minerals, their physical condition and chemical composition, also the kind of oil and emulsifying agents used, and the alkali selected. The finer the

ore the more compact and cohesive the granules formed, and hence the stronger the solution required to break them down. With granules largely of galena, which breaks down with difficulty, stronger solutions are necessary than for those consisting mainly of sphalerite. With animal or vegetal oils that emulsify easily the breaking down of the granules will be too rapid for convenience. The heavy residuum oils and the heavy hydro-carbon oils are the best. Oils may be blended advantageously for this purpose. An alkaline solution of the oil used in granulating is best for emulsifying.

Whether or not Cuttermole's process was ever applied is not known to me, but it is not impossible that its principles may be applied to modern flotation froths.

WENTWORTH. Following the U. S. patents in their chronological order, the next is No. 938,732, of 1909, taken out by H. A. Wentworth and assigned to the Huff Electrostatic Separator Co. It "relates to the separation of the ingredients which constitute ore mixtures, and particularly to the separation of sulphide ores from each other." "The process consists in the preliminary treatment of ore mixtures containing several sulphides, which converts some of the sulphides, superficially at least, into metallic compounds which are differentiated in their behavior" with respect to flotation processes as commonly practised. To use the words of a later patentee, the surfaces of such minerals as galena, pyrite, and chalcopyrite are 'deadened' by a very short and slight roast in a roasting-furnace, while the sphalerite is unaffected. Thus the sphalerite can be removed by flotation from such an ore, leaving the other sulphide minerals to be removed by other means. A few minutes heating at a dull-red heat has been found to be sufficient.

This is a type of process that has been tried in Australia under the name of the Horwood. It is further described under that heading in this paper.

RAMAGE. The same idea underlies the next patent, which is No. 949,002, of 1910, taken out by A. S. Ramage and assigned to the Chemical Development Co., a Colorado corporation. "This process has for its object the separation of the valuable minerals from such ores as chalcopyrite, bornite, or erubescite, and mixtures of the same with pyrite, in which ores the copper is in chemical combination with the iron; and also from such ores containing zinc-blende. The method is also applicable to compound ores, such as those of the Cobalt district and other sulph-arsenides." "The principle of the process is founded on the combination of fractional roasting with

chemical floating." Ramage's introduction of the term "fractional roasting" is particularly felicitous, as it more accurately describes the method than does the term "preferential flotation," used by Horwood.

Ramage described the process by the use of three examples, which are decidedly interesting. The first example is of an ore containing iron pyrite and chalcopyrite, with a content of about 5% copper and 30 to 40% sulphur. The ore is roasted at about a red heat long enough to decompose the pyrite slightly and not affect the chalcopyrite. "The burnt ore is then crushed to at least 15 mesh and passed through a solution of acid sulphate of soda and nitric acid (the solution being formed by adding nitric acid to sulphate of soda), which solution is kept near the boiling point. The copper sulphide immediately rises to the top of the bath and can be skimmed off." The copper dissolved in the bath can be recovered in known ways. This method of flotation (hot acid bath) is not new, having been patented by De Bavay, Potter, Delprat, and others. The fractional roasting had been previously patented by Wentworth, and so the only thing that seems new is the combination of methods.

A second example is that of an ore containing pyrite, chalcopyrite, and zinc-blende in quantity. The ore is roasted at a temperature of not over 600° C., so that only the iron pyrite is deadened. The roasted ore is then subjected to the acid sulphate of soda solution for flotation of the unchanged sulphides of zinc and of copper. This product is then roasted at about 700° C. until all of the zinc sulphide is decomposed and the copper sulphide unchanged. This mixture is treated with a solution of dilute sulphuric acid for the dissolution of the zinc, to be recovered from solution by any familiar process, such as electrolysis, the copper sulphides being sent to the copper smelter. There are certainly most interesting facts disclosed in this patent. The great resistance of copper sulphides to the roasting process, as compared with the sulphides of zinc, is something new and will be a most valuable characteristic, if true.

The third example is that of the ores of the Cobalt district, Canada, where cobaltite, niccolite, chalcopyrite, pyrite, and native silver occur. All the sulphide and sulph-arsenide minerals are floated, leaving the silver in the gangue. The sulphides are roasted at about 800° C. and everything is decomposed except the copper sulphide, which can be floated from the calcine. Again we have mention of the almost incredible property of copper sulphides to resist roasting.

The next patent was that of H. A. Wentworth, amplifying on

his former patent in claiming the superficial chemical change of minerals as a method of separating them preferentially by flotation. He had in mind particularly the treatment of the ore with chlorine, which would sink when subjected to a film-flotation process, while others would have their flotative properties enhanced. As an example, a mixture of zinc and iron sulphides, when treated with chlorine gas in a slightly damp state, is so altered that the blende will float on a film-flotation machine much better than before treatment, while the pyrite has a coating formed over its surface, which is much more easily wetted, so that it will sink. Still a further example is the application to the separation of pyrite and chalcopyrite. The latter is attacked much slower than pyrite; hence it can be floated when both are present. A similar behavior of the minerals is observed when they are suspended in water containing dissolved chlorine in the proper concentration, but the best work seems to be done with minerals fed onto one of the film-flotation machines, such as that of H. E. Wood of Denver, although Wentworth gives the design of one of his own in the specification. It is easy to see that with chlorine-water and one of the mechanical frothing methods of flotation the soluble coatings that are formed on the surfaces of the minerals would be simply washed off and the preferential part of the flotation lost. Tests in our laboratory seem to show this. So far as is known to me, this process is not being used.

Howwood. This process of preferential flotation is practically the same as that described under Wentworth and Ramage. It has been worked for some years in Australia and received careful testing by the Zinc Corporation. It depends upon the 'deadening' of galena and pyrite in a short roasting at 300 to 500° C., whereby the galena is coated with lead sulphate and the pyrite with iron oxide, while the sphalerite is unaltered. This allows a separation of the undesirable zinc from the lead-iron-silver product and allows their separate marketing. This process has received more careful attention than any other process, and reference to original articles is best.† According to the data given in some of this literature, it appears that it is possible to take a flotation concentrate containing 36% Zn, 15% Pb, and 22 oz. Ag per ton, and divide it into a zinc product running as high as 50% Zn, 7% Pb, and 15 oz. Ag, and a lead

†T. J. Hoover, 'Concentrating Ores by Flotation'; *Min. & Eng. World*, July 18, 1914, p. 96; *Eng. & Min. Jour.* (1914), 97, p. 1208; *Mining and Scientific Press*, April 18, 1914, p. 657; *Metal. & Chem. Eng.* (1914), No. 12, p. 350 and 592.

product containing 38% Pb, 8% Zn, and 42 oz. Ag per ton. This is of great interest to all producers of 'complex sulphide' ores, as the milling of coarsely crystalline material has presented much difficulty in the past for the reason that some finely divided material (slime) is bound to form in crushing, and while the combined lead and zinc sulphides can be floated nowadays without much difficulty, the mixture is of far less value than the two minerals separated. This is important enough, not to speak of the possibility of treating the microcrystalline sulphide ores and those containing gangue of high specific gravity, such as barite. While flotation has been a boon to the concentration of all sulphide slimes, preferential flotation is much more important for the ores containing undesirable combinations of sulphides. Hence Horwood's work should receive the highest praise.

Another detail, as regards this process, is that 35 lb. of sulphuric acid per ton of ore is necessary and 2 to 3 lb. of oleic acid for the flotation of the unaltered zinc. All of this appeared in Horwood's first patent, No. 1,020,353, of 1912, and he later came out with improvements on the process in patent No. 1,108,440, of 1914. In this later patent he stated that he had found there was a tendency for the silver to follow the zinc, which is undesirable, but that this could be prevented by simply washing away all soluble salts on the concentrate before it was subjected to the deadening roast. This reduces the amount of oxidized zinc formed, and lost by solution in the dilute acid in the mill-water, as well as allowing the silver to become deadened to a greater extent. He also found that the most successful flotation took place with the pulp at a temperature of about 120° F.

It will be seen that the Horwood process has been applied only to concentrates from previous flotation or from other concentration processes. This is the logical place to apply it, as there is no object in leaving a non-flotative galena or other sulphide mixed with gangue, by using the process on crude ore. The same remark applies to many of the other processes. To be sure, there has been some success in the Australian mills as well as in the United States in the treatment of mixed galena-sphalerite concentrates from flotation machines or concentrating tables. As an example, the Timber Butte mill is treating the flotation concentrate of a zinc ore containing some zinc concentrate carrying 53% Zn, 1.5% Pb, and 4% insoluble. However, this method has not always met with the best results, and where the proportions of lead and zinc in ordinary complex

sulphide concentrates are about equal it is quite hard to get two products that are sufficiently pure. Where it can be done, it is certainly more desirable than the more complex fractional roasting and preferential flotation processes of Horwood, Wentworth, and Ramage.

LYSTER. This is another process that has received consideration by the Zinc Corporation for the year or two preceding the European war. Lyster's process is carried on in neutral or alkaline solutions (never acid) of the sulphates, chlorides, or nitrates of calcium, magnesium, sodium, potassium, or of their mixtures, or solutions of manganese, zinc, iron, acid sodium, or sodium-potassium sulphates. Using eucalyptus oil or a similar frothing agent, the agitation of the pulp takes place in centrifugal pumps, throttled to give further agitation, and discharging it to spitzkasten with constricted tops. It is said that a galena froth can be collected carrying 55 to 60% lead and that by sending the tailing to a second machine with further addition of oil, the sphalerite can be floated.

It will be noticed that this, with the possible exception of Wentworth's second patent, is one of the first proposals to give a true 'preferential' flotation to a mixture of sulphides, as the roasting methods above mentioned involve an actual conversion of some of the minerals, so that sulphide surfaces are no longer presented to the oils and air bubbles in the flotation operation. Lyster's process, however, involves the actual flotation of one mineral in preference to another, unless the chemicals used are chemically altering certain of the sulphides so that they cannot float. Anyone who has worked with mixtures of sulphides has doubtless noticed that greater care is necessary in the flotation of zinc sulphide than in floating galena: in fact, galena is one of the most easily floated minerals outside of molybdenite, and zinc sulphide is considerably more difficult. The fact that a froth running so high in lead as the Lyster process is reported to give would also tend to make one suspicious that rather poor flotation conditions are maintained, so that only the most easily floated material (galena), and only the purest of that, is coming up in the first product. This takes place even in the presence of considerable oil, whenever flotation conditions are poor on almost any type of machine, and while the grade of froth that is obtained is high, the extraction is poor on account of the fact that only the best mineral is floating. It is possible that some such combination of results as this has caused the process not to be considered unfavorably.

NUTTER AND LAVERS. Perhaps the most important disclosure of a process for preferential flotation of minerals is contained in the patent specifications taken out by E. H. Nutter and H. Lavers, U. S. Patent No. 1,067,485 of 1913. This patent was assigned to Minerals Separation, Limited, as the patentees are engineers in the employ of that company. The wording of the patent shows more actual contact with flotation work on the part of the patentees than perhaps any other single patent that has been granted. They have observed that while controlling conditions in a flotation plant, the varying of certain of these conditions has been accompanied by changes in the character of the froth coming off their machines, the metals coming off in various ratios to each other at different times, and for definite causes. Thus there is considerable difference in the sizes of the different minerals separated under various conditions. It is no uncommon experience while developing the machinery of a flotation mill to float all of the fine part of the gangue as well as the sulphide minerals. In like manner, the more easily flotative minerals are liable to come off in the first froth that issues from a machine accompanied by the more finely divided portions of the less easily flotative minerals. "This tendency is dependent upon several factors, such as the amount and character of the agitation and aeration, or of each singly, the chemical constitution of the solution employed as mill-water, the degree of dilution, the temperature and the amount and nature of the different frothing agents." "The word aeration is used in this specification to mean the supplying of air or other gas or gases." By sufficiently controlling all of these factors it is possible to obtain effective separation of galena and sphalerite as well as other sulphides and metals. By taking the various froths obtained from subjecting the pulp to varying conditions, and classifying on apparatus such as concentrating tables it is often possible to get good separation of the minerals contained.

One example cited is that of an ore containing sulphides of lead, copper, and zinc. From this can be obtained a froth containing most of the chalcopyrite, and not much of the galena or the sphalerite, by the use of cresylic acid (cresol) without the addition of mineral acid to the pulp. This froth can be re-treated under varying conditions to purify it. To the mill-pulp that has been depleted of its copper can be added sulphuric acid as well as the frothing agent, to obtain the major portion of the lead, and, finally, by the addition of such an oil as oleic, it is possible to float all of the zinc mineral.

as well as any coarse particles of chalcopyrite and galena. The re-treatment of these froths by further flotation, or on tables, makes it possible to get good products of the grade demanded by smelters.

When using an ore containing only copper and zinc sulphides they state that with the use of cresylic acid or eucalyptus oil, without the addition of any mineral acid, it is possible to get a froth containing a portion of the copper minerals, some fine zinc, and some still finer gangue. They also state that if the remaining pulp is acid, the froth obtained will contain an additional amount of more coarse zinc and copper minerals and that the zinc minerals are finer than the copper minerals. If oleic acid is added to clean the tailing, the froth obtained will carry much gangue, but most of the sphalerite and chalcopyrite are very coarse-grained. The treatment of these froths on vanning machines or tables gives the desired products.

Consciously or unconsciously, a number of operators have applied methods more or less like those claimed in this patent. By restricting the amount of oil used, it seems to be possible to float galena in the presence of sphalerite, though the lead product obtained always carries a good deal of zinc, and it is impossible to get all of the lead out before the sphalerite is floated by the addition of further oil. This is practically an application of Lyster's process, except that pure water is used instead of the solutions recommended by him. However, there can be no doubt that the addition of certain substances to the mill-water does help in this type of flotation. In another plant where an ore containing pyrite and chalcopyrite is being treated, the first froth contains most of the chalcopyrite in a finely divided form, while only a small amount of the pyrite, in large pieces, comes to the surface. The property of chalcopyrite to disintegrate into very fine flakes on crushing has bothered millmen in the old days when the production of slime was kept down to a minimum. Now it seems to be an advantage. These two instances of "controlling flotation" conditions are somewhat different from the ones implied in the Nutter and Lavers patent, and it is doubtful if it could be held to cover these cases, at least more than in part. However, too much attention cannot be given to their patent, as it discloses the methods by which preferential flotation will be first developed successfully, as far as I am able to see.

GREENWAY AND LOWRY. A further development of the idea of using a solution of some chemical that will permit true preferential flotation of one mineral in the presence of another flotative mineral

is contained in the patent of H. H. Greenway and A. H. P. Lowry, No. 1,102,738 of 1914. They discovered that "if a salt of chromium (such as sodium bichromate or potassium bichromate) is introduced in solution into the circuit liquors, or if the material to be treated is subjected to the action of such chromium salt solution by digestion or otherwise, the sulphides are affected in such a way as to leave certain of them amenable to flotation, whereby products are obtained relatively high in certain sulphides on the one hand, and relatively high in the other sulphides on the other."

Three examples are cited: (1) A molybdenum ore containing 15% molybdenite and 25% iron pyrite was crushed to pass 100-mesh screen and treated in a froth-flotation apparatus with four times its weight of water containing 0.25% sodium bichromate, and heated to 120° F. One pound of eucalyptus oil per ton of slime was used and the flotation product consisted of 93% MoS_2 and 4.9% iron pyrite. Attention should be called to the fact that this example does not tell as much as it would seem to say, for the reason that molybdenite is one of the most easily floated minerals. I believe that work of a character more nearly comparable with this result could be obtained without the use of chromates.

The second example cited is of a copper ore containing 6.5% copper and 35% iron. This, likewise, was crushed to pass a 100-mesh screen and digested in a hot solution of 1% sodium chromate for about 30 minutes, the liquor decanted and the mineral treated in a flotation machine with one pound of eucalyptus oil per ton of dry slime. The flotation product contained 19% copper and 30.2% iron, while the residue contained 0.7% copper and 36.2% iron. When we remember the case cited above of separating the chalcopyrite from the pyrite by virtue of the fact that fine grinding takes the copper down to a much finer product than it does the iron, we are led to wonder if this process is really necessary for this kind of ore. It may be that a better grade of product and a higher extraction can be obtained by this method than without the addition of bichromate, but otherwise it is doubtless possible in most cases to do the same work with proper control of ordinary conditions.

Their third example is of a lead-zinc slime containing 18.6% lead and 32.3% zinc, which was digested for 30 minutes in a warm solution of 1% sodium bichromate. The solution was decanted and the material subjected to froth-flotation with one pound of eucalyptus oil per ton of slime. The flotation product contained 47.2% zinc and 6% lead, while the residue contained 31.6% lead and 16.3%

zinc. The solution was heated to 120° C. These are interesting figures, but there is too much zinc in the lead concentrate. Here again I feel that the work is not much better than it would be without the aid of bichromates. By taking advantage of the fact that galena floats more easily than blende, it is possible to get a galena froth from an ore that will contain 54% lead and 15% zinc, while the blende-froth that follows will contain 37% zinc and 20% lead. This type of work errs in the other direction, that is, in having too much lead in the zinc product, but the point is that the addition of bichromates does not make a separation which is any more advantageous than does preferential flotation by other methods. However, the fact that the galena can be deadened by treatment with a weak solution of sodium bichromate is most interesting in that it shows that a true preferential flotation is possible. It is assumed that the action of the bichromate solution must be that of oxidation of the surfaces of the galena to insoluble sulphate, while such an action on the sphalerite could not be possible, as the zinc sulphate would dissolve. The treatment of the high lead-zinc product of this last mentioned preferential flotation product by the bichromate process might be a useful method of cleaning this kind of concentrate. It is probable that successful preferential flotation will develop along such lines, though bichromates are not the only chemicals that will be used. While the results obtained by this process have been shown to be capable of duplication otherwise than by the use of bichromates, this fact of the peculiar action of weak bichromate solutions is thankfully accepted and further work is urged to discover if it can have a field of application peculiarly its own.

BRADFORD. Another process along these lines is that revealed in British Patent No. 21,104 of 1913, by L. Bradford of Broken Hill. He claims the use of a solution that will wet one of the sulphides which it is desired to separate from the other preferentially without chemically altering the same. A medium which will wet galena particles and allow sphalerite and pyrite to float unaffected is a solution of one or more of the alkaline chlorides, slightly acidulated and heated to about 120 to 160° F. On account of its low cost a solution of sodium chloride is used, and Bradford states that there are no definite requirements as to how concentrated the solution shall be, but suggests a 10% NaCl solution as about the right strength to use.

The acidity should be about 0.1 to 0.2%, for a higher amount

than 1% will cause the flotation of galena on account of the formation of hydrogen sulphide bubbles on its surface. He states that if the process is applied directly to crude ores the use of a frothing agent is not necessary, although it will cause no harm if added. Any well-known apparatus can be used for the flotation.

The invention may be applied either to the crude ore or to the mixed flotation concentrate from the ordinary method of flotation. Where the plant is used on crude ore the tailings from the flotation of the sphalerite and the pyrite are agitated again in pure water with a frothing agent in order to float the galena. On account of this requirement it is thought better to make a mixed concentrate first by ordinary flotation and then separate preferentially as above described. This latter method, however, makes a higher-grade zinc concentrate.

When treating ordinary mixed flotation concentrate, it is best to remove the oil on the surface by the use of an alkaline or an alkaline carbonate solution, or by either. Further, finely ground material is liable to agglomerate too quickly, so that some of the galena will be entrained mechanically with the agglomerated sphalerite and decrease its value. In these cases it is desirable to add an agent that will retard flotation. Substances suitable for this purpose are sulphites or thiosulphites of alkalis or sulphur dioxide, but they must be used sparingly and with care, or they will entirely spoil all flotation. He thought so much of this latter step that he later incorporated it in a separate patent (Brit. Pat. No. 19,844 of 1914.) No further description of this patent is necessary.

There are many other proposed methods in the patent literature of England, Germany, France, and the United States, concerning which I am not fully informed, but it is believed that most of the important ones have been reviewed. Many interesting details are disclosed, such as the fact that galena and sphalerite will not float in a solution containing zinc chloride of the right concentration and acidified by hydrochloric acid (German patent, No. 282,234). Aniline compounds are said to allow flotation of galena in preference to sphalerite, etc.

It will doubtless be noticed that little mention is made of the kinds of machinery used in the above methods of preferential flotation and there will doubtless be some question as to whether or not these principles can be applied equally well in the mechanically-agitated and in the pneumatic-agitation machines. Most of the above processes,

where not specifically stated, have been worked out with the aid of mechanically-agitated machines, but it is possible to apply most of them to the penmatically-agitated machines, such as the Callow or the Towne. Such machines, owing to the economy of power in making froth, and the easy control of flotation conditions, will doubtless materially assist in the development of preferential flotation.

FLOTATION AT THE INSPIRATION MINE, ARIZONA

By WILLIAM MOTHERWELL

(From the *Mining and Scientific Press* of July 3, 1915)

The Inspiration Consolidated Copper Co.'s mine near Miami, in Arizona, is estimated to contain 97,143,000 tons of 1.63% copper ore, mostly in the form of chalcocite. The ore at present being mined contains about 0.20% metal in the form of carbonate and silicate.

For some time past the company has been experimenting with a view to finding the best method of concentrating the sulphide ore before smelting. The first test-mill consisted of two sets of rolls, one Chilean mill, one Hardinge conical mill 3 ft. diam. by 12 in. cylinder, Richards hindered-settling classifier, Deister tables, some kind of vanner, and a 50-ton Minerals Separation flotation machine of standard type (Hoover's single-level apparatus). This mill was situated close to the Joe Bush shaft, on top of the orebody, and is now dismantled. It is understood that good results were obtained.

On a change of management taking place, a new test-mill was erected near the old leaching plant of the Black Warrior Copper Co., about 1½ miles from the new twin-shafts through which all ore will be hoisted when the large mill is running. This mill will be the largest, or rather will handle the largest tonnage, of any mill in the world, namely, 15,000 tons per day. It adjoins the test-mill as can be seen in the photograph published in the *Mining and Scientific Press* of May 29. The crushing and concentrating capacity of the test-mill is about 1000 tons per day, but it is limited by the capacity of the classifiers, elevators, etc.

The ore is at present hoisted through the Scorpion shaft and broken in a 'K' Gates crusher close to the shaft. From there it is conveyed to the 30,000-ton flat-bottomed steel and concrete bins

attached to the crusher-station at the new shafts. It is then transported to the test-mill in Ingoldsby dump-cars (each having a capacity of 60 tons) drawn by steam-locomotives on a standard-gauge railway. A part of the new mill-bins (which are of steel and trough-shaped) is set aside for the use of the test-mill. On leaving these bins the ore falls upon a tray-conveyor, then to an inclined rubber-belt conveyor, where it is automatically weighed. At the head of this conveyor there is a magnetic pulley that removes pieces of iron and steel which may have got mixed with the ore. At this point there is a grizzly and a 36-in. Symons vertical-disc crusher.

From here an incline-conveyor carries the ore to the top of the test-mill, where it is divided into two streams, one going to a shaking screen from which the oversize falls into a 48-in. Symons horizontal-disc crusher, where it is crushed dry, and the other to a 5 ft. 6 in. by 8 ft. diam. Marcy ball-mill, where it is crushed wet without previous screening. The product of the Symons machine is fed to pebble-mills without any classification, being distributed in varying proportions by a mechanical device. This consists of a fixed horizontal circular vessel 103 inches in circumference, divided into four sections by vertical sheet-iron partitions that can be adjusted to give segments of any size, thus varying the feed to each mill as desired. By measuring the number of inches of circumference given to each division the proportion of feed going to each mill can be calculated. Above this receptacle there is a vertical crooked revolving iron pipe through which the feed comes from the Symons machine after being mixed with water. The revolution of the feed-pipe causes the pulp to be discharged into each division of the distributor in turn. In the bottom of each division is a hole through which the feed passes to launders leading to the pebble-mills.

The following kinds of pebble-mills are installed:

1. One 20 by 6-ft. Chalmers & Williams quick-discharge tube-mill with herring-bone gear engaging with pinion on a shaft directly driven through a flexible coupling by an electric motor.
2. One Hardinge conical mill, 10 ft. diam., with cylindrical part 23 in. long driven through spur and pinion by two-belt transmission from motor.
3. One Hardinge conical mill, 8 ft. diam., with cylinder 72 in. long, with herring-bone gear engaging with pinion on shaft direct driven by motor.
4. One Hardinge conical mill, 8 ft. diam., with cylinder 36 in. long, driven in the same manner as No. 3.

5. One Hardinge conical mill, 8 ft. diam., with cylinder 44 in. long, driven in same way as No. 3 and 4.

Both silex and El Oro linings were tried in the cylindrical part, and pebbles set in cement in the conical part; and, in one mill, steel plates, which, however, did not last long.

Each pebble-mill has a drag-classifier attached, and the oversize in the product, except in the case of the tube-mill, is returned by a bucket-elevator to the mill from which it came. In the case of the tube-mill the oversize is returned to the mill by the drag-classifier, which is paralld with the mill. Both Danish and California pebbles have been tried.

The product of the Marcy ball-mill is classified in a duplex Dorr classifier, and the oversize returned to the same machine. This, as a fine crusher, has a capacity of about 13 tons per hour. Of the final product only about 1% remains on a 48-mesh screen. The mill is simply a strongly built cylinder supported on trunnions, contains about 10 tons of chrome-steel or manganoid balls, and is revolved at 22 r.p.m. It was formerly fed through the trunnion, then three scoops were attached, but now one large scoop is used. It is lined with manganese-steel plates and driven through spur and pinion by belting from a 200-hp. motor, using about 140 kilowatts. The discharge is at the opposite end to the feed-inlet and passes through grates composed of steel bars placed close together. The discharge area is more than half the entire end of the mill. It will thus be seen that it differs essentially from the Krupp ball-mill, in which the screens are placed around the periphery and the pulp has to pass through two screens before escaping. The pulp leaving the ball-mill contains about 40% of moisture. This is diluted before entering the Dorr classifier. The overflow from the classifier consists of $2\frac{1}{2}$ to 3 parts of water to one of ore.

The power required to drive these different mills, their capacity, consumption of balls, pebbles, and liners are, of course, known only to the management, but it is significant that in the new mill all crushing will be done by Marcy mills.

Among other crushing machines that have been tried are the Bradley roller-mill, Symons roller-mill, Overstrom mill, and Allis-Chalmers hammer-mill. No rolls or Chilean mills, Krupp mills, or Marathon mills were tried in this plant.

The products of the Marcy mill, and such of the pebble-mills as are running, are united and elevated sufficiently high to flow to all the flotation plants without undergoing any preliminary table or

vanner concentration. The feed is distributed to the flotation plants in the following way: It flows into the centre of a horizontal, circular, revolving apparatus of sheet-iron divided into five concentric circles or rings. Each circle has 20 holes in the bottom, and the proportion of feed to each flotation plant is regulated by opening the proper number of holes and allowing the pulp to enter a launder along which it flows to the flotation plant. Thus if the ring that receives the feed intended for one particular plant has 15 holes plugged and 5 open, this plant is, of course, receiving 25% of the total feed, and the actual tonnage passed through it can be calculated.

Automatic samplers, worked by a water balance, are used throughout the mill. All assays are done by the electrolytic method, using rotating anodes.

Most of the flotation 'oil' is added to the pulp at the head of the mill, being fed from a tank by a small bucket-elevator driven by a shaft having a cone-step pulley, so that the speed of the elevator and the quantity of 'oil' can be varied to suit the tonnage of ore being crushed. This is much more satisfactory than letting the 'oil' drip from a can. Any additional reagent that may be required is added at each flotation plant by dripping from a can.

The following methods of flotation have been tried:

1. An 8-compartment Minerals Separation machine of standard type (as described in Hoover's book on flotation), having a nominal capacity of 600 tons per day. The agitation compartments are 3 ft. square, and the flotation compartments or spitzkasten, 5 by 3 ft. The spindles are driven through enclosed bevel-gearing by a pulley on a horizontal shaft. The overflow from the first six compartments was sent to the concentrate-bins without 'cleaning' or further treatment designed to raise the grade by eliminating insoluble matter and the overflow from the last two compartments was returned to the head of the machine. This machine was discarded.

2. A 12-compartment Minerals Separation machine of standard type, of the same capacity and driven in the same manner as No. 1, the additional compartments being intended to prolong the treatment. At first the concentrate and middling were dealt with as in No. 1 machine, but afterward the overflow from all compartments was 'cleaned' in (3), next described.

3. An 8-compartment 50-ton Minerals Separation machine of standard type, the spindles being driven by half-crossed belts from pulleys on a horizontal shaft. The overflow from all compartments was sent to concentrate-bins, and the tailing was returned to the head

of No. 2 machine. This concentrate contained about 30% copper. These two machines were in use until recently.

4. An 8-compartment Minerals Separation machine of new type, known as a 'sub-aeration machine.' The agitation compartments were covered on top, and both mechanical agitation and compressed air were used. The agitation compartments contained cast-iron baffle-plates fixed to the sides, and the impellers were different from those used in the standard machine, but the spindles were driven in the usual way. The discharge from the agitation compartments to the flotation compartments was high up. The air used for the aeration of the pulp was introduced through a hole in the bottom of each agitation compartment at a pressure of about 2 lb. per square inch. It did not pass through any porous medium. This machine had the usual valves and suction-pipes in the bottom, but was afterward altered to (5) a machine of the Hebbard type, with agitation gear of the standard Minerals Separation pattern, but with horizontal discs in place of the usual screw-impellers. Each spindle makes about 300 r.p.m. In the Hebbard machine as used in Australia the agitators are driven from below. There are no spitzkasten, the overflow of concentrate-froth taking place from the agitation compartments. Consequently there are no suction-pipes and valves in the bottom, and no plugs to draw and replace when a stoppage takes place. The wooden partitions between the agitation compartments have been removed and cast-iron baffle-plates about 15 in. high substituted. Air is blown through eight holes in the bottom as in No. 4 machine (described above) and water under pressure is used to prevent pulp from entering the air-pipe. On a feed of about 300 tons per day this machine has given good results, and is still in use. The low-grade concentrate made by this machine is 'cleaned' in another machine of standard type.

6. A Towne-Flim plant, or bubble-column concentrator with a nominal capacity of 50 tons per day. This consisted of (1) Pachua agitator in which the pulp was mixed with oil, (2) a cast-iron vertical cylinder with a bottom of carborundum. The oiled pulp is fed into the top of the cylinder through a pipe that delivers it below the surface. Air at a pressure of 5 lb. per square inch is blown through the carborundum. Bubbles are formed, that adhere to the oiled sulphide particles, forming a froth overflowing at the top of the cylinder into a launder, whence it flows to (3) a similar cylinder at a lower level, where it is 'cleaned.' The tailing from the first cylinder escapes through a hole in the middle of the carborundum



MICROCOPY RESOLUTION TEST CHART

ANSI and ISO TEST CHART No. 2

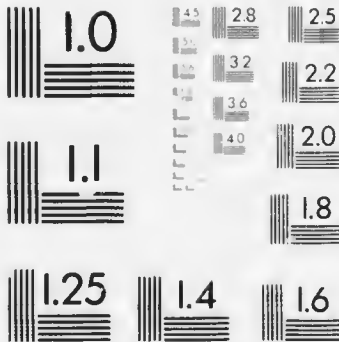

APPLIED IMAGE Inc

2700 N. M. Street
Warren, New York 14183 U.S.A.
Tel: 408/251-1111
770 288-0889 Fax

and flows through a goose-neck hose (by which the water-level in the first cylinder is regulated) to (4) another cylinder where it receives similar treatment and more concentrate overflows. This concentrate also is re-treated in the same cylinder as the concentrate from the first cylinder, and the tailing from this cylinder or 'cleaner' is returned to the Pachuea agitator at the top of the building by a centrifugal pump. The air is furnished by a Roots blower. This plant was dismantled.

7. A Callow plant consisting of (1) Pachuea agitator 18 ft. deep by 4 in. diam., (2) five cells, each $8\frac{1}{2}$ ft. long by 2 ft. wide, with nominal capacity of 50 tons each per day, (3) one cleaner-cell 12 in. wide, (4) one air-compressor, (5) one receiver, (6) Connersville blower with a displacement of 3.3 cu. ft. of air per revolution, (7) two 3-in. centrifugal pumps, (8) 30-hp. motor.

Mr. Callow's letter in the *Mining and Scientific Press* of May 29 fully describes his process, so I need not go into further particulars, except to say that during the past few months the plant has been run without the Pachuea agitators; but this is by no means advisable. This plant has been running for about nine months and has given better results than any other that has been tried here. Forty of these cells are being installed in the new mill.

8. A machine invented by David Cole, of Morenci, Arizona, consisting of rectangular sheet-iron tanks with pipes laid horizontally in the bottom. The upper half of these pipes is composed of carborundum, and air from a blower is forced through them with the same effect as in the Callow, Towne-Flinn, and other pneumatic processes. Perforated wrought-iron pipes wrapped with flannel or canvas have also been used. The tailing from the first tank is re-treated, and the concentrate from all tanks is re-treated in a 'cleaner.' This plant is still running. A similar machine is in use at Morenci, and one is being built at Cananea, Sonora.

9. The company's metallurgist has devised an apparatus intended to combine the best points of the other machines, but without infringing on any patents, except those of the Minerals Separation American Syndicate, from whom the company holds a license. It is called the Inspiration machine. At first it resembled a Callow apparatus with an almost flat bottom, the air being blown through canvas, but the froth overflowed at one side of the cell only, and there were partitions which, however, did not reach the bottom. It was twice as long as the ordinary Callow cell. The first concentrate was re-treated in a smaller machine of the same type, and the tailing from this machine

was, as usual, returned to the 'rougher' cell. Recently other porous media for false bottoms have been tried. The machine is still in the experimental stage.

It will thus be seen that the company has spared neither time nor money in endeavoring to find the best flotation process. The test-mill has been working since January 1914, and about 50 flow-sheets have been tried. In the laboratory there are 6 small flotation machines of the Minerals Separation type in almost constant use.

The tailing from all the flotation plants is run over tables, those in use being Wilfley, Deister Machine Co.'s double-deck simplex sand concentrator, Deister Machine Co.'s four-deck table, Deister slime table, and Deister Concentrator Co.'s double-deck table. At one time the ore was concentrated on tables before going through the flotation process, but this was not found suitable for the Minerals Separation process, as it left too little mineral in the ore, and for this and other reasons it was discarded. The mineral saved on the tables is mostly pyrite. The 234 tables in the new mill are Deister Machine Co.'s double-deck type, the same as used in the Miami Copper Co.'s mill. No tests were made with any kind of vanner. The sand and slime were run over the same tables without classification, but this will be altered in the new mill.

The tailing from the tables flows to the dam, the retaining-wall being built by allowing the coarse sand to escape through cones or inverted pyramids attached to the tailing-laundry.

The concentrate from all flotation plants and the tables, containing about 28% copper, 16% iron, and 26% insoluble matter, goes to a drag-classifier. From there the coarse concentrate goes direct to an Oliver filter and the fine to a V-shaped settling-tank, thence to the filter. The concentrate, after filtering, still contains a good deal of moisture. It is trammed to a bin adjoining a branch of the standard-gauge railway and loaded into bottom-discharge steel cars belonging to the International Smelting Co. Formerly it was sent to El Paso, Texas.

Water for the mill and domestic purposes is obtained by pumping from wells in the flat country about three miles distant. A large concrete reservoir has been built on a hill near the mill. Electric power is obtained from the power-house at the Roosevelt dam about 40 miles distant, belonging to the U. S. Reclamation Service, and the service is fairly satisfactory. The Inspiration company has an interest in the power-house at the International smelter near-by, where, in case of emergency, a supply of electricity can be generated by

steam from waste heat from the reverberatories and from oil-fired Stirling boilers.

As mentioned in the annual report of the company (a summary of

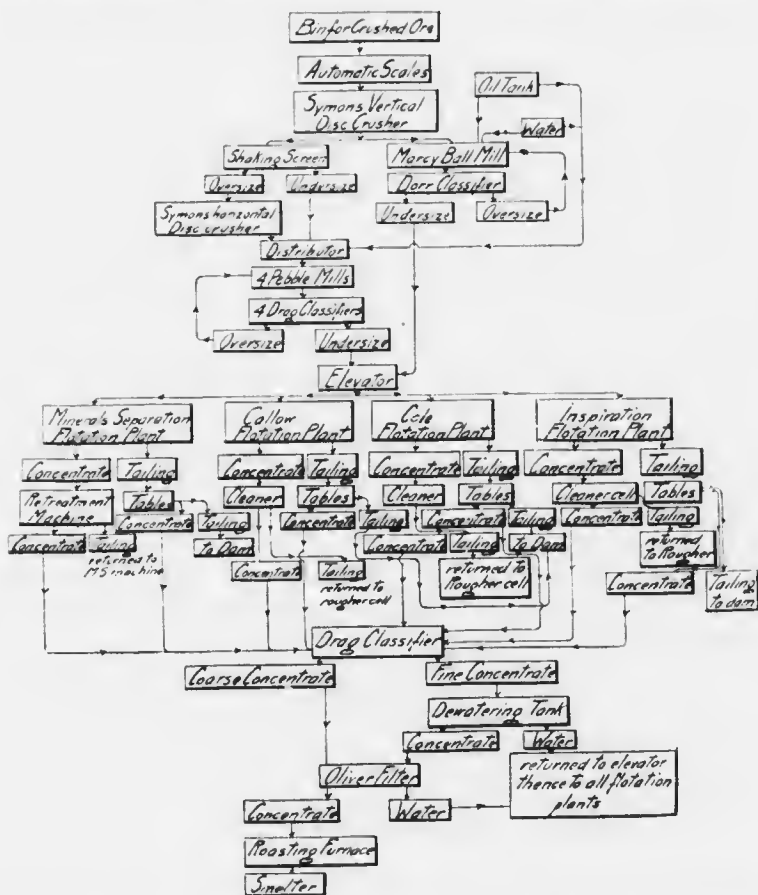

FIG. 16. FLOW-SHEET OF THE INSPIRATION MILL. THE ROASTING FURNACE FOR CONCENTRATE IS AT THE SMELTER NEAR-BY.

which appeared in the *Mining and Scientific Press* of May 1, 1915), 172,722 tons of ore was treated in this mill in 1914, so, although only a test mill, it handles a fairly large tonnage. During the month of February 1915, 90.3% of the copper occurring in the form of sulphides was recovered. The mill has been visited by mining men from all parts of the world.

FLOTATION IN A MEXICAN MILL

By A SPECIAL CORRESPONDENT

(From the *Mining and Scientific Press* of July 24, 1915)

PRESENT CONCENTRATING METHODS. The mill receives 200 tons per day of crude mine ore. After being crushed to 2-inch size, this ore is passed over a picking-belt, where one ton of high-grade ore and four tons of waste are removed each day. The remaining 195 tons of second-class ore is crushed in stamp-batteries, to pass a 4-mesh screen. Lime-water, in the proportion of 7 of water to 1 of ore, is added in the battery. The pulp from these is classified roughly, the coarse sand being ground in a Hardinge mill to pass a 20-mesh screen. The pulp is again classified roughly into four sizes of sand and one size of slime. The sand is concentrated on Wilfley tables and the slime (after being settled to 7:1 in cone-bottom tanks) is concentrated on Deister tables.

The slime-tailing, from the Deister tables, is re-concentrated on vanners. The tailing from the vanners settles to $3\frac{1}{2}$ tons of water per ton of slime; the water being further reduced to $\frac{3}{4}$:1 in a vacuum-filter. The filter-cake is washed with weak barren solution before being sent to the cyanide plant.

The sand-tailing from the Wilfley tables of the stamp-mill is classified carefully in mechanical classifiers; the slime under-size joins the slime-tailing from the re-concentrating vanners, and the sand (after the addition of cyanide solution) enters the tube-mill circuit, where it is joined by 50 tons per day of dump-tailing. All tube-milling is done in cyanide solution. After passing through the tube-mills, the combined current and dump sands are re-concentrated on Wilfley tables. The tailing from these tables is classified, the coarse sand re-entering the tube-mill circuit and the slimed sand being thickened in three 24-ft. Dorr vats before entering the cyanide plant.

METALLURGICAL RESULTS OF PRESENT METHODS

	Gold, oz.	Silver, oz.	Copper, %	Lead, %
The feed to the stamp-mill assays.....	0.1	35.4	0.25	0.7
The concentrate assays	2.0	570.0	2.0	10.0
The tailing, after concentration, assays ...	0.03	18.0	0.15	0.4

The recovery therefore is: gold, 65; silver, 48; copper, 35; and lead, 45%.

NECESSITY FOR BETTER CONCENTRATION. The above data show that a little more than half the gold is being recovered in concentration,

and that the recovery on silver, lead, and copper is less than half the contents in the original ore.

Tests indicate that more than 90% of the metal in the original ore occurs in the form of sulphides. Hence half of the metallic sulphides of the original ore enters the cyanide plant. This is undesirable for the following reasons:

1. The extraction of silver from sulphide metals is poor in the cyanide plant; the concentrate produced from panning current residue assays between 50 and 100 oz. silver per ton, and the tailing from panning invariably assays below 2 oz., even when the residue assays as high as 5 oz.; showing that the poor extraction is due to undissolved silver in the sulphides.

2. The presence of metallic sulphides increases the cyanide consumption. The chemical consumption of cyanide is reduced from 4 to 1 lb. per ton when the metallic sulphides are removed from the heading to the cyanide plant. The present excessive cyanide consumption is due almost entirely to the solution of copper from the ore.

3. The presence of copper and zinc sulphides in the cyanide pulp fouls the solution, thus decreasing the extraction from the rest of the ore.

The possibility of improving results by better concentration of the ore has long been recognized. For this reason, arrangements were made for re-concentrating. Both arrangements have effected a reduction of assay-value in the final residue and a corresponding increase of profit.

METHODS FOR IMPROVING PRESENT CONCENTRATION. Lately, extensive tests have been made to determine the possibility of still closer concentration. Careful panning reduces the average feed to the cyanide plant from 18 oz. silver to 10 oz. per ton.

Canvas tables give slightly poorer results. A full-sized canvas table, treating tailing from the Deister tables (assaying 20 oz. per ton) produced 15 oz. tailing—an extraction of 25%. Further tests along this line were discontinued on account of securing much better results from laboratory flotation tests.

LABORATORY FLOTATION TESTS. All flotation tests, made in the laboratory, were run in separatory funnels. The general procedure in the tests was to mix 100 grams of *minus* 200-mesh ore with water in proportion of four of water to one of ore. Suitable amounts of oil were then added and the mixture shaken violently. After allowing the pulp to settle for a few moments, the bottom cock of the funnel was opened and the tailing run into a second separatory funnel for

another flotation treatment; the cock being closed before the froth began to run out. This process was repeated, on the tailing, from five to seven times. Several hundred tests have been run, all possible variations of conditions being tried. The results of the tests led to the following conclusions:

1. All ores from the mine may be treated by flotation. Semi-oxidized ore from one level yields a tailing assaying 10 oz. silver per ton, while the oxidized ore from another level gives a tailing containing only 2 oz. per ton. The tailing from average ore, when conditions for flotation are right, is 4.5 oz. silver per ton.

2. The grade of tailing appears to be independent of whether the original ore is treated by flotation, or whether wet concentration precedes flotation.

3. The alkalinity during flotation must be between 0.01 and 0.05 lb. per ton of solution. The best results are secured when the alkalinity is 0.025 lb. When the alkalinity is too low, the extraction is poor although the concentrate is clean. When the alkalinity is too high, both the extraction and grade of concentrate are poor. When the alkalinity is right (0.025 lb.) both the extraction and grade of concentrate are best. The maintenance of proper alkalinity will require the most care of anything in the plant; although it will not be more difficult than the maintenance of proper cyanide strength in the cyanide plant.

4. The dilution may range between $3\frac{1}{2}:1$ and $7:1$; with the best results, on average ore, between $4:1$ and $6:1$. When the pulp is sandy a low dilution is best: pure sand, ground to 200-mesh, requires a dilution of $1:1$. Average slime, like the Deister feed, on the other hand, requires a dilution of $8:1$. Good extraction may be secured on either sand or slime, provided approximately the proper dilutions are secured in each case. Proper dilutions will be easy to maintain in the plant, for the range for the best work is comparatively large; and when either an excess of sand or an excess of slime occurs in the ore, the proper dilution will automatically adjust itself; for the sand of itself will settle to a thick pulp, while the slime will not settle well, but will remain thin.

5. The temperature is not a matter of vital interest. The extraction is slightly better and the grade of concentrate considerably higher when the temperature is over $100^{\circ}\text{F}.$, but good results have been secured with the temperature as low as $40^{\circ}\text{F}.$ It will not be necessary to arrange for heating the pulp, especially at the start.

6. Fine grinding is necessary for good results in flotation. When

the mill-heading was crushed to 60-mesh, the tailing from flotation assayed 0.08 oz. gold, and 11 oz. silver; when the same ore was crushed to 100-mesh, the tailing assayed 0.04 oz. gold and 5 oz. silver; and when the crushing was carried to 200-mesh, the tailing assayed 0.02 oz. gold and 3.75 oz. silver.

[The question of the kind of crushing mechanism best adapted to preparing ore for flotation is vital; at present the tube-mill, ball-mill, and disc-crusher hold the field.—EDITOR.]

7. The best flotation agents, so far tested, are pine-oils. Low-grade pine-oil gave as good results as the higher-grade varieties. S. S. pine-oil, of the General Naval Stores Co. (cost 26c. per gal., f.o.b. factory) has given exceptionally good results. For the best work in flotation it is necessary to have this oil present to the extent of 0.6 lb. per ton of ore. In actual plant-practice, where the water is returned again and again to the top of the mill, the consumption of oil will probably be about $\frac{1}{4}$ lb. per ton of ore. This oil will cost, delivered, 8c. per pound.

Pine-tar oil is much cheaper. It gives good extraction, but the grade of concentrate is low. Cresylic acid, when used with pine-oils, increases the extraction about $\frac{1}{4}$ oz. silver per ton. This hardly pays for its use.

8. In the laboratory tests the grade of concentrate was low, averaging 200 oz. silver per ton. This concentrate could be raised to 1100 oz. by re-treating the concentrate by flotation.

9. Cyanide tests, run on tailing from the flotation tests, produced residues assaying less than 1 oz. silver per ton, with a cyanide consumption of less than 1 lb. per ton.

10. The dump-tailing cannot be easily treated by flotation. When the methods of flotation that are applicable to mine ore are applied to the pump-tailing, the results are *nil*. Furthermore, when the water that has been in contact with the pump-tailing is used for diluting mine-ore, the mine-ore cannot be treated advantageously by flotation. Experiments show that both these effects are due to the presence of soluble sulphates (chiefly those of magnesium and calcium) in the pump-tailing. The injurious effect of magnesium sulphate can be overcome largely by an excess of oil. No method of overcoming the injurious effects of calcium sulphate has yet been discovered in the tests.

When the dump-tailing is washed in fresh water half a dozen times, before being treated by flotation, the results of flotation are as satisfactory as is the case with mine-ore. However, a plant for

washing the dump-tailing would be more expensive than the small tonnage of this material warrants, and the operation of such a plant would necessitate the waste of more water than is available. Some other method of rendering the dump-tailing susceptible to flotation may be devised; but the small tonnage does not warrant any extended investigation. The best thing to do, especially at the start, is to send the dump-tailing direct to the cyanide plant (after concentrating the ground sand on Wilfleys) as at present.

11. As a result of the laboratory experiment, it was decided that full-sized tests should be conducted in the plant on run-of-mine ore.

PLANT TESTS. For this purpose, there were set aside for the flotation circuit: one battery of five stamps, two Wilfley tables, one classifier, one tube-mill, one 24-ft. settler, and one pump for returning the water from the settling-tank to the head of the mill.

A flotation-cell of the pneumatic type was first tried. When treating 20-oz. heading this machine produced a 290-oz. concentrate and a 15.3-oz. tailing. This was far from satisfactory.

Another machine consisted of a series of mechanical-agitation chambers, alternating with a series of settling-chambers. From the start, this machine has given excellent results. In spite of many mechanical difficulties, and trouble with inexperienced operators, the tailing from the plant has averaged but little above 5 oz. silver per ton, and the concentrate has averaged above 600 oz., without re-concentration.

The chief weaknesses of mechanical agitation, as ascertained in this mill, are as follows:

1. The complex system of shafts and counter-shaft, with the corresponding drives, bearings, etc.
2. The difficulty of adjustment; any slight change in feed necessitating a change in the valves of each chamber.
3. The difficulty of the passages between chambers becoming clogged.

SUBMERGED AGITATION. It has been attempted to evolve a flotation machine to overcome these weaknesses, and at the same time give results as good as the mechanical agitation plant. A small machine (capacity 3 tons per day) has been constructed, and this, after many alterations, has yielded a 3.7-oz. tailing and a 680-oz. concentrate, when treating 10-oz. feed. This machine employs a somewhat novel principle of flotation—that of submerged agitation—the mixture of pulp, oil, and air being violently agitated in a partly

closed chamber, under the hydrostatic pressure of several feet of pulp in the settling-chambers above.

In construction, this machine is simpler than the machine using mechanical agitation. It consists essentially of a V-shaped box or trough, divided into compartments by a series of vertical partitions. At the bottom of each partition is an agitation-chamber. Agitation is supplied by a paddle-wheel in each chamber. All the paddle-wheels are mounted upon a single horizontal shafting, which passes the entire length of the trough, leaving the end partitions through stuffing-boxes. The pulp enters each agitation-chamber through an opening around the shafting, and leaves the agitation-chamber through an adjustable aperture, at a slight distance from the shafting. The agitator thus acts slightly as a centrifugal pump, overcoming the friction loss in the passage from one compartment to another, and keeping the height of the pulp the same in all the settling-chambers. The adjustment of the aperture is arranged to increase or decrease the centrifugal force. This adjustment occasions much less difficulty than is experienced in mechanical agitation, where the flow from one compartment to another is merely throttled.

Also, in the new plant there are no pipes to become clogged, the passage of pulp from one cell to another being along a rapidly revolving shafting, which keeps all material in suspension. The concentrate overflows from both edges of the trough, thus being removed more promptly than in a plant using mechanical agitation.

Further tests with the small machine are being made, and a larger machine (capacity 40 tons per day) is being constructed, for thoroughly testing the principles involved. The 40-ton machine will be constructed with the idea of using it for re-concentration of the concentrate, should a full-sized flotation plant be installed.

SIMPLE MECHANICAL AGITATION. The machine has now been operating intermittently for a month. During that month it ran six days continuously, treating 25 tons of 29-oz. pulp and producing 6.4-oz. tailing and 600-oz. concentrate. During the first five days of the following month, careful tests were run to compare flotation results with those from current concentrating practice. The following tables give the summary of results from these tests.

MILL-TESTS. Flotation *v.* Present Concentration Practice. Flotation plant takes 25 tons per day of mill heading after being crushed to 20-mesh by stamps, concentrated on Wilfleys, and passed through a tube-mill.

METALLURGICAL RESULTS, PER TON OF ORIGINAL ORE, USING FLOTATION

	Tons.	Assay		Contents	
		Gold.	Silver.	Gold.	Silver.
Mill-heading	1.0000	0.125	39.81	0.125	29.81
Wilfley concentrate	0.0313	3.070	663.27	0.096	20.76
Wilfley tailing	0.9684	0.030	19.70	0.029	19.05
Flotation concentrate	0.0207	1.190	692.78	0.025	14.34
Flotation tailing	0.9477	0.004	4.98	0.004	4.71
Cyanide residue		0.001	1.00	0.001	0.95
Cyanide bullion	0.003	3.76

LIQUIDATIONS*

Wilfley and flotation concentrate, tons		0.52
Gold, 0.12 oz. at \$20		\$2.42
Silver, 35.10 oz., 95% = 33.345 oz. at 50c		16.67
Copper, 3% - 0.3 = 2.7%; 2.81 lb. at 8.2c		0.23
Lead, 11.8% - 1.5 = 10.3%; 90% at 3c		0.29
		<hr/>
		\$19.61
Less haulage, freight, and treatment, at \$19.67 per ton		\$1.02
Less taxes, commissions, etc., 7.44%	1.45	2.47
		<hr/>
Bankable funds from concentrate per ton of ore		\$17.14
Bullion from flotation-tailing, per ton of ore, 5.56 oz. gross:		
Gold, 0.003 oz. at \$20.67		\$0.06
Silver, 3.76 oz. at 50c		1.88
		<hr/>
		\$1.94
Less haulage, treatment, 1.08c. per oz.		\$0.06
Less express, duties, etc., 7.8%	0.15	0.21
		<hr/>
Bankable funds from bullion per ton of ore		\$1.73

*Throughout this article values are given in U. S. Currency.

PRODUCTS PER TON OF ORIGINAL ORE

	Tons.	Assay.					Insol- uble.
		Gold. Oz.	Silver. Oz.	Copper. %	Lead. %	Zinc. %	
Wilfley concentrate...	0.0313	3.07	663.27	2.75	12.00	12.7	24.5
Flotation concentrate..	0.0207	1.19	292.78	3.36	11.55	13.9	34.3
Average concentrate..	0.0520	2.327	675.00	3.00	11.80	13.2	28.4
Bullion		0.003	3.76

PRESENT PRACTICE. During the five days the flotation test was being run, the rest of the mill received 160 tons per day of the same grade of mill-heading. This was treated on Wilfley and Deister tables and the tailing re-concentrated on Wilfleys and vanners.

METALLURGICAL RESULTS, PER TON OF ORIGINAL ORE

	Tons.	Assay		Contents	
		Gold.	Silver.	Gold.	Silver.
Mill-heading	1.00000	0.125	39.81	0.1250	39.81
Stamp-mill concentrate...	0.03650	1.930	518.00	0.0706	18.94
Willfley re-concentrate...	0.00375	1.760	286.44	0.0066	1.08
Vanner re-concentrate...	0.00060	0.780	370.92	0.0005	0.22
Tailing	0.95815	0.050	20.40	0.0473	19.57
Residue	0.95815	0.0048	3.12	0.0046	2.98
Bullion				0.0427	16.59

Bullion, 24.88 oz. gross; gold, 0.0427 oz.; silver, 16.59 oz. per ton.

LIQUIDATION, PER TON OF ORIGINAL ORE

Concentrate, tons	0.04085		
Gold, 0.0777 oz. at \$20.....		\$1.55	
Silver, 20.24 oz.; 95% at 50c.....		9.61	
Copper, 2.41% - 0.3 = 2.11%; 1.73 lb. at 8.2c.....		0.14	
Lead, 9.7% - 1.5 = 8.2%; 90% at 3c.....		0.18	
			\$11.48
Less haulage, freight, and treatment, at \$19.67 per ton.....	\$0.80		
Less taxes, commission, and expense, 7.44%.....	0.86	1.66	
			\$9.82
Bankable funds per ton of ore.....			\$9.82
Bullion from current tailing, 24.88 oz. gross:			
Gold, 0.0427 oz. at \$20.67.....		\$0.88	
Silver, 16.59 oz. at 50c.....		8.29	
			\$9.17
Less haulage and treatment, at 1.08c. per oz.....	\$0.26		
Less express, taxes, etc., 7.8%.....	0.72	0.98	
			\$8.19

PRODUCTS PER TON OF ORIGINAL ORE

Tons.	Assay.					Insol- uble.	
	Gold. Oz.	Silver. Oz.	Copper. %	Lead. %	Zinc. %		
Stamp-mill concentrate..	0.03650	1.93	518.00	2.56	16.40	12.9	24.50
Willfley re-concentrate...	0.00375	1.76	286.44	1.03	3.37	6.0	45.28
Vanner re-concentrate...	0.00060	0.78	370.92	1.00	5.86	4.7	56.22
Total concentrates.....	0.04985	1.90	496.00	2.41	9.7	12.15	27.00

COSTS. Labor and repair costs will remain about the same as now. Two high-class operators in the present re-treatment plant will be replaced by three cheap operators in the flotation plant.

Power consumption will be increased about 40 hp. This will cost 5c. per ton.

Oil consumption will be about $\frac{1}{4}$ lb. per ton of ore. $\frac{1}{4}$ lb. @ 8c. = 2c. per ton.

The total increase in the cost of concentration will therefore be about 7c. per ton.

The present cyanide consumption per ton of ore is 6 lb., of which 2 lb. is mechanically lost. Small laboratory tests show that the chemical consumption of cyanide when flotation-tailing is treated, is only 1 lb. per ton of ore. This is 3 lb. less than the consumption when current tailing is treated. If this result is sustained in actual plant-practice, the saving in cyanide alone will amount to $3 \times 19c. = 57c.$ per ton of ore.

The present cost of precipitation and melting is 2.56c. per fine ounce.

In present practice 16.6 fine ounces are produced per ton of ore. When flotation tailing is treated, only 3.7 oz. are produced per ton of ore. This means an excess of 12.9 oz. produced in present practice: $129 \times 2.56c. = 33c.$ per ton of ore.

FINANCIAL STATEMENT

Flotation v. Present Practice, Per Ton of Original Ore.

	Present practice.	Flotation.
Bankable funds; marketing concentrate.....	\$9.82	\$17.14
Bankable funds; marketing bullion.....	8.19	1.73
Increased cost of concentration.....	0.07
Decreased cost of cyanide	0.57
Decreased cost of melting and precipitation.....	0.28
	\$18.08	\$19.72

Increased profit per ton from flotation, 200 tons per day at \$1.64 = \$328 increased profit per day or \$9840 increased profit per month.

The above is calculated on the basis of results from a single mill-test of 5 days' duration. During this interval the heading to the mill and the residues were excessively high; indicating a greater advantage in favor of the flotation plant than is actually warranted.

The estimate of probable profit may be revised roughly by using the metallurgical results of the past two months for the basis of calculations. During two months the heading to the cyanide plant has averaged 17.8 oz. silver, and the residue has averaged 2.75 oz. per ton. The residue from cyanide-flotation tailing would assay 1 oz. per ton. This indicates an increased extraction of 1.75 oz. silver per ton of ore. 1.75 oz. at 41c. = 72c. increased profit per ton.

The indicated decrease in cyanide consumption (as determined

solely in the laboratory) is 3 lb. per ton of ore. Reducing this to $2\frac{1}{2} \times 19c. = 47c.$ per ton of ore.

The decreased cost of precipitation and melting may be figured as follows:: Cost of precipitation and melting, per fine ounce, has been 2.4c. The decreased production of bullion, due to flotation, would be 11 oz. per ton of ore. 11 oz. at 2.4c. = 26.4c. When fixed charges are considered, this should be reduced to 20c. per ton.

When the profit from marketing an increased amount of lead and copper is balanced against the increased loss occasioned by marketing the silver and gold as concentrate instead of bullion, there is a deficit of 17c. per ton of ore.

The matter may be summarized as follows:

	Per ton.
Increased extraction	\$0.72
Decreased cyanide consumption	0.47
Decreased cost of precipitation and melting	0.20
	<hr/>
	\$1.39
Increased cost of marketing	0.17
	<hr/>
Profits per ton of ore	\$1.22

The average tonnage of mine-ore for the past two months has been 5761 tons. Hence the indicated increase in monthly profit would be $5761 \times \$1.22 = \$7028.42.$

INSTALLATION OF FLOTATION PLANT. Should a flotation plant be installed, operations in the stamp-mill will continue as at present; though it may be deemed advisable, after the flotation plant is running smoothly, to eliminate concentration in the stamp-mill, and depend upon the flotation plant for all concentration.

Re-concentration of current tailing on vanners and Wilfleys will be discontinued from the start.

The dump-tailing will be treated as at present, with the exception that this material will enter the plant only in the day-time. One tube-mill, one classifier, one elevator, and the re-concentrating Wilfley tables will be kept separate from this circuit, which will be in cyanide solution. All lime for the cyanide plant will enter this circuit. One of the 24-ft. tanks and one of the pumps must be reserved for the dump-tailing circuit.

All the tube-milling of current sand tailing will be done in mill-water, instead of cyanide solution.

The ground sand, together with the current slime, will be settled in two of the 24-ft. thickening-tanks, and will then enter the flotation

plant. From the flotation plant, the tailing will flow to the two 33-ft. thickening-tanks. The thickened pulp from these tanks will be de-watered and washed in the vacuum-filter before entering the cyanide plant.

All lime for the mill-circuit will be added as an emulsion to the flotation-tailing launder, where it will be under direct control of the flotation-operator. The water in the 23-ft. thickening-tanks will contain about 0.4 lb. dissolved lime per ton. This is ample for good settling. The overflow from these tanks will be reduced, by consumption, to about 0.1 lb. per ton. This is sufficient for fair settling in the conc-bottom tanks of the stamp-mill. By the time the pulp reaches the 24-ft. thickening-tanks the lime will be reduced to 0.03 lb. per ton. This low lime will be extremely detrimental to good settling in these tanks.

INSTALLATION REQUIRED. The matter of supplying proper settling and de-watering facilities will be the most serious and most expensive part of the installation.

The two 24-ft. thickening-tanks, to be used in the flotation-circuit, must be triple-decked. It will also probably be found necessary to double-deck the 32-ft. steel thickening-tank. The work on settling-tanks will cost about \$6000.

By increasing the settling capacity, the pulp will probably be settled to a sufficient thickness so that the vacuum-filter will be able to handle the combined sand-slime feed.

It may be found necessary, however, to add another unit to this plant. This will cost \$2000.

The flotation plant will consist of two units (each of which will be able to treat the total tonnage of current tailing) and one smaller clean-up machine. The whole plant will cost about \$3000. A filter-press for handling the concentrate will cost \$2000. Tanks, air-lifts, launders, and buildings will cost \$2000. Thus the whole installation will cost \$15,000, or \$20,000 at the most. The addition of the flotation plant, for treating current tailing, will increase the profit about \$7000 per month. Practically all ore from the mine may be treated by flotation.

FROTH AND FLOTATION

(From the *Mining and Scientific Press* of July 31, 1915)

In the issue for November 1903 of the *California Journal of Technology* there appeared an article describing the experimental work done on oil-flotation by three senior students in the University of California. The article is entitled 'Experiments on the Elmore Process of Oil Concentration' by W. F. Copeland, Drury Butler, and Jas. H. Wise.

At the outset they state:

"The process depends upon the fact that minerals with a metallic lustre, when treated in the form of a wetted pulp, adhere to oil, while earthy minerals do not. Two distinct operations are involved; first, the separation of the metallic mineral from the gangue by means of oil; second, the extraction of the mineral from the oil.

"The ideas underlying the first operation were patented by John Turnbridge of Newark, N. J., in 1878. In 1886 Carrie J. Everson, of Chicago, contributed the idea that the concentration was aided by the presence of an acid solution, and patented the same. But the absence of a successful method of separating the mineral from the oil prevented the practical application of these early patents. Burning the oil was tried, but this left a difficult residue to treat, and the large consumption of oil made the method too expensive. Settling the mineral out by thinning the oil with gasoline, ether, carbon-bisulphide, etc., also proved too expensive, and it was not until July 1900 that this difficulty was overcome, when Mr. Francis E. Elmore, of Leeds, England, accomplished the separation by means of a centrifugal machine, similar in most respects to those used in sugar factories and in milk and cream separation. This contribution by Mr. Elmore, then, made the process feasible."

[They give an illustration of the plant designed by the Oil Concentration Syndicate and describe the operations. Their own apparatus is shown in photographs and they give details of the tests made on various ores. In brief, they obtained the following results:

Character of ore.	Extraction, %
Gold-quartz ore	86
Silver ore	75
Copper-schist tailing	90
Molybdenite ore	75

They describe the nature of their experiments and comment on the facts disclosed in a most intelligent way. We quote the salient paragraphs.]

"In making a test, the ore is first crushed to the desired fineness, and the proper charge is thoroughly wetted in the solution to be used (usually water), thus forming a thin pulp. The oil is next added and the whole charge thoroughly mixed. This mixing, or agitation, can be done in two different ways: The charge may be agitated very gently, the oil being kept in a single lake, and broken up as little as possible consistent with a thorough contact of pulp and oil; or the charge may be agitated so violently as to dash the oil up into a foam or froth, full of air bubbles; thus a very thorough contact of oil and pulp is obtained. * * * * *

"Three methods of mixing may be used.

1. By inverting the tube several times, thus allowing the ore to fall through the oil.
2. By rotating the tube in a horizontal position, thus throwing the pulp up on to the surface of the lake of oil.
3. By violently shaking the tube, thus producing the *foam effect*,* or at least shattering the oil into small globules."

* * * * *

"The solution used in the concentration is a matter of some importance. Water is, of course, used whenever possible, but certain other solutions have important advantages. As before stated, an acid solution is found advantageous. It cleans the metallic surfaces by dissolving the metallic oxide coatings that may have formed on them. It increases the specific gravity of the solution, and it aids in producing the *foam effect*, which is due to the generation of certain gases.

As before stated, the specific gravity of the average oil used is about 0.9 and water 1.0,[†] leaving a difference of about 0.1 for buoyancy or carrying capacity of the oil.

The idea at once suggests itself that if a denser solution be used, the carrying power of the oil will be increased correspondingly. A salt (NaCl) solution, for instance, gives excellent results. A saturated solution of NaCl at 20°C., containing about 27% NaCl, has a specific gravity of 1.204. This gives a difference of 0.3 between the specific gravities of the oil and of the solution, and a carrying capacity of the oil threefold greater than with water alone. Not only does it

*[The italics in all these quotations are ours.—EDITOR.]

†[In the original it is .1.—EDITOR.]

give greater buoyancy to the oil, but *it also aids materially in producing the foam effect*, and probably aids in brightening the metallic surfaces."

* * * * *

As a conclusion to the above experiments, the following suggestions and inferences are appended:

1. AS REGARDS THE WETTED PULP. As far as could be determined, particles with either metallic or non-metallic surfaces, when in a dry state, alike adhere to the oil. Furthermore, there is no affinity of oil for water, as shown by the fact that an oiled surface cannot be wetted. Hence if a metallic particle be thoroughly wetted, a water surface and not a metallic surface is exposed to the oil; and the former, as before stated, has no affinity for the oil. It is evident then that the water film must first be displaced before the oil and mineral can come in contact with each other. This displacement is hardly probable if the water film is in intimate contact with the particle, and it seems more probable that the differentiation is due to the fact that non-metallic surfaces are, and metallic surfaces are not, actually wetted. If this be the case, a careful study of the relative wetting of different surfaces would be an important line of investigation.

2. The ratio of the exposed surface to the weight of the particle should be as large as possible, because the total adhesive force is increased with an increase of the surface exposed to contact with the oil. This condition is best realized when the mineral breaks up into thin flakes. It is evident from this that a knowledge of the fissile character of the minerals in question is important.

3. One fundamental difficulty involved in this process is that it undertakes to concentrate and float a heavy metallic mineral, and sink the lighter gangue minerals, but this point is not necessarily fatal to the process. It is evident, however, that the heavier the gangue and the lighter and more fissile the metallic minerals, the better the ore is adapted to this method of concentration. This is a direct reversal of the ideal conditions for jig or vanner concentration.

4. Another characteristic of the process is the fact that the ratio of concentration is usually small, due to the large amount of gangue occluded by the oil and carried into the concentrates. This difficulty is increased by sliming the gangue minerals. Sliming of the metallic minerals is no disadvantage.

FOAM EFFECT.—*The foam effect is produced by a violent agitation, especially in acid or salt solutions. This throws the oil into a froth, which is heavily charged with air or other gases. This gas, of*

course, gives a greatly increased buoyant force. The oil in this condition assumes a certain load of mineral and holds it in a very stable condition. The charge does not settle and overload on standing as in the case of the lake effect. The foam effect is best adapted for light flaky minerals, such as molybdenite.

The work above outlined suggests many lines of further investigation, and as these come to be worked out, the process will become more valuable and of more general application."

[It is clear that they had a good idea of the usefulness of the froth, and how to make it. In the employment of salt and acid, they anticipated G. D. Delprat, for his British patent for the use of salt and sulphuric acid was taken out on December 11, 1903, that is, two months after this article was published. The early work of C. V. Potter (patented on January 14, 1902) and G. D. Delprat (beginning with a patent dated November 28, 1902) did not involve the use of oil, but the generation of gas in the pulp to form bubbles. Aleide Froment (under patent dated June 4, 1902) connected the oil and bubble ideas, and it is his patent that forms the basis of the Minerals Separation process, to which in 1905 (and particularly November 6, 1906) were added several patents obtained by H. L. Sulman, H. F. K. Picard, and John Ballot, for the agitation-froth process. Thus these three students at the University of California had touched upon an idea destined to be of the greatest importance in metallurgy, but they did not know it. In the very same issue of their *Journal of Technology* there appears an article on 'The Method of Obtaining Letters Patent.' The irony of the juxtaposition is evident now. We note that the manager of this student publication was Arthur H. Halloran, then a junior in the University. He became a member of the staff of the *Mining and Scientific Press* after graduation and for some time after his father, J. F. Halloran, sold the control of the paper to the present writer. However, it may not be so surprising that these young fellows failed to appreciate the importance of the suggestions obtained in the course of their experimental work, but it is truly remarkable that a keen investigator like their professor, the late Samuel B. Christy, should have overlooked it, at a time, too, when he himself was at work on kindred research, more particularly in cyanidation. It may have been his absorption in the one part of the subject that prevented him from obtaining the right focus on these—now, to us—deeply suggestive experiments.—EDITOR.]

FLOTATION AT WASHOE REDUCTION WORKS, ANACONDA

By E. P. MATHEWSON*

(From the *Mining and Scientific Press* of August 28, 1915)

The mineral that is two millimetres and under in size is sent to the Hardinge mills for re-grinding. These mills are 10 ft. diam. by 4 ft. long, and are in closed circuit with simplex Dorr classifiers, one classifier to each mill, 6 mills to the section, and 8 sections in the establishment.

The overflow from the classifiers goes to the flotation division, and the classifier-sand is returned to the Hardinge mills. At present pebbles are being used in the Hardinge mills, but, in all probability, steel balls will ultimately be used. With pebbles the Forbes lining is used, but with steel balls in use, each mill will be fitted with a false wooden lining to reduce the diameter of the cylinder, and a manganese-steel lining will be placed inside of this.

Each mill has a direct-connected 225-hp. motor. The mill fitted with pebbles required from 95 to 115 hp., but the motors are made extra heavy, in anticipation of the use of steel balls.

In each section of the flotation plant there are four Minerals Separation machines, each having 15 agitators and 14 floating-compartments. Below these are six Callow cells for cleaning the concentrate. The agitators for the Minerals Separation machines are made of gun-metal and are driven by bevel-gears from the main shaft. (See Fig. 17.) Each machine is driven independently by a 150-hp. motor, running at 385 r.p.m. on full load. The speed of the agitators is reduced to about 225 r.p.m.

The product from the machines is a tailing, which goes to waste (from this tailing, fire-brick, building-brick, and acid-proof brick will be made in a new brick-plant now under construction); a concentrate, which is sent to the Dorr thickener-tanks, for settlement—this comes from the first three cells of the frothing-machines. The rough concentrate from the next six cells of the M. S. machines, is further cleaned in the Callow cells (See Fig. 18), making a clean concentrate; and the middling, which, with the middlings from the remaining five cells of the M. S. machines, is returned to the feed of these same machines.

About 6 to 8 lb. of 50° B. sulphuric acid, per ton of flotation-

*Manager for the Anaconda Copper Mining Company.



FIG. 17. MINERALS SEPARATION FROTHING MACHINES.

feed, is used, together with two to three pounds of kerosene-sludge acid and from one-half to one pound of wood-creosote. A portion of the wood-creosote is added to the head of the Hardinge mills, and the remainder is added at the head of the M. S. machines. The pulp is heated to 60 or 70° F. by steam introduced into the first agitating-box. The method of adding the reagents is unique. The mixer consists of a revolving disc, to the circumference of which are attached a number of cups. The disc is set vertically, so that its lower edge dips into the pan of acid, or oil; as the disc revolves the cups are filled, and later discharge their contents into a suitable launder leading to the flotation machines. The disc is driven by the friction of a wheel against another disc attached to the main drive. The wheel is run at constant speed and any variation in feed can be made by changing the point of contact between the wheel and the disc. In addition to the speed regulation, the amount of acid, or oil, fed may be varied by changing the number of cups, or the size of the cups.

On account of lack of space in the old mill, now being re-modeled for flotation, an auxiliary plant has to be installed to handle the extra slime from the mill. This is now under construction and will consist of 20 M. S. machines of the same type as those now in use. Fourteen of these will be required for treating the current slime from the mill; the remaining six will treat old slime from the dump. This will be brought from the dump dry and mixed with water before treatment in the machines. The capacity for the dump-slime is about 1000 tons per day. No Callow cleaners are to be used in this plant.

The concentrate from the flotation machines is thickened to about 60% solid in Dorr tanks, 50 by 12 ft., the spigot-product of which goes to 11½-ft. diam. by 12-ft. face, Oliver filters, each having a capacity of about 150 tons daily.

The cake from the filters contains about 18% moisture and will be fed onto a conveyor carrying mill-fine concentrate to the new roasting-plant now in process of construction. In this way the filter-cake will be fairly well mixed with the concentrate, so that a generally uniform feed will be obtained for the roasters.

At the present writing two sections (out of eight) of the old mill have been re-modeled to use flotation; and a third section is now nearly ready. The mill is being re-modeled a section at a time by the company's engineering department. Some remarkably rapid work has been accomplished in changing over from one system

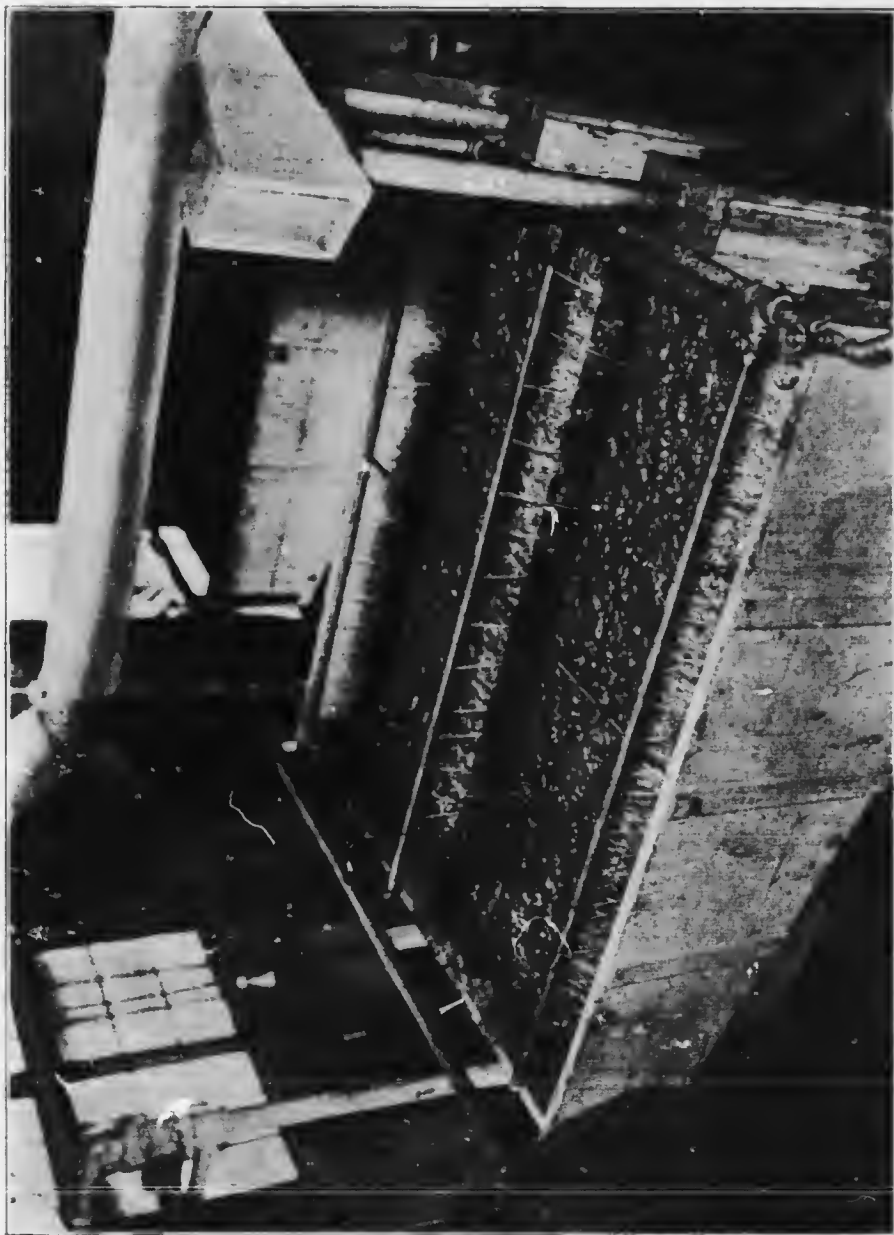

FIG. 18. CALLOW CLEANER, SHOWING THE MINERAL FROTH.

to the other. For instance, the No. 2 section of the mill was in operation on the 26th day of May for ordinary water-concentration; but was wholly re-constructed and in operation using the flotation process, on the 26th day of June. Each section has a capacity of 2000 tons of original feed daily. At the present rate of re-construction the entire plant will be re-modeled by January 1, 1916.

FLOTATION AT THE CENTRAL MINE, BROKEN HILL

By JAMES HEBBARD*

(From the *Mining and Scientific Press* of September 4, 1915)

‡EARLY ATTEMPTS AT FROTHING. While concentrating the galena in the lead ore produced from the Central mine, a valuable by-product was obtained in the form of slime assaying 18% lead, 20% zinc, and 16 oz. silver per ton. This came from an ore in which quartz and rhodonite were the chief gangue-minerals. In the course of ordinary operations, it had long been observed that a froth was formed containing high metallic values, in silver and lead particularly, whenever conditions were favorable, as, for instance, where the rotation of trommels, or the splash of the elevators or raff-wheels, or the motion of the jig-plungers, produced a violent agitation of the mill-water containing slime. Early in 1901 a series of experiments was carried out for the purpose of reproducing and accentuating the conditions responsible for this valuable float-concentrate. Experiments and tests, extending over several months, were made on slimes of varying degrees of fineness. Among the appliances tried was a series of funnel-shaped vessels with the small ends downward, each fitted with an overflow-lip. The bottom end of the funnel or cone-shaped vessel was fitted with a tap or plug discharging the contents into the next vessel in the series, and so on. To each vessel was attached, near the bottom, a water-pipe, as well as a pipe carrying compressed air. The object of the water was to provide an upward current for the contents of the vessel, while the object of the compressed air was to produce agitation, and

*Manager of the Central Mine, Broken Hill, New South Wales.

‡Abstract of paper appearing in the Proceedings of the Australasian Institute of Mining Engineers, November 10, 1913.

enhance the agitation effect of the up-current of water, in the expectation of reproducing the conditions causing the 'float' or metallic froth. Speaking generally, these experiments were on the lines of a spitzkasten, with a strong up-current to produce an agitation of the slime-water, assisted by jets of compressed air. It was thus early recognized that the bubbles of froth noticed in the wet-concentration operations were due to the aeration produced by violent agitation, resulting from mechanical implements moving rapidly in water. In these experiments a metallic froth or scum could be produced and recovered assaying 26 oz. silver, 30% lead, and 22% zinc. The appliance employed is illustrated in Fig. 19.

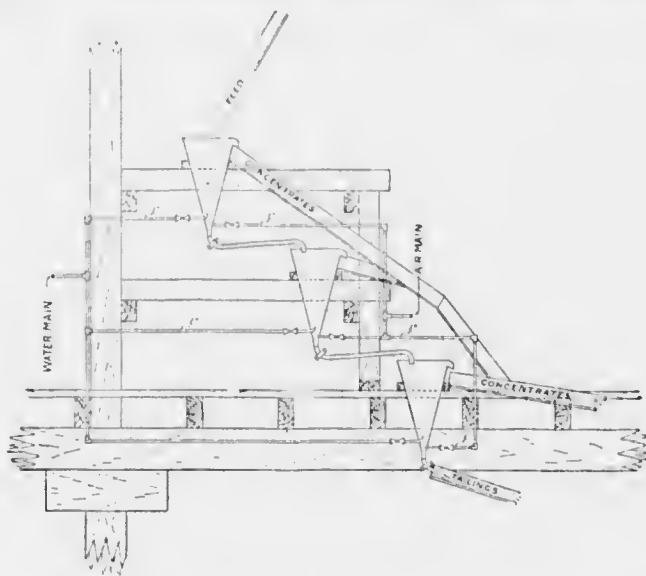

FIG. 19. APPARATUS FOR EXPERIMENTS ON FROTH.

[Up to that time the lead concentrate was the only marketable product from the ordinary water concentration. Besides calcite, the ore contained a good deal of rhodonite and garnet, each of which has a specific gravity close to that of blende. Thus water concentration could only yield a quartz tailing and a leady zinc-rhodonite-garnet middling.]

PRELIMINARY TEST. Early in 1903 an exhaustive series of laboratory tests was made on the lead by-product by flotation methods, using heated sulphuric acid and salt-cake solution. These tests

yielded some slight measure of success on material specially prepared, that is, on grainy material from which both the coarse and fine had been eliminated, leaving it evenly sized. Certain classes of the material produced by our mills contained such a large proportion of carbonates—such as carbonates of manganese, lime, and lead—that no flotation could be secured except by a prohibitive consumption of acid. These tests were carefully made, but the best work done in the laboratory was not equal to that being secured on a commercial scale in the existing magnetic plant. The tests on these flotation methods were conducted in pans or vessels worked on the principles of spitzkasten, following the lines of Potter and Delprat. The first apparatus was constructed so that the liquors could be raised in temperature by the application of direct heat underneath the pan; but in the later types the temperature of the liquor in the pan or spitz-box was maintained by the injection of live steam into the storage-tank. In none of these tests was agitation employed, the material to be treated being fed practically dry on the surface of the liquor in a regular stream, and the heated liquor added through a pipe discharging near the bottom of the vessel, and given an upward inclination in order to produce an up-current in the box itself and a gentle overflow at the lip. A still surface was imperative in this operation, and it was equally evident that the operation depended largely for its success on surface tension of the liquor, after the gas evolved by the action of the acid on the mineral carbonates had raised the particles. This surface tension was increased by the density attained in the one case by the salts formed from the mineral and gangue through the action of the sulphuric acid, and in the other by the addition of salt-cake. In all these experiments the liquor was returned by the ordinary type of air-lift, using compressed air at about 70-lb. pressure. These experiments definitely demonstrated:

1. That there was a limit to the size of the particle that could be buoyed up.

2. That any material below a certain size, no matter what its character—whether gangue or mineral—floated, owing to the density of the solution.

3. That if the finer particles of gangue were not eliminated before treatment they would be floated with the mineral, and lower its value in metals to such an extent as to make it unmarketable.

Slime, whether existing as a by-product of the ordinary wet-mill concentration or subsequently produced in preparing tailing for

treatment, bulked so largely among the total material available for re-treatment that any process that failed in this direction was too limited in its scope to be of much value to the Central mine.

As far as any process up to date was concerned, slime had to be regarded as of no value except in so far as it was available for smelting. The Broken Hill Proprietary Co. had used a considerable quantity in this way, and had discovered that roasting or sintering the slime in open heaps after briquetting gave a fair product valuable for smelting, a good deal of the sulphur and a fair proportion of the zinc having been driven off. The Sulphide Corporation also sought to make its slime available by this means, but it was proved that the losses of metal were too great to justify this method of rendering the slime amenable to direct smelting.

CATTERMOLE OR GRANULATION PROCESS. The foregoing experiments were abandoned on account of information received from London. C. F. Courtney, who was in England during the year 1902, advised that a discovery of considerable importance had been made; that laboratory trials gave every indication of success on a large scale; and that the process was so comprehensive as to include the finest slime and varying coarser sizes of particles up to $\frac{1}{2}$ mm. diam. This was subsequently known as the Cattermole or granulation process, and consisted in the agitation of a mixture of pulp, oil, and water, containing a suitable acid, or an alkali with soap or other emulsifying agent, so as to agglomerate the oil-coated particles into granules. The oil was thus employed in a state of emulsion in water in the presence of an emulsifying agent, such as soap. After agitation the mixture was passed into an up-current separator or classifier to remove the lighter non-oil-coated particles from the agglomerated masses of oil-coated particles. The lighter sand having been eliminated, the pulp passed to a second series of agitators to increase the size of the granules, and thence to a second classifier for the removal of the heavy sand. From the bottom of this second classifier some granulated concentrate was recovered, but the heavy sand from the overflow also carried over, with the up-current, a large amount of granulated mineral. This mixture of granulated mineral and heavy sand passed then to a third series of agitators, and thence to a shaking table, where the granulated mineral, rendered more buoyant by directing jets of compressed air onto the surface of the moist pulp, was buoyed to the surface of the water and floated off the bottom of the table, while the gangue sank and was delivered over the end of the table.

In order to give this process a thorough trial, a model plant was sent from England and erected on the mine early in 1904. G. A. Chapman was specially appointed to conduct experiments with this plant, and started a long series of tests early in June of the same year. It was quickly demonstrated that the process was capable of making high recoveries of all the three metals from the very finest slime, whether taken from the current work of the mill or from old accumulations, and also that old tailing or new crude ore were amenable to treatment when crushed to a given fineness. The largest size of particle that could be recovered was ascertained to be about $\frac{1}{2}$ mm., thus confirming the London work; but it was found that results improved with a decrease in size to impalpability.

In the early tests by Mr. Chapman, emulsions of the heavy oil of petroleum were used, but the cost was excessive, and it was found impossible to treat slime successfully. Emulsions of fatty acids, and also soft soap, were then tried, but proved prohibitive as to cost, except in the case of oleic acid. Oleic-acid emulsion was found to act rapidly and effectively on crude ore as well as on all lead by-products, including slime.

Mr. Chapman's work on oils and the results obtained by him with the model plant using the granulation process were satisfactory, but it was thought wise to have these confirmed by an independent chemist, and therefore J. C. Moulden, the company's chief metallurgist at Cockle Creek, was called in, repeated the experiments, and amply confirmed Mr. Chapman's work. Later it was found possible also to reduce the quantity of oleic acid, as was proved by the following tests in December 1904:

Material used was crushed tailing mixed with slime.

Test No. 1. 3.5% oleic acid on mineral and 0.75% sulphuric acid circuit.

The cost of emulsion in this case was 10s. per ton of ore, but the results were excellent, the concentrate being recovered as partly granulated and partly float or froth.

In test No. 2, only 0.75% of oleic acid with the same (0.75%) sulphuric acid circuit, in which case the cost of emulsion amounted to 2s.3d. per ton of ore, the results being excellent, with all float concentrate, no granular material being formed. This test took considerably longer in agitation.

ERECTION OF LARGE PLANT. Mr. Chapman's tests, and their confirmation by Mr. Moulden, established the fact that a process was obtained that would, with suitable arrangements for crushing,

efficiently handle the whole of the by-products of the wet mill, including slime. It was accordingly decided to erect a plant on the lines of the model, with slight modifications as dictated by experience, capable of treating 100 tons per day, operating on a commercial scale.

It was clear, from experiments and observations, that the time of agitation was a factor in the aeration and oiling of the mineral particles. Therefore, reckoning from the size and capacity of the mixers in the model plant, a mixer was built of the following dimensions: 5 ft. deep and 3 ft. diam., with a wooden stirrer 2 ft. 6 in. diam. at bottom placed vertically and made to revolve at the rate of 350 r.p.m.

Experiments with this one mixer unit indicated that, to make the treatment continuous for the stipulated 100 tons per day, it would be necessary to have for the first unit a series of six mixers in order to allow of the proper cleaning of the particles and the thorough aeration of the whole mixture before the discharge of the material under treatment from the last of the series. The mixer was of the core-stirrer type.

Accordingly, the plant was designed on these lines, and consisted of:

1. Grinding apparatus.
2. Vat for emulsifying various oils.
3. Set of six mixers in series.
4. Upeasts for separating sand and float.
5. Second set of mixers for further aeration.
6. Upeasts for further separation of sand and float.
7. Third set of mixers for re-aeration.
8. Wilfley tables for the separation of coarse sand from granulated sulphide.

Early in 1905 the construction of this plant was commenced; it was completed at a cost of £11,000, and started work in July 1905. The method of treatment adopted was on the lines of the tests made in the experimental model plant, and may be briefly described. See Fig. 20.

The ore, reduced to a suitable fineness, was elevated to a hopper at the top of the building and fed into No. 1 mixer, where it was agitated with the solution, the emulsion (previously prepared on the bottom floor) being added at the same time, together with further sulphuric acid, if required. The feed of ground material and the addition of the circuit-liquor and reagents was maintained constantly

and regularly. After passing through the first set of six mixers a pulp consisting of ground ore, acidulated water, and emulsion was passed to a hydraulic-sizing appliance known as an upcast, where the slime-gangue was eliminated by overflowing. The balance of the mixture was passed into the second set of mixers, beginning with No. 7, where more emulsion and sulphuric acid were added if necessary. The agitation and aeration were maintained and the pulp

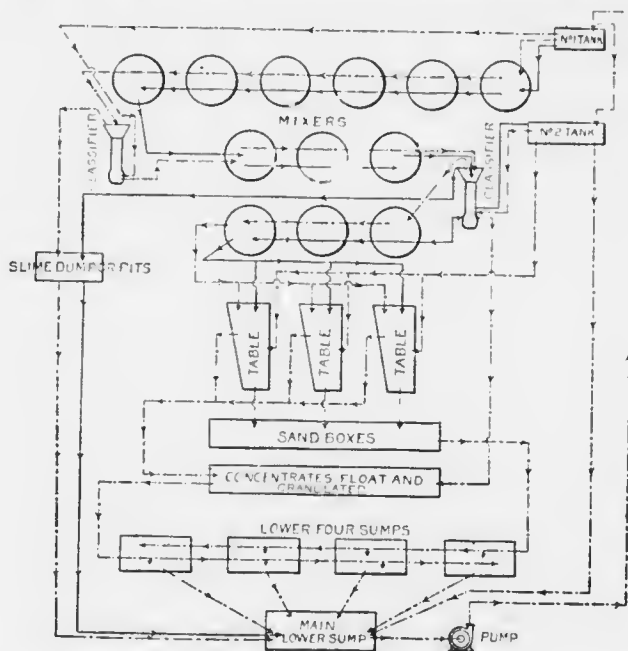

FIG. 20. THE EXPERIMENTAL MODEL PLANT.

discharged from No. 9 into another upcast, where further slime-gangue was eliminated by overflow. The balance of the material was then passed to No. 10 mixer, and thence through No. 12 to the Willey tables. The separation on the tables was effected thus: Such concentrate as had been frothed by the aeration and agitation passed off the table immediately opposite the point of feeding. The granulated or 'air-bally' material remained in close contact with the table, along with the sand, but floated immediately under the influence of puffs of air (supplied through a pipe laid lengthwise and close to the table), and then floated off with the froth concentrate. The sand was delivered toward and at the end of the table, thus

exactly reversing the relative positions of concentrate and tailing as ordinarily obtained if working by gravity concentration. The slime and sand were collected in one receptacle and the float and granulated concentrate in another, the surplus liquors in each case flowing to a common sump for re-use.

From the first day of operation the ease with which the float concentrate could be recovered was very striking; but the separation of the granulated concentrate from the coarse sand by tabling on a large scale was found to be a very delicate and difficult operation, and it was at once evident that 'spitz' separation would relieve the tables. The upcasts were also continually choking and proving a source of trouble, besides sending over large quantities of slime with the concentrate, thus reducing the grade of the product and lessening its market-value.

It was therefore decided, when the plant had been running for a few days only, to construct a small rectangular spitz-box for trial. This was introduced early in August 1905, the feed to the spitz-box being prepared pulp discharged from No. 7 mixer.

It was found also, as soon as the plant started regular treatment, that the agitation was excessive, and mixers 10, 11, and 12 were cut out.

Cone-agitators made of phosphor bronze were tried, then centrifugal stirrers, but the scour both on the stirrer and the sides of the mixer, due to the impact of the sand, was so great that these had to be abandoned, although the agitation and aeration had been considerably increased.

The spitz-box in the slime-overflow circuit gave excellent results, and toward the end of August it was possible to obtain the requisite agitation by using the first six mixers only. A fresh spitz-box was placed in the position formerly occupied by vats 7 and 8, with arrangements for all tailing-flows, both slimes and sands, to deliver to No. 1 hutch of a special spitz on the floor beneath. The object of this spitz (3-compartment) was (1) to allow a settlement of the granulated material in the first compartment; (2) to effect a settlement of middling for re-treatment on tables in the second; (3) to provide for the deposition of clean sand and slime in the third, with an unrestricted overflow for the float material. Sprays on the surface of the liquor, and upcasting jets of water, were provided to assist the operation. Various simplified forms were later adopted as the process merged from partial to complete flotation, as illustrated in the experimental spitz-box for the granulation plant (Fig. 21).

At first the sand was ejected by sluicing out to a dam; but this being wasteful of cirenit-liquor, and therefore also acid, it was decided to construct sand-boxes, through which, in turn, the suspended sand could be deposited—the liquor overflowing from these sand-boxes to be run to the pump-sump and thence re-circulated through the plant. By this means a closed cirenit would be secured, and liquor-losses minimized. It was not until November that these sand-boxes were actually in use. Meantime, it was noted, particularly in slime-tests, that the operation was appreciably assisted by raising the temperature of the liquor. Steam jets were, therefore, introduced into the mixers in the plant early in September 1905.

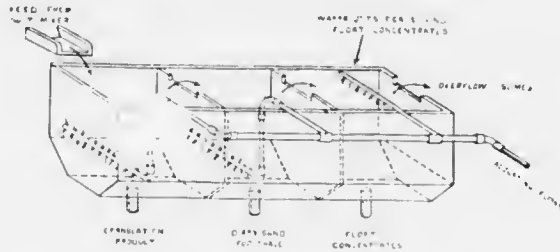

FIG. 21. EXPERIMENTAL SPITZ-BOX.

Before advancing further with the evolution of the process as developed in the first large plant, it is perhaps advisable to refer here to certain experiments that mark a most important era in the history of the process.

DISCOVERY OF THE FROTHING PROCESS. We now come to a stage when a remarkable development in the operation was discovered (strangely enough, at the same time both here and in the Patent Co.'s* laboratory in London), which had for its main principle the reversal of all previous operations, and consisted in the complete flotation of each particle of mineral independently in place of granulating the mineral particles and causing them to sink, thus not only revolutionizing the process, but greatly simplifying and cheapening it. The developments noted were mainly along the line of decreased consumption of oleic acid or oil, for example, from 3% oleic on ore, resulting in very little float, down to 1%, giving practically a complete float.

The following data from a report furnished by A. H. Higgins (March 16, 1905), indicate in more detail the nature of the experi-

*[Minerals Separation Ltd.—EDITOR.]

ments and the effect on the separation produced by varying the percentage of oleic acid.

DETAILS OF EXPERIMENTS

Acid, %	Oleic, c.c.	Percentage of oleic on ore.	Time for aeration, min.	Temper- ature, C.	Remarks.
1.1	15	3.0	4	30.5°	Very little float
1.1	7.5	1.5	4½	31.0°	Rather more float
1.1	5.2	1.04	6	31.0°	Still more float
1.1	3.1	0.62	6	32.0°	Still more float
1.1	1.66	0.32	7	31.0°	Float vastly increased
1.1	0.5	0.10	8	31.0°	Float vastly increased

In every case the oleic acid has been measured in cubic centimetres and the percentages calculated as though they weighed grains; but, as the specific gravity of oleic is less than that of water (taken as 1), all percentages will be lower than those actually given.

These experiments obviously proved that the reduction in the percentage of oleic acid materially altered the type or character of the oiling of the mineral particles—the higher percentage producing granules, which were precipitated, while the lower percentages produced a mineral froth. As the quantity of oleic acid decreased, the time required for oiling the mineral particles and aerating them was found to increase, and more froth formed. These tests, followed by many others, led to Messrs. Sulman, Peard, and Ballot's British patent of April 12, 1905, under which "finely powdered ore, suspended in acidified water, is mixed with a small proportion of an oily substance such as oleic acid, amounting to a fraction of 1% on the ore, and agitated until the oil-coated minerals form into a froth, which can be separated from the gangue by flotation. Heat may be applied to facilitate oiling, and either shaking tables or spitz-boxes may be used to separate the frothy mineral from the sands and the gangue slime."

To return now to the record of operations at the large plant, some successful tests were carried out in September 1905 on dump-slime, by using this flotation method. Agitation was completed in six mixers (using cones) in 0.6 to 1% sulphuric acid at a temperature of 80-90 F. The quantity of oleic acid used in these tests was from 0.15 to 0.2% on the actual dry weight of slime treated. From the sixth mixer the pulp passed "with a good splash" to the first spitz, and the residues from this "with a good splash" to No. 2 spitz, and the tailing from this latter spitz-box was run into dams. These and other experiments emphasized the importance of dropping the pulp

vertically into the spitz to assist aeration and subsequent flotation, and of heating the liquor to enhance the oiling of mineral particles.

The three-compartment spitz-box with upcast water-flows gave place, in turn, to a two-compartment spitz-box without upcast flow, and this, in turn, was replaced by a single-compartment spitz, the latter being provided with a rigid flat board on which the feed was splashed to assist aeration. Conical spitz-boxes were tried, but not generally adopted.

FROM GRANULATION TO FLOTATION. The plant had now been running for a couple of months on tailings and slimes from various sources, and during this time the frothing method was generally ousting the granulation process, until, finally, the superiority of the spitz-box and froth method was clearly demonstrated. The Wilfley tables of the original plant were then dismantled to make room for the sand-boxes already mentioned, and the granulation gave way to flotation with simple spitz-boxes early in October, after treatment of approximately 1700 tons of crude ore, tailing, and slime.

This method of working, thus briefly outlined, quickly established itself as capable of dealing with the company's ores and by-products, and Mr. Chapman's patent of September 1906 was taken out to protect the various discoveries made by supplementing Sulman, Peard, and Ballot's patent (No. 5032, 1905). Under Mr. Chapman's patent:

1. The ore, suitably crushed, is agitated with acidified water in the first mixer and heated.
2. Oleic acid is subsequently added in the second vessel.
3. The pulp is maintained at the desired temperature in the third and following mixers, with violent agitation in each mixer to insure complete and thorough aeration. A sequence of operations is thus arranged by which the solution, after the second agitator, is practically or entirely neutralized, so that the liquor in circuit as a whole is neutral, except at the outset, when the ore is introduced.

The adoption of this flotation process with its neutral liquor allowed the use of iron where formerly, under the granulation method, with acid liquor, only wood or special metal could be used. For instance, the original wooden cone mixers, which had been replaced by centrifugal stirrers of copper or beaters of regulus metal, were now replaced by four-armed stirrers of cast-iron.

A great difficulty lay in the grinding. The experiments had proved that the best work could be obtained on material that would pass through 40-mesh, and that practically the finer the material the better the recovery. The whole experience in the fine grinding

had been with ball-mills in our magnetic plant, and accordingly a No. 8 Krupp dry ball-mill was attached to this plant as part of the equipment. The dry mill proved unsuitable, and, with considerable difficulty, it was converted to a wet mill. Even then its capacity, allowing for numerous break-downs partly due to forcing its capacity, was too limited, and two No. 5 Krupp wet ball-mills were installed to assist. Meantime, experiments proved conclusively that grinding-pans were superior in character of work, cost of maintenance, and power consumed, to the ball-mills for re-grinding tailing, whereupon we installed a grinding-plant which was gradually increased until the ball-mills were thrown out of use entirely. The character of the work was much improved, and it was then evident how much the progress of the process to a satisfactory stage of efficiency had been retarded by lack of efficient grinding appliances.

EXTENSION OF PLANT. The operations of the first plant were commercially and technically successful, and an extension was completed, with all its appurtenances, including grinding-pans for the reduction of the material to the requisite degree of comminution, conveyor-belts for the disposal of the residues, together with bins for concentrates and tanks for storage of liquor, toward the end of 1906, at a cost of £25,000, the sum of £11,000 having been already spent on the initial experimental plant. The total quantity of material treated by this flotation plant was 135,808 tons, which yielded 45,147 tons of high-grade zinc concentrate. The plant continued in successful operation until the completion of the wet-mill zinc section, which was capable of supplying the quantity of zinc concentrate under contract. During the time this plant was in operation numerous tests were made with a view to increasing the aeration, which was recognized as the chief factor in flotation, and at the same time lessening the mechanical energy absorbed in aerating. Among these may be mentioned the nest of centrifugal pumps, as illustrated in Fig. 22. The pumps were worked in series, each one drawing a tailing from the preceding spitz and discharging into the next succeeding spitz. The aeration and flotation were produced satisfactorily, but it was soon found that the scour in the pumps, caused by the gritty nature of the material being pumped, was so great that the heavy maintenance would counter-act the other advantages. Another expedient was to lift the whole of the tailing discharged from the first spitz by means of an air-lift. This also resulted in increased aeration, but it was found that the volume of liquor would have to be increased to an impracticable quantity to

give the necessary velocity to carry the particles of ore, etc., up the rising leg of the pipe and prevent settling. An elevator was subsequently installed in its place to command the third spitz of the series. Further expedients were the insertion of a jet of air into a centrifugal pump used for raising liquors and material for re-treatment, the introduction of a jet of compressed air into the

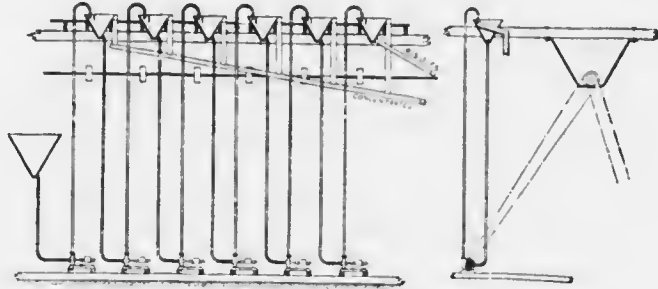

FIG. 22. A NEST OF CENTRIFUGAL PUMPS.

mixer-boxes, and also the insertion of pipes in the mixer-boxes in such a position that air would be drawn into the bottom of the mixer by the rotation of the blades. As a result of all these expedients, the conclusion was formed that the air, to be of value, must be finely comminuted, but that any addition was of value that would decrease the energy required to secure aeration by means of mechanical agitation.

MINERALS SEPARATION PLANT. The Minerals Separation company, owners of the froth patents, purchased the tailing-dumps on the Central mine, and, by arrangement, a plant was designed and erected by the Sulphide Corporation for the treatment. The plant is shown in cross-section in Fig. 23, and was designed on previous experience for the treatment of 2000 tons per week. It was finished at a cost of £26,000 complete. The efficiency of the grinding-pans proved so great with the new design of positive pan that the plant was able easily to handle 5000 tons per week. This plant was responsible for the treatment of 709,999 tons of tailing, etc., and the production of 242,462 tons of concentrate up to the time it was shut-down in June 1911 on the exhaustion of the dumps.

In connection with the Minerals Separation plant, it is important to note that the fact of the circuit being no longer acid, but neutral, has been taken advantage of, inasmuch as there is only one circuit through iron grinding-pans, agitators, and spitz-boxes. The original

granulation plant, being designed for an acid circuit, was equipped originally with wood throughout where liquor circulated, and with dry-crushing ball-mills for the same reason. Later, wet crushing was adopted, but with a fresh-water circuit, kept carefully separate from the acid circuit in which the actual separation took place. The successful development of the flotation process, however, has enabled both crushing and separation to be conducted in one and the same circuit, and has thus greatly simplified operations.

The liquor that was circulated through the Minerals Separation plant was approximately 25,000 gallons per hour. During the

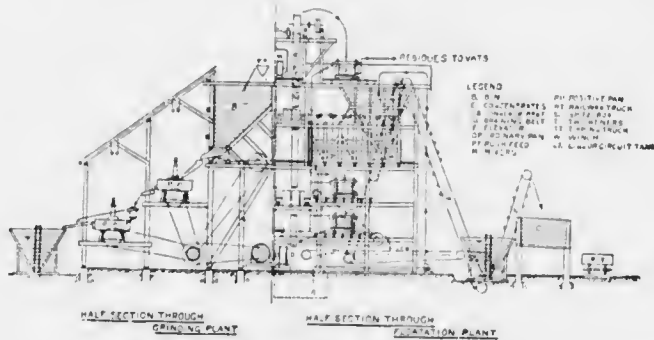

FIG. 23. THE PLANT AT THE CENTRAL MINE.

course of operation, therefore, over 600,000,000 gal.—equal to nearly 3,000,000 tons—has passed through the 12 iron grinding-pans of this plant without detrimental effect. No stronger evidence could be produced as to the freedom of the circuit-liquor from acidity. The maintenance charges on these iron pans are no heavier than corresponding charges on exactly similar grinding-pans in the lead-zinc crusher-section, where fresh water only is used.

Following exhaustive experiments in the laboratory, various media have from time to time been used for long periods on the commercial scale, both in substitution for and in combination with oleic acid. Chief among such media are amyl alcohol, resin-oil, camphor-oil, pine-oil, and eucalyptus, with all of which ingredients good work has been obtained. Thus Nature, in close proximity to the vast bodies of complex ore, has provided the means for the concentration of such ores, for the essential oil of the Australian eucalyptus is one of the best-known media available for the successful exploitation of refractory Australian ores. It is of interest to note here that this

application of an Australian product to the treatment of complex ores is the outcome of a research on the Central mine by an Australian metallurgist, Henry Lavers; and it was also in the milling-plant on the Central mine that eucalyptus oil was first used on a commercial scale for concentration by flotation.

This satisfactory stage having been reached, attention could now be turned to improvements in methods of handling, and, on suggestions from the owners of the patents, it was found that, by connecting the bottom of each spitz-box with the bottom of the next mixer in series, that all the spitz-boxes could be kept on one floor, thus improving the supervision of the work. An experimental plant of this nature was erected at the end of our No. 2 zinc section in September 1910, and, proving highly successful, the system was altered with confidence to this method of working. Experience shows that, for ideal work, the feed material should all pass through 40-mesh, but it is impossible to secure this condition of grinding at all times in the mill, as designed. Moreover, although the Sulphide Corporation was quite aware that improvements in character of plant and methods of operation generally were easily possible, their attention, by force of circumstances, had to be turned sedulously to increasing the production with the appliances at hand. As illustrating what the writer means by ideal grinding, the records of the average assays of residues show continually that where the average in zinc is from 2 to 2.5%, that portion remaining on 40-mesh will assay from 3 to 4% zinc. As illustrating the character of feed, and proving that the process is capable of handling successfully the very finest material, sizing-analyses by commercial screens of the feed to the zinc-section, zinc-concentrate as shipped, and de-leading plant lead-concentrate as shipped, are given:

Feed to zinc section.			Zinc concentrate.			De-leading lead.		
Through	On	%	Through	On	%	Through	On	%
	40	11.2		40	1.5		40	1.9
40	60	21.4	40	60	16.9	40	60	7.5
60	80	19.4	60	80	21.1	60	80	15.8
80	130	15.6	80	130	21.7	80	130	18.8
130	180	7.3	130	180	7.4	130	180	8.5
180		25.0	180		31.4	180		47.5

RESULTS OBTAINED. For comparison with the work of the old mill, the following summary of results achieved by the existing plant will be of interest. This table summarizes work done on a commercial scale in the Central mill over a period of twelve months, ending

December 28, 1912, and demonstrates conclusively the vast improvement in concentration practice made possible by the adoption of the flotation process.

SUMMARY

	Assay value.				Recoveries.		
	Prop., %	Ag, oz.	Pb, %	Zn, %	Ag, %	Pb, %	Zn, %
Lead concentrate ex lead section...	16.0	33.1	67.0	6.7	44.7	72.4	6.1
Lead concentrate ex de-lead plant..	1.4	50.9	62.5	12.5	5.9	5.8	1.0
Total lead concentrate...	17.4	34.5	66.7	7.1	50.6	78.2	7.1
Zinc concentrate	32.7	16.1	8.1	46.4	42.1	15.9	84.7
Total concentrates	50.1	92.7	94.1	91.8

Modifications of the wet mill are now in hand for the improvement of the grinding, but it is felt that, as the proportion of lower-level ore increases, the grinding appliances will have to be increased in order to allow for the finer crystallization of the minerals in the ore as further depth is attained. The writer is of opinion that the figures quoted clearly show that if the ideal grinding is obtained the already high recoveries of metals will be further augmented.

It is unique in the history of concentration that so far-reaching and extensive a development should have reached its present state of perfection in so short a space of time, and more wonderful still that it should prove applicable in an equally masterly manner to so many other classes of ore. There can be little doubt left in the minds of those who have seen this new system of concentration that it must of necessity spread to all parts of the world.

WHAT IS FLOTATION?

By T. A. RICKARD

(From the *Mining and Scientific Press* of September 11, 1915)

Flotation, in its latest phase, is a process of concentrating ores by frothing. When crushed ore, previously mixed with water and a relatively minute addition of oil, is agitated violently in the presence of air, a froth is formed. This froth, rising to the surface of the liquid mixture, is laden with sulphides or other metallic particles, while the earthy material, or gangue, subsides to the bottom. The froth is "thick, coherent, and persistent."*

The formation of this froth depends upon a number of physical causes, of which the buoyancy of oil is the one most generally associated with the flotation process. Surface tension, however, is the phenomenon to be considered first. Then viscosity.

Every millman has had occasion to notice how sulphides are carried on the surface of wash water in a stamp-mill; for example, when water is passed over the dry surface of an amalgamating-table or a vanner-belt. The metallic particles are dry and to their surfaces is attached a film of air that buoys them on the water. To a similar cause is due the loss of 'float gold' in tailing. Most of us learned early that grease of any kind was bad for amalgamation. It 'sickens' the quicksilver, coating the globules so that they do not coalesce but remain in a 'floured' or minutely globular condition. This may account for the loss of quicksilver, but the further loss of gold must be imputed to the fact that the fine sealy bright gold attaches itself readily to the oiled spheres of mercury and is carried with them into the creek.

The surface of any liquid behaves as if it had a film or elastic skin. To this fact is due the variation in the maximum size of drops of different liquids. As the drop enlarges, the strength of this skin is exceeded; then the drop breaks and the liquid falls. When an iron ring is dipped into a solution of soap, it will be seen, on taking it out, that a film of the liquid stretches across the ring. If a small loop of cotton, previously moistened with the solution, is placed on the film left on the ring, this loop can be made to assume, and retain, any form, such as is shown at *A* in Fig. 24. If,

*That is the description given by the Minerals Separation metallurgists, it is a description denied by others, more particularly those using the Callow machine.

however, the film within the loop is broken, the loop immediately assumes the circular form, shown at *B*; and if it is now deformed in any way, on being released it springs back at once to a circle.

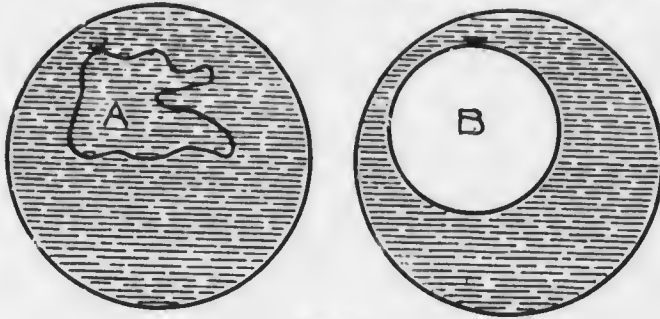

FIG. 24.

These phenomena indicate that the particles at the surface of a liquid have a greater coherence than the particles in the interior of the liquid. The force that does this is surface tension. The experiment with the ring and the loop, for example, is explained by the fact that, in the first place, "the surface tension of the liquid acts equally on both sides of the cotton, but when the film inside the loop is broken, the surface tension only acts on one side, and hence draws the loop out into a circle."[†]

Surface tension can be measured. A framework[‡] (Fig. 25) consist-

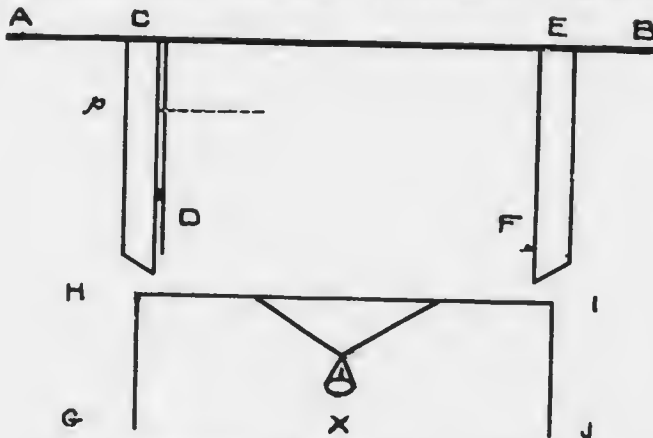

FIG. 25. APPARATUS FOR MEASURING STRENGTH OF FILM.

[†]'A Text-Book of Physics,' by W. Watson, page 191.

[‡]'A Text Book of the Principles of Physics,' by Alfred Daniell, 1911.

ing of a transverse bar $A B$, and two grooved slips $C D$ and $E F$, will allow the piece of wire $G H I J$ to slip freely up and down. The wire $H I$ is pushed against $A B$ and a quantity of the liquid is applied between them. The little pan X is loaded with sand until the wire $H I$ is pulled from $A B$. The minimum force required to do this is mg , the weight of m grams. This weight suspended on the film equals the tension of the film on the wire. If the film stretches until the wire $H I$ is at p , then the film has an area $C E.Cp$. The total weight mg is distributed over the breadth $C E$; whence, if T represents the superficial tension across the unit of length $C E$, then $mg = T.C E$ or $T = \frac{mg}{CE}$

Thus the force of surface tension between water and air has been determined; it is $3\frac{1}{2}$ grams per linear inch or 81 dynes* per centimetre, which being interpreted means that 40 grains would be supported by a film one foot long.

The surface tension of various liquids is as follows:

Liquid.	Sp. Gr.	Tension of surface separating the liquid from	
		Air.	Water.
Water	1.00	81
Mercury	13.54	540	418
Alcohol	0.79	25.5
Olive oil	0.91	36.9	20.56
Turpentine	0.88	29.7	11.55
Petroleum	0.79	31.7	27.8

These are given in dynes per centimetre as determined by Quineke, and recorded in the *Encyclopadia Britannica*. However, a liquid has another characteristic that must not be overlooked, namely, viscosity or resistance to flow. This gives toughness to the superficial film. Water-spiders will run over the surface of a pool like boys on skates over thin ice. The spider's feet do not break through, although each tread makes a dimple on the surface. H. H. Dixon actually measured the pressure exerted by the spider's feet on the water. He photographed the shadow of the dimple and then mounted one of the spider's feet on a delicate balance and made it press on the water until it made a dimple of the same depth as that previously observed.

The next phase of the subject is illustrated by the familiar

*See also page 11 of this book.

experiment with a greased needle. If you place an ordinary needle, say, a lace needle suitable for use with No. 80 thread, on the surface of a bowl of water, it sinks at once to the bottom, in obedience to the law of gravity.[†] If, however, you pass the needle through your hair,[‡] so that it becomes greased, it will float on the water. Why the difference of behavior? In its ordinary state the needle has a film of air attached to it. That film, being loosely held, is readily displaced by the water, so that the needle becomes wetted, that is, its weight causes it to break through the elastic skin constituting the surface of the water. On the other hand, when the needle is greased, the film of air around it is displaced by a film of oil, which is firmly held, because lustrous metallic surfaces have a selective adhesion for oil. Moreover, gases have a marked adhesiveness for oils, so that air adheres readily to the film of oil on the needle. On account of this envelope of oil and air, the needle is not wetted, that is, it fails to rupture the surface. The needle lies in a depression in the surface of the water, but the amount of displacement does not account for the floating. Viscosity, however, may play a part, by increasing the tenacity of the film, the particles of which are so held together, or cohere, that the needle fails to part them. In short, although it is eight times heavier than water, the steel floats.

Another suggestive experiment is that of the grapes in soda-water. Fill a glass two-thirds full with soda-water from an ordinary 'syphon' and then drop two or three small grapes into it. The grapes sink to the bottom, but they become restless almost immediately and soon rise to the surface, one after the other. They do not remain there; first one and then the other sinks. This performance will continue for half an hour, the individual grapes rising and falling, not always the whole way, but maintaining a condition of intermittent activity. They become quiet only when bubbles cease to be generated at the bottom, that is, when the carbonic-acid gas has been driven out of the water by the relief of pressure. By watching, it is seen that the bubbles attach themselves to the grapes and buoy them to the surface, where the bubbles break. Sometimes a couple of grapes will collide and cause the adhering bubbles to become detached, so that one or both of the grapes sink. In the end the bubbles become too few to buoy the grapes, so that the latter rise only part of the way; finally, they lie motionless at the bottom. During the early and

[†]See also pp. 327 and 356 of this book.

[‡]Or even through your fingers.

active part of the performance, the grape will strike the surface of the water and rebound from it as if it were a membrane.

The buoyancy of oil is the physical fact most associated with the first development of flotation, although it is subordinated in the latter phases of the process. Oil has a specific gravity less than that of water, and therefore rises to the surface when mixed with water. The lighter oils range in specific gravity from 0.8 to 0.95, as against the 1.0 of water, so that the margin for buoying particles heavier than water is small. For instance, to make a mixture of zinc sulphide and oil as light as water, it would be necessary, even with the lighter oils, to use from 3 to 15 times as much oil by weight as the blende. This suggests that flotation, even as conducted on the lines of the older patented processes, cannot be due entirely to the buoyancy of oil.

The selective adhesion of oil for particles having a metallic lustre is a decisive factor in the process. It has been said that this adhesiveness is characteristic of sulphides; but it is exhibited by tellurides and by graphite also. Similarly, it has been imputed to 'mineral' and to 'metallic'³ particles, but both terms would include substances outside the range of this phenomenon. Apparently it is the metallic lustre that is the decisive factor, for this would include the minerals especially amenable, such as molybdenite, graphite, the tellurides, and the bright sulphides. The effect of this marked preference of oil for lustrous metallic surfaces is intensified by the fact that gases (such as air) have a similar adhesiveness for oil, so that, if present in water, they will join in preventing the wetting of the metallic surfaces. It is an equally important fact that quartz and other gangue-minerals, having a 'non-metallic' as against a 'metallic' lustre, exhibit the opposite preference: they are feebly adhesive to films of oil, and therefore to those of gas, while they are strongly adhesive to water, that is, they are easily wetted. The reason for this difference is not known; it may belong to the, as yet, mysterious realm of electro-statics, but it is a fact that the curve of contact, or wall-angle, between metallic particles and water is convex while that between earthy particles is concave.

Whatever the reason for this difference, it can be accentuated by

³'Metallic,' in this context may mean minerals with a metallic lustre, including graphite, and 'mineral' may be meant in the sense of ore, the valuable part of the vein or lode, as distinguished from the worthless earthy matter or gangue. In French, *mineral* means 'ore.' Sometimes 'sulphide' is preferred, but that excludes the tellurides and graphite. At least one sulphide without metallic lustre is readily amenable to flotation, namely, cinnabar.

acidulation of the water. "Acidified water has a greater wetting power than neutral water." For this fact also no satisfactory explanation is forthcoming. In some cases, the acid may be supposed to dissolve any coating of oxide on the metallic surface, rendering it more lustrous, while on the other hand, the acidity of the water may give it a corrosive penetration beneath the surface of the gangue.

The addition of acid in quantity produces another effect, namely, effervescence or the liberation of carbonic-acid gas by the reaction with calcite, rhodochrosite, or other carbonates such as are often present in the ore. This generates bubbles that will buoy the metallic particles, whether oiled or not. But water contains air in solution; hence by heating the water, or by diminishing the pressure, it is possible to release the air in the form of bubbles that attach themselves to the metallic particles, like the bladders used by persons learning to swim. Moreover, by a violent agitation of the mixture of ore, water, and oil (if added) it becomes easy to entrain or entangle a large volume of air, which will rise through the mass in the form of myriad bubbles, constituting a foam or froth of varying strength and persistence.

Oil reduces the surface tension of water, that is, between water and air. Pure water has great surface tension, it also has no superficial viscosity; that is why it will not froth. The addition of oil lowers the surface tension and imparts a decided viscosity to the surface of the water. That is why the pouring of oil on troubled waters abates their turbulence. That also explains why the placing of oil in stagnant pools kills the larvæ of the mosquito, which then finds it impossible to adhere to the surface by their breathing-tubes. (See Fig. 26.)

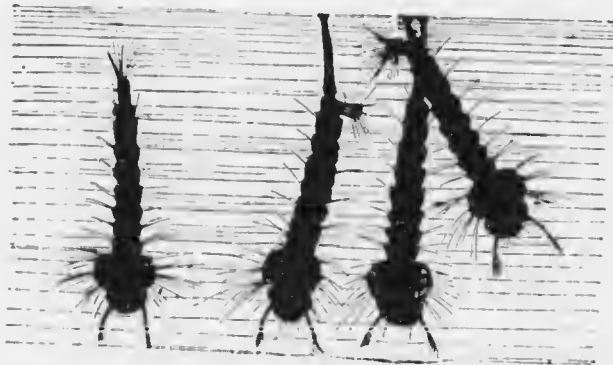

FIG. 26. LARVÆ OF THE MOSQUITO ATTACHED TO SURFACE OF WATER.

Consider the beautiful soap-bubble. The oil of the soap is an impurity that lowers the surface tension of the water; by stretching of the film of the bubble this effect is diminished through the dilution of the impurity, making the film stronger and less prone to collapse.⁴ Thus it renders the bubble more persistent. The bubble therefore is another illustration of surface tension, for it is an elastic skin of water enclosing gas, like a balloon. Here also the property of viscosity comes into play, for the addition of oil to the water, more particularly after exposure to the air, as in agitation, gives tenacity to the superficial film. The combination of low tension and high viscosity enables a bubble, rising through the liquid, to envelop itself in the surface film of the liquid, which the tension of the bubble-film is not strong enough to break, so that the bubble endures.⁵ The noise made by the bursting of a bubble suggests the fact that it is a receptacle of energy.*

The bubble is spherical because the sphere is the shape involving the smallest surface or superficial area. The bubble has an affinity for the instrous metallic particles and adheres to them, as it also adheres to the smooth sides of a glass. This particle of air, or other gas, is enveloped in an elastic skin of the contaminated viscous liquid in which it has been generated and the metallic particles do not break through that skin for the same reason as the greased needle failed to be drowned in the water.

The addition of soluble oils assists the formation of bubbles in the mass of ore and water. These three constituents of the flotation pulp are mixed intimately so as to form an 'emulsion,' such as is typified by mayonnaise. The air present while the emulsion is being made furnishes the gas for the bubbles. In order that they may lift the metallic particles, they must endure long enough to permit complete separation of the metallic particles from the earthy particles, that is, the sorting of the valuable from the non-valuable components of the ore. For the purpose of metallurgical concentration the rate at which the bubbles burst must be slower than that at which they are being formed. An effective froth represents a multiplicity of persistent bubbles. The relative stability of the bubbles depends also upon the kind of oil employed. Pine-oil makes a brittle film; creosote yields an elastic envelope.

By a wonderful correlation of physical forces, the metallic particles become attached to the bubble, made in the metallurgical emul-

⁴C. V. Boys, 'Soap Bubbles,' page 105.

⁵Daniell, *Op. cit.*, page 278.

*See also page 311 of this book.

sion, in such a way as to serve as a protective armor, the particles of varying size interlocking on its spherical envelope. The bubbles without mineral are like a balloon with a weak gas-bag, which is likely to burst, while the armored bubbles are like a balloon with a strong gas-bag, which does not burst. Variety of size among the metallic particles favors the construction of the interlocking mineral coat on the bubble, just as materials of various size help to make a dense concrete. Hence slime is no hindrance.

Intimate mixing is required. The more thorough the mixing, the cleaner the separation of the metallic from the earthy particles. This is said to be due to the complete oiling of the metallic particles, but it is a fact that no oil can be discerned on the concentrate when using the $\frac{1}{3}$ to $\frac{1}{2}$ pound of oil per ton sufficient in most cases for the purpose of the process. The mixing may be beneficial for reasons other than the oiling of the concentratable parts of the ore; it may cause enough friction to clean the metallic surface; it may promote such a solution of the oil in the water as ensures the formation of the right kind of bubbles for a mineral-carrying froth. Heat, by the injection of steam, increases the miscibility, or ability to be mixed, of the oil, thinning it so that it will extend over a larger surface, as butter is warmed to make it spread over pop-corn. Many common oils, such as 'red oil' and other forms of oleic acid, are solid at the ordinary temperature, so that heat sufficient to raise the temperature of the emulsified pulp to about 80° F. is desirable.

To apply this process of concentration, the ore is crushed to the degree of firmness required to separate the metallic minerals from the earthy gangue. This may mean anything from 40 to 200-mesh. The crushed ore is then mixed with water in the ratio, say, of 3:1, although theoretically 2:1 would make a better emulsion; oil is added, say, in the proportion of $\frac{1}{2}$ lb. per ton of ore; and the mixture is agitated violently in the presence of air, by paddles or beaters, by passage through a centrifugal pump, or by jets of compressed air. Acid is not necessary, as we now know,⁶ although it has heretofore been considered requisite. Whether oil is absolutely essential is open to doubt. Agitation of the pulp in the presence of air is the prime factor in producing the desideratum, namely froth. What machines are best adapted to ensure proper agitation is a matter for separate consideration. Aeration of a liquid by agitation

⁶'Flotation in a Mexican Mill,' *Mining and Scientific Press*, July 24, 1915, page 123. Also Charles Butters, *M. & S. P.*, August 21, 1915. See pages 93 and 120 of this book.

in the presence of air and forcing of the air into it so as to form multitudinous small bubbles, producing a froth, is done every day in the domestic operations of the beating of eggs and the whipping of cream.

We have now got our froth. This, as it accumulates on the surface of the emulsified pulp, may be from 2 to 3 inches up to 10 or 15 inches thick. It is so densely coated with the sulphides as to be black, while the gangue that falls to the bottom is so clean as to be white. By skimming, using radial arms or scrapers, or a simple flow, the froth is removed to a secondary receptacle or 'cell,' of the spitzkasten or V-shaped type, where it is cleaned by a repetition of the process, making a high-grade concentrate, while the discard goes back for re-treatment. In short, all that is needed is some arrangement for thorough mixing and aeration, by the use of paddles or air under pressure: then the removal of the resulting froth so that the floated mineral will not drop when the bubbles break. When the froth has been collected, it is filtered, yielding a cake containing about 10% moisture, which may be dried before shipment or final treatment for the extraction of the precious metals.

WHY IS FLOTATION?

By CHARLES T. DURELL

(From the *Mining and Scientific Press* of September 18, 1915)

Some of the fundamental principles of this concentration 'upside down,' as it may be termed, being such a new method, have been overlooked. There has been such a mad scramble to get results in advance of the 'other fellow,' and to penetrate the cloud of secrecy enforced by patent litigation, that there has been little time to answer the question as to why the heavier mineral floats and the lighter gangue sinks. In this buzzing cloud of secrecy the student can distinguish such phrases as 'froth flotation,' 'surface tension,' 'oil-film,' 'DeBavay float,' 'liquid skins,' etc., all of which tend to confuse rather than answer the main question. A few articles in the magazines have given various data, phenomena, causes, and effects, but no definite theory explaining these has been clearly stated.

The action of any flotation machine in successful operation seems quite simple, the mineral floating in preference to the gangue, giving rise to the phrase 'selective flotation.' All that is necessary for the one type of machines is to place the mineral particles gently on the surface of a liquid so that they will not sink or, in the other type of machines, attach to them something of a lighter specific gravity than the liquid so that they will rise bodily to the surface. On the face of it, this is quite simple. Apparently the simplest of all is to attach 'life-preservers' or something buoyant to the mineral particles.

Herodotus describes how "the virgins drew up gold by means of feathers daubed in pitch." Therefore this or an oil, for instance, can be employed to float mineral. The Elmore patents for this flotation, due to the buoyant property of oil, are still in effect. Owing to the large quantity of oil necessary, as well as other things that make this method of no commercial value at present, the only 'why' to be considered in this class of flotation is the selective action, which will be discussed later.

The simplest and cheapest 'life-preserver' is undoubtedly the pneumatic one, which is beyond the time of Herodotus or perhaps even history itself, since eggs and cream were surely frothed before the stylus was known. Any little girl who has helped her mother in the kitchen can tell how any foreign substance, such as a piece of egg-shell for instance, is buoyed up and brought to the surface by

these bubbles. These are bubbles of air, and what could be cheaper for the manufacture of these simple pneumatic 'life-preservers'? It is true that Delprat, with his process, uses carbon dioxide, but this is simply a case of using a by-product that would otherwise go to waste.

Therefore the whole sum and substance of this apparently complex problem of ore concentration by flotation, now surrounded by a cloud of secrecy, consists in either attaching mineral particles to gas bubbles, preferably air, or attaching air bubbles to mineral particles. It amounts to the same thing whether the bubble be attached to the solid or the solid attached to the bubble. In the one case, 'surface tension' type of machine is used for the concentration, while in the other a 'froth' type of machine is used. These will be taken up later.

Therefore the two prime requisites to flotation are:

1. Attachment of bubbles to solids;
2. Creation of selective action of bubbles for metallic particles instead of for the gangue particles.

Since the all-important requisite is the attachment of gas bubbles to solids, it is logical to investigate this phenomenon first with the simplest material at hand—air and water.

Far back in primeval time the progenitors of the fishes made air bubbles that came to the surface of the water and yet we, a few years ago, know but little more concerning air bubbles in water. There was no reason for these aquatic things knowing the ways that air can exist in water but there was no excuse for our building Pachuca tanks, blowing air in at the bottom and then writing a beautiful chemical equation to show that these air bubbles were necessary for dissolving gold. Visible bubbles of air, which have been blown into the water, can in no possible way sustain the life of a fish. Neither can they aid one iota in dissolving gold in a cyanide solution. Nor can visible bubbles of air, introduced into a liquid in this way, be attached to solids to aid in flotation. Available air or oxygen for things of this nature must be air actually in solution. A fish may be breathing freely at the bottom of an aquarium. If the water be warmed so as to expel the air, the fish will rise to the surface and try to jump out. Only nascent hydrogen can unite with arsenic in the Marsh test. In the same way, only nascent oxygen from the dissolved air can act as shown in the chemical equation:

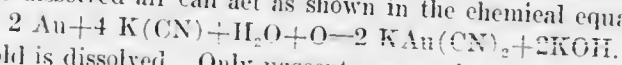

when gold is dissolved. Only nascent gas can be attached to mineral

in the flotation process. This fact is quickly demonstrated by introducing a small jet of air into the bottom of a flask, filled with water, where rests some pulverized ore, the metallic particles of which are in a perfect float condition. Why will the mineral particles, which almost float of their own accord, refuse to attach themselves or be attached to the small bubbles of air? To prove that these same metallic particles can be floated by bubbles of air, it is only necessary to remove the jet and place the flask on a hot plate when they will immediately collect air driven out of solution by the heat and rise to the surface. Some one may here remark, that the rise of temperature of the solution causes enough expansion of the air bubbles already attached to the metallic particles to produce flotation. Anyone familiar with the law of Henry will know this is not the case on noting the greatly increased size of the bubbles. Why, then, cannot air bubbles be attached to mineral particles in the place of nascent or dissolved air?

All great facts, when thoroughly understood, are demonstrable by simple experiments with material at hand. Sometimes when the young man at the soda fountain absent-mindedly forgets to stir your cherry phosphate and sets before you the straws, demonstrate the above fact to your satisfaction while the nascent bubbles of CO_2 form and rise to the surface of the liquid. Crush the straw slightly to reduce the size so that only a minimum of air can be forced through. With this straw, blow air into the colored syrup in the bottom of the glass so as to form a few small bubbles that can be watched closely. These bubbles that come to the surface are colored. Why? The air itself is not colored. Therefore, since the only part of the liquid that is colored, is in the bottom of the glass, the air must be enveloped in the same identical portion of liquid throughout its passage from the bottom to the top of the glass.* In other words, the air bubble, on being introduced into the liquid, is immediately surrounded and inclosed by a film of liquid, which remains with that air bubble throughout its passage just as if it were a part of the bubble. Here is a concrete example of surface tension, a force that can be measured, as explained in any text-book of physics.

This phenomenon is worthy of investigation. The bubble rises to the surface of the liquid by reason of the force of gravity. That is, the force of gravity is greater than adhesion of the molecules of the air for the molecules of the liquid; otherwise the air would remain in the liquid. The molecules of the liquid move freely

*See also pages 316 and 357 of this book.

among themselves according to the definition of a liquid. In other words, the force of cohesion of any single molecule within the liquid is equalized by the cohesive force of other molecules of the liquid. An extraneous force would be required to separate them. An air bubble, for instance, introduced into the liquid, unbalances this cohesive force. It is self-evident that this force of a molecule must act equally in all directions from that molecule. Therefore molecules of the liquid adjacent to the air bubble have their force of cohesion on the one side satisfied by that of adjacent molecules of the liquid; while, on the side of the air bubble, there are no molecules of the liquid to equalize this force. Being statical, this force must be equalized by that of adjacent like molecules in a transverse direction. Since a force of cohesion was already in existence between these adjacent molecules this force is thereby multiplied so that there then exists a greater cohesive force between the molecules immediately surrounding the air bubble than that existing between the molecules in the interior of the liquid. This force is 'surface tension;' it is so great that these molecules of the liquid surrounding the air bubble are firmly held together and torn loose from adjacent molecules of the liquid as the bubble rises to the surface. That is to say surface tension causes the molecules of the liquid to form a film around the bubble and remain with it to the exclusion of like molecules during the time the bubble remains in the liquid. To all intents and purposes, this film is seen to be the same as if it were a membrane of some solid. The air in these bubbles can no more come in contact with the liquid through which it is passing than it could were it inside a toy balloon, for instance. The bubble may be said to be enclosed in a 'liquid skin.'¹ Therefore to attach this bubble to any substance, this liquid skin must first be penetrated or broken. As seen from above, this requires some force.

As shown above, the force of chemical affinity is not sufficient to overcome this surface tension. So then, it could hardly be expected that a mere adhesive force would be greater than this surface tension. Therefore, to attach gas to solids in a liquid, it is first necessary to dissolve the gas in the liquid and then expel it in a nascent state.

¹A striking experiment to show these liquid films is as follows: To a beaker partly filled with a colorless oil, add a small quantity of permanganate solution. Blow air through a finely drawn-out glass tube into the permanganate solution now on the bottom of the beaker. Air bubbles enclosed in the colored liquid film rise through the oil and break at the surface, because of the expansive force of the gas. The colored water drops back through the oil exactly in the same manner that a balloon, bursting, drops to the earth.

There are at present only three known ways of forcing a gas mechanically into solution so that it actually occupies the interstitial spaces of the liquid molecules: (1) beating it in with stirrers or paddles, as is described, for instance, in the patent papers of the Minerals Separation Co., where propellers or centrifugal pumps are used; (2) dividing it into such minute portions that, by capillary force, it is actually taken into solution, as is done in a Callow cell; and (3) introducing it as a surface film surrounding a jet of fluid by means of surface tension, as is done by a method under process of patent.

There are also three methods of expelling dissolved gas from a liquid that are of vital interest to the matter in hand; (1) Super-saturation, so that the excess gas comes out of its own accord; (2) heating, which expels some of the gas by increasing its volume; and (3) reduction of pressure. The present Elmore machines work the pulp in a vacuum, taking advantage of the fact that "at constant temperature, the gas dissolved in a given volume of liquid varies directly as the pressure"—Henry's law.

Since it is easier to work in the open air than in a vacuum, flotation machines using the principle mentioned, of forcing more air into solution than the liquid can hold, are preferable. The second method mentioned, of expelling dissolved gas by heat, aids the super-saturation type of machine in two ways: (1) nascent gas is expelled from the liquid to be readily attached to solids for flotation; and (2) dissolved gas is expelled from the solids so that gas bubbles may be easily attached to them. Here lies the whole secret of flotation.

No solid can be floated unless it contains some dissolved gas. Why? For the reason, explained above, that the enveloping 'liquid skin' cannot be penetrated or broken. It was shown above that a gas bubble is surrounded by a film of liquid. A solid in a liquid is, in the same way, surrounded by a film of the liquid, for the same reason. Therefore, in a liquid, the molecules composing the film around a gas bubble would have no more attraction for those composing the film surrounding the solid than they would have for any molecules in the liquid itself. Hence the bubble would not attach itself to the solid. It is seen then that flotation has for a foundation a subject of which practically nothing is known—occlusion of gases.

It is self-evident that the same cause which tends to super-saturate a liquid with gas will also have the same tendency to super-saturate a solid contained therein. And also the same cause

that tends to dispel from solution the dissolved gas will also tend to dispel the gas from a solid in this same liquid.² Therefore a solid in a liquid becomes a nucleus for the formation of bubbles. This is easily demonstrated by the formation of vapor bubbles when water is boiled.

The surcharging of a liquid with a gas tends to surcharge any solid in this liquid—on account of diffusion. The adhesion of the gas for the solid, therefore, will tend to condense the gas on the surface of the solid. Sufficient condensation will collect enough molecules of the gas to form a bubble on the surface of the solid.

The same effect, due to diffusion of gas in the opposite direction, will be produced by causing the gas to be expelled from either the liquid or a solid contained in this liquid. An example of this is the dumping of a cold ore into the hot solution of a flotation plant. Bubbles immediately tend to form on the ore particles, by reason of cohesive and adhesive forces, and have the tendency to be enlarged by the gas in solution in the liquid.

It is natural, therefore, to suppose that solids with high occlusive power for gases have a greater tendency to float. Here, then, is a cause of selective flotation. Hezekiah Bradford's patent No. 345,951 is the first to recognize this. Speaking of metallie particles, he states: "These floating particles appear to possess some peculiar qualities which repel water from their surfaces, especially when such particles are exposed, even momentarily, to atmospheric air."³ Later this phenomenon caused trouble to, instead of benefiting, Hebron, who says in his patent No. 474,829, an interest in which is assigned to Carrie J. Everson: "I expel from such mineral and metal particles—the air and other gases—by producing as far as practical a vacuum—or, and preferably, by applying heat to the ore, thereby obtaining the desired expulsion of air and other gases."

Why then do minerals (here in these patent papers meaning solids containing metal), and especially sulphide minerals, occlude gases more readily than other solids? It is only necessary to look into the subject of ore deposition for the answer. Primary sulphide ores are changed near the surface to sulphates, carbonates, oxides, etc.:

²"As in the case of liquids, we would expect that the amount of gas adhering to the surface or absorbed in the pores of a solid would vary with the nature both of the solid and of the gas, with the extent of the surface, with the fineness of the pores and lastly with the temperature, becoming less as the temperature rose." Josiah P. Cooke, Jr. 'Chemical Physics.'

³He describes a traveling belt with one end in water to take advantage of this fact. This antedates, and is the same principle as, the Macquisten tubes.

in other words, chemical affinity assists sulphides in absorbing oxygen or carbon dioxide. Hebron and others discovered, by the aid of the microscope, that most mineral particles to be saved by concentration have larger pores and surfaces of larger extent than equal sized 'gangue' particles. This gives a greater chance for gas occlusion, which is another cause of selective flotation.

There is practically no adhesive force existing between oil or fatty substances and water. As a general rule, an oil is but slightly soluble in water or water in oil. Therefore water will not adhere to a surface wetted with oil or oil will not adhere to a surface wetted with water. Also an oil, due to its property of capillary attraction, has that power of entering solids. Therefore, owing to larger surfaces and pores, most metals and sulphides are capable of absorbing oil so that sufficient oil can be attached for agglomeration and flotation. This selective flotation, as mentioned above, is not now worth considering, because so large a quantity of oil is necessary.

Mickle's experiments⁴ showed that none of the minerals tried hot, cold, or with reduced pressure floated on oil under any of the conditions where floating would take place on water. This was to be expected, since the specific gravity of oil is less.

What then is the potent factor for selective flotation? It is the ability to vary the "angle of hysteresis." It has been seen from the above that solids occlude gas which can be expelled from them. If this gas be expelled from them when they are in a liquid at a time when gas is expelled from the liquid, they become the nuclei for the formation of gas bubbles which will float them under certain conditions. Now, therefore, if it be possible in an ore mixture to drive out a considerable portion of the gas from all the particles, there will be insufficient remaining in the 'gangue' to float it while the mineral containing more gas will float to the surface. It has been found, for instance, that sulphuric acid in very small quantity added to water will decrease the angle of hysteresis to that point where quartz and similar 'gangue' will sink, while that of the metallic particles remains practically unchanged.

Since an acid in very minute quantity will produce this effect, it is not due to rise in temperature or reduction in pressure, which would drive out the occluded gas. This must be caused then by no ordinary phenomenon. The only way that an acid can act in this manner is in the capacity of an electrolyte, especially when diluted

⁴Proceedings of the Royal Society of Victoria. Vol. 23. Part 2 of 1911.

⁵Trans. Inst. M. & M., 1912, Presidential Address by H. L. Sulman.

to its dissociation point. That is, complete ionization exists. Yet with this extreme dilution, gas is expelled from a solid contained therein. In other words, equilibrium does not exist. Why? It is on account of these ions of the electrolyte which cause this displacement of equilibrium between the solution and the gas dissolved in the solids within this solution. This then resolves itself into a simple case of osmotic pressure. The surface of the solid is the septum. The ions of the electrolyte enter the solid while those of the gas leave. Since the carrying solution is saturated with gas already, bubbles form; and this action continues until the eutectic point is reached. So far an acid (sulphuric on account of its cheapness) has been used as the electrolyte, because it produces such a great change in the angle of hysteresis.

In the future, as more is learned concerning flotation, the finer and more delicate manipulation will be better understood, permitting an alkaline electrolyte to be commonly used. This will allow of the selective action for mineral particles other than sulphides so that, for instance, cerussite or malachite can be separated readily from gypsum, quartz, etc. This is not to be confused with Horwood's "differential" or "preferential" process, whereby the surfaces of some sulphide minerals are oxidized by roasting to prevent them floating with another sulphide in a mixed sulphide ore.

While, as stated above, the fundamental requisites are the manufacture of 'life-preservers' and the attachment of these to the mineral particles, it is still necessary to resene these particles. Bubbles, on coming to the surface of a liquid, burst if not protected, and the attached mineral particle sinks. Why do they burst? (1) Relief of pressure, so that the contained gas expanding exerts more pressure on the liquid film, (2) adhesive force of contained gas for the atmosphere, or (3) evaporation of the film causes this bursting. The greater the super-saturation, the greater the interior gas-pressure of the bubbles, so that they in reality explode. This is the case with bubbles in a glass of soda-water, for instance. How can this be prevented? The small boy will prevent it by coating the bubbles with soap—that is, by toughening the liquid film. This then is the secret of "the froth-forming material" so frequently mentioned in the various patent papers of the Minerals Separation company. Why is an oil the most useful substance with which to do this?

It has been shown above that metallic particles are readily coated with oil. Therefore, an oil may not only toughen the bubbles but a cohesive force is exerted on the oil-coated metallic particles. Besides

an envelope to hold the gas, and an aeronaut uses a net to strengthen his balloon, so that when the pressure is relieved by the higher atmosphere it will not burst. This same effect is obtained in froth-flotation. In the same way that particles form around drops of water on a dusty floor and prevent the globule from breaking, small particles form a network around the large bubbles. This is due not only to the force of cohesion of the oil on one particle for that on another, but the force of cohesion existing between the particles themselves. Thus a froth is formed of bubbles that do not readily break.

It is a well-known fact that water has the greatest surface tension of all liquids under ordinary conditions, except mercury. It is therefore a safe assumption that dilution with another liquid will decrease the surface tension. The tendency to float is decreased. With reduced surface tension bubbles burst more readily. From this it is easily seen that surface tension is decreased exceedingly by the use of a volatile liquid. Alcohol evaporating from a substance held near a bubble will diffuse sufficiently to readily dilute the surface film and quickly burst it. Mineral particles floated when, for instance, amygdaloidal or globulous eucalyptus oil is used will dance on the surface of the liquid, being apparently attracted and repelled until evaporation has progressed sufficiently to equalize the surface tension not only of the liquid but of the bubbles as well.

Water then is the natural and universal medium for all flotation machines and air the necessary adjunct. The air may be in the pores of the mineral particles and as films around them, so that they are not easily wetted, in which case the machine may take some such form as a Macquisten tube or Henry E. Wood type—a purely surface-tension effect into which enters nothing but water and air. The meniscus of the water buoys up the metallic particles surrounded with an air film that prevents them being wetted. The force of gravity is less than that of surface tension, so the particles float. If the particles be surrounded by a water-film, the cohesion of the molecules of this film for those of the body of water neutralizes the surface tension, and gravity sinks the particles. Or again, minute bubbles may be attached to metallic particles that necessarily contain occluded gas. A thin film of oil may enclose or contain the particles and their attached bubbles. With sufficient displacement the particles will rise to the surface and form what may be termed a DeBavay float. Or, lastly, the bubbles may be large and have the mineral particles attached to them, as well as being attached to each other. This is the so-called froth flotation.

WHAT IS FLOTATION?—II

By T. A. RICKARD

(From the *Mining and Scientific Press* of October 2, 1915)

All of the natural phenomena, or appearances, described at the beginning of the previous article, play their part in flotation and each of them has served as the basis for one or other of the many patents that have involved the subject in a maze of vindictive litigation.

SURFACE TENSION is the idea underlying Hezekiah Bradford's patent of 1886. In this process the dry powdered ore is caused to meet the surface of a still body of water, so that the metallic particles, which are not wetted, are made to float away, while the gangue particles, which are wetted, sink. This was the first application of flotation without the aid of oil.

In 1904 A. P. S. Macquisten invented a tube apparatus in which surface tension is utilized for concentration. In 1906 the process was applied on a working scale in the Adelaide plant at Goleonda, Nevada, where chalcopyrite was separated from a lime-garnet gangue. In 1911 the Federal Mining & Smelting Co. adopted the process for the Morning mill, at Mullan, Idaho, in the separation of blende and galena from a quartz-siderite gangue. At Goleonda 96 tubes treated 125 tons per day; at Mullan, 119 tubes treat 150 tons. The iron tube is 6 ft. long by 12 in. diameter. The interior is cast with a helical groove. The tube is revolved at 30 r.p.m. Success appears to depend upon the angle at which the metallic particles are presented to the surface of the water. Subsequently, the water at Goleonda was slightly acidified, so that it must have caused an ebullition of carbonic acid gas from the lime in the ore. Thus the bubble phenomena may have come into play. Later, small additions of coal-oil were made, so that another phase of flotation was introduced. In the first instance, however, the Macquisten tube was a real surface-tension process.

In 1905 H. L. Sulman and H. F. K. Picard obtained a British patent for a similar process, but it was a failure. As the floating particles are in the nature of a film, or "in patches one particle thick," the area of the separating surface has to be large and still. Moreover, some gangue-minerals are floated as readily as the metallic parts of the ore.

In 1912 H. E. Wood described his method of concentration, by the surface tension of water alone, in a paper read before the American

Institute of Mining Engineers. In common with other metallurgists, he had noticed that dry particles of sulphide minerals are "good swimmers." In all gravity work, we try to drown them. He had also proved for himself that the oxides are easily wetted. Thereupon he devised a machine in which the dry-crushed ore is fed in a thin stream from a vibrating plate onto a current of water. An impetus is given to the surface by small water-jets. By retarding the current the gangue is made to sink, while the film of sulphides remains on the surface. The elasticity and tenacity of this film is remarkable. The process is being applied on a commercial scale to molybdenite ores by the inventor, Mr. Wood, at Denver. He has also made experimental demonstrations on graphite, tellurides, and other lustrous minerals. At the San Francisco del Oro mill, in Chihuahua, Mexico, 12 of his machines are in use on an ore that has defied other efforts at concentration.

BULK-OIL flotation was invented by Robinson & Crowder in 1894 and developed successfully by Francis E. Elmore, whose British patent was obtained in 1898. In the Elmore process the crushed ore is mixed with several times its weight of water. With this pulp a weight of oil equal to, if not exceeding, that of the ore, is mixed gently, so as not to break or emulsify the oil. The oiled mass is run into a spitzkasten, where the oil rises to the surface, buoying the metallic particles, while the gangue and water are removed at the bottom. While oil is described as the prime agent, it is probable that air, entrained by agitation, increased the buoyancy of the concentrate.¹

OIL AND AIR. Coming to processes using a combination of oil and air, we have the Everson patent of 1885. Carrie J. Everson was washing some sacks in which concentrate had been shipped to her brother's assay-office at Denver when she noticed that the sulphide particles floated on the water.* It is said that the sacks had become greasy, but it is quite likely that she used soap, in which case the greasiness is not required as an explanation. In her process the maximum addition of oil, namely, 18%, is less than one-sixteenth of the quantity required for bulk flotation. As to air, that she obtained

¹A suggestion that is confirmed by the statement of Walter McDermott that "in practice [of the Elmore process] the agitation with the pulp results in the oil taking up a very appreciable quantity of air, giving a certain sponginess, with natural increase in floating power." 'The Concentration of Ores by Oil,' *E. & M. J.*, February 14, 1903, page 262.

*This proves to have been a yarn. See page 35 of this book and 'The Everson Myth,' *Mining and Scientific Press*, January 15, 1916.

by the agitation of the pulp by means of two fans radiating from a hollow revolving tube. The result—according to a description written in 1890, not in the light of prejudiced observation today—was the formation of a “thick scum of sulphides” that “rose to the surface and was skimmed off, leaving the hitherto black ore as white as snow.”

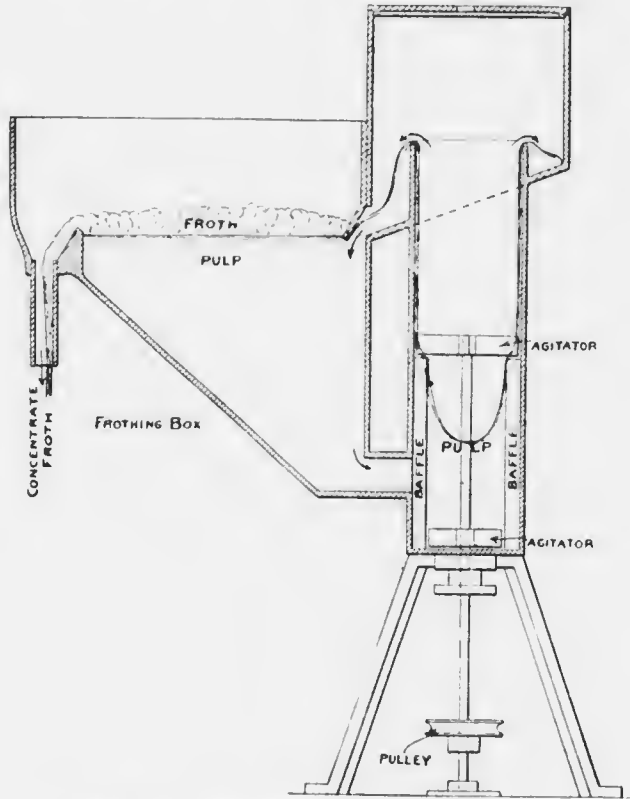

FIG. 27. THE JANNEY FLOTATION MACHINE.

The original bulk-oil process of Elmore had numerous applications, some of which were fairly successful, but in 1904 it was displaced by the Elmore vacuum process, in which flotation by bulk-oil was subordinated to the buoyant effect of air-bubbles generated from the oiled mixture while under a vacuum, and by heating. Under normal conditions water holds in solution an amount of air equal to 2.2% of its volume. This is liberated under a vacuum, but neither the amount of air released (especially at high altitudes) nor the

quantity of oil used suffices to explain the degree of flotation achieved, as measured in weight of concentrate. The presence or the addition of limestone or other carbonates, with the use of acid, suggests the aid of bubbles of gas other than air. The proportion of oil in this process has been decreased gradually from 10 lb. per ton of ore to as little as 2.7 lb. per ton. As the mixing involves violent agitation, it seems inevitable that entrained air plays a part.

To the 'oil and air' process we must add that of Edmund B. Kirby, for which patent was applied in December 1903 and granted in January 1906. Kirby experimented on ore from Rossland, British Columbia. He used a large proportion ("one-fourth to three-fourths as much, by weight, as ore") of oil; he added acid; he employed heat; he "thoroughly agitated"; he "injected air into the mass"; and he obtained "a floating scum of hydrocarbon liquid, air, bubbles, and concentrates." In the light of later events it is claimed that he must have made a 'froth,' because the oil was insufficient to cause bulk flotation and the agitation sufficed to entrain enough air to produce a froth. To this the patentees of the so-called 'agitation-froth' process reply that his "scum" was not a "froth" in *their* sense of the term. That he produced froth seems highly probable; but to say that 'scum' and 'froth' are the same thing, is, in my opinion, not correct.²

BUBBLES. Meanwhile the bubble methods of Charles V. Potter and Guillaume D. Delprat had been patented in 1902. In these processes gas was chemically generated with a view to promoting the flotation of metallic particles in Broken Hill ore. This Australian ore contains calcite, which by the addition of acid, emits bubbles of gas that adhere to the sulphides. Potter used acid, agitation, and heat, while Delprat employed a hot solution of salt-cake or acid sodium sulphate and sulphuric acid. Both processes were successful on a large scale, particularly Delprat's, which is still in use at the Broken Hill Proprietary mine. Neither used any oil. The bubbles attach themselves to the sulphide (blende and galena) particles and carry them to the surface, whence they flow with the liquor into a compartment where, the bubbles breaking, the metallic freight is dropped, and collected as a mixed concentrate. T. J. Hoover says³ that "the result of the manipulation to which the material is subjected

²'Scum' is the impurity or extraneous matter that rises to the surface of a liquid, such as the vegetal film on a stagnant pond or the dross on a bath of molten lead. 'Froth' is a multiplicity of bubbles.

³'Concentrating Ores by Flotation.' Second Edition. Page 101.

is the formation of a dense froth of bubbles and mineral"; but this was published in 1912, and must be read in the light of events long subsequent to the claims made by either Potter or Delprat. In order to explain the making of froth without oil, he suggests the presence in the ore of such substances as "yield gummy organic compounds that selectively adhere to the ore." This is an important suggestion. Be that as it may, the Potter and Delprat methods demonstrate that flotation is practicable by the aid of bubbles without the addition of oil.

In the Froment process, patented in Great Britain and Italy in June 1902, the bubble idea is dominant, for, while Aleide Froment used oil, he employed it to attract the bubbles of gas generated by the reaction between acid and calcite, adding the latter if suitable carbonates were lacking in the ore. He emphasized the fact that not only have the lustrous metallic particles an affinity for films of oil, but the oil itself attracts bubbles of gas, both air and carbon dioxide. He recommends much less oil than had hitherto been used, namely, a "thin layer of oil," which has been interpreted, according to the exigencies of litigation, to mean anything from less than 1% up to 14%, according as the Froment patent was being upheld or attacked. In Froment's later instructions to the purchasers (Minerals Separation, Ltd.) of his patent he mentioned the quantity as from 1 to 3½%. For a 5% sulphide ore, the oil would weigh 20 lb. per ton. This question of the quantity of oil required by Froment has been much discussed, but the dominant idea in his mind appears to have been the affinity of oiled particles, necessarily sulphides or lustrous metallic particles, for bubbles of gas. These he obtained by agitation (air-bubbles) and by adding both acid and calcite (bubbles of carbonic acid gas) to the pulp. As to what "a thin layer of oil" may mean, I do not know what Froment intended by the expression, but the scientific meaning of the phrase is indicated by the fact that oil when dropped on the surface of water will spread out in a film one molecule thick.⁴

The agitation of the ingredients specified by Froment will produce a froth; therefore, to the detached onlooker, it is difficult to distinguish the essentials of his process from those claimed in the basic patent of Minerals Separation. Mr. Sulman called the Froment froth a "tender and evanescent assemblage of bubbles of carbon

⁴'Oil Films on Water and on Mercury.' By Henri Devaux. Translated and published in Annual Report of Smithsonian Institution, 1913. Also *M. & S. P.*, July 31, 1915, page 156.

dioxide carrying mineral," but if it carried mineral I do not see that his refusal to call it 'froth' is of any great consequence to those of us who are not interested in the litigation.

COAGULATION. Here we come to what is apparently a break in the sequence of inventiveness, for, beginning with November 1902, Arthur E. Cattermole obtained a succession of patents for a process in which the idea of oil-selection is used to sink the metallic particles of an ore, not to float them. To an acidified pulp he added from 4 to 6% "of the weight of metalliferous matter present," not of the ore as a whole: therefore, with a 12% zinc ore this would mean 0.48 to 0.72%, say 10 to 15 lb. oil per ton of ore; and with a 2% copper ore, it would mean only 1½ to 2½ lb. of oil. But this oil "is brought into the condition of an emulsion in water containing a small percentage of soap or other emulsifying agent." These are the words of his most important patent, U. S. No. 777,273, dated December 13, 1904, but in his first patent, British No. 26,295, of November 28, 1902, he gives the proportion of soap as 2%. When this mixture of ore, acidulated water, and soapy oil is agitated violently the metallic particles are agglomerated into flocculent masses that sink, the separation from the gangue being then effected by an up-current of water. To facilitate the separation, the mixing was conducted in two stages, of which the second is said to have been "a rolling form of agitation." Cattermole called his agglomerate a 'granule'; Froment called it a 'spherule.'

FROTH. The Minerals Separation company was organized in 1903 to acquire the Cattermole invention and thereafter his patents became part of the property of that company. The first and only plant to use the Cattermole process was erected on the Central mine at Broken Hill,⁵ where it was soon displaced by the so-called agitation-froth process of Sulman, Picard, and Ballot. These gentlemen have testified that they made their discovery by experimenting with the Cattermole process, applying scientific methods of research, based on the fact that sometimes "loose flocculent masses of partially granulated sulphides" would rise, instead of sinking. Finally, they decided that this was due to insufficient oil. The actual experiments were made by Arthur H. Higgins, who, by diminishing the amount of oil to 0.62% on the ore, caused so many of the metallic particles to rise that a high recovery was obtained by flotation. H. L. Sulman says that by reducing the amount of oil the granulation was stopped and "co-

⁵'Flotation at Broken Hill.' By James Hebbard. *Mining and Scientific Press*, September 4, 1915. See page 110 of this book.

incidentally a mineral froth began to take its place." This was in March 1905. Whereupon the British patent of Minerals Separation No. 7803, of April 12, 1905, was taken out by H. L. Sulman, H. F. K. Picard, and John Ballot, and subsequently they obtained the U. S. patent No. 835,120 of May 29, 1905, issued on November 6, 1906. In this patent reference is made to the Cattermole patent and it is

J. M. HYDE.
ART OF CONCENTRATION OF MINERAL SUBSTANCES.
APPLICATION FILED NOV 10, 1911.

1,022,085.

Patented Apr. 2, 1912

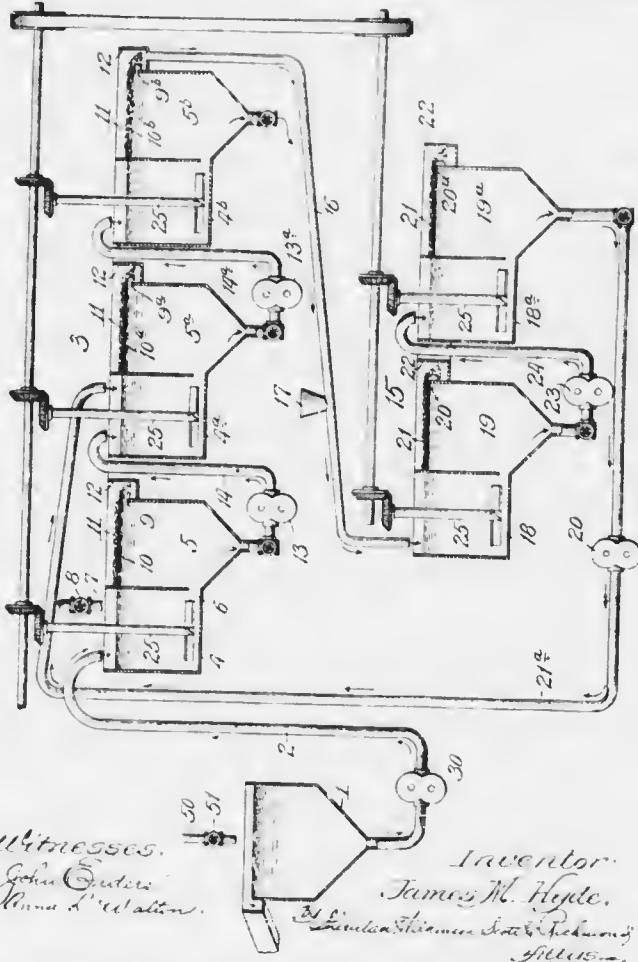

FIG. 28. FACSIMILE OF HYDE'S PATENT, AS USED AT THE BUTTE & SUPERIOR MINE.

claimed that the 'granulation' characterizing his method is stopped by reducing the amount of oil to "a fraction of 1% on the ore" and that by vigorous agitation the oil-coated particles are caused "to rise to the surface of the pulp in the form of a froth or scum." The use of 'scum' here is unfortunate for Minerals Separation, for it tends to identify the 'froth' made by this process with the 'scum' made by most of their predecessors in the art. In this patent acidulated water, warming of the mixture, oleic acid from 0.025 to 0.5% on the ore, oleic-soap solution, the formation of the froth, and the separating of the froth from the remainder of the solution are specified. Since this patent was issued the process has been applied successfully, and on a large scale, in many parts of the world, notably Broken Hill, Great Cobar, Great Fitzroy, Chillagoe, and Wallaroo, all in Australia; also the Braden copper mine in Chile; and more recently at the Inspiration, Anaconda, and other important mines in this country. It is proper to add that a froth-flotation process is used successfully at the Butte & Superior, Miami, and other mines, but the users deny that it is a method to which the Minerals Separation company has proprietary rights. The difference of opinion is yet to be settled by the Courts.

In the foregoing review, I have omitted reference to a number of flotation patents, some of them interesting, because the multiplication and repetition of detail would be only confusing. It will be noted that the amount of oil per ton of ore has decreased from over a ton⁶ to less than half a pound. From an insistence upon the use of acid in all the patents, even to the last quoted in the above summary, we come to the recent fact of flotation in alkaline solutions. Indeed, in the case of the Mexican mill we are told that the deleterious effects of soluble sulphates was overcome by an excess of oil.⁷ How much of the oil used in the prior art was due to excess of acid, it remains to be stated by an independent investigator. Much of the early work with flotation was done on Broken Hill ore, which contains a notable proportion of carbonates, hence the addition of acid proved a help, by generating gas, not only in the Potter and Delprat processes, but in others also, namely, those using oil. One ingredient, however, has gained progressively in importance: air. Other gases have had their day, some generated chemically, others electrolytically,

⁶'Note on the Elmore Concentration Process.' By Charles M. Roiker. Trans. Inst. M. & M., London. Vol. VIII, 1899-1900, page 382.

⁷*Mining and Scientific Press*, July 24, 1915, page 124. See page 94 of this book.

but in the latest phase of the process the prime agent is air. Indeed, the good results ensuing from the lessened proportion of oil may be due to the fact that the less the oil the greater the intensity of agitation required to spread it throughout the pulp.⁶ The vigorous

H. L. SULMAN, R. H. GREENWAY & A. H. HIGGINS.
ORE CONCENTRATION.

APPLICATION FILED APR 30, 1909

962,678.

Patented June 29, 1910.

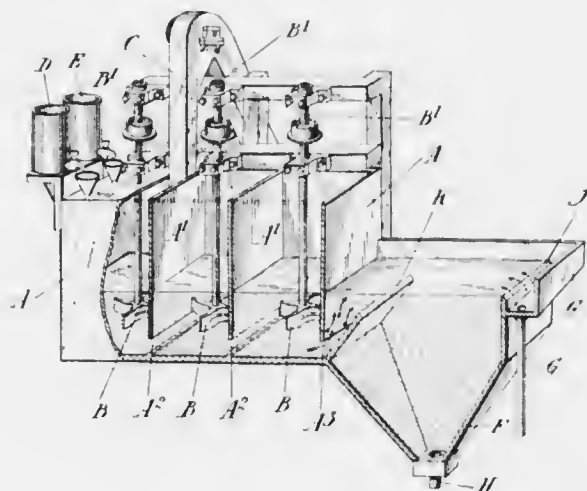

In witness
J. M. H. H. H. H.
6/3/10

In witness
H. L. Sulman, R. H. Greenway
& A. H. Higgins
Attorneys

FIG. 29. ONE OF THE MINERALS SEPARATION PATENTS.

⁶Dudley H. Norris has several patents for the use of water containing, in solution, air under high pressure for intensified bubbling, with or without oil.

agitation, so often emphasized, may have been like the shot that was aimed at the crow and killed the pigeon, for it must have done more than mix the ingredients: it resulted in entraining and atomizing a large volume of air. The later history of flotation suggests that a day may come when the oil, like the acid, will be found non-essential, and in its place will be added the ingredient that supplies the substance required for making bubbles. To make bubbles the surface tension of the water in the flotation-cell must be decreased by a contaminant and at the same time the viscosity of the liquid must be strengthened. Oil is not the only substance that can perform these functions. Some alkaline compound may be found that will do the trick. In the Cattermole, Sulman & Picard patent (U. S. 777,274) a fatty acid is produced *in situ*. In another patent, by Sulman, Greenway & Higgins (U. S. 962,678) a claim is made for "an organic compound contained in solution in the acidified water" as a soluble frothing agent. In U. S. 1,055,495, Schiek claims the use of carbon tetra-chloride to promote 'levigation,' or flotation. In U. S. 770,659, Seammell employs sulphur dioxide as a means for increasing the viscosity, and in U. S. 744,322, Foote uses slaked lime. Among other nostrums, alcohol, phenol, camphor, amyl acetate, benzoic and lactic acids, and calcium chloride have been suggested in various patents. In some cases, possibly, an ingredient of the ore itself may suffice. Meanwhile the element of time essential to a good formation of froth suggests that the delay is useful in increasing the viscosity. Mere speed of agitation and aeration does not seem to suffice. But sub-division of the air helps. This reminds us that T. J. Hoover and Minerals Separation took out a patent, in Great Britain in 1910, for the introduction into the oiled pulp of air and other gases through a permeable medium, but it was not deemed worth while to obtain a patent in the United States. Knowing nothing about this, J. M. Callow hit upon the same idea and designed the porous bottom now in use at many flotation plants. Cattermole used an ordinary cone or Gabbett mixer⁹ fitted with baffles. Froment employed a mixer of the egg-beater type. Sulman & Picard in one of their patents (U. S. 793,808) suggest an agitator made of a coil of perforated gas-pipe, through which compressed air and oil are fed. Centrifugal pumps, Pachuca agitators, air-jets, and pans with mechanical stirrers have been adopted by various inventors. Other devices for causing agitation and promoting aeration of the pulp have been, and are being, introduced.

⁹See Fig. 41.

SURFACE TENSION AND SALTS IN SOLUTION

(From the *Mining and Scientific Press* of October 9, 1915)

The Editor:

Sir—In your editorial on 'Flotation at Broken Hill' in your issue of September 4, 1915, page 343, you made a statement regarding surface tension that is rather befogging to a student of flotation. It is as follows: "Mr. Hebbard says that the surface tension was increased by the salts introduced, but we venture to suggest that the opposite was the fact."

Surface tension has been threshed out pretty thoroughly by articles appearing in the *Journals of the American Chemical Society*, beginning in 1908.

Jour. Am. Chem. Soc.,	Vol. XXX,	No. 3,	March	1908
" " " " "	" " "	" 7,	July	1908
" " " " "	XXXIII,	" 3,	March	1911
" " " " "	" " "	" 5,	May	1911
" " " " "	" " "	" 7,	July	1911
" " " " "	XXXV,	" 10,	October	1913
" " " " "	" " "	" 11,	November	1913
" " " " "	" " "	" 12,	December	1913

These articles deal with the drop-weight method (weight of a falling drop) for the determination of molecular weight, critical temperature, and surface tension, and they describe the apparatus used. The work was started by Morgan and Stevens, who wished to investigate what had become known as the law of Tate.

Tate, in 1864, had made a generalized statement about the relation of weight of drop to diameter of tube, the weight that could be raised by capillary action, and the temperature of the drop. Some of their conclusions are that:

(a) The drop-weight of any liquid is proportional to the diameter of the dropping-tube. These tubes are uniform in diameter, thus differing from the ordinary burettes.

(b) The weight of a drop, other things being the same, is proportional to the surface tension of the liquid.

(c) That it is possible to calculate the temperature at which the drop-weight would become zero, namely, the critical temperature of the liquid, for at that point the drop would disappear, there being no distinction between the gas and the liquid.

In the course of these experiments the surface tension of a number

of organic liquids in aqueous solution was determined by drop-weight and found to range from 21 up to that of water. The tabulated results cover several pages in the *Journal*; I have copied a part and condensed into one table, which is given below.

AQUEOUS SOLUTIONS AT 30°C.

—Ethyl alcohol.—		—Methyl alcohol.—		—Amyl alcohol.—	
%	Sur. ten.	%	Sur. ten.	%	Sur. ten.
0.000	71.030	0.000	71.030	0.000	71.030
0.979	65.600	1.011	68.120	0.250	53.712
2.143	60.847	2.500	64.845	0.500	46.157
4.994	53.137	4.997	60.294	0.750	41.247
10.385	44.668	9.994	53.661	1.000	37.631
17.979	37.311	10.000	48.817	1.500	32.504
25.000	32.941	25.000	41.809	2.000	28.667
50.000	26.521	50.000	31.843	2.498	25.726
75.000	23.850	75.000	26.173
100.000	20.756	100.000	21.037	100.000	22.296

—Acetic acid.—		—Formic acid.—	
%	Sur. ten.	%	Sur. ten.
0.000	71.030	0.000	71.030
1.000	67.756	1.000	69.816
2.475	63.995	2.500	68.024
5.001	59.435	5.000	65.706
10.010	53.500	10.000	62.061
14.980	49.451	15.000	59.197
20.090	46.455	25.000	55.190
49.960	37.109	50.000	48.112
79.880	31.026	75.000	41.990
100.000	25.725	100.000	35.281

It is to be noted that in all cases the very first addition causes a very considerable lowering of surface tension. The decrease in the surface tension of water caused by the addition of a very small amount of amyl alcohol is especially striking. Thus the presence in solution of even so small an amount as 0.25% changes the surface tension of water from 71.03 to 53.7, or nearly 25% at 30° C.

Morgan and Schramm studied many concentrations of a few salts. They selected the molten hydrated salts for this purpose; those salts which melt below 50° in their own water of crystallization being especially satisfactory for this purpose, for the reason that concentration in some of these cases could even be carried to supersaturation.

In the case of the salts which they studied it is plain that surface tension is increased by the salts introduced. Where calcium chloride

was used, the surface tension was increased from 71.03 to 102.57, approximately 50%. Taking a few specific cases it is noted that to increase the surface tension 10% it would take

- 20% CaCl_2 at 30°
- 43% $\text{Zn}(\text{NO}_3)_2$ at 45°
- 29% Na_2CrO_4 at 30°
- 34% $\text{Na}_2\text{S}_2\text{O}_3$ at 40°

The diagram is appended. See Fig. 30.

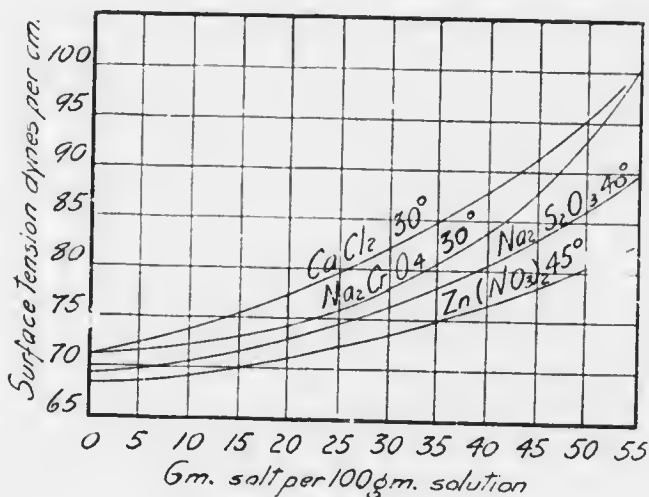

FIG. 30.

The degree of accuracy of Valson's early generalization that equivalent salt solutions exhibit identical values of surface tension is shown by plotting the same results reduced to molecules of water to molecules of salt. But one must be careful not to carry generalizations too far because this does not hold with some salts. The diagram is appended. See Fig. 31.

The fact is that some salts elevate while other depress surface tension, but the former predominate. In addition to the salts just mentioned, the tartrates, carbonates, oxalates, citrates, lactates, and a part of the acetates raise surface tension; while the salicilates, the butyrates, part of the acetates, and all the acids lower surface tension.

It is suggested that the liberation of free acid by hydrolysis in the case of salts or weak acids may cause their negative effect on water.

All acids lower surface tension, and in the case of the fatty acids experiments have shown that the lowering is proportional to the carbon content of the acid.

It is suggested in these researches that the surface tension of a

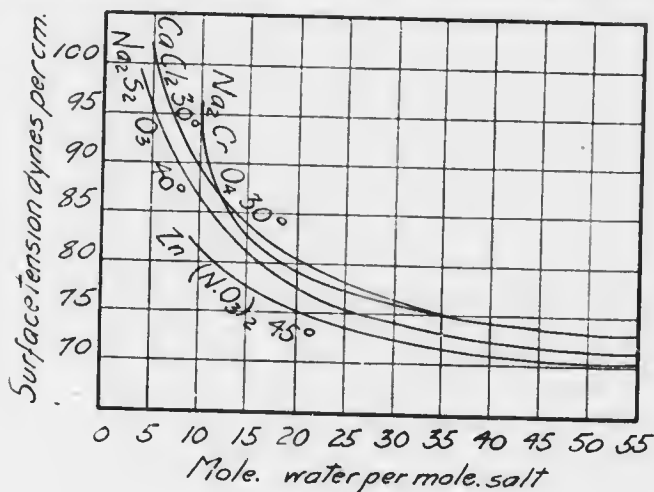

FIG. 31.

solution of two salts one of which raises the surface tension and the other lowers it, is an additive property of the two solutions—provided no chemical reaction takes place between them, and the values of the two are not far removed from the value of water. If one of the solutes causes a much larger effect than the other, the value of the mixture lies closer to the one with the greater effect.

Regarding the variation of surface tension with temperature, it is made clear that surface tension increases with decrease in temperature

In reviewing the subject of flotation in one of the mining journals about two years ago, a leading educator made the statement that heat increases surface tension. Now this is absolutely erroneous in case of pure water and it is not likely that it would maintain in any case. I do not mention this in a fault-finding spirit, but to show that in the science of flotation the metallurgical engineer faces problems in physics and chemistry that are absolutely new to him.

In the work in the chemical journals the surface tension of pure water is taken as 71.03 dynes per cm. at 30°, 69.33 at 40°, and 68.46

at 45°, while Hoover† uses 81 with apologies. Again Hoover makes a slip on page 77 where he says that surface tension of water has been determined to be a force of 81 dynes per square centimetre. Here he has confused surface tension in dynes per centimetre with surface energy in "ergs per sq. cm." Work (in ergs) is the act of producing a change in opposition to a force (in dynes) that resists this change. Now, gravity gives to a gram a velocity of 980 cm. per second. It is therefore equal to 980 dynes. Hence if one gram be lifted vertically one centimetre, the work done against gravity is 980 ergs. Books on physics demonstrate that surface tension (dynes) per unit-width is numerically equal to surface energy (ergs) per unit-area. We should therefore speak of surface tension in dynes per centimetre, and surface energy in ergs per square centimetre.

The above figures on surface tension and surface energy might be applied to the so-called surface tension method of flotation, such as the Wood machine, where the ore is fed dry onto the surface of water and at one place at least, in the West, where the wet oiled pulp is spread upon the surface of water in a spitzkasten.

While 0.0724 gm. (71.03 :- 981) per sq. cm. represents the weight that it requires to just break the surface membrane of pure water, there is another factor, and that is the size of the dimple formed. Take the case of galena. The buoyant factors are the membrane and the water displaced. Taking the specific gravity of galena at 7.5, the maximum volume of a dimple on one square centimetre would be 0.0096 cc. (0.0724 :- 7.5) or a displacement equal to 0.0096 gm. water. Adding the two quotients we find that 0.082 (0.0724 + 0.0096) gm. galena per sq. cm. would just break through. This is not mathematically correct, but a close approximation—sufficiently close,‡ because we do not know the volume of the foreign water attached and the condition of the water.

WILL H. COGHILL.

El Paso, Texas, September 24.

†'Concentration of Ores by Flotation,' 2nd edition.

‡See page 348 of this book.

AIR-FROTH FLOTATION

(From the *Mining and Scientific Press* of October 16, 1915)
A LEGAL VERSION OF THE TECHNOLOGY OF THE PROCESS

[Herewith we give a part of the address made by Mr. Walter A. Scott, counsel for defendants in the case of *Minerals Separation v. Miami* recently tried at Wilmington, Delaware. We give this not only because the learned gentleman discusses the underlying principles of the flotation process in an interesting way but because the questions put by the Judge are such as would suggest themselves to other persons enrious to understand the subject. In reading this excerpt from the court proceedings our readers must not forget that it is an *ex parte* statement, putting forth the technology of the subject with a view to aiding the ease for the defendant. Mr. Scott assumes that oil is necessary to flotation and also that the force of surface tension bursts the bubbles. Neither of these assumptions can be taken for granted in a scientific disecussion, however usefui they may be in a lawyer's brief.—EDITOR.]

The manifestation of the force of surface tension is a phenomenon that shows itself as a tendency of any liquid body—we may confine ourselves to a liquid—to assume that shape in which it has the least surface. It is a well-known fact that in the form of a sphere the ratio of surface to volume is at the minimum. Therefore we can say that surface tension is that force or property which tends to cause a body of liquid to assume the spherical form, in order to make its surrounding surface as small as possible.

We are familiar with manifestations of this force; when a drop of water falls upon a hot stove, we see it immediately come into the form of a little sphere. The explanation of that probably is that the stove, being hot, generates a little steam all around the particles, and that frees it from interference by other forces, so that it assumes the shape which surface tension tends to give it.

I think the ordinary shot-tower, where molten lead when poured or dropped assumes the spherical form of shot is probably another manifestation of surface tension. The lead, instead of dropping in a formless mass as it passes through the air, under the influence of the contractile force around its surface is drawn up into a spherical body.

Another illustration is the tendency which we observe when water

is spilled, we will say, upon a smooth surface or table. Were it not for surface tension it would spread out in an infinitely thin layer; gravity would tend to pull it down flat. But surface tension causes it to assume the form of a little bulge of water on the table. Viscosity of the water probably also plays a part in that. It is difficult to disentangle all of these causes. But surface tension surely is one of the forces to enter into that effect.

Now, this surface tension exists not only at the free air-surface (for instance, the surface of the water in this glass) but it exists at every point where there is a change of medium, that is, where the water encounters another substance. Surface tension here is along the water surface, the air surface, but that surface tension exists clear around the inner surface of the glass and at the bottom of the glass; it has the same relation to the water around the glass and at the bottom of the glass as next the atmosphere above. So this surface tension exerts itself about the entire surface of a body of liquid, tending to draw it into a spherical form.

As we observe a bubble—for instance, a soap-bubble—the idea that we are apt to have is that the bubble bursts from an interior force; that is, that it explodes. We are accustomed to that thought in connection with any explosion or bursting. I apprehend from the testimony of these experts that a lessening of this contractile force, or the surface tension, tends to permanency of a froth; from that fact I apprehend that the force causing a bubble to burst is not an expansive force from the inside, but that it is due to surface tension, if the surface tension is strong enough. For instance, imagine a soap-bubble, we will say, three inches in diameter. It is surrounded by a very thin film of water contaminated or modified by soap. The amount of water in that film which surrounds the air inside of the bubble is, as we may well imagine, very small. The ordinary soap-bubble bursting upon this piece of paper would hardly leave a visible sign of water. Now, as that bubble exists as a bubble the surface of that very small amount of water is very large. It is the entire outer surface of that bubble and the entire inner surface, where the film comes in contact with the exterior air and where it comes in contact on the inside with the enclosed air. Now, over that immense surface, for it is truly immense in consideration of the small amount of water, there is this contractile force, as if around the bubble there were stretched a sheet of rubber constantly drawing inward to make that bubble smaller, and the effort of that force of surface tension to reduce the area of the water forming the film

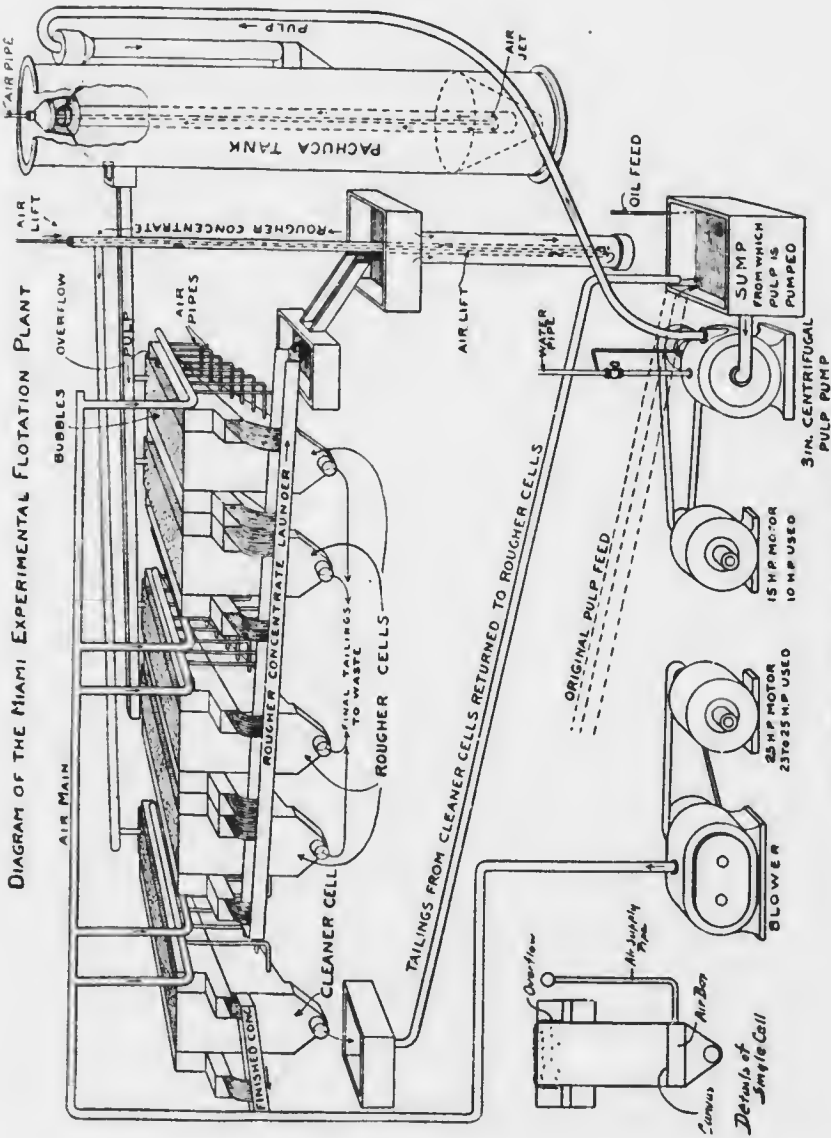

of the bubble, simply pulls it in, bursts it, reduces it to a drop, which has the minimum of surface. So I apprehend that the reason the bubbles in these froths burst is on account of that shrinking inward, that tendency of surface tension to gather the water into the smallest possible compass.

The experts who have testified in this case say (and their views are in harmony with the literature on the subject) that any substance which tends to lower or lessen the surface tension of water tends to make the bubbles or the froth more persistent or permanent; and in view of what I have said, I think the reason why these modifying agents which lower the surface tension of water also tend to make the froth more permanent is clear. In the case of pure water, having a surface tension which I think is—well, it is arbitrarily represented by some numeral—we can say 1. It makes no difference. Now, that force of surface tension in clear water is strong enough to burst these bubbles. It pulls in and bursts them. But if the water is modified by some agent, such as an oil in emulsion, or a soluble substance, such as phenol or cresol, that contractile drawing-in force is lessened, and therefore the bubble has greater longevity, can exist longer, because there is not this constant pulling in. So, while this surface tension manifests itself in various ways and has been utilized in various ways, so far as this bubble flotation or froth flotation is concerned, I think it is clear why a lowering of that surface tension tends to permit a bubble to exist longer. And all of the experts in this case are in perfect agreement that an insoluble oil mixed up, or emulsified, lowers the surface tension in precisely the same way that a dissolved substance does.

The phenomenon of the flotation of small particles upon the surface of water, as upon the surface of water in that glass, has been referred to as surface tension flotation or skin flotation. That is a matter of arbitrary nomenclature. The surface tension effect does not enter into that effect any more than it does in bubble flotation. This stretched membrane, as we picture it, surrounding a body of liquid and tending to draw it into a small compass, also has the property of supporting a small particle upon the upper surface of a body of water, but the name 'surface tension' should not properly be restricted to that kind of a flotation, because the surface tension phenomena enter into all flotations, and it is the lowering of that surface tension that leads to the formation of these froths which have more or less permanency.

* * * * *

Besides these various prior art patents and publications that I have referred to, in which the lowering of surface tension is utilized for the purpose of giving permanency to a froth or a bubble, we have other patents, I believe owned by the complainants in this case, patents issued to scientific men, technical men, the officials connected with these companies, in which they also explain the use of both soluble and insoluble reagents for the purpose of contributing efficiency to a bubble or froth process.

Notable among those is patent 788,247, which is in evidence.

Patent 788,247 was granted to Cattermole, Sulman, and Picard. Sulman and Picard are two of the grantees of the patent in suit. Now, in this process—

THE COURT (interposing): What is the date of that patent?

MR. SCOTT: The date of the grant was April 25, 1905; the date of the application was March 29, 1904. In their statement of invention in patent 788,247 they say:

“Our process has for its object the separation of minerals from silicious or earthy matters of ores by means of soaps or similar compounds and is dependent upon the superior physical attraction exhibited by minerals for fatty or resin acids, or for certain other aromatic derivatives, such as phenols, cresols, etc., which form soluble salts or compounds with alkaline hydrates.”

Then upon the first page of that same patent they state:

“The mineral particles now attached to or more or less coated or enclosed by films of fatty or resin acids and the like, are capable of being separated from the gangue or earthy particles by various methods, depending upon this altered physical condition. For example, the coated mineral particles may be removed by generating gaseous bubbles in the mixture, which preferentially attach themselves to the fatty or similar acid coated particles and raise them to the surface of the pulp, whence they may be removed by skimming or the like.”

There is a clear statement of the use of soluble agents, the very soluble agents which are mentioned in the patents here in suit, with their use in connection with gases for raising them to the surface, and the only way in which a gas can function is as a bubble, and this effect of lowering the surface tension was there brought about by the same substances which are in use today.

In patent 793,808 which is the patent disclosing the perforated spiral coil that we have had so much discussion about, the patentees state:

“The present invention relates to the concentration of ores by

separation of the metalliferous constituents and graphite, carbon, sulphur and the like, from the gangue, by means of oils, grease, tar, or any similar substance which has a preferential affinity for metalliferous matter over gangue."

The tar there mentioned is one of the substances in use today. Coal-tar is the principal source, I think, of phenol and cresol, and it is used in a crude state in flotation operations. I think it is one

No. 793,808

PATENTED JULY 4, 1905

H. L. SULMAN & H. F. KIRKPATRICK-PICARD.

ORE CONCENTRATION.

APPLICATION FILED OCT 5, 1903

3 SHEETS SHEET 1

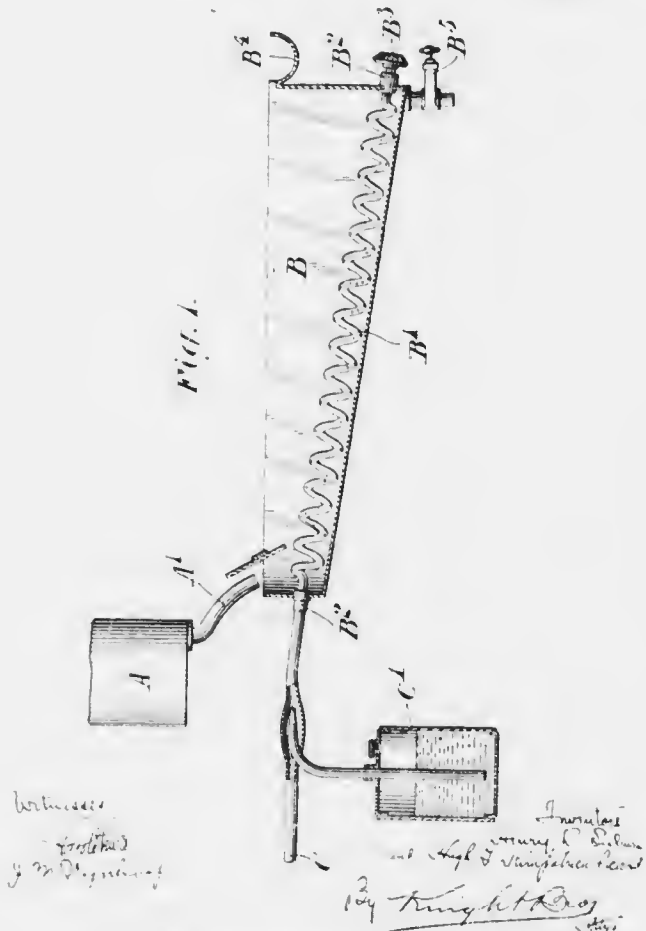

FIG. 33. THE PERFORATED COIL PATENT.

of the substances which the answers to the interrogatories say has been used by the Miami company. It is partially soluble and partially insoluble. It is a mixture. And then this patent, after naming these substances, oil, grease, insoluble substances, and then mentioning in the same breath tar, which is partially soluble and partially insoluble, the same as is the frothing agent used at Miami, after explaining the use of these substances goes on to say:

"According to one method of carrying out our invention suitably crushed ore is suspended in water. To this suspension a proportion of oil, grease, or tar (hereinafter referred to as 'oil') is added and duly mixed with the mass by any suitable means in quantity insufficient to raise the oil mineral by virtue of the flotation power of the oil alone. A suitable gas is now generated in or introduced into the mixture, such as air, carbonic acid gas, sulphureted hydrogen, or the like."

Now here again we have a process in which a soluble agent is used. Tar is not completely soluble, but the complainant has taken the position, which I will accept for the purpose of argument at present, that if any constituent of a substance is soluble, then the substance is a soluble agent under the second and third patents in suit. Accepting, for the sake of argument, this construction of these patents, we have here disclosed, down to the minutest detail, every operation that is performed at Miami. We have tar, a mixture of soluble and insoluble agents; we have the admixture of that substance with the pulp; we have the introduction of that substance into a vessel provided at the bottom with means for the admission of air; that means being this perforated spiral coil.

2 p. m. Same day.

MR. SCOTT: If the Court please, just before the recess I was speaking of the spiral coil-pipe machine, the perforated spiral, and had stated that this process was identical with the operations at Miami. In fact, I think it will be difficult for anyone to conceive of any different action on the part of air bubbles escaping through fine holes in a metal pipe or a sheet of metal, and the same bubbles escaping through similar holes in a canvas bottom. I do not think the thing needs any argument, the two processes are absolutely identical.

An attempt has been made to establish the appearance of identity between that fragile mass of bubbles which results from the Miami operation and from the patent 793,808, and the persistent froth that results from the violent agitation of the patents in suit.

Now certainly to the eye there is no identity whatever. And going further, looking to the real essence of the two operations, we find as great a distinction as there is in the appearance. The agitation froth results from violent agitation of the pulp, beating the air into very fine particles and then bringing the liquid to rest; as the Court has seen here in court, when the agitating mechanism was stopped, there arises this persistent froth which lasts for days. Even when shaken in a bottle in accordance with the directions of the California Technical Journal*, we showed the Court a froth that had stood for some two weeks, I think Mr. Dosenbach testified. That froth was so strong that it remained as a bridge across the bottle, even after the water had evaporated out from beneath it. I think that matter was called to the attention of the Court, that the stopper had been left out, and that froth was so strong that it simply adhered to the sides of the bottle, and bridged across the bottle without any support whatever from below. That is characteristic of all these froths that are formed by this violent agitation.

Now contrasting with that we have what was exhibited to the Court in many experiments with the canvas-bottom machine, our Exhibit 53, and in the perforated spiral-pipe machine, our Exhibit 52.

The first difference that strikes one is that in this agitation process the liquid must be brought to rest before the froth will form. The froth will not form in the presence of and simultaneously with that violent agitation. The agitating mechanism either must be stopped, or the liquid must be conducted into a side vessel where it will be quiet. As it was exhibited in court, the agitating mechanism was stopped, that being merely for convenience in demonstration. Both complainant and defendant did it in that manner. Of course, that would make the operation intermittent if it was applied in practice. It would simply be agitated, and stop, and take off some froth, and then take more material, and agitate again. As I think the Court is informed, in practice the pulp flows in a continuous stream through these agitating vessels and then into quiet vessels where there is no agitator, vessels called 'spitzkasten,' and the current as it flows along is so slow and gentle that the froth rises in these quiet spitzkasten after having been previously agitated in the adjoining agitation vessel. And that is a *sine qua non* of this agitation process: that

* [The California Journal of Technology. Mr. Scott refers to the article by the three students abstracted in our issue of July 31, 1915.—EDITOR.]

the pulp be subjected first to violent agitation and then be brought to rest for this coherent froth to rise.

Now, it is equally of the essence and vital to the process carried on at Miami that just the opposite conditions prevail. In the process as carried on at Miami the bubbles which carry the metal concentrate to the surface can rise and can exist only in the presence of these

No. 835,120.

PATENTED NOV. 6, 1906.

H. L. SULMAN, H. F. KIRKPATRICK-PICARD & J. BALLOT.

ORE CONCENTRATION.

APPLICATION FILED MAY 29, 1905

3 SHEETS—SHEET 1

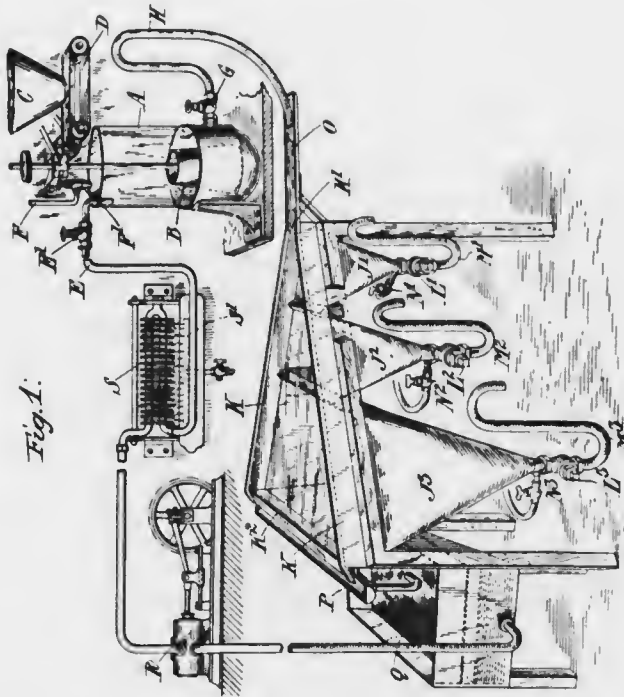

Witness
J. M. O'Keefe
M. B. Hayes

Inventors
Henry Longstrech Sulman
Henry F. Kirkpatrick-Picard and
John Ballot
 by *Knights/O'Keefe*
Attys

FIG. 34. DIAGRAM ACCOMPANYING THE MINERALS SEPARATION BASIC PATENT.

incoming streams of air from the bottom of the vessel. The complainant has contended that the mere gentle entrance of these bubbles at the bottom of the vessel is the equivalent of the violent agitation which forms a vital and essential element in the process of the patents in suit.

There again to the eye there is no similarity and no equivalency. In the agitation-froth process of the patents in suit—and they are all alike in the mechanical treatment of the pulp by agitation—we have a mass of water that is beaten into a perfect vortex or maelstrom, as violent a movement as we can conceive of; whereas in the Miami process where the air is admitted through a permeable bottom, we have no more agitation than one would observe in a glass of charged liquor, soda water, or champagne. There are simply the rising bubbles coming through the liquid. So far there is no similarity.

Look at the principle of the thing. There is an even greater dissimilarity. In the first place, as I have just stated, in the agitation-froth process the froth or bubbles can rise only after the agitation has stopped, or after the pulp has been conducted to a quiet place away from the agitating vessel.

In the Miami process the moment the influx of air stops—and air is what is contended to be the equivalent of the agitation, that is, the incoming stream of air—the minute that stops in the Miami process, the entire body of bubbles carrying the concentrate collapses, and I think your Honor has a vivid impression of that demonstration in which Mr. Yerxa and Mr. Hunt first turned on the air in that spiral-coil machine, and in the canvas-bottom machine, and built up this mass of bubbles, and then suddenly turned the air off, whereupon this all dropped.

Now, looking at the matter of equivalency, it seems to be an impossible construction of the facts and law to urge that the incoming air-streams in the bottom of the permeable-bottom cell, whether it be the spiral pipe or the canvas bottom, is the equivalent of the agitation, when their action is precisely opposite in respect to the formation of the froth. In one case the froth forms only when the agitation ceases. In the other the floating or rising bubbles exist only while the so-called agitation is going on. The principle of the two things is as different as the manifestation of that principle. The manifestation differs in this respect that I have pointed out. In one the froth rises when the agitation stops. In the other the bubbles can rise only when this so-called agitation is going on.

Now as to the principle. The two processes attack the problem

in completely different ways. In the agitation-froth process the thought is so to treat this pulp by violent agitation that a froth will form and exist after agitation, that froth to be of so permanent and lasting a character that it can be manipulated, can be floated or skimmed off, as the Court has seen witnesses do in this case. The idea there was by this agitation to effect a separation more or less permanent between the gangue and the concentrate, to get the gangue at the bottom and the concentrate at the top—to stratify them, as it were. We have the two strata with an intervening stratum of water. And then to take off that froth in any way which may be convenient, either by simply flowing off or by skimming, as has been explained by complainants' witnesses in that instance where they had a revolving paddle something after the fashion of the stern-wheel on some of the river-steamers. That paddle would revolve and scrape off this froth.

In the Miami process the mode of attack upon the problem is completely different. There is no idea in the Miami process of stratifying these materials and making a permanent float, which can be scraped off or floated off. The thought there, and the process as actually carried out, is to admit at the bottom of the vessel containing the pulp with the agent that is used, a stream of air bubbles which act, as Dr. Liebmann has said, simply like an upcast. These air bubbles, rising by the force of gravity through the water, collect the mineral particles by reason of the fact that they do collect them. That is about all that we can say, that the mineral particles adhere to these bubbles while the gangue does not.

Then the bubbles come to the surface of the water and break almost instantly. There is a constant succession of breaking bubbles, but the influx of air at the bottom of this vessel manufactures these bubbles at a slightly more rapid rate than they break, and for that reason the upper layer of bubbles is overflowed from the top of the vessel and saved, with their burden of mineral. The only reason that the Miami process is a success, or that the process of patent 793,808 is a success, is that it is possible by these rising bubbles to make the bubbles a little faster than they break. If they broke as

MR. SCOTT: Up to the top.

THE COURT: Up to the surface, or above the surface?

MR. SCOTT: Precisely.

THE COURT: Now, where in the complainant's process does the bubble attach itself to the mineral—below the surface or above?

MR. SCOTT: I think that must be below the surface, too.

fast as they were made, we would never have any appreciable amount of bubbles on top. They would simply break, each one in time for the next one to come up; but as it is there is a small interval of time before they break, and more bubbles are being formed at a rate so rapid that some of those bubbles are raised to the top and carried over the top before they have broken, and that is the only reason that it is possible to concentrate ores in that way.

The frothing process, on the other hand, is not dependent upon any such principle at all. The thing is simply agitated violently, and when the agitation stops, this froth rises and floats much the same as a board would. It may not be as long-lived as a piece of wood, but it lasts for weeks, and it simply rises there and floats. Speaking with regard to the purpose of concentration, it is permanent, within the limitations that permanency is necessary or desirable.

Now in view— —

THE COURT: Let me see if I get your idea. Do you draw a distinction between a process which results in the formation of what is termed a permanent froth, and a process in which the bubbles come up in rapid succession, but not in such quantities or in such close proximity as to form a permanent froth, but as soon as they get to the surface they float away; is that what you mean?

MR. SCOTT: They float over, if we get them over before they break. It is a kind of a race.

THE COURT: If you get them over before they break? But suppose they break before you get them over, what becomes of the mineral?

MR. SCOTT: Then, as is shown in these demonstrations, if they do break, the mineral drops, and it is caught by the bubbles below.

THE COURT: And brought up again?

MR. SCOTT: And brought up again. The bubbles must be brought up fast enough so that it will gradually be raised.

THE COURT: That is, above the surface,

MR. SCOTT: Yes. There must be new bubbles coming fast enough so that it is gradually carried up over.

THE COURT: And they float off?

MR. SCOTT: And finally float off.

THE COURT: That is what I meant. I did not express it in that way. You expressed it in two stages, a first mass of bubbles and a succeeding mass of bubbles, but that was what was in my mind.

MR. SCOTT: The same idea, I think.

THE COURT: That there is no permanence?

MR. SCOTT: No permanence in the bubble process at Miami. Now, if the Court remembers the mass of bubbles was probably about 6 inches high above the water, as I remember.

MR. KENYON: Ten or twelve inches high.

MR. SCOTT: Ten or twelve inches high. It was quite high. Now, if a particle should be allowed to drop by reason of the bubble breaking, it would be caught on a bubble below, and thus constantly raised up by new bubbles coming into the bottom, so that it is, as you might say, a case of stepping back an inch and going forward two inches, and gradually getting over, despite the breaking of the bubbles.

The term 'flotation' seems inaccurate as applied to this Miami process. In the agitation-froth process, after the agitation is stopped, this froth actually does float. It will float for hours, and days, and weeks, and stay on the top of the water; but in the Miami process, as soon as the incoming current of air stops, everything drops, and we have the clear water-surface on the top of the cell. Now, that demonstrates absolutely that that mass of bubbles several inches deep, which we see in the Miami process operation, or that of the patent 793,808, is not really floating. It is held up there by the current of air, which holds it in place. That current of air not only manufactures these bubbles so fast that we have that mass of bubbles there, but it actually holds them up in position, and the minute the air is turned off everything drops. The mineral goes right to the bottom, and the bubbles break. So that instead of a floating mass of concentrate, it seems to me that it is best described, as I think I did once before in opening the case, by saying that this Miami operation is similar to these devices we have seen, where a stream of air is blown out of a pipe and a ball floats above it. The minute the stream of air is turned off the ball drops. In popular language, we may say that that ball is floating in the air, but obviously that is a misnomer, if we attach any exact meaning to our words.

Now, the Miami process is analogous to this ball held up on that stream of air. The agitation-froth process is the ball floating in the water. The two things operate upon absolutely different principles, and the difference is so great that it cannot escape anyone's notice.

Dr. Liebmann has characterized this Miami cell, or Callow cell, as he calls it, as an upcast, and the figure of speech is very happy. We took an ordinary upcast with water, such as that which was

used for separating the Cattermole granules; and the Court will well remember that the mixture, the granules and gangue, was brought downward into a pipe, and water was flowing upward in the pipe, and that upward stream of water carried off the light tailing, and the heavy granules sank to the bottom. Now, 'upeast' is the term that is ordinarily used, and the action which takes place in this Miami process is absolutely analogous to that. It is not a floating operation. It is an operation in which, in a rising current of air, gravity is strong enough to pull some of the particles down, but the other particles are of such gravity and shape that the rising current of air carries them up against the force of gravity.

THE COURT: Let me ask you, where is the gangue separated from the metal?

MR. SCOTT: In the Miami process?

THE COURT: Yes.

MR. SCOTT: The gangue comes out at the bottom and the mineral is carried over the top.

THE COURT: Yes. How is that the result of this upeast?

MR. SCOTT: Of air?

THE COURT: What is it that separates the gangue from the particles?

MR. SCOTT: The rationale of the thing is evidently this: We have in this cell, or tank with the porous bottom, water carrying in suspension both gangue particles and mineral particles, and the mixture has been treated with some of these agents—tar, or coal tar, or what not—mixed up with it. In the first place, those air bubbles attract to themselves the mineral particles and do not attract the gangue particles; so that at that stage of the operation we have in the water a series of bubbles with the mineral particles sticking to them and we have the gangue particles free in the water itself. Now, those bubbles rise, of course, by gravity and carry with them those mineral particles. The combination of the bubble and the mineral particle is together lighter than water, so it goes to the top.

THE COURT: I understand.

MR. SCOTT: And the gangue particle has had no assistance whatever from the air. It is still heavier than water, the way it always was, and it goes to the bottom.

THE COURT: I understand, then, that in the Miami process the bubble attaches itself to the mineral below the surface.

MR. SCOTT: Below the surface, yes.

THE COURT: And carries the mineral—

THE COURT: And it carries it up, does it?

MR. SCOTT: It carries it up to the top.

THE COURT: Is it not pretty much a question of froth, rather than of concentration—the difference between the two processes? I understand that the purpose of the patents is to effect not a froth, but a concentration.

MR. SCOTT: Precisely.

THE COURT: A separation?

MR. SCOTT: Precisely.

THE COURT: Now, you may assume that I do not know anything about this. I want to have it put to me as plainly as you can express yourself. What is the distinction in principle between those two processes? You have explained the difference in point of actual operation. Now, what is the distinction in principle, when it comes to the formulation of any principle, between these two operations, as bearing upon the question of the separation and saving of the metal particles?

MR. SCOTT: The broad principles are the same in both. In both we have the pulp, consisting of ore held in suspension in water. In both the water is modified to lower its surface tension. In both the buoyancy comes from air bubbles. The difference comes after the air bubbles have attached themselves to the mineral particles. In the agitation-froth process the air is beaten into very minute bubbles, and when they rise with these mineral particles they form this permanent froth. The permanent froth is then floated off or skimmed off. Now, in the Miami process there is no beating up of the liquid, of the pulp. The bubbles are larger and more fragile, and instead of forming a permanent froth, which will float, the thing is simply pushed off by the current of air. The basic principles are the same in both of them. The method practised at Miami is the older of the methods. It is the method of the patent 793,808, with the perforated spiral coil.

Now, speaking so far as patents go, departing from the Court's question as to the general principle of the thing, which is identical up to the point I have explained—departing from broad explanations and approaching it from the patent side purely, the patents in suit must necessarily, if they have any validity whatever, be restricted to this permanent froth formed by this mechanical agitation, or they must confessedly be invalid by the prior existence of the perforated coil-pipe machine.

THE COURT: Let me ask you another question.

MR. SCOTT: Certainly, I am very glad to have you do so.

THE COURT: When was the perforated-coil machine first used?

MR. SCOTT: As far as the record in this case shows—

THE COURT: I mean with respect to the first patent in suit.

MR. SCOTT: The date of the application was about a couple of years before, and I think the patent was granted about a month before the application in this country. I will give you the exact date.†

THE COURT: I mean, was it before?

MR. SCOTT: Oh, absolutely.

THE COURT: Before the first patent in suit?

MR. SCOTT: Before the first patent in suit.

THE COURT: Now, let me ask you, what were the ingredients that were used, and what proportions were used?

MR. SCOTT: In this patent the ingredients—and, of course, in all of these—are the ore-pulp in the first place, the water and the ore.

THE COURT: Yes.

MR. SCOTT: And the ingredients for effecting bubble formation in this patent 793,808 are oils, grease and tar, or any similar substance, which has a preferential affinity for metalliferous matter over gangue.

THE COURT: And in what proportions?

MR. SCOTT: The proportions are stated in the patent in this language—there are no figures—in line 89 of the first page of the patent:

“We have also found that a particle of metalliferous mineral, if coated with a minute film of oil, grease or the like* * * *”
And so forth. That expression, “minute film” certainly gives us indication of a very small quantity, because the word ‘film’ without any qualification whatever, conveys to the mind the idea of a very small amount; and when you say “a minute film” we are getting about the strongest expression of the necessity of a small quantity that words can convey.

There is one other place in this patent where I think the quantity is similarly characterized.

MR. SHERIDAN: At the top of page 2.

MR. SCOTT: “A small proportion of oil,” following the “minute film.”

†[The coil-pipe patent (No. 793,808) is dated July 4, 1905, but the application was filed on October 5, 1903. On the other hand the basic agitation-froth patent No. 835,120 is dated November 6, 1906, while application for it was made on May 29, 1905.—EDITOR.]

This brings us, of course, to what I regard as the only real question in the case, and that is as to whether there is any distinction in principle between the froth which is formed with a very small quantity of oil and one which is formed with a larger quantity; in other words, whether there is a difference between an air-froth and an oil-froth or emulsion. The first patent in suit, 835,120, states 'not less than 1% of oil is used; and then in describing the action of that oil it states that it coats the mineral particles. Well, they cannot be coated otherwise than by a minute film. The descriptive language is precisely the same, and then, as shown by the demonstrations in this Court, we have produced the same result ocularly, and metallurgically, with these large quantities of oil as with the minute quantity.

WHY DO MINERALS FLOAT?

By OLIVER C. RALSTON

(From the *Mining and Scientific Press* of October 23, 1915)

*I was very much interested in reading an article by Charles T. Durell, appearing in the *Mining and Scientific Press* of September 18, under the caption 'Why Is Flotation?' However, I find myself unable to agree with Mr. Durell's line of argument, and for the following reasons:

In the first place I believe that Mr. Durell has used loosely some rather obscure scientific terms which may cause unnecessary confusion to anyone not thoroughly familiar with the physical chemistry involved. The term 'nascent gas' is especially open to criticism. Doubtless Mr. Durell means the dissolved gas that can be liberated from the water, but that is hardly the ordinary sense of the term, and many modern physical chemists will object to the use of the word 'nascent' under any conditions whatever, or even refuse to recognize it, in spite of the old ideas that grew up around it. However, it may be that 'nascent' is a good term to use here in a figurative sense. Another term used by Mr. Durell and to which an objection might be raised is the word 'occlusion' as applied to the gases held by minerals. Mineralogists have long used this term rather loosely, but Mr. Durell

*Communicated by D. A. Lyon, metallurgist in charge of Utah Experiment Station, U. S. Bureau of Mines and Department of Metallurgical Research of University of Utah, Salt Lake City, Utah. O. C. Ralston, assistant metallurgist.

does not seem to have taken it up in the same sense. As I understand it, there are three ways other than in visible openings by which gases can be held in solids;¹ these are:

1. In solid solution, in the same way that gases can be held in liquid solutions.

2. In surface adsorption, where the layer of gas immediately in contact with the solid is found to be more or less tightly held by some force of attraction, unnamed, and is hence considerably compressed.

3. In occluded form. This is a term the meaning of which has been much disputed; it is often used in the sense of one or the other of the terms above mentioned. Of late there has been a tendency to call occluded gas any gas that seemingly is held in some manner different from that designated by either of the other two terms, and in a manner not exactly understood. An example is found in certain substances that are known to be finely porous and that seem to hold gases in neither solid solution nor surface adsorption. Charcoal is such a substance. Possibly these have pores of such small diameter that they are of the same order of magnitude as the thickness of the adsorbed layer of gas, so that most of the gas held in them is present in a highly compressed condition. Charcoal absorbs so much CO_2 , for instance, that at ordinary temperatures the volume of CO_2 held is enough to fill the known pore-space at a pressure sufficient to liquify it.²

There doubtless are very fine openings in our crystalline sulphides, and they admittedly do hold some occluded gas, but good cases of occlusion have been found thus far only in amorphous substances like charcoal, hair, wool, glue, meerschaum, starch, etc. This fact tends to cast a doubt upon Mr. Durell's hypothesis that the occluded gas in the flotative minerals plays an active part in the attachment of gas bubbles to the surface of the mineral.

Another physical fact that casts further doubt on this hypothesis is that occluded gases (and dissolved gases as well) are liberated from the substances occluding them only with difficulty; the last traces of them are still held even when the substance is placed in a high vacuum and heated to a considerable degree. It is as though the molecules of the gas were diffusing out through very small clogged pores. How this tightly-held gas could be liberated fast enough to compare with the exceedingly short time which it takes to accomplish flotation of a

¹*Philosophical Magazine*, Vol. XVIII, page 916, 1909.

²See the researches of Sir James Dewar on charcoal, published in various volumes of *Chemical News*.

sulphide particle, is difficult to explain physically. Mr. Durell has further supposed that there is an osmotic travel of ions from the water solution, in which the ore pulp is made up, directly into the fine openings of the mineral particles. The surface of the particle acts as a septum and at the same time the molecules of the gas diffuse out and join the air from the solution, forming a bubble that floats the mineral. At the present time I cannot see my way to accept Mr. Durell's supposition. Briefly stated, then, Mr. Durell's hypothesis is that "nascent" gas from the water and "dissolved" gas from the solid meet and collect at the surface of the solid until a bubble large enough to lift the particle is formed, while the purpose of an oil is to form a persistent froth so that the particle will not be dropped back into the pulp. I am of the opinion that all the phenomena cited by Mr. Durell constitute no proof of any part of his hypothesis, but only furnish the basis for an inference that such could be the case. Whether it is possible to get flotation from water containing no dissolved gases and with minerals that have been treated for the removal of their occluded gases, no one knows. Possibly Mr. Durell is right when he says that "this phenomenon is worthy of investigation," but, on the other hand, I believe that flotation can be explained more satisfactorily than by the conjecture that well crystallized minerals, such as the metallic sulphides, contain important amounts of either occluded or dissolved gases, and that they contain these gases in any greater amount than do the equally well crystallized gangue-minerals, such as quartz and feldspar. That surface films of adsorbed gas or air exist and may be of great importance, I firmly believe, but there is little evidence of any great difference in the amount of this gas on gangue and on flotative minerals.

As I understand Mr. Durell, the sole use of the oil in froth-flotation is the formation of a tougher liquid film around the bubbles of air, so that the resulting froth is more persistent. Mr. Rickard³ has pointed out that various writers have continually made the statement that the surface tension of water is *increased* by the addition of the oil, while as a matter of fact it is *decreased*. This fact Mr. Durell acknowledges, and yet he states that because the surface tension of the water is decreased, the tendency to float is likewise decreased. He implies that the reason is because the bubbles burst more easily. This seems strange, but in the absence of further data we can let it pass. My main comment is that while Mr. Durell believes that the only function of oil is the toughening of the surface film, we are not sure

³M. & S. P., Sept. 11, 1915, page 383.

that such is the case. His hypothesis about "nascent" gas and "occluded" gas does not require the presence of oil; hence he has had to explain the use of oil or abandon the hypothesis.

Although I consider that Mr. Durell should be applauded for his courage in putting forward a hypothesis concerning a subject that has been of so empirical a nature up to date, nevertheless I have felt the necessity for challenging Mr. Durell's hypothesis and of taking the liberty of advancing what seems to me to be a better one.

There are two such hypotheses which seem to be equally possible and it is not certain but that the two simply cover parts of a greater fact. One hypothesis can be stated in terms of the inter-facial tensions involved, and the other in terms of the electric charges residing on suspended particles.

The first hypothesis is based on some academic work done by Reinders.⁴ He based his work on some equations that Clerk Maxwell⁵ had derived from fundamental thermo-dynamic laws, leading up to a certain set of inequalities between inter-facial tensions of the phases involved. By 'inter-facial tension' I mean the state of strain existing at the zone of meeting of any two dissimilar phases. The surface of water in contact with air is under a strain which we call 'surface tension,' so that this surface acts like a tightly-stretched rubber membrane. Likewise the inter-face between a solid and water and between a solid and air or between oil and water is under a similar strain. Allusion has been made already to the surface adsorption of air on solids. The inter-facial tensions of many pairs of liquids are known, as well as the surface tensions of all manner of liquids in contact with all manner of gases. However, the inter-facial tensions of solids in contact with liquids have never been studied thoroughly on account of the difficulty of getting measurements that mean anything. Reinders deduced the following inequalities as applying to the case where a powder, or the particles of a colloid, is suspended in a liquid to which is added a second liquid that is immiscible with the first. Let us assume that the first liquid is water and the second oil, then expressing the inter-facial tension between the solid and water as $T_{(s,w)}$, the tension between water and oil as $T_{(w,o)}$, and the tension between the solid and oil as $T_{(s,o)}$, Reinders stated that:

If $T_{(s,o)} > T_{(w,o)} + T_{(s,w)}$ the solid powder will remain suspended in the water.

⁴*Kolloid Zeitschrift*, 13:235 and *Chem. Weekblad*, 10:700.

⁵*Encyclopedia Britannica*, on 'Capillarity.'

If $T_{(w,s)} > T_{(w,o)} + T_{(o,s)}$ the solid will leave the water and go into the layer of oil.

If $T_{(w,o)} > T_{(s,w)} + T_{(s,o)}$, or if none of the three tensions is greater than the sum of the other two, the solid particles will collect at the boundary between the oil and water.

It hardly needs to be said that here we find something very close to the conditions obtaining in the flotation process. In fact, the old Elmore bulk-oil flotation method fulfills exactly the conditions that Reinders had in mind. Below are given some tables of results obtained by both Reinders and Hoffmann⁶ in an experimental way, by suspending a definite powdered solid in water, adding a second immiscible liquid, and shaking. The letter *w* means that the powder remained in the water; the letter *o* means that the powder went into the oil layer; the letter *s* means that the powder went to the surface separating the oil from the water, and symbols like *s(w)* or *s(o)* mean that there was a good deal more of the powder in the inter-face than in the bracketed phase. Similar results were obtained with colloidal solutions.

TABLE OF REINDERS' RESULTS

	Paraffin oil.	Amyl alcohol	CCl ₄ .	Benzene.	Ether.
Water and Kaolin	w	w (s)	w (s)	w	w (s)
CaF ₂	ws	ws	w (s)	w (s)	w (s)
Gypsum	w	ws	w	sw	ws
BaSO ₄	w (s)	ws	ws	sw	ws
Magnesium	ws	ws	ws	ws	ws
PbO	s	s	sw	s	sw
Malachite	so	s	s	s	sw
ZnS	s	s	s	s	sw
PbS	so	so	s	s	s
HgI ₂	so	s	s	s	s
Carbon	so	s	s	s	s
Selenium	so	so	so	s	s
Sulphur	so	so	o (s)	so	s

Hoffmann worked a great deal with chemical precipitates and other artificially prepared products. However, the laboratory method involved ought to be good in the study of flotation processes for a possible method of floating oxidized minerals. Then it might be possible to convert a successful bulk-oil process into a frothing process in the same way as the old Elmore bulk-oil method went through the stage of granulation and classification to a final frothing process such as we

⁶Zeit. physik. Chem., 83:409, 1913.

TABLE OF HOFFMANN'S RESULTS

	Ether.	Chloro- form.	Butyl alcohol.	Benzene	Kero- sene.	Amyl alcohol	Paraffin oil
Water and							
CaSO ₄	w	w	w	w	w	w	w
SnO ₂	w (s)	ws	ws	s (w)	sw	sw	sw
Al(OH) ₃ . . .	w (s)	ws	ws	s	g (w?)	sw	s (w)
SnS	ws	ws	ws	s (w)	s (w)	s	ws
BaSO ₄	ws	ws	ws	s	s	g (w?)	s (w?)
ZnS	w (s)	ws	ws	s	s (w?)	s	s (w?)
ZnO	ws	ws	s (w)	s	s	s	s
CaCO ₃	ws	ws	s	s	s	s	s
Mg(OH) ₂ . . .	s (w?)	ws	s	s	s	s (w)	sw
Al	sw	s (w)	s (w)	s	s	s (w)	s
BaCO ₃	ws	ws	ws	s	s	sw	s
CuS	ws	s (w)	s	s	s	s	s
PbCrO ₄	ws	s (w?)	s	s	s	s	s
Cu ₂ O (?) . . .	ws	s	s	s	s	s	s
MoS ₂	s (w?)	s	s	s	s	s	s
PbS	ws	s	s	s	s	s	s
Fe ₂ O ₃	ws	s	s	s	s	s	s
BaCrO ₄	ws	s	s	s	s	s	s
Pb ₂ O ₃	sw	s	s	s	s	s	s
C	sw	s	s	s	s	s	s
PbI ₂	s	s	os	s	s	os	s
HgS	s	s	s	s	s	s	s
HgO	s	s	s	s	s	s	o
HgI ₂	s	s	s	s	s	o	os
AgI	s	s	o	s	s	o	os

see today. I have done some work along these lines and have planned considerable research work in the same direction. Meantime these notes might as well be available to others in suggesting lines of useful research. The comments to be made on the above tables are without end, but the tables are given here mainly to suggest the possibilities of further work.

The question arises as to whether it might not be possible to apply a set of inequalities such as those of Reinders, or even to apply Reinders' inequalities direct, in the prediction of results for froth flotation. In froth flotation we have at least four phases—solid, water, oil, and gas—unless the oil happens to be soluble in water, in which case we are reduced to a solid, a solution, and a gas. We have interfacial tensions between each two of the phases, making six tensions altogether, and mathematical expressions covering such a case must necessarily be much more complex and exhibit a greater number of possibilities. The problem is more difficult, but it should be capable of solution. Fig. 35 shows a fanciful magnification of one possible arrangement of the particles of solid, droplets of oil, and spherules

of air, in the liquid of the ore-pulp, being subjected to flotation, at the moment when a bubble begins to raise a particle of mineral to the surface.

Fig. 36 shows a possible way of applying Reinders' inequalities direct without any modification. It is assumed that the oil forms an envelope on the inner surface of the air bubble so that the air is

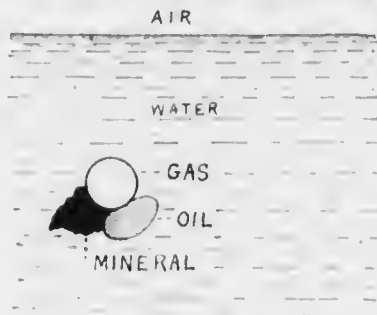

Fig. 35.

nowhere in contact with water. Mr. Riekard¹ has called our attention to the work of Devaux, published in the annual report of the Smithsonian Institute, in which it was found that a droplet of an oil when placed upon a plane surface of water will spread, of its own weight,

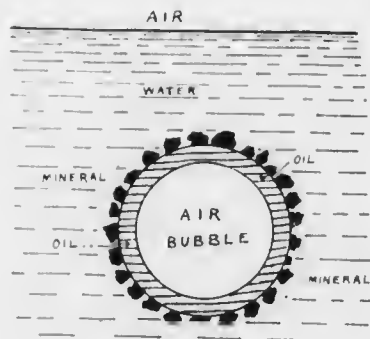

Fig. 36.

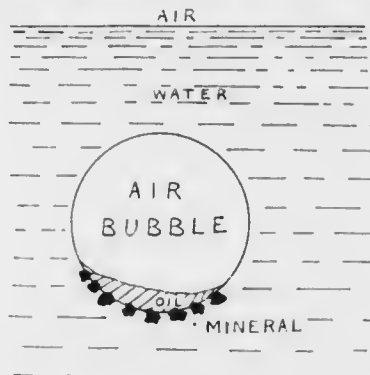
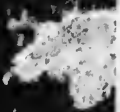
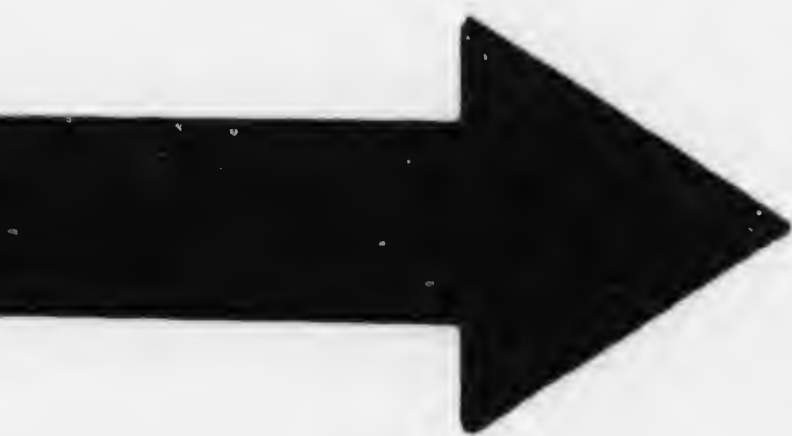

Fig. 37.

until it forms a film only one or two molecules thick. This fact allows an explanation of how the small amount of oil used in the froth-flotation processes could be so efficient. If it so happens that the oil

¹M. & S. P., Sept. 11, 1915, page 167.





MICROCOPY RESOLUTION TEST CHART

ANSI and ISO TEST CHART No. 2



45
50



32
36



40



APPLIED IMAGE Inc

16 3 East Main Street
Rochester, New York 14609 USA
716 482-5050 Phone
716 288-5099 Fax

could coat the inner surface of an air bubble, the powdered mineral would be able to take up a position on the inter-face between the water and the oil without any reference to the air in the bubble.

By reason of the known low adhesiveness of oil and water it is doubtful if the air bubbles could be completely mantled by oil, as the oil would be too liable of its own weight to slide down to the bottom of the bubble to the position indicated in Fig. 37. Even here, the oil could carry mineral on its water inter-face (in case the oil and water do actually get into contact) and Reinders' criteria would still apply. In a Callow flotation machine having glass sides it is sometimes possible to see particles in just such a position. However, this case does not prove that the top side of the bubble is coated with oil or mineral, while the bubbles of a mineral froth on top of the pulp are seen to be covered completely with particles of mineral.

If the mineral tends to enter the oil phase completely and leave the water, the mineral grains present only an oil surface and in case oil droplets tend to collect at the inter-face between water and air (by Reinders' criteria) we could have the case illustrated in Fig. 38.

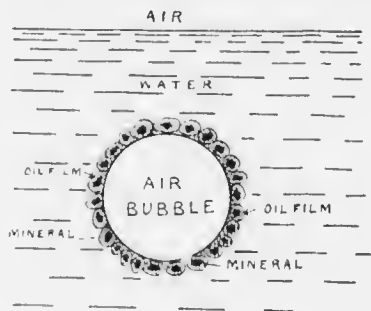

FIG. 38.

This case, as well as the one illustrated in Fig. 36, would allow of the air bubbles becoming completely covered with oiled mineral.

Other phases are possible, but these are given to show how very feasible it is to get an explanation of flotation in terms of inter-facial tensions.

In an investigation conducted by the Minerals Separation, the 'contact angle' of various minerals with water was examined to find at what angle the mineral had to come in contact with a water surface before it was wetted and could sink.⁸ A glance at Clerk Maxwell's

⁸H. L. Sulman, Trans. Inst. M. & M., 1912.

famous paper on 'Capillarity,' upon which Reinders' work is based, will suggest immediately the explanation of a contact angle, and that it is the result of a certain equilibrium of inter-facial tensions of air, water, and solid. Valentin⁹ has likewise investigated the contact angle and its hysteresis under certain conditions and has connected it very definitely with capillary phenomena. There can be no doubt that there is a close parallelism between the angle of hysteresis of the contact angle and the ability of a mineral to float. But if we go no further than to observe the parallelism we cannot designate the statement of the parallelism as a theory, although we might be able to predict by its means whether a mineral would float.

To go into this a little farther, and indeed along the line suggested by Mr. Durell, we ought to consider the properties of the surface layers of the substances involved. For example, the plane surface of water in contact with air is known to have considerably different properties from the inner bulk of the water. In Fig. 39 the film is

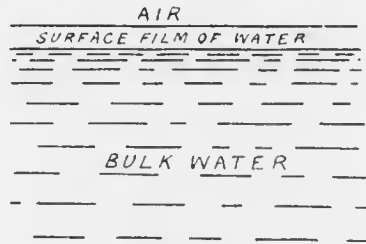

FIG. 39.

shown magnified in thickness. It acts like a tightly stretched elastic skin, due to what we have long called a 'surface tension' of 81 dynes per centimetre, as is usually given in text-books. (This means that for a strip of the surface film one centimetre wide, a longitudinal tension of 81 dynes has been measured at ordinary temperatures, and there is a definite tension for each temperature.) This tension of the surface film is one of its most commonly known properties, but some other interesting points about it are given in the following:

Its thickness, varying with temperature and other conditions, has been estimated¹⁰ to be all the way from 4×10^{-5} to 10^{-8} cm. Its density averages 2.14 as compared with 1 for bulk water, although it is doubtless more dense at the immediate surface next to the air and gradually

⁹'A Theory of Flotation,' *Metall und Erz*, 11:455, 1914.

¹⁰*Philosophical Magazine*, 20:502, 1910.

shades off into that of bulk water. This consideration probably explains the wide variation in the results of the measurement of the thickness, as one method might be less delicate than another and hence not take account of some of the layers of the film that are nearly bulk water in their properties. This average density, however, is illustrative of the magnitude of the force involved because water is a substance that resists compression, and it has been calculated from the known compressibility of water that the force necessary to compress it to twice its ordinary density is some thousands of atmospheres. Such a compression should liberate heat, and, in fact, the heat liberated when a definite area of new surface film is formed has been measured and found¹¹ to be 0.00315 cal. per sq. cm. Being so highly compressed, its specific heat might be expected to be different from that of bulk water and has been measured as being nearly 0.45 instead of 1. This low specific heat approximates that of ice.

One important property of this film is that it will often take up dissolved substances in different proportion from the amounts in which they are taken up in the bulk solution, and there is always a definite equilibrium between the two. This is known as surface concentration or 'surface adsorption,' and has been dealt with mostly in colloid chemistry, where the large amount of surface of the finely divided solids is large in comparison with their weight. In case a greater proportion of the substance is concentrated into the film than there is into the bulk water we have positive adsorption; and in the reverse case, negative adsorption. The properties of these inter-facial films have been found to be greatly modified by small amounts of dissolved substances and the properties of colloids are hence likewise greatly changed. The importance of the study of inter-facial films becomes obvious.

Finally, there is a most important fact about the film of water in contact with air. It has been found that there is a difference of potential of 0.055 volts between the two surfaces of the film.¹² The density of the static electric charge at this potential is 4×10^{-5} coulombs per sq. cm. This electric charge is markedly influenced by electrolytes in solution and can be increased or decreased, even passing through zero and then increasing in the opposite sign. All inter-facial films have likewise been found to be charged in one way or other. Industrial applications of this fact are legion. All the technical handling of clays is now conditioned by the use of electrolytes in

¹¹*Ibid.*, 20:502, 1910.

¹²*Ibid.*, 27:297, 1914, and 28:367, 1914.

this manner, and the question of emulsions of all kinds of oils in water is closely bound up with it. Cottrell's precipitation process of suspended particles of solids or liquids in gases does not escape these considerations. Small particles of solids, liquids, or gases suspended in either liquid or gaseous media are found commonly to carry electric charges, due to various combinations of factors which affect the double electric layer of the inter-facial films.

Since the size of many of the particles of minerals treated by flotation is of the same magnitude as that of many colloids we cannot escape from calling ore-slime "coarse suspension colloids," and must apply all the laws of colloid chemistry to our problem.

The electric charges on suspended particles allow another possible explanation of flotation phenomena. We find in some of the colloid chemical literature¹³ that quartz particles when suspended in water are negatively charged, pyrite particles positively charged,¹⁴ oil droplets are negatively charged, and air bubbles negatively charged.¹⁵ The charges are somewhat small compared with the weight of the particles, so that they are hardly strong enough to cause negatively-charged quartz to stick to positively-charged pyrite, as they can have only a few points of contact, and currents in the water could easily tear them apart. However, the negatively-charged droplet of oil, which is repelled from a negatively-charged particle of quartz, can wrap itself around the positively-charged pyrite particle so that they will stick together, and the same applies to air bubbles. The other sulphides known to be flotative have positive charges when suspended in water or can be made to assume positive charges by the use of the proper amount of the proper electrolyte. So it can be seen that the application of these principles gives no difficulty in explaining flotation from an entirely new standpoint.† The large effect of a small amount of sulphuric acid on the conditions of flotation does not seem strange at all in this light, and we do not have to retreat to the purely

¹³*Kolloid Chemische Beihefte*, 2:84.

¹⁴*Zeitschrift für physikalische Chemie*, 89:91, 1914.

¹⁵See foot-note No. 10.

†It would appear that at the instigation of J. M. Callow, the Mellon Institute of Pittsburg, under the direction of R. C. Bacon, also formulated this same theory, and for a long time has done research work in this direction, this work and continuation of it at the Bureau of Mines at Salt Lake City seem to support the logic of this theory. A paper on the same subject was read by Mr. Callow at the October meeting of the American Institute of Mining Engineers in Salt Lake City. See page 231 of this book.

imaginary supposition that osmotic pressure is acting through the surface of the mineral, as does Mr. Durell.

The inter-facial tension and the charge on the inter-facial film are two different physical properties of one and the same thing. I have shown that an appeal to either property is enough to build up a working picture of flotation phenomena that is simpler and more probable than that of Mr. Durell. I do not know how much there is in his contention that air bubbles will not attach themselves directly to the particles, or that only the dissolved air can thus attach itself; it may be that this is all correct, without interfering with the explanation that I have put forward. However, I hesitate to accept such a conception. The underlying cause of the tensions and of the electric charges is the same thing—some strange molecular, atomic, or other force manifested in 'adhesion,' 'cohesion,' or even 'gravitation,' if you please. No one can claim that electric charges carry the whole explanation of flotation, nor can it be stated that it is merely a question of a balancing of inter-facial tensions. Both will doubtless have to be considered.

Although much more could be said on the subject, I have only attempted to point out that there are certain scientific principles that can be applied to our problem, with great chances of success, in bringing us nearer to a definite understanding of flotation. Physical chemistry has been a recognized tool of metallurgists for some time, although little used by most of them, and now a particular branch of physical chemistry—colloid chemistry—is beckoning to us alluringly. All questions of the treatment of ore-slime should be studied in this new light. The results of an application of this idea in our own laboratory have been astonishing, and we hope that we may soon be able to publish them.

WHY IS FLOTATION?

(From the *Mining and Scientific Press* of October 30, 1915)

The Editor:

Sir—Mr. Durell's article on this subject in your issue of September 18 is interesting. I believe that an exchange of ideas on this subject is very desirable, and it may be that some of the information that I have collected may be of interest to the readers of the *Press*.

The arguments which Mr. Durell's article presents are, briefly, that floatable particles cannot attach themselves to previously formed bubbles, but must be floated by bubbles which form themselves on the surface of the particles so that there is no surface film of water between the particle and the air. To explain the formation of these, Mr. Durell assumes that the water is super-saturated with dissolved air and that there is a certain amount of "occluded" air on and in the surface of the particle, and that these combine to form bubbles. That this occluded air may be present is certainly possible, but that it would be liberated with sufficient rapidity to float the particles does not seem probable. That the water in a M. S. type of machine is supersaturated with air is also probable, but I cannot see how the water in a Callow or other pneumatic machine can become greatly super-saturated by the introduction of air through a coarsely porous medium such as canvas twill.

The idea of super-saturating the water with air is not new. As early as 1907 D. H. Norris patented this process. (U. S. patents No. 864,856 and 873,586.) Mr. Norris saturated water with air at a pressure of several atmospheres, and introduced it into an open tank at normal pressure, where the excess air formed what he called "infinitely small nascent bubbles of gas" which were supposed to float the sulphide particles. So far as I know, this idea has never been put into successful operation.

As to Mr. Durell's statement that the dissolved and occluded air are indispensable; if it is true, previous boiling of the pulp, which would drive out all of the dissolved and some of the occluded air, should interfere considerably with flotation, especially in a pneumatic machine. I have seen this done in the laboratory of the General Engineering Company. The subsequent flotation took place with practically the same rapidity and cleanliness as when the same ore was floated without boiling of the pulp. Furthermore it has been my observation, that when a carbonate ore is treated with soluble

sulphides for the purpose of forming an artificial film of sulphide on the surface of the mineral particles, much better results are obtained when a small amount of alkali is added to the pulp to remove any traces of H_2S gas. This can also be accomplished by the use of SO_2 , which reacts with the H_2S to form sulphur and H_2O , and does not leave an alkaline pulp. Were Mr. Durell's hypothesis true, this gas should be beneficial rather than detrimental, and it would seem that the general effect of artificial sulphiding would be to reduce the amount of occluded air rather than increase it, as some of it would undoubtedly be displaced by H_2S which would later be removed.

I cannot agree with Mr. Durell's statement that floatable particles will not attach themselves to previously formed air bubbles. I understand that in the suit of the Minerals Separation, Ltd., v. Miami Copper Co., heard at Wilmington May 1915, the plaintiff presented to the Court a moving picture of an experiment in which it was shown under just what conditions the particle would attach itself to the bubble. Aside from that, it is not a far-fetched assumption that the air bubbles in an oil-emulsion have mantles of oil. Their property of frothing would so indicate, and, in that case, the surface films of water surrounding them would not differ materially from the films surrounding drops of oil suspended in water. That such drops of oil can collect floatable particles out of an ore can easily be proved by shaking oil with a mixture of galena and sand suspended in water. When the oil has collected, the drops will be seen to be covered with the galena. If we imagine the centres of these drops to be filled with air instead of oil, we have conditions which might easily hold in an actual flotation machine.

On the whole, Mr. Durell's hypothesis does not seem to conform with actual flotation practice. There are other theories that explain flotation in better conformity with known scientific facts. T. J. Hoover, for instance, in his book 'Concentrating Ores by Flotation,' presents a consistent theory, and J. M. Callow presented a paper to the Utah Section of the American Institute of Mining Engineers in which were set out some theories based on experimental work done at the Mellon Institute and at the local station of the U. S. Bureau of Mines. This paper* will undoubtedly be published soon in the transactions of the Institute.

JAMES A. BLOCK.

Salt Lake City, October 6.

*See page 231 of this book.

AIR-FROTH FLOTATION—II

(From the *Mining and Scientific Press* of November 6, 1915)

[In our issue of October 16 we gave an excerpt from the speech made by Mr. W. A. Scott, counsel for defendant in the case of Minerals Separation, Limited, v. Miami Copper Company. We follow this now with lengthy quotations from the speeches of Messrs. Henry D. Williams and W. Houston Kenyon, of counsel for the complainant. In the first excerpt Mr. Williams discusses the article by the three students at the University of California, as published in the college magazine, *The California Journal of Technology*. The major portion of that article appeared in our issue of July 31, 1915, to which the reader is referred* in order to follow the lawyer's remarks. In the second and third excerpts Mr. Kenyon discusses some of the physics of the flotation process. Of course, the reader must remember that this exposition of the subject, like that of Mr. Scott, is not to be taken as a scientific thesis; it is essentially an *ex parte* explanation, but even as such it is extremely interesting to metallurgists. The first patent in suit, to which reference is made, is No. 835,120.—EDITOR.]

MR. WILLIAMS: *The California Journal of Technology* is evidence of the interest that the metallurgical world took in the Elmore process. The title is 'Experiments on the Elmore Process of Oil Concentration.' The conclusion is:

"The work above outlined suggests many lines of further investigation, and as these come to be worked out, the process will become more valuable and of more general application."

What process? The Elmore process.

In 1903, the Elmore process was a hope of the metallurgical world.

Incidentally, the students discovered something else, and, for the first time, gave to the world the foam effect. Full disclosure as to a mode of operation which would produce an oil foam, they, for the first time in the history of metallurgy, gave to the world.

That was an incident of their careful investigation, but the article itself is on the Elmore process, and it says that the Elmore process was then a hope of the metallurgical world.

THE COURT: Mr. Williams, if there was a disclosure of the process, although a misnomer, what would be the effect of that disclosure?

MR. WILLIAMS: The name, obviously, has nothing to do with it.

THE COURT: No.

*See page 102 of this book.

MR. WILLIAMS: I was particularly directing my attention to the fact that Mr. Sheridan took those last three lines as something which was directed solely and wholly to that small part of this article which deals with the foam effect.

THE COURT: Oh, I understand.

MR. WILLIAMS: And I was merely pointing to the fact that those lines must have referred to this Elmore process as a hope of the metallurgical world.

The foam effect here disclosed, which is recommended as employing 8.9% of oil—it being clearly shown that nothing else is worth anything—8.9% of oil and salt solution, an ore containing light flaky minerals, such as molybdenite; and another one of the same kind is graphite, and I do not know any others—certainly not copper, certainly not zinc. Galena and blende are not flaky. Galena is almost cubical in its fracture. They call attention to the study of the fracture of minerals. They worked out this foam effect, which they give to the world, with the recommendation that 8.9% of oil be used, as something which may possibly be useful with light flaky minerals, and that became a part of the constructive knowledge of the world in November 1903.

It is remarkable that it was buried and lost, and that it took three years of litigation to unearth it. That is quite remarkable, especially that it should have been buried and lost in the University of California, which is in the heart or the centre of the important mining interests on the Pacific Coast, and in the Great West.

But that is all there is there, and the most significant thing about it is that it tells the investigator: We have tried 2.1%, and the result is hopeless. We have tried 5.3%, and the result is almost as bad. But we have tried 8.9%, and there is some hope in that. Now, proceed; investigate.

But very evidently, nobody proceeded and investigated. There is not any practical art, unless it be Elmore. There was not any mill that made any use of any of these patents that have been referred to. Haynes lightly touched upon; Everson, the foundation of the defendant's case—why these very students in this article tell the exact truth about Everson. I am sorry they did not write more, because they would have been impartial, and they would have possibly given us a fair, unbiased interpretation of the patent.

“In 1886 Carrie J. Everson of Chicago* contributed the idea that

*In her first patent, No. 349,157, she is described as “of Chicago, Illinois.” but in No. 471,174 she is said to be “of Denver, Colorado.”—EDITOR.

the concentration was aided by the presence of an acid solution, and patented the same.”

That is just exactly what Carrie Everson did contribute. It is an exact statement, and that is preceded by reference to another patent, which the defendant has not seen fit to refer to, although it has figured in some other litigation—the patent of Tunbridge, erroneously here spelled ‘Turnbridge.’ That is set forth here as the first patent for utilizing oil, and its date is given as 1878. But it is of slight relevancy, and the defendant has not relied upon it, and it is, as your Honor will note, later than Haynes.

As a matter of fact, the reference to this patent would indicate a study of the Everson patent, because the Everson patent disclaims the Tunbridge patent. It does so with quite some labor. It is the thing that Carrie Everson had to distinguish from; that I think accounts for the reference to that patent.

These students probably investigated the patent situation, and so they referred to the Tunbridge patent and the Everson patent, and they tell the exact truth of the contribution of Carrie J. Everson to the art of the idea that the concentration was aided by the presence of an acid solution.

Then these young men say, and they say truthfully:

“But the absence of a successful method of separating the mineral from the oil prevented the practical application of these prior patents.”

Well, they do not tell the whole truth about that, but that is undoubtedly one of the reasons, and the important thing is that these prior patents, Tunbridge and Everson, were not practically applied. That they were not capable of practical application would be the reasonable presumption, but that is the fact. And then these students go into the subject of the removal of the oil. Of course, with 17.1% of oil, which is 342 pounds of oil to the ton of ore, and if out of the ton of ore you got 700 lb. of concentrate, that would be a fair average. With these 342 lb. of oil, you see the oil would be about 50% of the concentrate. You would have a great mass of oil with the concentrate, and unless you could successfully get rid of that oil, it would be troublesome; and, again, the cost of that oil was such that it must be possible to recover and use it over again. It has acted merely in a physical manner. It has not changed its constitution at all. So, if you could bring it out, separate it, and send it through again, there was some hope; it was Elnore who did that.

The students say that burning of the oil was tried, which left a

difficult residue to treat, and the large consumption of the oil made the method too expensive. That is undoubtedly true.

"It was not until July 1900 that this difficulty was overcome by means of a special machine, similar in most respects to that which is used in sugar factories and in milk and cream separation. This contribution by Mr. Elmore then made the process feasible."

Now, we will note here that they mean the process of oil concentration. These young men were looking at it solely from the viewpoint of something which utilized oil in the concentration of ores—they were not concerned particularly with methods, but they were looking at it always from that viewpoint; that is why they refer to Timbridge, and why they refer to Everson, but there is not a thought or suggestion running through here that the Everson patent, which they say has proved of no practical value, makes any suggestion of flotation. Everson merely contributed the use of acid.

MR. WILLIAMS: Prior to the invention of the first patent in suit, and looking only to what men did, we find that wet-concentration processes were the solution of the ore-concentration problem. They were the processes that have been described here, and that I need not describe again; processes that depend upon gravity and shaking and motion of finely ground ore suspended in moving water, the separation depending upon the difference in sinking-power of the metal and the gangue; wet-concentration processes that are in use to a tremendous extent still, but that are being superseded in the last two or three years to an astonishing degree by the processes of the patents in suit.

No, in these wet-concentration processes advantage was taken of the fact that the metal had a higher specific gravity in the average than the gangue, and the laws of nature were followed. The heavier thing was allowed to settle, and circumstances and conditions were so controlled that it would have a chance to settle away while the gangue would be left suspended. The gangue would be floated in mid-bulk of the liquid, and up and down and all around, and finally floated off over a dam.

But all wet-concentration processes—and the machinery for carrying them out has exercised the ingenuity of inventors for thirty years—all wet-concentration processes were useless on slime, and the fact that the concentration was by such processes raised a hard and fast limitation to the extent that you could grind ore. The grinding must be coarse. The grinding must be so done as to produce the minimum of metal-dust; and so grinding machines were invented to that

end, to prevent the production of the fine dust-like particles of metal in the general grinding of the ore. All wet-concentration processes are useless on slimes. They will not settle. They will not obey the laws of gravity. They will stay up with the gangue. They will float off with the gangue. They will run to waste. And hence we have these tailings in Australia and here, of millions of tons, where the slimed metal, the finest of the metal, has all run off, because it could not be recovered. With such concentration processes the best that could be done was from 60 to 70% recovery. Prof. Fulton gave 70% as the outside limit—60 or 70% of the sulphide metal in the original ore. And yet men persisted in using that process.

Elmore, about the opening of this century, about 1900—his patents were a year or two earlier—came in with his process to reverse the laws of nature. Instead of finding the heavier thing at the bottom, Elmore said: "I will carry it to the top."

Again a process useless on slime. Again a process requiring coarse grinding as before. The concentrate at the top now instead of at the bottom. The theory of operation was an oil lake. I like that word 'lake.' It is used by the *California Journal* students—an oil lake. Air entrainment was fatal. Ingenuity was exercised to so mix the oil lake and the ore as not to entrain air. Oil emulsion was fatal. The amount of oil we know was 100 to 300% on the ore. And yet men did that thing. Men paid that price, and the loss on every 100 lb. of oil was 9 or 10 lb. at each eye. The other 90 lb. had to be taken out, and preserved, and used over again.

And Cattermole. The very men who afterward made the invention of the first patent in suit spent two years and a half developing that Cattermole process, a really beautiful idea, the first process addressed to the slime problem. Said Cattermole to himself:

"Now, if I can have fine grinding of the gangue and coarse grinding of the metal, I can separate the metal out by its dropping and by the gangue floating." For right there is an interesting principle of physics. When a particle is floating in water, its tendency to sink is determined partly by its weight. The weight tends to carry it down if it is heavier than water. The surface of the particle tends to resist that, tends to keep it up. If the surface is greater, in respect to the weight, it will not go down so fast. If the weight is greater in respect to the surface, it will go down faster. Now, if you imagine a little cube of metal suspended in water, and imagine its linear dimensions doubled in all directions, the surface will have been squared, and that is the thing which resists dropping, while the weight will

have been cubed. The weight has increased faster than the surface. Therefore that doubled cube will sink faster through water. That law, of the square as to the surface, resisting sinking, and the cube as to the weight compelling sinking, is the thing that makes big particles drop more in accordance with their true specific gravity, but fine particles like slimes refuse to obey the laws of specific gravity, and continue to float and not sink, whether they be mineral or whether they be metal.

As Dr. Liebmann illustrated on the stand, if the rain came down in a shaft it would kill us all. When the same amount of rain is broken into small drops, it does not kill us. Why? Because the surface has been so enormously increased with respect to the weight, or *vice versa* the weight diminished with respect to the surface. So the resisting surface makes those drops come down, not like bullets, but gently. And going a step further, when the particles are smaller still, they will not come down at all. They will float like the summer cloud in the sky. Their specific gravity is just as great as it ever was with respect to the air, but they are so small that they are floated.

THE COURT: Is it because they are so small, or is it because of their form?

MR. KENYON: Their form would have a tendency to be spherical in all cases, but it is a function of their size.

THE COURT: I suppose if you dropped a needle into water and kept it point downward, it would go down fast.

MR. KENYON: Yes, it would go right down. Drop it sidewise, so that you have multiplied the surface without changing the weight, and it will stay right there.

Now, Cattermole conceived this brilliant idea: If I can only make my gangue particles fine, they will stay up there indefinitely. If I can only make my metal particles big, they will drop faster. He knew he could not do that in grinding. Let the inventor of the future, if he be here present, take this for a cue: A grinding machine that at the same time will grind the gangue fine and the metal coarse will revolutionize all these processes. Cattermole knew that could not be done in grinding, so he said: "I will grind it all fine, and then by the gluing effect of oil, particle to particle, oil which goes to metal and does not go to gangue, I will roll and work my metal particles into big metal particles, whereas the gangue will remain as fine as it was ground; and then when I have done that, my big metal particles, my granules, my spherules, will drop and the gangue will go up."

That was the Cattermole idea, and men proposed to do that thing.

and these plaintiffs, and the world would have been concentrating their ore by that process today in preference to all others, probably, but that the invention of the first patent in suit was made.

The Cattermole idea of operation was by oil adhesiveness and

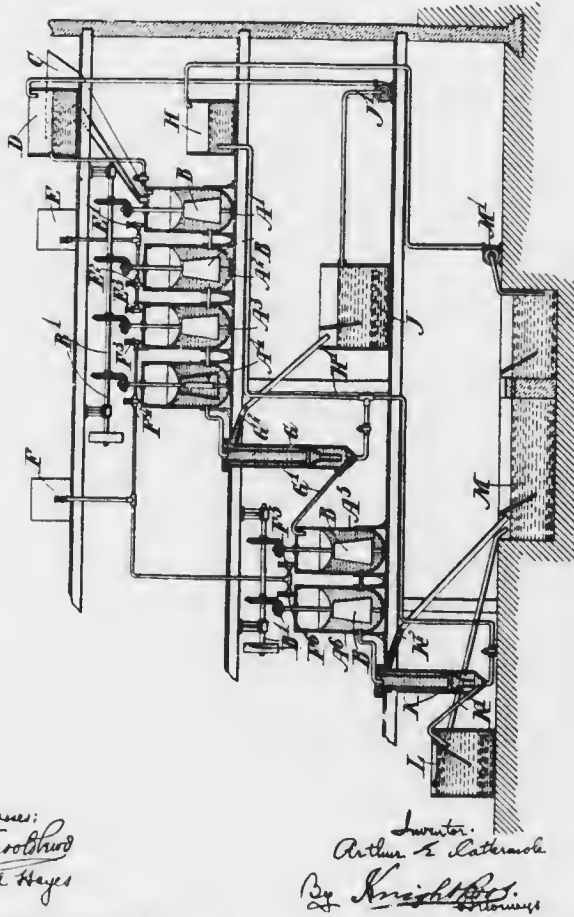

Witnesses:
Harold
Mark Hayes

Inventor:
Arthur E. Cattermole
 By *Knight*
Attorneys

FIG. 40. DRAWING ACCOMPANYING A. E. CATTERMOLE'S PATENT, NO. 777,273, OF DECEMBER 13, 1904.

mixing. Air entrainment was a trouble. Flotation scum was a loss. Two to five per cent of oil on the ore (4 to 10% on the metal; it was a rich 50% metal ore) was the amount, and if the effects were diminishing, then they increased slightly the amount of oil. (Higgins, Printed Record, p. 212. Q. 43, 44.)

Thereupon a recess was taken until two o'clock p.m. same day.

THE COURT: Mr. Kenyon, I was very much interested in the remark you were making before recess on the matter of the difference between big particles and little particles, in the strength of their power to overcome resistance. Now, entirely aside from surface tension as such, and I mean that sort of tension to enable very minute particles, although having a greater specific gravity than other particles, to float on the surface. Aside from that, and aside from the case in which the mineral particles having greater specific gravity are attached to any medium of buoyant character which tends to support them, these small particles, if once placed beneath the surface of the water, having greater specific gravity, of course, would sink.

MR. KENYON: Yes, and No. The coarsest will sink at once. The finest of them would ultimately sink, but the finest of them would take so long to sink that it is impracticable to separate them or do anything with them by sinking, and that was the slimes problem in all these metallurgical operations. They would float there. They would float in the liquid. When you get down to a certain ultimate point of fineness, whether it be metal or gangue, it will float in the water underneath the surface.

THE COURT: Underneath the surface?

MR. KENYON: Underneath the surface.

THE COURT: But still they would gradually sink?

MR. KENYON: After a long, long time.

THE COURT: I would like to understand you. Of course, we all know that if we could conceive of a perfect vacuum, both a bullet and a feather will go down together.

MR. KENYON: Under the law of their specific gravity absolutely.

THE COURT: When you come, however, to a resisting medium (I do not care whether it is air or water) then you have a different proposition, and there you have a resistance which has to be overcome, and as you proceed arithmetically the resistance increases geometrically, I believe. Is that right?

MR. KENYON: Yes.

THE COURT: My question is whether these particles would finally sink. I want to get the theory if I can. Aside from the surface tension, if you once get those particles underneath the surface of the water, not attached to any bubble or any substance which has a less specific gravity than water, will they not sink, although at a greatly diminished rate?

MR. KENYON: They will ultimately sink, although there may be

what they call a colloidal condition, which has been somewhat discussed here—clays are very colloidal, and have a tendency to keep them in suspension perhaps for days before they would sink. Even they will, as I understand it, ultimately sink.

THE COURT: Ultimately?

MR. KENYON: The least little jar or agitation will send them right up again. The whole slime problem and difficulty in all metallurgical operations, and in the cyaniding processes as well as concentration processes, turn just on the long length of time it takes the fine particles to settle to the bottom. They will float an inch below, two inches below, three inches below, all around, almost indefinitely, making muddy water.

THE COURT: The very instant this material passes into a larger mesh and you have a larger particle, it will overcome that resistance?

MR. KENYON: Yes, sir, and then the weight increases by the cube, whereas the resistance only increases by the square.

THE COURT: I see.

MR. KENYON: That is the mathematical theory of the whole thing. So, the coarser the grinding the better these water separation processes were, the greater the difference in specific gravity. But what you ran up against there was the fact that in the heart of a grain of gangue there might be a particle of metal, and you have lost it by not grinding fine. So there the millers were between the Devil and the deep sea.

MR. KENYON: It has been shown that the processes of the patents in suit depend in part at least upon certain simple facts of physical science that are observable to the knowing eye, and that clearly distinguish them from the prior art. We have shown that these processes are not oil-foam or oil-froth processes, or oil-emulsion processes, or aerated oil-flotation processes in any proper sense, but are processes of air-flotation: processes that effectively evoke the power of air to select out the metal from the gangue in a freely flowing pulp, and to float it to and through the surface for separation.

Air has little affinity for oil as such, and air-bubbles do not readily attach themselves to oil globules, and have slight lifting power when so attached. If a particle of mineral lies entrapped in an oil globule, or has an oil globule attached to it, an air bubble coming in contact with the oil globule will take away a portion of the oil, but will have little tendency to attach itself to the mineral. Therefore, while air bubbles may be mechanically caught and entrapped in oil, and may

in that way, increase and greatly increase the mass buoyancy of the oil, that is, its power to raise mineral particles that are also caught and entrapped within it, this action of the air (which had been suggested in the oil-foam processes of the prior art) is not secured unless the amount of oil is sufficient and the character of oil suitable to so mechanically embrace and entrap both air and mineral. That is, the oil must be viscous.

Air has a powerful affinity for clean, metallic, sulphide surfaces. This affinity is defeated for all practical ore concentration purposes in the mill when the mineral surfaces are coated with so much oil as to exhibit the physical properties of oil as such, such as adhesion to other similar oiled mineral surfaces, as in the Cattermole process, or adherence to an oil lake or to an oil foam mass and resultant buoyancy flotation, as in the Elmore process, the *California Journal* process, and so forth. But when the film of oil on the metallic surfaces is extremely attenuated (as when 1% of oil to ore is employed) the affinity of air for metal is not merely undefeated; it seems to be positively increased (why, we do not know) so that for all practical ore concentration purposes in the mill the attachment will persist in and out of the pulp, and will survive any amount of excess agitation or of excess aeration in the pulp.

Air bubbles have vastly greater lifting power for metal particles than oil globules have, and especially the sort of air bubbles that are produced, either by agitation or by aeration, in water modified by the reagents of the patents in suit.

Air bubbles in unmodified water, however produced, progressively and rapidly coalesce, and with explosive violence, which tends to explain the fact that such air bubbles, namely in unmodified water, will not practically concentrate ore.

Air bubbles in pulp modified by the reagents of the patents in suit have an enhanced selective affinity for metal over gangue (why, we do not know), and a persistence of life as bubbles in the pulp and a persistence of attachment to contacting metal particles in and out of the pulp sufficient (but why, again, we do not know) to permit in practice of ready separation and removal, and to result thereby in effective ore concentration.

THE COURT: You say "Why, we do not know." Is there any theory on that subject?

MR. KENYON: We have presented no theory.

THE COURT: You have no theory?

MR. KENYON: We have no theory. Dr. Sadtler says variation

of surface tension explains the phenomenon, but how I do not know. I do not know how variation of surface tension can enhance selective affinity, or how it can explain persistence of life as bubbles in and out of the pulp, or how it can explain persistence of attachment to contacting metal particles in and out of the pulp, to such a degree that practical ore concentration in a mill is an accomplished fact.

Whatever the explanation of the phenomena involved, it is clear that the operation proceeds by contact of air and metal in a freely flowing pulp under circumstances conditioned by the presence of the reagents of the patents in suit, and opportunity of flotation after contact.

THE COURT: You say the contact between the air and the mineral particles?

MR. KENYON: In the pulp.

THE COURT: Now, if the mineral particle has a film of oil, no matter how thin, how is there any actual physical contact between the air and that particle?

MR. KENYON: The mystery of the thing is that when the oil film of the attenuated character that is produced with one-tenth of 1% of oil to the ore, when that film is present on the metal particle, the air particle has an enhanced appetite for it, seeks it with increased avidity, instead of with diminished or defeated avidity such as a thicker film will produce.

THE COURT: And it seeks it through that very thin film?

MR. KENYON: Seeks it through that very thin film, as it were—that helps.

THE COURT: Not through the actual contact, but through the film being so very attenuated, it seeks the metal particle, and the interposition of the film, far from lessening the selective action of the air for the metal, enhances it—is that right?

MR. KENYON: Yes, that is right, and Dr. Sadtler on the stand suggested an idea that may help a little. He said that an attenuated film of that kind might possibly be conceived of as smoothing the roughness of the surface of cleavage of the sulphide particles.

MR. WILLIAMS: That was Dr. Liebmann.

MR. KENYON: Dr. Liebmann?

THE COURT: Increasing the effect?

MR. KENYON: Increasing the attachment or appetite of the air bubble for that surface so smoothed.

MR. WILLIAMS: In fact, they both suggested it.

MR. KENYON: Yes, Dr. Liebmann also suggested that idea; and

Mr. Dosenbach, as I remember, said that when these particles had rough surfaces the air bubble would not hold them. It is the smooth surface that the air bubble gets its grip on. Now, this microscopic film of oil may fill up microscopic cavities, may bridge over microscopic roughnesses, may make smooth what was before rough, and in that way enhance the avidity of the air particle for it, and the grip of the air particle upon it; but I present that with diffidence. That is a matter of speculation.

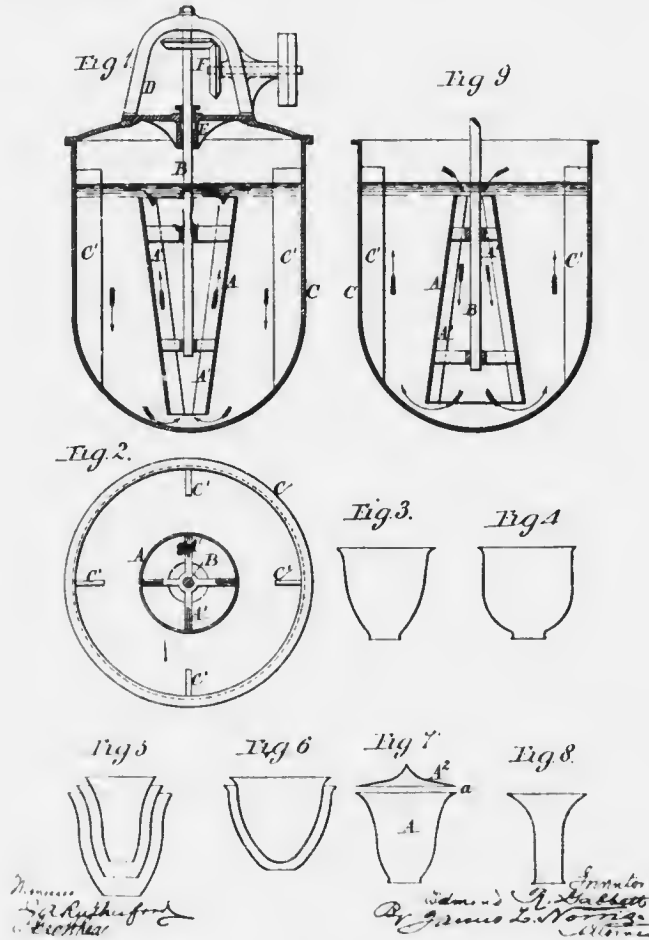

FIG. 41. THE GABBETT MIXER.

REDUCED FACSIMILE OF DRAWING IN E. R. GABBETT'S PATENT NO. 444,345, OF JANUARY 6, 1891.

TUE COURT: You have the evidence on both sides for that, so I do not suppose counsel on either side will contest it.

MR. KENYON: That is so, but with all respect to both witnesses, I present the suggestion with diffidence.

But now let me state again what are the clear essentials from the point of view of operation, whatever the explanation of phenomena. Whatever the explanation of the phenomena involved, it is clear that the operation proceeds by the contact of air and metal in a freely flowing pulp under circumstances conditioned by the presence of the reagents of the patents in suit, and opportunity of flotation after contact. You have got to bring your bubble and your metal particle into contact in this freely flowing pulp, and under circumstances conditioned by the presence of the reagents of the patents in suit. But to have brought them into contact—that is not enough. There must be another factor, namely, opportunity of flotation after contact, so that you may separate—flotation up in the pulp and through the surface of the pulp—so that you may practically separate them.

TUE COURT: Those are essentials in the flotation.

MR. KENYON: Those are the *sine qua nons*, and those are the only *sine qua nons* if we have presented the proper theory of operation.

And as to apparatus, it is clear, too, that apparatus for efficiency bringing about in a freely flowing pulp the contact of air and metal under the conditions stated, and for permitting or assisting flotation after contact, is all that is required.

It has been shown not only that the fine and slime that were practically unconcentratable in the prior art, except perhaps by Cattermole—I say 'perhaps' because Cattermole never reached the mill. On the threshold of the mill the life of the Cattermole process was cut off by this greater child of the brains of Sulman, Picard, and Ballot.

It has been shown not only that the fine and slime that were practically unconcentratable in the prior art (except perhaps by Cattermole) can be successfully concentrated by the processes in suit, but also that the presence of such fine and slime in the pulp actually assists the concentration of the ore, and is indeed almost essential to practical success; so much so that the art of grinding has been revolutionized where the processes in suit are employed and fine grinding has become the rule, where before it would have been the ruin, of the mill.

The history of what happened in the practical art before the

inventions in suit were made, and of what has happened in the practical art since that time, shows that while ways and means of bringing about contact of air and metal in the pulp and of permitting or assisting flotation after contact may be widely varied, the success of the process is sharply conditioned within relatively narrow limits in the matter of the quantity of reagent employed, when that reagent is the oil of the first patent. Especially is this true and crucial in the case of the first patent in suit, since it has been demonstrated beyond dispute that any notable increases of oil above the minute proportion there specified practically defeats the end in view and would in the mill practically prevent the concentration desired, and would be, not only intolerable, as a dirty and utterly non-controllable mill operation, but impossible, as giving at greatly enhanced cost a greatly depleted and inferior product.

Now, why the bubbles have enhanced selective affinity for metal over gangue, and why they have enhanced persistence of life as bubbles in and out of the pulp, no one really knows. No one really understands today why the process works as it does work. Under such circumstances prevision was impossible. And where prevision is impossible, nothing can anticipate except the very thing.

THE COURT: That would indicate that this was a discovery rather than an invention of a process.

MR. KENYON: Yes. It started with a discovery. As a process it became an invention.

CYANIDE TREATMENT OF FLOTATION CONCENTRATE

By CHARLES BUTTERS AND J. E. CLENNELL

(From the *Mining and Scientific Press* of November 20, 1915)

When Charles Butters began to take up the work of flotation in our Oakland laboratory, one of the first points brought to our attention was the treatment of the concentrate produced by flotation; J. E. Clennell was accordingly instructed to undertake the researches detailed in the present paper.

The whole value of the process hinges on two points, namely, the grade of tailing produced and the net realization of the value contained in the concentrate, these two considerations being of equal importance. This last point is complicated by questions of geographical situation, for if the concentrate cannot be treated locally the cost of realization may be so heavy that flotation would be entirely precluded.

The results obtained in our laboratory by the combination of flotation and cyanide have been so remarkable that a serious study of the disposal of concentrates has been forced upon us.

The difficulties attending the treatment of concentrate by cyanide are well known. The process of concentration collects in a small bulk not only the valuable constituents of the ore but also those substances that act as cyanicides, or which are readily converted by oxidation or otherwise into cyanicides, so that their influence, per ton of material treated, is greater than would be the case with the unconcentrated ore. Heavy minerals such as the sulphides of iron, copper, lead, arsenic, antimony, zinc, and double sulphides such as mispickel, proustite, pyrargyrite, and bornite, naturally tend to accumulate in the concentrate. If some interval elapses between the formation of this concentrate and its treatment, oxidation may take place, with formation of sulphates, arsenates, and antimonates, which are still more detrimental to cyanide treatment than the original minerals. These difficulties have been wholly or partly overcome by the adoption of modifications in the treatment, such as preliminary water, acid, or alkali washing, roasting, fine grinding, the use of special solvents, such as bromo-cyanide, and prolonged contact of the material with cyanide, extending in some cases to over a month.

In the case of concentrate produced by flotation, the minerals composing the product are substantially the same as those obtained by gravity concentration, consisting of the sulphides and double

sulphides of the heavy metals, and it is to be expected that the same difficulties will be encountered in their treatment. But as the concentrate also contains a considerable part of the oil, tar, or other flotation agent, the presence of this foreign matter must be taken into account. In some cases, this circumstance introduces an additional difficulty. A part of this organic matter is soluble in the cyanide or alkali used in the process, and the solution so formed may be capable of absorbing oxygen. The effect produced by carbonaceous matter in precipitating gold and silver previously dissolved by cyanide is well known and has been a source of much trouble in many localities. Some of the constituents of this matter are not easily eliminated and appear to resist oxidation even at a high temperature; roasting under ordinary conditions does not completely remove the carbon; it is probable that a portion derived from tar remains in the graphitic form, capable of acting as a precipitant for gold or silver.

The experiments detailed below were made on concentrates produced from typical gold and silver ores by a modified type of the Minerals Separation flotation machine. Most of the tests were made in neutral or alkaline media. The frothing agents employed were those in general use, consisting of tar, creosote, carbolic acid, pine-oil, and fuel-oil. It is not proposed to discuss these in detail in the present paper; it will be sufficient to state that the concentrate was collected and drained on a vacuum-filter and in some cases dried at a moderate temperature before treatment.

As an example of an ore in which the value consists essentially of gold we may take the product of the San Sebastian mine, in Salvador, operated by the Butters Salvador Mines, Ltd. For preliminary work a composite sample was made from 21 lots taken from different parts of the mine, and concentrate produced by treating the finely crushed ore in a 10-lb. flotation machine. The sample taken for this test assayed originally 1.54 oz. gold and 0.28 oz. silver. The concentrate obtained by flotation assayed 4.92 oz. gold and 1.14 oz. silver. As this constituted 25% of the weight of ore taken, the gold recovered in the concentrate amounted to 79.9% of the total. An analysis of the concentrate showed:

	%		%
Insoluble	44.3	Iron	24.3
Sulphur	23.2	Copper	0.3

together with small quantities of molybdenum, tellurium, and other elements. The tailing carried 0.04 oz. gold per ton.

TABLE I
SUMMARY OF RESULTS IN TREATMENT OF RAW CONCENTRATE

		Gold,	Silver,		
		Oz.	Oz.		
Head assay for all tests.....		4.92	1.14		
Dilution in all tests, 3:1.					

Test No.	Method.	Time, days.	Cyanide strength % KCN,	Chemicals consumed per ton.					Residue assay.		Extraction.	
				Cyanide, Lb.	Lead acetate, Lb.	BrCN, Lb.	Gold, Oz.	Silver, Oz.	Gold, %	Silver, %		
1.	Direct cyanide	3	0.25	32.7	4.38	1.06	11.0	7.0		
2.	"	3	0.5	39.1	3.88	0.88	21.1	22.8		
3.	"	3	1.0	52.3	3.46	0.70	29.7	38.6		
4.	With lead acetate.....	3	0.25	19.5	10	..	3.02	0.74	38.4	35.1		
5.	Preliminary NaOH	5	0.25	35.9	3.76	1.09	23.6	12.3		
6.	Preliminary NaOH + Al	5	0.25	35.9	3.68	1.00	25.2	12.3		
7.	Bromo-cyanide	8	0.25	41.1	..	8.3	1.20	0.68	75.6	40.4		
8.	Similar to No. 7, but without bromo-cyanide	8	0.25	35.5	3.50	0.86	28.9	33.3		

The first tests were made with the object of determining whether this material could be treated advantageously raw by agitation with cyanide. In addition to direct cyanide treatment various modifications were tried, as shown in Table I, including addition of lead acetate, preliminary alkali treatment, desulphurizing with alkali and aluminum, and bromo-cyanide. The last procedure showed a marked improvement over every other method of raw treatment, but still failed to yield a satisfactory extraction. The extraction was increased by increasing cyanide strength, but with strong solution the consumption of cyanide became prohibitive, and alkaline sulphides were formed. This effect can be prevented and cyanide consumption much reduced by addition of lead acetate, some improvement in extraction being obtained. Preliminary alkali treatment with or without aluminum showed no benefit whatever. The fact that bromo-cyanide has a marked effect on the extraction suggests that a portion of the gold may be present as a telluride. This conclusion is supported by experiments made by direct treatment of the original ore, without concentration; these tests showed that a certain proportion of the gold is inaccessible to cyanide even after very fine grinding and prolonged contact. (See Table XI.)

As these results did not appear encouraging for any system of raw treatment, attention was next turned to roasting. It was soon found that roasting within certain limits of temperature converted a considerable part of the copper into sulphate, which could be leached with water, together with some sulphate of iron, leaving the residue in a favorable condition for cyanide treatment. Preliminary acid wash of the roasted material was also tried; this would have the advantage of dissolving a further quantity of copper that might have become converted into oxide in the roasting, but the results show that the benefit obtained would not warrant the additional cost. Another test was made in which the concentrate was cyanided raw before roasting and acid-washing, and re-cyanided after the washing; this also showed no advantage either in extraction or cyanide consumption over direct roasting, water-wash, and cyanide. In all cases the roasted material was agitated with cyanide, using a dilution of 3:1. The results obtained by these three methods are shown in the following table. (No. II.)

In Test No. 2 the acid-washing was made with 1% H_2SO_4 , using approximately 5 tons of wash per ton of concentrate treated. Before agitation with cyanide, the pulp was re-ground in a model tube-mill with glass marbles.

TABLE II
COMPARATIVE RESULTS OF CYANIDING AFTER ROAST WITH VARIOUS PRELIMINARY TREATMENTS

Test No.	Time under cyanide, Days.	Strength used KCN, %	Cyanide consumed per ton of raw concentrate, lb.	Weight of 1 ton raw concentrate after treatment, Ton.	Assay of raw concentrate.		Assay of roasted and washed concentrate.		Residue of treated material.		Calculated residue on raw concentrate.		Recovery based on raw concentrate.	
					Gold, oz.	Silver, oz.	Gold, oz.	Silver, oz.	Gold, oz.	Silver, oz.	Gold, oz.	Silver, oz.	Gold, %	Silver, %
1	3	0.25	4.20	0.792	4.92	1.14	6.20	1.44	0.15	1.37	0.12	1.09	97.5	4.9
2	3	0.25	6.49	0.790	4.92	1.14	6.28	1.36	0.125	1.20	0.10	0.95	98.8	11.1
3	6	0.10	8.93	0.773	4.92	1.14	5.44	1.44	2.00	1.28	1.55	0.99	64.9	10.9

*In calculating 'recovery,' allowance is made for losses of gold and silver in roasting.

Test No. 1. Oxidizing roast, water-wash, and cyanide.

Test No. 2. Oxidizing roast, acid-wash, and cyanide.

Test No. 3. Cyaniding raw, roasting, acid-wash, and re-cyaniding.

In Test No. 3 the preliminary raw treatment was made with 0.1% KCN using a dilution of 2:1, for two days; the extraction of gold was 12%. Acid treatment was made with 1% H_2SO_4 , dilution 1:1, agitated 18 hours, and then leached with water before cyaniding. Roasted and washed concentrate agitated with cyanide for 4 days.

Test No. 1 on Table II indicates that the flotation concentrate from the San Sebastian ore may be successfully treated by a simple process of roasting, water-washing, and cyaniding. This conclusion was confirmed by numerous experiments on a large scale in which the material was roasted in a hand-reverberatory furnace, and the roasted product treated by agitation in tanks with mechanical stirrers, adding water, settling, and decanting until the bulk of the copper and iron salts was removed, finally collecting the material on a vacuum-filter and washing on the filter to remove the last traces of soluble salts. The washed concentrate was then re-pulped with lime and cyanide solution in an agitation-tank, and treatment continued in the ordinary way. The results of the bottle tests were fully confirmed.

Attempts to treat the material by percolation were not successful. Owing to the fine grinding of the ore previous to flotation, the roasted material showed a tendency to slime; percolation took place slowly and irregularly, through channels formed in the mass, so that the extraction by this means was always imperfect.

In the tests made in the large muffle the oxidation was somewhat more effective, but a rather longer time was required to reach the temperature at which roasting began. Temperature was approximately determined by Seger cones.

On examining the details of Table III, it will be apparent that the most favorable results were obtained when roasting was carried out at a low temperature; under these conditions a maximum amount of copper was extracted by water-washing, and the highest extraction of gold obtained with a minimum cyanide consumption.

In this ore the silver is negligible, but it is significant that the silver extraction on the roasted material is poor in all cases. This condition will be noted in most cases where attempts have been made to treat silver ores by cyanide after an oxidizing roast.

With these results as a guide, tests were made on a larger scale on the same material, roasted by hand in an oil-fired reverberatory furnace. A charge of about 400 lb. was dried slowly in a sample drier, and charged into the furnace; the temperature was gradually

TABLE III
BOTTLE-AGITATION TESTS ON CONCENTRATE ROASTED AT DIFFERENT TEMPERATURES

In each case 100 grams of concentrate was roasted in the muffle, and a test made of the roasted material, after water-washing. The charge for cyanide treatment was as follows:
Roasted and washed concentrate, 60 gm. Lime, 0.6 gm. Solution, 180 cc. 0.5% KCN. Agitated at intervals for 3 or 4 days and solution strength maintained at 0.5% KCN.

Test Muffle No. used.	Temp. of roast, Deg. C.	Time of roast, Min.	Weight of 1 ton		Copper extracted per cent of raw concentrate.		Total, %	Cyanide consumed Per ton of washed Conc., Lb. Conc., Lb.
			After roast, Ton.	After wash, Ton.	By water, %	By cyanide, %		
1. Small	590	55	0.811?	0.785?	0.244	0.083	0.327	6.5
2. Large	590	65	0.849	0.825	0.242	0.145	0.387	9.2
3. Small	620	60	0.848	0.830	0.207	0.165	0.372	8.9
4. Large	620	80	0.849	0.840	0.040	0.185	0.225	12.0
5. Small	650	75	0.853	0.832	0.189	0.096	0.285	9.0
6. Large	650	65	0.848	0.839	0.061	0.128	0.189	10.0
7. Small	under 590	87	0.867	0.836	0.287	0.078	0.365	6.6
8. Large	"	70	0.877	0.854	0.406	0.063	0.469	4.4
9. Large	"	60	0.878	0.839	0.428	0.052	0.480	6.4

Gold, Silver, Oz. Oz.
Assay of raw concentrate in each case..... 3.50 0.89

TABLE III—(Continued)

Test No.	Roasted concentrate.		Head assays.		Roasted and washed concentrate.		Roasted and washed concentrate, calc. on raw.		Residue assays after cyanide.		Calculated on raw concentrate.	
	Gold, Oz.	Silver, Oz.	Gold, Oz.	Silver, Oz.	Gold, Oz.	Silver, Oz.	Gold, Oz.	Silver, Oz.	Gold, Oz.	Silver, Oz.	Gold, Oz.	Silver, Oz.
1	3.90	0.99	4.02	1.02	3.16	0.80	3.16	0.80	0.13	0.77	0.10	0.60
2	3.89	0.90	4.00	0.94	3.30	0.76	3.30	0.76	0.06	0.72	0.05	0.59
3	3.95	0.98	4.04	1.00	3.35	0.83	3.35	0.83	0.07	0.79	0.06	0.66
4	4.05	1.01	4.10	1.02	3.44	0.86	3.44	0.86	0.09	0.86	0.08	0.72
5	4.06	1.03	4.16	1.06	3.46	0.83	3.46	0.83	0.08	0.82	0.07	0.68
6	3.96	1.01	4.00	1.02	3.36	0.86	3.36	0.86	0.07	0.82	0.06	0.69
7	3.91	0.95	4.06	0.98	3.39	0.82	3.39	0.82	0.06	0.72	0.05	0.60
8	3.97	1.04	4.08	1.06	3.48	0.91	3.48	0.91	0.055	0.64	0.05	0.55
9	3.97	0.88	4.16	0.92	3.49	0.77	3.49	0.77	0.08	0.58	0.07	0.49

Test No.	Lost in roasting and washing.		Days under cyanide.	Extraction		Recovery	
	Gold, Oz.	Silver, Oz.		On roasted and washed concentrate.	Calc. on raw concentrate.	Calc. on raw concentrate.	Calc. on raw concentrate.
1	0.34	0.09	4	96.8	97.1	87.4	22.5
2	0.20	0.13	4	98.5	98.6	92.9	19.1
3	0.15	0.06	4	98.2	98.3	94.0	19.1
4	0.06	0.03	4	97.8	97.7	96.0	15.7
5	0.04	0.01	3	98.1	98.0	96.9	15.7
6	0.14	0.03	3	98.2	98.3	94.3	22.5
7	0.11	0.07	3	98.5	98.6	95.4	19.1
8	0.02	...	3	98.7	98.6	98.0	24.7
9	0.01	0.12	3	98.1	98.0	98.0	40.4

raised till it approximated that obtained in the muffle-roasts, probably about 550° C. After 3½ hours, the flame was turned off and the charge allowed to cool in the furnace over-night. The concentrate roasted in this way, showed little or no tendency to sinter or form lumps, but in subsequent tests when the material was charged without previous drying, portions of the concentrate agglomerated into comparatively hard lumps, which contained a core of unroasted material, and which it was necessary to sift out and re-roast after grinding. Possibly in practice it would be advisable to pass the material, after drying and before roasting, through a ball-mill or similar pulverizer.

A bottle-test made on a scale of 100 gm. on a sample of roasted concentrate from the above reverberatory charge showed the following results:

TABLE IV

Copper extracted per cent of raw concentrate:		
By water-wash		0.435
By cyanide		0.039
		0.474
Total		0.474
Cyanide consumed per ton of washed concentrate.....	5.03 lb.	
Cyanide consumed per ton of raw concentrate.....	4.21 lb.	
Under cyanide treatment	3 days	
1 ton raw concentrate = 0.837 ton washed.		
	Gold,	Silver,
	Oz.	Oz.
Assay of roasted concentrate	3.70	0.86
Assay of washed concentrate	3.90	0.94
Assay of washed concentrate calculated on raw concentrate	3.26	0.79
Loss per ton of raw concentrate.....	0.24	0.10
Residue assay on washed concentrate.....	0.05	0.60
Residue assay calculated on raw concentrate.....	0.04	0.50
	%	%
Extraction on roasted and washed concentrate.....	98.7	36.2
Extraction calculated on raw concentrate.....	98.9	43.8
Recovery calculated on raw concentrate.....	92.0	32.6

The loss shown in this test seems to be mostly mechanical, due to dust carried off while stirring the charge; it could probably be much reduced by using a suitable roaster with revolving rabbles and a dust-chamber.

AGITATION TESTS

The following tests were made in small tanks fitted with wooden paddles.

No. 1. Agitated with cold water, washed by settlement and decan-

TABLE VI

TESTS MADE BY PERCOLATION

	No. 1.	No. 2.	No. 1.	No. 2.	No. 1.	No. 2.
Weight of roasted concentrate taken.....	100 lb.	32 lb.*	Cyanide consumed per ton raw concentrate (lb.)	5.44	2.32	
Total preliminary water-wash used per ton of roasted concentrate (tons).....	3.48	3.92*	Solution used per ton of roasted concentrate (tons)	2.63	1.46	
Lime added per ton (lb.).....	30	26	Final water-wash per ton of roasted concentrate (tons)	0.92	0.41	
Strength of solution used (KCN).....	0.25%	0.25%	Time of cyanide treatment (days).....	3	5	
Cyanide consumed per ton of roasted concentrate (lb.)	6.48	2.77	Depth of charge for percolation (inches).....	24	10	
			*Hot water used, and ore charged into tank while hot (200°F.).			
(a) Residue of roasted and washed concentrate after KCN.....				Test No. 1. Gold, Oz.	Test No. 2. Gold, Oz.	
(b) Residue calculated on raw concentrate.....				0.65	3.00	
After extra wash in laboratory.....				0.54	0.77	
				0.22	0.64	
(a) Extraction on roasted concentrate.....				0.62	0.78	
(b) Extraction calculated on raw concentrate.....				0.52	0.65	
After extra wash in laboratory.....				%	%	
*Recovery based on raw concentrate.....				83.3	23.1	
Recovery after extra wash.....				84.6	18.1	
				94.4	28.3	
				94.9	28.1	
				77.7	17.0	
				88.0	48.0	
					21.4	
					16.9	
					15.7	

in calculating recovery, allowance is made for losses of gold and silver in roasting.

TABLE VII

Weight of united charge, 200 lb.	Tons.
A. Water per ton of charge.....	2.3
B. Solution, 0.147% KCN, per ton of charge.....	4.6
Additional cyanide consumed per ton of charge in treatment B (lb.).....	0.82
Total time for additional treatment.....	3 days

UNITED CHARGES FROM PERCOLATION AND AGITATION TESTS, AFTER ADDITIONAL WASHING

- (1) After further water-washing A.
- (2) Same with extra water-wash in laboratory.
- (3) After final cyanide-wash B and water-wash C.
- (4) Same with extra water-wash in laboratory.

	(1)		(2)		(3)		(4)	
	Gold,	Silver,	Gold,	Silver,	Gold,	Silver,	Gold,	Silver,
	Oz.	Oz.	Oz.	Oz.	Oz.	Oz.	Oz.	Oz.
Residue on roasted concentrate.....	0.07	0.59	0.06	0.62	0.06	0.59	0.05	0.60
Residue calculated on raw concentrate.....	0.06	0.49	0.05	0.52	0.05	0.49	0.04	0.50
	%	%	%	%	%	%	%	%
Extraction on roasted concentrate.....	98.2	37.2	98.5	34.0	98.5	37.2	98.7	36.2
Extraction calculated on raw concentrate....	98.3	44.9	98.6	41.6	98.6	44.9	98.9	43.8
Recovery calculated on raw concentrate.....	91.4	33.7	91.7	30.3	91.7	33.7	92.0	32.6

TABLE VIII

TESTS ON INFLUENCE OF CYANIDE STRENGTH

Charge for each test: roasted and washed, 100 gm.; lime, 1 gm. = 20 lb. per ton; solution, 300 c.c. = dilution 3:1.

Time under cyanide treatment..... 4 days

Weight of 1 ton raw concentrate after roast.....0.865 ton

Weight of 1 ton after roast and wash.....0.811 "

	Gold, Silver, Oz.	Gold, Silver, Oz.
Assay of raw concentrate.....	4.88	1.12
Assay of roasted concentrate.....	5.35	1.24
Assay of roasted and washed concentrate:		
1st series.....	5.72	0.82
2nd series.....	5.68	1.32
Assay of roasted and washed concentrate calcu- lated on raw concentrate:		
1st series.....	4.68	0.67
2nd series.....	4.61	1.07

Test No.	Copper extraction per cent of raw concentrate.		Total, %	Strength of cyanide used, KCN, %	Cyanide lb. consumed.	Residue assays.	
	By water-wash, %	By cyanide, %				On roasted and washed concentrate.	Calculated on raw concentrate.
Series No. 1:							
1	0.364	0.026	0.390	0.50	6.23	5.12	0.63
2	0.364	0.024	0.388	0.25	3.18	2.60	0.63
3	0.364	0.027	0.391	0.125	2.30	1.88	0.61
4	0.364	0.022	0.386	0.062	2.36	1.93	0.62
Series No. 2:							
5	0.411	0.034	0.445	0.50	6.20	5.03	0.66
6	0.411	0.036	0.447	0.25	4.42	3.58	0.68
7	0.411	0.040	0.451	0.125	3.19	2.59	0.71
8	0.411	0.038	0.449	0.062	3.44	2.79	0.72

THE FLOTATION PROCESS

TABLE VIII—(Continued)

Series No.	Test No.	Extraction on roasted and washed concentrate.		Extraction calculated on raw concentrate.		Recovery calculated on raw concentrate.	
		Gold, %	Silver, %	Gold, %	Silver, %	Gold, %	Silver, %
1	1	98.4	23.2	98.5	53.4	94.4	13.4
	2	98.3	23.2	98.3	53.4	94.2	13.4
	3	98.3	25.6	98.3	55.4	94.2	15.2
	4	98.1	24.4	98.2	54.5	94.1	14.3
2	5	98.6	50.0	98.6	51.8	93.1	47.3
	6	98.6	48.5	98.6	50.9	93.1	46.4
	7	98.3	46.2	98.4	48.2	92.9	43.7
	8	98.2	45.5	98.4	48.2	92.8	43.7

TABLE IX

EFFECT OF VARYING TIME OF TREATMENT

Charge for test as in Tests Table VIII.

1 ton roasted concentrate = 0.919 ton after water-wash.

	Gold, Oz.	Silver, Oz.	Calculated assay of roasted Strength of solution maintained at 0.1% KCN.	Gold, Oz.	Silver, Oz.	
Assay of roasted concentrate.....	4.05	2.45		4.15	2.43	
Assay of roasted and washed.....	4.52	2.64				
				Test No. 1.	Test No. 2.	
				Time of cyanide treatment (hours).....	28	71
				Cyanide consumed per ton treated (pounds)	1.50	3.70
				Test No. 1.	Test No. 2.	
Residue of roasted and washed concentrate.....	Gold, Oz.	Silver, Oz.		Gold, Oz.	Silver, Oz.	
Residue calculated on roasted concentrate.....	0.095	1.73		0.09	1.61	
	0.087	1.59		0.083	1.48	
	%	%		%	%	
Residue of roasted and washed concentrate.....	97.9	39.8		98.0	43.9	
Extraction calculated on roasted concentrate.....	97.9	35.1		98.0	39.6	

tation, then drained by vacuum on a horizontal filter-tray; re-pulped with lime and cyanide solution.

No. 2. Agitated with hot water, washed by settlement and decantation, neutralized with lime and agitated with cyanide without previous filtration. Cyanide treatment by decantation, finally washing without water.

PERCOLATION TESTS

Portions of the same roasted charge as were used for the previous tests were leached in tanks with a canvas filter, using vacuum to aid filtration. After washing out soluble salts as far as possible in this way, the residue was mixed with lime and treated by percolation with cyanide solution in the same manner.

In view of the unsatisfactory results obtained by percolation and the fact that further extraction was made by increased water-washing, the residue of charge No. 1 was mixed with the residue of charge No. 1 treated by agitation (see Table V) and the united charge agitated further with water, then with weak cyanide solution and finally with water again.

The result of these tests indicates that thorough washing is essential for a high extraction. Filtration without vacuum was found to be practically impossible.

The following tests were made on another portion of roasted concentrate, to determine the influence of cyanide strength on extraction. Eight tests were made; in the first four a preliminary wash was given with hot salt solution, 10% NaCl using 2 tons of material treated. In the remaining four tests the preliminary wash was given with water alone, using 4 tons per ton of material. The salt wash showed some extraction of silver, but it does not appear that any advantage derived from this would warrant the additional cost.

The cyanide treatment is detailed in the accompanying tables:

From these results it appears that the extraction is scarcely affected by variation of cyanide strength within the limits and under the conditions of the tests. The cyanide consumption, however, increases with increasing strength. Apparently the best results are obtained with a strength of 0.125% KCN.

Two tests were also made on another portion of roasted concentrate from the same lot of ore to determine the influence of time on the cyanide treatment.

From this test it is evident that the gold in the roasted concentrate is rapidly soluble in cyanide. The small insoluble portion

TABLE X

	Test No. 1.—		Test No. 2.—		Test No. 3.—	
	Gold, Oz.	Silver, Oz.	Gold, Oz.	Silver, Oz.	Gold, Oz.	Silver, Oz.
Weight of roasted concentrate treated (gm.)	150	150	125*	125*	150	150
1 ton raw = roasted (ton)	0.801	0.801	0.788	0.788	0.854	0.854
1 ton raw after chlorination	?	?	?	?	0.834	0.834
Assay of raw concentrate	4.92	1.14	4.92	1.14	3.50	0.89
Assay of roasted concentrate	6.24	1.28	6.18	1.30	3.87	1.09
Roasted concentrate, calculated on raw	5.00	1.03	4.87	1.02	3.50	0.93
Residue of roasted, after chlorination	0.14	1.32	0.15	1.33	0.12	1.08
Residue calculated on raw	0.11	1.06	0.12	1.05	0.10	0.90
Actual recovery by precipitation with FeSO ₄ :						
Per ton of roasted	6.09	...	5.49	...	3.84	...
Per ton of raw	4.88	...	4.27	...	3.28	...
Extraction.	%	%	%	%	%	%
On roasted concentrate	97.8	...	97.6	...	97.1	0.9
Calculated on raw	97.8	7.0	97.6	7.9	97.1	...
Recovery from raw concentrate:						
(a) Based on residue assays	99.4	...	96.5	...	91.4	...
(b) Based on FeSO ₄ precipitation	99.2	...	86.9	...	93.6	...

*Ground to pass 200-mesh before chlorination.

seems to be quite inaccessible to prolonged treatment or to stronger solutions.

The foregoing tests sufficiently indicate that the San Sebastian concentrate, produced by flotation, may be treated successfully on a commercial basis by the method of roasting, water-washing, and cyaniding. Some tests were, however, made by alternative methods for the purpose of comparison.

The processes thus tried were:

1. Chlorination by saturating the roasted charge with chlorine gas and leaching with water, as in the old Plattner process.
2. Direct cyanide treatment of the raw ore after fine grinding in a tube-mill with steel balls.

CHLORINATION TESTS

A charge of roasted concentrate was moistened with about 15% of water, and placed loosely, without any paper or other filter, in a porcelain funnel with flat perforated diaphragm. Chlorine gas was introduced from below through the neck of the funnel, and after saturation, the charge was allowed to stand covered for 24 hours. It was then leached out with water and the residue dried and assayed. The extraction was found by difference of head and tail assays; it was also checked by precipitating the filtrate with ferrous sulphate, allowing to settle and collecting the deposited gold on a filter. This was dried and cupelled.

In one case the residue after chlorination was further treated by agitation with cyanide. The results obtained by chlorination are detailed in the accompanying table.

The residue from test No. 3 (Table X) was further treated by cyanide, by agitation for 4 days with a solution originally at 0.2% KCN, and increased toward the end of the treatment to 0.5% KCN, using a dilution of 3:1. This treatment yielded the following results:

	Gold,	Silver,
	Oz.	Oz.
Final residue after cyanide treatment.....	0.07	0.87
	%	%
Extraction from chlorination tailing.....	41.7	19.4
Total extraction from raw concentrate.....	98.3	18.4

From these figures it would seem that the results to be expected from chlorination, or from chlorination followed by cyanide, are in no way superior to those obtainable by water-washing and cyanide. Either method will give a satisfactory extraction and the choice would depend on relative cost under local conditions.

DIRECT CYANIDING OF RAW ORE

It is interesting to compare the results obtained on this ore by direct cyaniding without any form of concentration, with those given by the combination of flotation and cyanide.

The following tests were made on portions of the same lot of ore as was used for tests detailed in the preceding tables. Three charges were treated; the first two were taken from a portion crushed in a small tube-mill with manganese-steel balls, using the following quantities:

Ore, 25 lb.; lime, 0.25 lb.; water, 17 lb.

Time of grinding, 6 hours.

The pulp was drained on vacuum-filter to 26.4% moisture.

The third test was made on part of a larger portion of ore crushed in the same manner, but in a larger mill, for use with a 200-lb. flotation machine.

TABLE XI

DIRECT CYANIDING OF RAW ORE, WITHOUT CONCENTRATION

	Test No. 1.	Test No. 2.	Test No. 3.
Wet weight of ore taken (gm.)	708	708	100
Dry weight of ore taken (gm.)	521	521	95
Solution added (cc.)	1,457	1,457	300
Lime added, per ton of ore (lb.)	21.1
Strength of solution maintained at KCN	0.1%	0.2%	0.2%
Final dilution of pulp	3:1	3:1	3:1
Time under cyanide treatment (days)	5	5	3
Cyanide consumed per ton of ore (lb.)	4.80	6.32	4.76

	Test No. 1.		Test No. 2.		Test. No. 3.	
	Gold, Oz.	Silver, Oz.	Gold, Oz.	Silver, Oz.	Gold, Oz.	Silver, Oz.
Head assay	0.625	0.16	0.625	0.16	0.895	0.13
Residue assay	0.205	0.07	0.16	0.04	0.155	...
Extraction (%)	67.2	56.2	74.4	75	82.7	..

CYANIDE TREATMENT OF FLOTATION TAILING

A flotation test was made on the ore used in Test No. 3 (Table XI), resulting as follows:

Product.	Weight, %	Assay-value.		Percentage of total value.	
		Gold, Oz.	Silver, Oz.	Gold,	Silver,
Head	...	0.895	0.13
Concentrate	12.45	6.53	1.04	90.8	99.6
Middling	11.45	0.35	...	4.5	...
Tailing	76.10	0.055	...	4.7	...

The tailing thus produced was agitated with cyanide, with results as shown below:

TABLE XII

CYANIDE TREATMENT OF RAW FLOTATION TAILING

Wet weight of tailing taken, 100 gm.
 Moisture, 7.4%. Dry weight, 92.6 gm.
 Lime added, 1 gm. = 21.6 lb. per ton of tailing.
 Strength of solution maintained at 0.2% KCN.
 Dilution of final pulp, 3:1.
 Time under cyanide treatment, 3 days.
 Cyanide consumed per ton of tailing, 1.40 lb.

	Gold, Oz.
Assay before cyaniding	0.055
Assay after cyaniding	0.0125
Extraction	77.3%

COMPARISON OF METHODS

For the sake of comparison, we may assume in view of previous results that an extraction of 98% could be obtained from the concentrate yielded by the above flotation test, by the method detailed, namely, roasting, water-washing, and cyaniding. The values shown in the middling may be eliminated on the assumption that in practice the middling would be constantly returned to the head of the machine, and that finally only two products would be obtained, concentrate and tailing, having the same assay-values as in the test. The result of the flotation test would then appear as follows:

Product.	Weight, %	Assay-value.		Percentage of total value.	
		Gold, Oz.	Silver, Oz.	Gold,	Silver.
Concentrate	12.97	6.53	1.04	94.6	103.8
Tailing	87.93	0.055	...	5.4
We have, therefore, per ton of raw ore:		Gold,		Percentage	
Recovered from concentrate:		Oz.		of total gold.	
$6.53 \times 0.1297 \times 0.98 = 0.830$				\$17.16	96.7
Recovered from tailing:					
$0.055 \times 0.8793 \times 0.773 = 0.037$				0.76	4.1
Total recovery		0.867		\$17.92	96.8
Heads		0.895		18.54	100

Taking the figure of Test No. 3 (Table XI) as indicating the possible recovery by direct cyanide treatment we have:

	Gold, Oz.	Gold.	Percentage of total gold.
By direct cyaniding	0.74	\$15.30	82.7
Additional recovery by combined method..	0.127	2.62	14.1
		Per ton of concentrate.	

Flotation, 16c. per ton of ore = $\frac{0.16 \times 100}{13} = \1.25

Roasting	1.00
Extra labor, etc., in cyaniding.....	0.50

\$2.75

Per ton of raw ore, 2.75×0.1297 = 0.36

Net saving by combined method..... = 2.26

In addition to this there is a saving in cyanide consumption as follows, per ton of raw ore:

	Cyanide consumed.
By direct treatment	4.76 lb.
By combined treatment:	
Concentrate (say, 5 lb. per ton) 5×0.13	= 0.65 lb.
Tailing, 1.4×0.87	= 1.12
	1.77

showing a saving in cyanide of 2.99 lb.; taking cyanide at 16c. per lb. of KCN equivalent, this would amount to 48c. per ton of raw ore treated, bringing the total saving to \$2.74 or about \$9600 on a monthly output of 3500 tons.

The tests given in Table No. III show that about 0.4% of copper, or 8 lb. per ton of raw concentrate (in this case 2 lb. per ton of raw ore) can be extracted in a soluble form, and might be recovered as an additional source of revenue.

FLOTATION ON GOLD ORES

(From the *Mining and Scientific Press*, of November 20, 1915)

The Editor:

Sir—I was very much interested in the interview with Mr. Butters appearing in your issue of August 21, 1915.

Flotation promises in the future to take a very important part in the treatment of sulphide gold ores. It is going to be a serious competitor to the cyanide process, especially where the precious metals are locked up within the sulphides. At the present time there are many mills treating low-grade gold ores in California, Alaska, and Korea that employ only amalgamation and water-concentration (tables and vanners), the tailing being too low for a further profitable treatment by cyanidation.

Concentration results will no doubt in the future be improved by the application of flotation to the treatment of the slime. The extraction of sulphides from the sand can be done cheaply and efficiently on Wilfley or Card tables. The weakness of water-concentration methods during the past has been with the treatment of that product passing a 200-mesh screen commonly called 'slime.' The best concentrators on the market today make only an incomplete saving of the fine float sulphide mineral which in many cases accounts for a good part of the gold escaping in the final tailing. Flotation is the remedy. The Suan gold mine in Korea is an example.

There are a number of low-grade sulphide ores (Oriental Consolidated in Korea and the Alaska Treadwell) that do not require to be crushed finer than 25-mesh in order to free the sulphides from the gangue. Would such a coarse product, where a considerable portion of the sulphide remains on a 40 or 50-mesh screen, be suitable for an all-flotation process? I am inclined to favor in such cases a combination process consisting of tables for sand and flotation for slime.

Where the sulphide minerals are finely disseminated throughout an ore and comparatively fine grinding is necessary, I should think an all-flotation process would then be in order. However, those of us who have to do with the design of plants would insist upon large-scale tests before deciding on a flow-sheet. It is money wisely spent where big sums of money are involved in the final plant.

A. E. DRUCKER.

La Salada, Colombia, October 9.

THE ELECTRICAL THEORY OF FLOTATION

By THOMAS M. BAINS, JR.

(From the *Mining and Scientific Press* of November 27, 1915)

INTRODUCTION. If one turns to 'Elementary Lessons in Electricity and Magnetism,' by Silvanus Thompson and studies the fundamental principles of frictional electricity, as given in Chapter 1, a clearer idea of the causes of 'flotation' may be obtained. After seeing a few experiments, such as were performed at the Case School of Applied Science early in the year, it is not a difficult matter to believe that most of the phenomena are electrical in nature. For instance, if powdered galena ore, with a limestone gangue, be dropped into pure water, most of the powder will immediately sink to the bottom. As the air enclosed by the particles is expelled gradually, one sees the formation of 'armored' bubbles, some of which may last for days. Here is flotation without oil or acid. If nitric acid is added, the gas bubbles, formed by the action of the acid on the gangue, will carry up particles of galena, some reaching the surface and bursting, while others too heavily loaded with galena particles will hover just below the surface. These will form clusters, resembling bunches of grapes, and when enough gas bubbles join the clusters, they start upward toward the surface, but generally before reaching there they are overloaded by particles falling from the bubbles that are bursting at the surface. The bubbles with their loads often resemble balloons, with the galena hanging on to the bottoms, as do the baskets of actual balloons. Some of the bubbles will be completely 'armored' while others will be nearly free from galena. Another experiment that may be successfully used in the laboratory for the flotation of the difficult sulphides, such as old rusty pyrite concentrate, like sweepings from floors of old mills, is as follows: Mix the ore with bleaching powder, some carbonate (say, sodium carbonate), and water. Put the mixture into a glass beaker and add concentrated nitric until red nitrous fumes are given off. Chlorine also will be evolved. The bubbles of gas are so highly charged electrically that pyrite from the Mother Lode between 10 and 20-mesh size was floated, making a complete separation from the quartz gangue. In this experiment the nitrous oxide was the active agent, for if the same experiment is conducted with sulphuric acid, no such separation takes place. Assayers are familiar with a similar phenomenon when treating blister copper with concen-

trated nitric acid and heating. Nitrous oxides are formed and the metallic copper is floated, a froth of copper being the result. Carbon dioxide does not seem to be as active as the nitrous oxides or chlorine bubbles.

ELECTRIFICATION OF THE BUBBLE. Two different substances, whether gaseous, liquid, or solid, when brought intimately into contact and moved one over the other, always produce electrification. Difference of temperature of two similar substances in frictional contact will cause electrification, the warmer usually being negatively charged. Something certainly happens when the surfaces of two different substances are brought into intimate contact, for the result is that when they are drawn apart, they are oppositely charged. The nature of the charge depends on the substances. Fur rubbed on glass electrifies the glass negatively; while if glass is rubbed with celluloid it will become charged positively.

A blow struck by one substance on another produces opposite electrical states on the two surfaces. Again, the evaporation of liquids is accompanied by electrification, liquid and vapor assuming opposite charges, though this is only apparent when the surface is in agitation. A few drops of copper sulphate thrown on a hot platinum plate produces violent electrification, as the copper sulphate evaporates. Electrical charges are set up by various other means, such as vibration, disruption of material, crystallization, combustion, pressure, and chemical reactions.

It would seem easier therefore to electrify a bubble than to keep it from being electrified. I assume that the bubbles are electrified, whether by means of air being forced through canvas, by beating air into water with blades, or by other means. The next step is to consider the properties of an electrified sphere. These may be illustrated by suspending two light spheres of conducting materials near each other by means of silk threads. Upon charging the spheres with like electric charges, they will repel each other, but if a conductor is brought toward them, both are attracted to the conductor. Of course, if the spheres touch the conductor and the conductor is grounded, then the spheres lose their charges. If the conductor is insulated from the ground, then upon contact with the spheres, the conductor receives a similar charge and the spheres will be repelled. Suppose that the spheres or conductor are covered with an insulating film. Then the spheres and conductor would remain as close together as the films would permit. So air bubbles that are electrified will attract conductors near them that are free to move.

Air, being a poor conductor of electricity, the bubbles as a whole do not discharge immediately upon contact with a conductor. The only part of the surface discharged is that in immediate contact with the conductor, and this discharged film of air acts as a dielectric and non-conductor to the rest of the bubble, which remains charged.

The amount of electrification of the bubble will depend on various conditions, such, for example, as the amount of friction produced by the blades of a Minerals Separation machine. Increase the speed and the electrification is greater and the attraction for conductors will increase, reducing the proportion of conductors in the tailing. Referring to D. G. Campbell's article in the *Mining and Engineering World* of January 17, 1914, the speed of agitation and the percentage of extraction is given as follows:

Speed of blades, r.p.m.	Extraction, %	Weight of product, Gm.
1800	68	39
1200	54	32
900	46	26
600	39	18

The extraction seems to vary directly as the square root of the increase in speed. But it will be observed that with the increased extraction, the percentage of sulphide in the concentrate decreases, due to the attraction of the small particles of mixed gangue and sulphide. If the bubbles are highly charged, the concentrate will not be as clean in a particular case, as if they were less charged.

Vapors and gases may be highly electrified. The Armstrong hydro-electric machine, devised by Lord Armstrong, gave sparks of 5 to 6 feet. The friction of a jet of steam through a wooden nozzle generates the charge on the particles of condensed water.

RELATIVE CONDUCTIVITY. From the above, it appears that to float a mineral, it must be a conductor. The following table of relative conductivities is taken from Landolt-Bornstein 'Physikalisch-Chemische Tabellen,' 1912, fourth edition:

Silver	681,000	Pyrite	41.7
Copper	634,000	Magnetite	1.24
Gold	455,000	Chalcopyrite	0.983
Iron	113,000	Manganese di-oxide.....	0.16
Covellite	8,000	Cuprite	0.025
Galena	3,350	Siderite	0.00014
Graphite	700	Quartz	0.844×10^{-11}
Pyrrhotite	119	Diamond	0.211×10^{-11}
Chalcocite	91		

From this table, it would seem that the metals and sulphides that may be recovered by the flotation method are all conductors. The chalcopyrite figure seems low, but the flotation properties of sulphide minerals vary, and the variation in the conductivity of the different minerals may have something to do with this. The better the conductivity of the valuable mineral, the easier is it floated, other factors remaining the same.

THE INSULATING FILM. The next important question in the problem is the action of the oils, resins, or other agents now used in flotation. Working from the electrical standpoint, it is necessary to prevent the charge of the bubble from being dissipated and thus breaking down the froth, before it has done its duty. Oils and other substances have a tendency to coat the metals and minerals that are recovered by flotation, and if the air bubble is completely surrounded by these particles, an envelope of oil or other dielectric will insulate the bubble and prevent the dissipation of the charge. Without a dielectric film about the bubble no permanent froth would be formed. It is, therefore, necessary to add some material of great dielectric strength that has the tendency to coat the valuable mineral.

The words 'dielectrics' and 'non-conductors' or 'insulators' should not be confused. A 'dielectric' is a substance that is not only a non-conductor, but is also one that takes part in the propagation of the electric inductive forces. All dielectrics are 'insulators,' but equally good insulators are not necessarily equally good dielectrics. Air and glass are far better insulators than ebonite or paraffine, but the inductive influence acts more strongly across a slab of glass than across a slab of ebonite or paraffine of equal thickness, and better still across these than across a layer of air of the same thickness.

It may, therefore, be possible to use a frothing agent, as is well known, that is not an oil at all. I have done this and formed froth that has lasted for weeks. For instance, if in the experiment mentioned in the first part of this article, with galena ore, a little alcohol is first mixed with the galena, before the water and acid is added, then a heavy mass of bubbles and galena particles will be formed, too heavy to rise to the surface.

As the influence of the charge acts inversely as the thickness of the film, it is imperative that some dielectric be used that will create a very thin film about the valuable mineral. The dielectric must also be of such a character as to aid the formation of a great quantity of small bubbles in the liquid. It is difficult to create and

maintain small bubbles in pure water. It is here that surface tension phenomena probably play a part in flotation.

ACIDITY OF THE PULP. In Mr. Campbell's article he gives the following results of acid variations:

Acid, Gm.	Extraction, %	Weight of product, Gm.
0.0	63	67
0.2	50	60
0.4	51	35
0.4	48	30
0.8	40	25

Other tests also show that the extraction decreases as the acidity increases, but the amount of gangue in the concentrate decreases much more rapidly. With an acidified pulp, a cleaner concentrate is obtained. Also better results are obtained if the acid is added before the oil to the agitation-tank.

As to the action of acids and alkaline substances in the pulp, little seems to be known, but according to the electrical theory, the addition of these substances causes the conductivity of the pulp to increase greatly. It is a possibility that if the acid is not added before the oil, the gangue, oil, and conductors are all electrically charged by reason of the friction. The conductors would be positively charged, while the other substances and the air bubbles would be negatively charged. If the pulp is a poor conductor, as it would be if water is not acidified or otherwise made a conductor (pure water being a very poor conductor), the charges on the gangue materials would remain for some time and the conductor (sulphides, etc.) would attract the gangue as well as the bubbles and oil, thus causing gangue to be taken up with the bubbles. By the addition of acid, the charges on the surface of the solids are discharged to the ground, and the bubbles and the oil, which will not be instantly discharged as are the solids, will attract the conductors.

CONCLUSIONS. It might be stated here that the electrical theory was taught last year, as possibly explaining flotation phenomena, to the class in ore-dressing, at the Case School of Applied Science.

The above mentioned method of floating conductors may be used for the rapid determination of certain ingredients in ores that are amenable to the flotation process. It requires only a beaker and a few chemicals, no flotation machines being needed. For the rapid approximate determination of insoluble in a smelting ore, the method will give a fair result within a few minutes. If the conductor is

readily acted upon by nitric acid, the results may not be satisfactory, but by addition of oleic acid the dissolving action of the acid is reduced.

The following summary of the requirements for 'flotation,' considered from the electrical standpoint, may be of practical use:

1. Ores containing valuable minerals or metals that are good conductors are the only ones that are suitable for flotation.

2. To buoy these conductors, it is necessary to supply enough electrified bubbles from below to float particles of the conductors that are attracted; hence the smaller the bubble, the better the result, the amount of gas being the same.

3. Some dielectric fluid is necessary to cover the conductor or the bubble, to prevent the dissipation of the electric charge. The thinner the film of dielectric and the greater its dielectric strength, the greater the effective attractive force and the more permanent will be the froth.

4. Some material must be added to the water to increase its conductivity, to obtain a clean concentrate; acids in small quantity are now used.

NOTES ON FLOTATION

By J. M. CALLOW

(From the *Mining and Scientific Press* of December 4, 1915)

***HISTORICAL SKETCH.** The selective action of oil for lustrous minerals was first disclosed by Haynes in 1860. In 1885, Carrie Everson elaborated this idea and also disclosed the fact that acid increased the so-called selective action. Her patent called for oils, either animal, vegetal, or mineral, and also an acid or salt. The process was tried on a practical scale both at Baker City and Leadville in 1889; it failed, first, because, as has since been shown, of the unsuitability of the ore to flotation; second, because her invention was too far in advance of the times. Then followed the Elmore brothers, first with their bulk-oil process and later with their vacuum scheme. The basic principles of oil-flotation were undoubtedly covered by the above inventors and the work that has been done since their time has been merely a building up on ground-work laid down by them. Different kinds of oil, different quantities of oil, and all the varying degrees of agitation were all exemplified and practised by them in one phase or another; the developments that have since been made are but elaborations of the fundamental principles laid down by Haynes, Everson, and the Elmore brothers.

In 1902 we saw the development of the Potter or Delprat process in Australia. In this no oil was used, but the mineral was raised by the generation of gas, brought about by the introduction of acid in the pulp so that the mineral appeared on the surface of the separatory vessel in the form of a seam or froth buoyed by minute gas bubbles attached to them, and thus first gave the suggestion of gaseous flotation. In 1902, also, Froment, an Italian, was granted a patent in which he combined violent agitation with oil and gaseous flotation, the gas being generated within the pulp, in much the same way as in the Potter-Delprat process. In the same year, Cattermole came out with a unique scheme. He first emulsified his pulp with a small quantity of oil by violent agitation and afterward submitted it to a slow stirring action in a second machine, by which he granulated or coagulated the minerals that had been oiled into nodules, which he afterward sepa-

*A paper originally presented at the annual meeting of the Utah section of the American Institute of Mining Engineers, at Salt Lake City, on October 4, 1915. Read at the New York meeting in February, 1916.

mental idea of the process afterward described by Sulman, Picard, and Ballot in their patents, in which, instead of granulating part of the mineral, they floated all of it. This patent forms the basis of all the Minerals Separation operations. It was first exploited in Australia and in a short time replaced all other flotation processes in that country.

In 1904, Macquisten brought out his tube process, a very ingenious scheme which gave excellent results on the sandy portion of the feed, but was inoperative when slime was present. This was a strictly surface-tension scheme, and its inability to handle slime was a serious limitation.

In 1912, Hyde introduced a modification of the Minerals Separation process into the mill of the Butte & Superior company, at Butte, Montana. This differed from the regular practice in that it introduced a double treatment, first 'roughing' and then 'cleaning' the concentrate.

PNEUMATIC FLOTATION. Early in 1909, I did a great deal of work with the Macquisten flotation process and in the installation of the tube-plant of the Morning mill at Mullan, Idaho. This work was followed by a large amount of experimenting on the different kinds of existing flotation processes, the outcome of which was the development of the pneumatic method.

The first application of pneumatic flotation for the treatment of ore was made by me at the mill of the National Copper Co. at Mullan. This plant was designed and built by me and was a success in every way from the very start. Construction was started on August 14, 1913, and the plant went into successful operation about April 10, 1914. The flow-sheet is given in Fig. 42.

Since that date, the method has been adopted by nearly all the other mills in the Coeur d'Alene treating lead and lead-zinc ores, notably the Gold Hunter, Morning, Hercules, Bunker Hill & Sullivan, Caledonia, Last Chance, Hecla, Standard, etc., a total of about 50 cells in all, treating from 1500 to 2000 tons of slime and fine sand per day. The same method also has since been adopted by the Inspiration, Arizona, Anaconda, Magma, and other copper companies, and by the Silver King, Daly-Judge, Duquesne, and El Rayo mining companies, on lead, zinc, and other ores, making a total of some 680 cells in operation or in the course of erection, having a combined capacity of 25,000 to 28,000 tons per day.

The flow-sheets of the Inspiration and the Arizona Copper plants are given in Fig. 43 and 44. The Daly-Judge flow-sheet, in Fig. 45, is

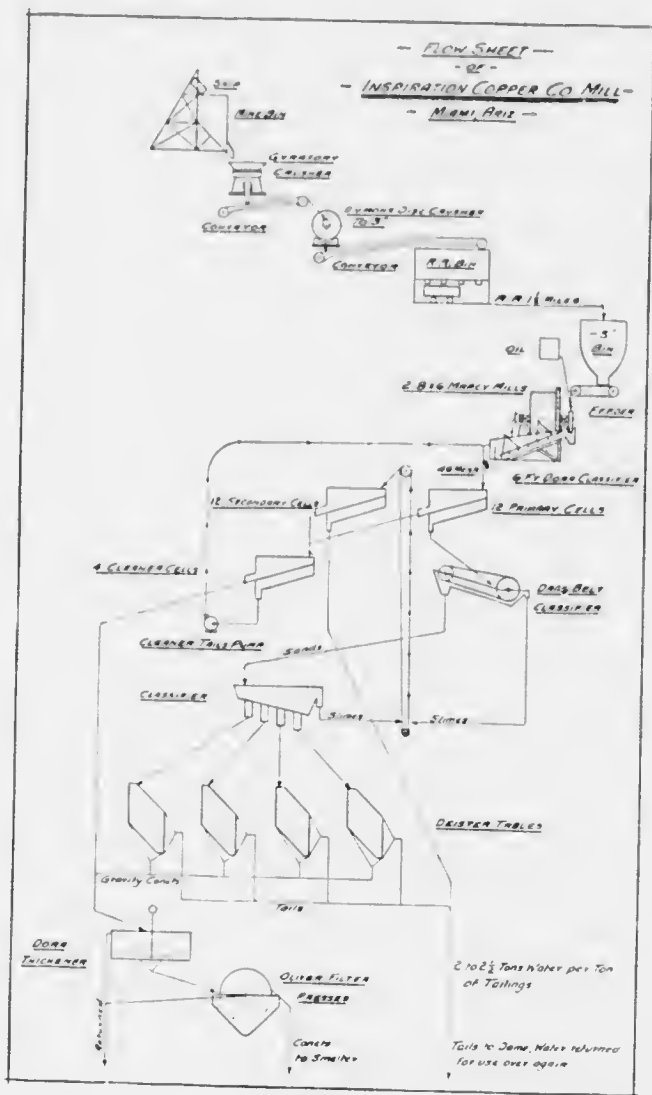

FIG. 43.

an interesting example of the recoveries possible on zinc-lead, fine sand, and slime.

The accompanying diagram, Fig. 46, illustrates the various elements composing the Callow method.

A is a mixer operated by compressed air for the purpose of mixing

and emulsifying the oil, the air, and the water, the same type of apparatus being in common use in cyanide work. In cases where the oil or frothing agent can be fed into the crushing machine or tubemill, this mixer, or Pachuca tank, can be eliminated, so that the oil is fed direct into the mill and thence into the separatory cell.

It has been proved conclusively that agitation *per se* is not necessary to successful flotation by the pneumatic method. In one of the plants a Pachuca mixer for each four roughing-cells was installed. This received the thickened feed from a Dorr tank, which feed was elevated by a belt-and-bucket elevator. The oil was fed into the boot of the elevator and the mixing there served all purposes, since the results without the Pachuca were found to be just as good as with them. Therefore the use of them in this plant has been abandoned.

B is the initial or roughing separatory cell. It consists of a tank about 9 ft. long over all and 24 in. wide, with a bottom inclined at from 3 to 4 inches of fall per foot; it is 20 in. at the shallow end and 45 in. deep at the deepest end. It may be built of either steel or wood, preferably wood.

Fig. 47 and 48 show the cell in detail. The bottom of the tank consists of a porous medium made of four thicknesses of loosely woven canvas twill, properly supported by a backing of perforated metal to prevent bulging when under air-pressure. Through this porous medium compressed air is forced by the blower *E*. Porous brick or any other ceramic material may be used to ensure the necessary fine subdivision of the air. Some of these have been tried, but for practical and mechanical reasons the loosely woven canvas-twill seems to serve all purposes better than anything else, and has been adopted as the standard porous-bottom construction.

The space underneath this porous medium or bottom is subdivided into eight compartments, each connected by an individual pipe and valve with the main air-pipe *F*. By this means the air-pressure to each compartment can be regulated (by throttling the valve) to correspond with the varying hydraulic head within the tank, so as to discharge a uniform amount of air throughout the length of the bottom and maintain a uniform aeration of the contents. A pressure of from 4 to 5 lb. is generally used and each square foot of porous medium requires from 8 to 10 cubic feet of free air per minute.

Each longitudinal edge of the tank is provided with a lip and an overflow gutter for the reception of the froth to be discharged. The lower end of the tank is furnished with a spigot-discharge

THE FLOTATION PROCESS

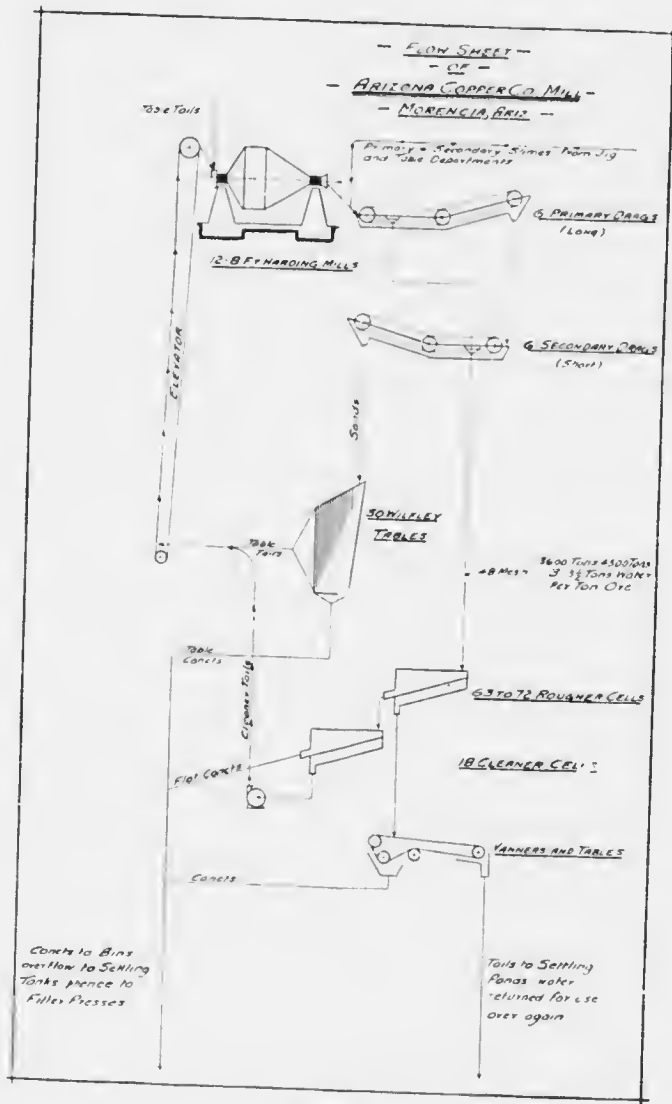

FIG. 44.

nitted with a plug-valve, operated by a float, for the purpose of maintaining a uniform water-level within the tank, thus in turn securing a uniform and constant discharge of froth under all the varying conditions of feed incident to practical milling operations. The water-level may, of course, be varied; but it is usually maintained

at about 10 to 12 inches below the level of the overflow-lips. The tailing is discharged through the spigot and the frothy concentrate is conveyed by means of the side-gutters to the pump *D-1*, thence to the cleaner-separatory cells marked *C*. This cleaner-cell is a machine of the same construction as the rougher; in operation, however, it is usually run with a lower air-pressure; the tailing from the cleaner is pumped by *D-2* back to the original feed, and thus a closed circuit is maintained on this portion of the feed. The concentrate from the cleaner is the shipping or finished product. Dump *D-1* can well be eliminated by setting the cleaner at a lower elevation and conveying the rougher-froth to it by gravity. Usually one cleaner serves four roughers.

PARALLEL OR SERIES. The machine may be run either in parallel or in series without any sacrifice in capacity for a given number of cells. Recent experience goes to show that, on some ores at least, the series treatment gives a slightly better tailing; on others it does not. It is unnecessary to extend this arrangement of cells beyond two cells in series. In a heavily mineralized ore this arrangement is decidedly advantageous and in such a case the rougher-concentrate might be of high enough grade to omit the re-cleaning operation. The froth from the second cell in the series might be returned into the original feed in the same way that the tailing is returned from the cleaner when practising a roughing and cleaning operation. A number of such combinations is possible. At the Inspiration, the original feed goes to 12 primary roughers, the tailings from which are classified into sand and slime, the sand going to tables and the slime being returned to 12 secondary roughers. The concentrates from both the primary and secondary roughers go to four cleaners, and the cleaner-tailing back into circuit.

FROTH FORMATION. The froth is generated as the result of injecting the finely divided air into the bottom of the already emulsified pulp; it continues to form and to overflow so long as it is furnished with pulp of the proper consistence, properly mixed with the right quantity and kind of oil or frothing agent. Measured from the water-level within the tank, the froth produced may be from 14 to 16 inches in depth or thickness, and according to the character of ore, kind and quantity of oil introduced, will be more or less voluminous, coarse or fine grained, dry or watery—all of these conditions being adjusted by the regulation of the kind or quantity of oil and the quantity of air injected.

In the case of some ores, rich in sulphides, when a comparatively

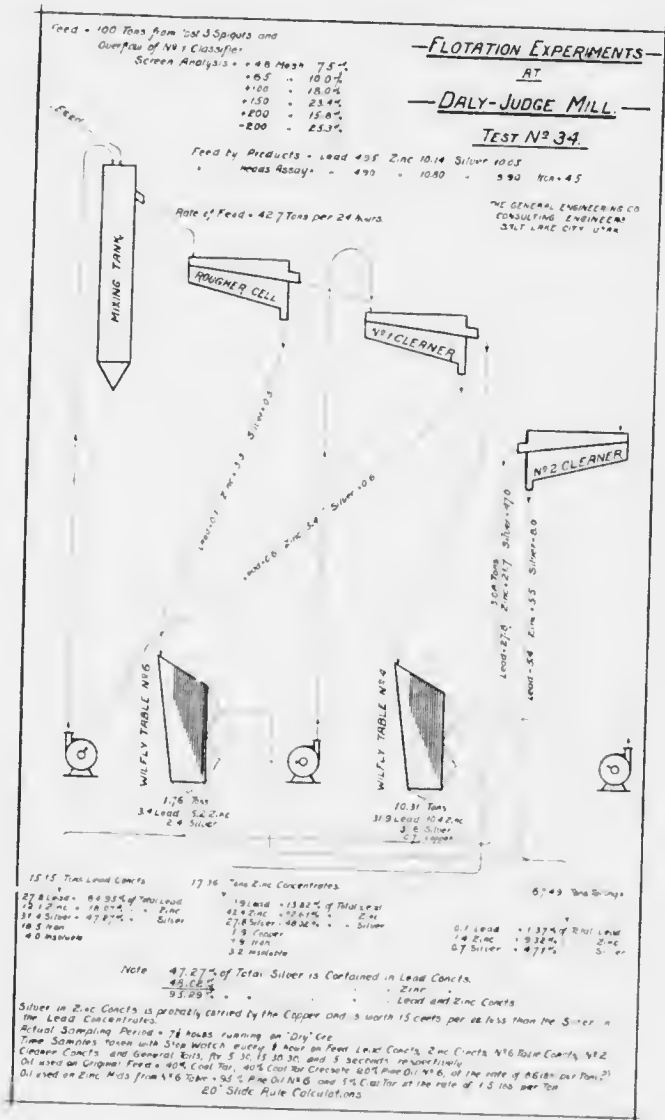

FIG 45.

low-grade concentrate will suffice, the 'cleaner' may not be necessary, but on low-grade ores having a high ratio of concentration and demanding a concentrate of maximum purity, a cleaner is desirable.

PULP-DENSITY. The pulp to be treated may be of varying density,

from $2\frac{1}{2}$:1 water and ore, up to 5 or 6:1; for a mixture of sand and slime the former ratio is preferable, but for a pure slime mixture (—200-mesh) the larger proportion of water is allowable. The particular density is not a matter of so much importance as that the supply of pulp be uniform in density, since each variation in the density of the pulp requires a re-adjustment of the oil-supply, the quantity of oil increasing in proportion to the increased volume of pulp independent of its solid content.

CAPACITIES. A normal capacity per standard roughing-cell is 50 tons per 24 hours. This, of course, will vary with the nature of the ore. In one plant that employs gravitation previous to flotation the fine sand and slime only are treated at the rate of 50 tons per rougher. The Inspiration Copper Co. uses flotation as the prime process, and its 800 tons per section is treated by 24 roughing-cells and 4 cleaners. In this case the cells are run in series, the primary cells treating the original feed and the secondary cells re-treating only the slime from the primary tailing after the sand has been removed. This gives an average of 33.3 tons per roughing-cell. The Arizona Copper Co.'s plant will treat the slime and re-crushed sand from previous gravity-treatment; out of an original tonnage of 4000 there will be about 3600 tons of flotation feed. This will be handled on 63 roughers run in parallel, and 18 cleaners, or an average of approximately 57 tons per roughing-cell, or 45 tons per cell for roughing and cleaning.

Some tests have shown little difference in recovery, whether running 45 tons to the cell or 65; but the recoveries commence to decline as soon as the feed exceeds 75 tons. In the Coeur d'Alene, on zinc-lead ore, 35 tons per cell is an average capacity.

Oils. The oils used may be broadly divided into 'frothers' and 'collectors.' The pine-oils are good frothers; coal-tar and its various subdivisions are good collectors. On some ores crude pine-tar will in itself combine both the properties of frothing and collecting. On others, this may have to be enriched by the addition of some one of its more volatile constituents, such as refined pine-oil, turpentine, or wood-creosote.

Generally speaking, the coal-tar products are poor frothers; to get a sufficient volume of froth to insure a high recovery, it is often necessary to add refined or crude pine-oil, creosote, etc. At the Inspiration, for instance, the mixture is 80% crude coal-tar, 20% coal-tar creosote; at another plant on similar ore 45% El Paso coal-tar, 40% coal-tar creosote, 10% cresol, and 5% pine-oil. At

the Daly-Judge we used 40% crude coal-tar, 40% creosote, 20% pine-oil. In the Coeur d'Alene on zinc ore we used straight wood-creosote; on the National Copper ore plain turpentine will work,

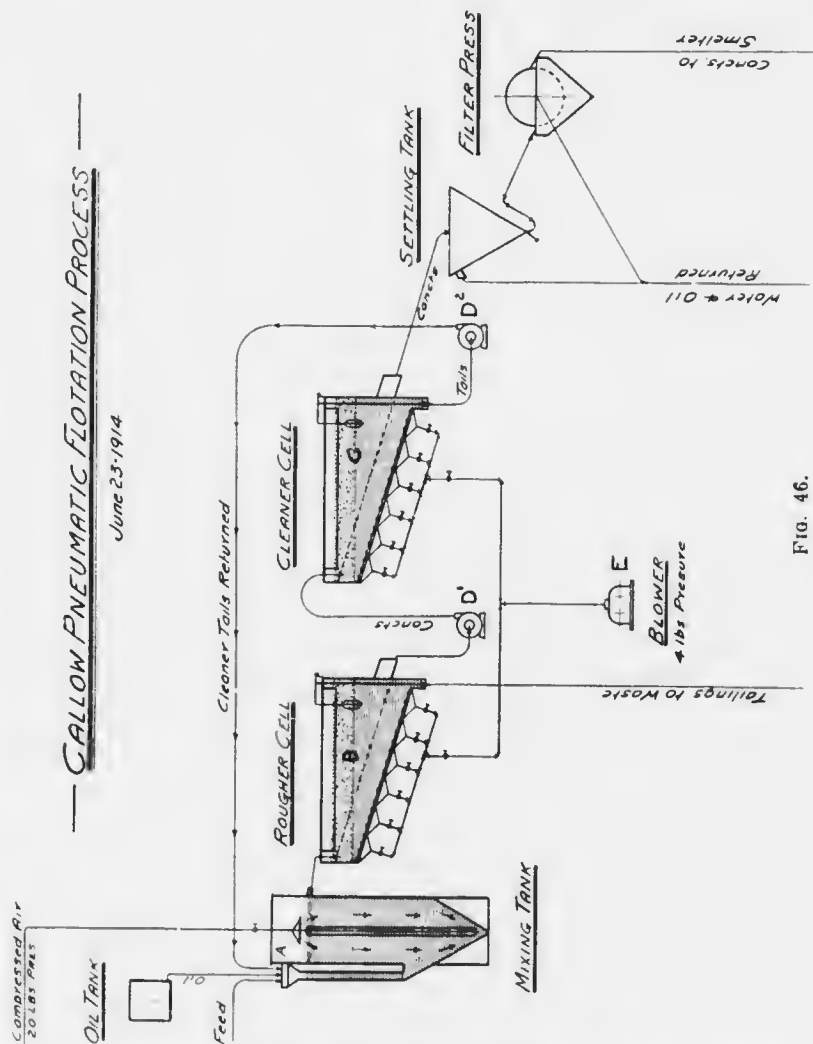

but pine-oil is better. At the Inspiration we used from $1\frac{1}{2}$ to 2 pounds of the mixture per ton of ore; at the Daly-Judge, 1 to $1\frac{1}{2}$ lb.; and at the National 0.3 lb. oil is sufficient. In the experimental work at another plant the consumption of oil was approximately one pound

of mixture per ton, but since the entire plant has been in operation and the circuit-water is reclaimed and used over again, the oil consumption has dropped from 1 to 0.35 lb. The proper kind or kinds of oil and the quantity requisite can only be determined at present by tentative experiment; so far no scientific short-cut is known.

CHARACTER OF FROTH. The nature of the froth made by the pneumatic method has the distinctive characteristic of being unstable or ephemeral, that is, it quickly dies when removed from the action of the injected air. The bubbles composing the froth, being generated under a hydraulic pressure varying from 15 to 40 inches, on rising above the water and to the froth-level, burst by reason of the lower surrounding atmospheric pressure. On bursting, they release the mineral attached to them, but this in turn is caught up by those bubbles immediately following behind. The instability or stability of the bubbles will depend, to some extent, upon the oil used and the nature of the gangue. Pine-oil makes a very brittle froth, which dies immediately on arriving at the surface. Creosote and light oil make a more elastic envelope, which at times will expand into bubbles 3 to 4 inches in diameter before bursting. The pine-oil bubbles will rarely be over $\frac{1}{4}$ or $\frac{1}{2}$ inch diameter. Castor-oil, olive-oil, candle-makers' oil (oleic acid), palm-oil, sperm-oil, and other oils of a lubricating nature, have in general been replaced by oils more or less soluble or miscible in water—such as turpentine, pine-oil, and all the coal and wood-tar distillations. The very volatile oils, such as naphtha, gasoline, ether, alcohol, seem to serve very little purpose except as a means for making the pitchy ingredients of the tars more soluble or miscible.

A large, coarse, and elastic bubble seems necessary to the recovery of coarse-grained mineral, but for the very fine or colloidal mineral, a small and comparatively brittle bubble is necessary.

POWER. The National Copper Co., using approximately 950 cubic feet of air at 4-lb. pressure, and treating 500 tons per day on 8 roughers and 2 cleaners, required 35-hp.; this equals 3.5 hp. per cell, or 12.53 tons per horse-power, or 1.25 kw.-hours per ton.

Another company using approximately 9600 cubic feet of air at 5-lb. pressure and treating 2400 tons per day on 48 roughers and 12 cleaners, required 210 hp.; this equals 3.5 hp. per cell, or 11.45 tons per horse-power, or 1.56 kw.-hours per ton.

The Inspiration experimental plant, using approximately 950 cu. ft. of air at 5-lb. pressure and treating 200 tons per day with

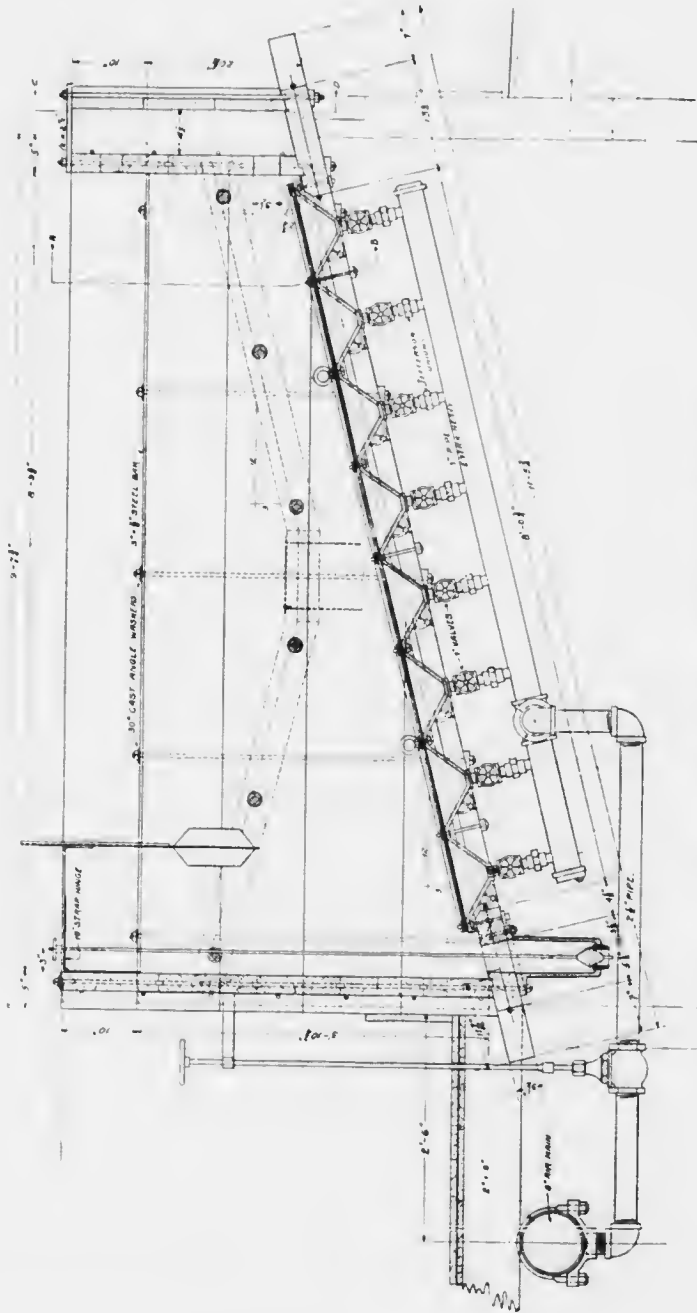

FIG. 47. SECTION OF THE CALLOW FLOTATION MACHINE.

4 roughers and 1 half-size cleaner required 25 hp.; deducting 4 hp. for two 2-in. centrifugal pumps, this equals 20 hp., or 4 hp. per cell, or 10 tons per horse-power, or 1.79 kw.-hours per ton.

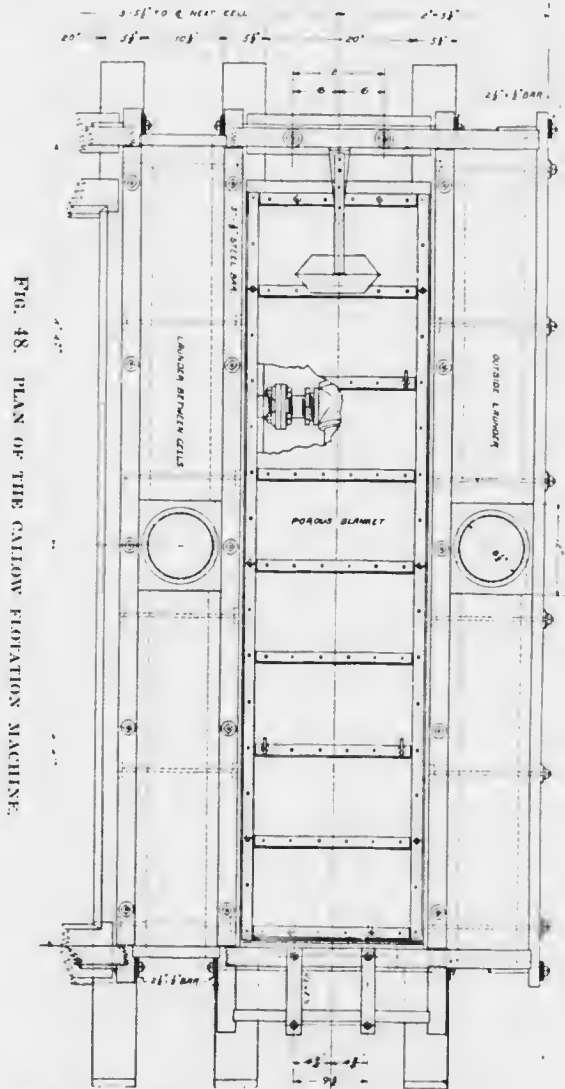

FIG. 48. PLAN OF THE GALLOWAY FLOTATION MACHINE.

A maximum figure would be $2\frac{1}{2}$ kw.-hours per ton of feed, using 5 to $5\frac{1}{2}$ -lb. air-pressure, generated by a Roots or Connersville positive blower.

COST. The oil-mixtures generally in use will cost from 1.25c. up to 3c. per lb. depending on the proportion of cresol and other high-priced oils used, but 1½c. per lb. will be a safe average on most oils. A consumption of 1 to 1½ lb. per ton or from 1.25c. to 4.5c. per ton of feed, say 2½c., would be a safe average. The labor, of course, will vary with the size of the plant. At one plant consisting of 60 cells, two men per shift operate the entire plant, equivalent to a cost of 1½c. per ton. One man per shift on a 250-ton plant will mean a cost of 5.4c. per ton in maintenance. Assuming a life of three months per blanket and 50 tons per cell and an allowance for repairs to blowers, motors, pump, etc., we have ½c. per ton as a liberal estimate.

Power at 1c. per kw.hour (\$60 per hp.-year) and 2½ kw.-hours per ton equals 2.5c. per ton of feed.

Summarized, my estimate on a 2000-ton plant will stand approximately as follows, in cents per ton of feed:

Labor	1.25
Oil	2.50
Maintenance	0.50
Power	2.50
Total	6.75

On a plant of 250 tons the extra labor would bring it up to approximately 10c. per ton. Actual figures from a large plant of over 2000 tons gave 6.1c. per ton. The flotation feed in this case represents 60% of the crude-ore tonnage or 3.5c. per ton of crude ore treated.

THEORIES. So far no satisfactory explanation of flotation phenomena has been advanced. At my instigation and under my direction, a large amount of research work has been done in an earnest endeavor to formulate some logical explanation, and perhaps to find some scientific way of conducting experiments in lieu of the empirical methods now in vogue. While this purpose has not yet been fully attained, the experiments have resulted in the formulation of a theory that appears to be well grounded and that may prove of value to others engaged in this branch of metallurgy.

Much work has been done at the Mellen Institute at Pittsburg under the direction of Raymond C. Bacon, and lately by James A. Block at the local station of the U. S. Bureau of Mines. The results of some of this work are summarized in the following statements:

In considering the connection between flotation phenomena and the physical properties of the minerals concerned, there are two parallelisms to be noticed:

First: It has been noticed for some time that the minerals which floated were not easily wetted by water, while those which were easily wetted did not tend to come up with the froth. This is the basis of about the only theory that has been widely circulated up to this time. It is well stated by Hoover in his book, 'Concentrating Ores by Flotation,' the first authoritative publication on the subject.

Second: There is a parallelism between certain electro-static characteristics and the flotation properties of ores, as will be explained.

In the theory first mentioned, it may be demonstrated by a consideration of surface tensions and contact angles that certain floatable minerals, such as galena, will float on the surface of still water, while gangue particles, on the other hand, possess a greater adhesive attraction for the water than the water's cohesive attraction for itself, and are therefore drawn through the surface film into the interior, where they sink because of their greater specific gravity. These properties of floatable minerals and gangues are increased by the presence of oil and acid. Oil sticks to galena with greater tenacity than it sticks to silica, and an oil surface is far less easily wetted than a galena surface. The acid in the water causes a still greater difference in the various surface tensions. This, it seems, is without question the explanation of such flotation as is obtained by the Macquisten process, in which the ore particles are lifted to the surface and those remaining are removed by skimming the surface layer of the liquid.

As regards the second parallelism mentioned, it has been noticed that extremely small amounts of certain colloidal impurities, such as saponine or tannine, were detrimental to flotation, while others, such as Congo red and methylene blue, did not interfere, and were, if anything, beneficial. In classifying these, the injurious ones generally came under the head of what physical chemists call electro-negative colloids, while electro-positive colloids were not harmful. This classification is derived from the fact that suspended particles will generally migrate when placed in an electric field, and the classification comes naturally from the direction of their migration. This migration is called electro-phoresis, or electrical endosmosis, and is the result of the fact that the liquid containing the particles forms contact-layers around them, similar to the surface-films formed when liquids come in contact with air. These contact-films almost

invariably have a difference of potential between their inner and outer surfaces. The film of an air-water contact has, for instance, a difference of 0.055 volts,¹ and other contact-films have similar charges. This causes the particles to act like charged solids, and to be attracted by electric charges of opposite sign.

The charges on solids and non-miscible liquids can be conveniently studied on the stage of a microscope.

This work led naturally to the study of the charges exhibited by various ores and minerals, and in that work an interesting parallelism was observed; namely, that floatable minerals seemed to have positive charges and non-floatable gangues negative charges.² Some gangues were found with positive charges, but they were characteristically hard to handle, having a tendency to come up with the froth. These charges sometimes vary with the acidity or alkalinity of the liquid, and this variation is not inconsistent with the effects of acidity or alkalinity on the flotation of ores.

It has been noticed that these electro-static properties depend on the condition of the surface of the particles and not upon the composition of the mass. For instance, lead oxide, which is ordinarily negative or neutral, when covered with a sulphide coating takes upon itself a positive charge.

Although these charges are small, recent work on the coagulation and deflocculation of slime, on the coagulation and dispersion of colloids, and along similar lines, shows that the contact-film charges have an important bearing on the dispersion or coherence of particles suspended in liquid mediums. In fine suspensions and in colloidal solutions, these charges may often be neutralized by the introduction of oppositely-charged ions, and precipitation will generally take place whenever these charges fall below certain limits. Oppositely-charged contact-films generally have a tendency to absorb each other, and to coalesce, while similarly-charged films, if their charges are great enough to overcome natural cohesiveness, do not seem to coalesce, but to repel each other, and if the weight of the particles is small enough in relation to their size and surface, permanent dispersion will take place, the particles distributing themselves through a liquid in much the same manner that a gas will fill a container.

In view of the above observations, it seems possible that flotation is due to differences in polarity in the charges on the various particles

¹*Philosophical Magazine*, 1914, 27: 297 and 28: 367.

²*Kolloid Chemische Beihefte*, 2:84; *Zeit. für Physikalische Chemie*, 89: 91, 1914.

of ore, and on the bubbles. Since oil contact-films and air contact-films have both been proved to have negative charges, the positively-charged minerals might adhere to either. The bubble-mantles in a flotation machine are undoubtedly composed of oil, or of oil in emulsion, since pure water alone will not froth. The same forces, then, that cause oppositively-charged colloids to agglomerate and precipitate, cause the minerals to adhere to the oil-covered bubbles; and the same forces that keep the particles of an oil emulsion dispersed, keep the gangue-particles repelled from the bubbles.

Expressed briefly, the theory is as follows: That oil flotation is an electro-static process. It is a scientific fact that when a solid particle is suspended in water, the water will form around the particle a contact-film that generally possesses an electric charge, the amount and polarity of which will depend upon the nature of the surface of the particle and the electrolyte in which it is suspended. The presence of these charges can be demonstrated by the fact that the particles possessing them will migrate when placed in an electric field. It has been demonstrated that floatable particles have charges of one polarity (positive), and that non-floatable particles have charges of the opposite polarity (negative), and that the froth is charged negatively and so attracts the positively-charged or floatable minerals, and repels the negatively-charged or non-floatable ones. It is this, it is believed, that causes the floatable minerals, such as galena or sphalerite, to adhere to the froth and rise, while the gangue-minerals, such as silica and limestone, remain in the liquid where they can be discharged as tailing.

DISPOSAL OF FLOTATION RESIDUE

By W. SHELLSHEAR

(From the *Mining and Scientific Press* of December 11, 1915)

*INTRODUCTION. There are many methods of handling sand and slime from metallurgical operations, but in this article the draining and conveying of waste products from flotation processes will be specially dealt with, the methods given being those in use at the leading flotation plants in Australia.

DRAINING AND DEWATERING. It is generally advisable to thoroughly dewater the residue from flotation treatment in order to form a closed circuit of liquor. This maintains constant conditions throughout the plant and avoids waste of oil, which would be carried away by the solution with the tailing. The methods that may be used for this purpose are:

(a) Filtering in vats; (b) combination of a submerged draining-belt and Dorr thickeners; (c) combination of Caldecott diaphragm-cones, draining-belt, and Dorr thickeners, and (d) combination of Dorr classifiers and Dorr thickeners.

FILTERING IN VATS. In this system, shown in Fig. 50, the pulp from flotation is run direct into vats. These are usually 15 ft. diam., their depth varying from 10 to 20 ft. In the centre of each, and before filling, a tube or pipe, 15 in. diam., that fits over the circular discharge-hole, is inserted. When the vat is ready for emptying, this tube is lifted out a large proportion of the tailing falling through the centre hole onto a conveyor underneath. The remainder is afterward shoveled upon the same conveyor.

A wooden frame, not shown in the sketch, is erected above the vat to support the lifting-device, a screw-block being used to raise the pipe to the desired height. This operation is afterward carried out by an ordinary block and tackle. The vat may be made of wood or iron, and the height to which it may be constructed is controlled by local conditions, such as the design of the plant, and the nature and fineness of the material to be filtered. It is, however, apparent that the greater the height that can be economically employed, the less the labor required, as a proportionately large amount drops through the centre of the vat without shoveling. This would tend to make the inner tube too long to be handled conveniently, but the

*Abstract from *Min. and Eng. Review*, Melbourne, Australia.

difficulty has been overcome by making the tube in sections, each of which is lifted in its turn from the top as emptying proceeds.

The time of filtering is arranged according to the number of vats employed, but it is the usual practice to run the pulp through



FIG. 49. AUSTRALIAN BOOM-DISTRIBUTOR. BELT-DRIVEN WITHOUT GEAR AT 900 FT. PER MIN. BY SLOW-SPEED MOTOR CONTROLLED FROM BELOW. THE MACHINE CAN BE MOVED WHILE WORKING.

a number in series, so that the slime settles from the solution. Thus, if six vats are in use, one may be draining and another emptying, while the remainder would be used for the pulp flowing in series, through them. The filtered water is carried off by a

number of pipes at the bottom of each vat. Under certain conditions a suction-pump is connected to these pipes to assist the filtering, but this is not the usual practice. As a filtering medium, cocoa-nut matting is used generally.

After a vat has been emptied, the tube is dropped into the discharge-hole, two lugs, one on each side keeping it in position. The open space round the tube is then filled with clay. It is advisable to have the bottom of the vat six feet above the ground-level to allow of easy access to the conveyor underneath. At the spot where the sand is discharged upon the conveyor-belt, guide-doors are arranged parallel with the belt to prevent sand going over its edge, and the number of idlers under the conveyor is increased to prevent it sagging under a rush of feed. The conveyor is usually a flat belt, 24 in. wide, traveling at 350 to 450 ft. per minute, 4-in. iron idlers being used.

This method has many excellent features; its advantages are: (1) The moisture of the drained tailing is less than in any other system; (2) the slime is drained at the same time as the sand; (3) dams for handling the slime and the cost of labor or same are eliminated; (4) dusting troubles are minimized on the dump, owing to the slime helping to set the tailing; (5) the angle of repose of the dump is increased, thus enabling more sand to be stacked per unit of ground-area; (6) no trouble with conveyors handling tailing will cause a stoppage in the main plant; (7) accurate sampling of products is possible, enabling shift-work to be kept under control.

The disadvantages are: (1) High initial cost of erection; (2) relatively high cost of labor in emptying vats; (3) clarification of solution is not usually as complete as is the case with other methods.

COMBINATION OF DRAINAGE-BELT AND THICKENERS. The idea of the submerged draining-belt, I think, was first introduced in connection with the Elmore process in order to overcome the difficulty of discharging the residual pulp without upsetting the vacuum in the flotation apparatus. In this system the belt runs inside an iron trough filled with water, being forced into a semi-circular shape by means of a spherical pulley, as shown in sketch, Fig. 51. The belt travels under water for a certain distance, rising at a slope of 15 to 20° onto the head pulley.

The drive is usually from the tail-end by means of a worm-wheel on the tail-pulley shafting. This tail-pulley is generally 6 ft diam., and is faced on the outside with wooden boards to give the belt a better grip. The feed is, preferably, distributed to the

belt by means of an iron launder with holes in the bottom, wooden guides being arranged to guard against sand getting between the under side of the belt and the trough. The trough has side boards attached to carry the overflow to Dorr thickeners, the number of

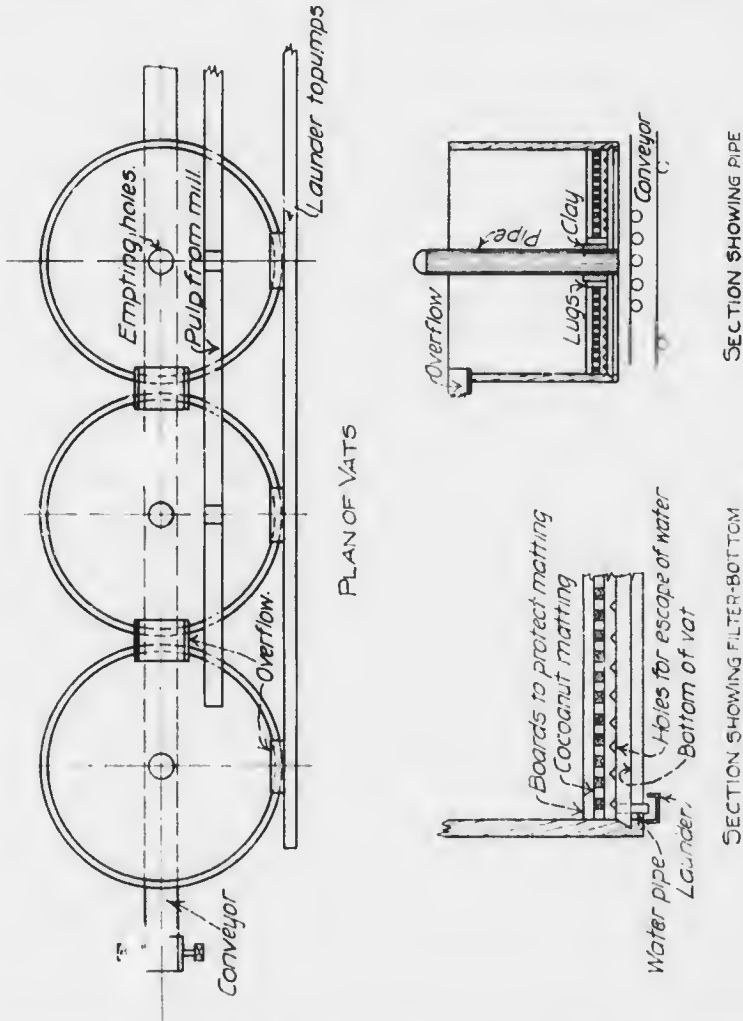

FIG. 50.

the latter depending on general conditions, such as nature of slime, amount of water in circulation, etc. The submerged belt forms an excellent desliming system, by reason of the classification in the trough; its capacity is 4000 or more tons a week of mixed slime and

sand. The draining of the sand is accomplished as it rises from the surface of the liquid in the trough to the head pulley.

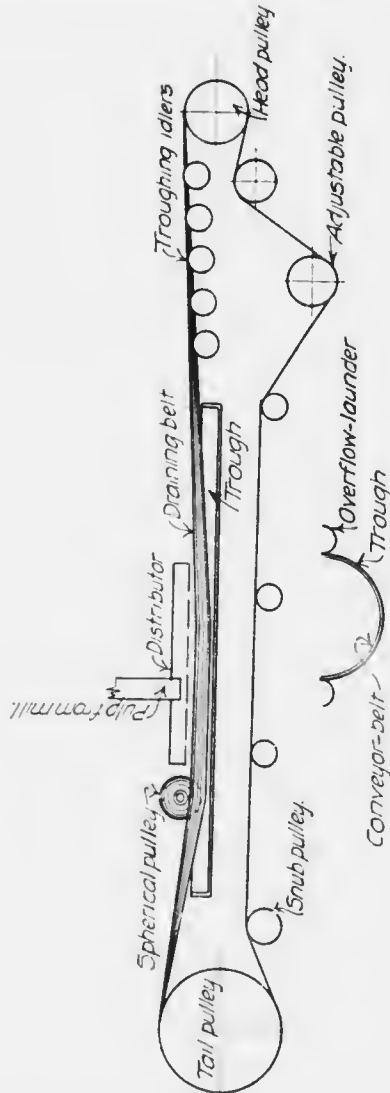

FIG. 51.

In order to accelerate this draining action, a bumper is usually employed. This consists of an idler driven by two eccentrics. The vibration caused on the belt by the idler striking it underneath

displaces a larger quantity of water from the sand, and thus reduces the proportion of moisture in the final product. An iron scraper is used for removing the tailing from the draining-belt; it may be kept under pressure by means of iron springs. This method is very good, especially where the room available for drainage is limited. It is also convenient where the height of the flotation-plant above the ground is small.

The life of the belt is less than that of an ordinary draining-belt, owing to the heavy pressure of the spherical roller, and the action of the hot eirenit-liquors in which the belt is submerged. The labor for attendance is small. This method is at present in use on two of the large flotation plants at Broken Hill.

COMBINATION OF CONES, DRAINING-BELT, AND THICKENERS. This method, diagrammatically illustrated in Fig. 52, has been installed in the latest flotation-plant at Broken Hill. The size of the Caldecott cones usually employed is 12 ft. diam. and 10 ft. deep, the diaphragm being 2 ft. to 2 ft. 6 in. from the bottom of the cone. In most cases a plate-diaphragm is used, but the introduction of an iron ball to serve the same purpose has been most successful. Where a cone of this type is used as a thickener, rather than as a slime-classifier, more pulp may be thickened, as the height of pulp need not be so finely adjusted. Still, it is customary to keep the level of the sand two feet from the top of the cone, as measured in the centre. The feed usually passes into these cones through a centre of the Callow type.

To remove the thickened pulp continuously and divert it onto the draining-belt, an ordinary plug may be used with advantage, provided coarse rubbish has been removed previously. Another successful device is a plug-valve or a plug worked from the top, fitting into a seat at the bottom of the cone. The type of draining-belt employed is 36 in. wide. The belt rises gradually, about 1 in 60, from the tail-pulley, the last 30 ft. of the slope being increased to about 20°. The belt-speed is 20 to 30 ft. per min., both ordinary and troughing idlers, of 6-in. diam., being used. As the operation of the belt is slow, wooden idlers working in cast-iron 'dead-eyes' can be successfully used for the horizontal idlers, the troughing-idlers being of the usual type.

The drive is at the head end, double gearing for speed reduction being employed. The head-pulley is generally 5 ft. diam., the snub-pulley 18 in. diam., and are of contact 200 to 250°. The tail-pulley is usually 2 ft. diam. Rubber belting on the face of these pulleys

reduces the slip, thereby increasing the power-efficiency and the life of the belt.

The overflow from the Caldecott cones goes into one or more Dorr thickeners, according to requirements, the underflow from the thickeners, as in other methods, being handled with flooded suction-

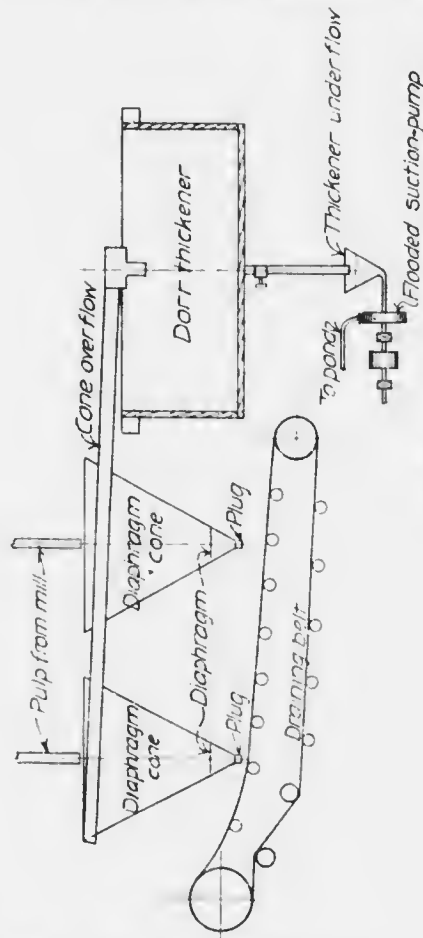

FIG. 52.

pumps. Attempts to mix the underflow from the Dorr thickener with pulp on the draining-belt in order to convey them together to the pump have not so far proved successful. For the control of the underflow from Dorr thickeners the hydrometer method (described in 'Rand Metallurgical Practice') has proved quite satisfactory, a constant pulp, with Broken Hill slime of 50% solid being easily

maintained. This method is considered a good one, because the cost of labor is low, the life of the draining-belt is prolonged, and the cost of maintenance is small. Adequate head-room is, however, necessary for the erection of the cones; in some cases elevation is essential. A disadvantage is that a stoppage of the dump-belts causes a stoppage of the whole plant.

COMBINATION OF CLASSIFIERS AND THICKENERS. This method has not, to my knowledge, yet been adopted at any plant in Australia, but the great success that it has achieved at cyanide plants in America shows that it could be applied to the handling of tailing and slime products at Broken Hill. The usual type of Dorr classifier, however, would have to be especially lengthened to cause extra draining of the sand product. Owing to the regular working of these machines the usual draining-belt may be discarded. At the same time very little head-room would be required. This method is illustrated in Fig. 53, which shows the classifiers delivering direct onto the inclined belt. It has, however, the same disadvantage as the method last mentioned, in that it does not make the treatment-plant independent of the dump-belt stoppages. The cost of erection and maintenance would, however, be small.

HANDLING OF DRAINED PRODUCTS. Tailing may be handled in the following ways: (a) Inclined conveyor-belts and boom-stackers, (b) aerial trams, (c) trucking, and (d) sluicing.

INCLINED CONVEYOR-BELTS AND BOOM-STACKERS. The usual angle for an inclined conveyor is 20° ; where possible the conveyor should be driven from the head-end. Where the head-end is high above the ground, the drive should be either from the tail-end or from a large centre-pulley, midway along the belt, having a snub-pulley at each side above it, the centre-pulley being 6 to 8 ft. diam. and resting, preferably, on a concrete base.

The inclined conveyor is first of all built on trestles at the angle required. As the size of the dump increases, the conveyor is extended in the form of a cantilever, held by guy-ropes from the upright trestles in the dump. A belt to handle 40 to 50 tons per hour would require to be one of 24 in. six-ply rubber built on 3 to 10-in. stringers, placed 3-ft. centres. If driven from the head-end, the driving pulley should be 5 ft. diam. gear-driven, the tail-pulley being 2 ft. diameter.

The Australian practice is to use separate rollers and troughing-idlers instead of a combination idler. This practice is simple; the idlers can be more easily lubricated. The best size of roller is 4 in.

diam. It is usually made of steel pipe shrunk onto cast-iron end pieces. A favorite practice is to have idlers and dead-eyes on the top of the same stringers, the loaded and return belt running on rollers supported by the same, and being about three inches apart.

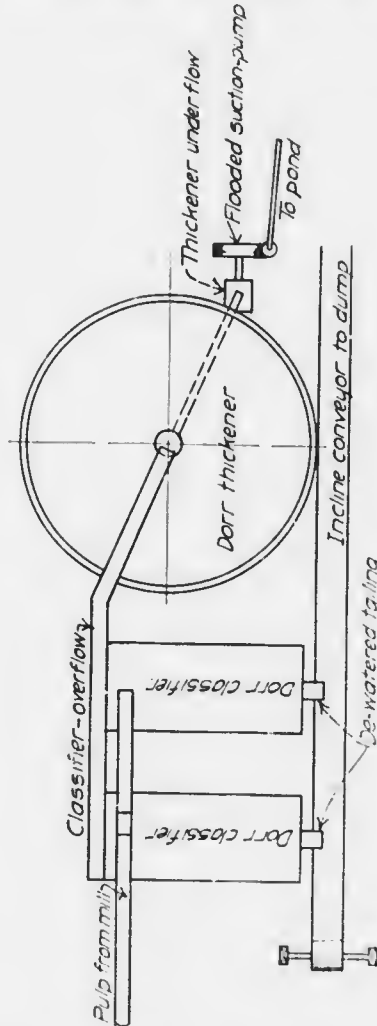

FIG. 53.

The top rollers are usually spaced 4 to 6 ft. centres, the return idlers being spaced at twice this distance apart. Wooden rollers for fast belts of this type are not satisfactory.

In calculating the power required for this type of belt it is well

to remember that the horsepower lost in friction per 100 ft. varies inversely as the length of the belt, averaging from 2 to 6 hp. per 100 ft. A tightening arrangement is usually fixed on the tail-pulley of this type of belt to cause it to run true and take up any unnecessary slack. When an inclined conveyor has been carried out to an economical distance, the tailing at its end is made into a bed for a boom-stacker. This is an iron pole, which is held in position by four strong guy-ropes. Attached to the pole is an iron lattice-girder, which is supported similar to a cantilever by guy-ropes attached to the pole itself. This boom-stacker rests on a steel ball in a cup-shaped receiving device, which enables it to swing around as desired. The weight of the boom-stacker is spread over a large area by means of a number of heavy timbers resting in the prepared foundation on the dump. The conveyor on the boom-stacker is driven by a motor fixed behind the boom, and traveling around with it. [The photograph (Fig. 49) shows a good boom-stacker at Kalgoorlie, Western Australia, from which place the Broken Hill system was largely copied.—EDITOR.]

AERIAL TRAMS. These are so well known that they need no description here. For moderate tonnage they are seldom used, as a bin is required and two men loading and operating trucks.

HANDLING OF SLIME. The pulp from Dorr thickeners is either transferred by flooded-suction centrifugal pumps or three-throw pumps, or else elevated by an ordinary belt-elevator. Where there is room for a slime-dam close to the treatment-plant, the belt-elevator, which is a very economical system of elevation, may be used. In other cases centrifugal pumps are resorted to. The thickened pulp may also be delivered to dams or sprayed onto the surface of sand-dumps. To remove the drained water it is preferable to use a wooden box-laundry. This consists of two box-launderers connected in the form of a right angle, and fixed in position at the starting of the building of the dam. The horizontal portion of the laundry is laid 12 ft. inside the dam, and is carried to the water-sump outside it. The vertical portion passes through the slime and is bored with holes, which are plugged from the bottom upward as the building of the dam proceeds. Probably the best method of handling slime-pulp is to pump it through a nozzle onto the surface of sand-dumps. By such means it may be sprayed evenly all over the dump. This does away with dams, and checks the dust rising from the sand-dump. The idea was first originated in South Africa, and has only lately been introduced into Australia.

THE ELECTRICAL THEORY OF FLOTATION—II

By THOMAS M. BAINS, JR.

(From the *Mining and Scientific Press* of December 11, 1915)

The article in the *Mining and Scientific Press* of October 23, 1915, by Mr. O. C. Ralston, has brought out many points of interest. It seems to me, however, that the fundamental principles of flotation can best be studied with larger particles, thus avoiding the interesting, but also little understood 'colloid' chemistry. In gravity separation by rising currents of water, Rittinger's formula $V = c\sqrt{D}$ (S-L) holds true for particles above a certain size, namely, about 0.2 mm. for quartz and 0.13 mm. in case of galena. Below these sizes, colloidal and other little-known phenomena become of importance and complicate the investigation. So it is with flotation.

In the laboratory, it is possible to use larger particles. The following experiments were conducted in the Case School of Applied Science on material sized through 20 and 30-mesh screens. The phenomena connected with preferential flotation furnish new evidence to strengthen the electrical theory.

The simplest experiment, demonstrating preferential flotation, may be performed as follows: Upon a 4-inch watch-glass, place a little galena, blende, and quartz, of 20 to 30-mesh size. Add dilute nitric acid and place the glass under a microscope. The acid attacks the galena, forming bubbles of H_2S gas that adhere to the galena. The particles of galena are electrified also, as can be seen by the actions of the particles. The blende and quartz are not attacked. If the ore had been finely pulverized and dilute nitric acid added, the bubbles of H_2S would have been sufficient to float the galena, leaving the blende and quartz at the bottom. However, with fine particles, some blende and quartz would have been entrapped, brought to the surface, and held there by surface tension. The bubbles are not sufficient to float the coarse galena, but by a vanning motion of the glass, the galena will collect, being brought and held together by the H_2S bubbles, forming a mat, which is lighter than quartz or blende and can, therefore, be panned off, leaving the blende and quartz. This experiment seems to show that the H_2S is charged oppositely to the galena.

If more concentrated nitric acid had been added to the ore, the blende would have been attacked and the process would have been reversed, the blende forming the mat while galena and quartz

were left behind. If dilute sulphuric acid, one part of acid to four of water, had been used, then both the blende and galena would have been attacked and if the ore had been finely pulverized, no 'preferential' separation would have resulted, both galena and blende finding their way into the float concentrate. However, with coarse material, the blende is much more highly charged than the galena and if the watch-glass be tapped and the contents given a vaning motion, the blende will gather most of the H_2S bubbles and finally float, leaving galena and quartz behind. This shows that the electrification of minerals varies with different acids and also with different strengths of the same. This action of one mineral, 'robbing' the others of their bubbles, has not been utilized in practice, as yet, but there is no reason why 'preferential' separations could not be made on a large scale, utilizing this principle. Less air or gas would be necessary than in the present type of frothing-cells and a clean concentrate would be produced at once. A separation of blende, galena, pyrite, and quartz may be made as follows:

Add dilute sulphuric acid and pan off the blende; then add dilute nitric acid and pan off the galena; then add concentrated sulphuric or nitric acid, which attacks the pyrite so that it may be panned off.

Or the separation may be made with nitric acid alone, varying the strengths; with sulphuric acid, by use of the 'robbing' action described above or by use of hydrochloric and other reagents that attack one or another of the minerals more strongly than the others. If galena or blende and magnetite be treated with dilute sulphuric acid, the magnetite will not be acted upon by the acid, but some of the H_2S bubbles generated by the sulphide will attach themselves to the magnetite, provided the bubble is formed near the magnetite. This illustrates the fact that electrical conductors in a conducting liquid attract electrified bubbles. A slight jar, however, will displace these bubbles; or a piece of sulphide in close proximity will rob the magnetite of the bubble, magnetite being a poor conductor.

Referring to the article on page 668 of the *Mining and Scientific Press* of October 30, 1915, describing a patent for preferential flotation of blende, galena, and pyrite, the second paragraph reads: "The new process consists of treating ores in a medium (*i. e.* sulphuric acid and sodium sulphite) that wets the zinc sulphide and which does not wet the lead sulphide or pyrite." This phenomenon brings out nicely the part played in flotation by the "dielectric film." When thio-sulphates, sulphites, or bi-sulphites are acted upon by sulphuric acid, there is more to the phenomenon than formation of SO_2 gas

The following reactions take place when blende and galena are treated with sulphuric acid and sodium sulphide:

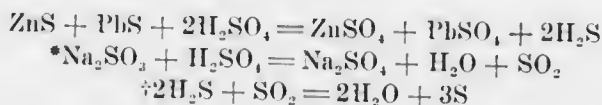

This sulphur thus formed is in a very fine state and acts as a dielectric film about the galena, for which it has a great attraction. Therefore, no frothing agent is needed in this case, as the dielectric film about the bubbles is formed by the sulphur similarly to the films of oil formed in the ordinary flotation processes. In the last paragraph of the above-mentioned article on 'Preferential Flotation,' the statement is made that "the procuring of the effect aimed at, is dependent upon the presence of a frothing agent, *only* when a reducing gas is *introduced* into the medium. It is not dependent on the presence of a frothing agent in the flotation medium, when a reducing gas is *generated* in the flotation medium by a reaction of a substance introduced into it." In other words, if sulphur or any other 'dielectric' is liberated in a very fine state, by a "reaction of a substance introduced," no frothing agent need be used.

This action may be nicely illustrated by taking 20 to 30-mesh galena and blende and treating them with dilute nitric acid on a watch-glass and observing the result under a microscope. The galena will gather all the H_2S bubbles, when vanned. Now if the sulphuric acid is added and the watch-glass be tapped and the particles moved over one another, the H_2S bubbles on the galena will be robbed by the blende. Sulphur may be seen surrounding the bubbles, the reaction being as follows:

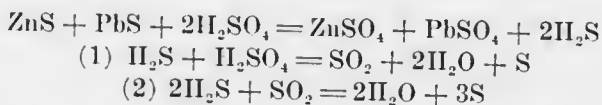

In (1), the sulphur is formed from the decomposition of H_2S ; and would be charged oppositely to the sulphur formed by the decomposition of SO_2 gas. In (2), we have both negatively and positively charged sulphur particles.

The larger bubbles, with sulphur particles adhering to them, may burst on reaching the surface and their film of sulphur will spread

*Newth's 'Inorganic Chemistry,' p. 417.

†*Ibid.*, p. 436.

over the water. If particles of mineral had been attracted to the bubble, then these particles would have remained attached to the sulphur film, even after disruption of the bubble, showing the electrification of the dielectric film. The same phenomenon occurs when the film is a liquid dielectric, like oil.

The laboratory tests with chemical reagents generating H_2S gas give the opposite results from the regular air-bubble flotation. The ordinary flotation method in practice is to add a little acid and frothing agent to the pulp. The sulphides are positively charged by friction, while the frothing agent and air are charged negatively. The oil surrounds the sulphides, but the film is so thin that the negatively-charged bubble is attracted by the positively-charged sulphide. If the film of oil is too thick, the attraction between the sulphide and bubble is too feeble, and flotation fails.

In the laboratory, H_2S is charged positively, but the sulphides are charged negatively by chemical action. So the bubble attaches itself to the electrified sulphide.

In preferential flotation of galena and blende, in practice, the ore is treated with H_2SO_4 and Na_2SO_3 . Sulphur is liberated and the galena is coated with the particles of sulphur positively-charged, while the negatively-charged sulphur coats the gas bubbles. The negatively-charged air bubbles of the flotation machine attach themselves to the positively-charged sulphur coating the galena and repel the negatively-charged blende.

In the laboratory experiments, the H_2S bubbles are charged positively and are attracted to the negatively-charged blende and repelled by the positively-charged sulphur on the galena. In this case, the blende is floated. When H_2S is blown into the pulp in practice, no sulphur is formed—the H_2SO_4 solution being too weak for this reaction. Therefore, to make a persistent froth, a frothing agent must be added to the pulp.

In conclusion, it may be well to call attention to the fact that for laboratory experiments in preferential flotation, any one of the sulphides may be separated from the other sulphides, (*a*) by the use of some reagent that attacks this particular sulphide and not the others, (*b*) by the use of a reagent that attacks one sulphide more vigorously than the others; in this case, the vanning motion allows the sulphide more highly charged to gather up the bubbles from the sulphides less highly charged, and if sufficient bubbles are collected, the mass of bubbles and sulphide will float. If not sufficiently buoyed, the mass remains submerged, but it is lighter than the other sulphides

or gangue minerals and can be panned off or separated by hydraulic classification.

The second point of interest is the formation of a frothing agent, within the pulp, when reactions take place that liberate dielectric substances in a very fine state, electrically charged.

The third point is that laboratory experiments may not work out in practice, due to failure to understand the nature of the electrical charges of the bubbles, dielectrics, and particles of ore. A little stronger reagent or a different way of frictionally electrifying the bubbles and pulp, or too thick a film of dielectric or frothing agent causes the attraction to cease or change. It is no wonder that great difficulty has been experienced in the practical application of flotation to ores, when such delicate electric forces have to be considered.

EFFECTS OF SOLUBLE COMPONENTS OF ORE ON FLOTATION

By AN OCCASIONAL CORRESPONDENT

(From the *Min. and Scientific Press* of December 18, 1915)

In concentration by flotation, the soluble components of an ore may play an important rôle. Occasionally ores that are shown by preliminary test to be unsuitable for flotation may be treated by the process after the soluble ingredients have been removed by decantation. On the other hand, excellent results may be obtained on certain ores by flotation in fresh water; but when the water is fouled by successive contact with fresh lots of ore (as is often the case in mill-practice) the results may be far from satisfactory.

This article deals with a determination of the fouling agents in a certain ore, and outlines methods for overcoming such fouling efforts. Since all tests were made on ore from a single mine, the results cannot be regarded as generally applicable; however, it is hoped that the experience recorded here may be of some interest to others studying similar problems in flotation.

The tests were made on a silicified-rhyolite ore assaying silver 37 oz., gold 0.15 oz., lead 1%, copper 0.25%, and zinc 1.5%. The principal minerals were argentiferous sphalerite, argentiferous galena, and stromeyerite. The value lay almost entirely in silver. For this reason, only silver assays are here recorded. Sufficient analyses were made to indicate that the concentration of zinc, lead, and copper roughly paralleled that of silver.

Preparatory to making the tests, a large general sample of ore was ground to pass a 200-mesh screen, and thoroughly mixed. In each test, a 200-gram portion of the general sample was emulsified with one litre of water and 0.05% of crude pine-oil. The mixture was then treated for a half-hour in an experimental flotation machine, consisting of an agitation-chamber connected in such a manner with a concentrate-separation chamber, as to permit of repeated treatment of the tailing. Results in a flotation plant treating this ore roughly checked the work in the experimental machine.

Preliminary tests showed that when the ore was treated by flotation in fresh water, the tailing assayed 13 oz. silver and the concentrate assayed 440 oz. per ton. When the water used in the first test was removed by filtration and re-used on a second test, the tailing assayed 18 oz., and the concentrate 240 oz. When the

same water was re-used a third time on a fresh sample of ore, the tailing assayed 27 oz.; the concentrate, 190 oz. Evidently some extremely deleterious substances had been dissolved from the ore. An analysis was made of the water filtered from the third test, with the following results:

Iron (ferric)	Tr.
Iron (ferrous)	0.002%
Aluminum	Tr.
Calcium	N:1
Magnesium oxide	0.012%
Sulphur	0.020%
Manganese	0.001%
Potassium and sodium	0.010%
Copper	Tr.

Most of the soluble minerals were present as sulphates.

The next step was to determine the effect, on flotation, of the various sulphates.

Sodium and potassium sulphates, when added to fresh tests in the proportion indicated in the analysis, yielded a 13 oz. tailing and a 650 oz. concentrate; thus producing a marked increase in the grade of concentrate without detrimental effect on the tailing.

Manganese, magnesium, and ferric sulphates produced no effect when added in the proportions indicated; in larger amounts, magnesium sulphate was harmful and ferric sulphate beneficial.

Ferrous sulphate proved extremely injurious to flotation. When present as above recorded, a 20 oz. tailing and a 240 oz. concentrate were produced. When a small amount of copper sulphate was added to the same quantity of ferrous sulphate, the tailing assayed 25 oz., and the concentrate 200 oz. Evidently ferrous and copper sulphates were the principal fouling agents in the original tests.

It was necessary to devise means for correcting the effects of these sulphates.

First: sufficient sulphuric acid and hydrogen peroxide were added to a charge containing ferrous sulphate to convert the ferrous sulphate to the ferric state. The tailing from this charge assayed 11 oz., and the concentrate 800 oz. With the same amount of acid, but using no peroxide, the tailing assayed 14 oz., and the concentrate 780 oz. Evidently the acid increased the grade of concentrate and also decreased the injurious effects of the ferrous sulphate upon extraction.

Second: efforts were made to precipitate the ferrous and copper sulphate. A test, containing these sulphates in the proportions indicated in the analysis, was rendered slightly alkaline by the

addition of lime hydrate. The tailing assayed 12 oz., and the concentrate 450 oz. When sodium hydrate was used in place of lime, the tailing assayed 8 oz., and the concentrate 600 oz. With the iron precipitated by sodium carbonate, the tailing assayed 6 oz., and the concentrate 800 oz. With a combination of lime hydrate and sodium carbonate, the concentrate assayed 800 oz., and the tailing 3 oz. Evidently the use of hydrates and carbonates produces much better results than can be secured by acid. The cost of sodium hydrate and sodium carbonate, and the injurious effects of the latter upon settling and filtration, restricts the use of these chemicals. Lime hydrate, on the other hand, presents a cheap and efficient means for preventing the accumulation of ferrous sulphate in mill-solutions. The calcium sulphate resulting from the reaction is somewhat detrimental to flotation; a saturated solution yielding a 16 oz. tailing and a 450 oz. concentrate. In ordinary practice the solution would be far from saturated, and the results much more satisfactory.

The lime-hydrate method has been successfully used on this ore in continuous mill-tests. During flotation the alkalinity was maintained as nearly as possible at 0.02 lb. lime-oxide per ton of water. After flotation, half the circuit-water was wasted, the remaining half being supplemented by fresh water, at the head of the mill; lime sulphate thus being prevented from accumulating in the solution. For a month during which the process was used, the concentrate from the flotation plant averaged 600 oz., and the tailing 6 oz. This compares favorably with a 20-oz. tailing from gravity concentration and a 12-oz. tailing from flotation in an acid solution. Aside from effecting better concentration, the lime method is cheaper than the acid process and is not injurious to subsequent cyanidation.

When lime is used in flotation, extreme care must be exercised in maintaining the proper alkalinity. The table submitted herewith shows that the best results, both as regards extraction and grade of concentrate, are secured when the alkalinity during flotation is extremely low (between 0.01 and 0.02 lb. CaO per ton of solution). Experiments indicate that alkalinity is beneficial to flotation but that the coagulating effect of high lime upon slime increases the affinity of the slime for the froth, lowering the grade of concentrate. When the coagulating effect is counteracted by the addition of sodium carbonate, or when sodium hydrate is used in place of lime, an alkalinity equivalent to a half-pound of CaO per ton of solution may be maintained without harmful effects on flotation.

Usually a bare alkalinity maintained with quicklime produces equally good results.

In order further to study the effects of copper sulphate on flotation, a solution containing 0.01% CuSO_4 was employed in another series of tests. When this solution was used alone the separation was extremely poor, the tailing assaying 32 oz. and the concentrate 100 oz. When sufficient quicklime was added to produce a slight alkalinity, the tailing was reduced to 24 oz., while the concentrate increased to 180 oz. per ton. A further improvement was effected by the use of sodium hydrate, a 340 oz. concentrate and an 11 oz. tailing being secured. This was still far from satisfactory.

An attempt was made next to precipitate the copper as sulphide. By employing hydrogen sulphide in a solution rendered alkaline by lime hydrate, a 6 oz. tailing and a 450 oz. concentrate were obtained. When sodium sulphide and sodium hydrate were used, the tailing-assay was reduced to 3 oz., and the concentrate increased to 700 oz. These results show that the injurious effect of soluble copper may be overcome by the use of hydrogen or sodium sulphide in conjunction with lime or sodium hydrate.

The following conclusions were established for the ore tested:

1. Sodium, potassium, and ferric sulphates are rather beneficial to flotation than otherwise.
2. Manganese sulphate has practically no effect on flotation.
3. Magnesium and calcium sulphates are slightly harmful, while ferrous and copper sulphate are extremely harmful.
4. The effect of magnesium and calcium sulphates may be overcome by the use of sodium carbonate in an alkaline solution.
5. The effect of ferrous sulphate can be overcome by the use of sulphuric acid or, better still, by employing quicklime, caustic soda, or sodium carbonate.
6. The effect of copper sulphate may be overcome by the use of hydrogen sulphide or sodium sulphide in an alkaline solution.
7. The use of sodium carbonate, though aiding materially in flotation, is of doubtful utility in plants where the pulp must be dewatered.
8. Lime hydrate is slightly less satisfactory metallurgically than sodium hydrate or sodium carbonate, but the use of it is inexpensive and aids materially in settling and filtering.

FLOTATION—A PARADOX

By DUDLEY H. NORRIS

(From the *Mining and Scientific Press* of December 25, 1915)

Flotation is a paradox. In a flowing mixture of finely pulverized ore and water it causes the heavy metallic sulphides to float to the surface, where they are collected for further metallurgical treatment, while the light barren gangue sinks to the bottom and is run into the tailing-pond.

This apparent reversal of the attraction of gravitation is due to the introduction into the flowing mixture of a small quantity of oil or other emollient in such a manner that every particle of the ore, whether metallic, or gangue, is brought into contact with the oil, whereupon there is what seems a selective action between the oil and the metallic particles such that these become coated with the oil, whereas there is no such action of the oil upon the gangue. Under proper conditions, at or about the same time that this oil coating of the metallic particles takes place, there may be caused to appear in the flowing mixture bubbles of air. These attach themselves to the oil-coated metallic particles and stick to them with more or less tenacity, making a new entity consisting of metallic particle, oil-coating, and air-bubble. The specific gravity of this entity is less than that of the water of the flowing mixture; thereupon, because of the attraction of gravitation, and not in spite of it, the heavy metallic sulphides float to the surface and the comparatively light gangue sinks to the bottom, neither oil nor bubbles having any tendency to attach themselves to the barren gangue.

My interest in flotation arose from the accumulation at my mine, the Magistral, at Zacatecas, Mexico, of a couple of hundred thousand tons of chalcopyrite ore of low grade which I had tried unsuccessfully to treat by water concentration. I came to San Francisco in February 1905 and went to London in June 1906, to investigate the two Elmore processes. I sent some of my ore to London and the tests showed a saving of 90% or more by the vacuum process. I set up an Elmore laboratory plant at the Magistral mine, 9000 ft. above sea-level, but got no satisfactory results—I judged that the altitude acted as a partial vacuum and that there was no air left in solution in the water. I then led a small pipe from the air-compressor and, tying a folded pocket-handkerchief over the end of the pipe, fed compressed air into the flowing mixture through 16 thicknesses of

fine linen, 150 threads to the inch. I found that with a light pressure of air the bubbles coalesced on coming through the fabric and when released and started on their upward journey were of a uniform size, about that of a marrow-fat pea. With greater pressure the size of the bubbles was reduced, but the action of the air was so violent that the mixture was like a boiling geyser and everything, ore and gangue alike, was brought to the surface. Thereafter my flotation experiments were suspended until one day in a Pullman car on the Mexican Central railroad I drew some water into the hand wash-basin and I noticed that it was as white as milk, but presently became just ordinary transparent water. I saw at once that this was due to an artificial aeration of the water in the tank under the car, and when the train stopped, I read from the gauge that the pressure in the tank was 11 atmospheres. That seemed to be a solution of the problem of the lack of air in the water of the Elmore process; so I patented the method, together with the apparatus for utilizing the same.

It is not proposed here to discuss any theories of flotation, surface tension, ions or static or electric conditions or to explain phenomena, of which we at least know a little, in terms of something of which we know less. Instead of that, a classification is suggested, homely and commonplace in its terms, but which will impress upon anyone the exact limitations of each kind of flotation.

The oldest flotation is that including Everson, Froment, and others, and the Minerals Separation. It produces an "agitation to form a froth" and is exactly duplicated by the activity of the cook with a Dover egg-beater stirring what she is apt to call an "egg-omelette."

Then there are the Australian processes known as the De Bavay and the Delprat, where an acid acts upon an alkaline carbonate and releases the carbonic acid gas, which action is duplicated in common life by the efficient Seidlitz powder.

Then there is the Elmore, which gets from ordinary water the air that the goldfish in the aquarium gets, and no more.

Then there are the Callow and the Towne processes, where air is forced through a porous medium, as above described; and, finally, the Norris process, which utilizes the air dissolved in water under pressure, as seen in the Pullman car or in the water-service at many places on the eastern shore of San Francisco Bay.

I believed that I had discovered a basic principle in flotation, and in September 1906 I applied for U. S. patents on the method

and on the apparatus for using the Pullman bubbles in flotation; later I took out patents in ten foreign countries on the same basis. Continuing my metallurgical investigation in the summer of 1907, I went to nearly all the principal copper-concentrating mills in Colorado, Utah, and Arizona, and to Cananea. I saw all the stars of the first magnitude in the copper metallurgical firmament, but they shed no light on flotation. In fact, I was asked how the word was spelled. The net result was that I went back to Zacatecas and later built the Magistral smelter.*

About this time I received word from my patent attorneys that I was opposed in the London patent-office by the Minerals Separation; but I instructed them not to appear and the case went on without me, as will be seen by the decision in the case where it is cited that "At the hearing Mr. Ballantyne appeared for the opponents; the applicant was not represented." Notwithstanding the fact that the opposition had things all their own way, the London patent-office over-ruled the opposition and decided in favor of issuing my patent, and when the Minerals Separation appealed to the law-officer the decision was affirmed, on February 24, 1910, and the British patent duly issued to me.

In the recent case of Minerals Separation against Miami, counsel for plaintiff said that the defendant interpreted the older patents, not in the light of the state of the art at the time the respective patent was applied for, but in the light of later developments. It so happens that a reference to the decision in Minerals Separation *v.* Norris before the British patent authorities, shows that the Minerals Separation is now doing that very thing.

My British application was dated June 27, 1907, and was opposed by the Minerals Separation on the grounds of prior British patents, as follows:

No. 12,776 A.D.	1905—Froment
No. 29,283	1904—Elmore
No. 7,803	1905—Sulman
No. 26,712	1905—Sulman
No. 13,268	1907—Hoover

These include the British patents corresponding to some of the American patents on the basis of which the Minerals Separation sued Hyde and Miami in the United States courts, and the suits are now pending. The case in the British patent-office was decided, and

*See 'The Copper Handbook,' 1912, page 545.

the decision bears date, March 15, 1909. Consequently the position of the Minerals Separation as to the basis of their patent rights as stated in the case against me, between June 27, 1907, and March 15, 1909, is the true statement of their own idea of their rights and position and not that set up in the later cases some years after, and in the light of the more mature experience which is protested by Minerals Separation itself when used by the Miami company.

Here is the Minerals Separation position in the case against Norris, as appears in the decision, which says that Mr. Ballantyne relied mainly on the Sulman and Hoover patents. He contended that the underlying idea of the various processes is asserted in Claim No. 1 of the Sulman patent, that is, introducing by some means or other air under pressure into pump containing oil and water and then allowing the pulp to come into a vessel which is open at the top to the atmosphere.

Claim No. 1 of the American Sulman patent "consists in mixing the powdered ore with water, adding a small proportion of an oily liquid having a preferential affinity for metalliferous matter (amounting to a fraction of 1% on the ore) agitating the mixture until the oil-coated mineral matter forms into a froth and separating the froth from the remainder by flotation." There is no hint in Mr. Ballantyne's presentation of his case before the London patent-office that he or his client, the Minerals Separation, placed any importance upon the little phrase in parenthesis (amounting to a fraction of 1% on the ore) and it can hardly be imagined that any court would permit, at this late day, a substitution of another idea for what Mr. Ballantyne claimed, in the case against Norris, to be the underlying idea of the various processes.

The decision, in my favor, contained these words: "It appears to me therefore, that the applicant is entitled to a patent for his invention****I decide therefore to seal a patent on the application***." The Minerals Separation appealed, but the decision was affirmed and the patent issued February 24, 1910. The Federal Circuit Court of Appeals, on appeal, decided the Hyde case against the Minerals Separation, in these words:

"We hold that to sustain the appellee's patent would be to give to the owners thereof a monopoly of that which others had discovered. What they claim to be the new and useful feature of their invention, as stated by their counsel, is agitating the mixture to cause the oily-coated mineral to form a froth. As we have seen, that feature was clearly anticipated by the prior art, and when the

elements of the appellee's claims are read one by one, it will be found that each step in their process is fully described in more than one of the patents of the prior art, with the single exception of the reduced quantity of oil which they use."

The judgment of the court below was reversed by the Circuit Court of Appeals and a motion for a re-hearing was denied. Then the Minerals Separation applied to the U. S. Supreme Court for a writ of certiorari, which was granted, and the case is now before that court. The Minerals Separation advertised that the Supreme Court had granted their petition, without going into details as to just what the petition was. As a matter of fact, the granting of a writ of certiorari by the Supreme Court is in no sense a decision on the merits of the case.

Prior to 1891 an appeal to the Supreme Court from a Circuit Court was a matter of course, if the sum involved reached \$1000, the result being a crowded calendar, years behind. In 1891 the Judiciary Act abolished the Circuit Courts, merging their functions in the District Courts, and creating the Circuit Courts of Appeals with final jurisdiction in many classes of cases, including patents. The Act provided for a writ of certiorari in cases where the judgment of the Circuit Court of Appeals is final and the rules of the Supreme Court say that the writ will issue where cases of great gravity or importance are involved or where two different Circuit Courts of Appeals have rendered conflicting decisions.

The proceedings on the application are very technical. A petition must be presented setting forth the facts of the case together with the reasons for the writ. Two weeks notice, or west of the Rocky Mountains, three weeks, to the adversary; and no petition will be granted within a fixed time before the end of the term. With the petition must be filed a certified copy of the papers on which the court below acted and 30 copies uncertified. No oral argument is allowed. As Chief Justice Fuller expressed it: "The inquiry upon the application is whether the matter is of sufficient importance in itself and sufficiently open to controversy to justify the writ."

At the October term of 1914, at which the petition for the Minerals Separation writ was granted, there were 45 applications for writs of certiorari, of which 11 were granted and 34 denied. In the reports no reason is given for the Court's action in deciding petition for certiorari; but it is extremely probable that a certain number of the applications were denied because the technical requirements of the rules were not observed. That is about the gist of

the present state of the Hyde case. There has been no pardon nor commutation nor reversal, but merely a stay of execution.

The Minerals Separation also advertised that they had 36 patents on flotation, suggesting that their collection includes about all the flotation patents that have any real value. Unfortunately for this view, there is a letter in existence written by the Minerals Separation which says: "It is our custom to add flotation patents to our collection if they can be obtained reasonably whether they are of any immediate importance to us or not." That being their custom and the decision of the Circuit Court of Appeals being so strongly against them, the inference is irresistible that however little these waifs and strays of patents were bought for, they were not worth it.

One can understand the keen regret on the part of the Minerals Separation that their Froment process had not been patented in this country, but only in Italy and England. They started with the Cattermole process, which was not a success, and acquired the Froment afterward. The Cattermole, using 4 to 6% of oil, was an improvement on the Elmore, which used more. They acquired the Froment, which was a bubble process as against the processes using only oil, and then began a new series of American applications for patents. The attempts of the Minerals Separation to get a foothold in this country for their process of flotation by "agitation to form a froth" begin with 835,120 Sulman *et al.*, dated November 6, 1906. This contained the agitation-to-form-a-froth idea but it is crudely worked out. Next came:

953,746. Hoover, April 5, 1910, with three beaters in an agitation-vessel; but this claims only one in patent for apparatus. Next came

955,012. Sulman, April 12, 1910, for process corresponding to Hoover's apparatus. Then

955,857. Hoover, December 27, 1910, claims mixing-vessel, an agitator therein, spitzkasten; also, a secondary mixing-vessel. Then

1,064,209. Hebbard, June 10, 1913. Claim 1. Apparatus for ore concentration by gas flotation, consisting of two adjacent mixing-vessels each containing a rotating agitator and a spitzkasten contiguous. Claims 3, 4, and 5 cover a number of these elements.

1,067,485. Nutter *et al.*, July 15, 1913. Process for concentrating ores consisting of agitating water containing mineral-frothing agent, removing the froth, agitating pulp again with addition of another agent, producing another froth, "and so on."

1,084,196. Broadbridge *et al.*, January 13, 1914. Apparatus for

agitation-frothing process comprising a series of agitating and aerating vessels and a series of spitzkastens.

1,101,506. Bradford, June 23, 1914. Introduces flowing mixture from mixer into a centrifugal pump, adding sulphuric acid and air and steam. Agitates to form a froth.

In all these patents the Minerals Separation is the assignee and the gradual advance is noticeable from the first claim of one vessel to the next claim for two mixing-vessels, then one agitation and another, "and so on." How far on is "so on"? Do they claim to use a third and a fourth vessel, and if so, must they use a different "mineral frothing agent" every time, or can they repeat with the same one? By the way, just what, in a strictly legal sense, is a "mineral frothing agent"? Does this cover any further discovery of such an agent that is thus preëmpted in advance? Is it anything and everything that will make a froth with a mineral?

Much of the phraseology of the Minerals Separation patents is vague and loose-jointed. If intentionally so, with the idea of making the most favorable interpretation in any circumstances that may be presented, the object is self-defeated, for it is an elementary principle of legal interpretation that words shall be strictly interpreted against the person using them.

This tendency is shown in Mr. Ballantyne's statement that Claim No. 1 of the Sulman patent is for the underlying idea of the various processes, introducing by some means or other air under pressure into pulp containing oil and water. "By some means or other," by any possible means, and Minerals Separation claims them all. "Agitation to form a froth" was their great claim, and in practice they seem to claim any agitation for any purpose whatever and any froth, however formed. So far has this been carried that it is said that Callow has desisted from the use of a paddle to keep his canvas clear from sand, although disclaiming any intent of forming a froth with it, because the Minerals Separation company takes the paddle to form a froth and proposes to keep it for all other purposes.

The present situation of flotation metallurgy is intolerable. There is every appearance that some time, perhaps years, may pass without a final judgment of all the Minerals Separation litigation and meanwhile they keep on collecting royalties from parts of the mining industry that are available for coercing the rest. Progress is halted. Development is retarded. Can nothing be done to rid the metallurgical Sinbad from this Old Man of the Sea? Statements

are freely made that in case of a final Minerals Separation victory, a strict accountability will be required from all infringers.

The Norris process has given excellent results with the apparatus of both Minerals Separation and of Callow, the concentrate being of excellent grade from the rougher and from a slower stirring-apparatus after the Elmore style of mixer. The process can be adapted to any type of tank, box, spitzkasten, or other receptacle and there is no danger of defeat from an attack on the Norris patents by the Minerals Separation. A method can be devised to float ores without using the Minerals Separation patents or paying them royalties. The day of royalties on daily tonnage is past. Arrangements can be made freeing the industry from this toll and also from extravagant prices for patented machinery.

The suggestion has recently been made that one of the most needed things in the mineral industry at the present time is some easy way of making flotation tests at the mine; so that a mill-foreman or mine-boss may be able to make his tests on his ores and decide whether or not they are susceptible to flotation and then design a process for treating them. Of course, any accomplishments that a foreman or mine-boss may have, add to his value; and ability to set a broken leg or cure a case of mountain fever might earn for him an additional salary, but aside from 'first aid' to the injured, no one would want to put himself in the hands of the foreman or the underground mine-boss for medical treatment. It is the same way with tests on flotation. Aside from mere preliminary experiments, testing ores for flotation is as much a separately professional matter as caring for a broken leg or a case of mountain fever. Metallurgical engineering is now so far advanced that there is but small reason for going astray in the matter of treatment of ores by flotation, provided adequate preliminary tests are made by expert metallurgical engineers. The cost of such tests is trifling and their importance and value not to be exaggerated.

One great reason why a mere practical millman or miner cannot devise a process from the patent claims and specifications is that most of the important elements of the actual installation are omitted from the patent. The essential principle of the patent of Elias Howe for the sewing machine was that the eye was in the point of the needle. Taking that for a starter, how far would a man get toward building a modern Singer from the Howe patent? It is like an equation in calculus. Take such an equation representing a mechanical movement and compare it with another equation of the

path of a comet. Differentiate both and out go the constant factors and the differential equations might be identical in form. Re-integrate them. Do you get back your mechanical movement and your comet's orbit? You do not. Your constant factors do not re-appear. The same way with patent specifications and claims. They contain only the differentials. In fact, a recent letter from the Patent-Office said: "It is suggested that the claims eliminate all unnecessary references to structure and that they be limited to the actual process steps."

By a proper combination of interests, not only can there be avoided the payment of royalties on ores treated and high prices for patented machinery; and not only can every mill-owner be assured of the constant high efficiency of his plant, but he can be protected against infringing patents, and if sued for infringement he can be defended at a trifling cost to himself, a general fund being provided, at a small percentage of what the use of the Minerals Separation patent would cost him. The way to do is to perfect a process in a metallurgical laboratory to fit the special ore in each case. When the process is perfected care must be taken that it includes the patent principle under which it is to be licensed and does not infringe any other patent. In one mine in the Ninth Circuit where a home-made process has been patched up, it seems as though every well known flotation patent has been infringed, and yet the process will not work as it ought.

Well, suppose the program is carried out and the Norris process is generally adopted, and the Hyde and Miami suits are decided in favor of the Minerals Separation. That has no effect on the Norris process, not being a party to the present suits. A new suit would have to be brought against new defendants and another term of years passed before the Minerals Separation could hope to get any money, however favorable their case. But their case would not be favorable. The first thing that they would meet would be a certified copy of the proceedings in their own country where their own Government decided that the Norris process, although the applicant was not represented at the hearing, was not an infringement of the five patents governing the Froment, the Elmore, or the Minerals Separation processes respectively.

The Minerals Separation people were so sure of their strategic position, so confident that their American patents would be sustained by the courts that, from what seems mere wantonness, conditions were imposed upon the licensees that were intolerable; with the result



MICROCOPY RESOLUTION TEST CHART

ANSI and ISO TEST CHART No. 2

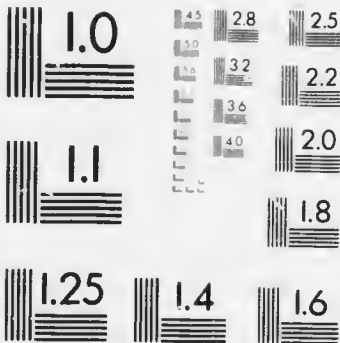

APPLIED IMAGE Inc.

1655 East Main Street
Rochester, New York 14643 USA
Tel: 482 0400 Phone
716 288 5989 Fax

of a concerted movement on the part of the whole mining industry to defeat the Minerals Separation patents and, from the present outlook, with every prospect of success.

FLOTATION OF GOLD ORES

(From the *Mining and Scientific Press* of December 25, 1915)

The Editor:

Sir—Mr. A. E. Drucker, well known for his work in cyanidation, in a letter appearing in your issue of November 20, made some very pertinent remarks in regard to flotation, more particularly concerning its application to gold and silver ores. His view is that of a metallurgist rather than of the man interested in the introduction of flotation. There is, as Mr. Drucker points out, a place in nearly every gold and silver mill for a flotation plant, and from the work that I have done so far, I have come to the same conclusion, namely, that flotation will be used in connection with water concentration, and that its best place in a gold and silver mill is in the treatment of the slime.

I think that in the future a common method for the treatment of gold and silver ores will be concentration by water and the treatment of the resulting sand by cyanide, with the use of flotation for the slime. A scheme like this could be adopted in many cases, thus obviating the necessity for fine grinding. The removal of the pyrite from the sand would allow quick treatment by cyanidation of the sand and the flotation of the slime, which would do away with the most expensive part of the cyanide plant, namely, the slime annex. However, the constantly recurring question would be: what to do with the flotation concentrate. Considerable work is now being done in our laboratory to obtain a flotation concentrate low in insolubles. The average amount of insolubles is about 30%. I am now carrying out some tests to reduce these insolubles to a minimum, because if the concentrate is to be handled or shipped, it should contain the lowest possible percentage of insolubles. Flotation is now on the map and will be appearing constantly in the flow-sheets of the future.

CHAS. BUTTERS.

San Francisco, December 13.

TESTING ORES FOR THE FLOTATION PROCESS

By O. C. RALSTON AND GLENN L. ALLEN

(From the *Mining and Scientific Press* of January 1, 1916)

INTRODUCTION. *Although the subject of testing for flotation has been well presented in T. J. Hoover's book on 'Concentrating Ores by Flotation,' there is need of later information on this timely subject. Much testing has been done in laboratories not connected in any way with the Minerals Separation company, with which Mr. Hoover was formerly associated as metallurgical engineer, and there have been developed methods of investigation that may prove suggestive to many experimenters.

On that account we have compiled data on the subject of testing both from the literature available and from our own experience, as well as from what we have seen in other laboratories. This paper is designed to present the results of this compilation, with a critical discussion of the more important methods now in vogue.

On account of the empirical state of the art of flotation a great deal of testing is necessary before large-scale practice can be commenced on any ore; therefore a small laboratory-machine is necessary in which many tests involving many variables can be made in a short time. The machine must be so designed and so operated that a close approximation to the results possible with full-sized flotation machinery will be obtained. In a mill-plant it is a matter of some difficulty to control conditions through a wide range of such variables as temperature, acidity, quantity of oil, percentage of solids in pulp, fineness of grinding, etc., and as the proper treatment of a given ore can be ascertained only through testing it first, a critique of the testing methods in use is in order.

Many people have had the experience of reading the available literature on flotation-testing and of failing to get satisfactory results when the described testing was attempted. To actually witness some good test-work and learn thereby the appearance of froth, the exact manipulation of the machine and froth, goes far toward bringing the beginner to a point where he can test efficiently.

*By permission of the Director, U. S. Bureau of Mines. Communicated by D. A. Lyon, metallurgist in charge of the Salt Lake station of the U. S. Bureau of Mines, co-operating with the University of Utah. O. C. Ralston, Assistant Metallurgist of U. S. Bureau of Mines, and Glen L. Allen, Research Fellow of the University of Utah.

None of the literature mentions the fact that it is difficult to get a high percentage of extraction and a high grade of flotation concentrate at the same time. The beginner often strives after both of these things in a single test, whereas he should determine how each can be attained before he attempts to obtain both simultaneously. Furthermore, it is difficult to manipulate a small machine to give as good results as a large one, until after considerable practice. So the small machine is generally pessimistic, compared with the large one. It is practically essential for the beginner to weigh and

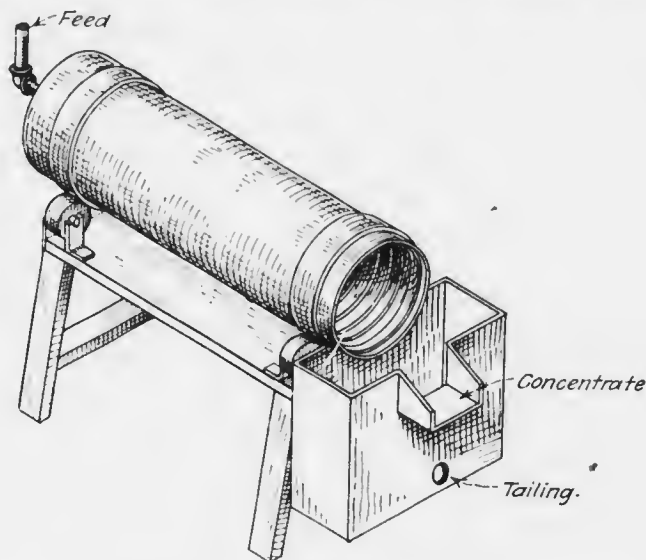

FIG. 54. THE MACQUISTEN TUBE.

assay all of his products in order to see if the extraction and the grade of concentrate are satisfactory, where an experienced manipulator can often tell by aid of past experience and the use of a glass or microscope whether he is getting good results or not.

With these points in view, we shall describe first the satisfactory machines and their operation. Then we shall give a more general exposition on what variables to study and what points to observe.

Flotation test-apparatus must necessarily be classified in the same way as large-scale machines, namely, as film-flotation machines, acid-flotation machines, and froth-machines of both pneumatic and mechanically agitated types. Film-flotation, as exemplified in the

Macquisten¹ and in the Wood machines, does not seem to have the same wide application as does froth-flotation; hence little need be said about them.

FILM-FLOTATION. Macquisten tubes have such small capacity that a single tube is small enough for test-work on a few pounds of ore at a time (see Fig. 54). A small 4-ft. tube is known to give trustworthy results, although a longer one is more desirable. Testing with a Macquisten tube was done for several years in the laboratory of the General Engineering Co., of Salt Lake City, of which company J. M. Callow is president. Since Mr. Callow has begun the exploitation of his own pneumatic frothing-machine this work has been set aside.

The Wood machine can be built in miniature and for several years a small machine of the type sketched has been used in the plant of the Wood ore-testing works at Denver.² This small machine was about two feet long and one foot wide. The method of operation is the same as that of the full-sized machine. (See Fig. 55.)

As neither of these machines has been much used in practice, they are merely mentioned for the sake of completeness. Hoover³ has recommended a test on a vaning-plaque, so that the sulphides will float off onto the surface of the water, but we consider this test of practically no value. Hoover, however, acknowledges that it is merely a test illustrative of the film processes.

In testing ores for the Potter or the Delprat processes, Hoover's text is again the source of information. An illustrative test-tube experiment is pictured in Fig. 56. Tubes containing 3% H_2SO_4 or acid salt-cake solutions and a little sulphide ore are warmed nearly to the boiling temperature. Bubbles of CO_2 attach themselves to the sulphides, travel to the surface of the solution, discharge into the air, and drop the sulphides into the pocket on the under side of the tube, as shown in the annexed sketch. In another test a 200-c.c. beaker is used with 100 c.c. of 3% H_2SO_4 and brought to nearly boiling temperature. The ore when introduced into this yields a froth composed of sulphides supported by bubbles of CO_2 . In case the ore is deficient in carbonate, an addition of as much as 3% of calcite or siderite is made. The froth is skimmed with a spoon as soon as it forms. We have noticed that a great deal of mineral is often lifted partly but never reaches the surface. Consequently extractions

¹*Mining and Scientific Press*, Vol. XCVI, page 414 (1908).

²H. E. Wood. *Trans. A. I. M. E.*, Vol. XLIV, pp. 684-701 (1912).

³T. J. Hoover. 'Concentrating Ores by Flotation,' 1st edition, page 77.

are low, although the grade of concentrate obtained is often very good. For practical purposes, however, the test is not of much value. A better test-machine is the small unit shown in Fig. 57. The acid should be allowed to run down through a section of garden-hose to within an inch of the surface of the ore and the ore should

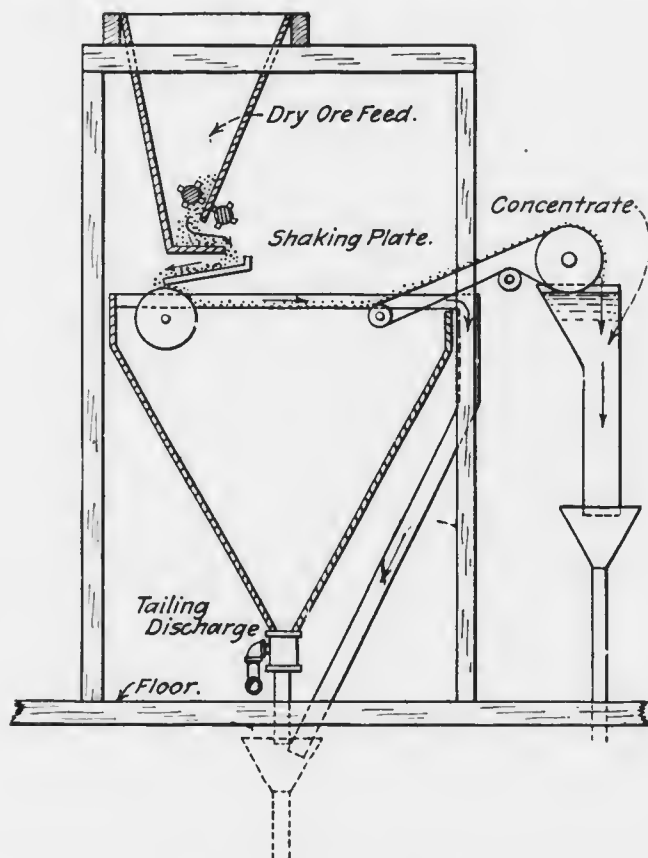

FIG. 55. THE WOOD MACHINE.

be kept stirred with a wooden paddle so that the bubbles of CO_2 generated by the action of the acid can lift the sulphides out of the body of the pulp. The froth formed should be skimmed with the paddle as fast as made, then filtered, dried, weighed, and analyzed. Not many ores yield gracefully to this treatment and slimes give poor extractions. Fines and Wilfley-table middlings are better

adapted, and the presence of siderite in the pulp is desirable, as it reacts slowly with dilute acid. From 1 to 3% H_2SO_4 is best in testing and $\frac{1}{2}$ to $1\frac{1}{2}$ % solutions on the large scale will give about the same results. The temperature of the pulp should be maintained at $70^\circ C.$ by use of a steam jet. Five to ten pounds of ore per test is necessary. The extractions obtained are always lower than in full-sized units. While oil is not necessary in this process, it will greatly assist in the flotation, and the addition of a small amount is often of much assistance in test-work.

MECHANICAL FROTHING as developed by the Minerals Separation company in England and Australia, and modified by many others, has been one of the most important methods of flotation. Therefore

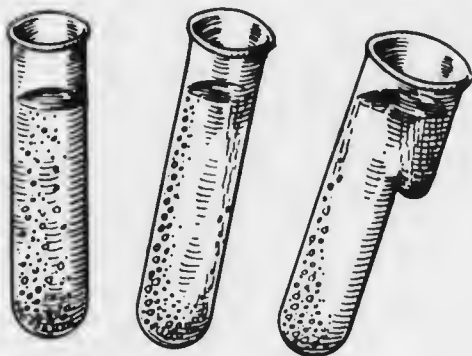

FIG. 56. TEST-TUBES FOR FLOTATION.

the laboratory machinery that has been developed is at as high a state of perfection as any such machinery now in use.

The Janney machine is probably the best designed machine for getting reliable quantitative results on a small quantity of ore. Photographs and sketches are appended (Fig. 58, 59, and 60). It can be seen that the agitation compartment is cylindrical in shape and that its top is surrounded by a froth-box, which slopes into a spitzkasten, where the froth can be skimmed. The tailing sinks to a return-hole at the bottom, passing into the agitation-compartment again. To provide good agitation, four vertical baffles are attached to the wall of the agitation-compartment, against which the pulp is swirled by the two impellers. Lining the walls with expanded metal lathing or with a coarse-mesh iron screen adds to the thorough mixing that the pulp must receive. The two impellers are on a common

shafting, which enters the machine through a stuffing-box in the bottom of the machine. The lower impeller with four vertical vanes is submerged; it agitates and emulsifies the pulp while the upper impeller, likewise with four vertical vanes, acts as a pump to lift the pulp and beat air into it. A pulley and belt connects the shafting with a variable-speed motor.

A dome-shaped lid is used on the machine. A small hole in the top of the dome allows the introduction of oil, acid, water, or other materials without the removal of the lid. The lid is so constructed that it can be turned upside-down with the dome

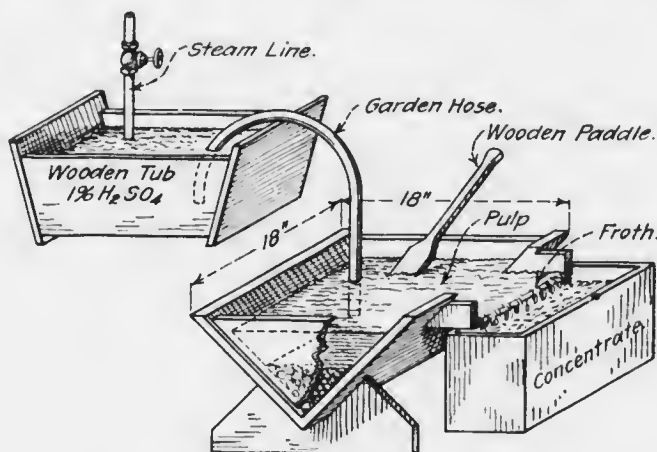

FIG. 57. A POTTER-DELPRAT TEST.

extending down into the froth-box, and in this position it can act as a funnel. The dome rests then on the top of the agitation-compartment and no froth can escape into the froth-box. This allows a period of agitation of the pulp before the cone-top is turned right-side up to allow aerated pulp to overflow into the froth-box and down into the spitzkasten, where the froth can be removed.

A discharge-plug at the bottom of the machine allows the flushing out of tailing after the test has been completed. So careful has been the design of this test-machine that even this discharge-plug is beveled to fit flush with the bottom of the machine and thus afford no dead space in which the solids might settle.

The spitzkasten is long and narrow, in order to permit a deep froth to be formed and to travel over as long a space as possible, before reaching the discharge. This tends to allow more of the

entrained gangue to settle out of the mineral froth. The sides of the spitzkasten are of heavy plate-glass, each fastened to a metal frame by means of screws. The wrought-iron shaft projects through a brass stuffing-box and is supported by a ball-bearing beneath. All the other metal parts are of cast aluminum.

The small variable-speed motor may be of either D. C. or A. C.



FIG. 58. THE JANNEY MACHINE. COVER INVERTED.

type. F. G. Janney recommends the use of a General Electric shunt-wound, direct-current motor, for 250 volts, with a rated speed of 1700 r.p.m. and $\frac{1}{4}$ hp. The impeller-shaft is to be driven at 1900 r.p.m. maximum speed. For speed-control he recommends a General

Electric direct-current field-rheostat, with an ampere capacity of 1.25 to 0.063 at 250 volts.

In our own laboratory it was desirable to use the ordinary city-lighting circuit of 110 volts, A. C. On that account we have found

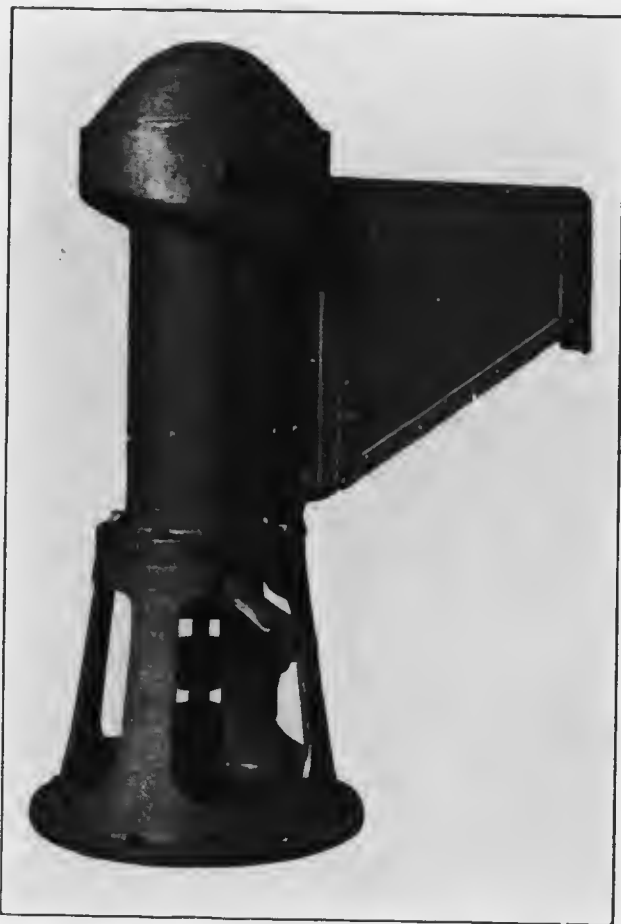

FIG. 59. THE JANNEY MACHINE. COVER UPRIGHT.

the following motor satisfactory: $\frac{1}{4}$ -hp. General Electric repulsion induction motor, single-phase, 60-cycle, with full speed of 1780 and carrying 4.2 amperes at 110 volts, or 2.1 amperes at 220 volts, depending upon the voltage of the current supplied to the machine, either voltage being acceptable. Speed-control is obtained by the

use of an ordinary field-rheostat in series with the motor. Such a motor has a speed varying with the load and with the voltage applied. As the load is practically a constant, the speed will depend upon the amount of resistance in series with the motor. As the majority of laboratories find a city alternating current more convenient to obtain, such a motor is recommended.

The operation of the machine is as follows: It is set up on a bench convenient to the sink and to running water. The motor is

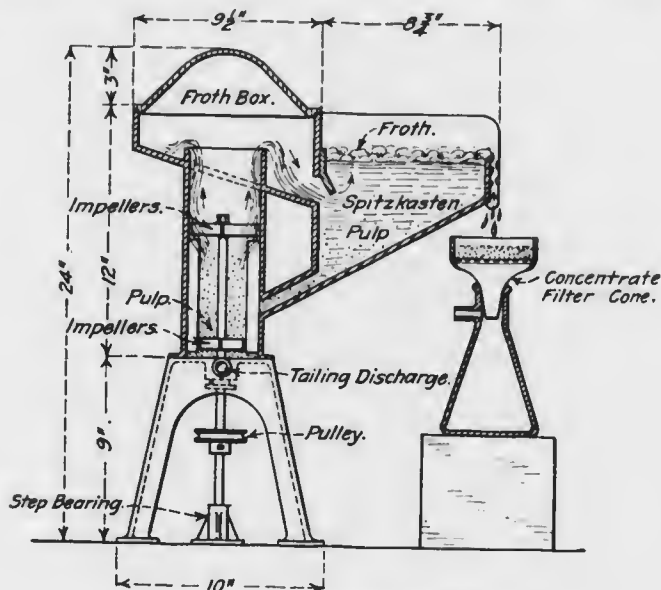

FIG. 60. THE JANNEY TEST MACHINE.

set up one foot to the rear with the switch and rheostat placed so that they can be easily reached while standing in front of the machine. A $\frac{1}{4}$ -in. round-leather sewing-machine belt is used for drive. The bearings are well oiled, the stuffing-box is properly packed, and some attention should be given to it occasionally in order to see that it is kept screwed tight enough to avoid leakage.

Enough clear water is run into the machine to barely show in the spitzkasten and the motor is started at its lowest speed. A 500-gm. charge of ore ground to at least 48-mesh is added and the cover placed on the machine in its inverted position. (See Fig. 58.) This is done to allow thorough mixing without circulation of the pulp. All or part of the oil and other reagents are now added

and the motor brought up to full speed for 30 seconds. The speed is again lowered to the minimum and the cover is turned over into its upright position. (See Fig. 59.) The speed is then raised and water is added through the hole in the top of the lid until the froth in the spitzkasten is nearly at the overflow lip. The ultimate speed of the agitator will depend somewhat upon the character of this froth, as some oils will give a deep persistent froth, while other froths are thin and brittle and allow of more water being added to the machine, as well as more violent agitation in order to beat more air into the pulp. The froth may either be allowed to flow out of the spitzkasten of its own weight or skimmed with a small wooden paddle. It is a good idea to wet the glass sides of the 'spitz' with water while the froth is rising, so that none of the froth will stick to the glass.

The duration of the test is about five minutes with an ore that floats easily, while other ores will require a considerably longer time to allow the entrained gangue to settle out of the froth before it is discharged from the machine. In such cases it is best to hold back the froth until its appearance shows it to be fairly clean. Beginners are likely to dilute their froth with too much gangue. In a large-sized machine the froth can travel over from four to eight feet of spitzkasten before it is discharged, while in this test-machine it only has a travel of about 10 inches. Consequently, the small machine is liable to yield concentrate of too low a tenor. The same applies to most other machines for making tests on flotation.

The concentrate may be caught in a pan or on a filter. After the test the machine is brought back to low speed and the tailing-ping removed, so that the tailing can be caught in a pan or bucket, or run to waste.

If it is so desired, this rough concentrate can be put back into the machine and treated in the same way as the original sample, or the concentrates from several tests combined to give enough material for re-treatment. If this is done three products are made, namely,

A 'rougher' tailing, to waste.

A clean concentrate, for shipment.

A 'cleaner' tailing or middling, which in actual practice is returned to the head machine.

When these conditions are observed results only slightly lower than those possible with a big machine can be obtained. A test can be run in from 5 to 30 minutes in such a machine with 500 grams of ore in anything from a 3:1 to a 5:1 pulp. The glass sides of

the spitzkasten allow close observation of the condition of the froth, and this is a great advantage to the beginner. The small amount of ore necessary for a test is a matter of considerable convenience as fine grinding of the ore in the laboratory is often irksome. The aluminum casting is little corroded by either acid or alkaline electrolytes. The return of pulp from the 'spitz' to the agitating-

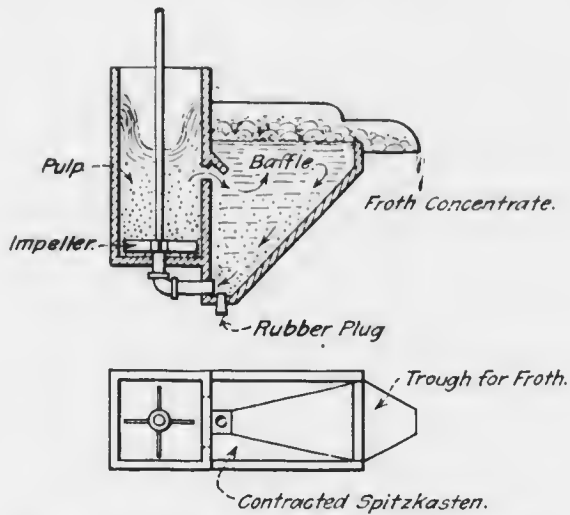

FIG. 61. SKETCH OF THE LYSTER OR HOOVER MACHINE.

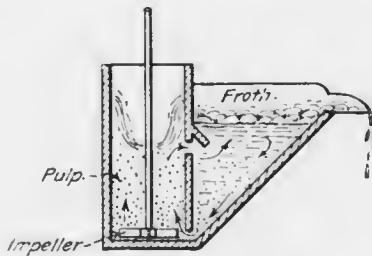

FIG. 62. ANOTHER FORM OF HOOVER MACHINE.

compartment allows the material to be treated until all mineral has been removed without stopping the machine, so that a single treatment yields a clean tailing. However, a second treatment of this 'rougher-froth' is sometimes necessary in order to get a high-grade concentrate. Clean tailings generally mean only medium-grade

concentrates due to entrainment of gangue, in the removal of all the mineral.

The stuffing-box in the bottom will probably leak if not watched. However, this driving of the impellers from below, instead of from



FIG. 63. THE HOOVER MACHINE.

above, leaves the top of the machine free for the operator and is more convenient in every way. This is of importance in a laboratory-machine, and will excuse the use of a stuffing-box. In large-scale machines a stuffing-box underneath would not be tolerated, and the

drive should be from above. We would also suggest a sheet-lead construction as being more easily built. A $\frac{1}{4}$ -inch sheet-lead is sufficiently rigid to stand up well, while it is ductile enough to be

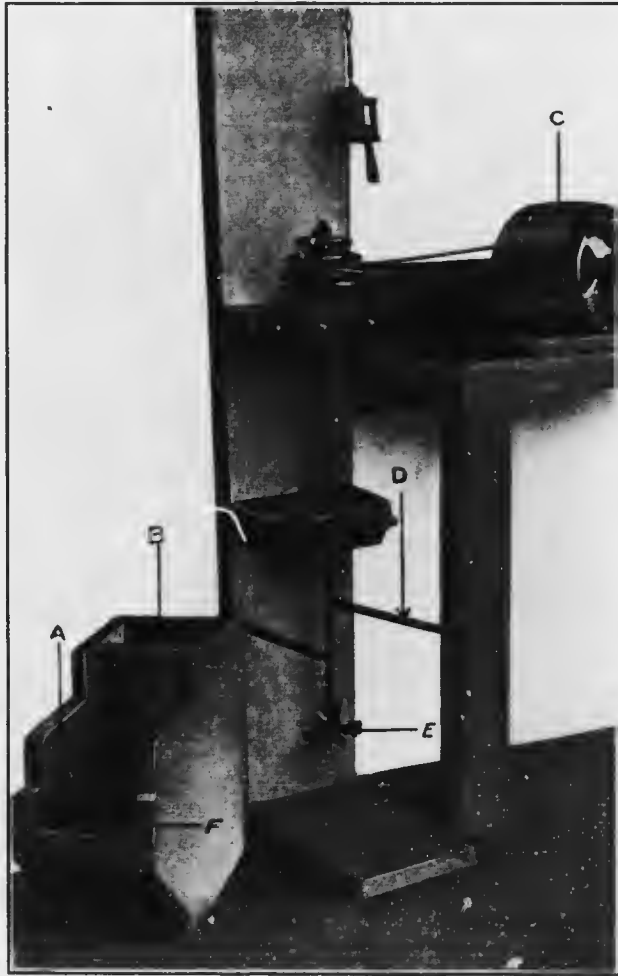

FIG. 64. THE HOOVER MACHINE, SHOWING STIRRER.

- A. Spitzkasten.
- B. Agitation compartment.
- C. Variable-speed motor.
- D. Retaining bolts.
- E. Impeller.
- F. Concentrate discharge.

worked readily into the desired shape. The joints are easily burned, and it is acid-proof.

THE HOOVER MACHINE, so-called, was designed after a test-machine described in the second edition of Hoover's book, being copied from one of Lyster's patents, and has been much copied by people wishing to make flotation tests. An improvement over this construction was published by Ralph Smith⁴ recently (see Fig. 61), and a modified sketch of the same is shown in Fig. 62, while photographs of the machine used for a while in our laboratory are shown in Fig. 63 and 64. Either a variable-speed motor is belted to the pulley that drives the stirring mechanism, or a pair of conepulleys on a constant-speed motor is used. This construction has been popular because it can be made of wood, at small expense. The Janney machine will cost about \$100, while the Hoover machine can be built for a small fraction of that amount. Mr. Hoover's original drawing does not show the spitzkasten drawn to a point, as only the front side was beveled. Our sketch shows both sides beveled. This is desirable, as it eliminates space in which fine sand can settle, and tends to minimize the amount of pulp lying inactive in the spitzkasten. In the agitation-compartment the pulp is swirled into the corners, where it is well mixed with air; hence the baffles sketched in the Janney machine are unnecessary. One objection, however, is that unless the agitation-compartment is very tall the pulp being swirled into the corners has a tendency to splash out, and a lid similar to the one on the Janney machine is desirable. However, it is difficult to attach one because the stirrer-shafting is in the way. The operation of this machine is practically the same as that of the Janney, except that without glass sides on the spitzkasten it is hard to get as clean a froth. A charge of 1000 to 2000 grams is necessary in this machine.

THE SLIDE MACHINE, as shown in Fig. 65 and 66, was designed by Hoover and perfected by many others. In recent practice it is motor-driven. A number of these machines were given by James M. Hyde to various universities in this country. Many people favor this apparatus for the reason that they have had little opportunity to use any other design. In this machine the agitator is driven from below through a stuffing-box, as in the Janney, with the consequent freedom of the top of the machine for the convenience of the operator. The top half of the machine is so constructed that it can be slid to one side, cutting off the froth formed in the agitation

⁴*E. & M. J.*, Vol. C, page 395 (1915).

from the gangue, which is allowed to settle. The operation consists in agitating with oil and other reagents, then a period of quiet during which the froth collects at the top while the gangue sinks. Two windows in the side enable the observer to see when the gangue has subsided sufficiently to allow the top half to be slid along the rubber gasket, cutting off the froth from the remainder of the pulp. The time necessary for the settling of the gangue is sufficient for much of the gangue to separate from the froth, leaving only clean sulphides in the froth. This element of the machine has made it of some value in testing flotation oils, but in a weak froth

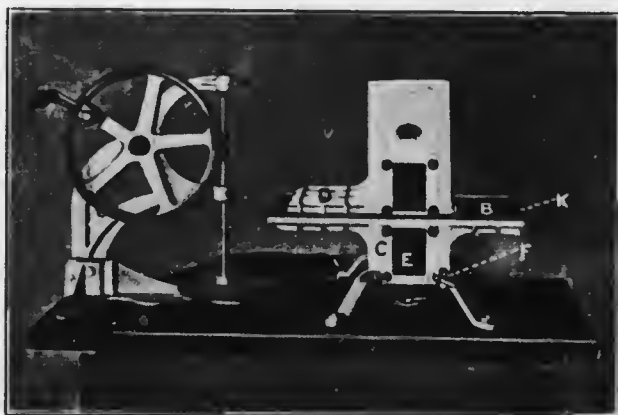

FIG. 65. THE SLIDE MACHINE.

much of the sulphide mineral also settles out and is lost, so that the test results with this machine often show unnecessarily low extractions and a high grade of concentrate. On the other hand, when conditions are adjusted to give a froth persistent enough to hold all the sulphide mineral, considerable gangue is entrained in the stiff froth. Further, after skimming one froth we find it necessary to add more water and start the machine again to make more froth. It is hard to make the slide machine give a high extraction with only one agitation. The intermittent character of such work and the time necessary to wait while settling are disadvantages that make the Janney or the Hoover machines of greater utility, in our opinion. The parts are of cast aluminum with a rubber gasket between. A charge of 500 to 1000 grams of ore is used.

As regards the fineness of crushing in laboratory work, material ground as fine as 200-mesh will yield high extractions with much

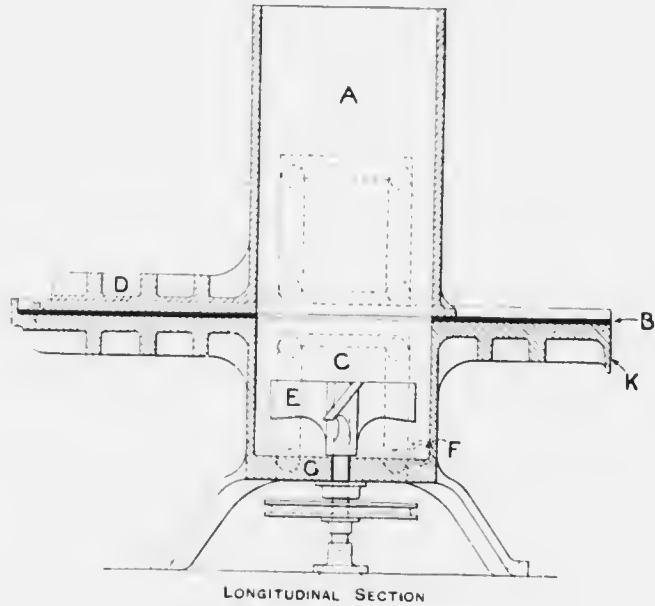

FIG. 66. THE SLIDE MACHINE.

- A. Upper part of cell.
- C. Lower part.
- B. Rubber cushion.
- D. Tail to prevent leakage of froth.
- E. Agitator.
- F. Hole for withdrawal of tailing.

greater ease than coarser material. It is possible to get acceptable work in some cases with material as coarse as 40-mesh on condition that there is a considerable portion of the same material in the slime. For ordinary laboratory work a convenient size is 80-mesh, unless poor extractions are obtained.

[The General Engineering Co. at Salt Lake City and the Mine & Smelter Supply Co., at Denver, sell flotation machines. So does the Denver Fire Clay Co., which makes a modified Hoover machine. The Joshua Hendy Iron Works, San Francisco, makes machines for the Minerals Separation company.—EDITOR.]

TESTING ORES FOR THE FLOTATION PROCESS—II

By O. C. RALSTON and GLENN L. ALLEN

(From the *Mining and Scientific Press* of January 8, 1916)

SEPARATORY FUNNELS. During the past year an article on practice in Mexico² mentioned the fact that much of the preliminary testing on the ore was done in separatory funnels, in which the charges of pulp, oil, etc., were shaken, after which the cock at the bottom of

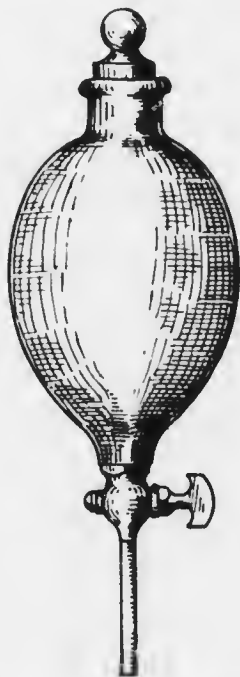

FIG. 67. SEPARATING FUNNEL.

the funnel was opened and the tailing run into a second separatory funnel for further flotation tests, the cock being closed in time to catch the froth. The versatility of experiment permissible with the use of such apparatus (Fig. 67) is commendable. Obviously, this arrangement is open to the same objections as is the slide

²*M. & S. P.*, Vol. CXI, page 122 (July 24, 1915).

machine except that separatory funnels are simple and inexpensive.

ELMORE MACHINE. As far as we know, no small test-machine for the Elmore process has come into common use on account of the fact that the pulp must be lifted through a tube corresponding in length to the column of water equivalent to barometric pressure. This makes an awkward laboratory machine. Mr. Hoover (2nd edition, page 98), describes "illustrative" experiments with the pulp in a bottle connected with a water-pump for producing a vacuum, but no quantitative method of this kind has been developed.

Other miscellaneous frothing tests are in the literature but most of them are merely "illustrative." Putting a charge into a soda-water siphon, pumping in air to dissolve the water, and then releasing the charge into a beaker gives nice-looking froth. In some of the lawsuits square glass candy jars (Fig. 68) with a motor-driven impeller have been used to show flotation phenomena in court. In a recent U. S. Patent (No. 1,155,836) taken out by T. M. Owen, one of the engineers of the Minerals Separation company, is a sketch of a simple test-machine made of an ordinary 2½-litre acid-bottle. (See Fig. 69.) This corresponds to the sub-aeration type of machine and is recommended by Mr. Owen for test-work when such a type of machine seems necessary, as in differential flotation. Air is led into the pulp through the stopper in the bottom and beaten into the pulp by the impeller. The four large baffles above the impeller prevent the swirling of the pulp from rising through them, so that there is a quiet zone in the top of the machine where the froth can collect. One great beauty of such a machine is that any froth formed will rise immediately to the discharge. However, we believe that the Jauney and Hoover machines are the most useful of the mechanically-agitated type.

PNEUMATIC FLOTATION. Among the different pneumatic machines, as far as we are acquainted, the Callow test-machine is the only one of laboratory size that has been much developed. It is merely the commercial Callow machine reduced in size (see Fig. 70, 71, and 72). Later development in the laboratory of the General Engineering Co., in Salt Lake City, has resulted in the reproduction of the whole plant in miniature (as shown in Fig. 72), with a Pacluea mixer, a roughing-cell, cleaning-cell, vacuum-filter, and sand-pump to return middling to the Pacluea mixer. As seen in the drawing, the pulp is mixed well in a Pacluea tank of small size, overflowing into the rougher flotation-cell. The tailing from this rougher goes to a sand-pump and is returned to the Pacluea. The froth is treated in a

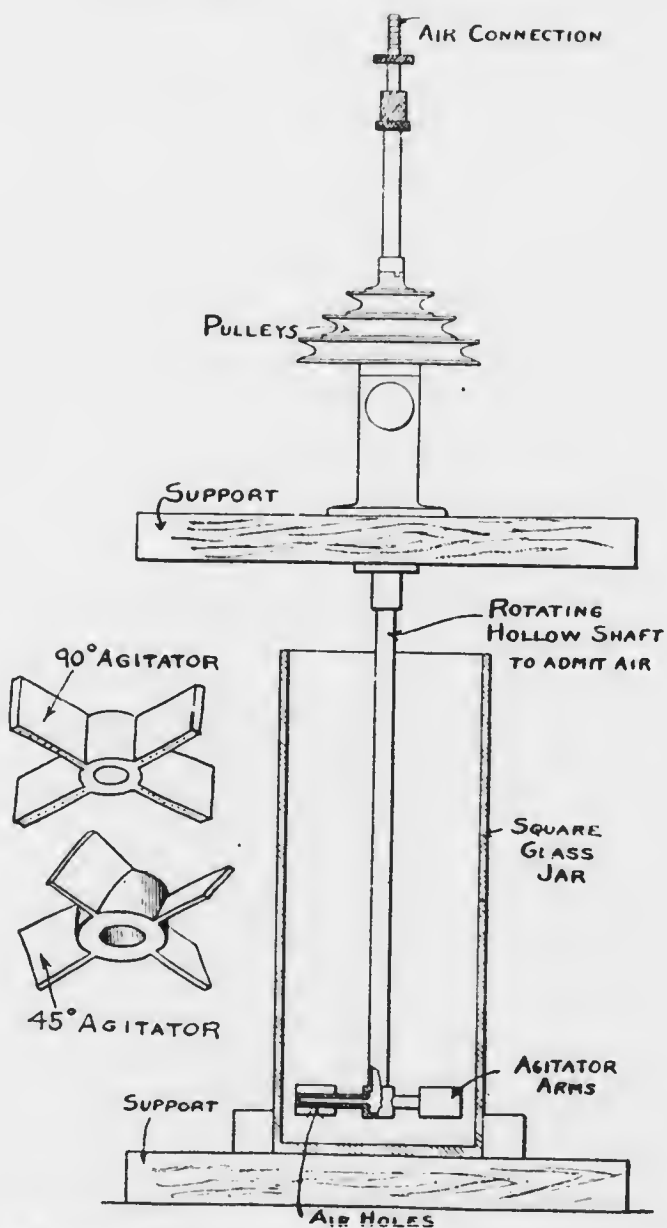

FIG. 68. THE SQUARE GLASS JAR MACHINE FOR MAKING FLOTATION TESTS.

second and smaller pneumatic-flotation unit, giving a concentrate that overflows into an ordinary laboratory vacuum-filter actuated by a water or aspirating pump. The tailing from the 'cleaner-cell' consists of a middling that likewise flows to the sand-pump and back to the Pachuca.

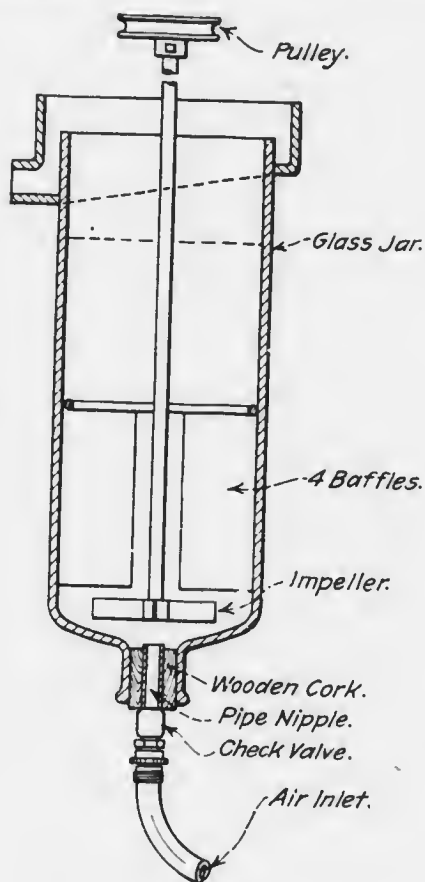

FIG. 69. OWEN TEST-MACHINE.

A novice will have no small difficulty in operating such an installation, as there are a number of things to be kept in operation at the same time. The mixture of ore, water, oil, and any other reagents is fed either into the suction of the sand-pump or into the top of the Pachuca after air has been started into the various machines. The overflow from the Pachuca into the rougher-cell accumulates

until a nice froth is coming up and nearly overflowing. Then the tailing-discharge valve on the rougher is gradually opened and froth allowed to overflow from the cell into the 'cleaner'-cell. It is best to get most of the charge circulating before much concentrate-froth

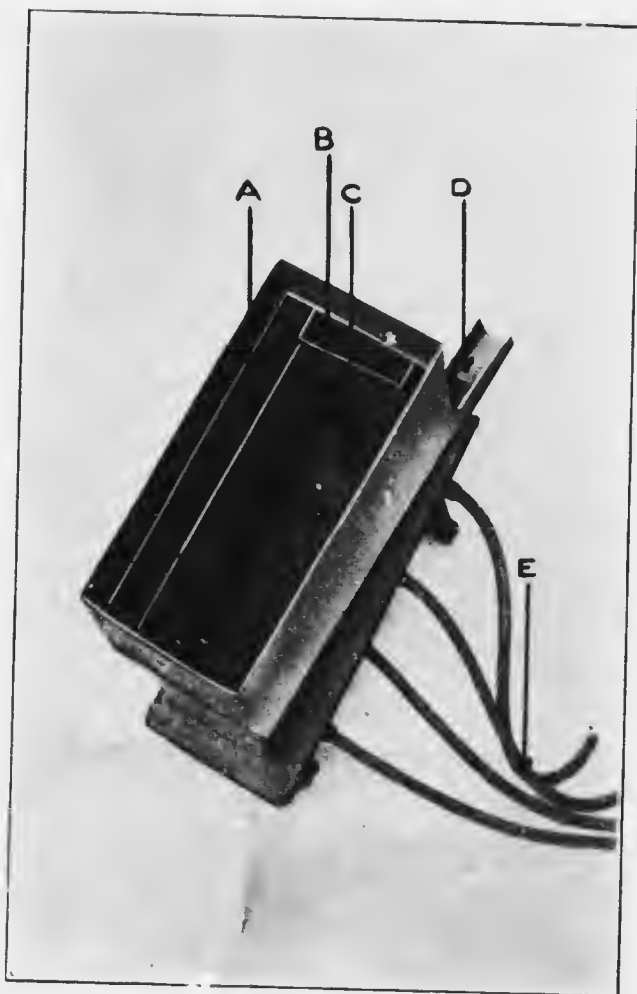

FIG. 70. THE CALLOW CELL. (EARLY FORM).

- A. Froth-overflow launders.
- B. Pulp-feed to air-blankets.
- C. Air-atomizing blanket.
- D. Concentrate discharge.
- E. Compressed-air feed to wind-boxes.

is allowed to overflow, the overflow of froth being controlled by the main air-valves leading to each unit. After the valves into the individual wind-boxes beneath the machine have been once adjusted they should never be disturbed, and all control of air supplied should be at the valves in the main pipes. When everything is going well, the air-pressure in the cleaner can be increased until concentrate-froth is overflowing into the vacuum-filter. A wooden paddle to stir any settled material in the flotation cells is of value, as well as a small jet of water from a rubber hose for washing concentrate along the froth-launders and for beating down froth when occasional too-violent rushes of froth from the cells take place. After a test is complete the pulp should be drained completely from all parts of the machine while the air is still blowing, so that

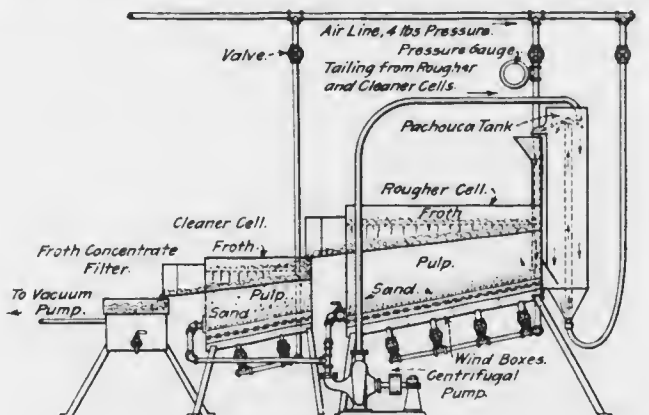

FIG. 71. CALLOW TEST SET.

solids will not settle in passages or clog the canvas blanket in the cells. Only practice will allow anyone to get reliable results with this machine. A watch-glass for catching and panning occasional samples of froth is another necessary auxiliary to this equipment. The cost of installing such a set of apparatus is from \$100 to \$150. At least 1000 grams of ore is required for a test and about 30 minutes to 1 hour is spent. It can be seen that nothing but a finished concentrate and a tailing are obtained or a middling product may be left in the cleaner cell. This middling may be assayed as such and calculated into the concentrate and tailing or its sulphides may be panned out and added to the concentrate. The machine is said to give results closely paralleling those obtained with larger-scale apparatus. A

source of supply of compressed air at 3 to 5 lb. per sq. in. is necessary and the main valves on the air-pipe leading to each machine should be some type of needle-valve in order to ensure exact control.

In testing practice, the air-lift type of middling-return has been found more satisfactory than the centrifugal pump shown in Fig. 71.

LABORATORY MANIPULATIONS. Turning from the description of the machines used to the operations on the ore before and after the



FIG. 72. CALLOW TEST-MACHINE WITH PACHUCA MIXER.

- A. Pachuca mixer.
- B. Pulp-feed to air-blanket.
- C. Needle-valve air-control.
- D. Blanket-clamps for quickly removing blanket for cleaning.
- E. Wind-boxes.

flotation operation, we have in general the problems of crushing the ore and of drying the froth-concentrate.

As a rule laboratory machinery for the pulverization of ore is of the dry-grinding type, with the exception of small ball-mills that can crush from 1 to 100 lb. charges in the wet. Consequently, most

people start with weighed charges of finely-ground dry ore, a known quantity of water, of oil, and of acid or alkali. Our experience has been that most dry-ground ore must be treated in an acidified pulp to get good flotation. Doubtless the surfaces of sulphide particles become somewhat oxidized in, or shortly after, dry grinding and the function of the acid would be to clean the slightly oxidized surfaces. Wet grinding usually does not call for so much acid. In nearly all laboratory work finer grinding than is used in practice seems to be necessary. This may possibly be due to the smaller amounts of froth that are formed. Such small quantities of froth cannot form layers as deep as those made in the large machines. If a big particle of sulphide can be entrained with a number of smaller particles, it can be floated, but with a thin froth the chance of such entrainment would seem to be less. Some experimenters have informed us that they were able to float even as large as 30-mesh material, but our own experience is that 60-mesh material is often hard to float with any chance of getting a high extraction, while the operation is performed with much more ease and expedition when the ore is crushed somewhat finer.

Wet grinding is more desirable, as it parallels conditions in practice, where most of the finer grinding of ore is in Chilean, tube, and other mills. However, wet grinding is harder to manipulate in a small laboratory and requires more time. The dry weight of the feed to the flotation machine must be known; hence a weighed charge of dry ore crushed to about 10-mesh can be introduced into a porcelain or iron pebble-mill for grinding and ground for the length of time found necessary to reduce the pulp to sufficient fineness—15 minutes to 24 hours. The charge can then be poured and washed through a coarse screen (to retain the pebbles) into a bucket and thence into the flotation machine. The oxidation of sulphide surfaces is thus avoided, but separate grinding of each charge, in order to know its exact weight, is rather tedious and requires a number of small mills if many tests are being run, on account of slow speed in grinding. A mill with iron balls rather than pebbles is of greater service. It is possible to introduce the flotation-oil before grinding, to be sure that it will be thoroughly mixed. For thick viscous oils this is highly beneficial, as a ball-mill gives about the best conditions for agitation and mixing. Usually 1 to 2 lb. charges are used and a small laboratory mill of the Abbe type serves well, although a good mill can be made with a 10-in. length of 8-in. iron pipe and two heavy iron caps for the same.

Practice in our laboratory has been standardized to a miniature gyratory crushing to 10-mesh, splitting into weighed samples kept in paper bags and reduced to smaller size by either wet or dry grinding as occasion demands.

A short-stemmed tin funnel about 6 inches in diameter with a one-inch opening is found to be about the most convenient means of pouring a charge of ore into a laboratory flotation-machine.

The measuring and testing of flotation-oils in the laboratory has been very inexact in many instances witnessed by us. It is common practice to count the number of drops of oil falling from a small piece of glass tubing. We are using a Mohr pipette of 1 c.c. total capacity for measurement of the amount of oil used in each test. Such a pipette is shown in full size in Fig. 73. It will be seen that this pipette allows measurements of the oil to the nearest 0.01 c.c., which is as close as will ever be desired. If the density of the oil is known, the volume as measured by this method is quickly converted into the weight of oil used.

The testing of oil samples for flotative power is a matter that needs standardizing. It is desirable to classify oils according to flotative power, but just how to do this is not exactly clear. A unit of 'flotativeness' might be established and each oil referred to that unit in terms of percentage. But it has to be remembered that the best oil for one ore may not prove to be the best oil for another, although two such series of oils might roughly parallel each other. For any given ore, it would be permissible to make such a measurement on a series of oils and group them according to some definite standard. A standard oil might be chosen and the value of a second oil expressed in percentages of the flotative power of the first as determined by using equal quantities of the two oils in tests on an ore under identical conditions. This test could not be fair for the reason that different amounts of two different oils are necessary to accomplish the same results. Further, the conditions of acidity or alkalinity might favor one oil and handicap another. If we measured the amount of oil necessary to give a fixed percentage of extraction the first of the above objections would be satisfied, but conditions of acidity or alkalinity could make the test unfair for some oils. Hence the dilemma as to a standardized test of a flotation-oil.



FIG. 73.
MOHR'S
PIPETTE.

No single test could definitely place an oil in any scheme of classification and nothing can be done but run a series of tests using varying amounts of the oil to be tested and with varying acidity or alkalinity. The temperature of the pulp must be kept constant although it has a minor effect.

Coutts gives about the only directions on oil testing that are to be found in the literature of the subject⁶. He states rightly that the first thing to do with an oil is to measure its density, for future calculations, as it will be measured by volume in the laboratory and must later be reduced to weights. He recommends the use of a burette for measuring the oil, but we favor the Mohr pipette mentioned above. He chooses a standard ore on which all tests are to be run and classifies three different kinds of standard tests: (1) for mixed sulphides, (2) differential separation, and (3) flotation of copper and iron sulphides. He states that oils high in phlanderene have proved best for differential separation of zinc-lead sulphide ores. While this is helpful, he does not state just how the oils are to be classified after the tests have been made.

Much work with oils is needed in order to determine if there are any definite constituents in oils that give them flotation power. Research is also needed in the preparation of oils from the wood, coal, and mineral oils in such a manner that they will have maximum efficiency in flotation. Work on this subject has been initiated in our own laboratory and it is known that several of the larger companies have employed oil chemists to look into such problems. We understand that most excellent work is being done on methods of modifying and reconstructing oils that can be had cheaply. By this we mean more than mere mixing of a good flotation oil with a cheaper non-selective oil. Sulphonating the oils, dissolving them in acids, dissolving modifying substances in the oils, etc., are some of the ideas being tested with varying success. It is on account of all this oil testing that considerable progress has been made in flotation during the past year, so that now most of the larger companies are using cheaper oils than a year ago.

When starting to work with a new ore, there is needed a rapid qualitative method of choosing an oil that seems well adapted to the flotation of the ore in question. Such a scheme is in use in the laboratory of the General Engineering Company at Salt Lake City. Their qualitative tester is designed to test oils for use in the Callow pneumatic flotation cell and consists of a glass tube of about

⁶J. Coutts. *E. & M. J.*, Vol. XCIX, page 1079 (1915).

two inches diameter and two feet long. (Fig. 74.) This can be set on end and closed at the bottom with a one-hole rubber stopper through which passes a glass tube into a small canvas bag. The small bubbles of air coming through the canvas are similar to those used in large-scale machines and can be observed through the glass walls of the tube. With some pulp in the tube, oils, acids, salts, etc., may be added in very short tests until the proper appearance is obtained. An overflow lip is provided in case it is desired to examine the mineral in the froth. A slight adjustment of the air will provide an ample overflow of froth.

DISPOSAL OF THE FROTH. The handling of the flotation froth in the laboratory finds difficulties which are reflected in practice.

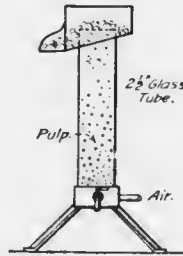

FIG. 74. QUALITATIVE OIL TESTER.

It is often very slow to settle and filters with difficulty. A vacuum-filter, connected with a laboratory aspirating pump, is a very convenient method of getting the concentrate out of the froth. A large porcelain Buechner funnel fitted into a filtering flask, as shown in Fig. 60, is used at present in our laboratory. A copper vacuum-filter of much the same type, provided with a porous false bottom of acid-proof wire cloth, resting on a punched plate, is shown in Fig. 71 of the Callow test set. Filter-papers can be laid over the bottom of either of these funnels to collect the concentrates, and the vacuum beneath sucks out the water and oil of the froth. Such a filter can be placed under the froth-discharge of a flotation machine so that a fairly dry cake of concentrate is ready for further drying at the end of the flotation test. By loosening the outer rim of the filter-paper and then turning the funnel upside down over a pan, the filter-paper with the concentrate can be dropped into the drying-pan by gently blowing into the stem of the funnel. This is set aside in a warm place to dry and later weighed against a filter-paper tare.

If it is desired, the froth can be collected in a glass beaker or

other vessel and allowed to stand over-night. A layer of clear water can then be siphoned off and the thick pulp remaining filtered or dried direct. In some laboratories the froth is dumped onto a shallow pan on a hot plate and the water evaporated. Occasionally such a sample of froth will be left too long, and will be ignited and roasted. We once used a numbered set of shallow pans for such evaporations but prefer filtering before drying the precipitate. A numbered tag is now put in each pan along with the cake.

The products coming from the flotation machine should be watched closely and occasionally panned or examined with the microscope to see what kind of work is being done. This is fairly easy to determine as the sulphides are more of them distinguished easily from the gangue under the microscope, and likewise gangue particles in the froth-concentrate can often be distinguished. A microscope is a most useful adjunct in a flotation laboratory or mill.

GENERAL CONSIDERATIONS. We have mentioned at various places the relation of the laboratory tests to the large-scale operations and now repeat that in almost every instance the laboratory results are somewhat pessimistic as compared to large-scale work. The reasons are made apparent by the smallness of the machine and the shallower layer of froth often formed under these conditions. Moreover, laboratory operations seem to call for greater amounts of oil, acid, etc., than do the large-scale operations.

Only one of the above machines is adapted to 'roughing' and 'cleaning' operations in a single test. Present-day practice tends toward re-treatment of at least part of the froth in order to make cleaner and higher-grade concentrates. Consequently, it may be desirable to collect enough froth from a series of tests to be re-treated in a 'cleaning' test. Of course, this is provided for in the Callow test set, where only 'cleaned' concentrate is discharged from the machine. It is further found desirable to weigh and analyze some of the successive fractions of the froth being discharged from a flotation machine, as the tailing becomes leaner, and determine at what point it may be desirable to re-treat such froth.

Many reports of flotation test-work with mechanical-agitation machines give the speed of the rotation of the agitating-blades. We have found that it was possible to get much the same work done with quite a variation of speeds, the only effect being to lengthen or shorten the time of treatment. We feel that the importance of this matter has been much exaggerated. Some means of speed-control is necessary and the speed can be adjusted in each case until



FIG. 75. THE CASE MACHINE.

the froth presents the proper appearance as to depth, size of bubbles, color, etc. Speeding toward the end of a test in order to give a deeper froth with a faint line of concentrate on the very top is often

advisable. We recommend adjusting the speed in each test to suit the other conditions, rather than running a series of tests with different speeds. Only in the slide machine, where operation of the impeller must be suspended in order to allow froth to collect, is the speed of much importance. Here we recommend agitation for a definite length of time, and then a period of settling. The effect of variation of speed during a definite length of time may be a considerable variation in the amount of froth collected during the quiet period. Hence we are prejudiced against the use of the slide machine except for oil-testing.

When a good set of conditions has been found for the flotation treatment of an ore, it is best to recover the water from each test to see what effect a closed circuit of the mill-water will have. Some oil and chemicals are thus recovered, cutting down the amounts necessary for operation. In case a carboy or two of the water to be used in the large mill should be used to make certain that no deleterious contamination will ensue from this source. Under these conditions filtration of the concentrate and tailing for recovery of the water is necessary. Such conditions are provided for in the Callow apparatus, above described, and can be applied easily to any of the other machines.

Oil samples for test purposes can be obtained from the various wood-distilling companies now advertising in the technical press, from gas companies and from petroleum-refining companies.

In attacking refractory ores, there are a number of ingenious things that can be done to the pulp both in and out of the machine. The trouble may be due to deleterious substances, which sometimes can be washed out, rendered harmless by boiling, or by acidifying, or by making alkaline with lime before entering the machine. Occasionally, the ore will not work well under ordinary conditions but will yield beautifully after finer grinding. Sometimes extra reagents are necessary, such as powdered charcoal, modified oils, argol, soap, calcium sulphate, alum, etc. A rational method of devising the proper tests in such cases must be based on some theory of flotation. Colloid chemistry is a branch of knowledge that we believe to be very necessary for such work, as it has facilitated a more intelligent control of our tests and has given wonderful results in a number of instances.

Finally, it is well to be prodigal in the amount of analytical work connected with flotation testing in order to discover interesting differences in gangue-constituents carried into the concentrate, as

well as to find the best conditions for leaving out some gangue constituent that is less desirable than the rest. If an experimenter does his own analytical work he can be expected to spend three-fourths of his time analyzing what has been done during the other fourth.

Summarizing the most important points to be tested on a given ore with any given flotation machine, we have:

Method of grinding.

Fineness of grinding.

Kind of frothing agent used.

Amount of frothing agent.

Acidity or alkalinity.

Temperature.

Necessity of preliminary agitation.

Effect of addition-agents in flocculating gangue-slime.

It can be seen that there may be a certain best combination of the above variables that will be entirely missed if a great many tests are not carried out; hence the desirability of doing the testing in a small laboratory-machine where many trials can be made in a short time.

After the best conditions have seemingly been established, they should be further tried in a larger-sized machine before they are incorporated into the general practice of a mill. The test-work on this scale need hardly be described, as, for the most part, it is a question of translation of laboratory results into large-scale operation.

[We have added an illustration of the Case machine, evidently a modified Hoover apparatus, made by the Denver Fire Clay Co.—EDITOR.]

MOLECULAR FORCES IN FLOTATION

Surface Compression

By DUDLEY H. NORRIS

(From the *Mining and Scientific Press* of February 12, 1916)

At the meeting of the local membership of the American Institute of Mining Engineers on December 14 last the question was asked by one of the speakers: "Why does the greased needle float on the surface of a tumbler of water and the wetted needle sink?" Did one or another of the experts present rise and say that it was due to 'surface tension' and then in a few well chosen words explain just exactly what 'surface tension' is? Nothing of the sort happened. The question was not only not answered, but it was unanimously avoided. It is a fair question, however, and deserves an answer.

The fact is that 'surface tension' is a misnomer. Tension is a stretching, whereas the phenomena in question are those of compression. In 'surface tension,' a bubble of air or a drop of water is pictured to the imagination as being actually of the form that it would have if it were contained in a film like that of a soap-bubble or a toy-balloon. That grasped, the substance of the bubble or of the drop is ignored and we are asked to occupy our minds only with the imaginary film. The reasoning appears to be: "There might be such a film, there must be, there is. Otherwise, we are not able to explain it at all." In what follows, I shall attempt to explain the phenomena discussed in terms of molecular attraction and of heat.

If you will fill a tumbler with water or other liquid and then continue carefully to pour in more: instead of running over the side, there will be a heaping up of the liquid in the tumbler and a rounding of the surface, the centre of the liquid being as much as a sixteenth or even an eighth of an inch higher than the rim of the tumbler. That is the phenomenon of your 'surface tension' pure and undefiled. The same phenomenon is seen when mercury is contained in a glass vessel, even when the vessel is only partly filled. Mercury does not wet glass, and where the liquid metal meets the side of the glass vessel the mercury is convex. Where, however, the tumbler is only partly filled with water the surface of the water is concave where it meets the inside of the tumbler, and the glass is wetted by the water.

In the Miami flotation case it was stated that surface tension is a force existing in the surface of a liquid that tends to draw the liquid into the form of a sphere, this being

the most compact form that a given volume can assume and the form in which it presents the least surface. This is a lovely specimen of the logical fallacy known as *post hoc ergo propter hoc*. In surface tension, it was said in the Miami case, because the most compact form that a given volume can assume and the form in which it presents the least surface is a sphere, therefore the volume assumes that form and does so at the behest of surface tension; but as to the why and how, nothing was said, nor can they be imagined. It reads as if there had been a mass-meeting of the molecules looking to 'preparedness.' The molecule acting as chairman states the business before the assembled molecules: "Owing to the war in Europe and a hard winter coming on, the molecules must decide on some form that will be the most compact and which will present the least possible surface to an unsympathetic world. The sphere comes highly recommended. It is moved and seconded therefore that the molecules form a sphere. So ordered."

The calculus proposition that two homogeneous spheres attract each other as if their masses were collected at their centres of gravity is as true as anything human can be. It is also true that in a single homogeneous sphere, if acted on by no outside force, the cohesive attraction of its molecules for each other will act radially toward the centre and form a sphere; and it is this radial attraction and not an imaginary film or a non-existent tension, that causes the phenomenon, and it is probably some similar molecular attraction that causes mineral flotation.

In James Clerk Maxwell's article on capillary action, in the *Encyclopaedia Britannica* (11th edition), vol. 5, p. 258, he says: "Plateau, who made an elaborate study of the phenomena of surface tension, adopted the following method of getting rid of the effects of gravity. He formed a mixture of alcohol and water, of the same density as olive oil, and then introduced a quantity of oil into the mixture. It assumes the form of a sphere under the action of surface tension alone." That it assumes the form of a sphere is granted. That surface tension does it is denied.

The toy-balloon has a place in a rational explanation of the phenomena under discussion; but the alleged film around a drop of water or around a bubble of air, or as the top layer of a body of water, like the film of a toy-balloon, has no existence in nature. The vendor of toy-balloons has each one of his gayly colored stock fastened by a string, which serves the double purpose of keeping the gas in the balloons and of keeping the balloons themselves down to earth. The

free ends of the strings are brought to a common knot. There is a pull on each string along the hypotenuse of a right-angle triangle; this can be resolved into a vertical component, tending to make the balloon float off, and a horizontal component, tending to crowd the balloons together.

The same thing happens in surface compression. The water in the tumbler is subject to the cohesive attraction of its molecules, to the attraction of gravitation, and to heat. The water, if free from the attraction of gravitation, would tend to form a sphere, but gravitation causes it to conform to the shape of the containing vessel. Heat, by tending to drive the molecules apart, acts counter to the attraction of cohesion and their equilibrium fixes the specific gravity of the water, its bulk, and its state of aggregation—making it solid, liquid, or gaseous as the case may be. If gravitation be neutralized or be not opposed, the water takes a spherical form under the influence of cohesion, as is shown in raindrops, in Plateau's experiment, and in drops of water on a hot stove, in conformity with the rule of homogeneous spheres.

Let us suppose each molecule of water in the tumbler to be free from the attraction of gravitation and in the form of a sphere, then the vertical section of the surface layer would look like this:

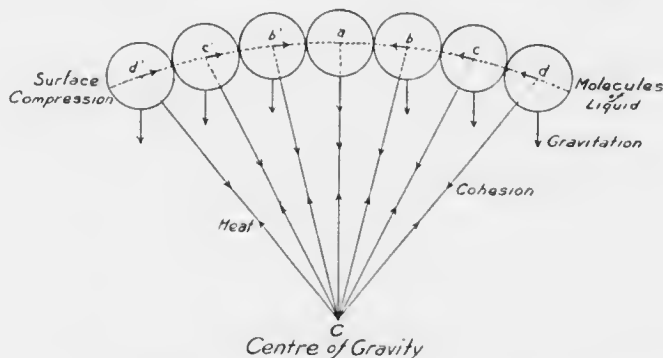

FIG. 76. FORCES AFFECTING SURFACE OF WATER.

There you have the stock of toy-balloons with the strings connecting each with a common centre point. *C* is the centre of gravity of the water in the glass. The lines diverging from *C* show the directions of the forces of cohesion. The short vertical lines downward from each molecule indicate the lines of the force of gravitation and the arrowheads on the cohesion lines mark the opposing forces of heat

and cohesion. In the triangle, $C a d$, for example, the hypotenuse $C d$ represents the total force of cohesion; $C a$ is its vertical component, and $a d$ its horizontal component. The resultant of all these horizontal components ad, ac, ab , etc., is a force effecting a compression of the surface of the water. A good idea of the structure of surface compression is shown by the ripe seed-tuft of the common dandelion.

Oh, but water is not compressible. True enough, to any sensible degree by an exterior force; but the interior forces at work in water do many wonderful things. For instance, they cause water to expand on cooling and to contract on heating, between 0°C . and 4°C ., and all the water phenomena of oceans, rivers, and rain-fall, of hydraulic and of steam powers, and of the irresistible force of freezing, are caused by the molecular activities existing in a drop of water.

One reason for lack of a clearer understanding of these phenomena is the failure to perceive the fact that the tendency to form a sphere of water in the tumbler is incessant, whether the attraction of gravitation acts on the mass of the water freely, as in falling; is warded off, as in Plateau's experiment; or is super-imposed upon the attraction of cohesion, compelling the water to conform to the inferior shape of the tumbler and rendering the ever-present cohesion inconspicuous.

The action of water from the higher degrees of temperature, through 4°C . to ice, is shown by the accompanying drawings. A mole-

FIG. 77.

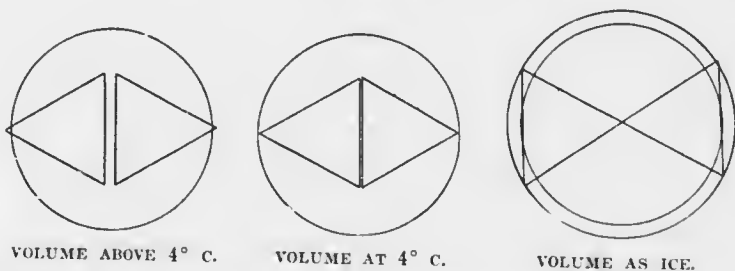

cule of water, composed of three atoms, is plausibly represented by a triangle. Two such molecules are separated a certain distance by a corresponding amount of heat, and this distance fixes the volume of the mass of water, which increases and diminishes as the degree of heat is raised or lowered. At 4° the volume of water is at a minimum and it is a fair inference that the molecules of water are at that point

nearer to each other than at any point. Below 4°C . the molecular forces react in such a manner as to cause a change in the relations of the molecules themselves, causing them to turn and—in the state of ice—to assume the positions shown in the third figure, with a lower specific gravity than the water had before freezing. No other forces are necessary to the causation of the phenomena indicated than those of cohesion and heat.

Here, then, is the answer to the question asked at the meeting: By reason of the horizontal components of the attractions of cohesion which draw each molecule of water toward the centre of gravity of its mass, the surface of the water is compressed, made more dense, and offers a resistance to the needle greater than the weight of the needle. That weight is not sufficient to break apart the surface molecules, but only makes a slight indentation on the surface. When the needle is wetted, capillary attraction raises the compressed surface over and above the needle which, no longer resting upon the denser surface, but in water not under surface compression, obeys the attraction of gravitation and sinks.

Attention was called above to the two cases of simple compression where the entire surface of both liquids, the water in the brim-full tumbler and the mercury in the partly filled glass vessel, are convex, whereas in a tumbler partly filled with water, the edge of the water, where it meets the glass composing the tumbler, is concave and the water wets the glass. Thus there is added a new force which modifies the surface compression of the water and draws the water at the edge upward on the glass, forming a concavity tangent to both the surface of the water and the inside of the tumbler. It makes no difference here and now what this force is called, whether cohesion or adhesion; whether it is the same molecular attraction that exists between the molecules of the water or whether it is the cohesion of the glass acting at sensible distances, or neither, or both. The water is drawn up, not pushed up, and any drawing up is attraction, and acting on molecules is molecular attraction.

In a tumbler $2\frac{1}{2}$ inches in diameter the horizontal concavity against the glass seemed to be about $\frac{1}{16}$ of an inch wide, perhaps a little more, leaving about $2\frac{3}{4}$ in. of convexity to $\frac{1}{4}$ in. total concavity, out of the diameter of $2\frac{1}{2}$ in. The vertical concavity seemed also about $\frac{1}{16}$ of an inch along the inside of the glass. With glass tubes of smaller diameter the horizontal concavity seemed to remain about the same, but the vertical concavity increased as the diameter diminished. The convexity at the centre of the surface de-

creased with the diameter of the circle and in a tube of $\frac{1}{4}$ in. diameter the surface of the water was an inverted hollow sphere with no convexity at all and its height above the level of the water in the tumbler was $\frac{1}{8}$ of an inch. With a tube of $\frac{1}{16}$ in. diameter the water came up $\frac{1}{4}$ inch.

The surface compression at the edge of the water in the tumbler is less than nearer the centre, being practically zero, and offering no resistance to the upward attraction upon the water. If a glass tube be partly immersed in the water in the tumbler, the water in the tube, even if open at the lower end, forms a separate cohesive mass, independent of the rest of the liquid with all the phenomena of capillarity.

It has been said above that the cohesion of the water varies inversely as the temperature, being greater at the lower than at the higher temperatures, and at the boiling point there is no cohesion. With the same changes in temperature the attraction between the water and the glass sides of the tumbler varies exactly as the cohesion varies, and there is every reason to believe that the forces elevating the liquid are those of cohesion of the water and the glass acting at sensible distances. These phenomena between the water and the mercury on one hand and glass on the other are, of course, those of capillarity. They seem to fit in with the above theory of surface compression.

Then what is there left of true surface tension? Well, there is the soap-bubble. I made some experiments in this direction a few days ago with 50 or 60 soap-bubbles from 4 to $6\frac{1}{2}$ inches in diameter. These were burst over a dark hardwood table about 30 inches square, so that the resulting wet spots on the surface of the table could be examined. Care was taken in every case in blowing the bubbles to remove the usual drop of water at the south pole of the bubble, so that all the wet spots came from the wreck of the distended film. After each bubble burst the table was wiped dry for the next one. When inflation ceased, one bubble 5 inches in diameter shrank an inch before it burst; another shrank from $6\frac{1}{2}$ to 5 inches. In both cases the air was expelled by a real surface tension of the bubble's film. Most of the bubbles were blown until they burst, at from 1 inch to 2 feet above the table. The ones at 1 inch spread wet spots in circles from 7 to 13 inches in diameter. Of the bubbles that burst at greater distances from the table, at 6 inches above the table the wet spots extended to the edge of a circle 15 inches in diameter; at 12 inches above, 20 inches; at 20 inches, 24 inches; and at 24 inches, 30 inches. Count-

ing a quarter circle, there were from 175 to 260 wet spots, or 700 to 1000 for each bubble.

It was evident that the force throwing these drops of water such great distances was not the air pressure inside the bubble. When the bubble burst the attraction of cohesion of the water composing the film acted to re-unite the distended watery molecules and, as the shortest distance between two points on the circumference of a sphere is measured on the great circle that joins them, the re-uniting molecules took that route, traveling over the spherical surface of the bubble, and when a number of them met and formed a drop, all the molecules were attracted with a certain force. The tangential components of these cohesive forces, acting in the substances of the spherical film and at right angles to the bubbles' radii, neutralized each other, while the centrifugal components united to shoot the drops away from the centre of the late bubble, in the direction of the prolongation of the bubbles' radii, and they fell in a wide circle, as already stated.

This is a true statement of the phenomena of the effect of surface tension on a soap-bubble. By what stretch, by what torture, of the imagination can these phenomena be brought into identity or even the least resemblance with those of the placid floating of the greased needle upon the compressed surface of the water in the tumbler?

Mr. Charles T. Durell in an article in the *Mining and Scientific Press* of September 18, 1915, entitled 'Why Is Flotation?', discusses the rising of a bubble through a liquid and says: "Surface tension causes the molecules of the liquid to form a film around the bubble and remain with it to the exclusion of like molecules during the time the bubble remains in the liquid. To all intents and purposes, this film is seen to be the same as if it were a membrane of some solid. The air in these bubbles can no more come in contact with the liquid through which it is passing than it could were it inside a toy balloon, for instance. The bubble may be said to be enclosed in a 'liquid skin.' As a proof of his argument he cites in a footnote the following: "A striking experiment to show these liquid films is as follows: To a beaker partly filled with a colorless oil, add a small quantity of permanganate solution. Blow air through a finely drawn-out glass tube into the permanganate solution now on the bottom of the beaker. Air bubbles enclosed in the colored liquid film rise through the oil and break at the surface, because of the expansive force of the gas. The colored water drops back through the oil exactly in the same manner that a balloon, bursting, drops to the earth."

With these instructions the following experiments were made: A

layer of water, half an inch thick, colored dark blue with a dye not soluble in kerosene, was put into a tumbler and three inches of white kerosene poured upon it. With a medicine dropper having a rubber bulb and a $\frac{1}{16}$ -in. hole in the end of the glass tube, bubbles of air were blown into the blue water, the end of the glass rod resting on the bottom of the tumbler. At first the pressure on the bulb was made very gently, the idea being to have the bubbles as small as possible. As many as 200 of these tiny bubbles were blown and they rose to the surface and formed a group. Some burst, some were incorporated with others, and finally, of course, they all burst. Every one of these 200 bubbles burst within a circle of half an inch, and that circle from the time of the first bubble until the last one, was not free from bubbles, one touching another and all forming a single compact group; but at no time, in the strong sunlight, was there the slightest trace of blue in the circle nor anywhere in the kerosene. The upward bound bubbles were perfectly white and there were no return passengers. The bubbles had no films but were simply holes in the water. When they came to the joint surface of blue water and kerosene, they slipped into the kerosene, made holes in that, and burst at the surface with no trace of a film.

Then, with greater pressure on the bulb, larger bubbles were blown, and with them, small quantities of the blue water were forced up into the kerosene. When these came separately the air rose to the surface and the water dropped back, but where they came together the air buoyed the water up to the surface where the air escaped and the blue water sank through the kerosene and disappeared. With greater pressure the bubbles became still larger, as did also the size of the drops of water forced out with the air. Where trapped together the larger masses of air and blue water joined and rose to the surface, as a single entity, sometimes very rapidly and sometimes very slowly. But in no case, whatever the size of the constituent parts, was the air-bubble blue. There were never any water-films. The rising combined air and blue-water drops in the cases of the larger bubbles were in shape as if the bubble were sitting on a tiny blue feather bed. In every case the blue water was below and the white bubble above and the bubble was pulling the drop to the surface. Sometimes the drop was too heavy for the bubble to float and both sank to the water layer and remained stationary until the drop merged in the blue water and the bubble was released.

When the smaller bubbles rose to the surface of the kerosene they did not break as quickly as in water but seemed to strike against the

under side of the surface stratum and rebound downward and moving over to the edge of the tumbler. On nearing the glass they seemed to rise as if attracted upwardly, like the part of the surface stratum around the edge under capillary attraction.

Some other interesting phenomena of capillarity were noticed. In the blue-drop-kerosene experiment the sides of the glass were wetted by the kerosene, even below the joint surface of the liquid; but notwithstanding this fact there was observed the concavity of the blue water under the oil, seemingly warranting the belief that the attractions between the water and the glass took place through the intermediate film of oil.

With a body of mercury, a glass tube pushed below the surface showed a rounded surface of mercury within the tube, with no capillarity the rounded surface being due solely to surface compression. With the tube floating in the mercury the level of the outside mercury was exactly the same as the top of the rounded contents of the tube; but when the tube was pressed down into the mercury the level of the mercury in the tube was lowered. It seems likely that the indentation of the floating needle and the lowering of the level of mercury in the glass tube are both due to the resistance of the surface compression to the entrance of foreign bodies.

In the experiment of the blue water, the bubbles and the kerosene, we come most unexpectedly upon flotation, or its counterfeit. If it is flotation, like the mineral flotation, how is it to be accounted for? If it is different, what is the difference? Will an explanation of the blue-drop kerosene flotation be that of mineral flotation, or will it help in that direction? There is surely an attraction between the air-bubble and the blue drop, or why should they stick together? The blue drop is heavier than the kerosene and the bubble of air lighter. One pulls up and the other pulls down. Why do they not separate unless there is a positive molecular attraction between them? Why does the bubble, resting upon the blue drop, buoy both to the surface of the kerosene, except for some molecular attraction between blue drop and bubble? Where this attraction is manifested, even slightly, it is helped by the static pressure of the liquid medium in which the flotation takes place.

The great unsolved problem in flotation is the identity of the forces that do the floating. Some say that it is surface tension, some electricity, and some molecular attraction between the air-bubbles and the metallic particles; and there is always the mystery as to exactly the part played by the oil. In this article it is intended to show that

there are certain molecular attractions between widely different substances which would seem to be nothing more or less than the force of cohesion acting at sensible distances, but for the circumstance that such an interpretation runs counter to our pre-conceived opinions as to molecular attractions; but these attractions are shown in this article to exist between glass and oil, between glass and water, directly and through an intervening film of oil, between glass and air, and between water and air. The impression remains that a thorough examination of our pre-conceived opinions may show that they are fallacious.

There are strong reasons for believing that the state of science today is not unlike that of learning at the end of the 12th century, at the time of the great awakening, when the world dropped the scholasticism of Rome and went back to the philosophy of ancient Greece. We have lost the faculty of studying phenomena, we are ignorant of the first principles of logic, and we have degenerated into mere juggling with names.

Proof of this indictment is found in Vol. XXIV of the *Encyclopaedia Britannica*, at page 401-2, where it is stated that the passage of electricity through liquids had been explained as a transference of a succession of electric charges carried by moving particles of matter or 'ions.' Then it was discovered that the moving particles that carried the electric current were much smaller than the atoms of hydrogen, and they were re-named 'corpuseles.' They enter into the structure of all matter. The only known properties of these corpuseles are their mass and their electric charge. There is reason to believe that the whole apparent mass is an effect of the electric charge. "The idea of a material particle thus disappears and the corpusele becomes an isolated unit of electricity—an electron." This is a typical 'scientific explanation.' It starts out inventing the word 'ion', which it immediately re-christens 'corpusele' and then 'electron,' and the only meaning that can be extracted from the argument is that electricity is supposed to be made up of units, a purely gratuitous assumption. Here is another on the same page 402: "Maxwell and Hertz showed that the velocity of propagation of light and electro-magnetic waves was identical and that their other properties differed only in degree. Thus light becomes an electro-magnetic phenomenon. But light is started by some form of atomic vibration and to start an electro-magnetic wave requires a moving electric charge." Here are three sentences all fallacious.

The peculiar tendency of the human mind which substitutes empty

names for real phenomena and then plays with the names is the same that makes religious peoples worship idols instead of fixing their minds on principles. It is easier. A pilgrimage to a shrine where one may worship a rag, a bone, or a hank of hair, and be absolved, is less trouble than leading an exemplary life. So that when the question is asked "Why does a drop of water that falls upon dust take the form of a sphere?" it is easier to say "Oh, surface tension" and let it go at that than to think about it. It is all very well to say that a snark is a boojum, if you first define your boojum; but when you scratch the boojum and find the same old snark the pursuit of knowledge seems in vain.

FLOTATION-TESTS IN SEPARATING FUNNEL

EFFECT OF ALKALINITY.

(From the *Mining and Scientific Press* of January 8, 1916)

100 grams of 200-mesh mill-heads, assaying Au 0.17, Ag 29.53, frothed 6 times in 400 cc. mill-water, with 0.44 lb. S. S. oil and 0.44 lb. eryslic acid per ton of ore, at a temperature of 80° F.

Test No.	Lime, lb. per ton			—Concentrate-Assay—			—Tailing-Assay—		
	At start.	At end.		Gm.	Au.	Ag.	Au.	Ag.	Acid
1.	0.08	0.02	Acid	17.562	0.46	90.0	0.12	16.1	Acid
2.	0.01		Neutral	15.859	0.60	110.6	0.10	12.4	"
3.	0.15		"	15.350	0.82	164.6	0.06	5.1	"
4.	0.25	0.01	Alk.	13.470	1.00	192.1	0.06	4.1	"
5.	0.34	0.02	"	14.20	0.85	184.2	0.06	3.8	"
6.	0.43	0.04	"	15.05	1.00	166.4	0.06	4.9	"
7.	0.70	0.12	"	26.95	0.52	89.3	0.03	6.4	"
8.	1.00	0.25	"	31.55	0.34	60.3	0.09	12.9	"

In separatory-funnel tests, assays of concentrate are much lower than in plant-practice. Tailing-assays are practically the same.

When frothing in mill-water, the best alkalinity, both as regards extraction and grade of concentrate, is from 0.01 to 0.02 lb. per ton of water.

FLOTATION PRINCIPLES

By C. TERRY DURELL

(From the *Mining and Scientific Press* of February 19, 1916)

In attempting to start a discussion on flotation by setting forth my osmotic hypothesis, the main objects were (1) to firmly establish fundamental laws and definitions and (2) to bring out and classify new phenomena. Flotation terms have been misused and jumbled in the same way that the so-called expert makes a mining report ridiculous by the use of geological terms. Litigation has made the subject more confusing, and it is still an indefinite cloud to most people. Now that first principles and definitions are being agreed upon, concerted effort is starting experimentation along definite lines that will lead to far-reaching results instead of the heretofore duplication of efforts leading to nothing. Before the final solution of a problem can be accomplished, the problem must be stated properly. It is therefore quite gratifying to see that the discussion is fulfilling the two main purposes and that the flotation problem now stands out more clearly.

A man can never learn from one who agrees with him entirely. For this reason I was pleased to see exception taken to my article 'Why Is Flotation?' O. C. Ralston thinks I used rather loosely the two words 'naseent' and 'occlusion.' It took me a long time to realize the prime essential for an effective froth. This can only be described clearly by the word 'naseent.' It also required several years of patient effort to convince myself that the whole subject depends on gas 'occlusion.'

Being unable to learn anything more in this country concerning flotation, some four years ago I made a trip to Australia, the home of flotation. There I saw for the first time copper concentrate won by flotation. At the Lake View Consols, in the Kalgoorlie district, I saw one of the old bulk-oil flotation plants.

It was at Broken Hill, however, that I had plenty of time and opportunity to study flotation. Companies using different processes were naturally adverse to entertaining a stranger who might be gathering information to be used against them in one of the various law-suits. As soon as the managers or officials in charge were assured that I was not there for that purpose, they afforded me ample opportunity to learn everything concerning flotation, giving me access to figures and data. In this country, it is seldom that a comparative

stranger receives such courteous treatment as was shown me by the cordial company officials there.

At the Proprietary mine, where the Delprat process was in operation, no oil was being used, yet there was practically the same persistent froth as at other plants using the Minerals Separation process. This fact then eliminates the two hypotheses for flotation advanced by Mr. Ralston¹, who says that "The first hypothesis is based on some academic work done by Reinders, who deduced the following inequalities as applying to a case where a powder, or the particles of a colloid, is suspended in a liquid to which is added a second liquid that is immiscible with the first." There at the Proprietary mine, where 500 tons per day was being treated by a single 'cell,' no such liquid was used. Therefore, according to Mr. Ralston's hypothesis, froth-flotation could not take place. Yet the records show that thousands of tons of zinc concentrate has been recovered by froth where no oil was used. I quite agree with Mr. Ralston when he says "It hardly needs to be said that here we find something very close to the conditions obtained in the flotation process." "In fact, the old Elmore bulk-oil flotation method fulfills exactly the conditions that Reinders had in mind." By basing the whole subject of flotation on gas occlusion, as I have done in my article, 'Why Is Flotation?' in the *Mining and Scientific Press* of September 18, all flotation processes may readily be explained.

On seeing for the first time a single spitzkasten being fed 700 lb. of ore per minute by means of a 'push-feeder' as is done at the Proprietary, one can but marvel at the simplicity and rapidity of action of this froth-flotation process, which makes a marketable zinc concentrate with high recovery without re-treating. As no oil was used, I summed up as follows the essential elements: gas, acid, and heat, in addition to ore and water. There is nothing else essential to this treatment. Studying the conditions there, I soon became convinced that the function of the acid was not only to produce bubbles for froth-formation, but also for the creation of selective action. Since the solution was kept as near the critical temperature of 80°C. as possible, no air from the solution could aid in froth-formation because the solution was under a hydrostatic head and was admitted at the bottom of the spitzkasten instead of by means of a jet above the surface. It was easily seen that the function of gas was for froth-formation and that the persistence of the bubbles was mainly due to the enveloping net of mineral particles. What then was the

¹'Why Do Minerals Float?' by O. C. Ralston, *M. & S. P.*, Oct. 23, 1915.

function of the heat? The cold ore dropping into this hot solution carried some air with it which the heat expelled. This was not the essential factor. The heat expelled enough of the occluded gas from the ore particles to form nuclei for the attachment of nascent gas to form flotation bubbles.

Studying the Elmore vacuum process at the British Broken Hill plant at a later date, I summed up the essential elements there as follows: vacuum (to liberate the air) acid, oil, and alkali. At a first glance it was seen that here was another method of making bubbles and froth. This froth was perhaps more persistent, as the envelope for the bubbles seemed tougher. The difference was so slight that it is best described as that between the froth formed during the early stage of the clean-up in the acid or 'cutting-down' tank of a cyanide plant and the froth formed during the later stages. It was natural, therefore, to assume that the principle or cause of this Elmore process of flotation was identical with that of the Delprat at the Proprietary. I was told there, and have been repeatedly told since, that the oil was the cause of the selective action. I never will believe this, with all the evidence against it, although on account of adsorption—not occlusion—of gases by the ore particles, they are more easily wetted with oil than with water. The results at these two mines were practically the same. The grade of the concentrate at the British plant was higher, by reason of mechanical refinements, and not the difference in process. Therefore the oil could not be the essential element for selective action, because no oil was used at the Proprietary. The oil was an essential element only in that it toughened the froth. Owing to mechanical means of operation, the froth could not be removed so quickly nor could it be carried in such a deep layer. Therefore oil was added to toughen it. Using Mr. Scott's words², "This froth rises and floats much the same as a beard would" while the Delprat bubbles "float over, if we get them over before they break"; and "if they do break, the mineral drops and is caught by the bubbles below." Oil, then, can be eliminated in making the following comparison between the essential elements of these two processes. Acid creates the selective action as in the Delprat method; lime is then added to neutralize it, because the vacuum machines are of cast-iron. Acid was found to be necessary in the Delprat process to create the bubbles. It was necessary for these bubbles to form as they "came into being" on mineral particles as nuclei. Nascent bubbles of air

²Walter A. Scott, counsel for defendant in the case of *Minerals Separation v. Miami*.

are formed in the same way, so that the vacuum of the Elmore process takes the place of the acid in the Delprat.

At the British plant, in making a froth, the solutions were not heated, for the reason that the vacuum which drew the dissolved air from the liquid, in accordance with the law of Henry, also drew a sufficiency of occluded air from the mineral particles to form nuclei for the air "coming into being" from the liquid. The acid had already acted as previously described. The small slow-speed mixer, just ahead of the vacuum machines, used for stirring oil into the thickened pulp, could in no way super-saturate the mass with air as is the case with a Minerals Separation machine, which process will be taken up later.

When I began the study of the De Bavay process at the Amalgamated Zinc plant, I was at a loss, at first, to see how the same principles underlying the other two processes just mentioned could apply there. The following essential elements were separated out: gas (in the form of air), acid, and oil. Mr. Meredith told me the object of the acid was to clean the mineral particles. While it undoubtedly does this, my contention is that it acts as an electrolyte, as I have described, to create the selective action afterward manifest during the oiling and aerating stages of the process.

Oiling of the mineral particles is the next stage and can only take place in liquid pulp, as I have explained, when particles themselves contain gas. It required a careful study of the apparatus at the Amalgamated plant before I was able to understand that the same underlying principles applied here. Air was necessary; yet where and how was it introduced? This is best described in T. J. Hoover's³ words: "Throughout this manipulation, including the acid-washing, the oiling, the raising with compressed air, and the flowing over the corrugated cone, the sulphide particles are repeatedly aerated, and as a result, especially after the oiling, take up their adhesive air-film and float." They were not using corrugated cones when I was there. Instead, the cones were covered with concentric rows of staggered triangular obstructions. These were made by bending the triangular burrs from holes punched in galvanized sheet-iron cones until they were perpendicular to the surface. These cones were then fitted down tightly over similar cones not punched. A montejus was used to lift the prepared pulp to these cones. As Mr. Hoover says, "The subjecting of the oil pulp

³'Concentrating Ores by Flotation,' by Theodore J. Hoover. Second edition, page 117.

to compressed air may be an essential part of the operation." It undoubtedly is, and this method is patented by Dudley H. Norris,⁴ although opposed by Minerals Separation Ltd. when application for patent was made in England.

The De Bavay float is caused by air. Why is it not a froth? Norris turns his super-saturated liquid directly into the pulp-mass and a froth is formed. The pulp-mass at the Amalgamated Zinc plant, super-saturated with air, was turned on to the top one of each series of four cones. There was no chance for froth to form while spreading in a thin stream over the surface of a cone. The float, however, is entirely different from the unstable float on the Henry Wood type of machine, which depends on surface tension entirely. It is best described in the words quoted from De Bavay: "When the contents of the receptacle were emptied into a beaker, a thick clean layer of 'black-jack' sprang to the surface of the liquid, while the white clean gangue was precipitated to the bottom."⁵

Upon studying several plants using the Minerals Separation process, the following essential elements of flotation were easily recognizable: air (beat in by stirrers to super-saturation), acid, oil, and heat.

It is to be noted that these are the same as described in the other processes. Practically the only difference is that the froth is more persistent, because there is more slime with which to armor the bubbles. The violent agitation coagulates the exceedingly fine metallic particles in the same way that butter forms in a churn. These coagules are then taken up in the froth the same as larger metallic particles. As Mr. Hoover⁶ states, "Large quantities of air are beaten into the pulp. By running the machine for a few minutes on water alone, it will be observed that the quantity of air so beaten into the pulp is enormous, for the clean water will be milk-white." This air, as it "comes into being," uses the mineral particles as nuclei from which to grow into bubbles.

The résumé of these commercial processes is to show that nascent gas is necessary. The only explanation of single selective action for all processes is that gas is held in the solid particles.

A theory that will not explain all of these processes is of no value whatever. Both of Mr. Ralston's hypotheses depend upon the use of

⁴U. S. Patent No. 864,856, Nov. 19, 1906.

⁵'Flotation in Australia,' by Charles S. Galbraith, *M. & S. P.*, July 17, 1915, page 85.

⁶'Concentrating Ores by Flotation,' 2nd edition, page 136.

oil, which is not an essential element to flotation, as was shown above. Also these hypotheses assume that bubbles, existing as such in a liquid pulp, can then have mineral particles attached to them. If this be so, and it is not necessary to grow, as it were, the bubbles from the nascent gas in the liquid, why is it necessary to beat air into solution beyond the saturation point as is done in all froth-flotation machines using air as an adjunct except in the Callow machine? It would be much simpler to turn in a stream from a compressor or blower. If electrification is then all that is needed to produce attachment of the mineral particles, surely there are plenty of ways to electrify the bubbles. Thomas M. Bains⁷ says, "It would seem easier, therefore, to electrify a bubble than to keep it from being electrified." No; something more than electrification is required of the bubble, as all who have tried to produce a float in this manner well know. James A. Block,¹² in his criticism on my article, says: "I cannot see how the water in a Callow or other pneumatic machine can become greatly super-saturated." This is best answered by Mr. Callow⁸ himself: "The bubbles composing the froth are generated under a hydraulic pressure varying from 15 to 40 in." It matters not whether the water be saturated "with air at a pressure of several atmospheres," as was done by Norris, or under a hydraulic pressure of 15 inches, because, as I pointed out, it is not the air that is held dissolved, but it is the air that comes out, which is available for mineral attachment. A hypothesis based on nascent and occluded gas explains all kinds of flotation as well as all flotation machines.

More flotation experiments have been carried out in Australia than in any other country. No publication of systematic experiments to learn the reasons for flotation is so complete as that in the proceedings of the Royal Society of Victoria, of Kenneth A. Mickle.⁹ His experiments (many of which I have verified in the laboratories of the Colorado School of Mines while experimenting in the new testing plant there some three years ago with the Horwood process) showed nascent gas necessary and also that the particles must contain gas. He showed by experiments that (1) heat or reduction of pressure to liberate gas, that (2) generation of gas by means of acid, or that (3) super-saturation of solutions with gas, will cause

⁷'The Electrical Theory of Flotation,' by Thomas M. Bains, Jr., *M. & S. P.*, Nov. 27, 1915, page 824.

⁸'Notes on Flotation,' by J. M. Callow, *M. & S. P.*, Dec. 4, 1915, page 852.

⁹Vol. XXIII and XXIV (N. S.), Part 2, 1911. Abstracted in *Eng. & Min. Jour.*, page 307, Aug. 12, 1911 (vol. 92), and page 71, July 13, 1912 (vol. 94).

minerals to float or tend to float without the aid of oil. He showed the effect of gases occluded by minerals to be (1) the particles are not wholly wetted when immersed in water; (2) the particles tend to float when sprinkled on water; (3) the particles when immersed collect bubbles as the solution is heated or exposed to vacuum and float or tend to float; and (4) the particles in gas-saturated solutions collect the bubbles evolved. He says, "In my earlier paper, it was shown that mineral particles absorb gases to an extent not previously suspected and that they retain the gas adsorptions with such persistency that they could neither be easily separated by mechanical means nor much affected by gravity and gas expansion." He also says, "In previous investigations, I found that carbon dioxide was obtained from all sulphides by the aid of heat and exhaustion in the presence of water. It is probable that the gas film can be expanded for removal in appreciable quantities only in the presence of water and that exhaustion in the dry state does not remove all the gas present."

With a view to further investigating the gas held by solids, he conducted the following experiments:

1. Copper and silver foil were cleaned with sodium hydrate and distilled water and dried. These and uncleaned pieces were treated in a vacuum-flask. Few bubbles formed on cleaned foil with distilled and air-free distilled water, but more on the uncleaned. All foil floated in tap-water.

2. Six steel needles were cleaned in the same way as the foil and allowed to stand one half-hour in alcohol and then dried in a desiccator. They would not float on distilled water until it had been exposed for some time to the air. Another set of needles and iron wire were similarly cleaned, but would not float until allowed to stand in a desiccator for two days. The same results were obtained with sulphides cleaned with sulphuric acid.

"These experiments show that perfectly cleaned needles and iron wire will float on the surface under the following conditions: (a) if the water is allowed to stand for some time in contact with air; (b) if the needles and wire are allowed to remain exposed to the air for sufficient time."

3. Cleaned and uncleaned pieces of iron wire, on being immersed in a saturated solution of carbon dioxide, showed the following results: (a) clean pieces collected very few bubbles, while (b) unclean pieces were covered with a frost of bubbles.

I have confirmed these experiments, therefore I am positive of

the incorrectness of Mr. Rickard's statement, "If you place an ordinary needle, say, a lace needle suitable for use with No. 80 thread, on the surface of a bowl of water, it sinks at once to the bottom, in obedience to the law of gravity. If, however, you pass the needle through your hair, so that it becomes greased, it will float on the water."¹⁰ This is the same old false assumption that oil is a necessity instead of an aid to flotation.

Swinburne and Rudolf¹¹ say, "A way of demonstrating the presence of gaseous envelopes is to sift some powdered substance which easily sinks, such as sand or ferrous sulphides, upon the surface of hot water, previously freed from gas by boiling. Bubbles of gas rise from the surface of solid particles." "It seems necessary that the gas should be produced at the surface of the particles themselves." The air-film always plays an important part; and if the ore is thoroughly washed or boiled in water to remove the air-film, it cannot be concentrated with acid."

There are many other references all showing the same thing: that the mineral particles to be floated must contain gas so as to act as nuclei for the gas as it "comes into being" from the liquid. Therefore, in my former article, I did not present this evidence to prove my statement, which seemed a self-evident fact in view of the present knowledge of the subject.

Mickle collected gases from concentrate made from Broken Hill material some of which gas contained:

(1)		(2)	
N	72%	N	82%
O	2	O	2
CO ₂	26	CO ₂	16

It is seen that these gases obey Henry's law, each existing independent of the others and not displacing the others as Mr. Block¹² says undoubtedly would be the case. An analysis of a sample from the Horwood process gave:

N	95%
O	1
CO ₂	4

These three samples of gas became disengaged from three samples

¹⁰"What Is Flotation?" by T. A. Rickard, *M. & S. P.*, Sept. 11, 1915, page 384.

¹¹Paper read before the Faraday Society, Dec. 12, 1905, by J. Swinburne and G. Rudolf. Abstracted in *Eng. & Min. Jour.*, Feb. 10, 1906.

¹²James A. Block, *M. & S. P.*, Oct. 30, 1915, page 659.

of concentrate which were allowed to stand. Afterward a vacuum applied to No. 1 sample (70 gm. sulphide) gave a further amount of 1.7 cc. gas analyzing:

N	27%
O	14.1
CO ₂	58.8

On raising the temperature to the boiling point and subjecting this sample to vacuum, there was then given off 8.9 cc. of gas, which was found to be practically all carbon dioxide.

From the No. 2 sample he obtained 18.5 cc. gas of which practically all was CO₂. On subjecting minerals to reduced pressure and heat, he found that he could obtain more gas from calcite and quartz. This was mostly CO₂. He proved in all these cases that the CO₂ obtained was not from the decomposition of carbonates. This shows that minerals in general occlude gas, although Mr. Ralston¹ says that "good cases of occlusion have been found thus far only in amorphous substances." Mr. Block is quite right when he says "that it would be liberated with sufficient rapidity to float the particles does not seem probable."¹² Also Mr. Ralston¹ is correct in saying "How the tightly-held gas could be liberated fast enough to compare with the exceedingly short time which it takes to accomplish flotation of a sulphide particle is difficult to explain physically." I simply stated that "if this gas be expelled from them, when they are in a liquid, at a time when the gas is expelled from the liquid, they become the nuclei for the formation of gas bubbles." On the other hand, if bubbles are not formed from nascent gas of the liquid in contact with the mineral particle there can be no adhesion because the bubbles are surrounded by liquid films; or, if the particles contain no occluded gas, there can be no adhesion because the particles are surrounded by liquid films.

That these two words 'nascent' and 'occlusion' were objected to shows the necessity of extreme care in the choice of terms, and I am glad that Mr. Ralston brought up this point. 'Nascent' is defined in Webster's New International dictionary (3rd), 1915, as follows: "Being born; coming into existence; beginning to grow; commencing, or in process of, development." The Century dictionary, 5th edition, 1911, gives practically the same definition as follows: "Beginning to exist or to grow; commencing development; coming into being; incipient." The following usage is given: "Wiping away the nascent moisture from my brow: Barham, 'Ingoldsby Legends'." Available gas of any kind for flotation must "come

into being" in this way. Mr. Bains¹³ excellently describes this, as follows: "If powdered galena ore, with a limestone gangue, be dropped into pure water, most of the powder will immediately sink to the bottom. As the air enclosed by the particles is expelled gradually, one sees the formation of 'armored' bubbles, some of which may last for days. Here is flotation without oil or acid. If nitric acid be added, the gas bubbles formed by the action of the acid on the gangue will carry up particles of galena." I have placed ½-inch pieces of quartz, galena, and other minerals in a beaker filled with water saturated with air at atmospheric pressure. The purpose was to watch the formation of the bubbles. More small bubbles formed on the metallic minerals when heat was applied. The bubbles formed on all minerals apparently in the same way that moisture forms on one's brow. I wish to describe this. There is only one single word in the English language that can be used to do it—"nascent." This is not "the dissolved gas that can be liberated," but it is the dissolved gas at the instant of liberation.

Regarding occlusion, Mr. Ralston has been kind enough to mention three ways by which gases can be held in solids, and I should have used more care in the choice of these terms. I used the word 'occluded' as a general term to denote either surface adsorption or solid solution. As Mr. Ralston says, "this is a term the meaning of which has been much disputed." Trying to show that the gas in the mineral obeys the same laws as the gas in the liquid, as proved by Mickle, I spoke of the gas being dissolved in the solid and thus led up to the term 'occlusion,' having in mind the following: "The amount of gas which dissolves in a given quantity of water is proportional to the pressure, and from this experimental result, Van't Hoff showed mathematically by the principle of thermodynamics that, when in solution, this same gas must exert an osmotic pressure";¹⁴ and that "Substances dissolved by solids have an osmotic pressure as shown by Van't Hoff, so we can speak of solid solutions";¹⁵ also that "the greater the pressure to which the gas is subjected, the larger the quantity which will be adsorbed by the solid."¹⁶

Viscosity is another word that has been incorrectly used in

¹³'The Electrical Theory of Flotation,' by Thomas M. Bains, *M. & S. P.*, Nov. 27, 1915, page 824.

¹⁴'The Recent Development of Physical Science,' by W. C. Dampier Whetham, page 113, 2nd edition, 1904.

¹⁵*Zeit. Phys. Chem.*, 1890, 5, 322.

¹⁶'Elements of Physical Chemistry,' by Harry C. Jones, 1902, page 267.

connection with flotation. Mr. Rickard¹⁰ in his article, 'What is Flotation?' states: "The combination of low tension and high viscosity enables a bubble of gas, rising through the liquid, to lift the surface film of the liquid, which the tension of the bubble-film is not strong enough to break, so the bubble endures"; and cites 'A Text Book of the Principles of Physics,' by Alfred Danniell, 1911. Also Mr. Rickard states: "Pure water has great surface tension, it also has no superficial viscosity."

Viscosity as known today is an entirely different property of matter from that which Danniell in 1885 confused with surface tension.

Perhaps the best definition of viscosity is by Harry C. Jones,¹⁷ as follows: "We need simply mention here the works of Poiseuille, Pagliani and Battelli, Slotte, Gartenmeister, and Traube" * * * "The monumental works of Thorpe & Rodger merit more careful attention." * * * "They prove conclusively, what has been hinted at before, that * * * viscosity may be taken as the sum of the attractive forces in play between the molecules; * * * It is, therefore, made evident that viscosity or inter-molecular attraction is in reality a property of the atoms of which the molecules are composed." This 'superficial viscosity' is well explained in the *Encyclopaedia Britannica*,¹⁸ as follows: "The varying of contamination to which a water surface is subject are the causes of many curious phenomena. Among these is the 'superficial viscosity' of Plateau." * * * "Plateau attributes these differences to a special quality of the liquids named by him 'superficial viscosity.' It has been proved, however, that the question is one of contamination and that a water surface may be prepared so as to behave in the same manner as alcohol." Mr. Rickard, in his second article, page 517, *Mining and Scientific Press*, October 2, 1915, says: "To make bubbles, the surface tension of water in the flotation-cell must be decreased by a contaminant and at the same time the viscosity of the liquid must be strengthened." As shown above, it is not the viscosity but the general surface tension effect that must be strengthened. As I pointed out, a soluble or partly soluble oil will decrease the surface tension of water because it dilutes the water, which has the greater surface tension. By reason of this cause alone, the tendency to float is decreased and the bubbles burst

¹⁷'Conductivity and Viscosity in Mixed Solvents,' Carnegie Institute, Publication No. 80, 1907, page 19.

¹⁸11th edition, under 'Capillary Action.'

more easily. Using a volatile oil in a M. S. machine, I have had the bubbles burst so violently that the cement floor was blackened with zinc sulphide at a distance of several feet from the machine. At the same time I was making a very clean zinc concentrate from Leadville mixed sulphides after a Horwood roast. As no other contaminant was used, this was only made possible by having the mineral particles well oiled with the thinnest possible film to aid cohesion in armoring the bubbles well with the zinc sulphide particles. In this case the surface tension was still further reduced by the sulphuric-acid electrolyte.

Most oils, however, aid modern flotation in three ways, as I tried to point out in my former article, by (1) decreasing the force of adhesion of water for mineral particles by forming films around them, (2) increasing the cohesive force of the mineral particles for each other to aid in the formation of a network of mineral particles around the bubbles to toughen them, and (3) toughening the bubbles by forming films of oil around the bubbles in addition to those of the water. 'Toughen' is not a good word whereby to express the meaning Mr. Ralston explains this very well and at length on page 624, *Mining and Scientific Press* of October 23, 1915, under his inter-facial tension hypothesis. He claims, however, "It is doubtful if the air bubbles could be completely mantled by oil." This is contrary to the experience of others. The colors on the bubbles indicate that they are mantled." This shows that Mr. Callow is right when he says "The bubble-mantles in a flotation-machine are undoubtedly composed of oil, or oil emulsion."¹⁹ The sum of these tension effects causes persistent bubbles, even though the surface tension of the water has been reduced. These undoubtedly are extremely thin films, at least approaching one molecule in thickness.

Therefore molecular forces must be taken into account in dealing with them: as Mr. Ralston says, "The underlying cause of the tensions and of electric charges is the same thing—some strange molecular, atomic, or other force manifested in 'adhesion,' 'cohesion,' or even 'gravitation,' if you please." In dealing with these inter-facial tensions, the drop-weight method cited by Mr. Coghill²⁰ for determining surface tension is of no value to flotation.

The inter-facial hypothesis of Mr. Ralston explains very well indeed the persistency of bubbles, but I am not so easily satisfied

¹⁹'Notes on Flotation,' by J. M. Callow, *M. & S. P.*, Dec. 4, 1915, page 854.

²⁰'Surface Tension,' by Will H. Coghill, *M. & S. P.*, Oct. 9, 1917, page 543.

as is Mr. Bloek,¹³ who says, "T. J. Hoover, for instance, in his book, 'Concentrating Ores by Flotation,' presents a consistent theory." Mr. Hoover (2nd edition, page 72) says: "There has been no satisfactory theory yet propounded as to why acid does promote the preferential adhesion of water to gangue particles." Even the late electrical theory fails to answer all the questions asked by Mr. Hoover, on page 100 of his book. I answered the above question in my article by showing that an acid or any electrolyte creates osmotic pressure, by trying to enter the solid particles, of which their surfaces act as septums. If this pressure be sufficient to drive most of the gas out from the gangue particles, the metallic particles can be floated, for the reason that there is still left sufficient gas in them to become nuclei for bubble formation by the nascent gas of the liquid.

As shown by Mickle's experiments, mentioned above, there is more gas in sulphides than in other minerals and it is held more persistently in the sulphides. Thus a selective flotation is created. I have confirmed these tests.

Everyone who has experimented with flotation has seen how too much acid will 'kill' the float. That is, the greater osmotic pressure drives the air from the metallic particles as well as from the gangue particles.

This effect is not to be confused with that caused by substances such as tannin or saponin mentioned by Mr. Callow¹⁹ as colloidal impurities or volatile oils and the like, which destroy bubbles by reducing the surface tension to the extent that the gas pressure from within breaks or even explodes them. This weakening of the surface tension by a colloid is an entirely different phenomenon from that shown when the osmotic pressure is increased by a crystalloid.

"The crystalloids when dissolved in water change in a marked degree its properties; for example, they diminish the vapor pressure, lower the freezing point, and reduce the boiling point."²¹

And as Dr. Lupke²² states, the four laws in speaking of dilute solutions, are "Equimolecular solutions of any substances, prepared by using equal weights of the same solvent, exhibit equal osmotic pressure, equal relative depressions of vapour-pressure, equal risings of boiling point, and equal lowerings of freezing point."

²¹'Text Book of Physics,' by J. H. Poynting & J. J. Thompson, 3rd edition, 1905. page 186.

²²'The Elements of Electro-Chemistry,' by Robert Lupke, 2nd edition, 1903, page 119.

In maintaining that osmotic pressure of an electrolyte is the cause of selective flotation, it is well to look into the motive power of osmosis. Kahlenberg²³ states it "lies in the specific attractions or affinities between the liquids used and also between the latter and the septum employed. These affinities have also at times been termed the potential energy of solution, etc.; they are, to my mind, essentially the same as what is termed 'chemical affinity'." Or, as F. H. Garrison²⁴ put Taube's theory: "The driving force in osmosis is a superficial (or inter-facial) pressure obtained by subtracting the surface tension of one fluid from the tension of the fluid into which it diffuses." Or again as Van't Hoff and his followers contend "The molecules of a dissolved substance exert the same pressure against a semi-permeable membrane, during osmotic processes, as they would exert against the walls of an ordinary vessel were they in the gaseous state at the same temperature and the same concentration."²² Since these authorities do not agree on the motive force of osmosis, investigation must rest for want of further data.

However, all theories of flotation, be they electrical or otherwise, must come to osmosis for their solution. This is not to question the fact shown by electrolysis that every atom of matter is capable of uniting with a definite quantity of electricity. Nor is it to question that corpuseles (later termed electrons by Dr. Stoney) do not revolve around atoms which are thousands of times larger. But it is to question any hypothesis that does not take into account the fact that particles will not float when all the gas is driven from them. Osmotic pressure can free particles of their occluded gas. Whether osmosis is caused by electricity or whether a current of electricity is caused by osmosis has no bearing on flotation. However, in passing, it may be of interest to mention that Dr. Robert Lupke, in his book, 'Elements of Electro-Chemistry' devotes Part III to 'The Osmotic Theory of the Current of Galvanic Cells.'

As mentioned above, extreme dilution of the electrolyte affects the osmotic pressure and selective flotation. With complete dissociation, as Arrhenius has shown, the ionized molecules are free to obey electric forces. It may be freely granted that air driven from a particle by osmosis may effect a change in the 'contact-film' mentioned by Mr. Callow and leave the particle negatively charged, so that it would sink as described by him. Also it is granted that

²³*Jour. Phys. Chem.*, 1906, 10, page 266.

²⁴'A Note on Taube's Theory of Osmosis and Attraction Pressure,' by F. H. Garrison, Army Medical Museum, *Science*, vol. 32, 1910, page 233.

the mineral particles are all either negatively or positively (?) charged. Assuming the electric charges, there then enters the important question mentioned by Mr. Callow in stating his theory that "the particles possessing them will migrate when placed in an electric field." There is no question but that with an electric field, flotation can be produced in such a manner as described by Bothe Schwerin in his 'Electro-Osmotic Process'²⁵ as follows: "My invention consists of adding electrolytes to the liquids containing the substances to be separated, the nature of the electrolyte depending upon the character of the substance. If the latter is of such a character that they would be deposited by the electric current on the cathode, electrolyte of acid character are employed; and if the substances would be deposited on the anode, electrolytes of basic character are used." Speaking of finely-divided substances, sometimes indifferent to the action of an electric current, he continues: "I have found that such substances can be made electrically active by causing them to absorb [here used as defined by Mr. Ralston] colloidal substances of a strong electro-positive or electro-negative character." Of the recent electrical theories advanced, none explains how this important electrical field, mentioned as necessary by Mr. Callow, is created by any flotation machine. Mr. Bloek²⁶ shows this on a clay machine.

After selective flotation is created by osmosis, it matters not whether the particles be spoken of as being held together or to the bubbles by electric charges or by cohesion and adhesion in the way I mentioned. Sir Oliver Lodge,²⁷ after saying that "the force of chemical affinity has long been known to be electrical" goes on to say that "there is another kind of adhesion or cohesion of molecules, not chemical, but what is called molecular. This occurs between atoms not possessing ionic or extra charges, but each quite neutral, consisting of paired-off groups of electrons." However great this attraction may be, the mineral particles will not adhere to bubbles already formed, as was shown above; but, using them as nuclei, the nascent gas will form into bubbles to float them. Such gas formation is excellently described by Duhem²⁸ as follows: "From this, a bubble of vapor will never be formed in a region where the

²⁵U. S. Patent No. 993,888.

²⁶'Notes on Flotation.' Discussion. Bulletin A. I. M. E., Dec., 1915, page 2227.

²⁷Chapter 16, 'Nature of Cohesion,' in book 'Electrons,' by Sir Oliver Lodge, Principal of the University of Birmingham.

²⁸'Thermodynamics and Chemistry,' by P. Duhem, 1903, Art. 275, page 366.

liquid is continuous; in fact, if such a bubble could begin to form, its radius would be at first infinitely small—less than the limiting radius of which we have spoken; whence, instead of continuing to grow, it would collapse.” On the next page he continues: “These considerations do not apply merely to boiling; they completely explain a great number of phenomena.”

The electrically-charged mineral particles may aid in bubble formation although they cannot effect attachment of mineral particles to bubbles already formed. Regarding this, Dr. Thompson²⁹ says that “the charged particles act as nuclei around which small drops of water condense, when the particles are surrounded by damp air cooled below the saturation point.” “Experiments were made with air, hydrogen, and carbonic acid and it was found that the ions had the same charge in all the gases.” Also, “Thus by suitably choosing the super-saturation, we can get the cloud deposited on the negative ions alone so that each drop in the cloud is negatively charged.” Electricity may manifest itself in various ways, but flotation cannot take place without nascent or occluded gas.

²⁹‘The Atomic Structure of Electricity,’ Chapter 4, ‘Electricity and Matter.’ By J. J. Thompson. Lectures at Yale, May, 1903.

THE ELECTRO-STATICS OF FLOTATION

By F. A. FAHRENWALD

(From the *Mining and Scientific Press* of March 11, 1916)

The development of every new metallurgical method is accompanied by a host of contradictory statements and widely differing opinions, but it is only by the elimination and correlation of parts of recorded observations that a particular process approaches a state of perfection. The theory of flotation has called forth a number of articles, each writer applying a different hypothesis in explaining the puzzling phenomena accompanying the process.

Of the various hypotheses thus far advanced only two are based on principles of sufficiently apparent soundness to warrant serious consideration.

The first of these involves the physical surface phenomena that may produce an inter-facial tension. This has, until recently, been accredited with more importance than all the other explanations combined. The second is called the electrical theory.

The part that surface phenomena may play in linking the particles of ore to the bubble-carriers is ably outlined by O. C. Ralston, whose treatment¹ of this phase of the question includes reference to about all of the theory that has so far been found applicable to flotation. Without doubt a proper application of the laws of physical chemistry will disclose fundamental principles upon which this process may be based, and it may be in the field of colloidal chemistry that most information is to be gained.

With regard to the electrical theory, however, there has been applied a number of laws of electro-statics that, from the general nature of conditions under which flotation is carried out, would seem to be inoperative.

This hypothesis has been tolerated by Mr. Ralston,² it is strongly advocated by J. M. Callow³, while Thos. M. Bains, Jr.,⁴ excludes all other theories. These three references contain the gist of all arguments advanced in support of this hypothesis, and the last of them

¹'Why do Minerals Float?' *M. & S. P.*, October 23, 1915. See also page 175 of this book.

²*Op. cit.*

³'Notes on Flotation.' *M. & S. P.* See also page 231 of this book.

⁴'The Electrical Theory of Flotation.' *M. & S. P.*, November 27, 1915, and December 11, 1915. See also pages 225 and 258 of this book.

elaborates and definitely formulates the necessary requirements for flotation by electrical means. It is my object to attempt an analysis of the various arguments advanced in support of the electrical theory, and as the only difference between this and any other theory lies in the phenomena that cause the bond between the flotative mineral and the bubble-carrier, it is understood that only this phase of the process is under discussion. It is necessary, however, in order to arrive at practical conclusions, that this question be considered under conditions similar to those encountered in practice.

Before proceeding to a discussion of the electrical theory of flotation it will be necessary to point out briefly a few of the facts of electro-statics upon which it is based.

A. The production of electricity by friction is a common phenomenon; almost any two bodies become electrified if they are rubbed together. In the case of several substances, considerable force is then necessary in order to separate them. Attraction or repulsion also occurs when an electrified body is brought near bodies that have been subjected to friction and if these are light enough (as bits of pitch, feathers, wood, paper, etc.) they may be lifted. Bodies may also become electrified by coming in contact with other bodies that already carry a charge. In this case the first body receives electricity of the same sign from the charged body and is then repelled.

B. Bodies that when electrified at one point are immediately electrified all over are called good conductors; those over which the charge diffuses slowly are poor conductors. All metals, many metallic ores, graphite, ordinary undistilled water, and aqueous solutions of salts are good conductors.

C. If a piece of metal, or other conducting material held in the hand is rubbed against a non-conductor—say, a piece of dry flannel—only the non-conductor appears afterward to be electrified. The reason is that the electrification produced on the metal spreads over the hand, arm, and body of the experimenter to the floor and walls of the room. If, however, the conductor be insulated, the degree of its electrification cannot be increased or decreased.

D. By whatever process a body is electrified there is always an equal amount of electricity of the opposite sign, which may reside upon the walls of the enclosing room or upon some other surface insulated from the conductor. Bodies carrying opposite charges, when brought in contact or connected by a conductor, become discharged. If the charges are equal they are neutralized, but if one carries more than the other the system takes on the sign of the excess charge.

E. If these bodies are strongly electrified, discharge can take place through an appreciable thickness of non-conducting material, such as air, oil, or glass. This discharge is facilitated by the presence of sharp projections upon either body.

F. (a) The space between two charged bodies is filled with lines of force that tend to move a contained body in the direction of the local lines of force leading to the surface carrying the opposite sign.

(b) These lines of force do not penetrate the surface of the conductors forming its boundaries and a hollow conductor is electrified on its outside or inside surface only, depending upon whether the opposite charge resides upon one contained without the sphere or upon one contained within and insulated from the shell. In the latter case the entire field is contained within the inner surface of the sphere, and in the former case there is no charge within the hollow conductor.

G. The force exerted between two small charged bodies is given in the equation $F = \frac{qq^1}{d^2}$ in which q and q^1 are the charges in electrostatic units carried by each of the two bodies, and d is the distance between their centres of charge.⁵ If the bodies are separated by a medium other than air a factor K , known as its dielectric coefficient, must be used, and the equation becomes $F = \frac{1}{k} \cdot \frac{qq^1}{d^2}$

H. Matter itself is not acted upon by an electric force, which acts only between different quantities of electricity. When a conductor is introduced into an electric field it represents a gap or an interruption of the lines of force, resulting in an electrification of its surfaces only, that part becoming positive which is presented toward the negative boundary of the field and the reverse. In other words, the original field is divided into two. This same effect is produced in the case of a poor conductor but to an exceedingly small degree. This explains the attraction of small bodies by another that has been electrified by friction, in which case electrification by influence precedes attraction, and what is really observed is attraction between opposite electric charges.

Before considering these fundamental laws of electro-statics in connection with an explanation of flotation phenomena, it may be well to consider briefly the conditions under which different phases of this process take place.

⁵The force exerted by a charged sphere acts as if originated at the centre.

Of first importance is the fact that all operations are carried out in conducting solutions which in every case are earthed. It is inconceivable that, after any grinding process has been applied in machines such as are commonly used, the individual positively charged particles of ore should not have come in contact with negatively charged bodies and with conducting parts of grinding and mixing machinery, even if oil has been added in a preliminary stage. The ore particles are conductors, the oil is a non-conductor, the bubbles are filled with non-conducting air, and the gangue is composed of non-conducting material.

These conditions being granted, the next step will be to apply the laws of electro-statics to criteria for flotative conditions according to the electrical theory, as summarized by Mr. Bains. These include the main ideas of Mr. Callow's article and of the theory in general, so that a discussion of these in order will apply to the various other articles advancing a similar hypothesis.

1. "Ores containing valuable minerals or metals that are good conductors are the only ones that are suitable for flotation."

This seems in general to be true, but the ratio of flotative tendency to conductivity of the different ore constituents is nothing like a constant. For instance, the conductivity of galena is to the conductivity of chalcocite as 35:1. Their flotative tendencies hardly bear this ratio.

In entire opposition to this supposed requirement I found that small pieces of diamond attract a grease⁶ or oil coating and attach to bubbles quite as readily as does galena.

2. "To buoy these conductors, it is necessary to supply enough electrified bubbles from below to float particles of the conductors that are attracted; hence the smaller the bubble, the better the result, the amount of gas being the same."

A bubble within a solution of various salts and acids presents a similar condition to that of the air-space within a hollow conducting sphere. It is known (see F' (b) above) in this case that in order to have a charge upon this inner surface it is necessary that an opposite charge be maintained within and insulated from it. In the case of the bubble there is nothing inside to carry the charge. In case this space carried water-vapor or ionized gases, a charge could be present, but it would be dissipated quickly by diffusion of these charged particles and resulting contact with the water-surface.

If this sphere did contain charged gases and was lined with oil,

⁶This fact is utilized in the recovery of diamonds at Kimberley.

there would be present the condition of the hollow conducting spheres, (F (b)) with enclosed charged conductor insulated from it, and carrying an opposite charge. The charges would be equal and the amount governed by the charge on the inside sphere. These charges being balanced, the bubble system could have no influence upon a body—charged or not—without the outer sphere, such as a particle of galena suspended in the water at a distance. There can be no attraction through the intervening conductor, as lines of force will not penetrate a conducting surface.

It appears evident then that, first, unless a bubble contains charged bodies (ionized gas, water-vapor, or solid) within its bounding sphere it can carry no charge; second, that unless it is lined with a dielectric the charge will be rapidly dissipated; and, third, even though a charge is present and insulated from the outer conducting sphere it can have no attraction for any body or charge without the outer sphere, through a thickness of solution.

3. "Some dielectric fluid is necessary to cover the conductor or the bubble, to prevent the dissipation of the electric charge. The thinner the film of dielectric and the greater its dielectric strength the greater the attractive force and the more permanent will be the froth."

The bubble, both insulated and otherwise, has been considered. The particle of ore, unless insulated, will be immediately discharged by coming in contact with a grounded conductor—the solution. It is immaterial whether the opposite charge is carried by the water or by some other surface, the effect will be the same. Assume, however, that the ore particle is charged, and insulated. Again we have the case of one charged conductor (the ore) being enclosed within another (the surrounding water solution) giving a system which is neutral with regard to any other charge or system without the outer sphere.

Under conditions electro-statically ideal these forces may be pictured as in Fig. 79.* Both bodies are charged and insulated, and suspended in an intervening conducting medium. The systems ore-oil-water, and gas-oil-water, are without effect upon each other.

In case the gas is generated from the ore the particle could not be insulated unless by some phenomenon not understood at present. If the gas is air passed mechanically into the pulp it would be forced into contact with ore particles, in which case the charges carried by each would have its effect upon the other. That a mass of air con-

*See page 342.

taining charged vapor or gases could be insulated before coming in contact with the conducting solution is not reasonable.

Assuming, however, that both bodies are charged, so that the second part of No. 3 (above) regarding the thickness of insulation may now be considered. It has been proved that the force exerted by a charged sphere acts as if it was concentrated at the centre. Bearing this in mind it is evident that in the case of particles of the size with which flotation deals, a separation of their surfaces by one micron or one millimetre will produce little practical difference in the force exerted between them.

4. "Some material must be added to the water to increase its conductivity, to obtain a clean concentrate; acids in small amounts are now used."

This factor has been considered under divisions 2 and 3. The working solution is a conductor, parts of which are interposed between the various charged particles, thereby breaking all lines of force between them.

In any attempt to determine experimentally whether or not electro-static forces play any considerable part in holding the bubble and particles of ore together it is rather difficult to select tests which will give results of value. If these forces act to the exclusion of all others it is evident that they would be represented by charges of easily measurable magnitude. For example, I have separated particles of galena, (uncoated with oil) that have been carried to the top of an acid solution, weighing 60 mg. (52 mg. in water). To hold a particle of this size to the surface of a bubble requires 50.9 dynes—call it 50 in round numbers. The diameter of this particle is about 2 millimetres. The bubble required to buoy this particle must displace at least 52 mg. water or in other words its volume must be 52 mm³. Its diameter would be about 5.2 mm. Using these figures the equation for force becomes $52 \text{ (dynes)} = \frac{QQ'}{12.96}$ or assuming the charges to be balanced

$$Q^2 = 673.92$$

$$Q = 25.9 \text{ e. g. s. electro-static units.}$$

It is not likely that a particle of ore or a bubble of the nature given can have a charge of this magnitude, for the reason that a potential of this intensity would discharge through a very strong dielectric. Experiments have been carried out that give ratios for electro-static units, potentials, and distance through which discharge will take place in air, using brass knobs of one centimetre diameter.

Electro-static units.	Volts at discharge potential.	Distance between knobs.
16.1	4830	0.1 cm.
56.3	16890	0.5 "
84.7	25404	1.0 "

According to these figures the charge necessary to exert a force of 50 dynes in lifting a particle of galena would be so intense that it would discharge through a dielectric as strong as air at the distance by which the centres of charges are separated. Not satisfied, however, with this apparent theoretical disproof of the electric theory I undertook a series of experiments⁷ that should serve to check the various points in the above theoretical discussion.

No. 1. Galena ore was ground in an agate mortar and poured from an agate spoon (to prevent discharge of positive electricity, if present, from ore) between two plates of an electro-static machine. The material was deflected as shown. Plates were electrified almost to discharge point. This shows that galena ground under insulating conditions carries a charge and that a particle of this nature, suspended in a *non-conductor* in an electro-static field, is attracted.

No. 2. Ore was ground in conducting earthed mortar and poured from earthed spoon. Deflection of only a very few particles was shown. Perhaps the deflected particles were insulated with oil or did not come in contact with earthed surface.

No. 3. Ore treated as in No. 1 and poured between glass sides of a cell. Glass was 1 mm. thick and separated by 2 cm. Potential between plates of machine was 8500 volts. Deflection as shown. The interposition of glass had very little effect.

No. 4. As in No. 3, but the cell was full of water. Used conductivity, tap, and acid water. No deflection. This indicates that particles charged, or otherwise, suspended in a conducting solution (*i. e.*, enclosed within our hypothetical conducting sphere) is not affected by electro-static forces without.

No. 5. Cell contained ore and nitric acid solution to generate gas. Neither bubble rising or ore particles dropping showed deflection. Potential, 10,000 volts. The conditions here duplicate those of No. 4.

No. 6. Bubbles blown through canvas into water or acid solution were not deflected. A charge of bubbles flowing in one direction

⁷The writer is greatly indebted to the departments of Metallurgical Engineering and of Physics in the Case School of Applied Science for laboratory facilities and apparatus placed at his disposal in carrying out these experiments.

would produce an electric current, and even if they were charged they could not be attracted, as here again the charges are enclosed in a conducting material.

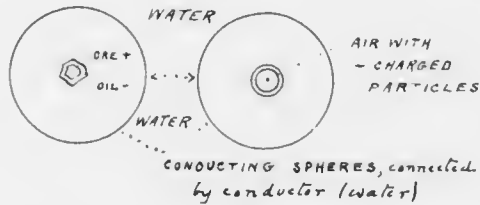
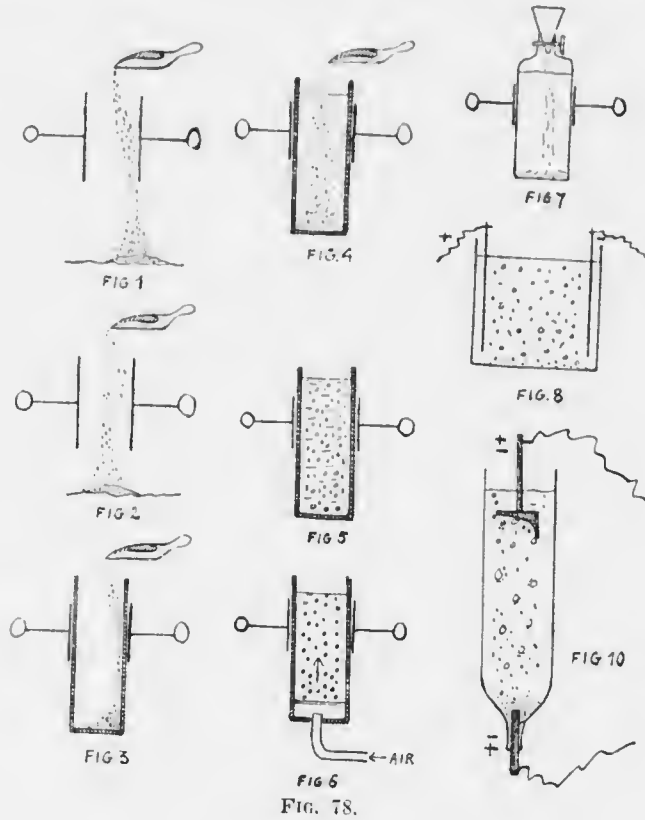

FIG. 79.

No. 7. Ore poured into cell containing gasoline. There seemed to be a slight deflection. 10,000 volts between plates. Conditions here should not differ greatly from those of No. 3. Solution may not have been sufficiently non-conducting.

No. 8. Solution placed in electrolytic cell, arranged as shown, gave no deflection of ore or bubble with conducting or non-conducting solution. Both ions and charged colloids are susceptible to this treatment, and no doubt they would move easier than the larger body and so lessen the potential on the larger masses.

No. 9. The water itself was electrolyzed to furnish gas. A two-way switch gave either hydrogen or oxygen at the bottom pole, which was covered with a layer of ore. Both gases carried apparently equal amounts of ore and with equal readiness. Bubbles in either case, upon striking the upper plate, did not discharge their burden of ore, no matter what the sign of electrode.

No. 10. Set up as in No. 9, except that gas was furnished by action of nitric acid on ore. Changing of sign produced no discernible effect upon bubble or ore or upon bubbles with load when coming in contact with upper electrode plate.

I wish to point out the fact that this discussion and these results are to be considered only in connection with the bond between a bubble and ore particles. The conditions chosen have been ideal, in order to isolate this particular phase of the problem. Particles of appreciable mass (+ 200-mesh) have been used, but this permits of an electro-static consideration without interference from exaggerated surface conditions due to smaller bodies. It is possible that an ionized solution does not behave like a solid metallic conductor toward an electro-static charge, but I know of no evidence to the contrary. Very little is known regarding contacts between solid-liquid-gas phases, but it is doubtful whether charges such as accompany phases of a colloidal solution are of much influence in the case of bodies of the size herein considered. It may be found that the oil-water emulsion or the oil-films introduce the colloidal element, and no doubt many of the slimes contain colloids, in which the electric charges are of great importance. It is known that masses of sulphides, such as galena, are positive, but

Assume edge of cube to be		Number of cubes.	Surface.
1	cm.	1	6 cm.
0.1	"	10^3	60 "
0.01	"	10^6	600 "
0.001	"	10^9	6,000 "
0.0001	" (one micron (μ)).....	10^{12}	6 sq. m.
0.0005	" (size of particles in kaolin suspension)		
0.00001	= micron	10^{15}	60 " "
0.01	micron (limit of ultra-microscopy). ..	10^{14}	600 " "
0.001	" = one millimicron ($m\mu$)... ..	10^{21}	6,000 " "
0.1	$m\mu$. = hydrogen molecule.....	10^{24}	60,000 " "

these same sulphides in colloidal form are negative. Metals in mass and as atoms are positive but these also as colloids are negative. This complicates considerably the electrical theory in the case of pulp containing both sand and slime. It may be interesting to call attention to the enormous increase of surface produced by subdivision, in which case phenomena that are purely superficial are greatly enhanced.

When it is considered that these small particles contain the energy necessary to subdivide them, whether electrical or otherwise, it is apparent that phenomena encountered throughout a range in size of particle body will not bear a direct ratio to its mass or constituent material. A consideration of this phase of the subject is, however, without the scope of this paper, which is only given to point out a few of what would appear to be misapplications of the laws of electrostatics.

ON THE SCIENCE OF A FROTH

By WILL H. COGHILL

(From the *Mining and Scientific Press* of February 26, 1916)

The paragraph on the character of froth in Mr. Callow's article in the *Mining and Scientific Press* of December 4, 1915, page 852, led me to refer to some notes that have been pigeon-holed for some months. I think that a little mathematics can be applied to good advantage.

Before taking up the mathematics, however, I wish to mention some principles that I think have not been sufficiently emphasized in the articles on flotation; that is, a distinction between the properties of aqueous and non-aqueous films.

The little book on 'Surface Tension and Surface Energy' by Willows & Hatschek shows how the elastic film analogy in the study of froth will get one into no end of trouble if not handled with care. It is the characteristic of analogies to break down when pressed too far, though they are useful up to a certain point. This one is no exception. In the case of india-rubber it is obvious that a given weight can only stretch this to a definite extent. To further enlarge the rubber film, an additional weight would be required; while with a liquid film this is not true. Reference to a recent article¹ shows that the measure of surface tension is not when the film breaks but at the instant when the wire is pulled away from AB . If the wire is pulled

¹T. A. Rickard, *M. & S. P.*, Sept. 11, 1915. See page 127.

a great distance without breaking the film, the total energy of the surface is increased, of course, but the energy per unit-area and surface tension are unaffected. Whether or not the film breaks, depends not upon the surface tension, but whether or not there is enough liquid to supply the added area. The difference between a non-aqueous substance and a liquid film is, that in stretching the former the molecules are distorted or separated while in stretching a liquid film molecules come from within the liquid to occupy the new area. According to Devaux² the surface tension phenomenon disappears as soon as there is no more liquid to come from within. The same laws apply to surfaces that are allowed to contract. The rubber has a constantly decreasing force of contraction as it approaches its original dimensions, while a liquid film always tends to contract with the same force independently of its size. Now, it is a common practice in demonstrating physical principles to omit certain qualifying conditions until the main features are outlined. This method must be pursued here. The qualifying statement is, that, in the case of a contaminated liquid the film may not "contract with a force independently of its size;" that is, after learning to look upon surface tension as a constant force we must now view it as a variable force. Take, for example, the explanation of the effect of oil on waves.³ When a small wave is formed on the surface of water the surface is stretched; for obviously the wavy surface has greater area than the plane surface. Owing to the stretching of the surface the oil film is made thinner so that the contamination due to oil is reduced, and hence the surface tension is increased; this increase in surface tension tending to oppose the production of the wave.

Again, Edser⁴ discusses variable surface tension under the heading 'Stability of a Liquid Film.' He shows that when a film is on a vertical rectangle⁵ equilibrium is impossible unless the surface tension is greater at the top than at the bottom of the film. This is obviously due to the weight of the film itself. For pure water, the surface tension is nearly constant, and therefore, a water film more than two or three millimetres in height cannot be formed. A slight trace of grease will give the water a variable surface tension; if the surface tension at any point on the film is insufficient to produce equilibrium, the film

²'Oil Films on Water and on Mercury.' *M. & S. P.*, July 31, 1915.

³J. W. Watson, 'General Physics,' page 113.

⁴Edwin Edser, 'General Physics for Students,' page 348.

⁵The cut of the rectangle was shown in the article previously referred to in the *M. & S. P.*, Sept. 11, 1915.

stretches at this point, and the concentration of grease is diminished, so that the surface tension increases automatically and equilibrium is maintained.

He concludes by saying that the great stability of a soap film is due to the wide variation in surface tension between freshly formed and long exposed parts of the surface and that any stretching of the film, due to insufficient strength, immediately increases the surface tension. Now it seems to me that it is time for us to get away from the idea that low surface tension *per se*, is necessary for the formation of a froth, for Edser has made it clear that the contamination of the film with something that will give a variable surface tension is the essential. To be sure this amounts to reducing surface tension because contamination of water, with some exceptions, has this effect. The attorney who discoursed at great length upon surface tension and said that the longevity of a bubble was increased by decreasing the contractile drawing force of surface tension, was merely riding too far the willing horse that many of us have ridden so freely.

It is quite easy to accept the statement that soap contaminates water enough to afford a variable surface tension, but it is not quite so clear how a very small fraction of 1% of oil will give the same results, until we have considered adsorption.

Adsorption has been described several times in the technical journals but I believe I am justified in taking it up again and quoting from 'Surface Tension and Surface Energy,' because here we find the generalized statement describing adsorption in a liquid and its effect on surface tension. It says: "If the dissolved substance diminishes the surface tension of the solution, an excess of concentration in the surface layer diminishes surface energy. If on the other hand, the solute increases the surface tension the surface energy will be reduced if the concentration in the surface layer is lower than that of the bulk of the solution. This difference in concentration between the surface layer and the bulk of the solution is called adsorption and is a physical fact. The factors tending to produce adsorption are opposed to the factors tending to establish uniform concentration. The final distribution of a solute is the resultant of adsorption and two other effects, namely, osmotic pressure and electric charge. Important qualitative conclusions are drawn from theoretical considerations already developed. A small quantity of dissolved substance may reduce the surface tension very considerably, but it can only increase it slightly. Thus, sodium chloride increases surface tension of water to a small extent; the concentration in the surface layer is accordingly

smaller than in the bulk, and the effect of the solute is thus partly counteracted. On the other hand, many organic salts reduce surface tension, and therefore accumulate in the surface layer; so that in extreme cases, the whole of the solute may be collected there and produce a considerable effect, although the absolute quantity may be exceedingly slight."

Adsorption is of such unmistakable importance that we will refer to 'The Chemistry of Colloids' by W. W. Taylor for a different perspective of the same thing. Here I quote freely, for I am not intending to advance my own theories but to bring out what seem to me to be the pertinent physical facts. And here I wish to state that I fear that the premise for my recent calculation^o of the carrying capacity of the surface of a liquid is not correct. It was an attempt to elaborate on a weak statement in a text-book and hence the calculations themselves cannot be credited.

Adsorption, in its most general sense, implies the unequal distribution of substances at the boundary between two heterogeneous phases: solid-gas, solid-liquid, and liquid-gas. We are concerned just now with only the last.

The surface layer of a liquid is under great compression due to the great difference of the molecular forces on the two sides of the interface and consequently the concentration in the surface of a solution must be different from that in the bulk of the liquid. For just as unequal temperatures in a dilute solution cause an unequal distribution of the solute, so from the same law unequal pressures must also produce an unequal distribution. This pressure (due to surface tension) always, in time, adjusts itself to the minimum, for a component which lowers surface tension is always increased in the surface layer whether the component be present as solvent or solute.

We now have a new principle to apply to a bubble, to wit: on account of adsorption a fresh surface always has a greater surface tension than an old one; thus if it is stretched locally by conditions tending to break it, it is automatically reinforced at that point.

It is now obvious that without adsorption it would be impossible to realize a variable surface tension, for if the solution were contaminated uniformly throughout, a fresh surface exposed by the stretching of the film would have the same energy as the old surface and the ultimate result would be identical with the case cited where pure water was used.

In this argument I have assumed that the contaminating substance

^oPage 158.

is soluble in water. I realize fully that many of the flotation oils are said to be insoluble in water, but I maintain that solubility is only relative, and further, we know nothing about the multiplicity of chemical reactions possible in a pulp which might release contaminating substances that would produce the adsorption phenomenon. If graphite, for instance, acts as a frothing agent, it might have to be treated as a special case and could not be taken as proof that the above arguments are invalid. If the flotation oil is extremely insoluble in, and lighter than, water there would be an oil film at the liquid-air interface and over the liquid film containing adsorbed oil. It might be well at this point to drop the subject of variable surface tension and undertake to get a better idea of the absolute value of these forces. One physicist has spoken of them as being enormous.

As far as surface tension is concerned it is theoretically possible to blow a soap bubble as big as a house.

Take the formula:

$$(1) \quad P = \frac{4T}{r}$$

Where T = pull due to surface tension in grams of a film of one surface and 1 cm. long.

P = excess pressure inside per unit-area, and r = the radius of the sphere.

This formula takes into account the pull on both the internal and external surfaces. It needs no demonstration, as it is derived in the same manner as the old familiar formula used in calculating the thickness of boiler-shells, etc.

In case of a liquid drop or a bubble submerged in water, the formula is:

$$(2) \quad P = \frac{2T}{r}$$

Now let us use these formulae to make a little study of the mathematics of a bubble to see how much a variation of surface tension and external pressure amount to when numerically expressed and see if Mr. Callow's argument is good.

He states: "The bubbles * * being generated under a hydraulic pressure varying from 15 to 40 inches, on rising above the water * * burst by reason of the lower surrounding atmospheric pressure." This pictures the emerging bubble as expanding like a bladder when suddenly inflated by increased internal, or decreased external, pressure, and is a misconception. To make the steps more simple we will first study the bubble in air and then when submerged.

Assume 1 cc. of free air taken in form of a sphere

$$(3) \quad V = 4.2r^3 = 1 \\ r = 0.620 \text{ cm.}$$

Now suppose this air to be enclosed in a liquid film in air where the liquid-air surface tension is 70. The new radius can be calculated by the application of Boyle's law, which is, that the pressure varies inversely as the volume, where absolute pressure is of course understood. The free air is, in round numbers, under a pressure of 1000 gm. per sq. cm. and a surface tension of 70 dynes per cm. exerts a pull equivalent to weight of approximately 0.07 gm. per cm. of length.

The proportion used to calculate the new radius is:

$$1000 : (1000 + \frac{0.28}{r}) :: 4.2r^3 : 1$$

$$(4) \quad 4200r^3 + 1.176r^2 = 1000 \\ r = 0.619$$

$$P = \frac{4T}{r} = \frac{0.28}{0.619} = 0.453 \text{ gm. per sq. cm.}$$

The second term of equation (4) is the only one that contains a function of surface tension, and since it is of such small numerical value, it is plain that any variation of surface tension has very little to do with the radius of an individual bubble in air. Even when the surface tension varies between zero and a maximum, as in (3) and (4), the change of radius is, in fact, too slight to be calculated on the slide-rule—only from 0.620 to 0.619 cm. It is interesting to note that P has a value of 0.453 gm. per sq. cm. which equals 0.006 lb. per sq. in. This is the order of magnitude of the forces that cause a spray above the froth.

Suppose again that the bubble is 1 cm. below surface. We then have:

$$(5) \quad 1000 : (1001 + \frac{0.14}{r}) = 4.2r^3 : 1$$

$$r = 0.618$$

$$P = \frac{0.14}{0.618} = 0.226$$

Total pressure $1 + 0.226 = 1.226$ (gauge)

Finally take a depth of 75 cm.

$$(6) \quad 1000 : (1075 + \frac{0.14}{r}) :: 4.2r^3 : 1$$

$$r = 0.561$$

$$P = \frac{2T}{r} = \frac{0.14}{0.561} = 0.250$$

Total pressure $= 75 + 0.250 = 75.250$ (gauge)

These results are shown in the appended table:

ONE CUBIC CENTIMETRE FREE AIR

No.	Description.	r	P	Gauge pressure.	Absolute pressure.
3	Free air	0.620	0.000	0.000	1000.000
4	Liquid film in air	0.619	0.453	0.453	1000.453
5	Submerged 1 cm.	0.618	0.226	1.226	1001.226
6	Submerged 75 cm.	0.561	0.250	75.250	1075.250

Column *r* shows that a bubble emerges with an infinitely small change of radius. In fact the change is on the side of decrease because of the surface film being doubled. Now, since there is practically no expansion or contraction upon emerging from the liquid, it seems to me that "low surrounding atmospheric pressure" has nothing to do with bursting Mr. Callow's bubbles. Of course it is well known that if a gas bag is burst under water the gas remains under confinement; whereas if it is burst in air it is evanescent, but it is necessary for the metallurgist to study the texture of these bags.

Since a bubble does not expand, how are we going to account for "4-inch bubbles"? By coalescence (unless electrification plays a part). Sometimes they cohere but do not coalesce. When they coalesce the large one robs the small one because pressure varies inversely as the radius (see Equation 1). The little one 'pumps' its gas into the large one. We shall have to learn how to control coalescence.

Viscosity is another important factor that must be considered along with variable surface tension and coalescence. It is not surface tension that breaks bubbles, but it is blows upon a surface that lacks viscosity or toughness and variable surface tension, that cause rupture. They rupture easily on account of lack of friction of the molecules. With low friction a blow is likely to cause the molecules to be separated a distance at which surface tension phenomena disappear before other molecules have time to come from below and reinforce the area with their greater surface tension.

The books all emphasize the importance of great superficial viscosity and small internal viscosity for the persistence of a froth. It is said that alcohol which has a superficial viscosity less than the internal viscosity, when mixed with superficially viscous liquids, will neutralize the relative surface viscosity and make frothing impossible. Hence the practice of adding a few drops of alcohol to check frothing in pharmaceutical work. We know that tannin sometimes interferes with flotation work and also that it may form a colloidal solution with water. May we not add that alcohol and tannin are deterrents because adsorption is checked on account of internal viscosity produced by them? For, without adsorption, one of the leading factors tending

to produce a stable froth is nullified, that is, variable surface tension.

My best thanks are due to Dr. W. B. Anderson, professor of physics in the College, for his helpful suggestions and critical reading of these notes.

SMELTING FLOTATION CONCENTRATE

(From the *Mining and Scientific Press* of February 12, 1916)

In the November issue of *Teniente Topics*, the monthly publication of the Braden Copper Co., Chile, a member of the staff briefly outlines the development of the smelter from 1909 to the present time. Metallurgical difficulties have been many, but were overcome, in spite of being 6000 miles from the base of supplies. The plant now treats 350 tons of concentrate daily, yielding 60 tons of copper, during which operation 60 tons of coke and 10 tons of fuel-oil are burned, employing 350 men and 1500 hp. This quantity of concentrate is recovered from 4000 tons of ore crushed per day. The concentrate consists of 19% copper, 17% silica, 23% iron, 2% lime, 8% alumina, and 28% sulphur. It is sandy and slimy, and contains 20% water. Of the 350 tons of concentrate, about 215 tons is dumped from V-shaped steel cars into bins, which supply the nodulizing kilns. This concentrate is then fed to conveyor-belts, thence into kilns, heated by oil-burners to a temperature of 1750°F. In the kilns, the sandy concentrate is quickly heated by the burning of the oil, and also by the combustion of a part of the sulphur content, to a sticky consistence, in which state the rolling motion tends to ball it into nodules of varying size. The kilns are sloped an inch per foot toward the discharge-end, out of which the red-hot nodules pour onto an endless chain of cast-iron pans, which convey the product to hoppers ready to charge into the blast-furnaces. The nodules have about the same chemical content as the original concentrate, except that the proportion of sulphur has been reduced from 28 to 18%, and, of course, the moisture has been evaporated.

A by-product of the nodulizers is flue-dust, that is, a small proportion of the concentrate blown out by the draft in the kilns and caught in dust-chambers, removed, and hauled to the bins for re-treatment.

Another 50 tons of the original concentrate is sent to bins that discharge to the sinter-plant, of four units. Each unit is a concrete box, 4 ft. wide by 50 ft. long. In place of a top there is a cast-iron grate similar to that of a stationary boiler, but with smaller air-

holes. An exhaust-fan is connected to the box, creating a strong down-draft of air through the grate. A 4-in. layer of raw concentrate is spread on the grate with an inch layer of saw-dust ignited with kerosene or gasoline torches, after the fan has been started. The saw-dust starts the combustion of the sulphur in the concentrate. This then continues to roast for an hour, when the sulphur is reduced to 12% and the loose layers are reduced to a hard cake. The cake is broken into pieces six to eight inches in diameter and raked into ears that go to the blast-furnaces.

The remaining 85 tons of concentrate received daily is discharged into bins, thence fed by conveyors into ears directly to the blast-furnaces; this amount being smelted raw.

The two blast-furnaces are 25 and 30 ft. long, respectively, 4 ft. wide, and 9 ft. deep, with hollow-steel water-jackets. The furnaces are fed with a charge consisting of varying proportions of nodulized, sintered, and raw concentrates, together with converter-slag (containing 60% iron) as a flux, and coke as fuel. The proportion of coke to concentrates averages about 15%, and is dependent directly on the amounts of raw and nodulized concentrates. This mixture gradually sinks in the furnace, becoming hotter and continually melting, until in the bottom it is liquid at a temperature of 2500°F., and runs into the settler. The matte, containing 45% copper, 30% iron, and 25% sulphur, remains in the settler until removed through a hole near the bottom and poured into the converters through a brick-lined launder.

The converters are of the Pierce-Smith basic-lined type. Each consists of a horizontal cylindrical sheet-steel shell 25 ft. long by 10 ft. diameter, inside of which is a lining 18 in. thick of magnesite brick. This material is not attacked by the chemical reactions in the converter, and consequently lasts for a long time, unless allowed to over-heat. The cylindrical converter-shell rests on heavy rollers, and can be revolved around its axis so as to empty its contents through a hole in the side when necessary. The converter is pierced by a horizontal row of blast-pipes through the sheet-steel and lining, for the entrance of compressed air. These holes are in a line parallel with the axis of the cylinder somewhat below the centre-line, and point down toward the bottom of the converter. A large hole in the top receives the charge of matte, and serves as a chimney for the escape of gases.

When ready to receive a charge, the converter is revolved until the mouth is under the end of the matte-launder leading from the

settler mentioned; this position places the tuyeres at about the centre-line of the cylinder. A stream of matte is run by gravity into the mouth, until the converter is filled almost to the level of the tuyeres. There is also added a small amount of quartz. Compressed air at 10 to 12 lb. pressure is then forced through the tuyeres and the converter is revolved until the tuyeres are submerged about 12 in. under liquid matte.

The elimination of the iron and sulphur leaves practically pure copper as the only remaining constituent of the matte; after 12 hours of alternate blowing-in air and pouring off slag a bath remains of 25 to 30 tons of molten copper. This goes into ladle-ears and is hauled to a receiver, which is simply a huge brick-lined kettle capable of lifting and pouring its contents into a series of moving cast-iron molds.

The copper solidifies, is removed, and carried to a platform to be loaded on ears for shipment. This final product is known as 'blister' copper, on account of large blisters or bubbles of gas formed on the surface of the bars while cooling. The bars run 99.5% copper, and average 220 pounds in weight.

FLOTATION ON DUMP ORE

(From the *Mining and Scientific Press* of December 11, 1915)

The Editor:

Sir—On the eve of my departure from Australia I received a copy of your issue of July 31, in which considerable prominence was given to the subject of flotation; and it has occurred to me that the following may be of interest to some of your readers.

Early last year I was commissioned to re-organize the work of the Lloyd Copper Company at Burruga, New South Wales, and, upon my arrival there, found that the concentration mill had been equipped recently with tube-mills and a flotation unit. I need not go further into the description of the plant than to state that when I assumed command the output of the mine and of the smelters was limited by the capacity of the mill, which was not working as well as it should have been doing. Attention was, of course, first given to the mill, which so well responded to the efforts made that before long it outstripped the supply from the mine, which was suffering sadly the consequences of lack of development. In the meantime I had made laboratory tests with regard to the flotation of the tailing lying on the dumps and had also sent away samples for trial at the experimental works. The results obtained from all sources showed that the sulphide in the tailing had become so oxidized that it had become totally unsuited for the ordinary process of flotation. However, before finally dropping the matter, I decided to give the tailing a bulk test and fed it to the mill during the ordinary course of crude-ore concentration. By this procedure I obtained such satisfactory results that dump-tailing was put through the plant with the crude ore whenever a shortage of the latter was anticipated. In order to find out definitely what recovery was being made from the dump-tailing, apart from the mixture of tailing and crude ore, an eight-hour run on tailing by itself was taken in hand. For the first two hours of the run everything went satisfactorily; but afterward the froth began to thin, and, finally, at the end of four hours there was no flotation at all, the particles to which the flotation bubbles were attached rising only part way to the surface in a manner similar to that which I had observed in my initial experiments on the flotation of zinc-blende by the Potter process at Broken Hill in 1902. The addition of sulphuric acid and other chemicals to the eucalyptus oil, which formed the frothing medium, had no beneficial effect.

At the end of four hours crude ore was put into circulation in the mill again; and very shortly afterward frothing recommenced, with the result that the flotation of the mixture of crude ore and tailing proceeded satisfactorily. Similar results were obtained during all the subsequent trials.

As my records are stowed away in the hold of this steamer, I am not, at the present moment, able to give accurate figures as to the recoveries obtained.

In smelting the flotation concentrate great losses were at first encountered. A big proportion by weight was lost in the roasters and again when the calcined concentrate was charged into the reverberatory furnaces. Clouds of calcined flotation-concentrate could be seen issuing from the top of the chimney-stack whenever the feed-hoppers containing the calcine were opened and the charge dropped into the furnaces. All kinds of devices were tried to overcome these losses, but they proved unsuccessful. As a final resort the 'green' concentrate, after having been well drained, was fed through the side doors (the rabbling doors) of the reverberatories and this procedure was ultimately adopted with satisfactory results. As the reverberatories frequently got ahead of the output of the mine and mill, they were, from time to time, used as roasters by being fully charged with 'green' flotation-concentrate and run with open doors for several hours until calcination had been completed.

I may add that at the works of the Wallaroo & Moonta company it has been found convenient to add to the top of each charge in the blast-furnace a definite quantity of 'green' flotation-concentrate, which sinters as the charge sinks and reaches the solidified stage before entering the strong blast area.

V. F. STANLEY LOW.

R. M. S. *Ionic*, October 1.

SIMPLE PROBLEMS IN FLOTATION

(From the *Mining and Scientific Press* of February 19, 1916)

The Reader:

Sir—On another page Mr. Durell objects to a statement of mine in regard to the floating of an ungreased needle on water. He is measurably right. An ungreased needle will float, but not nearly so easily as the greased one. The latter will float if placed on the water without special care, but if the former is handled in the same way it will sink. My reference to the matter was quoted from the 'prior art,' which in this regard, as in many others, I know now to be a dangerous guide. Some time ago, but since my first writing on flotation, last summer, I made several experiments to find out for myself what happens. To be certain that the needle was free from grease, I dipped it in a hot solution of washing-soda and then dried it, taking care to use a clean cloth and to not touch it with my fingers. Then I placed a piece of tissue-paper on the water in a cup and laid the needle upon it by aid of a pair of pincers. The tissue-paper was depressed into the water, becoming wetted gradually, until it was all soggy and finally sank, leaving the needle floating. Without such care I could not make the needle float.

Next I used the camphor test to ascertain if the water had been contaminated by grease. If camphor is whittled with a knife above the water, the shavings will dance on the water in a life-like manner suggesting insects in a fit. This phenomenon, as shown by Marangoni, is due to the dissolving of the camphor, preferably at its pointed end, where a maximum surface is presented to the water. The solution decreases the surface tension of the water in contact and thereby causes the uncontaminated water, with its stronger tension, to pull away from the spot affected by the camphor. In order to produce this activity of the camphor, the surface tension of the liquid must be greater than that of the camphor solution. Hence if grease be introduced into the water, thereby lowering its surface tension, the camphor becomes inert. If, while the camphor particles are active, the water is touched by a greasy finger (all fingers are a little greasy) the camphor becomes quiet immediately. This furnishes a good test for the presence of even a trace of grease. No ordinarily 'clean' cooking utensil is sufficiently free from grease to allow an exhibition of the camphor dance.

To return to the floating ungreased needle. I introduced some

camphor shavings, and they were lively. Then I repeated the experiment with a needle that was slightly greased, and the camphor seemed to be unaffected thereby. Finally, I smeared the needle with olive oil: an iridescence on the surface of the water indicated diffusion of the oil. This time the camphor chips fell dead on the water, and remained wholly inert. Apparently, therefore, the needle will hold to itself a limited amount of oil or grease, which adheres so selectively as not to contaminate the water. But any excess of oil, more than the needle can hold, will be set free to modify the water and lower its surface tension.

Of course, there is a limit to the size of needle that can be floated. When the needle is floating it lies in a dimple or depression; if the needle is so heavy as to overcome the surface cohesion, the sides of the depression meet, and the needle is engulfed in the water. Bubbles of air can be seen attached to the needle when floating. The film of air is not continuous. Apparently the flotation is due to the resistance of the water surface to rupture, this resistance being caused by an elastic force that permits the water to yield in the form of a dimple. Moreover, the air bubbles add to the buoyancy, both by their less specific gravity and by preventing the curved walls of the dimple from meeting overhead, that is, by widening the angle of contact. As the proverb says, "oil and water will not mix;" the adhesion of air to a metallic surface is matched by the molecular repulsion between the oil and the water.

As Mr. Durell suggests, the fact that grease is not essential to the floating of the needle is symptomatic of the trend of the flotation process. The oil is important chiefly as a means of lessening the surface tension of the water and so yielding air bubbles that will last long enough for the work of buoying the mineral particles.

Permit me to continue to disagree with Mr. Durell as to the negligibility of viscosity in the formation of froth. In quoting Daniell, I was not so out of date, for the reference was to the edition of 1911. We shall hear more about viscosity in the near future.

In regard to the attachment of previously formed bubbles to metallic particles: this point has been elucidated by the cinema record of experiments presented in the Miami case. Apparently such bubbles do attach themselves to the metallic particles, even when un-oiled.

In regard to the experiment described and discussed by Messrs. Durell and Norris, I have tried it and I recommend every student of flotation to try it, watch it, and cogitate on it. If kerosene oil is

poured over colored water and air is blown into the lower liquid, a number of interesting phenomena can be observed. Mr. Durell sees bubbles enclosed in a film of the colored water rising through the oil and breaking at the surface, while the colored water of the bubble-film drops back through the oil exactly as a balloon on bursting drops to the earth. Mr. Norris conducts the experiment in two stages; in the first, he blows air gently and sees colorless bubbles rising from the colored water through the oil to the surface; he says that these bubbles show no trace of color, and they are unaccompanied by a return passenger of colored water. He concludes that the bubbles have no film, but are simply holes in the water and oil successively. In the second stage of his experiment, he injects air with greater pressure, making larger bubbles, which pull the colored water to the surface of the oil. The bubbles are not colored, but they take with them flat portions of the colored water, which fall back when the bubbles reach the surface of the oil.

I have conducted the experiment many times, and my report is as follows: When the air is injected into the oil, the bubbles are short-lived, but they last long enough to prove, as we know already, that the oil is not a pure and perfectly homogeneous liquid. In such a liquid, bubbles would not survive. The fact that two bubbles can touch without coalescing proves that there is a film or membrane separating and surrounding them. When I blow air gently into the colored water, the rising bubbles are colorless. They accumulate at the surface of the oil, and show an attraction for each other, and for the sides of the glass vessel. These bubbles appear to last longer than those blown in the oil. Next, when I inject air more rapidly into the water, a bubble appears at the point of a cone or mound, as if it were dragging the water-surface with it. This bubble will remain poised for awhile at the peak of the mound of water before breaking away and rising, while the water falls back. If the air be injected still more rapidly, the bubble breaks through the water-surface, appearing to tear it, and takes with it a portion of water. This is attached to the south pole of the bubble and may accompany it to the surface, where, on arrival, it drops away in a curious crescent form. If I introduce air still more rapidly, the water-surface is torn into pieces of odd shape by the rising bubbles.

The bubbles in oil are round or spherical; those generated in the water, as seen in their passage upward through the oil, are flattened; they are oblately spheroidal. The colored-water drop that leaves the south pole of the bubble, on its arrival at the surface, is also flattened:

if small, it is crescent-shaped; if larger, it is oblately spheroidal or lenticular.

It will be noted that I have said that this and that "appears" to take place. The difference in description by various observers indicates how difficult it is to see correctly. These are truly 'phenomena,' or appearances that are unusual and hard to explain.

As to Mr. Norris's idea that the bubble is simply a hole in the liquid, I would suggest that a globule of air takes to itself a film when in an impure liquid, that film containing some impurity or contaminant in concentratable form. Thus the hole becomes a sac. As the colored water and the kerosene are both impure liquids, we may infer the existence of a film on the globule of air, as indeed is proved on its arrival at the surface, where bubbles remain in contact without coalescing. The next question arising is as to what change the film of the bubble undergoes in the passage of the bubble from one liquid into the other. The watery film would, I suppose, be affected by coming in contact with the oil, and it would seem to me *a priori* that the bubble would arrive with a film of the liquid having the lower surface tension. This is a point I would like to refer to our friends, Messrs. Ralston, Durell, Norris, and Coghill, all of whom have contributed so generously and so usefully on the theory of the subject. That theory is no mere academic exercise; it is at the very base of any reasoned understanding of the flotation process.

T. A. RICKARD.

San Francisco, February 11.



INDEX

	Page		Page
Absorption	346	Bulk-oil flotation	145
Adsorption	347	Oil methods	130
Acid, effect of.....	131, 157	Butters, Charles. Cyanide treat- ment of concentrate.....	203
Flotation method	147	Flotation of gold ores.....	276
For preferential effect.....	259	Treatment of concentrate.....	59, 89
Sludge	69	Caldecott cones	254
Used at Anaconda	106	Callow, J. M. Notes on flota- tion	231
Acidity of pulp.....	229	Callow cell	106, 204
Adhesiveness of oil and water.	182	Capacity of	239
Agitation, froth method.....	149	Flotation of copper ores....	65
In Pachuca mixer.....	235	Machine	242, 243
Air, adhesiveness of.....	14, 15	Method	67
Adhesion of bubbles to par- ticles	187	Patents	48
And bubbles	343	Plant at Inspiration	88
Bubbles	198	Testing machine	294, 298
Contact, metallic particles..	201	Campbell, D. G.....	227
Froth flotation	159	Camphor test	356
In flotation	268	Canby, R. C.....	33
Introduction of	153	Capacity of Callow cell.....	239
Used in Elmore process.....	25	Capillarity	10
Alkalinity	93	Carbonates, effect of.....	265
Effect of	318	Case machine	305
Allen, Glenn L. Testing ores for flotation	277, 293	Case School of Applied Science	258
Anaconda Copper M. Co....	51, 106	Cattermole, A. E.....	40, 71, 193
Anderson, W. B.....	351	Method	29, 113, 149
Arizona Copper mill	236	Patent	41
Australian practice	320, 354	Chalmers & Williams mill....	84
Treatment of flotation residue	255	Chapman, G. A.....	114
Bacon, R. C.....	185	Chlorination applied to flota- tion concentrate	220
Bains, Thos. M., Jr., Electrical theory of flotation....	225, 258	Clennell, J. E. Cyanide treat- ment of concentrate.....	203
Bailantyne, W. H.....	273	Coagulation	149, 246
Blende, preferential flotation..	259	Coal-tar products	239
Block, James A.....	244, 324	Coghill, Will H. On froth....	344
Why is flotation?	187	Surface tension	154
Boyle's law	349	Colloidal impurities, effect of..	245
Braden copper mill	351	Concentrate, cleaning of.....	286
Bradford method	18	Concentrate, silicious	55
Bradford, L. process.....	81	Smelting of	351
Bubble and air particles.....	343	Treatment of	59, 89
Bubbles, armoring of	133	Conductivity, electrical	338
Electrification of	226, 338	Contact angle	182
Bursting	13	Copper ores	48
Formation of	358	Sulphate	266
Of carbon dioxide.....	279	Cost of flotation	99, 243
Surface tension of.....	313	Of test machine	298

	Page		Page
Coutts, J.	302	Flotation:	
Courtney, C. F.	113	At Anaconda	106
Cresylic acid	62, 94	At Broken Hill.....	29, 319
Crushing before flotation.....	58, 84, 120	At the Central mine.....	110
Fine sulphide	291	At Mt. Morgan	53
Cyaniding and flotation, treat- ment after roasting.....	207	By acid	37, 279
Cyaniding raw flotation con- centrate	221	By agitation-froth	281
Daly-Judge mill	238	Cells in series	237
De Bavay method.....	24, 323	Classified	33
Deister concentrators	89	Concentrate, cyaniding	203
Delprat, G. D.....	37, 147	Concentrate, raw cyaniding. 221	
Process	320	Concentrate, chlorination of. 220	
Density of pulp	238	Effect of soluble component. 263	
Of surface film.....	183	Electrical theory	225, 258
Dielectrics	228	Electro-statics of.....	335
Differential method	142	History of	231
Disposal of residue	248	In Australia. 29, 47, 110, 151, 319	
Dorr thickeners	106, 254	In a Mexican mill.....	91
Draining flotation concentrate	248, 252	In Mexleo	267
Drucker, A. E. Flotation of		Of copper ores	65
gold ores	224	Of gold ores. A. E. Drucker. 224	
Dump ore, flotation of.....	34	Of gold ores	276
Durell, C. Terry. Flotation		On dump ore	354
principles	319	Pneumatic	233
Why do minerals float?.....	175	Preferential	71, 258
Electric charges	185	Prime requisites	136
Electrical conductivity of sul- phides	227	Principles	319
Theory	185, 245, 258, 335	Process, the	9
Elmore, Francis E.....	36	Recovery at Mt. Morgan....	53
Machine	294	Selective	332
Method	25, 34, 150	Simple problems	356
Process in Australia.....	54	Smelting of concentrate.....	351
Elmore vacuum process	34, 44, 145, 321	Testing ores	277
Emulsification	13	Tests	92
Everson, Carrie J.....	35, 145, 190	Theories	244
Fahrenwald, F. A. Electro- statics	335	Use of lime	265
Film, insulating	228	v. cyanidation	99
Filtering concentrate	248	Flow-sheet of Inspiration mill. 89	
Flotation, a paradox.....	267	Fouling of solution.....	263
Air-froth	159, 189	Froment, Alelde	39
		Patent	272
		Process	148
		Froth and flotation.....	102
		Agitation, discovery of.....	118
		Character of	241
		Destruction of	331
		Disposal of	303
		Early attempts in Australia. 110	
		Formation	237

Page	Page	Page
106	Froth and flotation:	Lyster process 77
29, 319	Relative persistence 31, 170	Machine 287
110	Science of 344	Macquisten method 144
53	Frothing 281	Tube 19, 278
7, 279	Gabbett mixer 200	Magistral mill 267
281	Gas, use of 139	Marcy ball-mill 85
237	Effect of 325	Mathewson, E. P. 106
33	Glass jar machine 295	Mexican mill, flotation in.... 91
203	Greenway & Laury method.... 79	Miami experimental plant.... 161
221	Grinding for tests 300	Method 33
220	Handling of slime 257	Process at 167, 169
263	Hardinge mill 84, 106	Mickle, Kenneth A. 15, 141, 324
258	Haynes, William 34	Minerals Separation... 54, 269, 275
335	Hebbard, James 29	And Froment 40
231	Flotation at the Central mine 110	Basic patent 30, 42
319	Machine 87	Machine 86
91	Higgins, Arthur H. 149, 153	Organization 29
267	Hoffman's results 180	Patent ... 150, 152, 163, 167, 272
65	Hoover machine... 49, 287, 288, 289	Plant 122
224	Hoover, T. J. 47, 158, 322, 331	Royalties 50
276	Horwood process 75	Mitchell, D. P. 48
354	Hyde, James M. 31, 48, 290	Molecular forces 308
233	Hyde's patent 150	Morning mill 233
258	Hydrates, effect of..... 265	Motherwell, Wm. Flotation at
136	Hydrogen-sulphide gas 188	the Inspiration mine..... 83
319	Ingalls, W. R. 14, 19	Flotation at Mt. Morgan ... 53
9	Inspiration Consolidated C. Co. 51	Moulton, J. C. 114
53	Mill 234	Mount Morgan, flotation at... 53
332	Mill, power consumed..... 241	Nascent, definition of..... 325
356	Mine, flotation at..... 83	National copper mill..... 68, 232
351	Oil used at 69	Needle, floating of..... 326, 357
277	Janney, F. G. 283	Norris, Dudley H. 187, 323
92	Flotation machine... 146, 281, 283	Flotation, a paradox..... 265
44	Test-machine 285	Molecular forces 308
65	Kenyon, W. H. 197	Patent 45, 269, 274
99	Kirby, E. B., patent..... 44, 147	Nutter, E. H. 48
89	Krupp ball-mill 121	And Lavers patent 78
53	Laboratory work 299	Occulsion, definition of..... 328
39	Lead ore, preferential flotation 259	Of gas 140, 176
72	Liebmann, Adolph 33	Oil, consumption of..... 70, 240
48	Lime hydrate method..... 265	Bulk methods 130, 145
2	In flotation 265	Function of 330
8	Use of 101	Pine 63, 241
1	Litigation 159	Proportion of 16, 43
1	Lloyd's Copper Company..... 354	Substitutes 153
3	Low, V. F. Stanley..... 355	Oiling of mineral particles.... 322
0		Oils 94, 123
7		

	Page	Page
Oils:		
Creosote	241	Silica in concentrate
Solubility of	348	Silver ores, treatment of.....
Testing of	301	Slide machine
Used in flotation.....60, 153,	239	Smelting concentrate
" at Mt. Morgan.....	56	Smith, Ralph
" in Wood machine.....	280	Soap-bubbles10, 132, 16
Oliver filters	108	Soluble component, effect of..
Osmosis, description of.....	332	Salts
Owen, T. M.....	294	Spitzkasten, shape of
Testing machine	296	Stability of film
Patents	34	Sulitelma plant
Physics of flotation	9	Sulman, H. L.....
Picard, H. F. K.....	33	Sulman & Picard patent.....
Pine oil	63, 241	44, 14 ⁹ , 153, 16
Oil as frother	239	Sulphates, effect of
Pneumatic flotation	233, 294	Sulphonation
Potter apparatus	38	Surface compression
Charles V.	37, 147	Tension.10, 126, 138, 162, 183, 34
Method	23	" effect of
Power for flotation machines..	241	" in bubbles
Preferential flotation	71	" measurement.11, 127, 153
Psychology of flotation.....	47	" and salts in solution. 154
Raiston, O. C. Preferential		Swinburne, J.
flotation	71	178
Testing ores for flotation..	277, 293	Tension, interfacial
Why do minerals float?....	175	Testing machines285, 287,
Ramage, A. S.....	73	288, 291, 293, 295, 296, 298
Reinders' researches	178	Tests, separating funnel
Revett, Ben S.....	9	Thickeners for concentrate....
Rickard, T. A.....	344, 359	Thickeners for draining con-
The flotation process	9	centrate
What is flotation?.....126, 144		253
Roasting flotation concentrate.	213	Tonnage treated by flotation..
Robson, George	36	9
Roiker, Chas. M.....	151	Towne, R. S.....
Royalties	50	Towne-Flinn plant
Avoidance of	275	Tunhridge patent
Salt, effect of.....	103	191
Salts in solution	154	Vacuum method
San Francisco del Oro mill....	145	27
San Sebastian ore	208	Viscosity
Saponine, effect on froth.....	14	129, 329, 350
Scott, Walter A. On air-froth.	159	Wallaroo & Moonta.....
Separatory funnels for testing.	293	355
Shellshear, W. Disposal of		Washoe Reduction Works.....
residue	248	106
		Water, electrification
		340
		Wentworth, H. A
		73
		Williams, Henry D.....
		189
		Wood, H. E.....
		20, 21
		Wood machine
		280
		Method
		145
		Oils used
		69
		Zinc separation from galena..
		See preferential flotation

	Page
.....	55
t of.....	91
.....	291
.....	351
.....	290
.....10, 132, 160	160
ffect of..	263
.....	94
.....	282
.....	345
.....	28
.....	149
ent.....	
149, 153, 164	164
.....	264
.....	61
.....	308
162, 183, 344	344
.....	177
.....	313
.....11, 127, 158	158
olution..	154
.....	326
.....	178
285, 287,	
295, 296, 298	298
el	318
rate....	250
ng con-	
.....	253
tation..	9
.....	48
.....	87
.....	191
.....	27
29, 329, 350	350
.....	355
ks.....	106
.....	340
.....	73
.....	189
.....20, 21	21
.....	280
.....	145
.....	69
elena..	
al flotation	

