

# • Massey's Illustrated •

(PUBLISHED MONTHLY.)

## Mid-Winter Number

New Series, Vol. 4, No. 2.]

[Toronto, February, 1892

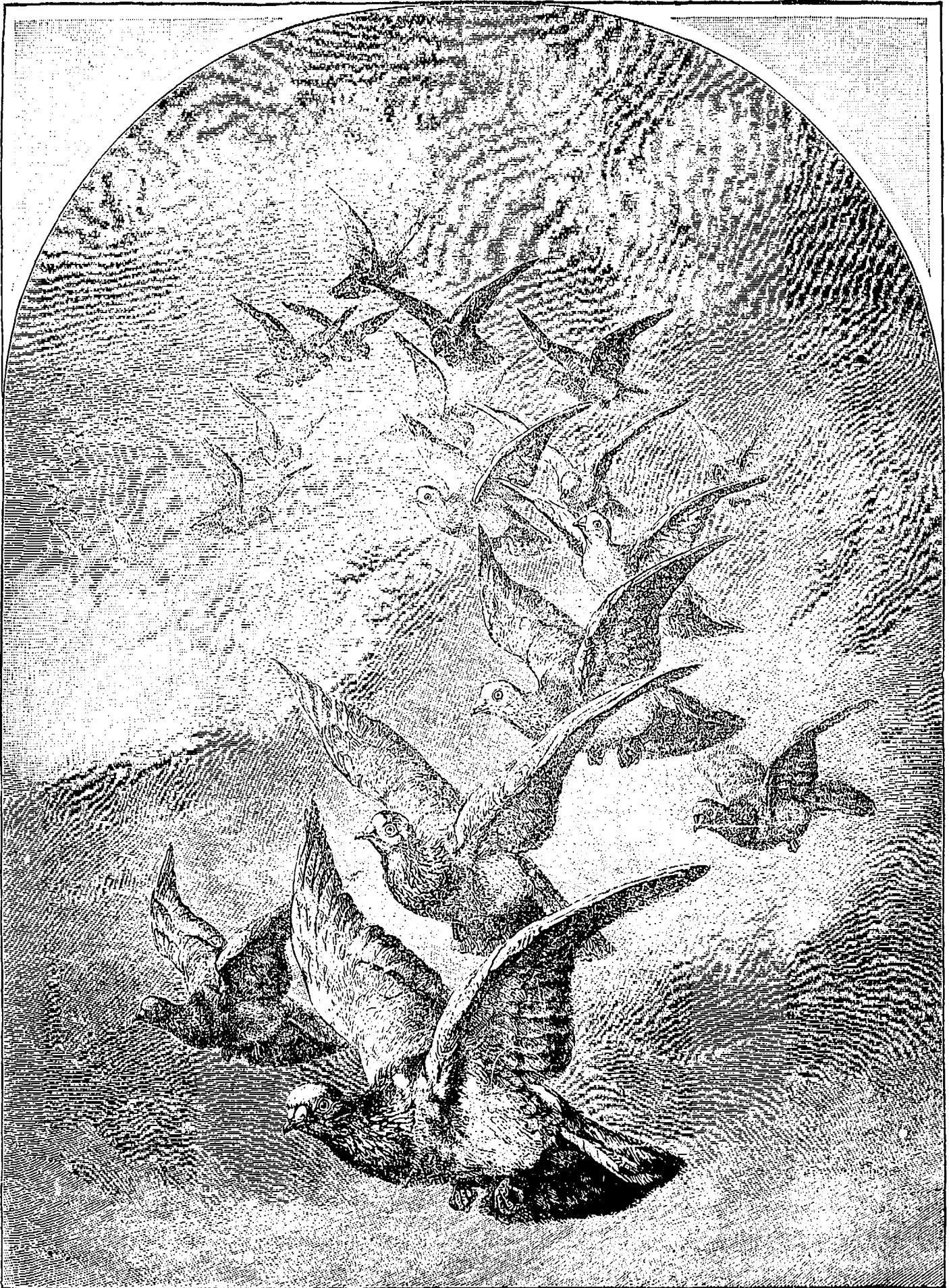

**SUBSCRIPTION PRICE** 50c. PER ANNUM  
5c. PER COPY

# TORONTO MOWER

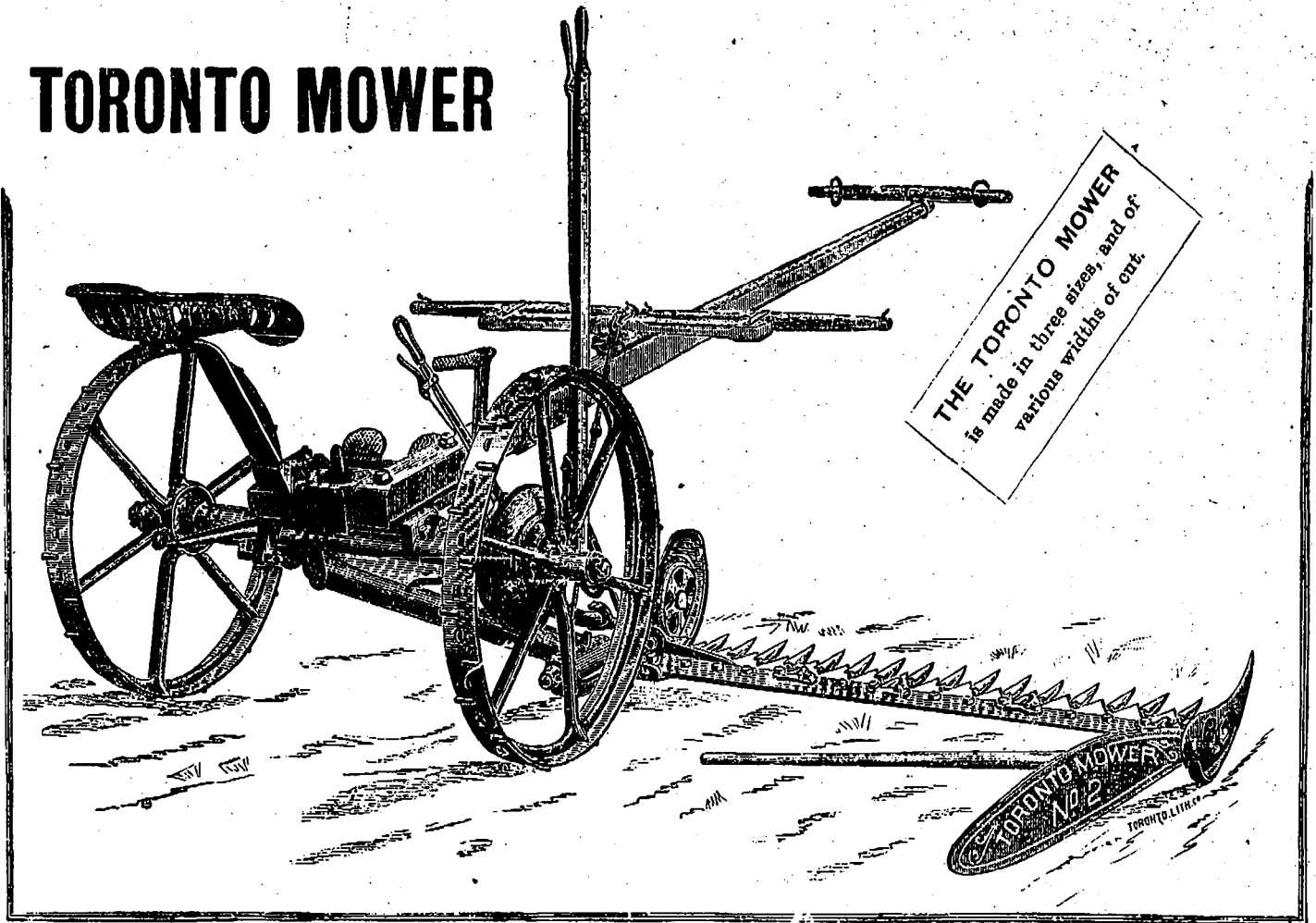

THE TORONTO MOWER  
is made in three sizes, and of  
various widths of cut.

# BRANTFORD NO. 3 MOWER.

FRONT VIEW.

MADE TO CUT 4 FT. 6 IN. AND 5 FT. 6 IN., AND WITH  
2½ IN. OR 3 IN. SECTIONS AS PREFERRED.

THE BRANTFORD MOWER.  
IS MADE  
BOTH FRONT AND REAR CUT.

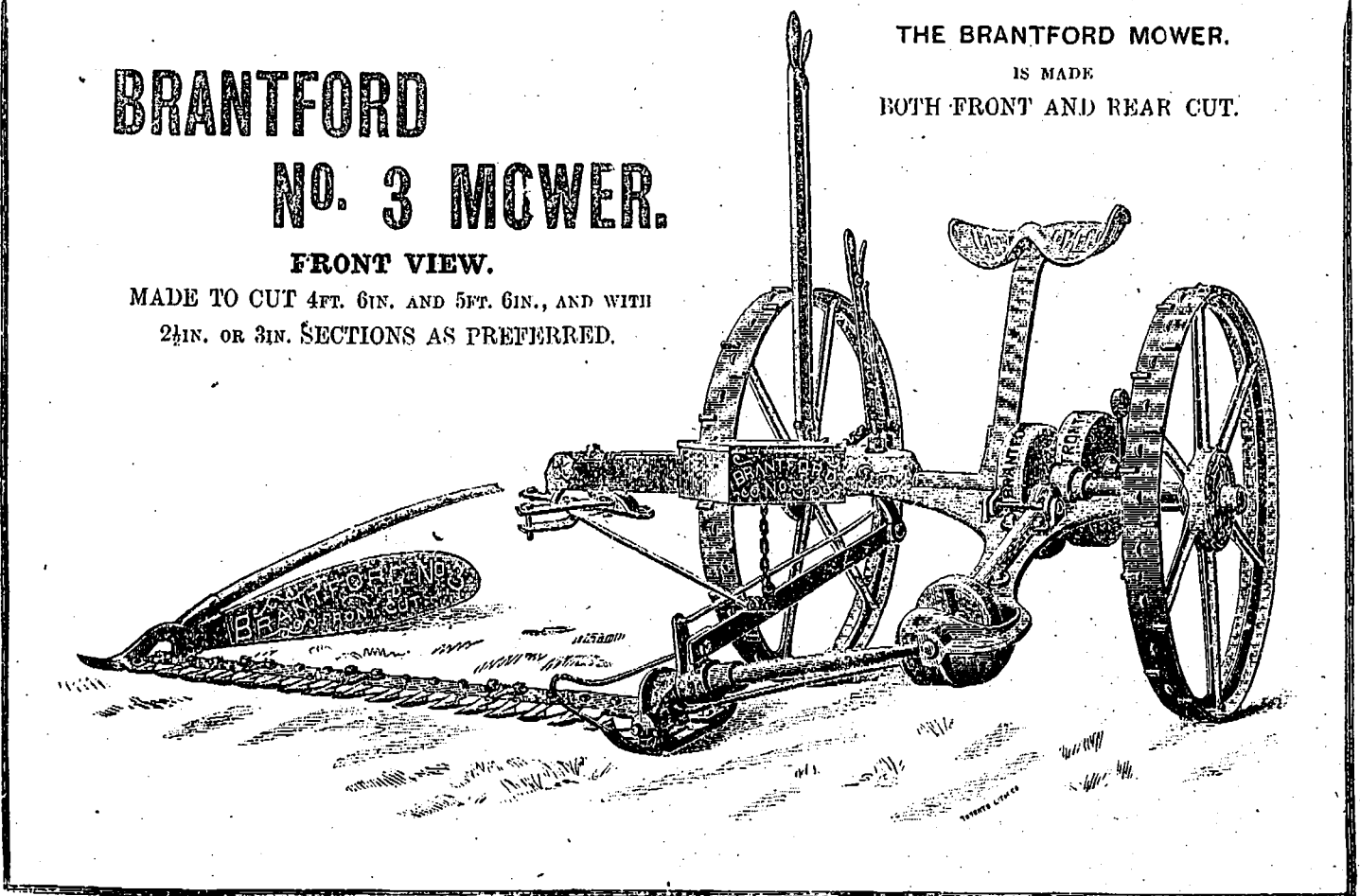

Massey-Harris Co., Ltd., Toronto, Can

# Massey's Illustrated

(PUBLISHED MONTHLY.)

A Journal of News and Literature for Royal Homes

New Series.]

TORONTO, CANADA, FEBRUARY, 1892.

[Vol. 4, No. 2.

Original in MASSEY'S ILLUSTRATED.

## An Old Maid's Diary.

### CHAPTER II.

WELL, I did laugh in my sleeve when Deacon Trim drove up to our door. I knew he'd been hangin' round widow Jones for a spell last winter, and folks did begin to say he was wantin' to finger her money, for he gets the name of bein' rather fond of money. Well, my sister-in-law, she jest showed him right into my settin' room when he asked for me, and of course, I couldn't help showin' him a chair, and she soon run off saying her baby was a-

cryin' and so I talked about the weather a bit. He was mighty good-natured, and admired my flowers, for I had fuchsias and geraniums in the windows, and sweet Williams, and roses and peonies outside.

"You seem so comfortable here, Miss Benjamin, there's no need of you gettin' married," he says.

"Who said I was gettin' married?" I asked

"No one," he said, "but it's not impossible. Such a smart woman as you, might get a husband any day."

"I s'pose so, if I was lookin' for one and would take any leavin'," says I.

Deacon looked confused and said, "'Twouldn't be necessary in my case," and tried to change the

subject, but I had something on my mind and watched a chance to come at it.

"Are you fond of strawberries, Miss Benjamin?" I had to say "yes," and he chimed in, "Well, my Lottie thinks a heap of you for a Sunday school teacher, and she's set on havin' you come out to tea while strawberries are ripe. Little Minta has asked her school-teacher to come over and Lottie said you should come too. Any day you set, I suppose 'll do."

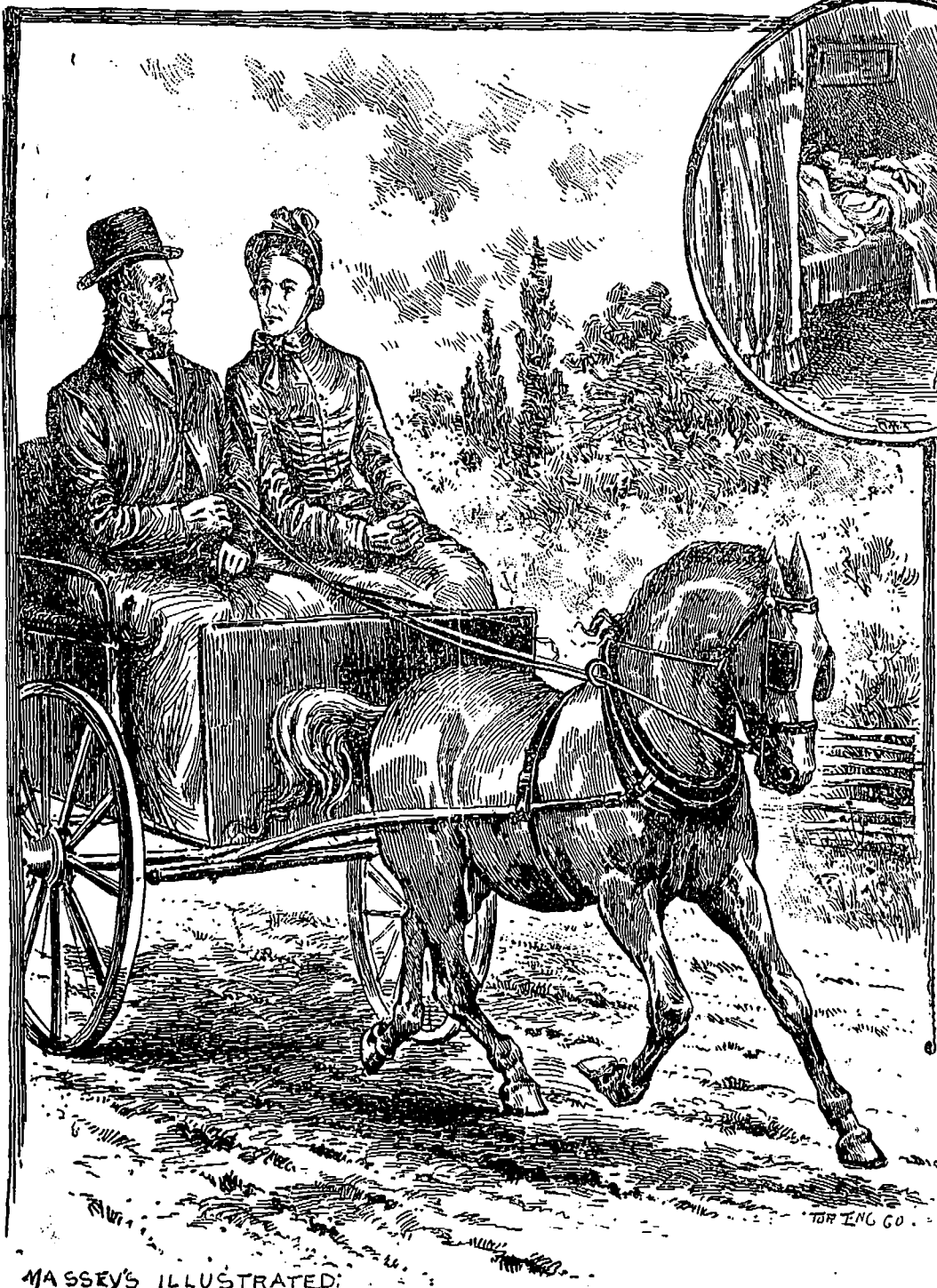

"Well," said I, "its very good of Lottie, for the child's got more'n she can do in that big house."

"Well, we've got Sally Brown you know, and she's a tarer to work."

"Yes, but there's too much responsibility for such a young girl as Lottie."

"I suppose there is," with a big sigh.

Then it struck me he might think I was speakin' for myself, instead of his sister-in-law, so I said.

"Yes, if she had an aunt that could overlook things for her 'twould be only right."

"Yes, I've been thinkin' of findin' some suitable person," he said.

I thought of widow Jones, and felt things gettin' serious, so I said: "Well, Deacon, you may tell Lottie I'll come this week. Let's see—to-day's Monday, washin' day; Tuesday is ironin' day I suppose, and perhaps Wednesday is bakin' day."

"I don't know," he said.

"But I do, you see. I don't want to make things inconvenient for them young girls. I'll come a Thursday if that'll suit."

"That'll suit," he said, and then I thought 'twas he and not Lottie as wanted me, but not to be uncharitable I held my tongue and went.

Well, I'd no more'n got my things off and walked round the garden with Lottie, than we saw Miss Davis coming across the pasture with Minta. I was just telling Lottie she could have a root of my peony in the fall, and that I had a young fuchsia rooted that she might have for the window. I saw

MASSEY'S ILLUSTRATED:

"WHY DON'T YOU ASK YOUR BROTHER'S WIDOW?"



she hadn't many flowers and was delighted with the bouquet I took her. She had promised me a slip of the white roses that badly needed prunin'.

I had almost forgot about Miss Davis again, till we heard her singin' some school-song with Minta, and she soon appeared lookin' so rosy and jolly. "Just the one to brighten up Lottie," I thought, and before long, I had said something of the kind, and they laughed so heartily over it, I believe it did make them better friends, for they were soon walkin' around with their arms round each other, and 'twasn't long before we were all in the strawberry patch, and we didn't leave it till time for Lottie to help get tea. The Deacon seemed quite pleased to see us, and admired my bouquet that Lottie had set on the table; but I was glad Miss Davis was so ready witted and good at keepin' conversation going. I couldn't help thinkin' "What a nice place for poor Mary Trim, (his sister-in-law) and her boy. The Deacon hasn't a son and 'twould be such company for the girls too. And Mary such a good hand at makin' pies and such like."

Well, when it come time to go home, the Deacon insisted on drivin' us. Miss Davis laughed and said she could run across the fields, but he said 'twas damp, and wouldn't be just proper, so she said no more, perhaps thinkin' of it that her way was part mine too. I persuaded Lottie and Minta to come too, for a drive, and gave them the fuschia and a geranium in flower, not thinkin' the Deacon might take encouragement from it till I saw how pleased he was. I had asked Lottie to drop in sometimes and see me and so, bein' a timid a likin' company, she took to callin' for me to go to Sunday school, and sometimes she and Minta walked down from church with me and the Deacon would stop and take them up as he passed. And so we got quite friends and people sometimes smiled as I passed with Lottie on my arm, but I didn't mind it, for some of the rest of my class begun to come too. If anyone tried a joke with me I turned it pretty sharply without lettin' them know I took the hint, and so no harm was done. I didn't mean to go out again, but Lottie coaxed so hard for me to come out in cherry time, and as the minister and his wife were goin' out I managed to go with them. We had a real nice time and I promised to go out again to show Lottie how to do a quilt. Somehow I couldn't refuse, especially as she said she couldn't have regular quilting. When we was drivin' home the minister began jokin me about bein' a deaconess and I up and told him I didn't believe in woman deacons, and he said, "Not unless they marry deacons."

I said, "When I marry a deacon you'll know it." He hoped he would, so I told him he was fishin' for fees.

Well, 'twasn't long before the deacon was obliged to be away on business, and Lottie asked me to go out and stay with her. I'd just been gettin' some hints I didn't like, and had a little collectin' to do, so I asked her if she hadn't better ask her aunt Marion. Poor child! I was sorry for her right off. "Why Miss Benjamin, I couldn't, father hasn't spoke to her for five years,—and—and I'd rather not."

So I promised at once to stay as long as I could, and supposed Miss Davis would stay at night when I couldn't. You see I'd no right to say a word against her father to her, and Lottie seemed so grateful, but I meant to "hide my time." I found out the deacon was goin' at noon, so I walked out in the cool of the afternoon. Miss Davis run over after tea and was persuaded to stay all night. After breakfast we got out the quilt, and I made myself quite at home, and told Lottie not to make company of me, and I worked hard at it all day. The girls helped me some, and so we got on pretty yell. I was afraid the Deacon might come home that night or early next morning, and as Miss Davis had promised to come over to tea, I hoped to get off.

But she sent word she couldn't come, and about teatime down came the rain, so that settled it. Next morning it was no better, and so I got at the quilt, and right at dinner-time in came the Deacon.

Of course, he insisted on me stayin' till the rain stopped, and then would drive me home. I mistrusted what was comin' and was not at all surprised when he up and told me in his matter-of-fact way, that he thought I'd make the best step-mother for Lottie, and he'd long ago made up his mind if I was willin'. Then I spoke my mind, and I says, "Why don't you ask your brother's widow, Marion Trim, to go and keep house for you? She's poor and would be glad of a situation, and you couldn't find a more capable person." "Exceptin' yourself of course," he said.

"No, Deacon Trim, not exceptin' myself. And think what a help Willie would be on the farm."

He winced a little and said he'd think of it, if I was decided, and I told him I was. We'd just got to our gate, and Rev. Baker, (our minister) passed and made some remark about the rain.

After that I didn't go out to the Deacon's, though I made no difference with Lottie, and I always had some good excuse to offer her, and made her acquainted with some nice young girls of her own age.

One day early in the fall, I dropped in to see a sick child, and met my friend, Rev. Mrs. Baker. "Miss Benjamin," she began at once, "I want you to go with me to Deacon Trim's. I hear he is very ill."

"I'm sorry for that," I said. "Lottie was not at Sunday school, and I meant to call, but—"

"I'm surprised you've delayed then. Something must be done to help Lottie. Can you go with me this afternoon?"

I thought of Marion, but said nothing then. A neighbor-woman was there but couldn't stay, and the doctor said 'twas a serious case of fever, and required careful nursing. We stayed as long as we could for Lottie's sake, and drove home late in the evening. I couldn't forget poor Lottie's tired, pleading look, and says I, "Something must be done, Mrs. Baker." "Yes," she says. "It's a shame to have Lottie alone—besides it's dangerous! If anyone could take the responsibility and engage necessary help." "I know of no suitable person," I says.

"I didn't mean just that, you know, but I'm really anxious about the deacon, and believe it absolutely necessary that an older head than Lottie's should have the management. Pardon me, I don't mean to quiz, but would your connection with the family warrant your taking hold for awhile?"

"My connection?"

"Yes! if there's anything between you and the Deacon."

"But there ain't! Only that I've refused him!"

"Oh! I'm sorry you've refused. But what would you suggest?"

"Well," says I, as bold as a lion, "I'd just go right to Marion Trim, and ask her to go out there and stay."

Well, Marion agreed to go, if I'd go with her. So next morning Mr. Baker drove us out real early, and by night she was quite at home like and acquainted with the girls and the ways o' the house, and I came home with Doctor Reid.

Well, the Deacon kept pretty bad for several weeks, and Marion stayed right on and kept things quiet and orderly, and won a world o' praise for her nursin'. Deacon was out of his mind for a good part o' the time, and sometimes talked about his dead brother and sometimes about foreclosin' a mortgage, and talked of makin' it up to him, and wishin' he hadn't foreclosed. And then he seemed to remember he was dead, and said something about Marion and his brother's boy, but didn't know she was there.

Her Willie was staying at the minister's and fetched their cow and run errands, but every day he was sent out to the farm, and sometimes stayed for hours huntin' eggs and doing what he could and the girls told me they wished the deacon'd let him stay always. Well, Deacon improved, and Marion talked of leavin' but Lottie wouldn't bear to it. So she kept out of his sight and stayed on till he was able to go out to the settin' room, then Mr. and Mrs. Baker arranged a little surprise party to welcome him like. There was just the family, and me and the doctor. And of course Marion and her boy, and Mr. and Mrs. Baker was there.

Well, he was surprised to see us all, and when Doctor Reid introduced Marion as the one that had saved his life, he pretty near fainted. Then the tears came into his eyes, and he shook hands with them both and said they should never want a home

while he lived; and then we all sung 'Thanksgivin' Hymns, and Marion almost cried, and everybody seemed thankful and happy.

I never heard anyone call the Deacon stingy after that, for he adopted Willie for his own, and Marion made her home with them.

Well, I never let 'em know that 'twas me that interfered, but when I see how happy and comfortable they all seem, I feel thankful that I'm still an old maid instead of Mrs. Deacon Trim.

To be Continued in our next.



## That Girl.

NEVER in all my life did see the like of that girl! I don't believe there's another of her sort in all California. I hope not, anyway!

Mrs. Fromer stood in the doorway of her rude little cabin and looked with interest and disapproval up the mountain road. There was nobody but little four-year-old Jerry for her to talk to, and he was too busy to pay any attention, but with the performances of "that girl" for a subject Mrs. Fromer must talk.

"There! Did anybody ever see anything to equal that? Why, she just got onto that dog's back and made him jump over that rock as if he was a horse. What in the world is she up to now? Well, I do declare."

Quite overcome by astonishment and dismay, the woman had to stop talking for a moment, and stood in breathless silence watching the strange goings on which had so upset her mind.

And no wonder, for the pranks she was witnessing were enough to make any woman with fixed ideas of propriety feel a little faint and giddy. It might be supposed that Mrs. Fromer would have become used to such pranks by this time, but she had not. Nobody did become used to them, it seemed. Consequently Hilo Mountain, although it was not a volcano, was always in a state of disturbance, because "that girl" was continually doing something extraordinary.

Just now, without knowing—or caring—that she had a spectator, she was rehearsing a sort of Wild West show in the rocky road a little way above the Fromer house. There were only two performers—herself and the immense dog she always had with her—but they were so active and versatile and made so much noise that they were more than satisfactory.

It was amusing to see the little midget—she was only thirteen and small for her age—playing Indian and scout, and stage driver, and giving a really good imitation of each. And she went at her fun with such spirit and enthusiasm that no looker on could help being excited in sympathy.

The dog, a great St. Bernard, was quite as enthusiastic as his mistress, and was full of the spirit of the occasion. It was evident that he saw no impropriety at all in this business. He gave it all the assistance in his power and was wonderfully intelligent in his performances.

Suddenly the girl stood upon the dog's back and balanced herself there with the skill of a monkey while the creature scampered up and down the road, leaped over rocks and did many other break-neck things. The girl held a stick in her hand, which she pretended was a gun, and at short intervals she "made believe" to fire the weapon, giving at the same time an Indian whoop.

It was this feature of the show that had caused Mrs. Fromer to exclaim and to hold her breath. It had also attracted the attention of little Jerry Fromer. At once the child was filled with admiration, and ran out into the road to join the fascinating party.

His mother caught and brought him back, not without loud protests on his part. The girl heard his outcries and understood them. She came racing to the house door in the hope of securing another playfellow.

"Let me have him just a little while!"

She was panting and flushed and eager; her eyes sparkled, and her face was bright and animated. In spite of her unkempt black hair and her torn clothing she looked very pretty and childish then, and there was certainly nothing vicious in the straight look of her pleading eyes.

"Let me have him," she said again. "I'll take right good care of him, and he'll have loads o' fun. Ranter'll be right glad to have him, too."

This last was meant as the highest compliment that could be paid. Any little boy whom the big dog was willing to accept as a playmate was honored indeed.

Jerry kicked in his mother's arms and held out his hands to the girl, and begged to go with her, but his mother held him close and moved a step further away.

It was a movement of dislike. The girl understood it. She drew back as if from a blow, and she stopped coaxing, while her face lost all its bright animation. She was a very sensitive tomboy, apparently.

"Rilly!"  
All turned in a startled way to see that Pete Pelter was standing beside them, with a look in his face that seemed half sad and half angry.

"Why, dad! ye've got back!"

The girl sprung nimbly up and caught her father round the neck, where she clung, kissing his bearded face. The rough mountaineer kissed her in return, just as a better dressed father would have done, and stroked her hair very tenderly.

"All right, ain't ye, Rilly?" he said. "Ranter took good care on ye while I was away? Got to be off again, but I'll be back this evenin'."

He kissed her again and put her down on the ground.

"Now you an' Ranter be off to yer fun. He's the comp'ny you've got to associate with, an' no other!"

The girl and the dog ran away together and the man turned again to speak to Mrs. Fromer.

"I don't want my gal to be intrudin' an' I won't allow her to be intrudin'," he said, with a kind of rude dignity.

"She wasn't intruding. But I will say this, Pete Pelter, you ought to stay home more and keep her in some sort of order. It's too bad, the way she goes on. Why, she's the wors' child on Hilo Mountain."

"There hain't no man would say that to me 'bout my gal!" the father said, roughly. Then he softened his tone, remembering it was a woman he spoke to.

"Ye're wrong 'bout Rilly," he continued. "She ain't the wust child. She's the best child, the lovin'est, generousest, bravest, best child that's goin'. It's her way that makes ye think different, an' ways depends on p'int's an' view. Rilly ain't so bad, bein' rough, as some is bein' smooth. Ef her mother wus livin'—wall, she showed what she'd 'ave done when she gave her that purty name, Amarillo. She'd 'ave made her the purtiest behaved child on the mountain. But no other woman don't bother!"

Mr. Pelter made an awkward bow and walked off toward his cabin, and Mrs. Fromer went into the house to think it over, leaving little Jerry outside. She was very glad that he had so soon forgotten Rilly's invitation and his own disappointment.

No child on the mountain—or off the mountain, for that matter—was quite so good as little Jerry Fromer. His father believed it and his mother knew it. He made no trouble at all, but amused himself in all sorts of pretty little ways, leaving his busy mother free to attend to the great amount of work which every housekeeper—even in a mountain cabin in California—always finds to do.

Almost always the weather permitted him to play out of doors, so that he was far happier, as well as far healthier, than if he were shut up in the house. And as he never thought of running away, this was all very satisfactory to the mother. Sometimes she did not have to look after him from noon until supper time.

This afternoon was one of those fortunate times. All through the long, pleasant time of sunshine the careful housewife was left undisturbed to work and think. She thought most of her own child, of course, but she thought a good deal about Pete Pelter's child also. Perhaps people were a little too hard on Rilly, after all. Perhaps if the neighbor women would only take a little more friendly interest in her, she would not be such a rude little

ruffian. Really she never knew of the child doing anything actually wicked. But she was such a rowdy.

At length she noticed that the sunshine had grown dim. Evening was coming and Jerry's father would soon be home, and she must bring the little fellow in and make him neat, as she always did for the father's home coming.

She went to the door, but Jerry was not where she had left him. She looked quickly about, but her child was nowhere in sight. She called; no answer came. In a panic she ran all about the house, and up and down the road, calling as she went; neither sight nor sound of her child could she gain. Little Jerry was lost!

"That girl! That dreadful girl!" Mrs. Fromer moaned, as she realized that her baby was gone. "But, then I would have heard her if she had come about."

Desperate and heartbroken she continued her fruitless search, growing more and more excited with every minute. When Mr. Fromer came home he found his wife so nearly frantic that he could hardly learn from her what had happened.

It was a terribly thing when he did learn and realize it. There was no knowing how long the child had been gone, but with darkness coming swiftly on he would have time before he could be found to get hopelessly lost in the forest that was

not so very far away. He might be wandering there even now; and it was no safe place for a little child to wander. To say nothing of the dangers of starvation or exhaustion, wild beasts were not unknown there. More than once or twice mountain lions had been seen or heard not very far from the little scattered settlement.

Very quickly Mr. Fromer satisfied himself that his child was indeed gone, and he was about starting away to summon the neighbors to help him in the search, when Pete Pelter appeared. There was trouble in his face and anxiety in his voice.

"Was Rilly here ag'in atter I left ye?" he asked.

"No."

"She ain't to hum, an' I ain't been able fur to find her, an' I'm oncesy 'bout her, it must be 'lowed."

"Have you lost your child, too?" Mr. Fromer exclaimed in astonishment. "I was just coming to ask you to help find ours. He's gone, God knows where!"

He stopped speaking with that break in his voice which it is always so hard to listen to. Even in his own grief and trouble Peter Pelter felt keen sympathy with this other bereaved man, and was about to say so, but another exclamation from Mrs. Fromer checked him.

"That girl!" Jerry's mother cried out. And it was easy to know from her tone what she was thinking of.

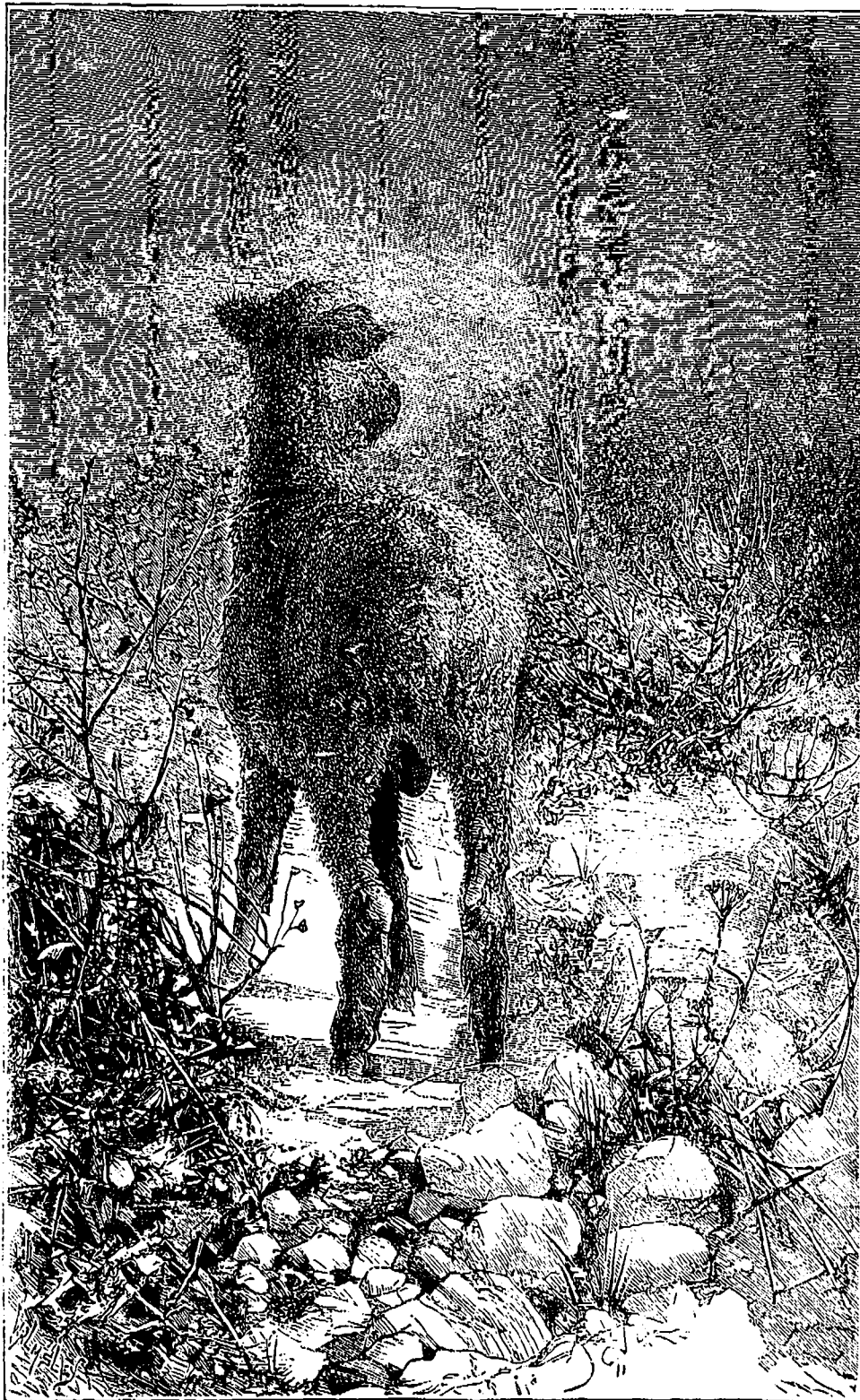

Her husband laid his hand on her shoulder and stopped her from saying more. Mr. Pelter heard the words and noted the movement, but he only said:

"I'll help ye to hunt fur yer child. I kin hunt fur mine later. Or mebbe we'll find 'em together. I reckon that's most likely."

All night long these two men, with the help of all the other men in the settlement, searched the forest with torches for their lost children, but found no trace of either of them. One little bit of information was given by a man who came to join the searching party.

In the afternoon, while on a shoulder of the mountain near the settlement, he had stopped to look down at the houses and the road. He saw a little child going along the road toward the forest. He thought that was not safe, so he started down the slope to capture the little rover. He was a good while getting to the road, and when he got there he saw only Rilly Pelter and her dog. He asked her about the child he had seen, but she only looked at him and started off toward her father's house. Thinking he had been frightened without reason, the man had gone his way without giving any alarm.

"What time might that ha' been?" asked Peter Pelter.

"'Bout three o'clock, I reckon."

"I war home jest afore that. Left right afterwards."

All the next day the search was kept up, and without success. At night the men were exhausted and had to rest. But the second day the search was renewed with more vigor than ever.

The two fathers kept together through a kind of sympathetic understanding. They were widely separated from the other searchers when they came upon the tracks made by little feet.

A moment later they found larger footprints and those of a dog close to them. The men looked at each other with tears of joy running down their faces and neither was ashamed of his weakness. They dashed forward over the soft, moist ground of the little hollow they were in, not losing sight of a single track. Suddenly Pelter stopped, with a smothered cry of alarm.

"Oh, Lord! Oh, Lord! Look at that?" he groaned, pointing to the ground, where the tracks of another animal mingled with those of the dog. Do ye know what them is? Them's the footprints of a mountain lion!"

It was true. There was no mistaking the nature of those latter tracks.

"You and me know what them marks for both ov us," said Peter, putting his hand on Mr. Fromer's shoulder. Ther hain't no hurry now, for we're too late. So afore we go on to look for our children's bones I want you to apolergise to my Rilly. Right here! Right now! Ye thought in yer heart as she'd led yer little feller off. I knew she didn't. She's give her life tryin' to save him fur ye. How do I know? 'Cause that's natural to Rilly, fur one thing. 'Nother thing, them little tracks was made afore the bigger ones 'nd the dog's. 'Nother thing, the baby was alone when Bill Brown seen him, 'nd Rilly was alone when he seen her 'nd told her 'bout it. An' more'n all that, while I was out o' the cabin after Bill Brown seen her she was there 'nd carried off grub enough to last her 'nd the baby—if she found him alive—till she could get him hum. An now, Jake Fromer, if you don't apolergise fur that insult ye thought I'll kill ye!"

Without speaking Mr. Fromer looked into the other man's eyes and held out his hand. The look and the gesture meant more than the words he could not control himself to speak, and the apology was made and accepted. The two clasped hands, and then went forward in fear and trembling.

Presently they stopped, having almost stumbled over the dead body of a mountain lion. At the same moment a faint, weak whine of recognition sounded close by, and then there was a happy but very feeble cry of welcome, and the two fathers knelt beside their living children.

"I knowed ye'd find us, Dad!" said Rilly. "My leg's broke, 'nd we had to wait. He broke it," pointing to the dead beast; "but me 'nd Ranter kep' him off the kid, 'nd Ranter killed him. The baby's all right. Didn't find him till last night. An' wasn't he hungry!"

With great rejoicing the lost children—and poor, torn Ranter as well—were carried to the Fromer cabin. As Mrs. Fromer was lavishing her tender-

ness and gratitude upon Rilly, Pete Pelter came stood beside her with a triumph in his face that was good to see.

"I knowed we'd find them two kids together," he said. "An' I knowed ye'd change yer p'int o' view 'bout my gal."—*James C. Purdy in Philadelphia Times.*

### The Angel Guide.

THE path of life lay stretching  
Before an eager child,  
Who with his own sweet murmurings,  
The lonely way beguiled.

It was a narrow pathway,  
And flowers of tempting hue  
Bordered its edge, and hid beneath  
A yawning depth from view.

So all unwarned of danger,  
With happy, trustful air,  
The child pressed on—how should he know  
Of peril lurking there!

But when his roving vision  
The fruits and flowers descried,  
They lured him toward the fatal edge,  
And drew his steps aside.

His garb was rent by briars,  
His tender flesh was torn;  
He strove to grasp a flower, and closed  
His hand upon a thorn.

But with the wife before him,  
He pressed yet farther through,  
Till suddenly the craggy steep  
Broke full upon his view.

He started back affrighted,  
He wrung his hands and cried,—  
"Oh, who will come and lead me on!  
I needs must have a guide.

"I shall be snared and tempted,  
Misted and overthrown;  
I cannot keep so straight a path,  
I dare not walk alone?"

"Nor shalt thou, tender pilgrim!  
Behold in me thy guide."  
The sobbing child looked up and saw  
An angel at his side.

"Now turn aside thy vision,  
Now follow where I lead,  
And with thy hand held close in mine,  
Thou shalt be safe indeed."

The little trembler listened,  
With look of sudden calm;  
Then closed his eyes, and laid his hand  
Within the angel's palm.

"Yea, guide me, blessed angel,  
Direct my steps aright,  
And show me it is best to walk  
By faith and not by sight."

—Margaret J. Preston.

For poisonous wounds made by insects such as mosquitoes, etc., apply cologne water.

A box of powdered borax should always be kept on the sink shelf. A little added to the water in which dish towels are washed will help much to keep them clean and at the same time keep one's hands soft and smooth.

For a dairy room floor, nothing is superior to cement; it also serves an admirable purpose in cellars, wash-rooms, stables, etc. There is no secret about laying excellent cement floors. Make an excavation to solid earth, which will probably be nearly a foot and fill with stone or coarse gravel for a foundation. Use a level and square to make the foundation level. Next mix five parts of coarse gravel to one of common cement. Mix dry, then wet slightly and mix again thoroughly. Spread this two inches at a time and tramp until solid. There should be six inches of this; then the floor is ready for the finishing coat, or liquid stone as it is called, three parts of coarse, clean, gritty sand to one of Portland cement, thoroughly mixed. Sift and wet a small amount at one time, and spread an inch in thickness. It should be laid in strips as wide as one can easily reach across with a trowel. To accomplish the work with least trouble, get down on the knees on a board of the thickness that you wish the cement, and with a short straight-edge keep the floor level. After a strip is laid, go over it with a trowel, making it perfectly smooth. Let the floor harden a few days.

## CORRESPONDENCE

Mrs. R. L., Guelph, Ont., writes: I have noticed some letters from correspondents about house plants and their care. I have learned from experience that success or failure in the growing of house plants is largely due to the care and attention paid to watering. Like everything else, what is worth doing, is worth doing well. When plants require water, give it unsparingly. The system to adopt is to be thorough, rather than regular. Many persons water their plants as regularly as they wash their faces, which will not do. A plant should not be watered unless it needs it, and it does not need it so long as the soil contains sufficient moisture for the plant's use; more than that is an injury. Water should never be given until the plants show by the drooping of the leaves that they need it. Then give with a liberal hand, not simply a surface-wetting, but give until every particle of soil in the pot is wet; let it go to the bottom. Many plants have been so long potted that the ball of roots and earth is almost impervious to water. Water applied to such ten times a day, will do but little good; the pots should be put in a tub of water occasionally, and left there for twenty four hours, the pot all under water, then they will get a wetting that is useful and lasting.

J. C. L., BRANDON, Man., writes: The gophers give us much trouble by digging up the seed corn. To check their work it is quite common to harrow the ground as soon as the corn is planted. This does not go deep enough. I use a five-tooth cultivator, with the middle tooth shifted to one side to escape the row of corn. If they are very numerous, I plant deeply with a drill, and run the cultivator over the rows. Some farmers, I believe, poison corn with strychnine, and scatter it on the ground, but this is fatal to many birds. Others put the poisoned corn into the gopher-holes, but this is slow work.

"D'ARCY MCGEE," Sherbrooke, Que., writes: It is deplorable to see farmers cutting down thrifty sugar orchards, which, if spared, would furnish employment at the time of year when there is little else to do on the farm. Such short-sighted farmers sit around waiting for spring to open, while their more thrifty neighbors are making maple sugar which they sell to them for the money they realized from the sale of the timber.

S. H., COLBORNE, Ont., writes: Winter is the time to repair broken tools, instead of leaving it to be done in the hurry of spring work. Broken tools may be seen lying beside the road, which could be rendered available at slight cost. Plows, harrows, crowbars and other tools, are often left in the field where used last, and in the spring the farmer will be inquiring for them and exclaiming that some neighbor has stolen them. It pays to take good care of tools, repair them when necessary, and house them when they are not in use.

Mrs. C. B. R., Trenton, Ont., writes: My vineyard consists of Concord and Warden vines set nine feet apart each way. I shall this spring sow the entire vineyard to clover, which I shall leave uncut, to mulch the ground and check the growth of the vines. I shall spray faithfully as a protection against rot.

Kerosene will take iron rust and fruit stains from almost every kind of goods without injuring the fabric in the least. Pour a little of it into a dish and wash the soiled place in it as if it were water. But bear in mind, the spots must be washed in kerosene before they have been put into soap and water, or it will do no good.



## HARVESTING MACHINERY NEWS

### An Entirely New Idea in Sheaf Carriers.

For many years inventors have been busy endeavoring to construct a sheaf carrier attachment for self-binding harvesters, which would drop the sheaves gently, and leave them in straight and even rows, ready for "shocking" or "stooking" and which could be easily operated by the driver, without tiring him, and taking up so much of his attention that he could still properly look after his team and the general working of the machine.

A number of carriers have been put on the market, more or less successful in some particulars, but the first carrier to completely meet these conditions, is the new Massey-Harris Sheaf Carrier just recently completed. A corps of men were busy experimenting with it during the past harvest, and complete success is now assured. The two illustrations given on this page, will aid the reader to an understanding of its construction and operation.

The carrier is supported from the main frame in a rigid manner, and places no undue strain on any part of the machine, nor does it interfere with the knoter in any way.

It is operated by a treadle, upon which the feet rest, which is illustrated in the cut above the upper part of the elevators of the machine being broken away for the purpose of showing it. A gentle and very easy motion performs the entire operation.

When in position to receive the sheaves as in the view above, the Carrier is "locked," and no pressure is required to hold it in place. It is attached close under the deck. A slight pressure of the foot unlocks it. The first movement is downward to an angle of 30 to 35 degrees, then backward under the deck—all from one quadrant.

It comes back to place easily and quickly, rising as it comes forward without scraping over the stubble, as is the case with low hanging carriers.

In running against a stump or other obstruction, the Carrier unlocks itself, and folds back out of the way without injury.

When folded back the Carrier shuts up under the deck, and in no way interferes with sheaves being delivered—a point never attained in any of the low hanging carriers.

As shown in cut below, the over hanging arm, with teeth for holding the sheaves in place on the Carrier, is hinged at the knoter, and hence can be

### THE New Massey-Harris Sheaf Carrier.

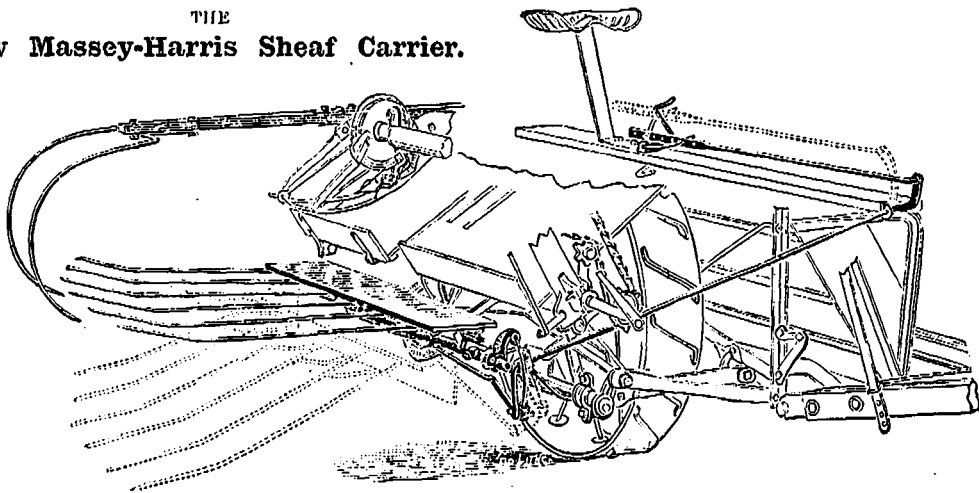

folded back when going the first round, and the machine will then pass through gates and doors, just as readily as though there were no Carrier on the machine.

We feel confident this valuable new invention will be highly appreciated, and it is destined to have a large sale.

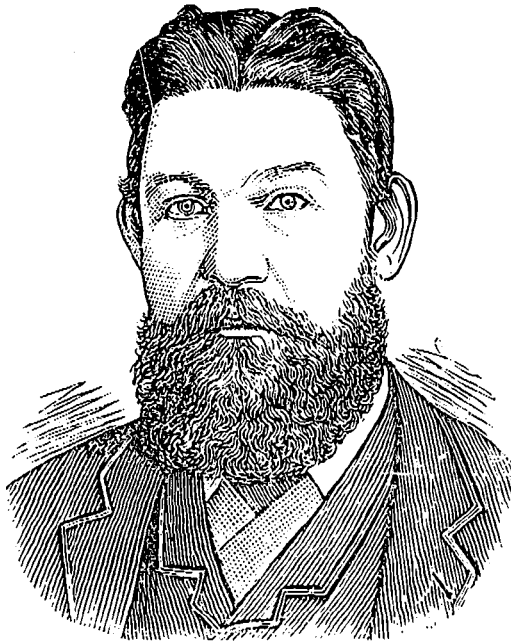

Coenrad H. Loubser.

Who is Coenrad Loubser? This question will be asked by many of our readers, when they see the accompanying portrait. Mr. Loubser is not a

seeker of notoriety, and probably none will be so surprised as himself to see his portrait in MASSEY'S ILLUSTRATED.

He is not an explorer, historian or poet—at least, we have not heard of him as such. Neither is he a great political leader or military officer. "Well, who is he?" you ask.

He belongs to that class of men upon whom the whole world are dependent—and upon whom they are more dependent than any other class for livelihood and progress, and for success in trade and commerce—he is a farmer. "Well," you say, "so are lots of other people farmers." Yes, but this farmer was a pioneer. "Pioneer where and in what?" If it ever comes to pass that you chance to visit the thriving Colony in South Africa, known as Cape Colony, the steamship will land you at Cape Town; and should you journey inland as far as Oortman's Post, Klipheval, your eyes will behold a large and thriving well-kept farm, giving every evidence of a progressive and energetic manager. The owner of this splendid farm is no less a man than Coenrad H. Loubser, who was one of the pioneer settlers of Cape Colony—a country about which and its great possibilities we are altogether too ignorant; for Cape Colony is destined to become quite a factor in the productions of the world's breadstuffs.

As one of the early settlers of that country, by his enterprise, earnest endeavors, and good management, Mr. Loubser owns one of the finest and best equipped farms in Cape Colony. His enterprise and forethought are plainly manifested by his progressive manner of farming for he was a pioneer also in the use of the most improved farm machinery. Were you to visit his farm, you would forget you were eight or ten thousand miles away from home, for there you would see a little bit of Canada—yes, there you will find TORONTO LIGHT BINDERS! and hear the same good words of praise for the splendid satisfaction they were giving that one hears at home.

Mr. Loubser, was the first purchaser of a Toronto Light Binder in South Africa, and the "Toronto" was the first machine used in that country which gave satisfaction. The extreme simplicity of the "Toronto," and the ease with which it can be operated enables the farmers of that far away land to set up, start and operate the machines without any aid beyond the printed instructions placed in the tool box; which has been a great boon to these Colonists.

Mr. Loubser intends adding next season to the number of Binders he has already purchased.

The sales of Massey-Harris machines in the Colony are continually increasing.

LADIES HOME JOURNAL, of Philadelphia. This excellent magazine for the household was accidentally omitted from our Clubbing List, but are prepared to supply it with MASSEY'S ILLUSTRATED for one year at the combination price of \$ 1.50.

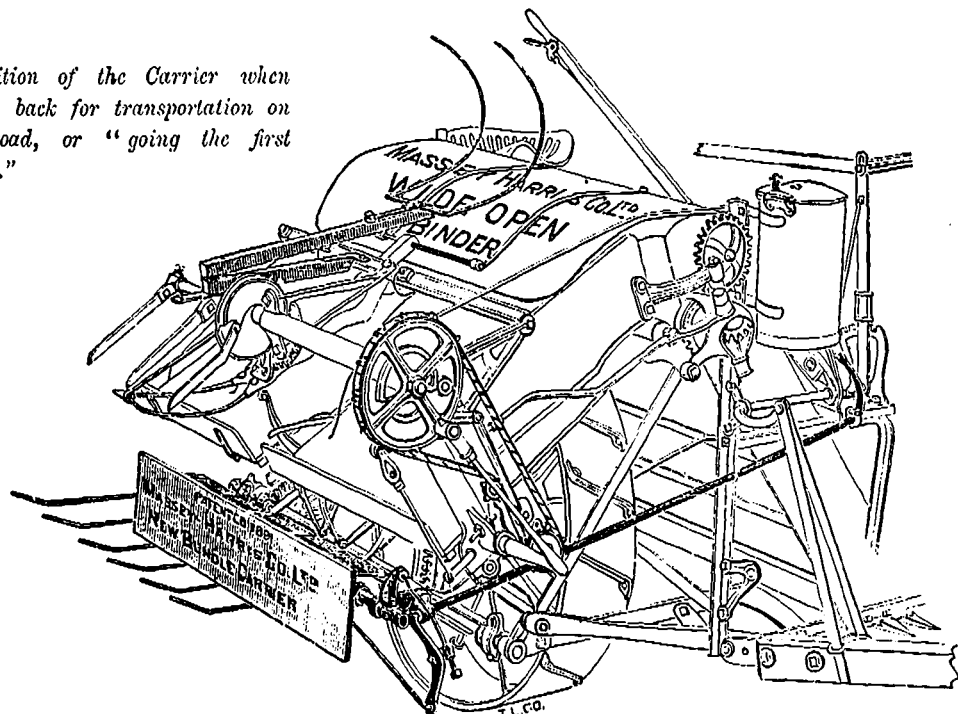

Position of the Carrier when folded back for transportation on the road, or "going the first round."



Seen and Unseen.

Who doubts when winter blows  
With roar and threat and turmoil, his fierce breath,  
His bonds of ice, his blinding burying snows,  
An universal death.

That in due time—not long,  
Proving a faith we scarce can understand,—  
We shall behold, upspringing green and strong  
Over the whole broad land,

The dandelions and the grass;  
Shall see buds burst on all the naked trees,  
The bee go gaily by in gold cuirass,  
Ay, butterflies and bees;

Shall hear birds sing, and hark  
The tinkle of glad waters as they run;  
Have dews, sweet rain, and twilight scarcely dark,  
Hours after set of sun?

There is no room for doubt  
Of any of these wonders God reveals.  
Then why an anxious questioning about  
What He in love conceals?

Have other faith than sight,  
A trust beyond the visible and near,  
And in His own good time the Infante  
Will make all mysteries clear.

—Mrs. Clara Dohy Roberts.

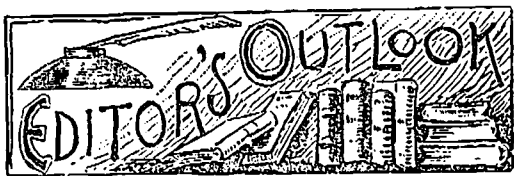

THE directors of the Winnipeg Industrial Exhibition have, it is said, practically decided to hold this year's fair in midsummer. This will be a new departure, and the result financially and otherwise, will be awaited with considerable interest.

ARRANGEMENTS have been completed for the establishment of a veterinary college in connection with Queen's University, Kingston, Ont. A principal will be secured in Scotland, who will be assisted by as able a staff of teachers as can be procured. A farm will also be purchased, on which to keep stock for veterinary purposes.

WE are very much pleased to observe that the attendance at the Farmers' Institute meetings throughout Ontario last month was as a rule, far in excess of previous years and that much greater interest was manifested in the proceedings, many of the leading farmers taking an active part in the discussions on the papers read. This is a good sign, and will bear good fruit in the future.

THE death of Prince Albert Victor, eldest son of the Prince of Wales, and heir presumptive to the Throne, on January 14th, evoked expressions of profound sorrow and sympathy for his grief-stricken parents and betrothed, from all quarters of the globe. The Prince was in his twenty-eighth year, and was to have been married this month, to Princess Mary, of Teck. His death was caused by congestion of the lungs. Prince George, of Wales, steps into the place of heir-presumptive.

THE Canadian Pacific Railway Company in order to encourage the settlement of their land in the

North-West, have decided to make a very material reduction in the price of all lands, which have been hitherto held at \$4 per acre and upwards, excepting such as are especially valuable on account of proximity to a railway station. This will practically mean that the bulk of the company's land, which has heretofore been held at \$4 per acre, will be sold at about \$3, and that held at \$5 and \$6 per acre, will be sold at about \$4.50 per acre. It is expected that these inducements to settlers will be largely taken advantage of during the coming season.

INFLUENZA, or la grippe, has carried off an immense number of people in Canada, the United States, Great Britain, and the continent of Europe this winter. A marked feature of the present visitation of the disease is the large number of deaths resulting either directly from it, or from the complications attending it. It is no respecter of persons, rich and poor alike being attacked by the malady. Reports came from all quarters last month, that doctors were being overworked, and in many places it was found utterly impossible for the whole of those afflicted to receive medical attendance. It was reported last month that Dr. Pleiffer, son-in-law of Prof. Koch, had discovered the influenza bacillus and had transplanted it in six cases with complete success. He had also discovered the original cause of infection, which he believed to be the sputum of persons affected. It was not known, however, whether he had obtained a specific cure from the cultures.

IN the province of Brittany, France, a plan of agricultural co-operation is meeting with great success. During the severe agricultural depression in 1880, many of the tenants of Count de Lariboisiere, a proprietor of eighty farms, covering some 4,000 acres, were far behind in their rents, and were abandoning their leases in despair. The Count called them together and suggested an arrangement by which they were to continue to work the farms under his direction, he to assume all financial responsibility, to guarantee them their living, and to give them the half of all profits derived from their labor. This they agreed to, and the count at once secured the services of a competent manager, who proceeded to make a specialty of dairy farming, steadily improving the breed of cows and perfecting the processes of manufacture of butter and cheese, with the result of soon securing a reputation for superior products and the highest prices in the market. Both owner and tenant have greatly prospered under the new plan, the returns from each farm having been greatly increased.

THERE is every indication that Canada will be well represented at the World's Fair, Chicago, next year. It is estimated that our agricultural exhibit will occupy 23,000 square feet, and the fruit display 10,000 feet. Last month Prof. Saunders, Canadian Commissioner to the World's Fair, visited Chicago to make preliminary arrangements with the Fair Commissioners in reference to the allotment of space for the Dominion exhibits. It is expected that the Dominion will require altogether 100,000 feet. At the Centennial exhibition in Philadelphia, Canada occupied a space of 50,000 feet, and at the Colonial exhibition of 1886, in London, 60,000 feet. At the convention of the Eastern Ontario Dairymen's Association, at Cobourg, Ont., on January 7th, it was resolved that in view of the magnitude and importance of the dairy interests of Canada, the attention of the Minister of Agriculture be called to the desirability of instructing the Dairy Commissioner of the Dominion, to take such steps as will secure a representative and creditable display of dairy products from Canada to the World's Fair.

THE annual meetings of the Eastern and Western Dairymen's Associations of Ontario, and the Ontario Creameries Association, last month, were well attended and highly successful in every respect. There is no doubt that the dairy industry of the country will be much benefited by the information disseminated and the interest aroused. One of the

principal features at the meeting of the Dairymen's Associations, was an address by Prof. James, on the progress of the dairy industry in Canada. Among other things he proved that the exports of dairy products from Canada were within a fraction of as great value as the exports from the United States. To account for the falling off in the United States exports, he quoted from American consular reports complaints of the export of what were known as "filled" cheese, or cheese in which the butter fat had been extracted from the milk, and cheaper fats substituted. These goods had the effect of lowering the reputation of American cheese generally. On the other hand the Ontario factories, by sending full, cream cheese, had made a record which gave their products a high place in the market. He advocated the adoption by the Dairymen's Associations of means to increase their membership by bringing in the thousands of farmers who are interested as patrons of the cheese factories, and as proprietors of private dairies.

ONE of the effects of the McKinley tariff bill has been to practically ruin the city of Oswego, N. Y. Its commerce was almost entirely in barley with Canada, and the virtually prohibitive duty of thirty cents per bushel reduced the importation of that article from Canada from ten million bushels in 1890 to about two million last year. It was predicted that the high duty on imported barley would increase the value of barley to the farmers in New York State, but the experience of the past year has demonstrated that these predictions were erroneous as the value is lower now than it was when the duty was only ten cents per bushel. The Merchants' Exchange of Buffalo, at a meeting last month, passed a resolution respectfully requesting Congress to reduce the duty to ten cents. It was also decided to use every endeavor to have other similar bodies to act with them, and to get the representatives to Congress and Senators of the State to support a bill recently introduced into Congress reducing the barley duty to ten cents. The republican organ in Buffalo, in speaking of the meeting, said: "It is to be regretted that theoretical belief in the principle of protection and endorsement of the McKinley bill as a whole should have induced any member of the Merchants' Exchange to oppose the reduction of the duty on barley. When a high duty fails to advantage either the American producer or the American consumer it is not a protective duty. The resolution in favor of a reduction of the duty passed by the Exchange by an overwhelming majority represents general Buffalo sentiment."

IN these severe winter months, it is not unusual for many people to be lavish in their praises of the other seasons. Spring, summer, and autumn whilst we enjoy their blessings, are little attended to; but when we no longer profit by their advantages, we praise them beyond measure. It is usual with men to disregard their present benefits, and only begin to feel their value when they can no longer enjoy them. But is it true that those three seasons alone possess every advantage? Is winter really so great an evil as some represent it to be? These are important questions, as they considerably influence our content and repose. Spring and autumn are sometimes dangerous from the great and sudden changes of temperature, and the frequency of epidemic diseases; and in summer the heat is very oppressive, and productive of debility and various maladies. In winter these inconveniences are not experienced, the health is generally better, the body more vigorous, and the spirit cheerful. In summer, when sinking under the intensity of the sun's rays, how we sigh for the shadow retreat, and the evening breeze, to refresh our languid frame; whilst during the cold of winter we are active and alert, and rarely find the cold so intense that exercise will not procure us a grateful warmth. Thus even winter may contribute to our health and to our pleasures. If we are disappointed, if we do not enjoy so good a state of health, the fault probably rests with ourselves. Many people pass the time in idleness and inactivity, and, immersed within close and heated rooms, never breathe pure air, nor go abroad to enjoy many of the delights which are really very favorable and mild.



WE are under considerable obligations to those naturalists who have made laborious researches and investigations into the nature of generation, and the propagation of animals, by which much light has been thrown upon a very difficult subject. The less we are able to comprehend the works of nature, the more eagerly should we seize every opportunity that offers of enquiring into them. We are told that the hen has scarcely sat upon the eggs twelve hours, when some lineaments of the head and body of the chick may be discerned in the embryo. At the end of the second day, the heart begins to beat, though no blood can be seen. In forty eight hours two vesicles with blood may be distinguished, the pulsation of which is evident; one of them is the left ventricle, the other the root of the great artery. Soon after one of the auricles of the heart is perceptible, in which pulsation may be remarked as in the ventricle. About the seventh hour the wings may be distinguished, and on the head two globules for the brain, one for the beak, and two others for the front and hind part of the head. Towards the end of the fourth day, the two auricles, now distinctly visible, approach nearer the heart than they did before. About the fifth day the liver may be perceived; at the end of one hundred and thirty-eight hours the lungs and stomach become visible; and in a few hours more the intestines, veins and upper jaw. On the seventh day the brain begins to assume a more consistent form. One hundred and ninety hours after incubation, the beak opens, and flesh appears on the breast. In two hundred and ten, the ribs are formed, and the gall-bladder is visible. The bile, in a few hours more, is seen of a green color; and if the chick be separated from its coverings, it may be seen to move. Towards the two hundred and fortieth hour, the feathers begin to shoot, and about the same time the skull becomes cartilaginous, and in twenty four hours more the eyes appear. At the two hundred and eighty eighth, the ribs are perfected, and at the three hundred and thirty first, the spleen approaches the stomach, and the lungs the breast. On the eighteenth day of incubation, the first faint piping of the chick is heard. It then continually increases in size and in strength till it emerges from its prison. By so many different gradations are the chicks conducted into life. All their progressive evolutions are arranged with order, and each one is effected by its own particular cause. If the liver is always formed on the fifth day, it is from the preceding state of the chick. No part of its body could appear sooner or later without some injury to the embryo, and each of its members appears at the most convenient time.

#### LUTHER D. SAWYER. JONATHAN AMES.

It might almost be said that the past few months have been a season of death. The fell destroyer has been no respecter of countries, communities, cities, or individuals; and on every hand death is recorded amongst individuals in every grade of social life from heirs to thrones down to the humblest citizens. It is not often that the two senior partners of a firm, who have worked side by side for many years in the development of a business enterprise, die within a few days of each other. But such was the case in the death of Mr. L. D. SAWYER on Thursday, January 14th last, at Hamilton; his associate, MR. JONATHAN AMES, dying on the Tuesday previous (January 12th) at South Lincoln, Mass. Both these gentlemen were members of the well-known firm of L. D. Sawyer & Co., Hamilton, Ont., and the fact that they both succumbed to the same disease—pneumonia—makes the coincidence still more remarkable.

By the death of Mr. Sawyer, Hamilton loses one of her most successful business men, and his name is widely known in connection with the agricultural implement trade. He was a man of very superior business abilities, was prompt and resolute in his decisions, and reasonable and generous in disposition, always actuated by the most honorable motives. He was by born in the little town of Amesbury, Massachusetts, in the year 1826, and in early life acquired a knowledge

of manufacturing, which he ever afterwards followed. Coming to Hamilton in the year 1844, he became connected with the foundry business then carried on by Messrs. McQuesten and Fisher, in a building which stood on the present site of the Royal Hotel. In 1853 he was admitted a partner, and in 1858 he with his brothers, Samuel and Payson, took control of the business in their own name, abandoned the foundry branch and devoted themselves exclusively to the manufacture of agricultural implements, and in the course of a very few years, by laudable energy and enterprise, succeeded in taking a foremost position amongst the leading manufacturing concerns of the country. Subsequent changes took place in the membership of the firm. Samuel Sawyer died in this city, and Payson removed to Muscatine, Iowa, where he and his family still live. Mr. H. P. Coburn and the late Mr. Jonathan Ames were admitted to membership, but through all changes Luther D. Sawyer continued the strength and controlling head of the business, until his final retirement in the year '89, when he and Mr. Ames sold out their interest to the Messrs. Massey, of Toronto, who, with Mr. Coburn, organized Sawyer & Massey Co., Ltd., which company has since conducted the business under the able management of Mr. Coburn, junior partner of the old firm. A few years previous to this Mr. Sawyer had the misfortune to lose his wife, who died of pneumonia at St. Augustine, Florida, where the family were spending the winter. Since which he has remained a widower. His family consisted of four daughters, the eldest of whom, a beautiful girl, just emerged into womanhood, fell a victim to hemorrhage of the lungs, and now rests beside her mother in Burlington cemetery, where Mr. Sawyer will also be buried. The other three remain to mourn his loss—Mrs. A. H. Hope, of this city, Mrs. Harry Brown, of Lowell, Mass., and the youngest, unmarried, at home.

Mr. Sawyer will be greatly missed by those who enjoyed business and social relations with him, and the entire community will join most heartily in tendering their warmest sympathies to his sorrowing relatives.

The Hamilton Times pays the following tribute to the memory of Mr. Ames:

In the death of Mr. Jonathan Ames from pneumonia, which took place at his home, near South Lincoln, Mass., on Tuesday morning (January 12), it may be truthfully said that a truly good man has passed away. He was a native of Draut, in the State of Massachusetts, and was a resident of this city from the year 1865 till December, 1888, when, owing to failing health, he with his family removed to the vicinity of Boston, where in the climate of his early life near the sea coast he continued to enjoy fairly good health, until the prevailing epidemic, *la grippe*, took unrelenting hold upon him, and added another noble life to the long list of its victims. Mr. Ames was a member of the well-known firm of L. D. Sawyer & Co., of this city, and during his residence here was a very useful and much respected helper in connection with the Young Men's Christian Association, the churches, and indeed every religious and benevolent institution in the city, to all of whom his generous liberality was freely extended as occasion required. Indeed his liberality was known far and wide, and seldom did a collector for any deserving object visit the city but he found his way to Mr. Ames, and not in vain. He was for some years an elder in the Central Presbyterian Church, and it may be said that to the liberal contributions and untiring efforts of himself and his worthy partner, Mrs. Ames, are largely due the erection of the present Erskine Church and the early prosperity of that congregation. Mr. Ames is still held in grateful remembrance, and his death is deeply regretted by the numerous workmen connected with the Hamilton Agricultural Works, to whom his kind and considerate conduct was such as became the genuine Christian gentleman and employer, and a large circle of sorrowing friends in Hamilton and elsewhere heartily sympathize with his respected partner and relatives in their great bereavement.

Added to Mr. Coburn's bereavement in the loss of his two old business associates, his aged father died the same day as Mr. Sawyer. He has our sincerest sympathy.



1st.—DEATH of A. Dunlop, M.P.P. for the North Riding of Renfrew, Ont., at his residence, Pembroke. . . . Corner stone of St. Joseph's hospital, London, Ont., laid by Bishop O'Connor. . . . Mr. Haultain, member for McLeod, appointed leader of the new government for the North West Territories.

2nd.—Reprted that influenza of such a violent form is raging in Somersetshire and Dorsetshire, England, that all labor on the farms has been practically stopped. . . . Destructive fire in Nashville, Tenn.; three men killed, and about \$500,000 worth of property destroyed.

4th.—Municipal elections throughout Ontario. . . . The proposal to run street cars in Toronto on Sundays, defeated by a vote of 10,011 for, 14,140 against. . . . Death announced of Mr. Richard Potter, president of the Grand Trunk Railway from 1860 to 1876. . . . Representatives of France and Sweden, come to a complete agreement in reference to a commercial treaty.

5th.—Bill introduced in the New York State Assembly incorporating the Wolfe Island Bridge Company, to bridge the St. Lawrence, near Kingston, Ont. . . . The grand jury at the Carleton Assizes, Ottawa, return true bills against Arnoldi, Talbot, and Larose in connection with the frauds against the government.

6th.—The Wanzer sewing machine factory, Hamilton, Ont., destroyed by fire; loss \$100,000.

7th.—Death of the Earl of Lichfield. . . . The new French Tariff bill finally passed by the Chamber of Deputies. . . . Death of the Khedive of Egypt from influenza.

8th.—Over one hundred lives lost by an explosion in a coal mine, at Krebs, I. T.

9th.—Judge Mathieu, of the Superior Court, Donald MacMaster, Q. C., and Mr. Damase Masson, merchant, all of Montreal, appointed a Royal Commission, to hold a general enquiry into the administration of the Mercier Government.

11th.—Mr. Hargart receives the portfolio of Railways and canals, and Mr. Ouimet, that of Public Works. . . . Mr. Bauneau, Liberal, elected member of Parliament for Richelieu, Que.

12th.—Petition against the return of Mr. S. Burdett, M. P. for East Hastings, Ont., dismissed with costs. . . . Destructive fire on Main Street, Winnipeg; loss, \$12,000.

13th.—Immense conflagration in Leeds, England; loss £300,000.

14th.—Death of the Duke of Clarence, eldest son of the Prince of Wales, in his 28th year.

15th.—Passenger train on the Northern Pacific Railway, at Jone ville, Minn., leaves the track and goes down an embankment; two women burned to death and many persons injured.

16th.—Prince Abbas, appointed Khedive of Egypt, and takes his place on the Throne.

18th.—A bridge over the river Kara, at Tifli, Russia, collapses while a religious procession is passing over it, and a large number of people are drowned.

19th.—Death of Rev. Father Anderledy, the Jesuit General, at Rome, Italy.

20th.—Death of Mr. S. B. Burdett, M. P. for East Hastings, at Belleville, Ont.

21st.—Arthur Edward Smithers, managing director of the English Bank of the River Plate, London, England, sentenced to four years' penal servitude, for embezzling the funds, and falsifying the accounts of the institution.

22nd.—The Indiana Surgical Institute, Indianapolis, destroyed by fire; twenty of the patients burned to death, and many seriously injured.

23rd.—Mr. Madden, Gladstonian, elected member of the British Parliament for Rossendale, rendered vacant by the elevation to the peerage of Lord Hartington, which is looked upon as a serious reverse for the Conservative party.

25th.—The Dominion Cabinet reconstructed by the appointment of Mr. J. C. Patterson, of Essex, as Secretary of State, Mr. MacKenzie Bowell, Minister of Militia, Mr. Chapleau, Minister of Customs, and Sir Adolphe Caron, Postmaster-General.

26th.—John A. Macdonald, Conservative, elected M. P. for Victoria, N. S.

27th.—Chili makes an amp'e apology to the United States, and the danger of war is considered over.

28th.—J. H. Metcalfe, Conservative, elected M. P. for Kingston, Ont.; William Gibson, Reformer, re-elected for Lincoln, and Mr. Henderson, for Halton.

29th.—Death of Prof. W. H. Huston, principal of Woodstock College, Ont. . . . The Democratic majority of the Ways and Means Committee of the U. S. House of Representatives separate decides to attack the McKinley high tariff by various bills.

30th.—Mr. Dickey, Conservative, re-elected M. P. for Cumberland, N. S. . . . The United States House Committee on Elections approves the principle of electing senators by popular vote. . . . Death of Hon. G. Bressa, M. L. C. of Quebec, in New York, while en route to Florida.

31st.—Death of Rev. Charles H. Spurgeon, the eminent London preacher, at Mentone.

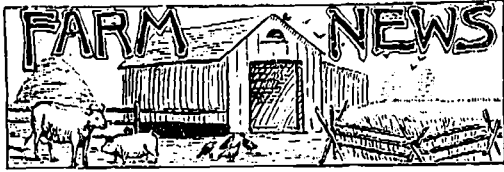

### A Lawn and Drive Roller.

A good thing was seen at work recently on a place in a neighboring city. It was evidently homemade and was rapidly rounding up and hardening the walks and drives, and at the same time clearing them of moss, weeds and grass. A pair of light rollers eighteen inches in diameter and three feet long are mounted, the one forward of the other, as shown in the illustration, to be drawn by one horse. A seat for the driver is bolted to the platform and near his feet an iron rod, on which he can throw his weight, extends through a slot and connects with a scraper resting on the ground. To make this, a plank two inches thick and six inches wide is bolted to irons, by which it is drawn. It

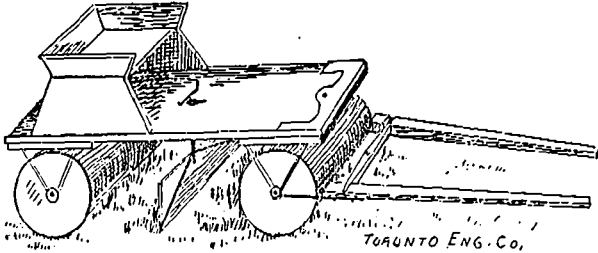

has a thin strip of steel bolted to its lower edge which takes off more or less of the surface of the walk, according to the weight placed upon it by means of the foot-rest above. When the scraper is not required, it may be raised and kept suspended by the connecting rod which has a notch filed in one side, by which it is caught in the narrowed, forward end of the slot through which it passes. The first roller is drawn by shafts hung directly on its axis, and turns on a king-bolt like the forward wheels of a wagon, allowing the scraper and hardening roller to be backed or turned. On new or uneven lawns the roller does admirable work in advance of the mower. For carrying weights like urns, jars, earth, water to be used in transplanting, etc., the roller is unequalled, as it never cuts the lawn, even when soft in spring, as barrows and carts are prone to do. —*American Agriculturist.*

### An Easily Made Piazza.

THERE are many houses that have not the advantage of shade trees around them during the summer, when cool places are most eagerly welcomed. A piazza is perhaps next best in its shade to a wide-spreading oak, ash, maple or elm. But piazzas are objected to by some, and with considerable reason, because they shut out the sunlight in winter, when it is particularly desirable. Moreover, the expense of building a permanent piazza, in the ordinary way, makes it an impossibility in many cases.

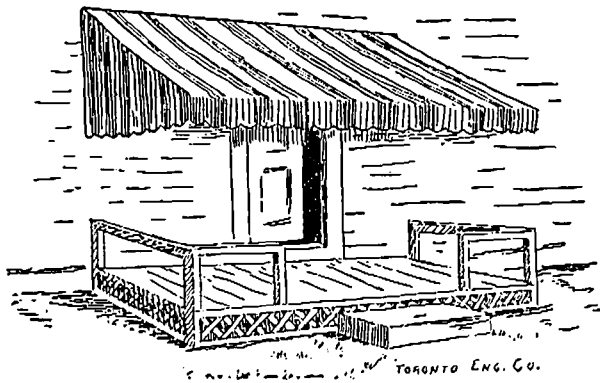

The illustration shows a way to secure the advantages of one without its disadvantages, and at so trifling an expense that it could be afforded by almost anyone. A platform is made before the door of such length and width as may be desired. This can be a temporary structure, without a railing, to be taken away in the winter, or can be made to re-

main permanently in position, if desired. A light framework is fastened to the house above this, of the same length and width, and over this is fitted striped awning cloth. This framework, which can be taken down in the winter, is easily made of light strips of wood and laths, well braced from side to side, and secured to small cleats that can be screwed to the side of the house. Such a summer piazza can be made to extend along the whole side of the house, shading both windows and doors, or arranged on a smaller scale as shown.

If the cloth is carefully removed from the frame each fall, and kept well secured during the summer to prevent the wind from tearing it, several seasons' wear can be had from it, though it can be replaced at a trifling cost. —*Cultivator and Country Gentleman.*

### Crate For Shipping Pigs.

THE man who receives stock in crates does not care to pay express on useless lumber, yet he wishes to have the crate strong enough to hold his purchase safely until it reaches his farm. Some woods, like poplar, basswood, and elm, are both light and tough, and can be used thinner than pine, but if pine is thoroughly dried and planed on both sides, a neat, light crate can be made, which will hold pigs or sheep securely. A crate for a two-hundred-pound pig must be four feet long, thirteen or fourteen inches wide, and from twenty-four to twenty-eight inches high.

When sent by freight it should have a feeding-box in front, and be nailed together with wire nails properly clinched. A six-inch board may form the lowest strip of each side, then a four-inch, then two three-inch strips. The sides are nailed up, then the bottom board is sawn out of a proper length to admit the strips at the front, and back of the sides, and securely nailed to the lowest boards of the sides.

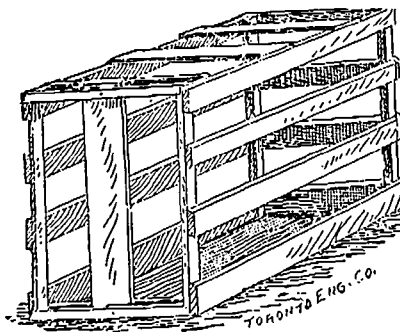

The slats are nailed across the front and top, four from each place, then a single board slipped in between two strips at the back end, making a door for getting the pig in and out. Two wire nails hold this board in place. The weight is from thirty-five to forty-five pounds, and will hold a large pig, going hundreds of miles.

### Sifter For Coal Ashes.

SCATTERED over the ground around many farm homes we see coal enough to run the stoves for a month. It was just dumped on the ground because it was too much trouble to pick it out of the ashes. We shouldn't care to do such picking with bare fingers, but it is well enough to let a sieve do the work. The sifter shown is made by a friend in Wisconsin, who says about it: "The apparatus consists of an ordinary coal sieve with a narrow strip nailed across the centre, as shown, and let into the top of a box having a hinged cover in the manner indicated in the drawing. The coal ashes may be poured into the sieve, and then the cover may be shut down, and the sifting done without the necessity of supporting the sieve and the ashes by the hands and without the annoyance caused by the dust settling on the clothing or blowing into one's face. The box is made in sections, which may

be lifted so that it can be taken apart to facilitate shoveling out the ashes." After you get this sifter made, don't conclude that, just because you have

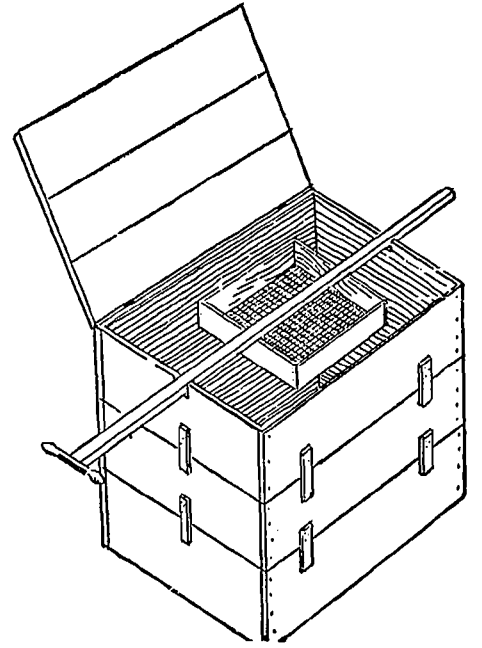

made the work a little easier, shifting ashes is the wife's job. It isn't. It is a man's job as much as it is his duty to shovel coal or cut wood. —*Rural New Yorker.*

It is said that the silo of the future will be round, thereby avoiding all corners, which are the seat of loss where loss occurs. Such siloes are very strong, with no danger of spreading, and are also cheap, as the studding need not be larger than 2x4. The belief is that the inside sheeting will be double, of half inch boards, including waterproof paper. The boards will break joints, and inside will be coated with coal tar thinned with gasoline. The door will consist of separate boards, so that it can be opened or closed, one board at a time, as the silo is emptied or filled and will extend from bottom to top, and the studding secured at this place by a few iron rods.

FARMERS should apply intelligently upon the garden an abundance of fertilizers, and a vast amount of well-directed labor so as to keep their tables liberally supplied with the best garden vegetables, and the choicest fruit, fresh from vines, bushes and trees. An important thing is to use good seed. Eternal vigilance is the price of freedom from weeds, and it stands to reason if the seeds of no weeds are allowed to ripen, it will greatly lessen the labor of keeping the garden clean. Sow as early as possible, on soil properly prepared, seeds of hardy varieties which are less liable to be injured by frost. Then another planting of those less hardy after about ten days, so as to have a succession.

A PROMINENT orchardist succeeded in repelling the borer from his young orchard trees by the following remedy: He found that when lime and ashes were applied around the trees, if they were not already too badly injured, they healed over and the borer left them. To exclude the borer from other trees, a wash was made of soft soap, ashes, lime and coal oil, and applied four times in the year, or twice in spring and twice in autumn. This remedy appeared to have been effectual, for not a tree had been lost since using it. Caution is, of course, necessary, for sharp, fresh wood ashes, and a large amount of coal oil, may each be too severe a remedy for young trees with tender bark, and especially if applied to young peach trees for the grub.

THE most valuable and economic application to rough out-door wood work has been found to be a wash of crude petroleum—either the light or heavy oil, but best of a mixture. It is not a paint, for it immediately sinks into the pores of the wood, and renders it more durable, like cedar. A small

intermixture of some coloring matter, like ochre, remaining on the surface of the wood, will partly affect the color, but it is not necessary. Next to this is one of several preparations of lime wash. The addition to it of small portions of sulphate of zinc and of common salt renders it more durable. Or, fresh water lime powder made into a wash, with as much fine, clear sand as the brush will hold in applying, makes a pretty good wash. These will need renewing every few years; the petroleum once in eight or ten years.

Potato seed that is to be planted early should be put into a warm room for about ten days, when they will be sprouted a little before planting. If they are likely to start too much before planting, they should be removed to a cooler place, which will check the growth. If this is not done the sprouts may break off. Plant the first warm day as soon as the land is dry enough to work. Do not cover too deep, but leave them near the surface, so the warmth of the sun will hasten the growth. If there are signs of a hard freeze after the plants are up, run a plow over the ground and cover them with earth for a protection. They will come up through this covering. Varieties should be selected, which will mature within three months. The field on which the early potatoes are grown can be made to produce another crop the same year of millet, turnips, etc., or it can be seeded with grass. It is bad policy to follow a crop of potatoes with another crop of potatoes, especially if the land has been manured with stable manure, as in this way the scab will be increased. The early kinds should be sown in drills, as they can be planted closer together, the vines being smaller.

### The Stock.

It is a mistake to think mares can foal good colts when they can no longer work. The worn-out mare is not a profitable brood mare.

Salt should be placed where cows can have access to it daily. They will then take just what nature requires, and there will be none of the injurious effects which follow giving in larger quantities at intervals.

Cows suffering from milk fever may be treated with tincture of aconite in twenty-drop doses, and tincture of belladonna in forty-drop doses, alternating every hour until the animal begins to recover, and then diminish the doses until the trouble has entirely disappeared.

Pure and fresh air is just as important as pure and nearly inodorous food for cows in order that they should give the best quality of milk for butter-making. There are, no doubt, cows which are not so susceptible of poor and strongly-scented food as others, but they are not, as a rule, animals that give the richest milk.

The old idea that barley was deleterious to milch cows has been effectually exploded by very successful experience in feeding it. Barley is, however, too rich in fat forming elements, to make a good ration alone. It should be ground and the meal mixed with wheat bran, cotton seed meal, or oil-meal. In the latter case it is the best to give the mixed ration immediately after milking, to prevent a peculiar flavor to the milk.

It is a good thing to have wind-breaks on the farm. Even where the farmer is able to build barns, stables and sheds, yet wind-breaks on the north-east and north-west of the cattle yards save much discomfort to stock, and, therefore, many dollars to the farmer. Part of every feed is used in maintaining animal heat, and, when the cold, wet storms of winter beat mercilessly upon unprotected animals, the farmer must pay for his inhumanity and thriftlessness. The east wind is everywhere

deleterious to health, and animals have often been chilled and killed by the east winds of winter.

The blanket is almost indispensable as a protection to horses during cold weather. The noble organs within the chest require such protection, especially when the animal is heated by fast work. The blanket should perfectly cover the chest and body far back of the loins even to the root of the tail. No animal when heated, even when blanketed, should stand long in a draught. The thick muscles of the rump require no special cover. A blanket that will buckle snugly under and behind the chest is the best for fast driving horses when heated. A horse gets stiffened in his forequarters and forefeet if exposed to a cold draught when heated. Clipped horses when properly covered, are not so liable to founder as long-coated horses profusely sweating. For more perfect protection the double-breasted blanket is a special preventive of founder.

Sheep properly selected according to the climatic condition of the country in which they are to be bred, and then intelligently managed, are one of the most profitable of domesticated animals. It is not advisable for farmers to sell out and go into sheep husbandry, but they should combine that with their other pursuits. Sheep should not be selected for wool-growing alone, it is better to get a good fleece and a heavy carcass of mutton from the same animal. A ewe that raises two lambs, besides the wool clip, pays her owner two hundred per cent. on the money invested in her. Besides, this money comes in from April to August, during a period at which many farmers have nothing else to turn into ready money for current expenses. Then, again sheep droppings form one of the best manures for grass lands and for cereal crops. One hundred sheep produce much valuable manure in the course of a year and are worth their keep for that purpose.

Those who are to have early litters of spring pigs must give the brood-sows proper food and treatment during the winter months. The first requisite is good shelter, and a clean, wholesome sleeping place. The next is a reasonable amount of liberty. It will not do to keep a brood-sow shut up continuously in a small pen, even if it is kept reasonably clean. She will become sluggish and inert, with none of the vigor and muscular stamina needed to produce and rear healthy pigs. A certain amount of exercise every day is necessary. If she will not take her daily "constitutional" of her own accord, it is best to drive her out. Nothing is better during mild, open weather than the run of a lot where she may root to her heart's content. The food should be abundant, but none of a fattening character. Milk, bran, and middlings, with a small modicum of oil meal, varied frequently by boiled turnips, carrots, beets, or other roots, clover hay chopped short and mixed with the cooked ration, and in cold weather a small proportion of corn-meal, will keep the animal in good, thrifty condition. Swine are omnivorous, and an occasional morsel of animal food is always acceptable. The "lights," entrails, and other waste material of a slaughterhouse, when attainable, are desirable additions to the animal's dietary. It is well to keep a mixture of salt, charcoal and a little sulphur in a trough where the sow can help herself as often as she likes. It is always best to keep brood sows separate from the rest of the herd. This is specially necessary as the time for farrowing approaches.

### The Poultry Yard.

A good expedient for securing dryness within the coop is to use dry earth, scattered about under the roosts, and over the floor.

Do not forget to furnish your fowls with occasional rations of green food at this season. If nothing better has been provided, cut hay will answer very well.

Skim and butter-milk can be fed to chickens and hens to more advantage than to pigs. Doing so pays better, and the milk is greatly relished by the fowls. It should be given in separate vessels, and the soft feed may be made up with it instead of water.

The quality of the eggs depends upon the character of the food supplied. The hen must make eggs out of what she eats. Too much fish gives a fishy flavor to the eggs, thus many onions, an oniony flavor. Decayed grain and tainted meat in like manner, will make eggs inferior to those produced from wholesome food.

If it is desirable to keep fowls from flying over their yard fences, do not pull out the wing feathers, as new ones at once begin to grow and make too great a drain on the system. Simply cut the flight feathers, except in case of show birds, when it pays to cover the yards with wire, or to have them so high they cannot fly over.

The dairy farmer who has the wit and wisdom to combine the raising of chickens with his dairy business, has an excellent combination. There is no better drink—indeed it is food and drink—for young chicks, than lopped milk. Skim milk and sour milk are excellent either for drink or for mixing with meal, shorts, bran, or middlings.

Select dry land for poultry, and never build a poultry house where water will ever stand on the ground floor. Dampness means sickness or no profit. Dry, hilly land is better than low, level land for poultry, provided they are sufficiently well fed; but rich land affords more vegetation and more insects to feed upon than poor land.

Tincture of arnica will cure fowls of sore head. Separate the sick from the well and apply the tincture with a soft rag every morning for four to six days. A few drops in the drinking water is necessary. Do not permit their eyes to become closed. Sore head is not the direct cause of death with fowls, but when not properly attended the eyes close and the fowls die of starvation.

Charcoal should be given to the hens in soft feed once or twice a week. It contains a substance their organs require constantly and as it acts on the blood, it acts really on the life itself of the fowl. When the blood is thick and clotty, a dull, sick chicken will soon follow; thin blood always means vigorous circulation, and on good circulation health largely depends. If your fowls lack activity, they need something that will stir the blood from its sluggish source.

Regarding the different breeds of fowls, an authority says: The egg machines are—Leghorns, Minorcas, Houdans, Spanish, Hamburgs, Andalusians, and Polands. The table fowls are—Brahmas, Cochins, Wyandottes, Plymouth Rocks, Dominiques, Houdans, Games, and Langshans. Those that lay dark eggs are—Wyandottes, Plymouth Rocks, Brahmas, Cochins, and Langshans. Those that lay white eggs are—Houdans, Spanish, Minorcas Leghorns, Games, Polish and Javas.

There are too many evils attendant upon feeding poultry almost wholly on concentrated food, such as grains of various kinds, particularly corn. In the first place, they are too expensive; nor is the expense less because one raises the grain. It is not sufficiently bulky, and is too fattening, thus bringing on a condition which is not favorable to egg production but disposes the fowls to diseases of various kinds, and has a tendency to bring on the incubating fever, since a hen scarcely ever desires to sit while unduly lean.





### Rustic Table.

This pretty little rustic table is a charming and useful piece of furniture for a bed-chamber or sitting-room, while it is so simple that the younger members of a family could well combine to make one as a gift for mother, the boys manufacturing the stand and the girls working the really artistic, if inexpensive, cover. Three stout, gracefully-curving branches thirty-two inches in length should be selected for the legs, crossed and fastened firmly together two-thirds up, as shown in the cut. These may be varnished or left the natural hue of the wood, as is best liked. A large barrel head

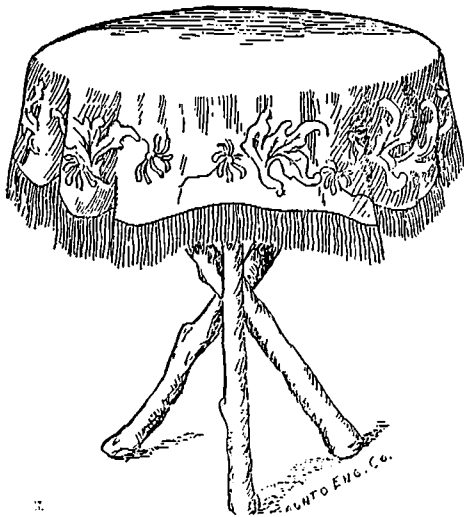

HOME-MADE TABLE AND COVER.

forms the top and is covered merely by the small tablecloth. Bolton sheeting, which sells for about fifteen cents a yard, is the material used for this cloth. It requires a piece twenty-seven inches square, and in each corner is embroidered a large, showy pattern with coarse linen floss in three colors. The design, from which the illustration was taken, is worked in yellow and brown, and it took three hanks of each shade. Strands of the same floss knotted in makes the fringe.

### A Thimble Case.

Take as large an English walnut as you can get, and carefully break in half; take out the kernel,

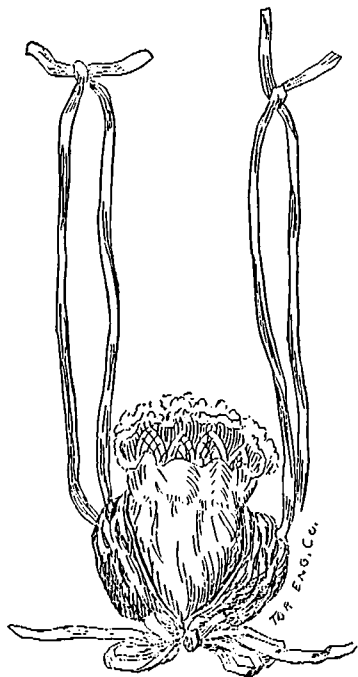

and make as smooth as possible inside the shell; then with the scissors make two holes in each end

of both halves. (Take the pointed part for the bottom.) Put narrow ribbon through the bottom and tie; then take surah silk or satin, and cut 6 inches in length, and 3 inches in width; sew ends together; turn down one inch at the top; hem; run another thread above for casing for ribbon; take narrow lace and sew around the top; run ribbon in; gather the other end, and sew part to the ribbon at the bottom; draw the ribbon in the holes in the top; tie ends together; draw up, and you will have a neat little thimble case.

### A Family Mending-Pocket.

A circular piece of card-board about as large as tea plate, or a little larger, forms the foundation of this dainty wall pocket. A slight indentation is cut in the top of the card-board, which is then covered with curled hair, beneath two layers of sheet wadding, over which thick, soft silk, of a dark red color, is smoothly drawn, the whole forming a soft, durable cushion for pins and needles. Around the lower half extends a puffed crescent-shaped pocket, the upper edge of which is shirred to form a standing frill, and a narrow casing, into which elastic cord is run. This forms a receptacle for an assortment of boot and clothes buttons of all kinds likely to be needed daily by one or another



READY FOR MENDING.

member of the family, a thimble, and a spool each of black and white thread. A narrow double ruffle, to match the pocket-ruffle, is carried around the upper half of the cushion, and the back is smoothly faced with any suitable lining material. To suspend it, narrow gold-colored satin ribbons are attached to the sides of the back, and are tied above in a cluster of soft falling loops. Hang the pocket on the wall in some convenient place in the family living-room, where all can see and reach it, from the least to the greatest, and invite, persuade or teach every member of the family to apply to it for repairs; and, on no account forget to keep two or three needles in it ready-threaded for emergencies. "A stitch in time saves nine" is a good motto for such pockets, but, like many other good things, it has been almost worn out with frequent repetition. "Mending done here" will answer the purpose, and will certainly be appropriate.

### Wall-Pocket for Magazines.

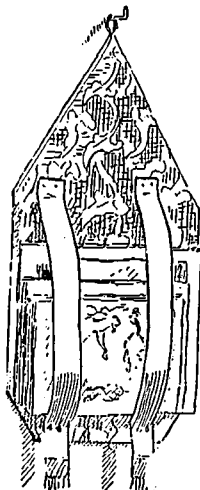

MAGAZINE HOLDER, pretty.

To make the article represented in the engraving, procure a board twenty-one inches long and ten wide; have it sawed to the shape shown in the illustration, and cover with some pretty dark cloth or cretonne. Take two bands of ribbon each twenty-four inches long; or, if preferred, two bands of the material used. Embroider and tack them on the board, as shown in the engraving, being careful to leave the ribbon full enough to slip the papers between it and the board. Place a screw-eye at the top of the board to secure it to the wall and finish the ribbon ends with a small tassel. It is both serviceable and

### Hints to Housekeepers.

Clean piano keys with a soft rag dipped in alcohol.

To clean a black dress, use a sponge dipped in strong black tea, cold.

A piece of sponge fastened to a stick is a good thing to clean lamp chimneys with.

To take out scorch lay the article that has been scorched in the bright sunshine.

Wipe flatirons on a cloth wet with coal oil and they will not scorch the clothing.

Oil-cloths should be rubbed off with a flannel cloth dipped in sweet milk once a week; rub well.

Take egg stains from silver by rubbing with a wet rag which has been dipped in common table salt.

In doing up fine lace do not use any starch, but in the last rinsing water dissolve a little fine white sugar.

Canned fruit is more delicious if it is opened an hour or two before it is needed, to restore the oxygen.

To keep flies away from gilt frames, boil four or five onions in a pint of water and put it on with soft brush.

A teaspoonful of borax added to cold starch will make clothes stiffer than anything else, though it adds no polish.

In using ammonia for domestic purposes one tablespoonful to about a quart of water is about the ordinary proportion.

To steam potatoes peel them, and when very clean put them in a colander over boiling water and leave them until done.

If you dip the wicks of lamps in strong hot vinegar and then dry them, it will do away with much of the disagreeable smell.

To clean ceilings that have been blackened by smoke from a lamp, wash off with rags that have been dipped in soda-water.

Clean a clothes wringer from the lint that collects on the rollers by saturating a cloth in kerosene and rubbing it well all over.

Lime water is good for chilblains. Use it both strong and hot. A saturated solution of alum in water, used hot, is also very efficacious.

Stains caused by sewing machine oil may be removed by rubbing the spots in a weak solution of ammonia before washing the garment.

To clean a tea-kettle, take it away from the fire and wash off with a rag dipped in kerosene, followed by a rubbing by a dry flannel cloth.

To preserve the color of black gingham or satinet gowns previous to washing dip them in boiling suds or in salt and water. Dry in the shade.

For simple hoarseness take a fresh egg, beat it and thicken with pulverized sugar. Eat freely of it and the hoarseness will soon be greatly relieved.

To clean hair brushes nicely sprinkle pulverized borax over them and let it remain on one half hour, then wash them thoroughly and rub them well.

Coffee spilled on damask may be taken out with yolk of an egg and a little wine mixed with warm water. After applying, wash off with warm water.

Turpentine is the best known substance for removing stains of paint, and if it is possible to apply the liquid at once not a vestige of the spots will remain.

Ribbons or silk which have become greasy may be cleaned by covering with pulverized French chalk and hold it near the fire, then it may be brushed off.

When your face and ears burn so terribly bathe them in very hot water, as hot as you can bear it. This will be more apt to cool them than any cold application.

Horseradish cut in thin strips lengthwise and a dozen or more of these strips placed on top of each keg of pickles will keep them from becoming stale or mouldy.



What a Boy Can Make.

"You know, Uncle, you promised to tell me of some of the things that you used to make when you were a boy, and describe how you made them. It rains this afternoon and I think this is just the time."

Although I was quite busy when my nephew

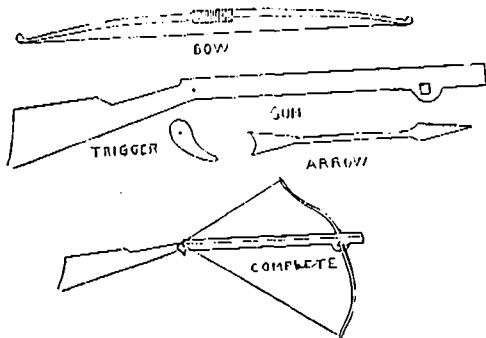

FIG. 1. THE CROSS GUN.

made this request, I was glad to gratify him, so I took out a piece of paper to illustrate, and began by asking him if he ever made a cross-gun, or, as some called it, a bow-gun.

"No, sir; what is it?"

"It is made like this: Get a good piece birch or oak—birch is the best—and make a strong bow about three feet long, just as you would for an ordinary bow and arrow, only the middle of the bow is made square for about two inches, tapering toward the ends. Be sure both sides are even as it will shoot better." Then I made him a picture of the bow as shown in the illustration in Fig. 1

"Now cut from a piece of pine board about an inch thick a model of a gun, having the barrel about one and a half inches thick. Within six inches of the end of the barrel on the under side make a knob, and cut a square hole in it just the

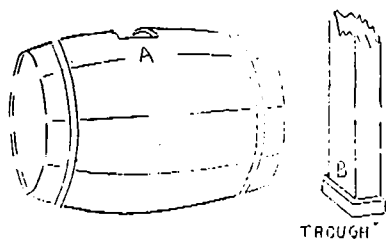

FIG. 2. BARREL AND TROUGH.

groove a notch is cut, to which you can attach a trigger, or the string can be pushed up with the finger. If you make a trigger, make it the shape of the diagram shown, and you will find that it will throw up the string nicely if screwed on just in front of the notch. The arrow can be made of a piece of pine wood. Make it like an ordinary arrow, but have the shaft wider and thinner than usual, like the one in the cut. Now you can put the bow into the barrel, string it up, and there is the complete cross gun, like this," and I drew a picture of the gun complete.

"Do you think you understand this well enough to make one?"

"Yes, sir, and I am going to try; but first I want to make a house for the two rabbits that Willie Mason brought over this morning. Father says I may keep them if I will make a safe pen."

When I was a boy I used to keep rabbits, and I knew just how to make what he wanted, so I replied:

"In the first place dig a hole about five feet deep and large enough to put in a large box, or a barrel. I think your father will give you an old barrel for the purpose. Saw out a hole at the bung about eight inches square. After you have placed the barrel in the right spot fill it full of earth and then build a trough from the barrel to about a foot from the top of the ground."

"I wish you would draw me a picture of it, Uncle, for I can understand so much better when I can see how it looks on paper."

So I drew a picture of the barrel with the hole in the top at A, as shown in Fig. 2. Then I made a

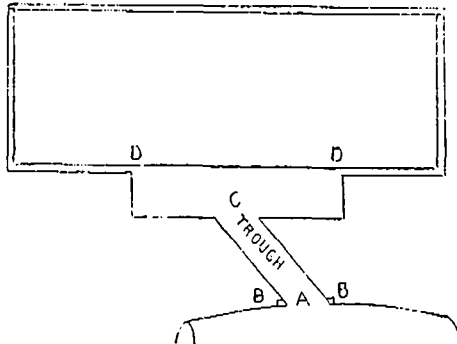

FIG. 3. THE PEN COMPLETE.

picture of the trough, and then one of the pen complete, which I call Fig. 3.

"The trough is made by nailing four boards together, and nailing some pieces of wood at the place marked B to keep it from slipping into the barrel and for fastening it to the edges of the square hole. After fastening it to the barrel fill it with earth.

It must be placed in a slanting position, for the rabbits could not climb up a straight surface. Then make a floor about four feet square, with an opening for the trough, as shown in Fig. 3 at C, and nail boards a foot wide around it which will bring it up even with the ground, as at D.D. Pack the earth all around the barrel and trough and then make a floor as large as you wish the pen to be. The square place in the center must then be filled with earth, and if you can get some turf put that over it. Then build the pen upon the floor as high as desired, either of slats or of poultry netting."

"But why do you make all the underground part?"

"Because rabbits like to burrow, and they do much better if they can do so. They will dig all over the square box of earth and will find the trough because that is the only place by which they can get down. There is room enough in the barrel to satisfy them, and they will at once make a nest. They will be perfectly contented with this pen because they can dig freely and at the same time they cannot get out, so your father will not have cause to complain."

A few days later I was called out to see the rabbits in their new pen and the boy had made it exactly as I have described it.

### Don't be Mean, Boys.

SOMETIMES I wonder, says Burdette, what a mean man thinks about when he goes to bed. When he turns down the light and lies down alone, he is then compelled to be honest with himself. Not a bright thought, not a generous impulse, not a word of blessing, not a grateful look comes back to him, not a penny dropped into the palm of poverty, not the balm of a loving word dropped into an aching heart, no sunbeams of encouragement cast upon a struggling life, no strong right hand of fellowship reached out to help some fallen man to his feet,—when none of those things come to him, how he must hate himself, how he must try to roll away from himself and sleep on the other side of the bed, when the only victory he can think of is some mean victory, in which he has wronged a neighbor.

No wonder he always sneers when he tries to smile. How pure and fair and good all the rest of the world must look to him, and how careless and dreary must his own path appear! Why, even one isolated act of meanness is enough to scatter cracker crumbs in the bed of the average man; and what must be the feelings of a man whose life is given up to mean acts?



size of the middle part of the bow, being sure to make a tight fit. It should be like this;" and I drew an outline of the gun, as shown.

"The top of the barrel must be grooved like the letter V to receive the arrow, and at the end of the



TRYING TO BE POPULAR.

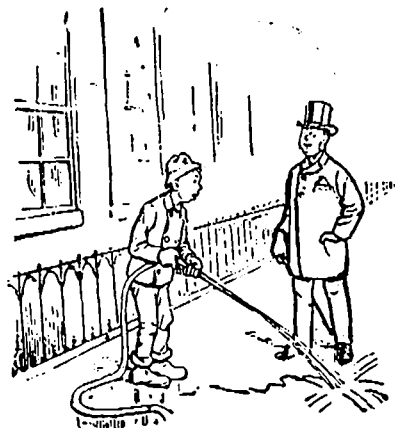

A WARNING TO POLITICIANS.

—Rural New Yorker.

"We must have an organ to support us," as the man said to his monkey.

AN EGG EPISODE.—The young woman who writes her name and address on the eggs, before she sends them to market, has received a proposal. It came from a man who proposed that hereafter she send strictly fresh eggs, instead of the stale ones she had been in the habit of sending. She no longer counts her chickens before they are hatched.

ALL YE WHO WOULD REAP ABUNDANT CROPS MUST PLOUGH, HARROW AND CULTIVATE THOROUGHLY AND WELL.

TO DO THIS, GOOD TOOLS ARE ABSOLUTELY ESSENTIAL, AND HERE THEY ARE



PATTERSON 2-FURROW STEEL FRAME GANG PLOW

SPECIAL PLOW CIRCULAR NOW READY.

Mailed to any address on application.

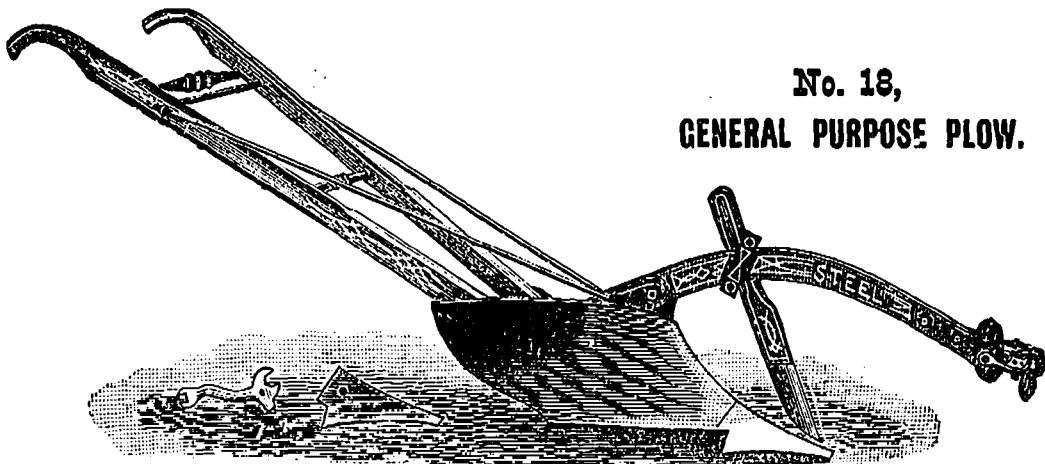

No. 18, GENERAL PURPOSE PLOW.

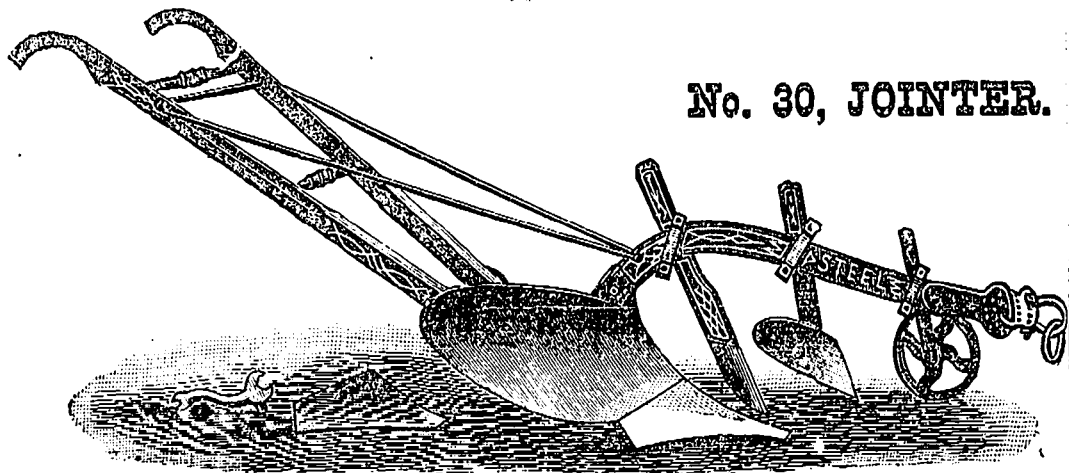

No. 30, JOINTER.

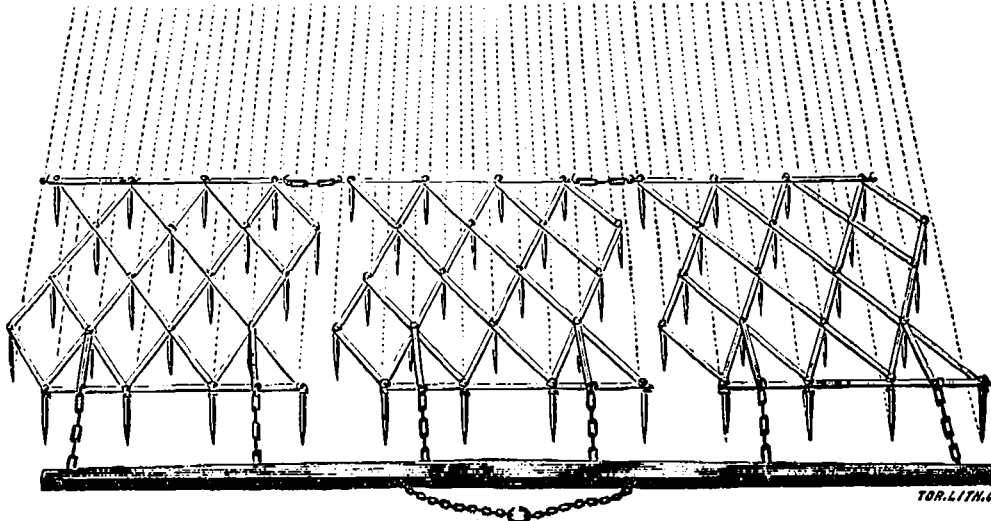

BRANTFORD STEEL TOOTH DIAMOND HARROW.

Three-Section, 60 teeth, cutting 10 feet wide. Four-Section, 80 teeth, cutting 13 ft. 6 in. wide. Five-Section, 100 teeth, cutting 17 feet wide.

MASSEY-HARRIS CO., LTD., TORONTO.



# Magnificent Line of SPRING GOODS.

THE PLOWS, HARROWS AND CULTIVATORS WE NOW OFFER HAVE NEVER BEEN EXCELLED.

## THE "WISNER" IMPROVED STEEL FRAME SPRING TOOTH HARROW.

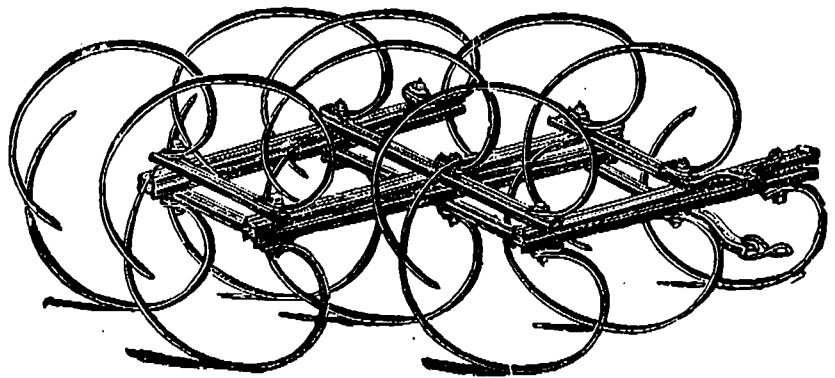

This view shows the Harrow folded ready for shipment or storage.

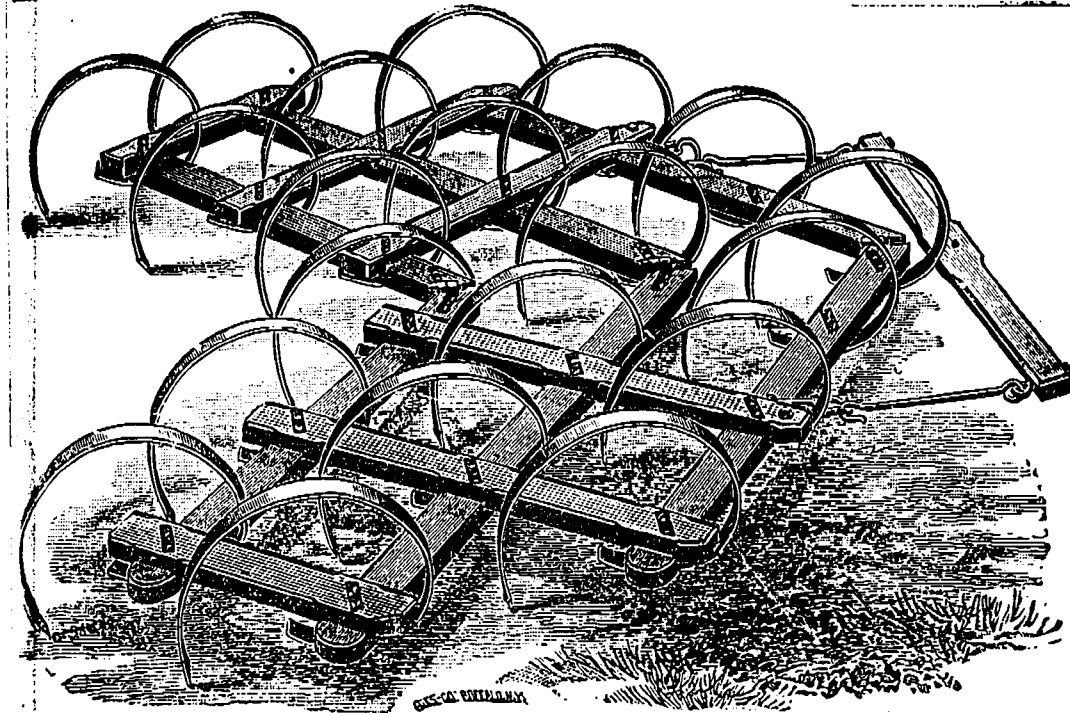

## The "Patterson" Spring Tooth Harrow.

It thoroughly loosens and pulverizes the soil.

**1000**'S OF CANADA'S BEST FARMERS USE THIS HARROW.

## THE "WISNER" Favorite Spring Tooth CULTIVATOR.

- Tubular Iron Frame.
- Oil Tempered Spring Steel Teeth.
- Has Patented Steel Runners.
- Has Patent Pressure Bars.
- Will work heavy clay land.
- Lighter Draught than any other.
- Boy can handle it easily.
- "Performs all and more than claimed."

Can be supplied with either four Steel Sections or three Wood Sections.

A Broadcast Seeder, with "Wisner" Feed Run, is supplied with this Cultivator when desired.

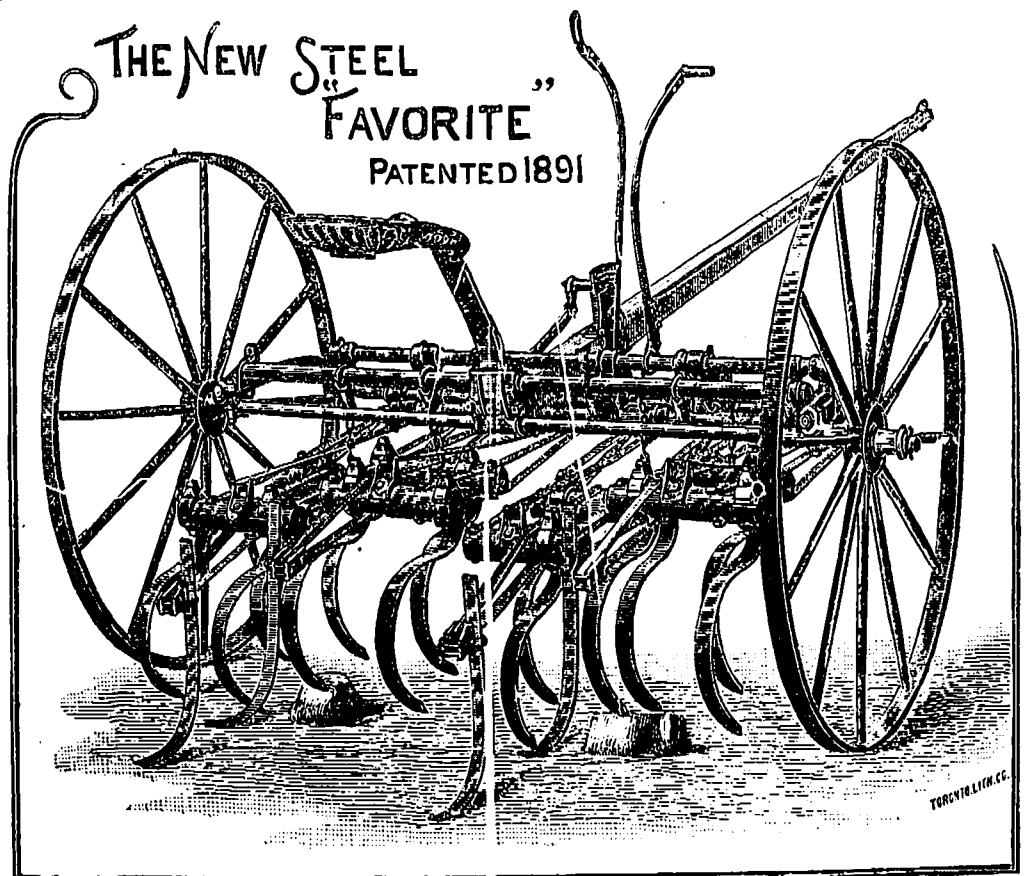

MANUFACTURED EXCLUSIVELY BY **MASSEY-HARRIS CO., LIMITED.** HEAD OFFICES, TORONTO, ONT.  
WORKS AT TORONTO, BRANTFORD AND WOODSTOCK.

# Rubber Belting!

## THE CANADIAN RUBBER CO. OF MONTREAL

Manufacture the Best Threshing Machine Belts in America.

ASK THE MERCHANT YOU DEAL WITH FOR THEM, AND TAKE NO OTHER.

### RUBBER

WESTERN BRANCH:  
Cor. Front & Yonge Sts., TORONTO.

### BELTING

## SAWYER & MASSEY CO., LTD. HAMILTON, CANADA.

### Side Crank Traction Engine

FOR COAL, WOOD OR STRAW.

### THE "L.D.S." Boiler & Engine

CONSTITUTE  
The Most Successful "Straw  
Burning" Power Outfit  
ever invented.

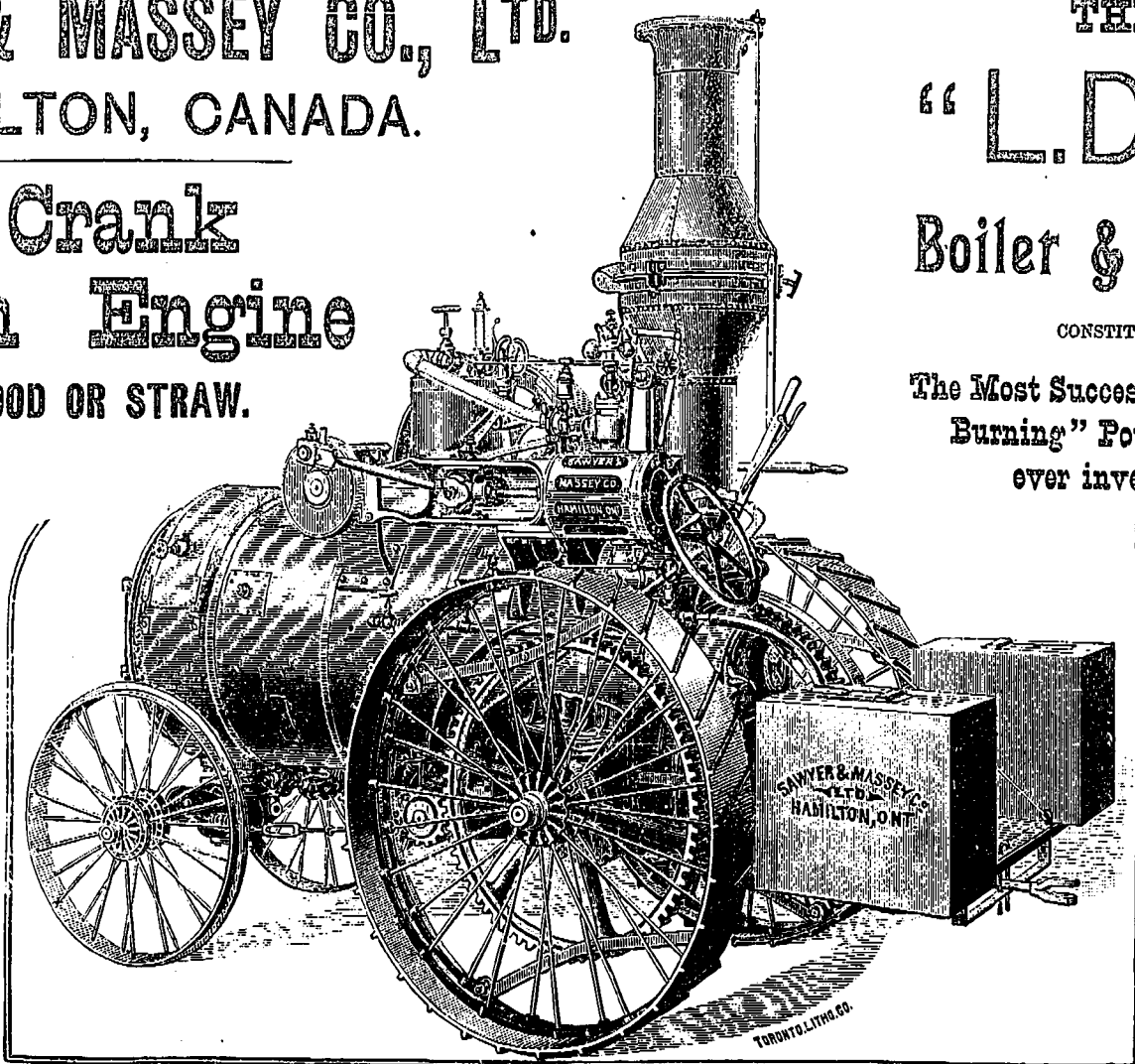

USES  
LESS  
FUEL.

GIVES  
MORE  
POWER.

Handsome Catalogue of our  
Celebrated  
**THRESHING MACHINE OUTFITS**  
sent to prospective purchasers  
on application.

# VAN ALLEN'S PATENT UNBREAKABLE AXLE.

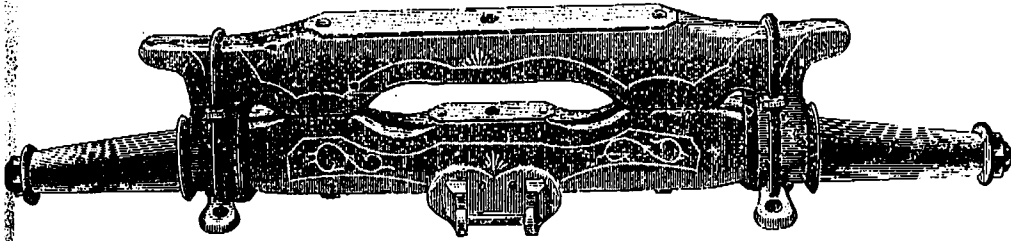

FRONT AXLE AND SANDBOARD OF THE CHAUTAUQUA GIANT.

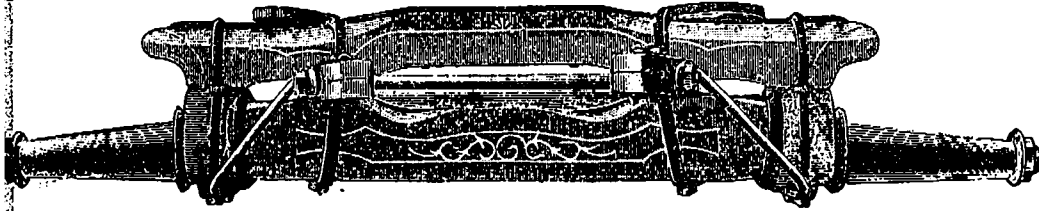

FRONT AXLE AND SANDBOARD OF THE CHATHAM GIANT.

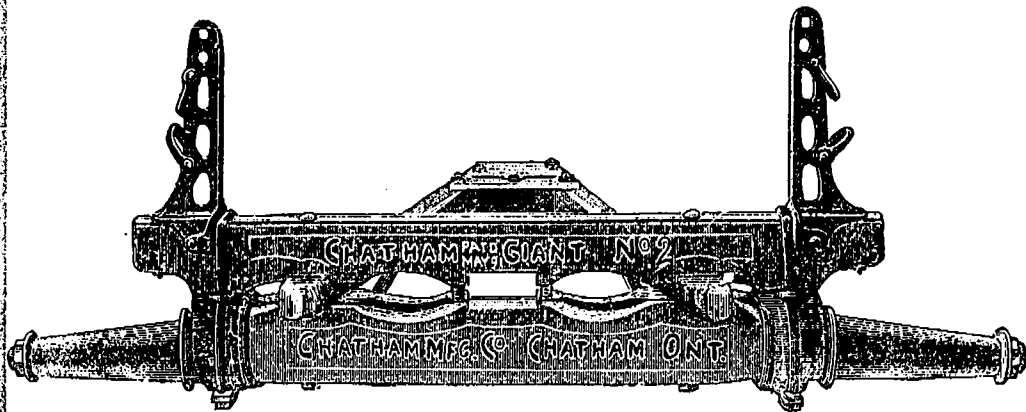

HIND AXLE AND BOLSTER OF BOTH THE CHAUTAUQUA AND CHATHAM GIANT.

The above cuts represent the latest and most important improvement ever made in the building of farm wagons, farm and log trucks and other wagons for heavy teaming.

This improvement was made by the undersigned, and patented in Canada in May, and in the United States in September of last year, and he is now open to treat with parties for the sale of the United States patent.

Being deeply interested in the Chatham Manufacturing Company, no consideration will induce him to give any competitor of that Company in the manufacture of wagons in Canada the privilege of using this improvement; certain as he is that wagons built in this way will have the monopoly wherever introduced. This fact must be self-evident to any beholder.

Referring to above cuts, it will be seen that the arms or thimble skeins are cast with a flat-topped stool on the upper side of shoulder that the ends of sandboard and bolster are formed to rest upon and are firmly clipped to, by which the front axle and sandboard and rear axle and bolster form each complete and solid truss, thus entirely transferring the pressure of the load from the axle to the very shoulder of the wheel, completely abolishing the old time breaking point of an axle, which all sorts of truss rods and hard running and costly steel skeins have been devised to reinforce, rendering these unnecessary and securing to farmers and teamsters the great boon of a marvellously strong and much lighter wagon and the great ease of running of the properly set cast thimble skeins, without much additional cost.

The unparalleled strength of this improved wagon was demonstrated in the presence of thousand on the 29th August last on the market place in this town, as the following certificate shows:

(COPY.)

TOWN WEIGH MASTER'S OFFICE,  
CHATHAM, ONT., August 29th, 1891.

I certify that I, this morning, weighed a wagon made by The Chatham Manufacturing Company (Limited), called a No. 3 or 3-inch cast iron Chautauqua Giant, loaded with pig iron, and found by the market scales the weight of wagon and load to be 5 tons, 1400 lbs.

(Signed), THOMAS HOLMES, Weigh Master.

The wagon referred to in above certificate has 3 inch cast thimble skeins and 2x½ inch tire, and weighs 700 lbs. Please note that The Chatham Manufacturing Company call these wagons "Giants," and that no great wagon concern rates the capacity of a 3-inch cast or steel skein wagon at more than 3000 lbs.

And the following clipped from "The Essex Free Press" relates another successful trial of the great strength of the Chatham Giant:

A TREMENDOUS LOAD.

"A GIANT WAGON."

"Farmers will no longer wonder why our townsmen, Mr. J. E. Stone, can scarcely supply the demand for the Chatham wagon and farm trucks after reading the following:

WATERWORKS BOILER AND ENGINE.

Essex, Nov. 4th, 1891.

"This is to certify that the boiler weighing six tons for the waterworks was conveyed from the M. C. R. freight sheds to the boiler house on an ordinary farm wagon manufactured by The Chatham Works. The same wagon also carried the pump, which weighs 5½ tons.

H. J. PURSER, Waterworks Contractor.

"The wagon was an ordinary farm wagon (not a truck), with 3½ inch Giant arm. The marvellous strength and carrying capacity of this make of wagon is due to an invention of the manager of the works, Mr. D. R. Van Allen."

**D. R. VAN ALLEN**

CHATHAM, ONTARIO, CANADA

CORRESPONDENCE SOLICITED.

**Toronto Lithographing Co.**  
GLOBE BUILDING.

Show Cards, Labels, Calendars,

Advertising Cards, etc

also, FINE WOOD ENGRAVING.



**BUNTIN, REID & CO.**

29 WELLINGTON STREET WEST,

TORONTO,

**Wholesale Stationers.**

Envelope and Blank Book Manufacturers.

**PAPER MANUFACTURERS AND DEALERS.**

Mills at Valleyfield, on the River St. Lawrence.



Every Stable should have Peerless Hoof Ointment.

ROGERS' PEERLESS MACHINE OIL is specially manufactured for Farmers' Machinery, and excels in all the qualities necessary for Farmers' use.

**FOUND AT LAST.**

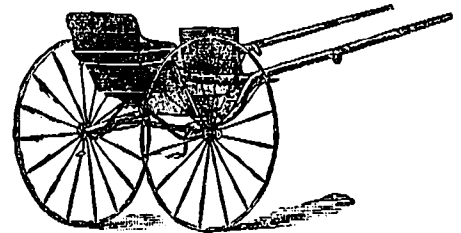

WRITE FOR PRICES.

A buggy with only two wheels to keep in repair, with all the convenience of a phaeton, at one-quarter the cost.

Manufactured Wholesale and Retail by

**J. W. BROWNELL, ST. THOMAS, ONT.**

**An Old Nurse for Children.**

**MRS. WINSLOW'S**

**Soothing Syrup,**

**FOR CHILDREN TEETHING.**

Should always be used for Children while Teething. It Soothes the Child, Softens the Gums, Allays all Pain, Cures Wind Colic and is the Best Remedy for Diarrhoea.

**TWENTY-FIVE CENTS A BOTTLE.**



**MASSEY'S ILLUSTRATED.**

An Independent Journal of News and Literature for Rural Homes.

PRINTED AND PUBLISHED BY THE MASSEY PRESS.

PROF. SCRIB. Editor.  
CHAS. MORRISON, Associate Editor.

**SUBSCRIPTION PRICE :**

To all parts of Canada and United States, only 50 cents per annum, postage prepaid. Stamps taken.

Always address MASSEY PRESS, Massey Street, Toronto, Can.

ADVERTISING RATES on application.

**THE CHATHAM FANNING MILL**

1000 sold in 1884  
1330 sold in 1885  
2000 sold in 1886  
2800 sold in 1887  
2800 sold in 1888  
3600 sold in 1889  
4000 sold in 1890  
4500 sold in 1901

More than have been sold by any ten Factories in Canada put together.

29,000 Chatham Mills now in use.

Over 7,000 Bagging Attachments now in use.

Bagging Attachment is run with a Chain Belt that cannot slip. The Elevator Caps are also attached to Endless Chain Belt that cannot slip nor clog.

SPECIAL ATTENTION GIVEN TO THE CLEANING OF ALSAC. CLOVER SEED.

The Mill is fitted with Screens and Riddles to clean and separate all kinds of Grain and Seed, and is sold with or without a Bagger.

**MANSON CAMPBELL, Chatham, Ont.**

For Sale by all Agents of MASSEY-HARRIS CO. LTD. in Manitoba, N.W.T., and Province of Quebec.

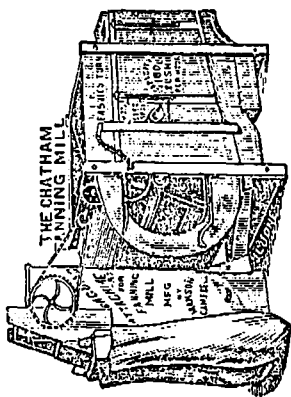

"A YARD OF ROSES." One of the popular paintings at the New York Academy of Design was a yard-long panel of Roses. A crowd was always before it. One art critic exclaimed, "Such a bit of nature should belong to all the people, it is too beautiful for one man to hide away." *The Youth's Companion*, of Boston, seized the idea, and spent twenty thousand dollars to reproduce the painting. The result has been a triumph of artistic delicacy and color. *The Companion* makes an autumn gift of this copy of the painting to each of its five hundred thousand subscribers. Any others who may subscribe now for the first time, and request it, will receive "The Yard of Roses" without extra charge while the edition lasts. Besides the gift of this beautiful picture all new subscribers will receive the Five Double Numbers and all the Illustrated Weekly Supplements. The price of *The Companion* is \$1.75 a year. See our Clubbing List for special combination price for MASSEY'S ILLUSTRATED and *Youth's Companion*. Every family should take this brightest and best of illustrated literary papers.

**W. H. VERITY & SONS, PLOW WORKS, EXETER, ONT.**

Established 1857.

This is without doubt the most popular Plow in the West to-day. Over ten thousand now in use. We also manufacture a full line of Sulky and Walking Plows. All made from the best American Centred Steels.

MASSEY-HARRIS CO., Ltd., Sole Agents from Manitoba to Pacific Coast.  
Full Line of Repairs kept constantly on hand.

**W. H. VERITY & SONS.**

**GURNEYS' FARM & STOCK SCALE.**

Patented April 25, 1888.

Portable on Wheels. With Drop Lever

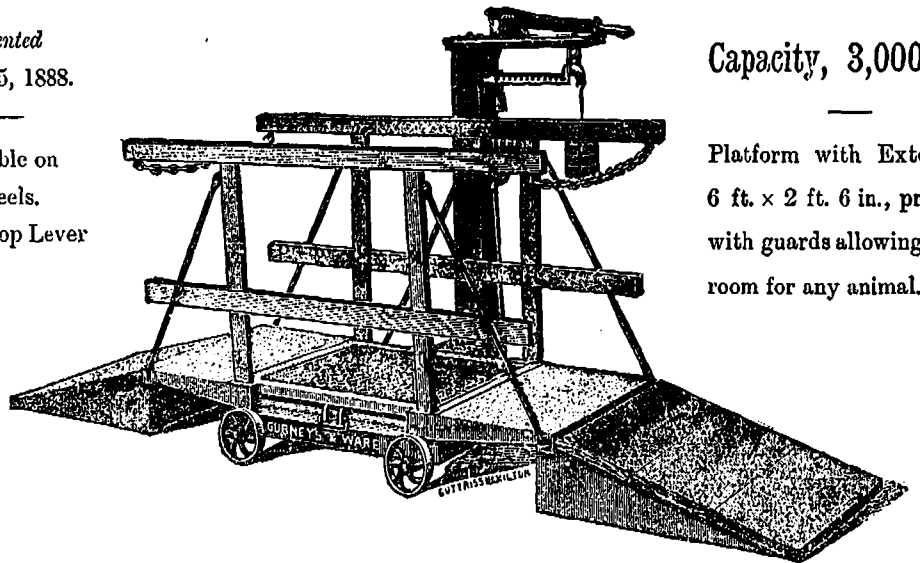

Capacity, 3,000 lbs  
Platform with Extension 6 ft. x 2 ft. 6 in., provided with guards allowing ample room for any animal.

So constructed that Extensions and Guards can be uncoupled when desired, and Scale used without them. This Scale was first introduced in 1888. We sold more Scales of this description in 1891 than we did in the three former years put together, showing its increasing popularity.

MANUFACTURED ONLY BY  
**THE GURNEY SCALE CO., - HAMILTON, ONT.**  
NOTE—We manufacture all kinds of Scales

**THE LEADING INSTRUMENTS.**

**BELL PIANOS**

See them  
—Hear them—  
—Buy no other

SEND FOR CATALOGUE TO  
**THE BELL ORGAN & PIANO CO., LTD., GUELPH, ONT.**

**DONALD C. RIDOUT & CO.,**  
Patent Experts.  
SOLICITORS OF HOME AND FOREIGN PATENTS.  
ESTABLISHED 1867. 22 King St. E., Toronto, Ont

**THE SHARP'S RAKE.**  
Over 40,000 have already been manufactured of this famous Rake, which speaks for its immense popularity.



# Rubber Belting

IF YOU WANT THE  
**FINEST THRESHING BELTS**

MADE, ASK YOUR DEALER TO GET FOR YOU THE

## 'MONARCH' BRAND

It will cost more at first, but will be economy in the end

MANUFACTURED SOLELY BY

### THE GUTTA PERCHA & RUBBER MANUFACTURING CO

OF TORONTO.

43 Yonge Street, Toronto.

### THE A. G. PEUCHEN CO., LIMITED,

MANUFACTURERS OF

## PAINTS, VARNISHES, Pure Paris Green

Now making for next Season 200 tons.

Farmers' Paint for Outhouses sold by all Hardware Men  
at 60 cents per gallon, in five-gallon Buckets.

MAKERS OF PAINTS AND VARNISHES FOR MASSEY-HARRIS CO., LTD.

FACTORY AND OFFICE:

Leslie Street, TORONTO.

### PERIODICALS.

If you have not yet subscribed for the Periodicals you usually take, see our Clubbing List on the previous page, and save money.

### THE MASSEY PRESS

Farmers, save your Teams and Wagons by using  
The Best Bolster Spring on Earth

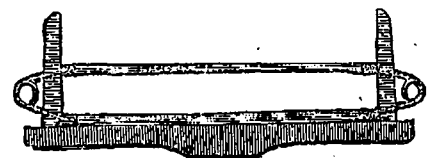

Also Responsible pushing Agents wanted. Address  
**VEHICLE SPRING & M'FG CO**  
BRIGHTON, ONT.

### BOYS FOR FARM HELP.

The managers of DR. BARNARDO'S HOMES desire to obtain good situations with farmers throughout the country for boys they are sending out from time to time from their London Homes. There are at present nearly 3,000 children in these Homes, receiving an industrial training and education to fit them for positions of usefulness in life; and those who are sent to Canada will be selected with the utmost care, with a view to their moral and physical suitability for Canadian farm life. Farmers requiring such help are invited to apply to  
**MR. ALFRED B. OWEN, Agent Dr. Barnardo's Homes**  
214 Farley Avenue, Toronto.

## WISNER SEEDING MACHINES

Catalogues of these celebrated Machines now ready for distribution. Copy sent post free to prospective purchasers.

**MASSEY-HARRIS CO., LTD., TORONTO**