

THE FARMER'S ADVOCATE

AND HOME MAGAZINE

PERSEVERE
SUCCEED
FOUNDED 1875

* AGRICULTURE, STOCK, DAIRY, POULTRY, HORTICULTURE, VETERINARY, HOME CIRCLE.*

PUBLISHED AT LONDON, ONTARIO, DECEMBER 1, 1902. WINNIPEG, MANITOBA. No. 563

BELL ART Pianos and Organs

LAST LONGEST AND YIELD BEST RESULTS BECAUSE THEY ARE MADE FROM BEST MATERIALS, IN THE MOST CAREFUL MANNER.

THE NEW ORGAN FOR HOME USE IS THE

BELLOLIAN

ANYONE CAN PLAY IT WITHOUT STUDYING MUSIC.

MADE BY

Bell Organ & Piano Co. (LIMITED).

QUELPH, ONTARIO.

CATALOGUE No. 40 FREE ON REQUEST.

A Savings Account

Gives its possessor a feeling of security and relieves him from anxiety about the future, and more especially if the money is on deposit with a SOUND CANADIAN CHARITABLE BANK, whence it can readily be withdrawn without trouble, delay or "red tape."

A SPECIAL SAVINGS DEPARTMENT is open at every branch of

The Sovereign Bank of Canada

where interest is allowed on deposits of \$1 and upwards.

HEAD OFFICE: TORONTO.

CHIEF EXECUTIVE OFFICE: MONTREAL.

Branches at: Toronto, Ont.; Montreal, Que.; Amherstburg, Ont.; Clinton, Ont.; Exeter, Ont.; Milverton, Ont.; Mount Albert, Ont.; Newmarket, Ont.; Ottawa, Ont.; Perth, Ont.; St. Catharines, Ont.; Stirling, Ont.; Stouffville, Ont.; Sutton, Que.; Unionville, Ont.; Waterloo, Que.

will devote his attention especially to

DR. PINGEL X RAY TREATMENT

of Cancer, Lupus and other tubercular affections.

Office—444 Wellington St., London, Ont.

CONTENTS OF THIS NUMBER.

EDITORIAL.	PAGE.
THE QUEST FOR KNOWLEDGE	865
THE DAIRY OUTLOOK	865
THE CALEB JINKINS LETTERS	865
RENEWING TIME	866
ANOTHER GREAT RAILWAY; THE FARMER AND SCIENCE	866
POINTERS; STANDARD OF JUDGING	866
HORSES.—ADHERENCE TO TYPE IN HORSE JUDGING	867
FEED AND FIT BEFORE SELLING	867
THE IDLE HORSE IN WINTER	867
GOLDEN CHARM (ILLUSTRATION)	867
KING OF THE CLYDES [2563] (10788)	868
STOCK.—THE FIRST MONTH IN STALL FEEDING	867
OUR SCOTTISH LETTER	868
KINDNESS TO STOCK; BREEDING THE SOWS	868
AMENDING THE EMBARGO	868
THE SHEEP PROTECTION ACT; CANADA'S INTEREST IN AUSTRALIA	869
SUMMER HILL MEMBER (ILLUSTRATION)	869
VIEW OF THE FARM OF MR. J. V. COOPER, PRINCE EDWARD CO., ONT. (ILLUSTRATION)	869
THE HOME OF MESSRS. THOS. BIGGAE & SONS (ILLUSTRATION)	870
DIGNITY OF THE BREEDER'S CALLING	870
SNAPSHOTS AT BRITISH AGRICULTURE	870
SELECTION OF THE BEEF SIRE	870
VIEW ON THE CHAPLTON FARM (ILLUSTRATION)	870
THE TUBERCULIN TEST AND IMPORTED CATTLE	871
WINTER CARE OF BREEDING EWES	871
DISCARD THE SOUR SWILL BARREL	871
CHALLENGER (ILLUSTRATION)	871
TO REMOVE WARTS; HAMPSHIRE DOWN SHEEP	871
SHEEP OR DOGS, WHICH? (ILLUSTRATION)	871
THE SHOTGUN METHOD	871
PRIDE OF MORNING (10838), IMP. (ILLUSTRATION)	874
FARM.—RURAL MAIL DELIVERY; RURAL MAIL DELIVERY	871
START THE RURAL MAIL DELIVERY	872
THE FOOD VALUE OF OATS	872
LARGE FARMS AND THEIR MANAGEMENT	872
FARM HOME OF WM. McRAE, KEEFoot, MAN. (ILLUSTRATION)	872
VALUE OF MARL AS A FERTILIZER; SAVE THE WOOD ASHES	872
FENCING HIGHWAYS; ANOTHER CANADIAN SUGAR BEET FACTORY	873
CALEB JINKINS: HIS LETTER (ILLUSTRATED)	873
CANADIAN HACHNEY WINS CHAMPIONSHIP	873
WOODMAN'S POINT, ON ST. JOHN RIVER, KING'S CO., N. B. (ILLUS.)	876
ST. PATRICK'S CHURCH, SCHOOL AND GLEBE—HOUSE (ILLUS.)	877
DAIRY.—DAIRY INSTRUCTION AT FACTORIES	873
STRATHROY DAIRY SCHOOL; NO CREAMERY TRUST	873
COMPTON MODEL FARM CREAMERY	874
PREVENTION OF MILK FEVER; MANIPULATION MILKING	874
CALF FEEDING; DAIRYING IN EGYPT; THE CARE OF CREAM	875
GARDEN AND ORCHARD.—WINTER PRUNING	875
HARVESTING POTATOES, SPRING LAKE FARM, MICH. (ILLUSTRATION)	875
FLOWERS IN THE HOME; APPLES FOR HOME USE	875
GUARD AGAINST MICE; SPRAYING WITH LIME IN WINTER	875
APPLE POMACE AS MANURE; PLEASED WITH THE WATCH	876
POULTRY.—HOW TO FEED FOR WINTER EGGS	876
APIARY.—THE BEEKEEPER IN WINTER	876
DATE OF CONVENTION CHANGED	876
QUESTIONS AND ANSWERS.	
VETERINARY: SYMPTOMS OF ANTHRAX; INFLUENZA; RINGBONE; PARAPLEGIA IN COW; HEMATUURIA; SICK HEIFER; SICK DOG; GROWTH IN COW'S EYE; INVERSION OF WOMB IN EWES; HEAVES IN MARE, ALSO SPINT; RIDGELING; HEAVES	876, 877
MISCELLANEOUS: EMPLOYMENT ON RAILWAY; DORSETS AND DOGS; WAGES CLAIMS; CONCRETE FOR CELLAR WALL; PROBLEMS IN DRAINAGE; DAMAGES FOR LOSS OF LAMBS; FEEDING WHEAT TO STOCK; RECONSTRUCTION OF STOCK; WORMEAD MUSTARD—CHICKWAD; COUGH IN PIGS; WOOLLY BEAR CATERPILLAR—KEEPING CEMENT OVER WINTER; WHITE HAIR ON SHOULDER; COLORING COLT'S HAIR; KEEPING CIDER SWEET; AN OCCUPATION RENT; REGISTRATION OF CLYDESDALE; SILO CONSTRUCTION AND FILLING; A FARMER'S FIRM—LEASE WITH OPTION TO PURCHASE	877, 878
FARM GOSSIP.	
SCOTTISH EDITOR'S VISIT; FORESTRY ASSOCIATION REPORT; PEAT FUEL; WESTERN CATTLE FOR ONTARIO FREDERS; THE MACDONALD BENEFACTION; NOTES FROM OTTAWA; WHERE BRITAIN BUYS HORSES; EXPERIMENTAL UNION; DEVICE FOR COLTER (ILLUSTRATED); FAT STOCK CLUB BANQUET; CHINAMEN IN BERLIN BRET FIELDS; FARMERS INSTITUTE PROGRESS; BARNARD'S HOMES; LINCOLN CO., ONT.; SHEEP AND DOGS; COMING OUR WAY	878, 879
MARKETS.	
TORONTO MARKETS	880
MONTREAL MARKETS	880
BRITISH CATTLE MARKETS	880
CHICAGO MARKETS	880
EAST BUFFALO MARKETS	880
HOME MAGAZINE.	
THE FAMILY CIRCLE	881
FATHER'S RETURN (ILLUSTRATION)	882
THE QUIET HOUR	883
THE CHILDREN'S CORNER	883
POPE LEO X. TAKING HIS LAST FAREWELL OF RAPHAEL (ILLUS.)	884
INGLE NOOK CHATS	885
GOSSIP	885, 886, 887, 888, 889, 892, 894, 896
BOOK REVIEW	891
NOTICES	885, 888
ADVERTISEMENTS	881 to 891, 885 to 900

PUBLISHED TWICE A MONTH, AT LONDON AND WINNIPEG, CAN. PLEASE MENTION FARMER'S ADVOCATE

Dissolves Easily.

Windsor Salt is very soluble. Its pure, white, delicate crystals are quickly absorbed in the butter. It makes buttermaking easier and more profitable.

Windsor Salt.

What frayed your linen?
Not Sunlight Soap—
No, indeed!

SUNLIGHT SOAP

REDUCES EXPENSE

Ask for the Octagon Bar

EASTLAKE

Steel Shingles

are made so carefully and accurately that they are fitted together with perfect ease.

Their patent side lock is the best shingle "wrinkle" you ever came across. It's a great help to be able to apply them so quickly and easily.

They are the popular lightning, rust and fire-proof roofing for all farm buildings.

Metallic Roofing Co., Ltd.

TORONTO MONTREAL WINNIPEG

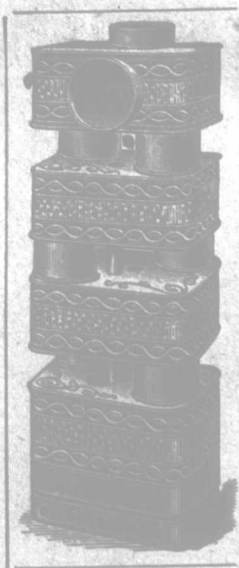

Save Your Fuel.

Winnipeg Heater Co., Toronto:
Dear Sirs, - I enclose ten dollars for one of your heaters. It is for a house heated by a furnace. I had one myself when they first came out, and I find them great savers of wood.
Yours truly,
C. H. GILES,
Fredericton, N.B.

Winnipeg Heater Co. of Toronto, Ltd., TORONTO, CAN.

WOODSTOCK STEEL WINDMILLS

Galvanized or Painted. For Power or Pumping. The



DANDY Windmill

with Graphite Bearings, runs easy and controls itself in the storm.
GRINDERS, PUMPS, WATER TANKS, DRINKING BASINS AND SAW BENCHES.

WOODSTOCK WIND-MOTOR CO., WOODSTOCK, ONT. (LTD.)

For Camp, Cottage or Summer Home:
Perfection Wickless Blue Flame
Oil Stove
1, 2, 3, 4 or 5 Burners and Oven.
Burns ordinary coal oil safely, economically and WITHOUT ODOR. Ask dealers.
Queen City Oil Company, Limited
WHOLESALE. TORONTO.

British Columbia Farms. Mild climate, the best dairying country in North America. No blizzards. No cyclones. No droughts. No hot winds. No summer frosts. No cloudbursts. The heaviest crops per acre in Canada. We make this statement without fear of contradiction. Cool nights and good water. The best price for all kinds of farm produce. THE CALIFORNIA OF CANADA, with land at one-tenth the price.
Write for farm pamphlet to
THE SETTLERS' ASSOCIATION, BOX 540 VANCOUVER, B. C.
Please refer to this paper.

Standard Scales
For railroad, hay, live stock, dairy, coal and platform.
For prices and particulars write or call on
GEO. M. FOX,
YORK STREET, LONDON, ONT.

The Daniels Incubators
Are the latest and most modern invention for artificial hatching of turkeys, chickens and ducks. Do not forget, we guarantee the Daniels incubators to be satisfactory to the purchaser. Our brooders are perfect; at least our customers say so. We carry a full line of poultry supplies. Our new catalogue is out, and is free for the asking.
C. J. DANIELS, 196 to 200 River St., TORONTO.

WE HAVE A LARGE STOCK OF SECOND-HAND TYPEWRITERS

Of nearly all makes, including REMINGTONS, JEWETTS, FRANKLINS, UNDERWOODS, CALIGRAPHS, HAMMONDS, BAR-LOCKS, FOXES, OLIVERS and BLICKENSDERFERS, which we are selling at from \$15.00 up. We are sole dealers for the

SMITH PREMIER TYPEWRITER

Which is the business and professional man's typewriter. All the largest railroads, insurance and commercial companies use the Smith Premier almost exclusively, and are satisfied that it is the BEST. Write for illustrated catalogue.

NEWSOME & GILBERT, SOLE DEALERS, 68-72 VICTORIA STREET, TORONTO, ONTARIO.

WOVEN WIRE FENCING

MANUFACTURED IN CANADA

The best selling because the most satisfactory.

"American" Field Fences

For horses, cattle, sheep, and hogs. All styles and heights—20 inches to 58 inches high, with stays 12 inches or 6 inches apart.



"Ellwood" Field, Farm and Lawn Fences.

Six styles. Heights, 18 inches to 58 inches.

If you can't get the celebrated AMERICAN and ELLWOOD fences from your dealer write to us and we will help you.

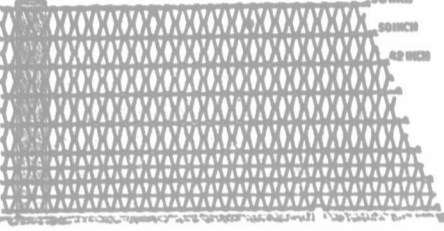

The CANADIAN STEEL & WIRE CO. (LIMITED), HAMILTON, CANADA.

"ELLWOOD" FENCE.

THE RAZOR STEEL, SECRET TEMPER, CROSS-CUT SAW.

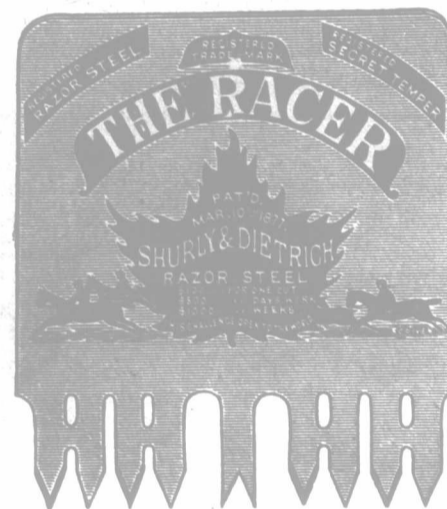

WE take pleasure in offering to the public a saw manufactured of the finest quality of steel, and a temper which toughens and refines the steel, gives a keener cutting edge, and holds it longer than by any process known. A saw to cut fast "must hold a keen cutting edge."

This secret process of temper is known and used only by ourselves. These saws are elliptic ground thin back, requiring less set than saws now made perfect taper from tooth to back.

Now, we ask you, when you go to buy a Saw, to ask for the Maple Leaf, Razor Steel, Secret Temper Saw, and if you are told that some other Saw is as good, ask your merchant to let you take them both home, and try them, and keep the one you like best. Silver steel is no longer a guarantee of quality, as some of the poorest steel made is now branded silver steel. We have the sole right for the "Razor Steel" brand.

It does not pay to buy a saw for one dollar less, and lose 25 cents per day in labor. Your saw must hold a keen edge to do a large day's work. Thousands of these saws are shipped to the United States and sold at a higher price than the best American saws.

MANUFACTURED ONLY BY SHURLY & DIETRICH, GALT, ONTARIO.

FREE RIFLE
Sure death to Rats, Crows, Squirrels, Rabbits, etc. Long Range. Terrific Force.
All steel barre and fitting, improved sights, walnut stock.
The best Air Gun made. Given for selling at 25c. each, only 12 packages of Chinese blue black ink powder. Each package makes 25c. worth of superior ink. It is cheap and useful that everybody buys. Write for ink powder to-day. THE NATIONAL PEN AND INK CO., TORONTO.

SHOT GUN FREE
For doing two things: (1) selling at 15c. each, only 12 handsome pieces of Jewelry: Stick Pins, Brooches, Lockets, etc. (2) Getting 3 more agents to do the same or by selling 2 or yourself. Every piece of Jewelry looks worth 50c. At our price 15c., everybody buys. This splendid gun is finely made with best quality steel barrel, taper choked bore, reliable lock, highly finished hardwood stock with steel shoulder plate and trigger guard, and metal tipped ramrod. It is accurately sighted and guaranteed a splendid shooter. Dealers ask \$6.00 for this gun. You can get one absolutely free in exchange for a few minutes of your spare time. Write to-day and we will send you the Jewelry postpaid. THE NATIONAL WATCH AND JEWELRY CO., DEPT. 568, TORONTO, ONTARIO.

The U. S. Separator has the advantage of being able to get more cream out of the milk than the others. At the Pan-American Exposition, 1901, it averaged for 50 consecutive runs, .0138 of 1% and established THE WORLD'S RECORD thus proving its right to its claim of BEING THE CLEANEST SKIMMER MADE. This, together with its many other advantages described in our catalogues, should remove any doubts that dairymen may have as to which is the best separator to buy. Write for descriptive catalogue. VERMONT FARM MACHINE CO., Bellows Falls, Vt. There is no delay on U. S. Separators shipped into Canada.

Catalogue of any of the following will be mailed to your address:

THE BRITISH AMERICAN BUSINESS COLLEGE
Y.M.C.A. Building, Yonge and McGill Streets, Toronto, Ont.
D. Hoskins, Chartered Accountant, Principal.
J. W. Westervelt, C. A., Vice-Principal.

THE CANADA AND HAMILTON BUSINESS COLLEGES
Arcade and Y.M.C.A. Buildings, Hamilton, Ont.
R. E. Gallagher, Principal.

THE FOREST CITY BUSINESS AND SHORTHAND COLLEGE
Y. M. C. A. Building, London, Ont.
J. W. Westervelt, Principal.

THE OTTAWA AND METROPOLITAN BUSINESS COLLEGES, OTTAWA
S. T. Willis, Prin. Metropolitan Business College
W. E. Gowling, Prin. Ottawa Business College.

BRANCHES:
The St. Catharines Business College
T. F. Wright, Principal.
The Berlin Business College
W. D. Euler, Principal.
The Brantford Business College
Jas. Swinton, Principal.
The Galt Business College
J. W. Wiggins, Principal.
The Sarnia Business College
W. H. Stapleton, Principal.

The Federated Business Colleges of Ontario, Limited, stand for all that is best in commercial education in Canada. Attend a Federation College.

C. R. McCULLOUGH, SEC'Y.
HAMILTON, ONT.

The First Step to the Success of hundreds of bright young men and women has been the thorough business and short-hand education given at the NIMMO & HARRISON Business and Shorthand College, COR. YONGE AND COLLEGE STS., TORONTO. Capable teachers, splendid equipment, individual instruction, high record of good results. Circulars free on request. Send for them.

ENTER NOW IF POSSIBLE. CENTRAL Business College STRATFORD, ONTARIO. A school that occupies front rank among the best business colleges on this continent. Those desiring the best in business education are invited to write for our catalogue. W. J. ELLIOTT, PRINCIPAL.

Ontario Business College BELLEVILLE, ONT., Has stood the test of a third of a century, and held its primacy against all competitors. Send for the 34th Annual Catalogue. Address: ROBINSON & JOHNSON, F. C. A. BELLEVILLE, ONT.

BOYS FOR FARM HELP. The Managers of Dr. Barnardo's Homes invite applications from farmers, or others, for the boys who are arriving periodically from England to be placed in this country. The young immigrants are mostly between 11 and 13 years of age; all will have passed through a period of training in Dr. Barnardo's English Institutions, and will have been carefully selected with a view to their moral and physical suitability for Canadian life. Full particulars as to the terms and conditions upon which the boys are placed may be obtained upon application to Mr. Alfred B. Owen, Agent Dr. Barnardo's Homes, 214 Farley Ave., Toronto. PLEASE MENTION FARMER'S ADVOCATE,

THE
Excelsior Life
INSURANCE CO.
Head Office: - - Toronto, Ont.
Absolute Protection. Profitable Investment. Agents wanted.

No. 3 "Prize"
Best Feed Grinder Money Can Buy for Operation with Gasoline or Steam Engine, Tread Power, Power Wind Mill, etc.
WHY? Because it makes splendid feed, table meal or graham flour, has ample capacity for 4 or 5 horse power, and an automatic feed regulator, which prevents its choking down the lightest power; is built throughout of iron and steel and will last a life-time. Thousands in use for 10 and 15 years still as good as new. We make 25 sizes and styles of Feed Grinders, including the only really successful Oats and Oat, and Corn, Oat and Buck Feed Grinders. Also a full line of Ensilage and Fodder Cutters, Huskers, Shellers, Wood Saws, Sweep Horse Powers, Tread Horse Powers, Wind Mills, etc.
Write to-day for free catalogue.
APPLETON MFG. CO., 53 Fargo St. Batavia Ill.

A BARGAIN
One 2-horse Tread Power.
No. 7 Alexandra Separator.
No. 6 Daisy Churn.
With shafting and belting, complete. For prices write—
W. C. SHEARER, BRIGHT, ONT.

WALKERVILLE WAGONS
ARE THE BEST
Walkerville Wagon Co. LIMITED
WALKERVILLE, ONT.
WRITE FOR CATALOGS.

The Elmira Food Boiler

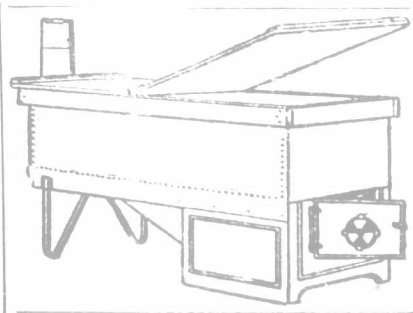

It is—
**SIMPLE,
DURABLE,
ECONOMICAL
AND CHEAP.**

Constructed of heavy galvanized sheet steel and cast iron. Will burn wood or soft coal without changing grates. You will save over 25% by cooking feed for hogs or stock. Built in three sizes—40, 90, and 125 gallon capacity. Write for prices.

The **ELMIRA AGRICULTURAL WORKS CO., Limited,**
ELMIRA, ONT.

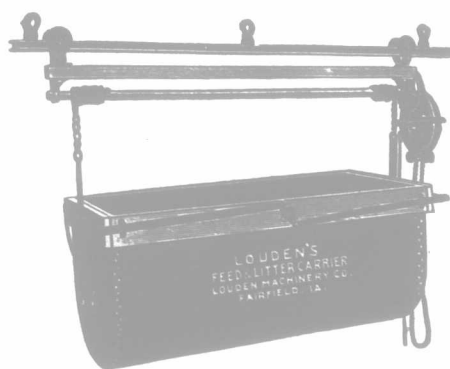

YOU NEED THIS.
No modern cow stable is complete without

LOUDEN'S FEED AND LITTER CARRIER

Hundreds of them in use and all giving satisfaction. By using our Double-Beaded Steel Track you can curve it in any direction, and we also make switches so that it can be used with any number of rows of animals. Write for circulars and prices. We also make the best line of Hay Carriers and Barn-Door Hangers in Canada. Agents wanted.

LOUDEN MACHINERY CO.,
WINDSOR, ONT.



FREE VIOLIN.

Powerful Sweet Tone with strings and bow, full size, Stradivarius model, made of selected wood, with highly-polished top, inlaid edges and ebony-finished trimmings, given for doing 3 things: (1) selling at 10c. each, 15 packages of Lemon, Vanilla and Almond Flavoring Powders; (2) getting 3 more agents to do the same, or by selling 21 dozen yourself. Each package equals 2c. worth of Liquid Flavoring and is far better. Everybody buys. You can earn this Grand Concert Violin in a few minutes. Write to-day and we will send the Flavoring Powders postpaid.
THE HOME ART CO., DEPT. 576, TORONTO, ONTARIO.

A MACHINE
to weave your own fence of
Called Hard Steel
Spring Wire,
32 inches high, at
25 Cts. Per ROD.
825 buys wire for 100-
Rod Fences. Agents
Wanted. Catalogue Free.
OARTEE
Wire Fence Machine Co.
Box B
Elgertown, Ont.



ROCK SALT for horses and cattle, in ton and car lots.
Toronto Salt Works, Toronto.

Save Your Fruit

and dry it with
Champion Fruit Evaporator.



Dries all kinds of fruit and vegetables, producing a superior quality of clean white fruit. It is made of galvanized iron, is lined throughout with asbestos, is fireproof and portable. Made in live sizes.

Catalogue for the asking.
THE GRIMM MFG. CO.,
64 WELLINGTON STREET, MONTREAL.

Catalogue Printing Our Specialty.

Many of the best Catalogues in Canada are produced by us. Latest type faces, designs, ornaments, and modern machinery. — Best in America. Up-to-date covers designed by special artists without extra charge.

London Printing & Litho. Company, Ltd.,
LONDON, ONTARIO.



The Entire Family Enjoys The Berliner Gram-o-phone!

The Berliner GRAM-O-PHONE

is an Enjoyable ENTERTAINER for Every Member of the Family.

Nursery rhymes, lullabies for the little tots; band and banjo music, comic songs, minstrel shows and choruses, and music and songs from the latest light operas for the young men; violin, guitar, mandolin and piano music, and sentimental and operatic songs for the young ladies; orchestral music, grand opera, songs of Scotland and Ireland, and choir and church music for the old folks, and hundreds of other instrumental and vocal selections that will enjoyably entertain the entire family and their friends. We're always adding something new. The Berliner Gram-o-phone is the only talking machine made in Canada, and guaranteed for five years.

Our new "Automatic Sound Box" gives the Gram-o-phone undoubted precedence over all other talking machines, no matter what the price. **RECORDS—50c. each; \$5.00 a dozen.** Records are sold for cash only—practically indestructible

Here Are a Few of Our New Records. There Are Over a Thousand More:

- BAND RECORDS.**
- 64 At a Georgia Camp Meeting.
 - 82 Whistling Rufus.
 - 105 Nearer, My God, to Thee.
 - 187 Imperial Edward March.
 - 208 A Mosquito Parade.
 - 300 Washington Post March.
 - 482 Blue Danube Waltz.
 - 578 God Save the King.
 - 803 Reminiscences of Scotland.
 - 808 Bonnie Brier Bush March.
 - 807 Soldiers of the Queen.
 - 805 The Maple Leaf.
 - 810 John Anderson, My Joe.
 - 806 Scotland's Pride.
 - 821 Lancers, 1st and 2nd Figures.
 - 822 " 3rd and 4th Figures.

- 823 Lancers, 5th Figure.
 - 824 Quadrille, 1st and 2nd.
 - 825 " 3rd and 4th.
 - 826 " 5th.
 - 203 Wearing of the Green.
 - 555 Scots Wha Hae.
- SONGS.**
- 696 Good-Bye, Dolly Gray.
 - 750 When the Roses Bloom Again.
 - 273 Sweet Annie Moore.
 - 735 The Blue and the Gray.
 - 134 Where is My Wandering Boy To-night
 - 131 Stay in Your Own Back Yard.
 - 432 In the Golden Field of Grain.
 - 66 The Bridge.
 - 204 All Hail the Power of Jesus' Name.
 - 109 Private Tommy Atkins.

- 309 Whistling Mike.
 - 310 Whistling Coon.
 - 453 And Her Golden Hair was Hanging.
- RECITATIONS.**
- 266 Auction Sale of Household Goods.
 - 268 Scene at a Dog Fight.
 - 263 Sermon on the Mount.
 - 552 23rd Psalm and Lord's Prayer.
- VOCAL QUARTETS.**
- 495 Blue Bells of Scotland.
 - 483 My Faith Looks Up to Thee.
 - 383 The Holy City.
 - 754 In the Sweet Bye-and-Bye.
 - 36 Evening Prayer.
 - 80 I've Gwine Back to Dixie.

- COON AND COMIC SONGS.**
- 727 Coon, Coon, Coon.
 - 725 Hear Dem Bells.
 - 722 Turkey in de Straw.
 - 282 Just Because She Made Dem Goo-Goo Eyes.
 - 731 Good Morning, Carrie.
 - 788 Bill Bally, Won't You Please Come Home!
 - 674 My Dinah.
 - 504 A Little Bit Off the Top.
 - 733 When Mr. Shakespeare Comes to Town.
 - 339 The Mick Who Threw the Brick.
- These are only a few of over a thousand records. Piano, Violin, Cornet, Trombone, Banjo, Mandolin, Flute, Piccolo, Chime Bells, Church Choir and other records. We'll be pleased to send you a complete catalogue.

Send your order for additional Records when ordering the **GRAM-O-PHONE**, thus saving time and express charges.

OUR SPECIAL EASY-PAYMENT OFFER.

As the orders keep pouring in, we have decided to continue our easy-payment plan. Send us one dollar with this coupon, promising, if the Gram-o-phone proves satisfactory after six days' trial, to pay two dollars a month for eight months, and we will ship you at once a genuine **Berliner Gram-o-phone, type "A,"** with three records of your own choice free. Enclose two dollars extra if you want spun-brass horn.

GIVE OUR OFFER A THOROUGH TEST.

Description of Berliner Gram-o-phone.

Cabinet—Quartered oak, highly finished.
Horn—16 inches long, 10-inch bell.
Finish—All exposed heavily nickel-plated.
Sound Box—The Improved Automatic Concert Sound Box
Needles—200 free.
Records—Three 7-inch records free.
Guarantee—Written guarantee for 5 years.
Weight—Completely boxed, 25 lbs.

CASH PRICE.
With Japanned Steel Horn, \$15. With Spun-Brass Horn, \$17.

EASY-PAYMENT PRICE.
With Japanned Steel Horn, \$17. With Spun-Brass Horn, \$19.

E. BERLINER, 2315-19 St. Catherine St., MONTREAL.
EMANUEL BLOUT, Manager for Canada.

E. BERLINER, F. A.
2315-19 St. Catherine St., Montreal, P. Q.

Enclosed find one dollar in payment on the Standard Berliner Gram-o-phone, type A, complete, with 16-inch Japanned concert horn and three records. If satisfactory after five days' trial, I agree to pay eight monthly payments of two dollars each. If not satisfactory, I will return the Gram-o-phone and this order is null and void.

Name.....
Occupation.....
P. O. Address.....
Express Office.....
Township.....
Province.....

If you wish a spun-brass horn in-tead of the japanned horn, enclose two dollars extra. Also send free of charge the following three records:

No..... No..... No.....

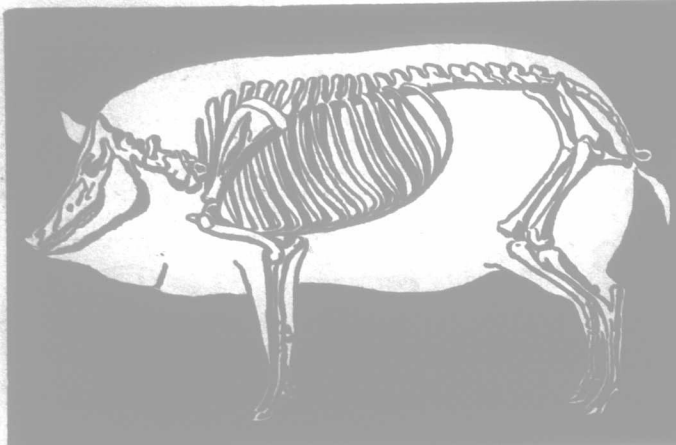

Veterinary Department of Our Book

This engraving, showing the skeleton of a hog, is a GREATLY REDUCED engraving taken from the Veterinary Department of the Stock Book we offer to send you free. The 183 large illustrations in this book are absolutely correct and were made by our own artists and engravers.

COMPARATIVE TEST.

INDEPENDENCE, IOWA.

International Stock Food Co., Minneapolis, Minn.
Gentlemen:—While called to see a sick cow, the owner, Mr. Hersh, called my attention to 60 shoats and pigs of all sizes and ages and among them were 13 which seemed to have catarrhal affections and general unthriftiness. I advised him to separate them and give dry quarters and plenty of "International Stock Food," which he did with remarkable results. He wrote me a letter in two months asking me to call and see them, and stated that they were far ahead of the ones he did not feed "International Stock Food." I have ordered "International Stock Food" to be used in neglected cases of distemper, chronic indigestion, etc., in horses with good results. I strongly endorse "International Stock Food" for the use of all farmers and stockmen.

Respectfully yours,
C. H. HETRICK, Veterinary Surgeon.

We will pay you \$1,000 CASH to Prove that our Testimonials are not Genuine.

"International Stock Food" FEEDS you ONE CENT is prepared from Roots, Herbs, Seeds and Barks and we paid \$40,000 in "war tax" because it was a high class medicinal preparation. Many "Stock Foods" did not pay this tax because they claimed to the Government that they did not use any medicinal ingredients and did not claim any medicinal results? "International Stock Food" purifies the blood and Cures or Prevents Disease. It is a great aid in Growing or fattening stock because it increases the appetite and aids digestion and assimilation so that each animal obtains more nutrition from the grain eaten. We positively guarantee that its use will make you extra money over the usual plan of growing and fattening stock. It does not take the place of corn or oats but is fed in small amounts as an addition to the regular feed. "International Stock Food" can be fed in perfect safety to Horses, Cattle, Sheep, Hogs, Colts, Calves, Lambs or Pigs. It is absolutely harmless even if taken into the human system. It won the Highest Medal at the Paris Exposition in 1900. It is endorsed by every High Class Farm Paper. We will furnish Thousands of Testimonials on application. We employ 107 people for our office work alone, including 33 typewriters. If you desire any special information be sure and write us. We pay these people for this kind of work and your letter will be answered promptly. "International Stock Food" is sold on a "Sole Cash Guarantee" by Forty Thousand Dealers throughout the World. Your money will be promptly refunded in any case of failure. You can test it without any risk. Can you ask anything fairer? It will make your Pigs or Hogs grow Amazingly and has the largest sale in the World for curing or preventing Hog Disease. Beware of Imitations! No Chemist can separate all the different powdered Roots, Herbs, Seeds and Barks that we use. Any one claiming to do so must be an Ignoramus or Fabulist.

A \$3000.00 STOCK BOOK FREE

IT CONTAINS 183 LARGE ENGRAVINGS OF HORSES, CATTLE, SHEEP, HOGS, POULTRY.

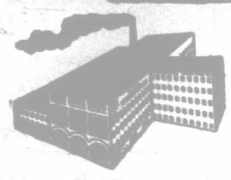

The cover is a Beautiful Live Stock Picture printed in Six Brilliant Colors. It cost us \$2000 to have our Artists and Engravers make these Engravings. This International Stock Book contains a Finely Illustrated Veterinary Department that will save you Hundreds of Dollars. It describes all common Diseases, etc., and tells how to treat them. This Illustrated Stock Book also gives Description, History and Illustrations of the Different Breeds of Horses, Cattle, Sheep, Goats, Hogs and Poultry. It also contains Life Engravings of many very noted Horses, Cattle, Sheep and Hogs. The Editor of This Paper Will Tell You That You Ought to Have Our Stock Book In Your Library For Reference.

WE WILL GIVE YOU \$14.00 IN "INTERNATIONAL STOCK FOOD" IF BOOK IS NOT AS STATED.

This Book Mailed Free, Postage Prepaid, If You Write Us (letter or postal) and Answer These 3 Questions:

1-Name this paper. 2-How much stock have you? 3-Did you ever use "INTERNATIONAL STOCK FOOD"?

Largest Stock Food Factory in the World
Capital Paid in, \$1,000,000.
We Occupy 61,000 Feet of Floor Space.

International Stock Food Co., MINNEAPOLIS, MINN., U. S. A.

DEALERS SELL THESE: INTERNATIONAL STOCK FOOD, INTERNATIONAL WORM POWDER, INTERNATIONAL GALL CURE, INTERNATIONAL POLTRY FOOD, INTERNATIONAL COLIC CURE, INTERNATIONAL HEAL CURE, INTERNATIONAL HOUSE FLYER, INTERNATIONAL HARNESS SOAP, SILVER PINE HEALING OIL, ETC.

I Will Cure You of RHEUMATISM

Else No Money Is Wanted.

After 2,000 experiments, I have learned how to cure Rheumatism. Not to turn bony joints into flesh again; that is impossible. But I can cure the disease always, at any stage, and forever.

I ask for no money. Simply write me a postal, and I will send you an order on your nearest druggist for six bottles Dr. Shoop's Rheumatic Cure, for every druggist keeps it. Use it for a month and, if it succeeds, the cost is only \$5.50. If it fails, I will pay your druggist myself.

I have no samples, because any medicine that can affect Rheumatism quickly must be drugged to the verge of danger. I use no such drugs, and it is folly to take them. You must get the disease out of the blood.

My remedy does that, even in the most difficult, obstinate cases. No matter how impossible this seems to you, I know it and I take the risk.

I have cured tens of thousands of cases in this way, and my records show that 39 out of 40 who get those six bottles pay gladly.

I have learned that people in general are not satisfied with a physician who cures them. That is all I ask. If I fail I don't expect a penny from you.

Simply write me a postal card or letter. I will send you my book about Rheumatism, and an order for the medicine. Take it for a month, as it won't harm you anyway.

If it fails, it is free, and I leave the decision with you. Address Dr. Shoop, Box 53, Racine, Wis.

Mild cases, not chronic, are often cured by one or two bottles. At all druggists.—Adv't.



DEERING IDEAL BINDER.

Deering Ideal Line

Lights labor on the farm.

The name "DEERING" signifies harvester excellence. It appears on the following "Ideals":

BINDERS,
MOWERS,
REAPERS,
RAKES, TWINE,
CORN BINDERS,



DEERING IDEAL HAY RAKE.

Deering Division International Harvester Co. of America

MAIN OFFICES:
Chicago, U. S. A.

FACTORIES:
Chicago, and
Hamilton, Ont.

CANADIAN BRANCHES:
Toronto, London,
Montreal, Winnipeg.

"IT PAYS TO USE DEERING MACHINES."

So say thousands of Canadian farmers. The

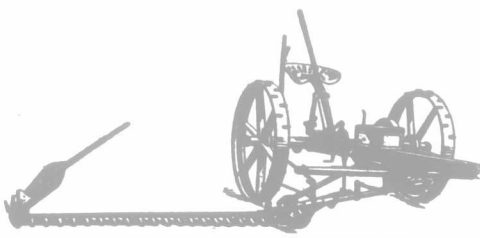

DEERING IDEAL MOWER.

Corn Shockers,
Huskers and
Shredders, Oil,
Knife and
Tool Grinders.

Deering Ideals garner every cent of profit in a crop, be it grass, grain or corn.

Investigate Deering machinery before you buy. Write for a beautifully-illustrated catalogue.



DEERING IDEAL CORN BINDER.

Please Mention the Farmer's Advocate.

Meet a Farmer's Needs "Sunshine" FURNACE.

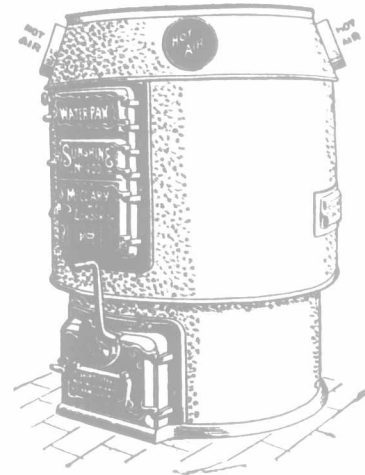

Burns coal and wood successfully. Wood can be used in spring and fall, and coal in severe winter weather.

Large double feed-doors will admit rough, twisted wood.

The "Sunshine" will extract more heat from the same amount of fuel than any other heater, and no other good furnace is so cheap.

"Cornwall" STEEL RANGE.

Made entirely of heavy steel plate.

All wearing parts are extra heavy.

Burns coal or wood, grates always being supplied for both.

Has an exceedingly handsome appearance, and a design distinctly its own.

Will last a lifetime without repair.

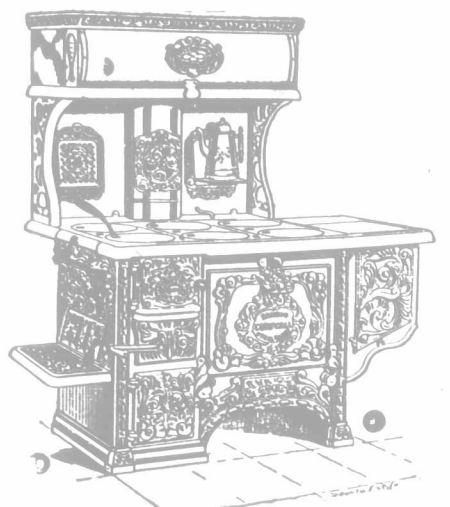

WRITE FOR BOOKLETS.

McCLARY'S

LONDON, TORONTO, MONTREAL, WINNIPEG, VANCOUVER; ST. JOHN, N.B.

EARN THIS REAL RIFLE

Breach Loader, Octagon Barrel, Solid Walnut Stock. A perfectly sighted long range Rifle, takes BB caps or 22-calibre cartridges. Given (1) for selling 1 doz. handsome pieces of Jewelry: Hat Pins, Stick Pins, Cuff Links, Brooches, etc., that look worth 50c., at only 15c., each and getting 3 more agents to do the same; (2) by selling 2 dozen yourself. Write to-day and we will send you the Jewelry postpaid. Boys, here is your chance to get a fine real rifle in exchange for a little of your time. It is just the thing for all kinds of small game and costs you not one cent. NATIONAL WATCH & JEWELRY CO., Dept 577, Toronto

The
Farmer's Advocate
and Home Magazine.

"PERSEVERE AND SUCCEED."

ESTABLISHED 1866.

REGISTERED IN ACCORDANCE WITH THE COPYRIGHT ACT OF 1875.

VOL. XXXVII.

LONDON, ONT., AND WINNIPEG, MAN., DECEMBER 1, 1902.

No. 563

EDITORIAL.

The Quest for Knowledge.

A notable manifestation of the spirit of intelligent activity characteristic of Canadian agriculture to-day is to be seen in the recent growth of Farmers' Institutes in the Maritime Provinces, Ontario, and other portions of the Dominion.

In Ontario, more applications have been made for meetings this year than ever before. Last year 791 meetings were held, and this year over 800 meetings have been arranged for. The year ending June 30th, 1901, shows a total membership of 20,307, 730 meetings and a total attendance of 131,653 persons. On June 30th, 1902, we notice quite a step in advance. The membership has increased to 22,948; 791 meetings were held, and 147,642 received instruction, an encouraging growth, for which Supt. Creelmann and the local Institute officers are entitled to very great credit.

The special features of the work last year included the increase of Women's Institutes, designed to promote scientific knowledge in domestic economy, from 20 to 44, with a membership on June 30th last of 3,081. The Institute excursions brought about 30,000 visitors to the Agricultural College, at Guelph, and a number of seed fairs were held before spring planting time.

But what of the future? During the coming winter instruction will be continued along the same lines as before, but in addition in Ontario a special campaign will be inaugurated in opposition to the pea weevil, as foreshadowed in our last issue, and to weeds. The latter campaign has our most hearty approbation. All Institute workers will receive instruction on these two subjects at the meeting of the Experimental Union, and at the Provincial Winter Fair this month. Prof. Wm. Lochhead, Guelph, and Dr. James Fletcher, Experimental Farm, Ottawa, will instruct the Institute delegates on matters pertaining to the pea weevil, while Prof. Zavitz, of the Agricultural College staff, and Mr. G. H. Clark, Department of Agriculture, Ottawa, will deliver addresses on the subject of "Weed Seeds and How to Avoid Them." Institute workers will also be provided with a chart, showing the amount of weed seeds actually counted in grasses and clover seeds procured from seedsmen in different parts of the Province. They will be supplied with literature, and a complete set of grass seeds and weed seeds, to show at the meetings.

The subject of fall fair improvement, educationally, from the farmer's standpoint, will be taken up. At these exhibitions the products of the farm and garden should be gathered together and so labelled that the average visitor may be able to see what can be accomplished by better methods, and return home and be able to apply that knowledge in the production of farm products. The advisability has been suggested of having some one in charge of each division of the show, to give information desired as to how the different plants and animals were grown and fed and finished. At a number of fairs this year, Institute workers were present as judges, and others gave a practical demonstration of killing, plucking and dressing of poultry, packing of apples,

describing the valuable points of cattle, sheep and swine, the handling of bees, and the growth and production of sugar beets. Several fairs, also, had splendid experimental plots of grasses, grains and forage plants, and had these crops looking their best at the time of the fair. The success of several local fairs, such as those in Norfolk and Dufferin counties, Ont., attended by members of our staff, go to prove that the people will appreciate a wholesome, instructive exhibition, if it is only properly presented. It is to be hoped that the country has seen the end of the mad rush for "attraction" follies, with which so many agricultural societies have been carried away in recent years. From all indications, we are looking forward to a good year in connection with the Farmers' Institutes.

The Dairy Outlook.

Never in the history of dairy farming in Canada was a more favorable summer and autumn experienced, or the business more profitable than this year, and never has the prospect for that industry been more encouraging. The returns from the export of Canadian cheese and butter the present year will, it is confidently estimated, reach the record of \$30,000,000. Ten years ago it was less than \$10,000,000. What other branch of farming has in the same time come near making such a showing in the upward trend of its course? With cheese selling now at 12 cents at the factory and butter at 20 cents to 25 cents in the home markets, and our barns choke-full of feed, what better business can the farmer covet? It is safe to say that dairying is the surest source of revenue the average Canadian farmer can count on. While it requires no special skill to make it a fair success, yet it rewards in dollars and cents the most intelligent and skilful management that can be applied to it. Comparatively few farmers make a financial success of feeding cattle for the market for beef, while the majority can keep cows paying their way and putting by a little profit. Since the steady demand and the good market for young hogs has evidently come to stay, the sow and the cow have proved the farmers' favorite reliance for profitable production. Our export returns for hog products last year totalled close to \$12,000,000, while ten years ago they were but little over \$1,000,000. Dairying and hog-raising fit into each other admirably, as there is no other food so suitable for young pigs as skim milk, while the next best thing is whey from the cheese factory. These by-products of the dairy, which would otherwise be largely wasted, go far towards growing the pigs, which, in little more than half a year from birth, go off as money-makers with a reasonable certainty. The labor question is liable to be raised as an objection to dairying, but can any class of farming be made successful by the average farmer without labor? And what line of farming will pay better returns for the labor bestowed upon it, or what line of farming will so well contribute to keeping up the fertility of the farm as dairying. Manure must be supplied from some source if the land is to continue to produce paying crops, and in what way can manure be so cheaply and conveniently provided as by feeding cows and pigs and other young stock, and where can as good a market for the

grain and hay grown on the farm be found as that furnished by the cows and the hogs which take it in right at home without any tedious teaming, and pay for it in the form of milk and meat that has a cash value and brings in money steadily the year round.

A successful Ontario dairyman elsewhere in this issue writes, "We market our crops through our cows at about these prices: Barley, \$1.00; oats, 75 cents; hay, \$20 per ton, and have the manure too, which is worth a lot." The labor problem, too, is being gradually solved by the introduction of improved methods of handling milk, by the use of the cream separator, the adoption of the cream-gathering system, the establishment of milk-condensing factories, and the increasing demand for milk and cream for city trade.

These things, and all other indications, point to a steady demand and profitable returns for the dairyman, while improved farm buildings and facilities for carrying on the business with a greater degree of comfort and cleanliness, which are within the reach of most farmers, helps to make the work less irksome, and may with patience and good management make it a pleasurable occupation. A herd of well-selected and well-kept cows and young cattle is a source of solid satisfaction and pleasure to one who loves animals, and he who does not is to be pitied.

Those who are in the dairy business will do well to stay right in it, because it is safe and sure, and they will do well to pay more attention to the character of the cows they keep, testing them to ascertain whether they are money-makers or merely boarders, paying only for what they eat and contributing nothing to the profits. Good cows pay well for good feeding, giving profitable returns for what they get, and the only way to get the best out of a cow is to see that she is regularly supplied with good feed and kept comfortable.

The Caleb Jenkins Letters.

Who has not heard of the "Caleb Jenkins" letters? Replete with shrewd common-sense, his observations on current questions have been so keen and yet expressed with such a sense of good-humored irony as to make them popular even with those who were satirized. With this gift the author (Bengough) combines the still rarer skill of the cartoonist, which, added to the product of his genius as a poet, first gave him enduring fame. By a happy thought he has now turned his humor in the line of agriculture, and his letters will be one of the new features of the "Farmer's Advocate" for 1903, the series beginning with the present issue and the Christmas number.

The Chicago Live Stock World describes as "facetiousness" the recent allusion by the "Farmer's Advocate" to a Washington bulletin labelled "American breeds of cattle," but which contained descriptions of the well-known British breeds, and then asserts, "American breeders are, in fact, striving to get away from English and Scotch types." Their zeal in "getting away" is manifested by continued purchases by American breeders of imported cattle and the presence of their buyers at the recent sales in Great Britain. American experts can doubtless enlighten the World man on how to keep up the march of improvement in their cattle.

THE FARMER'S ADVOCATE AND HOME MAGAZINE.

THE LEADING AGRICULTURAL JOURNAL IN THE
DOMINION.

PUBLISHED SEMI-MONTHLY BY
THE WILLIAM WELD COMPANY (LIMITED).

TWO DISTINCT PUBLICATIONS—EASTERN AND WESTERN.

EASTERN OFFICE:
CARLING STREET, LONDON, ONT.

WESTERN OFFICE:
IMPERIAL BANK BLOCK, CORNER BATHURST AVE. AND MAIN ST.,
WINNIPEG, MANITOBA.

LONDON (ENGLAND) OFFICE:
W. W. CHAPMAN, Agent, Fitzalan House, Strand,
London, W. C., England.

JOHN WELD, MANAGER.

1. THE FARMER'S ADVOCATE is published on the first and fifteenth of each month. It is impartial and independent of all cliques or parties, handsomely illustrated with original engravings, and furnishes the most profitable, practical and reliable information for farmers, dairymen, gardeners, and stockmen, of any publication in Canada.
2. TERMS OF SUBSCRIPTION—\$1.00 per year in advance; \$1.50 if in arrears; sample copy free. European subscriptions, 6s. 6d., or \$1.50. New subscriptions can commence with any month.
3. ADVERTISING RATES—Single insertion, 20 cents per line, agate. Contract rates furnished on application.
4. THE ADVOCATE is sent to subscribers until an explicit order is received for its discontinuance. All payments of arrearages must be paid as required by law.
5. THE LAW IS, that all subscribers to newspapers are held responsible until all arrearages are paid and their paper ordered to be discontinued.
6. REMITTANCES should be made direct to this office, either by Money Order or Registered Letter, which will be at our risk. When made otherwise we will not be responsible.
7. THE DATE ON YOUR LABEL shows to what time your subscription is paid.
8. ANONYMOUS communications will receive no attention.
9. LETTERS intended for publication should be written on one side of the paper only.
10. WE INVITE FARMERS to write us on any agricultural topic. We are always pleased to receive practical articles. For such as we consider valuable we will pay ten cents per inch printed matter. Criticisms of Articles, Suggestions How to Improve the ADVOCATE, Descriptions of New Grains, Roots or Vegetables not generally known, Particulars of Experiments Tried, or Improved Methods of Cultivation, are each and all welcome. Contributions sent us must not be furnished other papers until after they have appeared in our columns. Rejected matter will be returned on receipt of postage.
11. ALL COMMUNICATIONS in reference to any matter connected with this paper should be addressed as below, and not to any individual connected with the paper.

Address—THE FARMER'S ADVOCATE, or
THE WILLIAM WELD COMPANY (LIMITED),
LONDON, CANADA.

Renewing Time.

More new subscribers have been added to the "Farmer's Advocate" lists during the past season than in any previous year in its history. For this we are truly grateful. In large measure this splendid increase is due to the loyalty of our old readers. We also accept it as an appreciation of promises fulfilled in respect to improvements in the paper, of its increased size and the practical value of its contents. We act on the conviction that what is needed and desired is a paper of FIRST RANK for agriculturists and stock breeders. This is our policy for 1903, the prelude to which will be the beautiful CHRISTMAS ISSUE now in preparation. We look with confidence, therefore, to all our present subscribers to sustain us in this great undertaking by a PROMPT RENEWAL. Look up the address label on your paper, showing the date to which your subscription is paid. Every year the burden of our office work increases, and it will be a boon to receive your renewal now. We respectfully urge every reader to give this important matter immediate attention.

If possible, send us also the name of at least one new subscriber for 1903. Judging from the letters continually pouring in, the "Advocate" was never as popular with its subscribers as it is to-day. All points considered, they contend that at \$1.00 per annum it is the cheapest paper available.

Another Great Railway.

Announcement is made that the Grand Trunk Railway will build another transcontinental line from North Bay or Gravenhurst through New Ontario, Manitoba and the northern part of the Northwest Territories and the Peace River country to the British Columbia coast, 600 miles north of Vancouver.

The Farmer and Science.

That a misconception of the term science in its application to agriculture exists in the minds of many farmers cannot be denied. It is not uncommon to hear men of seeming intelligence give expression to their views, and in tones of irony make reference to "the scientific." To them it appears to convey the idea of speculation, mystery and unfitness for association with anything of a real practical character. They appear to think that facts not already in their possession are unworthy of acquisition. They have it all, and the man who comes forward as the advocate of new methods based upon the results of scientific research, they discredit.

In looking over the past, this is not altogether to be wondered at. Instances are not wanting where the scientist has proclaimed the results of his investigations that later discoveries proved to be untrue. This has occurred principally where men have prematurely undertaken to win fame, or have been over-anxious to enlighten the world on some subject of vital importance, and have arrived at what seemed to them a conclusion before, in reality, the enquiry had rightly begun. Another type to be found a quarter century or more ago was the scientist who, untiring in his efforts to benefit his fellow-man, particularly the tiller of the soil, lost no opportunity to give advice concerning farming, which, owing to his ignorance of farm life, was often unfitted for practical application. Fortunately, such are largely of the past.

Although the scientist has occasionally shown evidence of knowing too little about his science, he has, nevertheless, done great things for the farmer. In the ranks of those who gave their time and attention to this branch, have been men of rare intellectual ability, whose works will ever remain as living monuments to commemorate their name. Hand in hand with the advances which they made in biology, chemistry, bacteriology, entomology and various other subjects have gone the improvement of man's primitive calling—agriculture—until, happily, a brighter era has dawned. The farmer is beginning to know more about his farm, and to see that the scientist is his best friend, rather than one to be scorned; he discerns that, after all, science is nothing more than knowledge systematized; an association of facts so arranged as to be understood. To our universities and colleges, through the good work which they are doing, and the practical men that are leaving their halls, is due much credit for having created this better understanding. Intelligent and successful farmers everywhere now believe there is something to be learned about the cultivation of the soil, the liberation of plant food, the changes that take place during growth, the habits of insects, and a score of other questions equally significant that are ever under the survey of science.

We must look for great advances in future. Agriculture cannot afford to be deprived of the assistance to be gained from her powerful "handmaid," science. Nor will she. The farmer of the future, even more than of the present, will be a believer that those who think will lead. He will never lose sight of the fact that the real object of all industry must be the support of life. As the soil is stirred, the seed sown and plants produced, it will be done more intelligently than in the past. The one who is never ready to profit by the experience and advice of others will be obliged to give place to him who continues ever to study, believing that in all things a great hand ruleth, and that science is only man's effort to accumulate and arrange those facts which explain nature's laws and assist in the performance of all that is highest and best in life. To put it in another way: In the growth of crops and animals, nature has certain ways of working. (It is not luck or chance.) To farm successfully, we must work in harmony with these ways, or laws. By experience and study, we get acquainted with them. To fight weeds or insects best, we must know their nature and habits; to grow continually good crops, we must understand

how to keep up the productiveness of the soil; or to keep animals doing well, must feed and care for them according to the laws of their bodies. All this knowledge is simply science, and the better a farmer knows it in reality, the more scientifically will he farm, though he may not call it by that high-sounding name.

Pointers.

Do not forget the winter fair.

• • •

In this issue, for the first time, "Caleb Jenkins" begins to turn his search-light on the agricultural situation at Jenkins Corners.

• • •

Some things are neither useful nor ornamental. The Christmas "Farmer's Advocate" will be both and more. Do not miss it.

• • •

Read carefully the letter by Mr. John Campbell in this issue, in favor of free rural mail delivery.

• • •

Three ways of getting free rural mail delivery: 1st, write your local M.P.; 2nd, write the Postmaster General, Ottawa; and 3rd, write the "Farmer's Advocate," asking for it.

• • •

Mr. J. S. Larke, Commercial Agent of the Canadian Government in Australia, in his letter which we publish elsewhere, sheds a flood of light upon the opportunities and conditions for Canadian trade there, and points out the need for Canadian pure-bred stock to improve the herds and studs of the Commonwealth. Shall we rise to the occasion?

• • •

We take it that the highest and most practical achievement in pure-bred stock breeding is the production of prepotent males of the first class.

• • •

A few issues ago we referred to a letter sent us from a St. Louis concern, urging speculation in "November corn" as a money-making proposition. We warned our readers against all such schemes. A few days ago a Toronto butcher cut his own throat, ruined by stock gambling, and in his pocket was found a telegram about his investment in 3,000 bushels of November corn from the very people who sent us the circular letter.

Standard of Judging.

Mr. W. A. McKinnon, Chief of the Fruit Division, Dominion Department of Agriculture, in a letter from England, regarding British agricultural shows, says: "Particular enquiries about the standards adopted in judging stock at these shows failed to elicit a definite statement on this point. In fact, the officials themselves were not any too clear as to what is or ought to be the standard. They appear to have fallen into the easy error of looking on the prize itself as being the end and goal of the exhibitor's ambition. On pressing the matter somewhat closely, certain officials admitted that too little attention was paid to either the educational value of the show or the cash result to the farmers at large.

"In the catalogue and prize lists, judges are warned not to be influenced by the market value of stock in making their awards, and a high official stated that in his opinion too little attention was paid to the economic value of the exhibits, and that farmers are sometimes misled by awards so as to produce an article which is not remunerative.

"Educational meetings are all but unknown. At Carlisle there were demonstrations of dairying processes, but no word of explanation seemed to be given. Guelph leads them all for active, energetic, intelligent education, for in Britain the farmer seems to be considered highly honored in being allowed to exhibit, and they let him pick up some crumbs of information if he can."

The estimated shipments of celery from California for 1901-02 are put by commercial authorities at 1,200 carloads, against 1,100 carloads in 1900-01, and 700 carloads in 1899-1900.

HORSES.

Adherence to Type in Horse Judging.

In order to do good work in the show-ring, the judge must be a good judge of type. He must be conversant with the desirable characteristics of the different breeds of horses, and in order to appear consistent he must, as far as possible, adhere to type in awarding prizes. At the same time, we not infrequently hear a judge severely criticised for his apparent indifference to type when his awards are properly made. In judging cattle, sheep, swine or poultry, in which classes the entries are in nearly all cases pure-breds, and where not so, are, at all events, judged from a special standpoint where a certain type is demanded, it is comparatively easy to adhere to type. The same remarks apply, though to a limited degree, to the pure-bred classes of horses. The limitation referred to applies to soundness and action. In many cases a horse that is typical of his class is disqualified from winning, or set second or third, on account of some unsoundness that is not apparent to those outside the ring. Most agricultural societies have a paragraph in the prize list which states that, with certain exceptions, an unsound horse cannot win a prize. If this rule were strictly adhered to, a great many good horses would be disqualified, as there are few absolutely sound. Therefore, it is apparent that the judge must exercise his discretion or judgment as to what should disqualify. We occasionally hear it stated that if a horse has an unsoundness that prevents him from winning 1st place, he should be disqualified altogether. This does not necessarily follow; it depends greatly upon the company he is in. An unsoundness that does not interfere with the animal's usefulness, but at the same time should place him behind an animal that otherwise is not quite so good, might not be sufficient to place him behind another that is quite inferior. The slightly unsound animal being the more typical, and the unsoundness being invisible to the spectators, makes it appear that the judge does not value type as he should, and if the unsound animal be disqualified from winning anything, the idea is intensified. If the judge had the privilege of explaining, or giving reasons for his awards, it would, in most cases, satisfy the public that he was right, but it is not always wise for him to draw the attention of the public to an unsoundness in a horse; the owner does not like it, and this applies especially to the breeding classes.

In the pure-bred classes, as Thoroughbreds, Hackneys, Coach horses, Clydesdales, Shires, etc., the judge has, in most cases, a reasonable opportunity to show his knowledge of and preference for type, and he should adhere to it as far as possible. But in the classes of composite breed, as roadsters, carriage horses, saddlers, general purpose horses, combination horses, etc., where the blood of so many breeds or classes is represented, and where action and manners may be said to count for more than type (this is especially the case in carriage horses), it is often impossible for the judge to be particular about type in awarding the prizes. Cases are not rare, in which two animals of the same breeding, size and general appearance when standing are essentially different in action and style. One has the high, flashy, attractive action required in the carriage horse, while the other has typical road action, and can, perhaps, go fast, or he may even pace. It is quite possible for each of these to win in good company; one in the carriage and the other in the roadster class, and each may be said to be fairly typical. In cases of this kind, it is style and action rather than conformation that classifies the horses.

It is extremely hard to set up a definite type for classes of mixed breeding. In the case cited, while the animals are bred in the same way, possibly out of the same dam and by the same sire, and as regards size and conformation are alike, one inherited the carriage action of a more or less remote ancestor, and the other the road action of a member of another branch of the family. Instances of this nature are frequent, and apply to a greater or less extent, to all classes where impure-bred animals are eligible. We frequently notice in a class of horses, where size is not designated, that a large animal will be given 1st, a small one 2nd, and a large one 3rd, or vice versa. Now, to the casual observer this looks inconsistent, and we often hear such awards severely criticised, but if a careful observer, who understands the conditions, be present he will have observed that the animals that won possessed the desirable action demanded, in the degree in which they were placed.

While I do not wish to justify the awards that are made in all cases, as I am fully alive to the fact that frequently they are essentially wrong, I, at the same time, am also aware that the judge is often severely criticised by either interested or ignorant parties, when, as a matter of fact, his awards have been properly made. As already stated, in judging horses it is well to adhere as

far as practicable to type, but it would be unwise to sacrifice other desirable qualities for type.

In the pure-bred classes, of course, we must have type first, and the other qualities more or less marked, but in the composite classes it is hard to define exactly what is a typical animal, and all points and characteristics must be carefully considered, and we are justified in sacrificing type, at least to a limited extent, for other qualities. The judge of horses has much more to contend with than the judge of other classes of stock, and, for reasons explained, he finds it harder to stick to type. "WHIP."

Feed and Fit Before Selling.

In offering farm horses for sale, a common mistake is made in not properly fattening and fitting before placing on the market. Not only is this true at the present season, when the surplus stock are being disposed of before winter, but at other times during the year. Most people believe that it pays to fatten cattle, sheep or hogs, but they forget that for the feed consumed the heavy draft horse will give even better returns. Buyers for the British market, particularly, demand that the body be well covered with flesh of good quality, and for such, all other things being equal, they are prepared to pay the highest price.

The reason for this is readily seen; the long sea voyage is extremely trying, and unless horses are fat before starting they are not likely to appear in very attractive form when presented for sale across the Atlantic. The old adage, too, that "fat covers a multitude of defects," is very

**GOLDEN CHARM.**

Clydesdale stallion, two years old. Winner of first prize at Western Fair, London, 1902.
IMPORTED AND OWNED BY BAWDEN & M'DONELL, EXETER, ONT.

true, and while deceptive tactics must be ignored, it should not be forgotten that in a horse of good condition a buyer has the assurance that the animal is capable of making good use of his feed.

When it is desired to improve the condition of horses which have been constantly engaged in heavy work, they should not be fed heavily without receiving regular exercise. It is much better, to make the change to comparative idleness gradually, because if heavy feeding is indulged in, indigestion or disorders of the blood must be feared. Examine the teeth at the start and make sure they are capable of proper mastication. As a fattening ration, nothing is better than a mixture of good timothy and clover hay, if available, with whole oats and bran in addition. It is good practice to occasionally give a feed of oats, boiled, and if a small allowance of roots, such as carrots or turnips, be supplied daily, rapid improvement may be expected.

In regard to fitting, to show to advantage, it will generally pay to spend a little time for that purpose. Buyers will give more for a horse that is handy and will step up on the line with good grace. This feature of the preparation for market can be easily attended to while giving the necessary exercise, and if by the expenditure of a little time and skill better action and manners can be secured the value will be very materially increased. It might also be added that good grooming is one of the chief essentials to good health, and a little time spent with the comb and brush in the stall will not be amongst the unprofitable items when the stable accounts are audited.

The Idle Horse in Winter.

The cheapest method of keeping the idle horse over winter, is a question that might well be considered by many just at this season. There is no need to supply fat and flesh, nor stimulate muscular energy; all that is necessary is a ration containing sufficient nutrients to rebuild the tissues of the body broken down by the every-day activities of the vital organs. To do this, in most cases, little or no grain should be required. A moderate allowance of equal parts clover hay, where that luxury is available, and clean wheat or oat straw, with a few pounds of roots in the form of turnips or carrots daily, will fill the bill. As exercise is very essential to good health, it is splendid practice, after the morning meal has been disposed of, to allow freedom in a large yard or field, where he may roam at will. Even on comparatively stormy days, when rain is not falling, a few hours in the open air will be profitable. Under such treatment he will be healthy and in good condition when March arrives, to go into preparation for the spring fitting. The custom of feeding idle horses grain, which might profitably be given to stock that is for sale, does not belong to business farming.

STOCK.**The First Month in Stall Feeding.**

To feed right, the first month of fattening requires skill on the part of the cattleman quite equal if not superior to that necessary at any other time. During this period the health and individual condition of the animals has to be taken into consideration. It is largely a transition stage—changing from the succulent herbage of the fields to something more concentrated and solid in character; and since it is well known that sudden changes of feed are not conducive to good health or rapid gains in flesh, care must be exercised in preparing the ration.

To begin with, such feeds as roots, silage and rape must be given somewhat freely. Of the latter, too much can scarcely be said in its favor; many of the heaviest and most successful feeders now aim to give their cattle a few weeks' run on rape pasture previous to stabling, and even when they have been chained in the stalls and the weather somewhat severe, they continue its use by carting to the stable once each day a fair allowance. It has a wonderfully good effect in toning up the system, because, owing to a high per cent.

of protein, the fluids of the body are increased, and the bullock, as old feeders would say, "becomes sappy." This is exactly the condition that should be aimed at during the preliminary stage, so that when grain is gradually introduced four or five weeks later, the digestive organs will be in a state to assimilate what is given.

In the absence of rape, or when the supply has been exhausted, roots and silage, either singly or in conjunction, should be liberally supplied, the amount suited to each animal being determined by observing the readiness with which the manger is cleaned and the action upon the digestive tract as seen by the condition of the excreta.

As roughage, there is nothing better to mix with these than good clover hay, if it is available. It also, according to chemical analysis, is high in protein, has a narrow nutritive ratio, and hence is fitted to increase the circulatory protein (juices of the body) and invigorate the animal organization. While some practice feeding grain lightly from the beginning, others defer its introduction for a few weeks. This, however, is a matter which circumstances alone must decide. If the cattle are already thrifty, and have taken the change of food without a serious setback, a small allowance, say 2 or 3 pounds daily, may be advisedly given, but ordinarily, where the feeding is to be continued several months, it is better to withhold the meal for a few weeks, as before intimated.

With your renewal subscription to the "Farmer's Advocate" for 1903, can you not send us at least one new subscriber?

Our Scottish Letter.

Time passes, and the weeks fly over our heads in such fashion as alarms the man who looks back in his reckoning. Last letter closed with some reference to the great cattle sales which had just taken place in the north. The most notable of all the sales, in some respects, was that held at Jackston. The herds at Jackston and Westertown are in the hands of two cousins of the same name—James Durno. They have been rapidly building up a first-class reputation, and making good averages at the spring bull sales. The Canadian buyers operated to some purpose at these sales, and they got right good cattle. The younger animals were all sold subject to the tuberculin test, and we believe they came through it all right. The result of the sales of both A.-A. and Shorthorn cattle is to place the A.-A. breed at the top, with the best average in a mixed sale. This figure is £92 3s. 4d., which stands to the credit of Ballindalloch. Three of the next best averages are at the credit of Shorthorns, Collynie leading with £84 17s. 3d., followed by Jackston with £71 17s., and Holker in Lancashire with £53 10s. 6d. Fifth place is filled by Auchorachan, with £52 5s. for blackskins, and Whiteside Alford is sixth with £43 16s. 9d. for Shorthorns. Not far off is Balliol College, with £43 13s. 2d. for the blacks, and Westertown presses him hard with £43 8s. 9d. for Shorthorns. The last of the averages over £40 also stands at the credit of Shorthorns, Newton taking the place with an average of £41 15s. 4d. It will thus be seen that, leaving out of account sales which were confined to bull calves, the two breeds run a close enough race in the sale ring. The leadership belongs to the blacks, but the best average positions go to the red, white and roan.

October is the dairy show month of the year. The leading cheese shows in Great Britain are held at Frome in Somerset, London, and Kilmarnock. The first is a West of England affair, pure and simple. It is the great market for cheese in that locality. The taste there differs greatly from the Scots taste. The public in the south demand a mild, meaty cheese, and they get it. To the ancient Scot, who loves his cheese with a 'bite' in it, the brand which looks more like curd than cheese is not beautiful. The Englishman, however, demands it, and will take no other. This year the Scot made an effort to wrest the laurels from England at the London Dairy Show, and to a certain extent he succeeded. The north was fairly well represented in the battle, but the victorious dairy was that of Mr. Alexander Cross, of Knockdon, in Ayrshire. Mr. Cross contrived to put several lots of cheese before the judges, possessing the qualities which command success in England, with a fair proportion of purely Scots characteristics. The judges were Mr. R. Hudson, Jr., Ludgate Hill, London, and Professor Drummond, of the West of Scotland College, Kilmarnock. Mr. Cross took first for his cheddars; Mr. W. Stevenson, Boghead, Mauchline, being second; Mr. James A. Whyte, Kirkmabreck, Stranraer, third; and Mr. Jno. Smith, Standingstone, Kirkeudbright, fourth. In the other cheddar class a Gloucester maker was first, but Scotsmen were second, third and reserve. The cheese thus decorated would hardly have been looked at in a Scots show. They were made for the London palate, and seem to have hit it. These things show that after all cheese points are pre-eminently matter of opinion. There can be no absolute standard of merit. Makers must aim at supplying the public taste. The best is what best achieves this end. Canadian cheese are in growing favor in this country, and merchants speak highly of this season's make. The cool summer, combined with the new arrangements made for preserving the cheese in transit, and the summer-curing methods in vogue, will, inevitably, lead to an increased demand for Canadian produce. Canada has, however, much leeway to make up in the matter of butter. Last week she was on the same plane as Ireland. Denmark was far ahead, with an enhanced value by fully 10s. per 112 lbs., and New Zealand, which is almost due, was quoted quite 6s. in advance of Canadian and Irish. Will it be the case with factories as with individuals, that whosoever you find good cheese you need not look for first-class butter?

The most recent event of mutual importance and interest to Canada and the mother country has been the conference in London on the Canadian cattle store question. It was organized by the Clyde Trust and Glasgow Town Council representatives, assisted by representatives from the Dundee and Aberdeen Harbour Boards. There were agricultural representatives present from the Eastern counties of England and the Midland and North-eastern counties of Scotland. The meeting could not be regarded as at all representative, as three-fourths of the farmers in Scotland were not represented at all, and perhaps nine-tenths of the farmers of England. So far as agricultural interests are concerned, in this agitation they count for almost nothing. The aim of the conference was to enlighten members of Parliament on the side of the question which interests the consumer. There is an obvious de-

termination to work the argument of dear beef for all there may be in it. I don't think there will be much, as the vast quantities of beef and mutton brought here in chilled chambers will always prevent any excessive advance in the price of meat.

If any change in the law takes place it is increasingly evident that it will not be through any action of the Board of Agriculture, and its President, Mr. Hanbury, has obviously made up his mind, and he gives me the impression of being a gentleman who, when that stage is reached, may as well be left alone. He was down in Edinburgh last week, and it seems evident that while he is not indisposed to admit Argentine cattle for slaughter at the port of debarkation, he is not in favor of proposing any amendment to the Act of 1896. In other words, he may, as he must statutorily, when satisfied that there is no disease in the Argentine, admit the cattle from that quarter to be slaughtered at once, but he cannot deal in this way with the importation of Canadian cattle as stores, because that question is settled by statute in the negative. The movers in this business mean to keep the agitation going. The M.P.'s who favor the views of the conference speak of bringing in a private member's bill. That, however, has a very poor chance of passing. The Government, I believe, recognize the chief difficulty in this matter to be in the composition of the present Parliament. There are 80 or 90 Irish members who would vote against any change in the law; and the English county members, except a few from Norfolk, and perhaps Essex and Lincoln, and about one-half of the members for Scotland, would follow suit. In these circumstances no minister in this country is likely to look seriously at the proposed amendment of the Act of 1896. "SCOTLAND YET."



KING OF THE CLYDES [2569] (10786).

First-prize and sweepstakes draft stallion at Winnipeg Industrial Exhibition, 1902.
PROPERTY OF HON. THOS. GRKENWAY, CRYSTAL CITY, MAN. (SEE GOSSIP, PAGE 894.)

Kindness to Stock.

Of the various factors that go to determine success in the raising of live stock, whether it be the production of bone and muscle in the young, fat and flesh in the mature animal, or a large flow of milk in the dairy cow, none play a more important part than kindness. In all its branches, the animal organization is so constructed that when undue excitement or worry is caused, the energy thereby expended is lost to the economical functions of the body. Just as food is used in supplying the heat necessary to combat extremes of cold, so it is consumed to maintain nervous energy, and hence an animal must be contented before profitable returns can be expected by the feeder. This is borne out by practical experience and observation on every hand. It is only necessary to visit the well-ordered stables where the prizewinners at our exhibitions and fat-stock shows are reared and fitted to see the material benefits of good treatment.

When steers for winter feeding are first placed in the stalls, great caution should be exercised by all who are engaged in their care. Loud words should be avoided and patience exercised until they have become acquainted with their new surroundings. The man who must give expression to an evil temper by kicking or otherwise abusing the cattle, should promptly find an occupation elsewhere. Some good breeders even advocate closing the stables to all-comers after the morning work has been completed, and allowing the

stock to enjoy absolute contentment until feeding time again.

In the handling of dairy cows, similar abuses abound. Heifers are made useless as milk-producers by careless or impatient persons, who, during the first days of milking, find it convenient to use the stool as a corrector, instead of such a measure of kindness and forbearance as would in a short time create within the young milker a confidence in those responsible for her training. In breaking colts to harness, too, it is invariably the rough and unintelligent driver who makes the balky horse. He undertakes to make the youngster acquire in a day, lessons that should occupy weeks, and when progress is not made as expected, the lash is applied, and fear takes the place of confidence, with a spoiled horse as the result.

Animals soon learn the disposition of their caretaker; they are possessed of an instinct which enables them to determine the extent of his humanity. Most classes have also sufficient intellect to acknowledge any kindness which they may be given, and true stockmen are those only who love their stock and take an interest in their training, feeding and care.

Breeding the Sows.

As most of the sows in the country will be bred in December, in order to have their litters born in April, a little consideration at this time of the most convenient methods of carrying out the breeding operations will be seasonable. Where a boar is kept for service of sows in the neighborhood, and a considerable patronage is expected, it is a great convenience for loading and unloading to have a chute built at the end or side

of the building where the boar is kept. This can be cheaply built of posts and planks, and its floor should be about the height of a waggon bottom. By the use of a low hurdle of the required length, the sow may be guided into the pen, and from it to the chute. Time and trouble can be saved by the use of a breeding-box, in which the sow is placed during service. This is easily made, and is practically an ordinary pig crate about 4½ feet long, two feet wide and 2 ft. 9 inches high, with the top and the hind end left open. The length for small or large sows is regulated by having a second or sliding front, which is dropped between cleats on the sides. A bar is used across the hind end, about one foot from the bottom, to prevent the sow from backing out, and a platform made of four-inch scantling and inch boards,

placed behind the crate, with cross cleats to prevent slipping, is used for the boar to stand upon if needed. If a heavy boar is in use, his weight may be supported by having side wings on the inside of the box, on which his fore feet may rest. These may be so hinged that they may be turned down if not needed, or in getting the sow in or out of the crate. The breeding-box has been described and illustrated more than once in the "Advocate," and is a contrivance of so great convenience that no breeder can well afford to be without it.

The use of a short hurdle in the pen for guiding the sow into the crate is also a great convenience. As a rule one service is sufficient, and the sow should always be kept alone in a pen till her heat has passed off. In the case of a sow that has returned more than once, a second service near the end of her period of heat is advisable.

Amending the Embargo.

A cable despatch from England states that, as a result of the efforts of the Canadian Department of Agriculture to have the embargo removed, that the British Board of Agriculture may extend the ten days' limit for the slaughter of Canadian cattle to twenty days.

The duty of the hour: A prompt renewal of your subscription to the "FARMER'S ADVOCATE" for 1903. Discharge the duty, and you will sleep easy.

The Sheep Protection Act.

To the Editor "Farmer's Advocate":

Sir,—I have read several articles in the "Advocate" pertaining to sheep-worrying, and I regret to state that I have had some experience with the dog nuisance. In the autumn of 1899, we had eight sheep and four lambs killed during the night. I was awakened by the dogs barking, and saw the dogs, but could not swear who owned them, it being too dark. To prevent a recurrence, I went to the Township Council and drew their attention to the existence of an act passed A.D. 1890, C. 62, page 142. The reeve said he would consult their solicitor, and by all means have said act enforced. But instead of doing so, he had a by-law framed and passed to prevent collection of dog tax. I then obtained advice re its being legal, which was in effect as follows:

Every municipality in the Province must collect the dog tax (except where a by-law has been passed setting aside said tax). If the assessor has neglected to assess the dogs he is liable to the municipality. If he has assessed the dogs and the clerk neglected to extend the figures to their proper column then the clerk is liable, but in no case can the person suffering loss not recover from the municipality. But the municipality can recover from either the assessor or clerk who has neglected his duty, together with all costs.

In every municipality in Ontario, should a ratepayer have any sheep destroyed by dogs, the municipal corporation is liable for two-thirds of their value. But in no case is the municipality liable where the owners of the dog or dogs are known. You must sue the parties, and if you cannot recover by distress, then the corporation must pay you two-thirds of your claim, and all costs. R.S.O. 1887, C. 214, S. 17.

We, in Ontario, have a good act for the protection of sheep, because the owner of pure-bred sheep can recover two-thirds their value from the municipality, and, through the municipality, the difference between that and full value from the owner of the dog (when discovered) which may kill them or in any way affect their value, by tearing or wounding. The money collected for a dog-tax, and not required to pay for sheep destroyed by dogs, becomes an asset of the municipality, and may be used as a general fund of the corporation. R.S.O. 1887, C. 214, S. 7.

Section 2 of the act should be amended or repealed; it reads: "Upon the petition of twenty-five ratepayers the council of any municipality may provide by by-law, that the said tax shall not be levied in said municipality."

If the councillors (or other representatives) have no consideration for the sheep industry of the township, and respect the petition of twenty-five ratepayers (the majority of whom may be sports or dog fanciers), then the sheep industry is not receiving the protection that was intended when said act was framed. T. J. G. Russell County, Ont.

[Editorial Note.—Our correspondent is substantially correct for the most part in his statements of statute law. It is well, however, to point out that there may be municipalities in the Province of Ontario wherein sheep-owners cannot collect through the municipality for losses sustained from injuries to sheep by dogs, even where a dog tax is collected, for by section 8 of the R.S.O. (1897), Chap. 271, the council of any municipality may maintain the tax and yet, by by-law, dispense with the application of the proceeds thereof to the payment of such losses.

The Act for the Protection of Sheep and to Impose a Tax on Dogs (which is the statute above referred to), gives owners of sheep certain remedies, and provides certain facilities for recovery of compensation for losses, beyond what are afforded by the common law. It gives him the right to kill any dog which he sees pursuing, worrying or wounding any sheep; or any dog without lawful permission in any enclosed farm field, which he finds giving tongue and terrifying any sheep; or any dog which he finds straying, between sunset and sunrise, on any farm whereon any sheep or lambs are kept. But no dog so straying, which belongs to or is kept by the occupant of adjoining premises, or is securely muzzled, or accompanied by, or within call, of any person having charge of it, can legally be so killed, unless there is reasonable apprehension that if not killed it will pursue, wound or terrify sheep then on such farm. And in case of damage to sheep from dogs, provision is made for the killing of the dog by order of a Justice of the Peace, and also for proceeding before a Justice against the owner or keeper of a dog so injuring sheep, for the recovery of damages in a summary way. The act also makes the provision already alluded to, for recovery from the municipality in cases where the sheep-owner is unable to enforce the order made by the Justice in his favor, provided it be a municipality wherein a dog tax is levied and the proceeds kept to be applied to the purpose.]

Canada's Interest in Australia.

To the Editor "Farmer's Advocate":

Sir,—I have yours of June 30th. First, as to the lines on which trade is developing between Canada and Australia. The trade fluctuates in accordance with the changing conditions of the two countries, but mainly in accordance with the ability of the Canadian exporters to fill orders



SUMNER HILL MEMBER.
Yorkshire boar. Winner of second prize in yearling class at Toronto Exhibition, 1902. Weight at 22 months, 670 pounds.
BRED BY D. C. FLATT & SON; OWNED BY F. C. SMITH, NEW HAMBURG, ONT.

and the enterprise put into the business. The direct Australian exports to Canada are small and at present insignificant. At the best, they consisted of some frozen mutton, butter and Tasmanian apples to British Columbia, and a few fur skins, hides and a little wool to Eastern Canada. Indirectly, they are more. Canadians buy Australian wool in London, and Australian skins in New York. In the latter case the skins are carried by Canadian railways past the doors of Canadian fur manufacturers to New York, and are there bought and brought back again. It seems improvident to pay expenses in New York and double freights, but the Canadians seem to like it that way. The exports from Canada are much more varied. The products of Canadian farms sent here are flour, wheat, a little oatmeal, peas; cheese, hams and bacon, and occasionally fruit green, dried and canned, seeds. Some of these lines could be increased and others at opportune times sent here, such as oats, butter, potatoes and onions.

You have not space for the reasons why they are not, but mainly it is because the Canadian wishes the Australian to come to Canada, buy and pay for the goods there, and the Australian desires that the goods should be sent out and sold here. In the meantime, while these two cautious peoples are waiting and doing nothing, the Californian sends the stuff over and supplies the market. If Canada expects to do an export trade she must pursue the policy of other nations and do her own business.

The custom returns show about one hundred



VIEW ON THE FARM OF MR. J. V. COOPER, PRINCE EDWARD CO., ONT.

other lines in large or small quantities imported from Canada. British Columbia sends timber and fish, fresh, salted and canned. Eastern Canada, agricultural machines and implements; cotton goods, white, gray and colored; bicycles; boots and shoes; carriages and carriage materials; furniture; India-rubber goods; pianos, organs and other musical instruments; silk goods;

engines and machinery; plaster of Paris; ammunition; surgical instruments and dental goods; typewriters and typesetting machines; steel shingles and metal plates for roofing and interior of houses; leather hollow-ware, woodenware, etc.

Second: The classes of live stock making most progress and likely to do so. Just now, owing to the drought, none but those that in the past and that are likely to in the future are sheep, cattle, horses and swine, in the order named, with a probability that with the increase in dairying, horses and swine will change positions. Australians have displayed remarkable skill in the improvement of wool-bearing sheep, particularly Merinos. The average weight of fleece has been increased over 50 per cent. in 20 years.

Third: You ask for "The classes of animal and other products, the exports of which to Great Britain are on the increase."

Just now, owing to the drought, as above stated, practically none, but to go back to a series of years first wool. Australia is essentially a pastoral country, and is mainly devoted to the production of wool. The following table of exports will show how rapidly trade has grown:—

Year	Wool Exported (Lbs.)
1861	75,019,800
1871	175,169,400
1881	361,346,700
1891	674,205,600

Then, owing to drought and other causes, a decline set in and the amount declined. New South Wales in 1891 contained more than half the sheep of Australia, but does not reach that figure now. In 1891 its wool clip was valued at £11,036,018; in 1900 the value fell to £7,632,213. In 1891 it had 61,831,416 sheep, to-day the drought has reduced the number to less than half that figure. Great Britain is not the only buyer of wool, but she is practically the only buyer of meat (frozen and canned), tallow, butter and wheat, hides and skins and apples from Tasmania, the other products of the land exported. A little cheese has been exported, but its production has not increased so rapidly as that of butter, which has proven most profitable. It must be remembered that I am not speaking of New Zealand, but of Australia and Tasmania only. The butter produced in the New South Wales factories increased five-fold from 1891 to 1900. The total production of Australia in that year was 112,401,496 pounds.

Lastly: The lines of agriculture the governments are seeking to stimulate. As yet the Commonwealth Government has done nothing in this respect, and the work is likely to be left to the State Governments. The lines vary in the different States. In Queensland much attention is given to the production of sugar and tropical and semi-tropical fruits; New South Wales to butter; in South Australia to wine, and in Tasmania to apples and small fruits. In all the States there is a disposition to break up the large holdings used as stations in the fertile districts to induce closer settlement. This means in the end mixed farming as in Canada. The progress has been disappointing. The Australian is a born grazer, and slow to learn the necessity of growing and storing feed for his stock and hand feeding them.

The stock in the very best districts in the dry, hot times, or in the winter, are often in a wretched condition, and there are more of these seasons in ten years in Australia than there are winters in these years in Canada. The country at these times will be as desolate as the fields in Canada at midwinter. A large cheese producer told me he had been looking up the Canadian figures and was surprised to find that the average Canadian cow produced twice as many pounds of cheese per annum as did the average of his herd.

Australia has done great things in improving her sheep, but much can yet be done for her other stock. To have cast an imputation of this sort upon the Australian horse would once have been deemed here to be equivalent to blasphemy, but the South African war has taught the breeders that while they have produced speedy sprinters, they are after all going to weeds. I believe that Canada could supply pure-bred stock in horses, cattle and pigs which would much improve the stock of this continent.

L.
Office of the Commercial Agency,
Australia, Sept. 29, '02. Canadian Government.



THE HOME OF MESSRS. THOS. BIGGAR & SONS,
Chapelton, Dalbeattie, Scotland.

Dignity of the Breeder's Calling.

A deep love for original creative work has fired the high ambition of many a true breeder until his efforts have been rewarded and the product of his skill stands full worthy of wearing the coveted prizes in the show-ring—winning even in death—the crucial block test still verifying superiority. In times past a few men, through use of this rare gift, made world-wide fame, and not for one moment will the thought be entertained that the highest knowledge and skill in this art perished with them.

What has been achieved can be repeated—even surpassed. Previous lessons are practically weighed and the deep-thinking man of to-day who decides to make breeding his life's work carefully fits himself to begin where the ablest left off, ere he assumes the responsibility of shaping wondrous creations out of the helpless forms confided to his care. This art which deals with the modeling of living creatures must (if improvement is to be made) have behind it a mind capable of grasping fundamental principles and keenly able, not only to conceive an ideal animal form, but also call that forth into life through a wide knowledge of nature's intricate and hidden laws. Knowing this to be true, none will dispute that the breeder's calling is a truly dignified one; it required genius and intellectual force to give our present high standards, yet the top notch has never been reached. Fresh honor still awaits him who climbs. Vigilance is the pathway to success, unremitting attention means "good luck." Be advised to give more care to details, for most blunderings have arisen from some apparently minor overlook. Ever remember there are two forces at work, one constructive, the other subversive. Another plume which each breeder should possess is enterprise. Many a splendid animal has never been fully appreciated through lack of this necessary quality. Of course, small souls, through jealousy, will decry the best products of even the master builders. Fear them not, stick to your own ideals, being careful that utility, good form and constitution were rightly balanced when these were formed. This fraternity must never be mere peddlers of pedigrees, trying to corner the market, or yet cater to such freaks of fashion as color, escutcheon definitions, etc. Shun inbreeding; pedigree restrictions have made relationships of families closer than at the time when a judicious amount could be safely relied upon as a fixer of type; stand away now from such dangerous ground. Some ask, does showing of stock at fairs pay? The old saying that the light hid under a bushel cannot be seen at a distance might apply here. Successful showing is a great advertising medium, and judicious advertising lies at the foundation of all business success. He who ignores this fact has rightly no one but himself to blame should his surplus stock find no satisfactory market. Merit and advertising to give good results must necessarily go hand in hand; the wares must be worthy, and known, ere justice will be done to the investment. Good stock is not often fully appreciated in any immediate neighborhood.

A market for surplus stock is a necessity, and all must reach out for it; it seldom comes unsolicited. The show-ring and the public press are the two best mediums of communication to-day. Some use one, some the other, and the truly wise both. Show fitting, if continued, is injurious to stock, matured animals suffering most. The younger ones ought to be well done by, at least until they approach maturity, so are seldom injured, although show fitted, if returned to pasture shortly after. Until show-ring judges are content with less fat the average breeder should limit his showing to young things. This plan is quite effective as far as the buyers are concerned.

Snap-shots at British Agriculture.

THE FARM PUPIL.

The person referred to above is part of a system which looks at agriculture as an easy way of living in healthy surroundings. The farm pupil is the chrysalis of the gentleman farmer. This budding agriculturist is generally the son of indulgent parents, who have endowed their offspring with more money than brains or energy.

The writer had the pleasure of dropping in, as it were, on a preserve on which farm pupils were kept to undergo the pupilage process. The tutor was a

smart, bright, active farmer, who would have made a first-class settler in any colony, but who at the early stages of his career lacked an adequate supply of this world's goods, hence his reason for taking pupils. He was qualified for the work, however, which cannot be said of all those undertaking such a job. This farmer, when asked his candid opinion of the scheme, laughed and said: "I follow the same system as the university professor; if a chap wishes to learn, I will do all in my power to help him, but I use no force in the matter. The only restriction I do enforce is, that I will have no boozing—once a fellow does that and I find it out, I bundle him off home!"

The pupils vary in age from 20 to 30, and about one in four takes the profession of agriculture seriously; the others, born with silver spoons in their mouths, and being accustomed to being fed therewith, just fritter away their time and lives. During the period of my observation, I noticed one walking around with a spade over his shoulder, and thought I had the serious-minded one. I was mistaken. He was about to dig bait (worms), which found, he would fish for eels all day. Looking over a hedge, I saw another armed with a trap and stick—he was rat-catching. Noticing my look of interrogation, the tutor said: "If he was my own son, I would ply the stick on his back. As it is, the pupils are a means to an end, and their people pay promptly, possibly glad to have them out of the way." One kept a horse and bred a few canaries, and would spend an hour debating the value of a certain make of pipe. Farmers none of them would ever be—and very poor apologies for estate agents—theirs was the opportunity which they let fly by unheeded. The tutor, a man who has had to rustle for himself, and successfully too, says, "I believe in firing every child out to do for itself when sixteen or seventeen!" And the theory is a good one, when one sees the working of the opposite principle. One thought that struck me was: These must be the young fellows some good people would have an agricultural college built for, in Manitoba, a sort of annex to the University. Young Britishers, such as these, usually have a fair knowledge of English, but little else. It was this kind of trifler that used to infest the O.A.C. halls, years ago, causing no end of bother, and were never a credit to the college, although favorites in some social circles.

That any sane person would think of using public money to provide an asylum in the shape of an agricultural college for such as these is passing belief, and yet some persons, doubtless well-meaning, but strangely lacking in knowledge of the practical, continue to urge that provision be made for the young British emigrant.

When any province in Canada establishes an agricultural college, its chief aim and object should be to benefit its own agricultural community. No college

could afford to stake its reputation on an effort at making successful farmers out of a class of moneyed Britishers. To get real benefit out of an agricultural course the student must first be a farmer, or at least have spent two or three years of actual work on a farm. As it is altogether likely the young Manitoban would attend the agricultural college during the formative stage of his character, close contact with one of these imported trifiers in a residential college would be more dangerous than a contagious disease.

The farm pupils I saw pay a good sum for their pupilage—\$500 a year in house, or half that if outside. They are made very comfortable, and might, if they were so disposed, spend their time very profitably. The only way to make a farmer is to take a youth of sound common-sense and lots of energy, and put him on a farm, under the guidance of an up-to-date farmer, and have him work; teach him to take hold of anything and everything. If at the end of two or three years a course at a good, practical agricultural college can be afforded, it will be a good investment, and will tend to put a polish on the young farmer's brains which would take a long time to get otherwise.

INTER PRIMOS.

Selection of the Beef Sire.

To combine the butcher's, feeder's and breeder's needs, large scale, strong constitution, great wealth of natural flesh and early maturity must be had, and to insure satisfactory improvement in any herd, the stock bull must be typical of the breed, with abundance of masculinity. Sires that have proved to be outstanding in leaving a lasting impression of their individuality on their offspring have had a determined expression, indicating strength and boldness, and an active, vigorous temperament, which is also an evidence of virility and proves that the animal is strong and fully formed in all regions which have to do with the powers of vitality and reproduction. Excellence of girth is another very essential point; the ribs must be long and well arched, giving abundance of room for the vital organs and great storage capacity for food. Ample natural provision in these parts indicates ability to utilize large quantities of food, and augurs well for rapid progress in fattening. A straight, broad back, and wide, thick loin, assures a large percentage of the most valuable cuts, so should be carefully noted while purchasing. The rump must be long, level and smooth, with muscular thigh development, thick and low, also full, well-rounded quarters; short legs, with good strong bone, are also needed, and the mellow, mossy coat as evidence of a thrifty, vigorous, flesh-forming disposition. Style, finish and general beefing attributes must be freely indicated by the general characteristics of the male, as evidence of his ability to transmit these to his progeny.

Two of the most difficult points to build up are, first, ribs that start from the spine in a downward direction (instead of arching out), giving a wedge shape to the upper third of the chest; and, second, ribs, although fairly long, yet deficient at the lower end, causing a curve upward in under line immediately back of the fore legs; these two defects are harder to breed out than any others, except, perhaps, downright bad shoulders. A drooping rump can be brought right with two judicious crosses, but the defects of a narrow chest and flat ribs and tucked-up foreflank are caused by deficient vital organs within, and as the enlargement of these organs requires many strong crosses to grade up, be very careful in this point in making your selection.



VIEW ON THE CHAPELTON FARM
of Messrs. Thos. Biggar & Sons, Dalbeattie, Scotland.

The Tuberculin Test and Imported Cattle.

(From the London Live-stock Journal)

Sir,—It looks as if the Governments of the United States and Canada mean to keep up the scare about bovine tuberculosis, although Dr. Koch has clearly shown that there is very little in it, in so far as the transmissibility of the disease from animals to mankind is concerned. These Governments in North America have rendered the exportation of carefully selected pedigree cattle from this country almost impossible. As tuberculosis is not hereditary, it is difficult to see what possible harm could result from the importation of carefully selected animals that are obviously in good healthy condition. If the Americans and Canadians are convinced of the value of tuberculin, why do they not make its use compulsory among the cattle in their own countries? They have more sense! As the new regulations will prove to be very detrimental to the export trade, could not our Government show that what is sauce for the goose is also sauce for the gander? The Americans profess to be frightened that their precious herds may receive contamination from good healthy British cattle. But what about our people who eat American and Canadian beef? There is no proof that the cattle there are wholly free from tuberculosis, and yet they are allowed to land here alive in thousands without any test to ascertain if they have this disease. It is to be hoped that the President of the Board of Agriculture will see to this anomaly at once. An order should be issued without delay, enforcing the application of the tuberculin test on all cattle imported from Canada and the United States. Perhaps a second test would also be desirable—the expenses of the tests and of the keep of the animals during the time they are undergoing the ordeal to be paid by the exporters. If 20 per cent. of the cattle reacted it might be desirable (again following American methods) to schedule the places from which they were consigned, and allow them to send their cattle as dead meat, for which a certificate ought also to be required that the carcasses were those of animals that had been put to the tuberculin test and had not reacted. Certainly the life of a British subject, which may possibly be endangered by eating imported tuberculous meat, is of infinitely more value than thousands of ranchers' oxen, which, they say, might contract disease from high-class healthy stock imported from this country. X.

Winter Care of Breeding Ewes.

If a large crop of strong lambs is to be expected when the lambing season arrives, the breeding ewes must receive proper care during the winter. The practice, so very common, of allowing them to forage for themselves in old meadows or around stacks until the gains made on the fall pastures have begun to disappear is very poor economy indeed, and altogether degenerating to any flock. Not that a run to the old pastures on fine days should be discountenanced, because long experience has proven that the more closely we follow nature in the management of this as well as other classes of live stock, the greater will be our success. They should not be expected, however, to depend too much upon such sources.

Where it is necessary to feed from the barn there is no better roughage than clover hay, but corn silage and clean pea-straw are cheap and valuable substitutes. A mixture of the three, about equal parts by weight, makes a splendid combination when cut into short lengths and mixed. If access to pastures is prevented, roots should be supplied in moderate quantities. Turnips will be most readily eaten, and the best method of feeding them to breeding ewes is to scatter them whole, either in the yard or pen, and allow the ewes to scoop them at will. In so doing they will obtain exercise, a reasonable amount of which is conducive to the growth of a strong fetus.

As the lambing season approaches, and within four or five weeks of that event, grain should be fed, in addition to the roots and roughage. To begin with, one half pound daily of oats, barley and bran, equal weights, should be supplied, and later this amount may be increased somewhat, according to the size and condition of the sheep. It is not necessary that ewes be kept fat; considerable flesh is desirable, but a strong healthy body is the main requisite.

The winter quarters should afford protection from rain and snow, be well ventilated and not drafty. A single ply of lumber with battens is sufficient for the wall unless early lambs are expected, in which case a warmer pen should be provided. If the location be well drained an earth floor will be quite satisfactory; the amount of space ranging from ten to fifteen square feet for each ewe.

Discard the Sour Swill Barrel.

One of the chief reasons why some hog-raisers fail to secure the success which their neighbors enjoy is because the kitchen refuse is allowed to become fermented before being fed. It is a mistake to imagine that everything a hog will eat is good for him. He has really no greater need, nor does his system call for food strongly acid, than a man would have for pickles at every meal. There is no more active agent in promoting indigestion in hogs of all ages and in checking rapid

**CHALLENGER.**

A British bull, the sire of some Shorthorn emigrants.

and profitable growth than sour swill. It keeps young pigs thin in flesh and heavy in belly; and for older ones, and brood sows in particular, it commonly puts them "off feed." While everything coming from the kitchen should be made use of, its receptacle should be kept clean. Take it all down to the pens while fresh, and feed at once; nothing can be gained by delay, and much may be lost.

To Remove Warts.

To the Editor "Farmer's Advocate":

Sir,—I notice in your issue of Nov. 15th, that J. O. N. of Sunbury Co., N.B., wishes to know how to remove a wart, and having a simple remedy which has been tried in several cases, and as yet has not been known to fail, I thought perhaps it would be well to make it known. It is as follows: Rub the wart well once a week with lard. This will remove warts from either cattle or horses, and in most cases that have come under my immediate notice, when the animal has come up for the third application no traces of the wart or where it had been could be discovered. Hoping this may be of benefit to some one, as many things in your paper have been to me, I remain,
H. J. BRANDER.
Lambton Co., Ont.

Hampshire Down Sheep.

Can you give me the address of some reliable breeder of Hampshire Down sheep? I do not see any advertised in the "Advocate."

Ans.—Hon. M. H. Cochrane, Hillhurst, Que., has a first-class flock. John Kelly, Shakespeare, Ont., has also a real good small flock, and Telfer Bros., Paris, Ont., showed a few good ones at Toronto this year.

The service rendered its readers makes the "Farmer's Advocate" the cheapest farmer's paper in America to-day.

**SHEEP OR DOGS, WHICH?**
Pay your money and take your choice.**The Shotgun Method.**

In speaking of the dog nuisance in "Successful Farming," Mr. Wm. Rennie says:

"For that annoyance, lead is most effectual, and every farmer who has a valuable flock of sheep should keep a loaded gun in a convenient place, and when he finds a dog chasing his sheep he should shoot it, bury it, and keep his mouth shut."

FARM.**Rural Mail Delivery.**

To the Editor "Farmer's Advocate":

Sir,—Your October 1st editorial regarding free rural mail delivery was timely and to the point. The time has arrived when our Federal Government should begin giving their attention more to the needs of the agriculturists of Canada along that line. Manufacturers put forth their claims in concert, and frequently have their wants attended to. With the farmers in many parts of the older provinces, having in recent years changed their business of being merely grain-growers to be manufacturers of more finished products, which vary in values day by day, it has, therefore, become most important to have daily reports of the world's markets; and how is it possible to get these, with farming operations so often of late suffering from want of attention at the proper time, because of the existing scarcity of labor? Going or sending one to four miles daily for mail matter is getting to be altogether too heavy a tax on the majority of producers in the rural districts, and yet without the required quotations loss is certain to result. How often have we heard of a stock feeder, or a dairyman, or seed-grower, in marketing his productions, having lost heavily, simply because he had not the opportunity of being equally as well posted as the buyer who got his free delivering of mail three or four times during the day! In the thickly settled sections, how much saving of labor would result from having a carrier going along a ten or fifteen mile route with and for mail matter, compared with twenty or thirty individuals along the route going to the office daily? We fully recognize that principle of labor-saving in our beef-ring arrangements, when weekly we have our butcher deliver meat at our farms, and 'tis the same in connection with the delivering of milk to factories, towns and cities. One man, working along a practical system, accomplishes what a score can do on individual lines.

We are well aware of the question of cost entering largely into the consideration of the proposed improvement. Speaking for myself, I would say, better by far, if necessary, have mail delivery, even if we have to pay extra for it. But will extra pay be required if the post office department would not be compelled to do so much without any remuneration for the other departments of our Government and for individuals? I maintain we, in the rural sections, have the right to demand free delivery of mail, whether the department pays its way or not, while so much franking is done for the other departments down to party political campaign matter. The States Government has solved the question for us to profit by. It has for years experimented, starting on a small scale, not so long ago, but already the system is becoming general in many States. In connection with our sheep trade, we think half of our correspondents give free-delivery route addresses. Why not we in Canada also?

Let us unitedly demand the privilege given to our cities for years, and we can have it without fail. At our next general elections, let us put forth our claims, secure pledges of support from candidates, and give our support to those who will agree to carry out our wishes.
Victoria Co., Ont. JOHN CAMPBELL.

Rural Mail Delivery.

To the Editor "Farmer's Advocate":

Sir,—I noticed an editorial in your issue of Oct. 1st, on the above subject, and I sincerely congratulate you upon your public spirit, and the deep interest your paper takes in the farming

citizens of this great land. A great many of us are unable to take a daily paper, due to the fact that we can not afford the time off our farms to go to the offices of delivery, which are from three to eight miles distant from any home on the fifth concession of Verulam, south of Sturgeon Lake. On this line, which is about four miles long, twenty-two families reside; this whole section is thickly populated, and having the mail de-

livered at least every second day would prove a great blessing to your less fortunate fellow-citizen, living out here sixteen miles from the nearest railway station, by bringing him in touch with the commercial world three times a week instead of once a week. It is to be hoped that all farmers will put their heads together, and, with one tremendous effort, bring an unparalleled blessing to their homes.
R. J. MITCHELL.

Victoria County, Ont.

Start the Rural Mail Delivery.

The Toronto Globe, after referring to the successful extension of the free rural mail delivery system in the States, for which there are now 11,650 routes, concedes that it renders a material service to farmers, of which they had hitherto been deprived, and also that it tends to become self-supporting from the increasing revenues derived. The Globe, however, adds:

"In Canada the distribution of population may not, as yet, be favorable to any extensive employment of a rural free delivery system. Free city delivery is defended on the score that as much is charged for a letter which is not carried on the railways at all as for one that is carried hundreds, perhaps thousands, of miles before reaching the addressee. Some persons point out that there is a special stamp by which one can have a letter delivered by a special messenger. A further application, they say, might be made of that principle, which would entitle a letter to be delivered to an address in the country. The difficulties to be solved in connection with this proposal are not small, although not insuperable. Increased population is the best solution, even though it may be a slow one."

The special stamp delivery would not fill the bill, in lieu of regular rural mail delivery, and we cannot think the suggestion is seriously put forward. We question if the United States rural delivery has been inaugurated in districts any more densely populated than is Canada. We believe that in this respect the agricultural districts of Canada compare very favorably with those of the States, if, indeed, the advantage is not in our favor. To grant this boon to the business and social interests of the country will mean outlay, of course, but it should not be denied for that reason. The country's foundation industry in many localities badly needs such a service, as many of our correspondents have pointed out. Sparse population is rather an argument in its favor, because giving farmers privileges now in the possession of city people is one of the very best ways of encouraging more people to live in the country. Let a beginning only be made, and the difficulties will soon be overcome by the vigorous businesslike methods of the Canadian Postmaster General. A full-fledged system is not expected to spring into existence in a day. It will be a matter of development like those other new things, the rural telephone and the rural electric car.

The Food Value of Oats.

A great deal of misapprehension exists regarding the selection of oats as food. The characteristics of a good oat are (1) its condition which is denoted by its sweetness and hardness of the kernel; (2) the strength of its husk, whether it is thick or thin; (3) the weight per bushel and purity, by which we mean freedom from material of any other kind, whether dirt or seeds. It is scarcely necessary to say that there is more food in a bushel of hard oats than in a bushel of the same variety which is softer in the kernel—the one contains less moisture than the other, and consequently more food.

In judging a sample, if we take the apparently thinnest and lightest grains and find kernels within we may rest assured that all the oats contain food; but it constantly happens that many grains in the handful are nothing but husk. Sometimes the oat is harvested before the last formed grains are filled with kernels. It is usually safe, therefore, to examine the thin kernels in estimating the value of a sample. Next, the husk may be examined, and we shall often find that in a heavy and more costly oat this is thick, so that the buyer pays rather for worthless fodder in the husk than for additional food as compared with a lighter oat with a thinner husk.

To those who are able to pay close attention to this matter we would suggest a simple experiment. Two samples may be selected, a heavy home-grown oat and a lighter and cheaper oat with a comparatively thin skin or jacket. In each case the husks may be removed from a hundred grains and weighed on a delicate balance. It will probably be found that in one case the husks will weigh considerably more than in the other, and if the figures are worked out as applicable to a bushel or a quarter, the full measure of the difference will be better understood. This plan has been adopted in comparing the values of different oats, and sometimes with most extraordinary results. Again, if we take a clean sample at a higher price than a second sample of apparently equally good oats, and from a given weight, which may be 1 ounce to 10 ounces, collect all the waste material, including the empty husks or kernelless grains, we shall find that by weighing we are paying, in all probability, a good deal more for the cheaper sample than for the more costly one, which after all may be the most economical.

Suppose we take two samples at present market prices, and having decided the weight of husk in each case, and subsequently by testing the samples the relative proportions of dirt and other

impurities, we arrive at the conclusion that the more costly sample provides a smaller weight per bushel of feeding matter than the cheaper sample, it follows that we shall not only be saving several shillings, as between the respective weights per quarter, but still more owing to the difference in the proportions of food present.—[Farmers' Gazette.]

Large Farms and Their Management.

Six miles north and four east of Carberry, Manitoba, will be found the homestead of W. P. McRae, where for the last 19 years he has farmed successfully.

During that time, with one exception, the yearly average of his wheat crop never went below 18 bus. per acre, his highest average being 40 bus., and that year 50 acres averaged 45½. Of the 480 acres composing this farm, 400 were under cultivation this season. Last year \$4,112 worth of wheat was sold, besides other grain, and the good quality of the product is evident when it is known that almost invariably the price received for the wheat was equal to that paid for No. 1 hard.

The rotation practiced on this farm is three wheat crops followed by one of oats, and then summer-fallowing or seeding to grass.

Mr. McRae believes in only cutting one crop of timothy and that early, plowing soon after and again sowing to wheat. By this method he claims that a better sample is produced, with less straw. Regarding summer-fallowing, plowing once and cultivating frequently is preferred, but of course where the land is very weedy it becomes necessary to plow twice.

This year's crop was put in with 9 horses and two seeders; one a 22-shoe drill and the other a

Save the Wood Ashes.

From the fact that large quantities of wood ashes are annually bought in Canada, to be sold to New England farmers and gardeners, it is quite evident that their true value is not appreciated in this country. In a New York State farm paper at the present time, the best grades are quoted as high as \$14.00 per ton, and while they find it economical to apply this essential constituent of plants at that price, we, with a soil also becoming depleted in potash, allow ashes to leave our shore for little more in most cases than \$4.00 per ton. Why this should be is hard to explain. The answer lies altogether with the Canadian farmer.

According to a number of analyses of ashes, which have been made in an official way, the average composition has been placed as follows:—Potash 5, phosphoric acid 1.5 and lime 32.5 per cent. Estimating according to the prices which are paid in this country for other fertilizers, we find they are worth about 25 cents per bushel when applied to the soil. Some have the idea that ashes from soft wood is comparatively valueless, but this is a mistake. While they do not weigh as much, bulk for bulk, yet, when equal weights are examined, little difference in composition will be noticed.

There is probably not a farm in the older settled sections of Canada that has not an orchard or garden or some corner where wood ashes could be profitably applied, and it therefore becomes those who burn wood in any form to see that not one pound of this valuable fertilizer is wasted by exposure to rain, or sold for a mere trifle to the dealer who may come that way.

Contents considered, the "Farmer's Advocate" is now the cheapest agricultural paper available for the Canadian farmer.



FARM HOME OF WM. McRAE, KERFOOT, MANITOBA.

23. It was harvested with two binders and three relays of horses, thus keeping the machines running steady. Mr. McRae advocates fall plowing for wheat, but spring plowing gives him good results with oats. He has tried pure-bred cattle on a small scale and finds them very profitable, yet he bends most of his energies to wheat raising, and in that line, as will be seen, has been very successful.

His advice to newcomers is: Mind your own affairs, do your work well, keep down expenses, and then even should you have little to start with, riches will come in this country.

Value of Marl as a Fertilizer.

In reporting upon the value of marl as a fertilizer, Prof. Shutt, Ottawa, states: It can be used to advantage on all soils deficient in lime, of which it is really a carbonate, ranging in purity from 40 to 90 per cent. On heavy clays it flocculates the particles and renders the soil mellow, warmer and better adapted to root extension. In peaty and muck soils it neutralizes acidity, and is thus a corrector of sourness, and in sand it improves the tilth by cementing the grains and overcoming excessive openness and looseness.

Of the various samples analyzed, that from the Georgian Bay district, although of excellent quality, was not superior to that from other parts of the Dominion.

Marl can be applied to the soil in much larger quantities than lime, owing to its milder action. On most soils a good dressing of the latter would be one to two tons per acre, but marl may be beneficially applied in twice that quantity. Since all lime compounds have a tendency to work down beneath the reach of the roots of ordinary farm crops, it should be put on frequently, say every third or fourth year.

Fencing Highways.

To the Editor "Farmer's Advocate":

Sir,—I see by a recent number of the "Advocate" that a correspondent questions the correctness of my statement in re fences or no fences along the public highway. The statement is quite within facts. There is no statutory law requiring farmers to fence between the highway and their adjacent fields. I could, if necessary, refer to numerous test cases where the trial judges have clearly set forth this fact. And when municipal councils enact that certain animals may run at large without attendants, on public highways, it must be observed that such enactments limit the stock to the public highway. No council on earth can by by-law authorize the running of a neighbor's stock upon a farmer's unfenced land. The moment such animals leave the public domain they become trespassers and may be dealt with accordingly, and their owners are liable for damages sustained, fence or no fence. There are hundreds of acres of unfenced crops in Lambton and other sections. Our own by-laws are very clear on these points.

E. J. YORKE.

Lambton Co.

Another Canadian Sugar Beet Factory.

According to the Sugar Beet Gazette, a concern known as the Knight Sugar Company has been organized at Raymond, Alberta, in the Canadian Northwest, and has awarded the contract for the construction of a 400-ton sugar-house to E. H. Dyer & Co., of Cleveland, Ohio. The preliminary work for the buildings has already been commenced, and the plant is to be of complete fireproof construction. Mr. Jesse Knight, president of the company, is financing the project, and Mr. E. P. Ellison is the manager. Contracts are being made for acreage at a flat price of \$5.00 per ton for beets above 14 per cent. in sugar content, and the railroads have agreed to haul beets from distances not exceeding twenty miles from the factory at twenty-five cents per ton.

Caleb jinkins : His Letter.

jinkins Corners Nov 20 1902

To the edditer of the farmers Advocat
dear sir,

As i was brung up on to a farm tho i haint in the farmin bisness now but is livin privit in this villege jes doin a littel es a okshineer and vallater & lendin privit fums & so 4th yet i take a intrist in farmers and nose putty ni all of em



in this township es i am allus drivin round tendin to my affares. These one man up on the 2 conseshin is a petickler frend of mine name of Simon Fraser whitch hes got bout the best place in the hull township tho jes a few years ago it was a regler skrub of a farm & you mite spouse no buddy coodint do nothin with it, but Simon haint a scotch man fer nothin es the sayin is & es the methdis preecher ses in his sermin he has jes made the wilderniss to blossim like the rose. i allus like to git a invitashin to stay fer diner wen i hapen to be up Simons way cus his wife nose es mutch bout houskeepin and cookin es Simon dus bout farmin & you git a bang up meel.



Wen i was thare one day las spring & we was settin hevin a tawk wile diner was gittin redy i seen a copy of yure noosepaper on the tabel and started to take a look at it. Yude dorter suscribe fer the Advocat Jinkins ses Fraser, these splendid reedin in to it & it is jes chuck full of ideas how farmin dorter be did to make it pay. it hes did more fer me then eny thing i kin menshin and reedin it regler is bout es good es goin to the Colege in guell, he ses. Wel at fust i dident care bout suskribin es i haint farmin but wen i took a glants throo the paper i cum to the concloushin i cood git moren a dollars wuth outen it so i ses you kin put down my name Simon & heer is the cash. So he dum it & i hev bin gittin the Advocat sense that time & it hes woke up my



intrist in farmin affares and so the idee cum into my hed thet i will rite you sum letters occashnil to tell you bout my observashins mung the farmers of this sekshin. i kin stait rite now thet they haint menny of em up to the Simon fraser mark & i gess it must be becus in ginrel they dont take yure noosepaper sames he dose. I haint say-in this jes fer a compelmint to you fer it is plane es a pike staff thet if a farmer dont reed and

keep postid on his bisniss he cant keep up with the proseshin. thase a noshin goin round thet eny feler kin run a farm if he hes good helth and haint afrade of work but it dont need no branes ner studdy. This haint troo not by no meens, septin sech a farm es hiram Snaley runs only he dont run it he walks it and mitey slow at that. i hev node Hiram ever sense he cum to the township and took up his land and wen eny vissiter cum to my dwelin house and wants me to show him the sites round jinkins Corners i hitch up and drive him out to Snaleys place jes fer a joke. i tell him it is wuth wile fer him to see how farmin diddent otter be did and he cant find a better sampel of it nowares else. i drive up to the top of the hill ware we kin git a good look & then i pint out the objecks of intrist es you mite call em to the stranger & i bleeve it is a improovin ockashin es the methdis preecher ses. The fenses is down in sevril places & ware they haint down they air patcht up with stumps & rales and bits of borde & branchis of trees and looks regler tom tothery. Then i pint my wip stock at the barn & the vissiter ginerly busts out same es the barn is. The roof looks like its back is broke and the doors is hangin of with big holes in em ware the planks hes drapped out & haint bin put in agin. You kin see sum scrubs of cattel feedin roun the straw stack & wen i showed am to one feler frum the States whitch was a joker he ses dus Mister Snaley manifackter cattel hear. i ses no but he allows to breed em sum. O he ses i sposed he manifacktered em and wot we see is the frames put out thare to git seesind. the barn yard is allus cluttered up with a lot of ole broke harrers and waggins & so 4th and the dwelin house hes got a tired out look to it. Of corse i neent



harly say they haint no shade trees round the place Hiram dont bleeve in no sech fixins, it seems like his idee is to make the hull farm bout es ugly and oncomfertibel es it is possibel to do it. the oney trees is in the orchard and they are es measly a lookin lot es you ever seen. Hiram dont go in fer suskribin fer noosepapers septin the jinkins Corners banner that hes sum politicks in it & he gits it in trade fer cord wood. i offen hev tawks with this interprisin farmer & he is bout the mos stick in the mud feler i ever met in with. Wen i rite nex time i will tell you bout how i met him the day the farmers institoot was hevin its meetin at the Corners tho he diddent hev nothin to do with it, cus he dont take no stock in them sort of things, and the ideas he holes bout the Winter fare whitch i kin tell you he is sollid agin it.

Yurne fer the presint

Caleb jinkins

Canadian Hackney Wins Championship.

At the New York Horse Show last week, a Canadian exhibitor, Mr. Robert Beith, M. P., Bowmanville, Ontario, was successful in winning with his imported three-year-old chestnut stallion, Gribthorpe Playmate, the first prize in his class, and also the championship and challenge cup, as best Hackney stallion, any age, in the show. His chief competitor for this trophy was Robin Adair II., who won the challenge cup last year, being then owned and shown by Mr. Beith, and now the property of Mr. Mitchell Harrison, of Philadelphia. These are signal triumphs for a Canadian exhibitor, and Mr. Beith is to be congratulated on his achievements in this line. The champion is by Garton Duke of Connaught. Among the other Canadian winners were Mr. George Pepper and Crowe & Murray, Toronto, and Mayor Beck, M.P.P., of London.

DAIRY.

Dairy Instruction at Factories.

The Ontario Department of Agriculture last spring undertook a plan of work in connection with the instruction of cheesemakers. A syndicate of twenty-five factories was arranged for in the east, with Mr. G. G. Publow, of the Kingston Dairy School, in charge. A similar arrangement was made with Mr. Geo. H. Barr, of the Guelph Dairy School, in Lambton district, and these men have now completed their season's work. Mr. G. C. Creelman, of the Ontario Department of Agriculture, to whom these gentlemen have been reporting each day's work during the summer, has received a letter from one of the largest sheese exporters in Canada, who says:

"We have been through the district several times, in which Mr. Barr has been located during the past season, and we want to say that he has done immense good in that section, and all the factorymen to whom we have been speaking have spoken in the highest praise of Mr. Barr's work. Our own experience is that we have never had finer cheese from that section than we have had this year. We hope the Government will be able to still extend the work."

The second letter is from a cheesemaker in Eastern Ontario, where Mr. Publow was engaged. He says:

"I have been a cheesemaker for a number of years, and poor help, poor equipment and unsuitable surroundings had pretty nearly compelled me to give up the business. Nearly discouraged, I was still laboring on, when Mr. Publow took my factory into his syndicate. After he had visited my factory a couple of times, and had taken in the milk, an improvement was apparent. He also stayed and made cheese one day, on account of the bad flavor of the milk. Although I had received a good Dairy School training, I learned more that day about the bad flavor which I had to deal with than I could have in any other way. This confirms my belief that in the factory is the proper place for instruction regarding the troubles that are constantly cropping up. Mr. Publow afterwards held a meeting of the patrons, which did a great deal of good. One patron, who was sending a stable-flavored milk, immediately whitewashed his stable and cleaned up everything in connection with the dairy. We could then see a marked improvement in his work. He is now a strong advocate of this improvement. There are three factories surrounding me that were not in the syndicate. They manufacture for one cent per pound, while I receive 1 1/2c. per pound. In May we paid for milk 39 cents more per ton. The amount paid over the other factories has gradually increased, until for the last payment, September, the statement stood thus:

Our factory	\$18.76
Factory A	18.16
Factory B	17.46
Factory C	17.60

We are hoping for a continuation of the good work begun."

The matter will be thoroughly discussed at the next annual meetings of the Dairymen's Associations, to be held in January, at Brantford and Ottawa; and it is expected that this instruction work will be carried out on a larger scale next year. It is intimated that if the factories would agree to pay a small sum towards first-class instruction, the Department of Agriculture would supplement this sufficiently to engage a good man for the syndicates.

Strathroy Dairy School.

The annual circular of the Western Dairy School, Strathroy, has been issued. It announces the reopening of that institution on Dec. 2nd, when the special creamery course lasting eighteen days will begin. During the three weeks following Jan. 2nd, 1903, a short course will be given in such subjects as buttermaking, cheesemaking, milk-testing and domestic science. The principal or long course of the term commences on Jan. 26th, and lasts for two months, when the subjects mentioned will be fully dealt with. The domestic science course in itself lasts for a similar length of time, beginning Jan. 14th. With Archibald Smith as superintendent, the staff of instructors, all told, are twelve in number, and indications at present point to a very successful year.

No Creamery Trust.

Newspaper despatches published recently, stated that an American was at the bottom of a project at Montreal, exploiting a big creamery trust to get control of all the Canadian butter factories. Such schemes have been mooted before, but have always proved unsuccessful, and it is hardly possible that they should be otherwise, with the present spirit of Canadians and the conditions under which our creamery system is conducted.

Compton Model Farm Creamery.**DIRECTIONS TO CREAM GATHERER.**

1. The cream gatherer should be provided with jacketed cream cans, a spring balance, a pail for weighing and sampling the cream, a sampling tube, collecting bottles, a book to record weights of cream, and a thermometer.
2. At each patron's farm he takes from his wagon the sampling pail and tube, the scales, and one small collecting bottle, the book he has in his pocket.
3. He should find the cans of perfectly sweet cream, kept at a temperature of not higher than 50° F.; protected from dirt and bad odors, not kept in the cellar or the barnyard water trough, or near the swill bucket, or in the sun; not left uncovered, or shut up too tight, but preferably covered with a damp cloth.
4. Either sour, bad flavored or frozen cream must be rejected, in order to protect all the patrons from loss.
5. The patron's number should be placed in some conspicuous place near the cream cans, and here a hook should be provided. The cream gatherer hangs his scale on this hook, near the cream to be collected. The scale should be made that the hand of the dial will stand at zero when the empty pail is hung on it.
6. To Sample the Cream.—The cream must be poured into the sampling pail, then back into the patron's cream can, then into the sampling pail again to mix it thoroughly, and the sample taken at once, and the cream weighed.
7. In sampling, lower the sampling tube to the bottom of the weigh pail which holds the mixed cream, then raise it out and allow it to drain for a few seconds; this is done to rinse the tube with the cream to be sampled. Then lower the tube again to the bottom of the pail, and after allowing a moment for the cream to rise in the tube, close the top of the tube tightly with the thumb, raise the sampler carefully out of the cream, without any jarring, put the end of the tube into the collecting bottle with the patron's number on it, and let the contents run into the bottle. If the patron has more than one pailful of cream, repeat with each pailful the entire operation of sampling and weighing, using but one collecting bottle. Cork the samples securely and keep covered up.
8. Weigh the cream in the cream pail to the half pound, and record the weight. Occasionally take the temperature and record it in weight book.
9. Observe that each patron is provided with a clean and bright cream can; no rust or dirt should be visible.
10. The cream gatherer personally, his team, wagon and utensils should be an example of cleanliness and order.
11. The cream gatherer is expected not to smoke when performing his duties, or to allow the cream to become exposed to any taint whatever.
12. Cream can only be gathered properly in a spring wagon, and a cover is necessary in hot weather.

DIRECTIONS TO CREAM PATRONS.

1. Good milk is only produced by clean milkers, milking clean cows in a pure atmosphere, and fed only on pure and wholesome food and water.
2. Separate in a pure atmosphere as soon after milking as possible, for the best results.
3. If the milk is too cold for separating, warm gradually by placing it in a vessel of hot water, and stirring all the time, but don't put it on the stove.
4. Cool the cream immediately to 50° F., and never mix two lots unless both are cold and sweet.
5. Have a special bright and clean can for the cream, of a convenient size for the cream gatherer to handle by himself when necessary.
6. Have a special place to keep the cream in a pure atmosphere, and keep its surroundings clean, tidy, and free from dust. Trouble has been known to arise from keeping cream in the cellar, in the kitchen, near the barnyard, too near the roadside, and in the sun. Avoid these.
7. If the cooling water gets too warm in summer, put up some ice during the winter for such an emergency.
8. Cream cans are better covered with a clean, damp cloth, than with a tight cover. Cans must be bright and free from rust, and no old and dented can is suitable.
9. To Wash Cream Cans.—Rinse thoroughly with cold water. Scrub with a brush (never use a cloth), in hot water and washing soda, inside and out; then scald thoroughly, and allow to drain, the can lying on its side in a pure atmosphere, free from dust.
Never wipe cans with a cloth; if the scalding water is hot enough, they will dry themselves in less than a minute.
10. Wash all parts of the separator every time it is used. This is essential to produce good flavored cream, as well as to ensure thorough separation and good running of the separator,

If separator agents say otherwise, they neither know ours, yours or their own interests.

11. Have the skim-milk tested occasionally to make sure there is no loss of fat.

12. See that the cream gatherer performs his duties thoroughly.

13. If anything is wrong come straight to headquarters.

Prevention of Milk Fever.

Mr. Geo. Rice, the noted Holstein breeder, writes the "Farmer's Advocate" as follows:

I notice a statement in your Nov. 15th issue, page 832, under the head "Care of cows after calving," that may be interpreted wrong by many and do much harm. The article reads "Care should be taken to restrict the allowance of cold water for two or three days after the calf is dropped." Now, many will go and "restrict" the cow from water; and that is just what should not be done at this time. She should not have cold water—that is, not under 50 degrees—but it is the best of practice to give a cow all the water she will drink, moderately warm. The act of parturition causes thirst; it also causes constipation, and a liberal quantity of water, warm or moderately so, helps move the bowels.

I am continually getting letters asking what to do to prevent milk fever. Milk fever has no terrors for me now, because after three years' freedom I feel I have a treatment that is a pre-

warm, for that is nauseating, but with the chill taken off, but even this would have been considered heresy by some theorists a few years ago, who insisted that water should be almost entirely withheld for several days, as a safeguard against milk fever. Why not let nature have her way all through the crisis, and surely the swallowing of doses of drugs is not her way. Our observation teaches us that where nature has her way fully, there are few, if any, cases of so-called milk fever. Left at liberty, the cow will lick her calf dry when born, this process, doubtless, inducing a healthy circulation of blood in both herself and the calf, and the liquid taken in the licking process likely serving to loosen the cow's bowels, and, in perhaps 9 cases out of 10, she will turn and eat the afterbirth, probably to prevent constipation. Then the care of the calf and nursing it keeps her interested and contented. Left at liberty, the calf will take a little at a time of the colostrum or first milk, which has in itself the medicinal properties needed to relax its bowels. Supposing the cow had calved on the range and there was no one near to milk her for days, would she be likely to die of milk fever as the result of not being milked? If so, the ranching business would surely be very unprofitable. We never hear of milk fever under those conditions, though cases of spoiled udder do sometimes occur, owing to the calf neglecting a quarter. We know some dairy farmers who claim that it is good practice to take the calf away from its dam as soon as born, not letting her even see it or suckle it once, and we are strongly suspicious that those who practice this plan are,

as a rule, those who have the most cases of loss from "milk fever." In a long experience with cows of the beef breeds which were allowed to suckle their calves, and some of them heavy milkers and in good condition, the writer cannot recall a solitary case of milk fever, and there was no dosing with salts or other drugs. Nature just had her own way, and we have an idea that she knows a little better how it ought to be done than all the theorists. An English dairyman, keeping a herd of 100 cows, many of them heavy milkers in high condition, was quoted in this paper some time ago as stating that he has not had a case of milk fever in seven years, and he gave it as his opinion that the secret lay in allowing the calf to suck the cow for three or four days and never milking her out clean till after that time. This may be

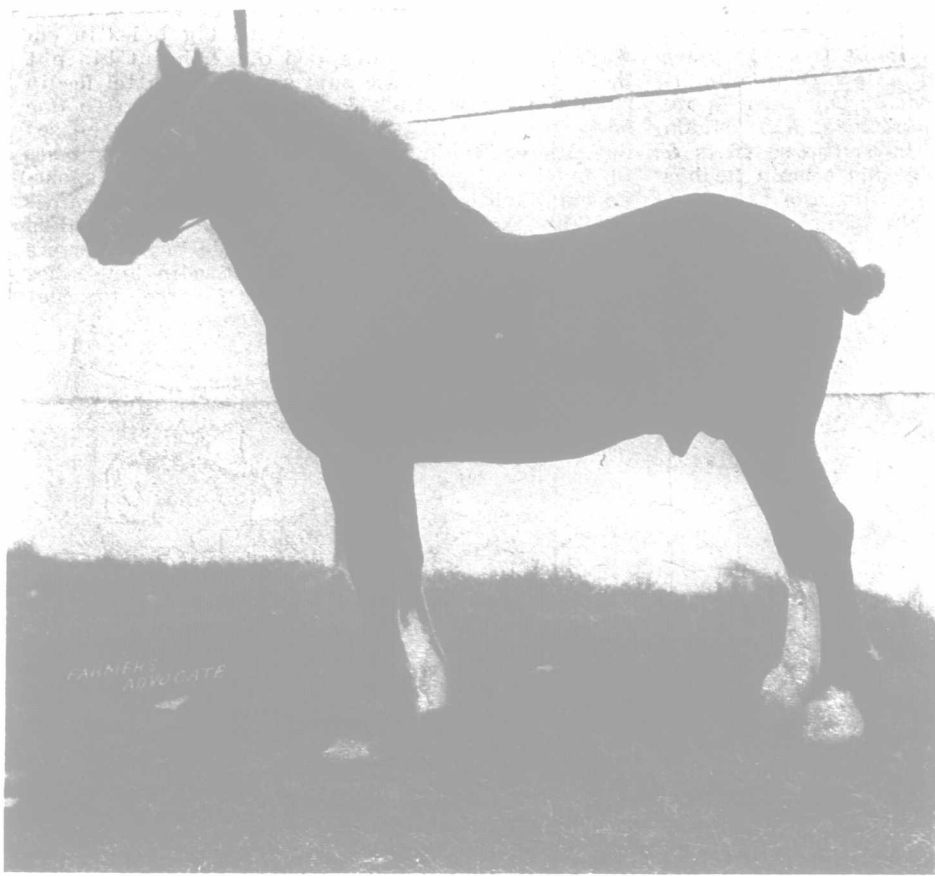
**PRIDE OF MORNING (10838), IMP.**

Clydesdale stallion, four years old, son of Baron's Pride (9122). In 1900 he was third at Castle Douglas and Edinburgh, and highly commended at the H. & A. S. show at Stirling, second at Kirkcubright, and was the Newton Stewart premium horse in 1901. In 1902 he was the Dunfermline premium horse, and second at the Western Fair, London.

IMPORTED AND OWNED BY O. SORBY, GUELPH, ONT.

ventive if followed in its entirety. This is my practice for all, as in the case of a cow that calved two days ago, which was very fat and flush, would weigh 1700 before calving; a case calling for heroic treatment. I gave her several doses of carbolic acid, twice daily for 3 days a week before calving, 25 drops pure carbolic in 1 pint of water and mixed on bran. When I saw she was near calving, I gave her 2 lbs. Epsom salts; she calved in 6 hours after getting the salts (just right). After calving she was very thirsty. I gave her 15 lbs. warm water; in 5 or 6 hours warm bran mash made very sloppy, to which I added a handful of common salt. I determined to run no chances, but made her drink all the water I wanted her to, and that is a lot. One hour after calving she got 20 lbs. or so more of water, in another hour 25 lbs. more, and an hour later another large pailful, the chill taken off it all. I had 100 to 125 lbs. water in her five or six hours after she calved, and, with other treatment, my mind was quite easy about her. As a matter of fact I went from home the next day, and felt perfectly sure she would be all right. There is virtue in plenty of water; nature craves it, the bowels need it and are kept moving when on a light diet.

[Editorial Note.—It does not seem to have occurred to our friend, Mr. Rice, that this cow might have come through the ordeal of calving without all the dosing she got, and that the drugs given her might all have been saved. We quite agree that it is well to give nature her way by supplying plenty of water, not cold, and not

only a notion, but it is nature's way all the same, and this man has had seven years' exemption with it. Mr. Rice has had three with his, he may have seven—in spite of the dosing—many a man has had as many without it. Without assuming to dogmatize in this matter, we confess that the longer we live the more we are inclined to accept newborn theories with a grain or two of salt. What are the scientists doing that they fail to give the world reliable light on this subject? Much credit is claimed for the Schmidt treatment for the cure of milk fever, and one veterinarian who claims to have been very successful with it, states that about the only cases in which it has failed in his hands have been those where the cow was dosed with salts before he was called, and yet that is the preventive that has been most persistently advocated, and in which the most faith is placed by dairymen generally. The subject is a live one, and is open for discussion, and any one who can throw a white light upon it will prove a public benefactor.]

Manipulation Milking.

Please explain what is meant by the manipulation method of milking? S. W. S.

Ans.—As we understand it, it means kneading or massaging the udder with the hands and stripping the last drop of milk that can be got from it, and, we believe, it is considered best to go over the cows the second time for this purpose. Experiments, it is claimed, have proved that this is a paying and profitable practice.

Calf Feeding.

The secret of success in hand-feeding of young calves lies in giving them for the first two or three weeks, little and often, of their mother's milk fresh and warm from the fountain. For the first three or four days it is best for the calf and its dam to let it help itself at will, or, at least, three times a day, of the colostrum or first milk which nature designs for moving its bowels and giving it a proper start in life. It is a mistake to be in a hurry to teach the calf to drink milk by the mouthful. The good old plan of giving it the fingers to suck while it is drinking is all right, and the longer this is continued, in reason, the better for the calf. It is nature's way to give the milk slowly to the calf, it having to work for it, and thus call into use the glands of the mouth, which secrete saliva to be mixed with the milk and to aid digestion. The next best thing to nature's way would be the use of a rubber nipple, through which the calf should take its milk, but care would be necessary to keep this scrupulously clean. Warm milk from the cow should be fed in small quantity three times a day, for the first two weeks at least, and if for a month all the better for the calf. After the second week, one-half the feed may be of warmed skim milk, and the feeding twice a day, gradually getting down to skim milk as the full feeding.

Calves will learn to eat whole oats or a mixture of ground oats and bran generally at three to four weeks old, and they can be early taught to eat by placing some of the feed in their mouths with the hand and by hanging a bundle of sweet hay in their stall, which they soon learn to pick at. Feeding cold milk is almost sure to cause indigestion and diarrhoea, which, if not checked, may become chronic, undermining the constitution of the calf and making it a scrub for life. In warming the milk, care should be observed that it is not boiled, as this will cause constipation, and it should not be fed hot, but lukewarm. When the calf has learned to feed, it may be grown satisfactorily, even if the supply of milk is short, by diluting it with warm water by degrees, and giving a fresh supply of bran and oat chop every day, and a little coarse ground oil-cake in the mixture will materially improve it. There is less danger of derangement of the stomach and bowels if these supplementary feeds are given in the dry state, since they are taken slowly, the process of chewing inducing the flow of saliva which is so essential to perfect digestion, but with care, and the exercise of good judgment, boiled flax-seed and meal porridge may be, and are, by some people, successfully used to supply the lack of fat in skim milk. There is no better substitute than flax-seed, and if boiled by a slow process and fed in moderation, say a half-pint to a pint of the jelly in warm milk, it is an excellent adjunct to the feeding, and serves a capital purpose in laying the foundation for a good constitution and a thrifty animal.

The vessel from which the calves drink should be cleaned daily by the use of hot water, and their pens kept clean and sweet and well bedded. If, from improper feeding or mismanagement, a calf contracts diarrhoea, the best remedy is a moderate dose of castor oil and a reduction of the supply of milk for a day or two, to be increased gradually when the trouble has subsided. A little lime water given in the milk will tend to correct acidity of the stomach and restore its healthy tone.

Dairying in Egypt.

Since the pacification of Egypt, a few years ago, that country has been making good progress along agricultural lines. With the influx of foreigners came new industries and the establishment of more modern methods and customs generally. Dairying, although yet in its infancy, is improving rapidly. For ages the Egyptians have taken a great interest in cattle, and it is said their dairy cows give a good quantity of milk. The climate, too, is favorable, and since irrigation was introduced, green pastures are to be had throughout the entire year. Cheese and butter factories are very scarce, but expert makers are sure to find good positions in a short time. In Upper Egypt the Greeks are erecting small butter factories and supplying a fair quality of butter, which ranges, retail, from 35 to 40 cents per pound. Cheese is also made, but not to any great extent. Every morning and evening in the city of Cairo, natives may be seen driving their cows along the streets, and milking fresh each time, according as a sale is made. This method should satisfy those who are continually in dread of adulterated milk.

When the reader considers what he receives in the "Farmer's Advocate" for the modest subscription price, it is the cheapest agricultural paper available for the Canadian farmer.

The Care of Cream.

Prof. Farrington, at the National Creamery Buttermakers' Association, Milwaukee, spoke of the larger use of hand separators, and said there was no insurmountable reason why butter from hand separator cream should not be as good as that from the cream skimmed in the factories. It was a matter of educating dairymen to take proper care of the milk on the farm and educating haulers to give it proper care when it is in their charge, and providing haulers with means to give cream the right care. He praised pasteurized cream butter as the standard for buttermaking. At some length he gave details of making pasteurized butter at the Madison station, and its comparison with sweet and raw cream butter, the points of good butter being in favor of the pasteurized.

GARDEN AND ORCHARD.

Winter Pruning.

In pruning trees, the general opinion now is that it makes but little difference at what season the operation is performed. The two principal factors to be considered are, the healing of the wounds and the time required in doing the work. Investigations at various experiment stations have shown that wounds made in winter, even when the trees are frozen, heal quite as well as those made in the spring or summer.

With the average farmer or fruit-grower, there is more spare time in winter than at any other season, and hence it is then the pruning should be done. There are many fine days from December to April, when a saw and clippers may be handled to good effect in many of the orchards in this country. If you do not understand how to do it yourself, employ someone whom you are sure does. The main thing is to have it done. If properly performed, it will, eventually, mean more and better fruit.



HARVESTING POTATOES' SPRING LAKE FARM, MICHIGAN.

Flowers in the Home.

That a home is not a home without a few flowering plants must be admitted by all who have any taste for the beautiful. True, there are those who have no use for anything that does not mean an accumulation of the mighty dollar, but they are fortunately in the great minority. In summer it is easy to have flowering plants in and around the ordinary farmhouse, but in winter it is often somewhat more difficult. Considerable space is sometimes required, and the temperature in which they are to be kept must, at least, be above freezing. All dwellings are not constructed to keep out frost in severe weather, so it becomes necessary to provide extra protection, especially for the night. Under these conditions, some use a box or case, nicely painted or papered, on which the plants may be kept in the daytime, and in which they may be placed when danger of severe frost is anticipated at night.

When the keeping of flowers in winter entails much labor, it is better to discard the less beautiful and useful plants and give all attention to a few. Better have some that will command attention and help to make the home cheerful and attractive than a number that would be no ornament anywhere. By all means have a few, and let them be good ones.

Apples for Home Use.

A few months ago, Prof. Reynolds, of the Ontario Agricultural College, published a bulletin showing the advantages of wrapping fruit in paper that was intended to be kept for a length of time. Few, perhaps, may have tried this method, but it is not yet too late. The winter fruit which has been placed in barrels or boxes, may be easily gone over now when the rush of farm work is not quite so great as it was at picking time. Try a few cases which you intend for your own use next spring. It will cost but little. Good newspaper will do about as well as anything. The time will be well spent.

Guard Against Mice.

Scarcely a winter passes but complaints are heard that ground mice have girdled or wounded large numbers of fruit and shade trees. The principal or only damage, appears to be done where the trunk has been encircled with long grass, weeds, strawy manure or other covering of a similar character, in which these little pests find a hiding place. If, therefore, materials of this kind be not allowed to accumulate at or near the point of danger, little loss will be suffered.

While protection to the roots of trees is always desirable, in winter nothing should be heaped against the trunk. Farmyard manure is often so placed, apparently with the idea that the only roots were situated within a foot or two of the stem. In these piles mice find a favorite resort for winter, and in mild weather they come forth to do their work of destruction. Where they are feared, under ordinary conditions, it is advisable to go through the trees after the first snowfall, tramping firmly around the base of each one, and thus making it impossible for them to reach the bark without coming on top, something they are not likely to do.

Spraying with Lime in Winter.

Although spraying fruit trees with lime in winter, as a means of protection against severe climatic changes, is as yet in its infancy, wherever tried it has proved beneficial, and its more general use is looked for in future. The common belief is that the principal damage suffered by the more tender varieties is not so much through severe frost in winter as frequent freezing and thawing in springtime. When the weather becomes bright and warm for several days during the last of March, the sap circulates and the buds swell. This is often followed by a period of cold weather in which the trees again become frozen, and thus suffer a severe check.

Where lime has been used, it has the effect of delaying the progress of bud development from four to five days, and in most cases this is sufficient to insure against danger. The value of the lime for this work lies principally in its color, as it is well known that light colors attract less heat than darker ones, and in this way the tree sprayed with any white material will not become so warm nor be so quickly affected by the sun.

There is in many quarters a mistaken idea that the budding and leafing of trees in spring is dependent upon the warming of the soil. To settle this point, Prof. Bailey, of Cornell, several years ago had a limb of a peach tree, which grew close to his office window, turned into the room. There, in mid-winter, it was subjected to a summer temperature, and, although in perfect connection with the stem and roots, which were frozen outside, it leafed out and blossomed.

The lime wash may be prepared at the rate of $\frac{1}{2}$ to 2 pecks to 40 gals. water; the thicker the better, but the more difficult to apply. It can be sprayed on fine days, from three to four applications being made between now and springtime. It will, at least, pay fruit-growers' to give lime a trial this year; the cost will be but little, and the benefits to be derived even in cleaning the trees and checking fungous diseases during the first days of growth will be helpful.

Apple Pomace as Manure.

"Of what value is apple pomace from cider-making as a fertilizer, and how would it do to spread on the orchard?"

Ans.—Apple pomace contains approximately one-third the amount of fertilizing constituents found in farmyard manure, and in about as available form. Because, by fermentation, acid is formed in the pomace from the sugar that is in it, it should not be applied to soils containing a large amount of humus, or on those which are naturally sour. For the same reasons, it should not be applied on any soil in large quantities.

I do not think it would give as good results on an orchard as out in an open field where there is more sunshine.

R. HARCOURT.
Ontario Agricultural College.

Pleased with the Watch.

I received the watch, and was very much pleased with it. I think it was well worth my trouble of getting the five subscribers. I will try to get more subscribers for you.
FLORA INGRAM.
Algoma, Ont.

POULTRY.

How to Feed for Winter Eggs.

To the Editor "Farmer's Advocate":

As the profitable season for egg production is at hand, the wide-awake poultryman will do well to use every available means for an increased egg yield. A few hints from my own experience may be of benefit to those interested:

Granted that clean and comfortable quarters have been provided for the laying stock, the greatest importance should be attached to the method of feeding, as it is here that most failures are found. The hens may apparently be in the best condition for laying, yet the egg-basket remains empty, and the owner wonders. To get at the root of this trouble, we must have some knowledge of the laws that govern the formation of an egg.

Scientists tell us it is composed principally of two elements, viz., nitrogenous matter and carbonaceous or starchy matter. If we fail to supply the hens with such food as is necessary to form these elements, we cannot expect to get eggs. It is essential that the rations be so balanced that they may be rich in those constituents of which the egg is composed. Most grains are rich in starch; for instance, corn contains eight times as much carbonaceous as nitrogenous matter. Barley, oats and wheat contain about six times as much. We do not have to go very far to prove by actual practice that the difference between these two elements in a grain diet is too great. This is what causes the cry we sometimes hear, that farm poultry do not pay.

It is plain that we must supplement the grain ration with other foods rich in nitrogenous matter. Any leguminous plant, as clover, which absorbs much of this material from the air, will help, although too much of it should be avoided. Mangels, turnips and cabbage will also add a little; and as they contain over 90 per cent. of water they will aid in keeping the fowls busy without danger of overfeeding. But the ideal food available, which has the greatest proportion of nitrogenous material, is animal food. If allowed their freedom during the warm seasons, they will provide this for themselves in the form of earthworms, insects, etc., but when the ground has become frozen it must be furnished for them, if we wish to get eggs when prices are high. In some localities it is difficult to obtain a supply. However, if there is a butcher-shop in the neighborhood, plenty of meat and bones may usually be had quite cheaply. Let me describe my method of preparation, which I think for ease, cheapness and good results has yet to be surpassed. I secure several beef heads, the carcasses of two or three calves, and anything else that may serve my purpose, and that is often found around a slaughter-house, cut them up into pieces, and boil in a caldron, bones and all; continue boiling until the whole has become soft and crumbled. Then pack solidly in an old salt barrel, and allow it to freeze. When it has frozen hard, knock out the bottom and roll into one corner of the hen-house. By this means the fowls will always have plenty of animal food, and besides they will have to work to get it.

I prefer to let the hens balance their own rations, as they will naturally do it much better than any one can possibly do it for them. Furnish the necessary materials and they will do the rest. I always feed grains in a litter 10 or 12 inches deep, as this insures plenty of exercise. The mash should not be fed during the forenoon, as some will get too much and spend the rest of the day on the roost. As the eggs are generally laid during the early part of the day, it is best to feed the mash at three or four o'clock in the afternoon.

In regard to the quantity of feed required, much depends upon the judgment of the person in charge; remembering that for best results the fowls should not be kept too fat or too lean. Only a hungry hen is a good layer. When not on the nest they should be scratching for food. Do not forget to furnish some grit with the food. In preparing the pen for winter, I draw a wagon-box load of gravel, not too coarse, and spread over the floor. The hens will easily find it when scratching among the litter. Lime in some form is also a necessary article in a poultry outfit, as it is required in the formation of shells. As it is generally difficult to keep a supply of bone for this purpose, I prefer crushed oyster shells, which, I believe, are cheaper and more effective. Lastly, but by no means the least important, is clean, fresh water. See that the fowls have plenty of it, and that it is warmed sufficiently to take off the chill.

J. HUGH MCKENNEY.

Elgin Co., Ont.

In sending a change of advertisement, Mr. F. M. Gardhouse, breeder of Shorthorns, Clydes, Shires and Leicester sheep, wishes to state that he has changed his post office from Highfield to Weston, Ont.

APIARY.

The Beekeeper in Winter.

After the honey is sold, and the bees ready for winter, there naturally comes a little lull, and we have a chance to draw a long breath; but the winter months are not to be idle ones, so far as the bees' interests are concerned. This is our chance to get ready for next year.

It is well to begin by taking an inventory of what we are likely to need—how many new hives, frames, bottom-boards, covers, sections, etc. In making an estimate, perhaps it is well to err on the side of having too much rather than too little.

In the very busy season we have no time for this kind of work, at least we don't want to take any time for it; we want this work out of the way while we have the leisure for it.

I know it is often said that a woman can not drive a nail, but bee-women know better than that, for many of them do their own carpenter work without any assistance, and do it well, too.

Besides making new, there is always some repairing of the stock on hand to be done. Now is the time to do it. There is boiled-down comfort in having everything ready for use.

Cleaning T Tins.—Do you use the T super? If so, have you your T tins all cleaned ready for next year? Don't forget that they can be cleaned with concentrated lye so that they will look almost as good as new.

Overhaul the Smoker.—Give your smoker a good overhauling, and put it away in good shape for work when needed.

Late Feeding of Bees.—Are you sure that your bees have plenty of stores for the winter, and



WOODMAN'S POINT, ON ST. JOHN RIVER, KING'S CO., N. B.

that you have done everything you possibly can to insure their comfort and safety during their long nap? If you are so unfortunate as to have to feed your bees at this late hour, don't try to feed syrup, it is too late for that. If you do not have frames of honey to give them, then feed them candy.

Reading Bee Literature in Winter.—How much of your time are you going to give to bee literature this winter? Have you made any plans as to what you are going to read? Remember, if you are going to be a tiptop beekeeper you must put your best effort into it. Get all the knowledge in regard to bees that you possibly can, and be ready to put it into practice when the right time comes.

"Faithfulness" the Keynote.—Don't get discouraged because you can't learn all about bees in a day. Possess your soul in patience, and keep pegging away. There is an old proverb that says, "Keeping everlastingly at it is sure to bring success." Be that as it may, be sure that faithfulness is the keynote to success in every department of work.

Saving Bits of Wax, Comb, etc.—Now is a good time to get all the bits of wax and pieces of old comb, etc., together, and extract the wax from them. That is, unless you have been so energetic that you have it done already. If you have carefully saved all stray bits it may be a surprise to you to see the nice cake of golden wax you will have the result of your labor.—[American Bee Journal.]

Date of Convention Changed.

The date of the annual beekeepers' convention, to be held in Barrie, has been changed from Dec. 2nd, 3rd and 4th, as announced in our last issue, to Tuesday, Wednesday and Thursday, the 16th, 17th and 18th of the same month.

QUESTIONS AND ANSWERS.

1st.—Questions asked by bona-fide subscribers to the "Farmer's Advocate" are answered in this department free.

2nd.—Our purpose is to give help in real difficulties; therefore, we reserve the right to discard enquiries not of general interest, or which appear to be asked out of mere curiosity.

3rd.—Questions should be clearly stated and plainly written, on one side of the paper only, and must be accompanied by the full name and address of the writer, as a guarantee of good faith, though the name is not necessarily for publication.

4th.—In veterinary questions, the symptoms especially must be fully and clearly stated, otherwise satisfactory replies cannot be given.

Veterinary.

SYMPTOMS OF ANTHRAX

Please publish in the next issue of your paper the symptoms of anthrax, and any other information concerning the disease which would be of use to an enquiring reader. SUBSCRIBER.

Perth Co.

Ans.—If you have been saving the back numbers of the "Advocate" you will find in Aug. 1st issue, of 1901, page 507, a pretty thorough description of this disease. In case you have not recourse to that information, we would say the immediate cause of the disease is the entrance into the body of healthy animals of rod-shaped bacilli or their spores either in food, water, or by inoculation through an abraded surface or open wound. The usual symptoms are trembling body, humped back, labored breathing, with an exudation of water and occasionally blood from the mouth and eyes. Death generally results in a few hours. It is extremely contagious, and cases of recovery are very rare. Send to the Department of Agriculture, Ottawa, for copy of Farmers' Bulletin No. 5, dealing with this disease.

INFLUENZA.

Mare took suddenly ill, with chill, stiffness and swelling of front legs; temperature rose to 106 degrees. Her colt had been taken from her three days previously, but she had been milked regularly.

J. S.

Durham Co., Ont.

Ans.—The symptoms given are meagre, but indicate influenza. Treatment consists in making comfortable, clothing well, and excluding drafts. A little of the following liniment should be applied to the throat twice daily for 2 or 3 days: 2 parts each of raw linseed oil and oil of turpentine, and 1 part liquor ammonia fortier; 2-dr. doses of chlorate of potash should be given 3 times daily, by placing on the root of the tongue. It is dangerous to drench, as the throat is so sore that swallowing is difficult. Soft food should be given. This treatment will usually be successful, but the disease is liable to various complications, and when complications arise the services of a veterinarian should be procured at once.

J. H. REED, V.S.

RINGBONE.

There is a lump on the hind pastern of my 4-year-old mare. She went lame when first taken out of the stable. The lump extends from hoof nearly to fetlock, and is not a complete ring. Her mother has one about the same. I treated it for ringbone and cured the lameness, but the lump remained.

B. L. N.

Algoma, Ont.

Ans.—Your filly has ringbone; the tendency was inherited from the dam. Ringbones sometimes appear only on one or both sides. As you have succeeded in curing the lameness, you have done all that can be done, as the lump cannot be removed.

J. H. REED, V.S.

PARAPLEGIA IN COW.

My cow became stiff about 7 weeks ago. The stiffness has gradually increased until she has nearly lost power of her back and hind legs. She eats well, but is getting thin. J. M. Wentworth Co., Ont.

Ans.—She is partially paralyzed. Purge her with 1½ lbs. Epsom salts and 1 oz. ginger. Give her a roomy box-stall and keep her in. After the physic has acted, give 2 drs. nux vomica three times daily, either as a drench, mixed with ½ pt. water, or in her food if she will eat it. J. H. REED, V.S.

HEMATURIA.

My mare passes blood in her urine. Is it the same as red water in cattle? Her appetite is good, and she is doing fairly well. G. M. S. British Columbia.

Ans.—In red water in cattle, the urine, while red, does not contain blood, hence the trouble with your mare, whose urine contains blood, is not the same. Your mare has hematuria or bloody urine. Give her 2 ozs. tincture of iron in 1 pt. cold water, night and morning, until the urine becomes clear. J. H. REED, V.S.

SICK HEIFER.

About two months ago I found a yearling heifer sick in the rape field. Her throat was swollen. I had it blistered and it apparently got all right, but she is no better. I am told that she has ulcers in the womb and will not get better. What is the cause and cure? J.H.B. Wellington Co., Ont.

Ans.—As you give no symptoms except a swelling in the throat, which you say disappeared, it is not possible for me to give a valuable opinion. In order to be able to diagnose and prescribe, we must either have the patient before us or be given details of symptoms. All I can suggest is the administration of tonics, say 1 dr. each, sulphate of iron, gentian, ginger and bicarbonate of soda, night and morning. This will simply improve her appetite and condition. If she is affected with any specific disease it will require specific treatment. J. H. REED, V.S.

SICK DOG.

A valuable pure-bred dog appears stupid most of time, gets stiff in his front legs and staggers, turns his nose up, has an anxious look in his eyes, keeps licking out his tongue and will tremble for probably ten minutes and then seem all right again. He has two or three spells a day some days. His coat is quite rough looking, and he breathes with a sort of a whine. M. W. T. Norfolk Co., Ont.

Ans.—Your dog has chorea, a nervous disease that often results as a sequel to distemper, and sometimes occurs without apparent cause. The disease is purely nervous and very hard to treat, especially in pet dogs that are inclined to be phlegmonous and become very fat. Give him a purgative of 20 grs. jalap and 2 grs. colomel; follow up with 10-gr. doses of potassium bromide twice daily. Feed lightly; allow no meat, and give him plenty of exercise.

GROWTH IN COW'S EYE.

Have a cow with a soft growth between the eyeball and the lid. It is growing steadily and causes the escape of tears and some pus. Perth Co., Ont. D. McM.

Ans.—The growth must be removed by an operation, and if the eyeball is involved the whole organ must be removed in order to save the other eye. This is an operation that can be successfully performed only by an expert. J. H. REED, V. S.

INVERSION OF WOMB IN EWES—HEAVES IN MARE, ALSO SPLINT.

1. Last winter I lost several sheep by casting their withers.
2. Have a mare with thick wind, can scarcely be called heaves. She also has a splint on the outside of leg and goes lame. C. Y. K. Elgin Co., Ont.

Ans.—1. I am not sure what you mean by a sheep casting her withers, unless it be inversion of the uterus after lambing. In this case the organ must be carefully washed with a 5-per-cent. solution of carbolic acid in warm water, carefully returned and retained by stitching the vulva and applying a truss, which must be kept on until all straining ceases. You cannot prevent the accident.
2. See answer to J. S. M. for heaves. It is not probable the splint is causing lameness, but if so, repeated blistering will remove it. You had better have her examined for other causes of lameness.

RIDGELING.

Can anything be done for a colt that has but one testicle down in the scrotum? E. J. M. Huntingdon Co., Que.

Ans.—The colt can be castrated by a ridgeling castrator. Nothing can be done to cause the descent of the testicle, but in many cases it will descend by the time the colt reaches one or two years.

HEAVES.

A 10-year-old mare has had a cough for three years, and is getting worse. She coughs more when she commences to eat in the morning. Would it be advisable to breed her? Wellington Co., Ont. J. S. M.

Ans.—Your mare has heaves. It cannot be cured. The symptoms can be somewhat allayed by feeding limited quantities of bulky food. Good clean wheat straw is better than hay. If hay be fed it should be of the very best quality. All food consumed should be dampened with lime water. Feed a little more grain and less bulky food than usual. If she is sound in other respects, and a mare likely to breed well, there appears no objection to breeding her. J. H. REED, V.S.

Miscellaneous.

EMPLOYMENT ON RAILWAY.

To whom would I have to apply to get on as an express brakeman on the G.T.R. or the C.P.R.? What wages do express brakemen get on these railways, and are they obliged to perform any other duties? W. E. F. Huron Co.

You might write to W. E. Castella, Trainmaster G.T.R., Toronto, but before any person can become an express brakeman he must first serve for years as brakeman on a freight train, beginning first in the yards, then on way-freights; later on, on through-freights, and then for some time on mixed trains. Only the best and most reliable men are promoted to that position.

The wages run from \$35 per month upward, based on a day of ten hours. As a rule they have no other duties to perform.

PROBLEMS IN DRAINAGE.

1. In putting in tile, is it necessary to have the ends of the tile covered by a collar, as is laid down in the English works on drainage? Collars do not appear to be made here, and what do you recommend to be used in their stead?

2. Do you recommend large tile, say 9 inches, where there is a constant flow of water in a creek, the object being to make the field workable without the inconvenience of an open drain, and if you recommend this, what system do you recommend in order to admit this small creek at the line where it comes from your neighbor's property?

3. Should tile be so made as to admit water through the tile as well as through the joints, and do you recommend the use of tile less porous than this, say made of white clay, and although not glazed, still practically non-porous to water except at the joints. R. C. CLUTE. York Co.

1. Collars for covering the joints of tile are not used in this country, nor are they necessary. Where the earth that is to be placed around the tile is extremely loose in character, such as quicksand, and likely to gain an entrance through the crevices, it is only necessary to first put down a layer of old sod or pea-straw, before filling in, but when the tile have been carefully laid, and the soil is possessed of an ordinary degree of consistency, no such covering need be used.

2. While the size of the tile depends altogether upon the amount of water to be carried, they should not be of greater capacity than would be required when the flow is at its highest. Large tile conveying only a small stream, are more apt to become clogged than those suited in size to the stream. At the point of entrance, the chief difficulty would be to guard against rubbish of any



ST. PATRICK'S CHURCH, SCHOOL AND GLEBE-HOUSE, LOCHABER, ANTIGONISHE CO., N. S.

DORSETS AND DOGS.

Please inform me whether Horned Dorset sheep are proof against dogs, or is it necessary to have a ram with them for protection? Would they be a good sheep for Essex county? How would they cross with a ram of another breed? Any information would be accepted with thanks. Essex Co., Ont. SUBSCRIBER.

Ans.—Breeders of Horned Dorsets claim for their favorites that they will defend themselves against the attacks of dogs. We do not know, from experience or observation, whether this is correct or not. Doubtless the ram would be more likely to put up a fight against dogs, and would probably give the ewe flock courage to fight also. Dorsets will, we believe, flourish in any part of Ontario. We have seen very little of the result of crossing Dorset rams on other breeds, and cannot speak as to its advantages or otherwise, but as Dorset ewes will breed at almost any season, we should judge that by using rams of any of the principal mutton breeds on the Dorset ewe, early lambs and early maturing stock could be counted upon, which, considering the high prices paid for extra early lambs, should make it a good paying business.

WAGES CLAIMS.

According to law, does wages come before taxes and rent? W. C. H. Simcoe Co., Ont.

Ans.—No. CONCRETE FOR CELLAR WALL.

Would you recommend concrete for a cellar wall, and would a twelve-inch wall be strong enough to carry a solid brick house? Stormont Co. D. S. McMILLAN.

Ans.—There is nothing better for a cellar wall than concrete. If properly constructed, ten inches should be thick enough even for a solid brick house.

kind entering the pipe. This might be accomplished by having an iron sieve with meshes about ¼ inch in diameter, but it would require constant attention lest it might become altogether clogged.

3. It is not intended that tile should admit water in any quantity, except through the joints. It makes but little difference whether they are glazed or not.

DAMAGES FOR LOSS OF LAMBS.

1. A owned four ewe lambs which could be registered. He put them to pasture on B's farm. A few days after they got out on road. C's boy came along with a lot of lambs. He tried to separate, but could not, the four being so tame they would follow. When he came to station, C's boy told C that there were four ewe lambs in flock not their own. C made no attempt to get lambs out, as can be shown by witness, but said, "Let them go." C had two hours to spare before shipping. A found out where his lambs had gone. Went to C. C at first said he did not know how many there were, and seemed quite indifferent. A pressed the matter, saying he was well informed of the lambs' whereabouts. Then C admitted he had shipped four lambs, and offered to pay 3½c. per lb. Should C pay shipper's price or breeder's price?

2. Could there be any action taken against C?
3. Is B any way responsible for lambs getting on road? SUBSCRIBER.

Huron County.
Ans.—1 and 2. C would be liable to A in damages based on the value of the lambs, considered as pure-bred, and an action would lie for the recovery of such damages. 3. B would only be responsible if it was owing to negligence on his part that the lambs got away, and it does not appear from the statement of case that there was such negligence.

FEEDING WHEAT TO STOCK.

1. Can you inform me how to obtain the best result from feeding wheat to small pigs, colts and calves, or even to grown stock, such as horses?

2. Can the same results be obtained from feeding whole wheat as from feeding bran, and what proportion is equivalent to bran? C. F. K. Elgin Co.

Ans.—1. To obtain the best results in feeding wheat to growing stock, such as young pigs, colts or calves, it should be mixed with some other concentrate of lighter weight, easier to digest. For pigs under three months of age, an equal quantity of ground oats, with the hulls removed, by sifting, will give good results, and for calves, the same might be given without the hulls being removed. In feeding colts, it is unwise to allow wheat to enter to any extent into the bill of fare. It is too likely to impair the digestive organs, and since ground oats are known to be so satisfactory, no risk should be run with wheat.

2. At the North Dakota Experiment Station, whole wheat was fed to work horses for some time, and although they gained in weight, it was with the greatest difficulty that indigestion was averted. This has been the experience of most practical men who have tried it.

Since wheat and bran differ considerably in composition, and also in their action upon the animal body when consumed, no real comparison as to their value can be made. For example, if either were to be fed alone, which, of course, would not be judicious, wheat would give the best returns with fattening stock, while for growing animals, in most cases bran would be preferable.

REGISTRATION OF STOCK.

Kindly give particulars as to registration of pure-bred stock, especially sheep. In buying stock at an auction sale, are there any papers the buyer is entitled to? N. R. J. Waterloo Co., Ont.

Ans.—In all cases of the auction sale of stock represented to be registered, the buyer is entitled to a certificate of registration, duly signed by the Secretary of the Association under whose authority the herdbook or record is kept. Most of the pedigree records for sheep in America are kept in the United States, but in nearly all such cases Canadian breeders are represented by one or more members on the executive board of the breed association controlling the registry. Full particulars and rules in printed form may be had by applying to the secretary of such association. In the case of the sale of stock, either by auction or private treaty, represented to be "eligible to registry," the seller must give to the buyer all necessary information and sign all necessary papers to enable him to have the animal registered in the record to which it has been represented to be eligible. In that case we are not aware that there is any established rule as to who shall bear the expense of registration, unless a promise to do so has been given by the seller. It is well always in a bargain to have a fair understanding on this point, and better to have a written agreement.

WORMSEED MUSTARD—CHICKWEED.

Please let me know the name and character of two weeds, which I enclose? The one with yellow flower does not give trouble until after the crop is harvested, but the other, with the fine stems and the small leaves, is apparently spreading. JNO. S. M. Wellington Co., Ont.

Ans.—The specimen with yellow flowers about a quarter inch in diameter is wormseed mustard (*Erysimum cheiranthoides*). This plant is an annual, growing up and producing seed in a single season. The chief source of distribution is through clover seed. Although it should always be avoided, it is not so difficult as some others to eradicate. Where it occurs in small quantity, hand-pulling and burning is the best remedy; otherwise good surface cultivation after harvest should be practiced, and the following season the land occupied by a hoed crop and no plants allowed to seed.

The specimen which you state is spreading, is mouse-ear chickweed (*Cerastium vulgatum*), also an annual, but more difficult to eradicate than the former. The plants mature early in the season, and produce an enormous amount of seed. The only remedy is constant surface cultivation, to germinate the seed and prevent any specimens maturing. Follow method of eradication as outlined in Oct. 15th edition for ox-eye daisy.

COUGH IN PIGS.

Can you give me any advice what to give pigs for a dry cough? They have been fed shorts. A. M. F.

Ans.—Cough in pigs may be due to different causes, and some cases are quite contagious. One of the early symptoms of hog cholera is a dry cough, so it is well to be on the alert for this disease, especially since it is known to be in the country. For a cough caused by indigestion, the remedy is soft feed, accompanied by a brisk purgative, as Epsom salts, from 4 to 6 ozs. If due merely to a cold, use pine-tar freely in the troughs, and supply soft feed and good shelter until cured.

WOOLLY BEAR CATERPILLAR—KEEPING CEMENT OVER WINTER.

1. I am sending you a caterpillar, about an inch long, black at both ends and with a light brown band across the center of the body. Please state whether it is destructive or not?

2. What is the best way to keep cement over winter without it being injured? Russell Co. J. FERGUSON.

Ans.—1. The specimen received is the larva of woolly bear (*Spilosoma Isabella*). In this state the insect passes the winter, hiding in any secluded spot, from which it emerges in early spring, and soon after becomes a pupa. In June the adult state is reached, and a brownish yellow moth may be seen flying at night. While it feeds on almost any form of vegetable life, the damage done is generally so little that it is not regarded as a troublesome pest.

2. There is no difficulty in keeping cement over winter, provided it be stored in a dry place, and not allowed to come in contact with the earth in any way. Sheds without a floor, but affording protection from rain and snow, will do very well, by laying a few boards under the barrels or sacks.

WHITE HAIR ON SHOULDER.

I have a colt, bay in color, but the hair on his shoulder has become white through hard work. Is there any way of restoring the original color? Peel Co. T. G. C.

Ans.—No method has yet been discovered, according to our knowledge, whereby hair so colored may be restored to its original shade. When the hair-roots have been disturbed by wounds on any part of a horse's body, and it is feared that white hair may grow in, some claim that it may be prevented by the application of an ointment, made of burnt leather and lard, if applied just as the wound has become nicely healed and before the hair has begun to appear.

COLORING COLT'S HAIR.

We have a valuable yearling light-chestnut carriage colt, having a silver mane and tail and a white face. Can I get a dye that will color the mane, tail and face, and not be injurious to the hair? Wellington Co. SUBSCRIBER.

Ans.—The color of animals' hair is regulated by the pigment which is contained in minute cells in the epidermal layer of the skin, and hence any dye which might be used can only have a temporary effect and would require to be continually applied. The ordinary dyes of commerce, we judge, could be used without danger, but dyeing hair on living animals is neither profitable nor judicious.

KEEPING CIDER SWEET.

Please publish in your next issue a recipe to keep cider sweet. A. B. M. Oxford County, Ont.

Ans.—Cider may be kept sweet by raising its temperature to 170 degrees F., keeping it at this point for ten minutes, and then bottling quickly in sterilized bottles. A good air-tight covering may be made by using paraffin wax.

AN OCCUPATION RENT.

We own hay sheds. In Dec., 1901, received contract of supplying hay to Montreal firm. They placed press and engine in buildings in February, and paid rent to May 1st, 1902, being charged with 3 months rent. Press run in June and hay was stored in till October. Engine and press still in buildings, also celled hay. Contract was to be completed by May, but they could not receive it all at that time, and accepted hay in June. Have no writings on rent, but they paid as per verbal agreement to May 1st, 1902. Have not notified them to move press. Can we collect rent since May 1st, 1902, in 3-months terms, at rate charged for 3 months ending May 1st, 1902? ONTARIO.

Ans.—You are entitled to charge the parties as for use and occupation of the premises for the overtime during which same may be actually in occupation by them, and at a rate proportionate to that agreed upon in respect of the three-months term.

REGISTRATION OF CLYDESDALE.

1. How many crosses does a Clydesdale mare require to register?
2. When was the standard set last?
3. What does it cost to register a mare?

Ans.—1. In the rules governing entries in the Canadian Clydesdale Studbook, as printed in the front of each of the eleven volumes issued, we read Clydesdale stallions and mares will be admitted to registry as follows: (1) Clydesdale stallions or mares by sire and out of dam both recorded in the Clydesdale Studbook of Canada. (2) Clydesdale stallions having five top crosses with their dams on record, and Clydesdale mares having four top crosses, in each case by sires recorded in the Clydesdale Studbook of Canada.

2. Vol. 1 was published in 1886, and there has been no change in the standard since.

3. To members \$1, to non-members \$2. Membership fee is \$2 annually.

SILO CONSTRUCTION AND FILLING.

A friend of mine, when I was in Virginia the last few weeks, requested me to obtain information of how to build a "silo"; that is, dimensions and capacity, when to fill, how to fill, and how long to be filled before corn put therein can be used for feeding purposes, and such other information as would enable him to operate successfully. It occurs to me that you would likely have on file a few issues of your paper containing fullest instructions on this subject.

Wentworth Co., Ont.

G. T. TUCKETT.

Ans.—The information desired will be found in the "Farmer's Advocate" for July 15th, 1901; April 15th, May 15th and Sept. 1st, 1902.

A FARMERS' FIRM—LEASE WITH OPTION TO PURCHASE.

1. Can two men buy a farm and work it together as partners, without being liable to a fine? 2. Suppose one wants to sell out, what can he do if the other will do nothing? 3. Two men rent a farm for a term of years, with a clause in lease giving them the privilege of purchase any time during said lease, at a stated sum. Will such a privilege stand law? 4. If so, is it any good to one man who wishes to buy, should the other refuse to buy with him, they having no registered partnership? Wellington Co., Ont. SUBSCRIBER.

Ans.—1. Yes. 2. He can dispose of his interest in the firm assets, including the farm. 3. Yes. 4. Yes.

FARM GOSSIP.

Every reader is invited to write something for this department that other farmers ought to know. Do it while you think of it. Put it on a post card if you haven't time to put it in a letter.

A Scottish Editor's Visit.

On November 12th, Mr. Arch. McNeillage, editor of the Scottish Farmer and Secretary of the Clydesdale Society of Great Britain, sailed from Liverpool for Canada, where he will deliver a course of lectures during the Winter Fair weeks at Guelph, Ont., and Amherst, N. S., chiefly in relation to dairying and horse breeding, and will also likely visit the Chicago International Show. In this connection, it will be of interest to mention that one of the features of the forthcoming Christmas number of the "Farmer's Advocate" will be a thoughtful article from the vigorous pen of Mr. McNeillage on "The Attitude of the British Farmer Towards Canada." His views on this subject are deserving of serious consideration.

The Macdonald Benefaction.

The contract for the Macdonald Institute, at the Agricultural College, Guelph, has been let to Schultz Bros., of Brantford, and they are now at work on the foundation of that building. The contract for the Macdonald Hall, or a residence for women, has not yet been let, but will be as soon as possible. Both buildings are to be finished by the middle of August next, with a view to opening the new department by the middle of September.

President Mills, of the College, announces that Sir William Macdonald, of Montreal, has, owing to the largely increased cost of building material, consented to add \$25,000 to his gift of \$125,000 made some time ago for the erection of the two buildings at the College for purposes of instruction in manual training and domestic science.

Forestry Association Report.

The report of the third annual meeting of the Canadian Forestry Association, held at Ottawa, in March last, has recently been issued. It contains a host of information valuable to farmers in all parts of the Dominion, and should be read with interest. The subject of forestry is rapidly becoming more prominent, and there is little doubt but that the Canadian Association is doing a good work in drawing public attention to the rapid denudation of our forest lands and the possibilities of reclaiming areas that are now barren and the benefits to be had therefrom. Copies of the report may be had by addressing, Secretary, Forestry Association, Department of Interior, Ottawa.

Peat Fuel.

The coal strike and high-priced fuel has caused a stir in Canadian peat manufacturing circles. In a recent trip, Mr. W. E. H. Carter, Secretary of the Bureau of Mines, found a new plant in course of erection at Newington, in Eastern Ontario, where a German process will be tested. The bogs at Brockville and Perth were also inspected. Mr. Carter says the deposits at each of these three places are upwards of 1,000 acres in extent, and run from 10 to 25 feet deep on an average. The success of the plant at Beaverton has been a stimulus to the other companies experimenting in Ontario.

Western Cattle for Ontario Feeders.

It has been announced that an experiment will be conducted in Ontario this winter to determine the possibility of finishing Western steers at a profit before being shipped to the British market. Twenty-four grades from the Northwest Territories have been purchased for the purpose, and will be exhibited at the Guelph Fat Stock Show, after which they will go into suitable fattening quarters somewhere in the Province.

Notes from Ottawa.

FOR THE JAPANESE SHOW.

Mr. Wm. Hutchison, Dominion Exhibition Commissioner, has about completed the collection for the Japan Exhibition, to be held at Osaka next year. These will constitute over six carloads, representing everything produced or manufactured in Canada. It will be one of the finest exhibits that Canada has ever sent out. Mr. Hutchison will leave for Japan about the first of the new year, and will take with him a complete baking outfit for the purpose of demonstrating how Canadian flour can be made into first-class bread. Mr. W. Jamieson, an expert Ottawa baker, will have charge of this part of the exhibition, and will show that Canadian flour makes equally as good and better bread in some grades than the American product, which at present has the preference on the Japanese market.

THE GAIN FROM COLD-CURING CHEESE.

At the second annual closing banquet of the Ottawa Cheese Board, the annual report showed that during the season 32,594 boxes of cheese had been registered on the board, showing an increase for this season of 220 boxes. The highest price paid was 11½ cents and the lowest 9¼ cents, or an average of 10¼ cents per pound. Providing each box of cheese weighed on an average 80 pounds, and figuring the total pounds at the average price, this would net the farmers of the Ottawa Valley and district \$265,793.40.

Responding to the toast, "Our Dairy Industry," Prof. J. A. Ruddick, Chief of the Dairy Division, Department of Agriculture, said last year he spoke of the deterioration in the quality of the cheese, but was glad to say that there are very few complaints this season; in fact, less than in any previous year. The exports from Canadian ports show an increase over last year, but a decrease from American ports. A few years ago New Zealand sent large quantities of cheese to England, but the situation is changing rapidly. Owing to the bad weather in that country during the season just closed, the New Zealanders have been manufacturing butter instead of cheese, and in the very near future the exports from that country will be almost nil. Regarding the curing rooms established last spring by the Department of Agriculture, he said: "During the season 26,000 boxes of cheese were stored at the four different points for the purpose of carrying on an experiment, and we have ascertained that there is a great saving in the shrinkage by having cheese stored in good curing rooms. On the 26,000 boxes stored in the model curing-rooms 31,403 pounds of cheese were saved, netting the farmers \$3,139.09 of a direct gain. And we must take into consideration that the weather was not very warm during the summer months, consequently the shrinkage was not as great as it would have been had it been warmer. Cheese wants to be cured at a temperature of from 55 to 60 degrees to ensure best quality. The texture of the cheese is injured providing the temperature is above 60 degrees." In closing, Prof. Ruddick stated that he intended to have a bulletin prepared in the course of a few weeks, dealing with model curing-rooms, and that they will be distributed to factory owners.

Mr. D. Derbyshire, President of the Eastern Ontario Dairymen's Association, alluded to the annual meeting of the Dairymen's Association to be held in Ottawa in January, which would be the greatest dairy convention ever held on the continent.

"Our Greatest Industry" was responded to by Prof. J. H. Grisdale, Agriculturist, Central Experimental Farm, in a practical address. He said the products of Canada this year will yield the farmers close to a billion dollars. We are not only producers, but we are receiving a fair remuneration for our products. We have made great progress and have a great future before us.

A SEED FAIR.

Mr. G. H. Clark, Chief of the Seed Division, Department of Agriculture, is making arrangements to hold a seed fair in Ottawa during the latter part of next March. The exhibition will be in progress for two days, and will probably be held in Byward Market Hall. Prizes will be offered for farmers exhibiting seed grain. Prizes will be offered for farmers exhibiting seed grain of the best standard quality in bulk lots of twelve bushels each, and addresses will be delivered by prominent agriculturists, who will point out the good qualities and defects of the seed.

THE OTTAWA FAT STOCK FAIR.

Mr. A. P. Westervelt, Toronto, Secretary of the Dominion Live-stock Association, visited Ottawa, Thursday, regarding accommodation for the big fat stock show to be held in February. He secured buildings from the Ottawa Forwarding Co., and as the City Council has granted \$1,200 and the local counties \$450, the show is now a sure thing.

APPLE SHIPPERS TO BE PROSECUTED.

Mr. A. McNeill, Acting Chief of the Fruit Division, and Mr. P. J. Carey, Dominion Fruit Inspector, Montreal, examined several lots of apples which had been consigned to the Ottawa Fruit Exchange, Friday afternoon. They found in one case that a consignment from Quebec Province had been both falsely packed and falsely marked. The lot consisted of sixty barrels of Fameuse. The barrels were all marked XXXX, which, under the Fruit Marks Act, indicates No. 1 quality. The apples were very inferior in quality, small and scabby. Some of the barrels were "faced" with good apples, but after a few had been removed from the top showed poor quality. These barrels were falsely marked. Mr. McNeill stated that barrels shipped under

this mark should contain apples of good size, free from worm-holes, scabs and other defects. He further stated that he could not prosecute a shipper unless the barrel contained more than fifteen per cent. of inferior apples, pointing out that the law was very lenient towards packers. Another lot of Baldwins, shipped by an Ontario man, and marked XXX, were found to be very inferior. Both shippers will be prosecuted at an early date.

Where Britain Buys Horses.

During the first nine months of the present year, England bought from Canada 1,685 horses, from the United States 6,142, and from other countries 20,260. This was an increase for Canada over the same period of last year of over 600; a decrease for the United States of 11,097, and an increase for other countries of 3,968.

Experimental Union.

The annual meeting of the Ontario Experimental Union will be held in the new Massey Hall, Ontario Agricultural College, during the first two days of the Winter Fair, Monday and Tuesday, December 8th and 9th. The principal speakers will be Dr. B. E. Fernow, Director of the College of Forestry, Ithaca, N. Y.; Dr. Jas. Fletcher, Dominion Entomologist, and Prof. Robertson, Ottawa; and Hon. John Dryden, Toronto.

Device for Colter.

In your last issue I notice J. J. Aitkin wants a device for keeping stubble off the plow colter, so I will give an idea of what I use. From an old Massey

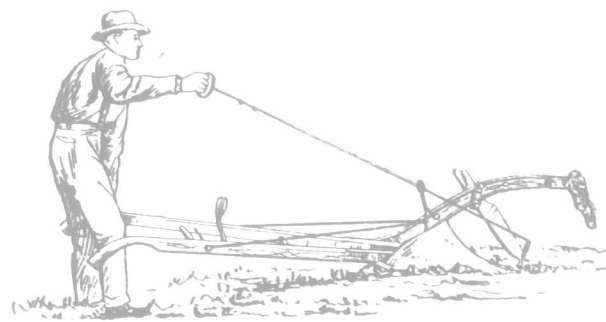

binder I took the tilter, or lever for raising or lowering the machine, and also the kicker which once was used for kicking the grain back on the lower canvas. With

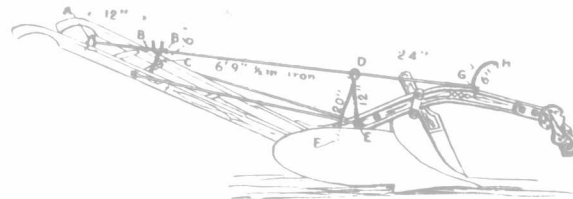

these two pieces and a bolt the material is on hand. Through the beam of a South Bend or other manufacture of plow I bore a hole and fasten the kicker thereto on the left by means of the bolt. With the lever fastened to this kicker and extending back on the handles the rubbish may be moved as desired.

A. M. F.

[Ed.—In the accompanying cuts will be seen another device used at the Dominion Experimental Farm, Ottawa, where it gave good satisfaction.]

Fat Stock Club Banquet.

At a joint meeting of the Fat Stock Club Banquet Committee and the Reception Committee of the City Council of Guelph final arrangements were made for the annual banquet of the club, which will be held in the City Hall, on Thursday evening, December 11th. Many prominent speakers have signified their intention of being present, among whom are Mr. J. I. Tarte, late Minister of Public Works; Hon. Sydney Fisher, Minister of Agriculture, and Mr. J. P. Whitney, leader of the Opposition in the Provincial Legislature.

Chinamen in Berlin Beet Fields.

Owing to the scarcity of laborers in Waterloo County and the necessity of having the sugar beets harvested before winter, the Ontario Sugar Co. have been obliged to import a number of Chinamen from Montreal to aid in solving the problem. The Indians which were employed during the summer have not proved altogether satisfactory.

Farmers' Institute Progress.

The annual report of Mr. G. C. Creelman, Toronto Department of Agriculture, Superintendent of Ontario Farmers' Institutes, makes an excellent showing. During the season of 1901-1902, 730 meetings were held, at which there was an attendance of 131,653 persons, and 3,262 papers were read and addresses delivered. Within the past two years, 44 women's institutes have been organized, having a membership of 2,816, to promote scientific knowledge of their home work.

Barnardo Homes.

An attractive monthly periodical, "Ups and Downs," is issued from 214 Farley Ave., Toronto, Ont., under the auspices of the Barnardo Homes, which have done so much for the introduction of Old Country youths into good Canadian homes, where they have grown up to be useful and successful members of society. It has been a grand work, and the periodical is well worth seeing. Send for a sample copy.

Lincoln Co., Ont.

"When the harvest is past and the summer is gone" there comes a time when the farmer looks back over the seasons that have passed and recalls the "ups and downs" which have confronted him during the busy seasons of the year. The last week in March the sun shone beautifully, the breezes were balmy, many farmers thought spring was at hand in earnest, and the harrows, scarifiers, rollers and disks were put into action. The beautiful weather soon took its flight, however, and a long rainy season followed, which delayed seeding for nearly a month. Again, a pleasant season came and, as it was getting late, seeding was rushed, and it was well, for the grain had scarcely been sown when another rainy period came, lasting for a couple of weeks.

Since the Hessian fly played such havoc with fall wheat during 1901, a very small acreage had been sown, consequently more spring grain was sown. Grass peas, which had been such a favorite and sure crop for several years, were sown in abundance, but from some cause they were a total failure. One would be quite safe in saying that in years past they averaged about twenty bushels per acre, this year about one and a half to two bushels.

Oats did the best this year they have for some time. In some localities, however, they rusted some on account of being sown so late.

Fall wheat averaged about thirty bushels to the acre. The principal varieties are: Dawson's Golden Chaff, Manchester and Early Arcadian. There has been far more wheat put in this fall than last, and since the fall has been so favorable it has a splendid top. Farmers are waking up a little with regard to cultivating their land. Last fall and this, the wheat has been put in in better condition than in the past. There was considerable corn planted this year late. It is not yielding very well, however, as the season was unfavorable—too cold and wet.

Potatoes did well until they came in blossom, when a blight came over them, and in some sections they are a total failure.

Turnips, sugar beets, mangels and carrots did well. There seems to be a tendency to drop turnips and mangels, however, and sow more sugar beets.

There is a creamery near that runs summer and winter, and people are going into the dairy business more than formerly, hence the reason for an increased acreage of sugar beets.

Silos are becoming quite popular. A few years ago one could not see one in a five-mile drive, but now, in some places, five may be seen in driving one mile, and since those that have them would not do without them, there is a likelihood of more going up next summer.

Some years ago, in going through this section, one would have seen the farmers feeding large, massive hogs for market, but matters have changed. Shippers and bacon hogs are in demand. Good prices are paid for shippers weighing from 160 lbs. to 200 lbs., live weight. In the raising of pigs and calves, farmers favor the creamery in preference to the cheese factory, as the whey from the cheese factory is of but little value for such stock, while the milk brought back from the creamery is valued quite highly.

Shipping cattle have not been in much demand this summer. A few two-year-old steers have been sold this fall for about \$28 per head. Lambs are selling for about \$3.25 to \$3.50.

We are all looking forward to Ontario's great Winter Fair at Guelph—the show that everyone should attend—the place to learn something that will be of interest and value. As it is held at a time when farm work is not pressing, methinks it would be of great interest to farmers and their wives to attend this great show. And to the young men of this Province I would say that a place would be hard to find where they could receive knowledge of a more intrinsic value.

I. E. N.
Lincoln Co., Ont.

Coming Our Way.

An American exchange announces that Connors Brothers, heavy owners of cattle in the Spearfish district, are contemplating the removal of several thousands of their stock to British Columbia owing to the crowded condition of the South Dakota, Wyoming and Montana ranges. This is the second large firm to move into Canada from the same feeding ground.

Sheep and Dogs.

Sir,—I believe that the owner of sheep killed by dogs should receive the full value for them, for he is not the loser of the dead ones only, but the rest of the flock are, as a rule, left little or no use, as they are so much frightened. Again, I think there should be some restrictions on the owner as well as the dog; some care little where they ramble to. I would say the owner of the dog that kills a sheep should pay half the cost of the sheep, and the township pay the other half, levied by taxes. Every person keeping more dogs than one should pay a double fee for every extra one, for they are only a nuisance, being always on the race. Five of my neighbors have two dogs each, two of them have no sheep, and they do not care where the dogs go. Another neighbor, who had two dogs, shot both for killing sheep this summer, and paid for the sheep they killed.

I think the owner of a dog following a pig on the highway should pay a special tax, as these are very often the ones that do damage.

Bruce Co., Ont.

A READER.

MARKETS.

Toronto Markets.

Trade at the Western Cattle Market was active. Exporters were a shade higher. Owing to the near approach of the close of navigation, many contracts have to be filled. The run of cattle to-day comprised 84 carloads: Cattle, 1,224; sheep, 1,802; hogs, 1,162; calves, 15, and horses, 23. The horses were rested and feed en route to Portland by G. T. R. Export cattle from ten to fifteen cents per cwt. higher. Butchers' cattle steady. Bulls unchanged. Feeders higher and scarce. Stockers unchanged and supply limited. Sheep in good supply and higher. Hogs higher and steady, with a good demand.

Export Cattle.—Supply scarce, and exporters did not obtain sufficient for their wants. Prices of best choice shippers, \$4.75 to \$5.25; medium, \$4.25 to \$4.75. Mr. William Levack bought 300 head of choice export cattle to ship via Portland to Liverpool.

Butchers' Cattle.—Choice butchers' cattle scarce and in good demand at \$4.25 to \$4.70; medium, well-finished heifers, \$3.75 to \$4.25; poor to common cows, \$2.75 to \$3.75. The Harris Abattoir Co. purchased six loads of good butchers' cattle at \$4.25 to \$4.40.

Bulls.—Choice heavy export bulls sold to a good demand at \$4.25 to \$4.50; light and medium, \$3.00 to \$3.25.

Feeders.—The demand still active. Choice, well-fed ones wanted at \$4.25 to \$4.75.

Stockers.—Stockers hold steady with a good demand and short supply, at \$2.75 to \$3.25; off colors, small, poorly-bred, common stockers, \$2.00 to \$2.75.

Mr. D. McDougal, the well-known dealer, of London, Ont., has been appointed to represent Messrs. B. I. Steven & Co., live-stock dealers, of Buffalo.

Calves.—Good demand for choice calves for immediate delivery. Prices steady and firm at \$5.00 to \$10.00 per head.

Sheep.—The demand for export continues; run large; prices firm, at \$3.40 to \$3.60 per cwt. for ewes. Bucks sold at \$2.50 to \$2.75. Mr. Wesley Dunn purchased 900 sheep and lambs at from \$3.55 to \$3.85 per cwt. Lambs sold at from \$3.50 to \$4.00 per cwt.

Milk Cows.—Demand very good. Buyers report a scarcity of good dairy cows. Prices range from \$45.00 to \$55.00 per head.

Hogs.—The prospects of the hog trade are very good for steady trade. Prices unchanged at \$6.12½ per cwt. for choice singers, off cars, unled or watered; must weigh 160 and not above 180, live weight. Car lots thick, fat and light are quoted at \$6.00; from farmers' wagons, \$5.75; stores, \$5.50; sows, \$4.50 to \$5.00; stags at \$2.00.

PRODUCE MARKET.

Wheat.—On Toronto market, 400 bushels of white sold for 72½ cents per bushel. Two hundred bushels of red sold for 72 cents per bushel, and 200 bushels of goose at 66½ cents per bushel.

Barley.—Seven hundred bushels sold at 50 cents per bushel.

Oats.—Five hundred bushels of oats sold at 36½ cents per bushel.

Peas.—One load of peas, badly injured with the weevil, sold at 73 cents per bushel. One load of good peas sold at 85 cents per bushel.

Mill Feed.—Shorts steady at \$17.00 per ton; bran, \$14.00. Manitoba mill feed is quoted at \$20.00 per ton, sacks included, f. o. b. Toronto.

Hay.—Thirty loads sold at from \$14.00 to \$16.50 per ton; clover and mixed hay, \$6.00 to \$9.00.

Straw.—Three loads sold at \$13.50 per ton.

Dressed Hogs.—Hogs were firm at a slight advance, \$8.00 to \$8.50 per cwt.

Dressed Beef.—Beef, fore quarters, per cwt., \$6.00; beef, hind quarters, per cwt., \$7.50.

Mutton carcass, per lb., 6 cents. **Lamb,** 7 cents. **Veal,** per cwt., \$8.00.

Poultry.—There is at present a good demand for poultry of all kinds. Chickens, 40 cents to 50 cents per pair. Turkeys wanted, and quoted at from 9½ cents to 12½ cents per pound. Ducks are quoted at from 5 cents to 8 cents per pound.

Strawberries.—One scarcely expects to see Canadian strawberries, grown in the open at Clarkson, Ont., offered during the last week in November. Today were sold six boxes of Canadian strawberries, nice plump berries, at 50 cents per box.

Montreal Markets.

Montreal, Nov. 24.—About 700 head of butchers' cattle, 30 calves, and 1,200 sheep and lambs offered. The butchers were out in large numbers and there was a fair demand for anything good, but the common stock are still dull, without any improvement in the low prices lately paid. A few of the best steers sold at from 4¼c. to 4½c. Pretty good animals sold at from 3¼c. to 4c., and the common stock at from 2c. to 3c. The canners paid from 1¼c. to 2c. per lb. for their supplies. The calves sold at from 3c. to 5c. per lb. Sheep brought from 2¼c. to 3¼c., and lambs from 3¼c. to a little over 4c. per lb. Fat hogs sold at from 5¼c. to 6c. per lb., weighed off the cars.

British Cattle Markets.

London, Nov. 25.—Live cattle firmer at 13c. to 14¼c. per lb. for American steers, dressed weight; Canadian steers 1c. lower; refrigerator beef, 11¼c. to 12c. per lb.; sheep, 11c. to 13c. per lb.; lambs, 14c. per lb.

Important Points to be Considered by Farmers.

IT STANDS THE TEST FROM EAST TO WEST.

Please find express money order for renewal to FARMER'S ADVOCATE for 1903. I cannot do without it. No agricultural paper published in America can come up to it. GEO. S. SHAW.
Idaho, U. S., Nov. 15, 1902.

I cannot speak too highly of your paper. I am well pleased with the FARMER'S ADVOCATE, and wish you every success. W. H. HILL.
Algoma, Nov. 20, 1902.

Things that You Want.

The world is full of HAS-BEEN'S and WILL-BE'S. For 36 years the FARMER'S ADVOCATE has aimed to be a DOER every issue, and that is the plan and policy today. It is not an organ for men or parties, but a searcher after facts for farmers, and a place for their prompt publication in attractive form. That is our programme for 1903—getting at the truth about the practice of agriculture, stock-raising, dairying, gardening, fruit and flower growing, beekeeping, treatment of ailing animals, the home life, and the thousand and one questions that confront the farmer every year. Practical answers to questions is one of its strong features, dealt with by a corps of specialists. "When I get stuck," writes one reader, "I write for information to the ADVOCATE." And another adds: "The beauty of your answers is that they can be relied upon and worked out in practice."

Practical and Competent Staff.

The great secret of the paper's success is that its editors and contributors are practical and competent. We have writers in every corner of the country. Our constant aim is to make the information published reliable. By steering clear of boomsters, faddists and fakers, and enlisting the co-operation of fair-minded and enlightened farmers in every province, adjoining States and Great Britain, we serve our readers with what is up-to-date and helpful. Practical men read it because it pays them, and because they want the best. "For improved stock breeding," writes an Eastern breeder, "you have done more than all other papers put together." Its reports of shows and herds are the reports that are read and that command respect.

Illustrated Teaching.

By using the best type, paper and ink, we make the paper readable, and we illustrate it with the best engravings money can procure, because we believe that one of the most affective ways to teach is through the eye. We make the camera serve our readers with knowledge, as well as please them. Every issue is an object-lesson.

Chicago Markets.

Chicago, Nov. 25.—Cattle—Good to prime steers, \$5.75 to \$6.90; poor to medium, \$3.00 to \$5.50; stockers and feeders, \$2 to \$4.60; cows, \$1.40 to \$4.50; heifers, \$2.00 to \$5.00; bulls, \$2.00 to \$4.50; calves, \$5.50 to \$6.75; Western steers, \$3.50 to \$4.75. Hogs—Mixed and butchers', \$5.85 to \$6.25; good to choice, heavy, \$6.15 to \$6.45; rough, heavy, \$5.75 to \$6.10; light, \$5.75 to \$6.10. Sheep and lambs—Good to choice wethers, \$3.50 to \$4.00; fair to choice, mixed, \$2.50 to \$3.50; native lambs, \$3.50 to \$5.20.

East Buffalo Markets.

East Buffalo, Nov. 25.—Cattle—Good demand; steady. Veals steady; tops, \$8.25 to \$8.75; common to good, \$5.00 to \$8.00. Hogs—Heavy, \$6.30 to \$6.40; mixed, \$6.15 to \$6.25; Yorkers and pigs, \$6.00; roughs, \$5.50 to \$5.85; stags, \$4.75 to \$5.25. Sheep and lambs—Top lambs, \$5.50 to \$5.60; culls to good, \$4.00 to \$5.40; yearlings, \$3.75 to \$4.00; ewes, \$3.25 to \$3.60; sheep, top, mixed, \$3.25 to \$3.35; culls to good, \$1.75 to \$3.15.

I have taken your paper only since May 15th, 1902, and am so much pleased with it that I only wish I had taken it long before. S. T. MILBURN.
Peterboro Co., Ont., Nov. 25, 1902.

I find the ADVOCATE one of the best papers I have taken, especially for its valuable articles on dairying, and I feel that I could not do without it. I shall endeavor to get some new subscribers. King's Co., N. S. W. R. ARMSTRONG.

Experiment Stations.

In constant touch with all Experiment Stations, we give our readers, promptly, the benefit of their investigations.

A Home Paper.

We believe in the home and home improvement, literary culture and art; hence, our readers have the "Home Magazine," with a larger and better-equipped staff than any other paper of its class. Old and young peruse its pages with delight and profit.

About Our Premiums.

Do we give premiums with the FARMER'S ADVOCATE? No, but we do give liberal and handsome premiums as a reward to present readers who obtain new subscribers to the paper. The reader finds the paper itself a premium, and everybody asks "how can you give such a splendid paper for such a small subscription price?" Our premiums, announced elsewhere in this and other issues, are like the FARMER'S ADVOCATE itself, "not how cheap, but how good." Note especially the Farmer's Knife, Collie Dogs, "The Big Four" Pictures, Curb-link Bracelet, Microscopes, Watches, Books for the farmer's library, and the celebrated Bagster's Teacher's Bible, which for students is invaluable. The small effort required to obtain three new subscribers for so good and popular a paper as the FARMER'S ADVOCATE makes it still a "bargain," for such Bibles cannot be purchased anywhere for less than \$3 cash. Look up the Premium pages.

Two Christmas Numbers.

In extending our subscription list our present readers are our best friends. We give to new subscribers every issue of this paper from now till the end of 1903, including the Christmas numbers of both years, for the regular yearly rate of \$1.

How to Get Your Paper Free.

By sending us the names of two new subscribers, at \$1 each, we will extend your subscription for one year, gratis, from expiry of your present subscription.

Write us at once for FREE SAMPLE COPIES, and push the canvass at once.

Address THE WILLIAM WELD Co.,
London, Ont., Canada.



"Of a' roads to pleasure
That ever were tried,
There's none half so true
As one's ain fire-side."

The Degeneration of Mrs. Nesmith.

"He is a farmer," said Adella Mason, and she added in a moment, "isn't it queer to think of me as a farmer's wife?"

"Yes, it is," answered her friend in a tone of disapproval. "I don't like it. I've a good mind to break up the match—if I can."

"Why, Nellie Jerome! What a thing to say."

"Well, if you'd had two or three friends who had gone to live in the country you would think just as I do about it."

"Why, it is just lovely where I am going. It is an old house where Mr. Nesmith's grandfather lived. It is old-fashioned, of course, but it is picturesque, and there are beautiful big elms around it. You must come and visit me, and I know you will be charmed with my home." She blushed a little at the last word.

"It isn't the place I am thinking about," said Miss Jerome gloomily; "it is you."

"Well, what about me? Do you think I am going to be worked to death? I am not. I have visited at the Nesmiths' and I saw that the men folks were the thoughtful, considerate kind. It isn't a large farm and I am going to enjoy the work."

"Yes, I know. But you don't understand what I mean. I have seen what happens when a city girl goes to the country to live. Will you listen and not get angry while I prophesy a little? And remember it is not theory, but what I know and have seen."

"Go on."

"At first you will keep up with your music and reading. You will wear your pretty clothes and call on the neighbors. You will go out of doors every day and be cheerful and contented. After a time you will forget to change your dress afternoons, you will neglect your piano and stop singing. You won't have time to read, and you never will step out of the house if you can help it. You will be continually putting over your housework, never getting it done, and you will be tired and out of sorts all the time. You will call it a dull old place where you live, and you will be continually finding fault with your neighbors. As for your husband—of course, not knowing him yet, I can't tell what effect your degeneration will have on him. Sometimes they get sour and fault-finding; once in a while one takes to drink. It all depends on the man. The change in you, though, is what I think of most. You won't have anything to make life worth living, and it will be all your own fault, for you will have deliberately thrown away the things that were worth while. There! Isn't it a pretty picture? You have a good disposition, Della; I will say that for you. Lots of girls would never speak to me again if I had talked to them this way."

"How long will the process of degeneration take?" Della spoke slowly and there was a deep color in her face.

"Well, I'll give you a year and a half," said her friend judiciously.

"Come and see me at the end of that time."

"I shall come unannounced," laughed Miss Jerome, "so as to find you in your dingy calico dress and dirty apron. I won't promise to stay long, as I shall probably be desperately homesick."

It was nearly two years before Miss Jerome fulfilled her promise to visit her friend. It was a cold, blustering day in March, and she had already begun to feel homesick before reaching the Nesmith house. She had hardly stepped into the yard when the front door opened and a figure ran down the path to meet her. It was Mrs. Nesmith.

"Come right in," she said cordially, and she hurried her guest through a little entry and into a warm, sunny room.

Before she knew what had happened, Miss Jerome found herself, with her wraps off, seated in a comfortable chair, toasting her feet at a stove. She gave a hasty glance about the room. "Lots of sunshine, books, papers, plants at one window, piano open," was her mental comment.

"I saw you coming," Mrs. Nesmith was saying, "way down the road; for in my countrified way I am always on the lookout for passers. But I did not recognize you till you almost reached the yard."

Miss Jerome's visit was extended to a week, and she was sorry when the day came when she must go home. The two friends were having their last talk together.

"I was a false prophet," said Miss Jerome significantly, as she looked about the pleasant room. "What is more, I am very glad I was."

It was the first reference that had been made to the talk they had two years before.

"You have not degenerated," she went on. "You

have improved wonderfully. I have long thought that fads were the country woman's salvation, and you have more of them than you used to have. There are your plants, and your music—it is so nice to have those weekly sings here, when all the neighbors come—and you have the long walks with the neighbors' children, and in summer you have botany and birds. It has done me good to see the way the young people flock to you and to see how you help them and advise them on every subject under the sun. Best of all is your perfect sympathy with your husband, and your interest in his work. I have had a lovely visit and I am so thankful that I was a false prophet."

"If you hadn't prophesied," said Mrs. Nesmith with a whimsical smile, "you would have been a true one."

Miss Jerome looked puzzled. "Please elucidate," she said.

"What you said that time made a very strong impression on me, and I determined that I would not degenerate. It has been hard not to, sometimes. It is a natural tendency and I had to fight against it. I could see just how true it all was, what you said. I have to keep a sharp lookout, now, not to backslide, but I think the worst of the struggle is over. I do enjoy life so much—you don't know. I am a very happy woman, and I owe it to you that I am not what you described."

"I am glad that I had a little to do with it," said Miss Jerome, "but don't give me all the credit. Most of it belongs to that strong will of yours, my dear."

NONA RUSS.

A Christmas Acrostic.

Suitable for Christmas entertainment.

BY A. M. K.

Nine children, each bearing a letter, march, while singing to time, "Marching Through Georgia":

Sing we now of Christmas time, the best of all the year,
Peace and happiness abound, the season of good cheer;
Blessings rich from heaven above are scattered far and near,
While we sing "Merry Christmas."

Chorus—

Sweet peace, good-will to men, the angels sing,
Glad bells awake and happy echoes ring,
For tidings glad to rich and poor alike to-day they bring,
While we sing "Merry Christmas."

Each child in turn recites:

C Christ was born on Christmas day,
In a manger low He lay.

H Heavenly angels praise His name,
"Peace on earth" the glad refrain.

R Rich the blessing given to earth,
Gracious gift, sublimest worth.

I I will sing on Christmas morn
Of the Saviour who is born.

S Stores of gifts and happiness,
Homes both rich and humble bless.

T Thanks, our heavenly Father, dear,
For Christmas blessings every year.

M Merry Christmas, hear the shout,
Ring the glad old world about!

A All the world rejoice to-day—
Merry, happy, Christmas day.

S Saviour born in Bethlehem,
"Peace on earth, good-will to men."

Sing, then, happy children, all this merry Xmas day,
All is joy on earth to-day, all sorrow cast away,
Hearts are light and free from care and gentle peace
has sway,
While we sing "Merry Christmas."

Somebody's Birthday.

This is somebody's birthday,
Just as sure as fate;
Some little boy is six years old,
Some little girl is eight,
Some little boy is three to-day,
Some little girl thirteen,
Some little twins are exactly two—
Two apiece, I mean.

Some one is eating his birthday cake
And laughing over the plums;
Some one is counting her birthday dolls
On all her fingers and thumbs.
Some one is bouncing his birthday ball
Or winding her birthday watch,
Some one is not too wise or tall
For birthday butter-scotch.

Think of the beautiful birthday books,
Think of the birthday cheer,
Think of the birthday happiness
Every day in the year!
Every day in the year, my dear,
Every day we're alive,
Some happy child is one or two
Or three or four or five.

—Ethelwyn Wetherald.

The Red River Settlement.

Some Reminiscences of Fifty Years Ago — Chiefly Schoolroom Memories.

Out of the mists of the past appears such a quaint little figure, with its odd mixture of old-womanishness and childish ways. Looking at Lizzie T., with her big shawl enveloping her head and shoulders, the ends knotted behind her back (a very general and easy-going playground costume amongst us all, where comfort was everything and fashion never considered), one could hardly tell whether she was nine or fifty years old. Indeed, there were times when she took on the dignity of the latter, and others when she hardly showed the natural development of her real age, which, I think, was about ten or eleven. Lizzie's grasp of a subject was always of the vaguest. Instruction seemed only to tickle her mental palate, refusing to go much further down. It could not reach her digestive powers, and never arrived at assimilation point. Sometimes a name or sometimes an idea would seem to have "caught on" and would make its sudden and often most inappropriate appearance, with an air of self-satisfaction and proud triumph, most upsetting to the gravity of teacher and fellow-pupils alike. But Lizzie had her ambitions, and whatever task was set her classmates she would try her hand at it or die. A girl on the same form had ended a very well written account of the Bishop's sermon of the Sunday before, by quoting its text. Lizzie had been agonizing over her own chosen subject, "The Pig," and had arrived at nothing more descriptive than the words, "The pig is a very dirty animal; it is fond of rolling in the mud." At this point Lizzie had literally "stuck in the mud" and could get no further, but a way out of it was suggested by the praise accorded to her comrade. "It was all because she put a text at the end," thought simple Lizzie, "and so will I." With much painful effort, the tip of her red little tongue following the ups and downs of her scratchy slate pencil, Lizzie laboriously inscribed what was the Bishop's chosen motto for his schools, "In Thy light shall we see light," well known to the pupils in both, and with no thought of incongruity and not a vestige of irreverence, her slate with its curious little essay was handed to her teacher, as by one who deserved well at her hands. The next lesson in the composition class did not leave a free choice of subjects, but each girl was to describe what she had noticed when taking her last walk upon our only winter road, the frozen Red River itself. "Why! you are quite poetical," said her instructor to the girl occupying the top seat on the bench. "That is really very well told. You may have three good marks for your composition." "I'll have three marks too," said Lizzie to herself. "Why, I remember lots of poetry." So she began thus, though cruel fate denied her a finish to her poetical venture: "When we went out for a walk on the river we saw the snow-birds running (pronounced rooning) about on the fury tomulet, and the bee".....and there she came to a standstill. There was something queer about it, she felt; perhaps it was odd that the snow-birds and the bee should be "running about together, especially in winter." Anyway, the mental supply had failed, and with it all hope of Lizzie's three marks. "What a figure of fun you look, Lizzie," said her teacher to her, jokingly, one day. "I wish we could send a sketch of you to Punch. But there, you don't know what I mean by Punch." "Oh, yes, indeed I do," replied the undaunted Lizzie, "He's in the Bible—Punchus Pilate." She really was more familiar with Bible stories than any other kind, and so, after her own jumbled fashion, it was there Lizzie mostly sought her inspirations. On another occasion, she wanted to describe how very sorry they would all be when the time came for her teacher, whom she really loved, to leave them and return to England, and this is how she transposed the situation: "Mrs. M. will be sitting on the boat, when she has said good-bye to us, tearing her hair and gnashing her teeth." I have heard since those days that Lizzie became a good, sensible little wife and mother, but I believe that she has long passed away, as have so many others whose girlish faces I remember so well.

Another schoolroom episode I recall as I write, partly because of my introductory mention of Lizzie's costume. We all had big, square shawls to twist around us and tie firmly behind us when the bell ordered us out for a romp in the snow, which we could shake off like powder when we went indoors again. These shawls were folded square, and placed one above another in a large empty tea-chest, which stood, papered and ornamented, either in a corner of the hall or of the schoolroom. On Saturdays the Bishop would occasionally come to see us, and the girls, all seated decorously before him, were, in most kindly form, asked questions testing their progress. Frank J., the mischievous, the idle, a lad of 8 or 9, would delight in riding down on his grey pony from the Fort, sometimes with the judge, his father, more often by himself, to have "a lark" and scare the girls if he got a chance. Sometimes it would be by a sudden appearance through the window, landing on his head, or after hiding in the cellar in the dining-room, popping up through

the square flap in the floor, or pretending to make his pony run over them in the field outside St. Cross. On this occasion he got the girls to connive with him, and at a critical moment of the examination, the muffled sounds of a cock crowing, of a duck quacking, a cat meowing and a dog barking issued from that apparently shawl-filled tea-chest in the corner of the schoolroom. At first the Bishop pretended to take no notice, but as that only set the whole poultry-yard into commotion, and started the girls into an uncontrollable giggle, for Frank was an inimitable mimic, finally he had to be expelled from the shawl-box, with as near a reprimand as that tender-hearted Bishop's lips were ever heard by us to utter. I could almost give the names of each girl in that room, as I write, and I wonder who of them is living yet to say, "Why, I remember that also." How many of them, too, can recall that dreadful summer evening when the little Indian lad, Georgie Hoesfall, was killed by a lightning stroke just beneath our fence? The head of the house happened to be spending a day or two away from home, a very rare event. She was at the Middle Church parsonage, some few miles below. The day had been very sultry, and a storm threatened. We were used to rather bad thunderstorms, and felt no especial uneasiness. The judge had come to see the eldest daughter of the house, whom he shortly afterwards married, his pony and little Red River cart being put up in the "byre" behind the house. Blacker grew the clouds, more vivid the lightning, so not a moment was to be lost if he and Frankie, the mischievous, who looked solemn enough now, were to get back to the Upper Fort before the storm burst. Frank and the writer rushed to the byre, and if there is such a measure of time as a "jiffy," it was in less than that we got the frisky, and now scared, little animal into the shafts. Anxious eyes watched from the schoolroom window the appearance and disappearance of that little cart, as it was, with its occupants, silhouetted against the sky with startling vividness, from various points along the prairie road to Fort Garry. Happily, they got safely into shelter, but not so poor Georgie, the Indian lad. He had brought over to St. Cross our usual portion of milk from the Bishop's farm. He had returned thither for the evening portion for Bishop's Court, and had started out again with his brightly shining cans when that death-bolt fell. He was found lying almost upon his face, which was blackened and disfigured, his hair singed to the scalp, and his clothing nearly all burnt into rags. The handle of the can in his hand was twisted out of shape, and in the can itself were two big holes through which the milk had trickled away. I have since that time been through storms of fearful violence on the South African veldt, leaving death and destruction upon their trail, but the memory seems ineffaceable of this evening of horror, perhaps because it was the first storm with fatal results which I had ever personally witnessed. The boy's body was not found until daylight, no one searching for him, as at Bishop's Court they thought he had not started, and at the farm, that he had been kept over night at Bishop's Court. Nothing, however, could have saved the life of the poor child, and he must have died without a moment's pang. Perhaps I have no more vivid memory of old Red River days than the tragic ending to that dreadful storm of fifty years ago. H. A. B.

The Tomb of Mausolus.

This was one of the Seven Wonders of the ancient world. Mausolus was King of a Province in Asia Minor. He was a man remarkable for his personal beauty, and was married to his own sister, Artemisia. Such a marriage was not uncommon in heathen countries in those early days. Artemisia was so much attached to her husband that when he died in 353, B.C., at the age of 24, she caused to be erected the most magnificent tomb to his memory the world had ever seen. This tomb was 63 feet long, by nearly as many feet in width, and was surrounded by 36 noble marble columns. It was built by four famous architects, each architect erecting one of the four sides, so that the four sides were all of different designs, and each trying to excel the other in grandeur of style. When the tomb was finished, a fifth architect was employed to erect a pyramid over the building, and on the top of the pyramid was a marble chariot drawn by four horses. When the whole was finished she called it a Mausoleum, after the name of her husband, which has given a word to our English language, for a mausoleum means a magnificent sepulchral monument. Our late beloved Queen was laid away in a granite sarcophagus, beside her husband, in Frogmore Mausoleum, Windsor, but Mausolus never lay in the tomb erected by his wife. When her husband died, she caused the body to be burned to ashes; when she drank her wine she mingled a little of the ashes with the liquor, so that she literally swallowed her husband.

The poor woman died of excessive grief, two years after her husband. J. O. Lambton Co.

Some Homemade Christmas Gifts.

O yes, it is coming; that is, Christmas. The whirling drifts of brittle leaves tell us that, and the shrinking of the scarlet barberries, and the corn-eating propensities of the turkey-flock, and where there are toddlers, the oft-repeated queries about Santa Claus, and solemn councils of war concerning the besieging of the chimney and capturing his Santaship with his pack of dolls, and drums, and "humbugs," and "nigger toes." O, to be a child again!

"O for festal dainties spread,
Like my bowl of milk and bread,
Pewter spoon and bowl of wood,
On the door-step gray and rude!"

Well, we can all try to be children at heart, if not in years, remembering those old, old words, "Whosoever shall not receive the Kingdom of God as a little child he shall not enter therein." And so, as this Christmas season draws near, let the old careless exuberance fill our hearts, and albeit we have long since abandoned all effort to trap that wily Master of the Reindeer, let us place our little surprises as joyously as in those glad days, and see how near we shall grow to the children by so doing.



FATHER'S RETURN.

Everyone will admit that home-made gifts are, as a rule, the most acceptable, but if you want to make a number of presents do not attempt any one extensive piece of work. You know it is not the value of the Christmas gift that makes it so sweet to the recipient, but the deep, glad consciousness of "being kept in remembrance." Now, of course all you girls have a knowledge of the needle, and the crochet hook, and very likely of the netting-mesh, the embroidery-frame, and the tatting-shuttle. In crochet work you can make dainty doilies of pretty colors, or of plain white, which is perhaps more satisfactory, with or without linen centres, and a pair of these makes a nice Christmas reminder. I have a number of patterns for crocheted doilies, and if any of my girl readers would care for some I should be pleased to send them through the "Advocate." Pretty handkerchief holders may be made by covering a six or seven inch square of pasteboard with sateen over wadding, crocheting around it in plain knot stitch to a depth of about eight inches, finishing the edge with a crochet frill and gathering with a bit of ribbon. To make a whisk-holder, cover a number of brass rings one inch in diameter with close single crochet in silk, tack them together in the form of a V for the front, and a single horizontal row for the back, fasten a bow of ribbon on the lower point of the V, and hang up with ribbon tacked in a bow to

each other point. One can also crochet centre-pieces, beaded purses, bedroom slippers, baby's booties and jackets (including the pretty boleros), tea coseys, "hug-me-tights," handkerchief borders, and, O—"things too numerous to mention." And the same way with fancy knitting and netting. Netted doilies, when done with very fine thread, are exquisitely dainty, and as the thread costs but a trifle, and they are quickly done, they make a very desirable gift.

If you embroider or do outline work, you can make almost numberless pretty things. Photo-frames of white or brown linen, embroidered simply with colored silks, are very nice, although they are a little out-of-date now. A useful thing is a book for clippings. Procure eight large envelopes, tack them together at the lower edges in book form, and glue them into a cover made of stiff pasteboard, covered with linen and having a design of forget-me-nots embroidered around two sides, and the word "Clippings" across the centre. Neat little pincushions may be made of two round bits of cardboard covered with linen, embroidered or outlined in some design, and tacked together with wadding between and a puffing of silk around the edge; they are suspended by ribbon the same shade as the silk. Speaking of pincushions, quite a "cat-tail" novelty is made as follows: Take a small round stick, about seven or eight inches in length, and wind pale-green baby ribbon around two-thirds of its length, wrap the remaining third with layers of wadding, and cover with brown velvet or plush, joining neatly; take two pieces of stiff green satin ribbon an inch and a half wide (for leaves), cut to a point at one end and fasten to the other end of the stem with the baby-ribbon. To make a newspaper holder, cut two pieces of cardboard, one almost square, with fancy curved edges, the other the same width, but not so deep, cover them both with blue linen, outlined with white linen floss, fasten together at the lower edges, and at the upper suspend the one from the other with little brass chains, or ribbon.

Chamois and celluloid make good foundations for many things. Of the former, one can fashion pen-wipers, watch-polishers, baby's boots, and if one can paint, photo-frames and table-mats. Of the latter there are napkin rings, book-markers, and exquisite little boxes for holding rings, fancy pins, etc.

It is surprising what pretty results you can attain sometimes with odds and ends of ribbon, silk or lace, by setting your wits to work and cultivating your bump of originality. I could tell you of several ways in which to utilize such "nips," but this pen of mine has a habit of flying into forbidden space, so I must clip its wings. One other thing I want to tell you about, however, for kitchen use exclusively: Fold a large piece of heavy dark goods (washable) into a square about seven inches in size, stitch it around the edge, and fasten a loop to one corner to hang it by; bestow a number of these on your practical, good-housekeeper friend, and when she employs them to lift burning pots and pans her thoughts will be a warm thank-offering to you. Wishing you all success with your "homemade Christmas gifts." CHRYSOLITE.

Sliding Down-hill on a Carpet.

Brave old winter brings plenty of fun
For the boys and girls whose work is done,
But of all the sports the merriest one
Is sliding down-hill on a carpet.

You need but a square of carpet, you know;
Tuck yourself in, and away you go,
Over the ice and over the snow—
Sliding down-hill on a carpet.

So leave your dolls and sleds and toys,
And bring out your carpets, girls and boys,
For one of the best of winter's joys
Is sliding down-hill on a carpet.

THE QUIET HOUR.

The Habit of Complaining.

"When thou hast thanked thy God for every blessing sent."

What time will then remain for murmurs or lament?"

One of the commonest of all sins is that of murmuring and complaining. Perhaps we hardly realize that it is a sin at all, and, therefore, make no real, sustained effort to conquer the habit. We can see that a person who is constantly finding fault is very unpleasant to live with, but we too often forget that murmuring is a sin against God. The books of Moses are intended for the instruction of God's people in all ages, and no one can read them carefully and doubt that this sin is particularly displeasing to God. In fact, we are told that "when the people complained, it displeased the Lord; and the Lord heard it, and His anger was kindled; and the fire of the Lord burnt among them, and consumed them that were in the uttermost parts of the camp." These are very terrible words, for if God heard their complaints and punished them so severely for their want of thankfulness, what does He think of us? He had been kind to them, but how little idea they could have of the infinite nature of the Divine love. The Cross has revealed to us something of its length and breadth and depth and height. They expected God to shower down gifts on the earth, but never thought those gifts would cost Him anything. We know that He sacrificed Himself to the uttermost because of His love for us, and yet we are not ashamed to complain when called to drink of His cup. Yes, I know we try to be patient and uncomplaining when a heavy cross is laid upon us, but such occasions are few and far between. It is not only the great troubles that come from God. He is watching us and testing us every hour of every day. We are told that God prepared a great fish to save Jonah from drowning, and it is also expressly stated that He "prepared" the worm which caused the prophet so much annoyance. Don't you think the veil is lifted in this case to warn us not to find fault with what God has "prepared," lest He say of us as of Israel of old: "How long shall I bear with this evil congregation, which murmur against Me?"

We should not be "so ready with complaint" if we realized that each temptation to murmur is an enemy to be conquered. The Great Captain is watching each soldier in His army; watching to see how he will meet this little disappointment and that disagreeable duty; pleased when he faces an indoor tempest with good humor, or an outdoor one with cheery, resolute determination.

Let us look again at the Israelites in the wilderness. Among other things, they murmured because the food provided for them was not to their liking. God heard these complaints and gave them their desire, but in this case, too, He was much displeased, and "smote the people with a very great plague." "How much murmuring about food does God hear every day. Why, some people can hardly eat a single meal without finding fault about something. Once a wife's patience gave way when her husband said the coffee was weak, the toast burnt to a cinder and the ham hard as leather.

"John Henry," she said, "I've tried faithfully to cook for you these twelve years, and you always find fault. Why can't you praise me once in a while, I'd like to know?"

He was quite astonished, for, as he said, "I've often sat down to a meal and never said a word about it. Anybody would know there wasn't any fault to be found or I'd have found it. That's just like a woman—she can't tell a compliment when she gets one."

A person who forms a settled habit of looking out for something to complain about, is generally disappointed when he can't find a peg to hang a grievance on. He might truthfully say:—

"Oh, don't the days seem lank and long
When all goes right and nothing wrong?
And isn't your life extremely flat
When you've nothing whatever to grumble at?"

The truth is, if we keep on grumbling until that blissful time arrives, we may make up our minds to spend a lifetime in this profitable occupation. Even millionaires might find something to complain about. I heard of one who had to be satisfied with a dinner of bread and milk on Thanksgiving Day. He could buy turkeys in plenty, but could not digest them. Would you like to change places with him? I wouldn't, for health is worth far more than millions of dollars. Anderson tells the story of a princess who proved her high birth by being easily made uncomfortable. A pea was laid on her bedstead, and over it were placed twenty mattresses and twenty down beds. Next morning she complained that she had slept on something hard, and felt black and blue all over; so they knew she must be a real princess. I should have thought a real princess would have been too courteous and high-minded to complain about a trifle. It is often

considered that a man who is very critical and hard to please is a man of fine taste; but is he not rather, as Daniel Webster says, "a man of fine distastes?" We might take a leaf out of Mark Tapley's book, who made a point of coming out strong under disadvantageous circumstances, when it was some "credit to be jolly." You know when a cold firebrand and a burning lamp went out to see the world, the former declared that the whole world was dark, while the latter found nothing but brightness wherever it went, for it carried brightness with it. Some people are by nature bright and cheery, while others are naturally inclined to look on the dark side; but the talent of wearing clouds inside out, "to show the bright lining," is one that can be cultivated—and it is worth cultivating too.

"What's the use uv worryin'?"
What's the use uv keer?
What's the use uv buryin'
Folks that's living here?"

"What's the use uv ketchin'
Sorrers on the wing?
Let 'em go adyin'—
Stretch yer necks and sing."

THE CHILDREN'S CORNER.

A Christmas Chat.

Here is a letter from one of our old friends, Effie Letson, and very glad I am to hear that the "Lookout Regiment" is still alive:

Dear Cousin Dorothy,—

I have not written for a long time, so I thought I would write to you. I would like a correspondent or two belonging to the "Lookout Regiment," and not younger than ten or twelve years. I am a country girl, fourteen years of age. I would like them to write first. A friend of mine, belonging to the "Regiment," is visiting your correspondent, who also belongs to the "Regiment." I will close, hoping to receive correspondents. Ever a member,
West Montrose, Ont. EFFIE LETSON.

I hope some of the members will write to Effie. It is a good time to consult about plans for bringing a little Christmas sunshine into darkened lives. If you try to fill some stockings yourselves, you will enjoy Christmas far more than if you are like the child who cares only to have his own well filled. This is what he says:

'I've written a letter to Santa,
But how shall I send it—how?
I don't know what his address is,
'Cept it's up 'mongst the ice and the snow.

"I want him to get it just awfully,
'Cause there's lots of things that I wrote
That I wanted, and I know he won't bring them
Unless he gets my wee note.

"I suppose that I might ask the postman
To take it to him when he went
To carry round papers and letters
That grown-up people have sent.

"But then he won't get it till morning,
Oh, dear! it can never go so.
I'll pin it right on to my stocking,
Right here on the end of my toe.

"Now, when Santa Claus fills up my stocking,
He'll find the note there on the toe.
And he carries so many things with him,
I'll get all I wanted, I know."

The little boy who wrote that letter hadn't much faith in the post-office clerks, had he? If they don't know old Santa's address it is time they learnt it. I read in the paper last Christmas that 20,000 letters addressed to him had been posted by children in the United States that year. What a huge mail-bag he will need this December, for a lot of children have learned to write since last Christmas, and of course they will want to send a note to the dear old fellow. It is just as well to let him know what you want, although he doesn't always bring exactly what is asked for—it wouldn't do, you know. Why, last year one little chap in a Canadian hospital asked for a real Billy-goat with horns. Such a present might be very suitable for a boy who could run and play out of doors, but just think what a commotion it would make in a children's hospital. It would be worse than Mary's lamb in school, for instead of making the children "laugh and play," some of them would be sure to cry with fear. Santa sent a race-horse and sulky instead: not a live horse, you know, for that would have been as unsuitable as the goat.

I think many poor children must almost enjoy being ill at Christmas time, for they have a far better time in the hospitals than they would have in their own homes, where sometimes they hardly have bread enough to eat, and never dream of tasting turkey, plum pudding or candy. You may be sure the hundreds of stockings hung up by the sick children in our hospitals are always well filled. I once heard of a doll which found its way

into one of these stockings, and did its duty of cheering and comforting a sick child as well as any nurse. Its first mother was a rich little girl who had plenty of other dolls; still she was very fond of Josephine—while she was new. Sometimes she was a baby in a long white dress, sometimes she was dressed as a bride in white satin, and often she appeared as a widow in bonnet and veil, with a tiny handkerchief to weep on. But after awhile another beauty was put carefully to bed at night in Josephine's pretty little bed. A cruel boy ill-treated her dreadfully, even scalping her one day when he was playing Indian. She lost one eye and an arm, and was tossed into a rubbish room, where she lay for months, feeling very forlorn and miserable. But one day she was picked up and sent with a lot of other broken toys to a dolls' hospital. There she recovered her spirits and her beauty, clever surgeons provided her with a new eye exactly like the old one, and a new arm. A fresh crop of golden curls suddenly appeared on her bald head. She was dressed in a pretty blue sailor suit, and started life a second time, with the determination to do her duty nobly. Josephine soon found herself clasped lovingly in the arms of a poor little girl, who lay all day in bed, and often moaned with pain. The room was large and seemed to be full of beds. Josephine never felt neglected now, for her new mother loved her dearly. "Nurse," she would say every night, "you won't take dolly away from me when it is quite dark and I am asleep, will you?"

One evening when she asks this question the nurse can hardly answer her, for there is a choking in her throat; and Josephine feels two hot tears drop on her face as the nurse stoops over the patient little sufferer. That night the Angel of Death passes through the ward, and carries the tired child lovingly in his arms to a land where there is no more pain. There is a smile on the white face, and the little thin arms are folded round the doll. The nurse does not take it away, for she fancies she can still hear the weak little voice saying, "You won't take dolly away from me when I am asleep, will you?"

You see even a doll may have a mission, although many of them seem to waste their short lives terribly, but I don't think it is altogether their fault, do you? Christmas will soon be here, and perhaps some of you may find a way to help your dolls and other toys to do some good in the world before they are quite dead. I say "quite dead," because, although they may not have nine lives like a cat, at least they may have two—like our friend Josephine.

COUSIN DOROTHY.

Puddings and Cake.

TO MAKE AN ENGLISH PLUM PUDDING.

Seed one pound of raisins when preparing to make an English plum pudding; mix with them a pound of currants and half a pound of minced orange peel; dust over a quarter of a pound of flour. Chop fine one pound of suet; add to it a quarter of a pound of brown sugar, half a nutmeg, grated, three-quarters of a pound of stale, dry bread crumbs. Mix all the ingredients together. Beat five eggs, without separating, until light; add to them half a pint of grape or orange juice; pour over the dry ingredients and mix thoroughly. The mixture should not be wet, but each particle should be moistened. Pack this into small greased kettles or moulds. It will fill two three-pound kettles. Put on the covers, stand the moulds in the steamer, and steam steadily for ten hours. The easier way is to get the ingredients ready the night before; mix and put them on early in the morning, allowing them to cook all day. Take them from the steamer, remove the lids of the kettles or moulds, and allow the puddings to cool; then replace the lids and put the puddings away. They will keep in a cool place for several months or a year.

TWO GOOD RECIPES FOR PLAIN PLUM PUDDING.

To make plain plum pudding, mix together one pint of stale, dry bread crumbs, one cupful of brown sugar, a teaspoonful of cinnamon, half a grated nutmeg, and half a pound of finely chopped suet. Stone half a pound of raisins and mix them with half a pound of cleaned currants and half a pound of shredded citron. Dissolve half a teaspoonful of soda in a tablespoonful of warm water; add it to half a cupful of New Orleans molasses. Add this to three eggs, well beaten, and pour the whole over the dry ingredients. Mix, and pack into greased moulds or kettles. Steam or boil for four hours.

A plain Christmas pudding is made as follows: Chop fine one cupful of suet. Stone one cupful of raisins. Dissolve a teaspoonful of soda in two tablespoonfuls of water and add it to one cupful of New Orleans molasses. Now add this to the suet, then half a pint of milk, half a teaspoonful of salt, a teaspoonful of cinnamon and three cupfuls of sifted flour. Beat vigorously for two minutes and add the raisins, floured. Pour into a well-greased mould, put on the lid, and steam or boil continuously for three hours.

FARMER'S FRUIT CAKE.

Chop fine half a pint of dried apples; cover with half a pint of cold water and let them soak over night. The next morning add a cupful of golden

syrup; simmer gently for one hour. Stand aside to cool. Beat half a cupful of butter to a cream; add one cupful of granulated sugar. Dissolve a teaspoonful of soda in two tablespoonfuls of water and add it to half a cupful of buttermilk or sour milk; add this to the batter; add two teaspoonfuls of cinnamon, half a teaspoonful of cloves and one egg well beaten. Sift two cupfuls of flour; add a little flour, a little of the dried apple mixture, and a little more flour until you have the whole well mixed. The batter must be the thickness of ordinary cake batter. Pour this into a well-greased cake pan, and bake in a moderate oven for one hour.

Humorous.

Every one notes that the passage of time seems now swift and now slow; but it is not given to every one to express his cognizance of this fact in Mrs. Herlihy's bewildering language.

"Sure, an' yisterday the hours was dragging at me heels as if they'd stoned tied to thim," remarked the good woman as she bent over the scrubbing-board, wrestling with Mr. Herlihy's one white shirt: "an' here's to-day they're galloping that fast it's mesilf can't even catch the tails av thim.

"Yisterday at this toime," she continued, after one fearful glance at the clock in the corner, "yisterday at this toime it was nowheres near half past tin, an' to-day it's all but twilve!"

Pope Leo X. Taking His Last Farewell of Raphael.

Very partial was Mother Nature to the "Prince of Painters." To his comprehensive and almost peerless genius was added a rare grace of person; a face almost feminine in its pensive beauty; a winning sweetness of manner; and, above all, the impulses of a large and noble heart, to which resentment and envy were strangers. When the works, in the Vatican, of several well-known artists were ordered to be removed in order to make room for his own, Raphael, with respectful love for his old master, besought that those of Perugino might be spared. Ignoring the hostility of Michael Angelo, Raphael expressed gratitude to Heaven that he was the contemporary of so great a man. We are told that "whenever any other painter, whether known to him or not, requested any design or assistance, of whatever kind, at his hands, he would invariably leave his work to do him service. He continually kept a large number of artists employed, all of whom he assisted and instructed, with an affection which was rather that of a father to his children than of an artist to artists. From these things it followed that he was never seen to go to court but surrounded and accompanied, as he left his

A Pharisee Rebuked.

In his latest book, "John Bull & Co." (Charles Webster & Co.), Max O'Rell tells this story about himself: I had just returned to the hotel after having given a lecture to the Scotch at the town hall. I was half undressed, when there came a knock at my bedroom door. It was a waiter bearing a card; one of the Christian ministers of the town wished to see me at once on a very urgent matter. I bid the waiter show the reverend gentleman up. A man of about fifty, in the usual black ecclesiastical coat and white cravat, and holding a soft felt hat, appeared in the doorway, wearing a sad face. I recognized him as one of my audience that evening.

"Excuse my costume," I began, "but you wished to speak to me on urgent business, and I thought best not to make you wait."

"There is nothing wrong with your dress," he broke in; "this is not any affair of the body, but of the soul. I have come to pray for you."

I was taken a little by surprise and felt a trifle discountenanced, but I quickly regained my composure. "Why, certainly," I said; "with the greatest of pleasure, if it can make you happy."

He knelt, put his elbows on the bed, buried his head in his hands, and began, "Lord, this man whom Thou seest near me is not a sinful man; he is suffering from the evil of the century; he has not been touched by Thy grace; he is a

stranger, come from a country where religion is turned to ridicule. Grant that his travels through our godly lands may bring him into the narrow way that leads to everlasting life."

The prayer, most of which I spare you, lasted at least ten minutes. When he had finished, my visitor rose and held out his hand. I shook it.

"And now," said I, "allow me to pray for you."

He signified consent by a movement of the hand. I did not go on my knees, but with all the fervor that is in me, I cried, "Lord, this man whom thou seest beside me, is not a sinful man. Have mercy upon him, for he is a Pharisee, who doubts not for one moment, and that without knowing me, that he is better than I. Thou who hath sent in vain Thy Son on earth to cast out the Pharisees, let thy grace descend upon this one; teach him that the foremost Christian virtue is charity, and that the greatest charity is that which teaches us that we are no better than our brethren. This man is blinded by pride; convince him, open his eyes, pity him, and forgive him, as I forgive him. Amen."

I looked at the good clergyman. He was rooted to the floor, amazement written on his face. I once more took his hand and shook it. "And now," said I, "we are quits. Good

night." He went away somewhat abashed, pocketing the mild reproof.

Young Old Women

You sometimes see a woman whose old age is as exquisite as was the perfect bloom of her youth, says Modes and Fabrics. You wonder how this has come about. You wonder how it is her life has been a long and happy one. Here are some of the reasons:

She knew how to forget disagreeable things. She mastered the art of saying pleasant things.

She made whatever work came to her congenial.

She retained her illusions, and did not believe all the world wicked and unkind.

How little it costs if we give it a thought.

To make happy some heart each day;

Just one kind word, or a sunny smile,

As we go on our daily way.

Perchance a look will suffice to clear

The cloud from a neighbor's face.

And the touch of a hand in sympathy

Removes the tear's sad trace.

—Mary D. Brine



(From the original painting by Pietro Michis.)

POPE LEO X. TAKING HIS LAST FAREWELL OF RAPHAEL.

"Did you see a man and a woman driving past here in a buggy about an hour ago?" asked a detective known to the Chicago Tribune.

"Yes," answered Mrs. Blank.

"Ah," said the detective, "now we are getting on the right track! What kind of a horse was it?"

"They were driving so fast I didn't notice that," replied Mrs. Blank. "But the woman had on a Scotch mohair and wool jacket of turquoise blue, last year's style, with stitched seams, a white pique skirt with deep circular flounce, a satin straw hat, tilted and rather flat, trimmed with hydrangeas and loops of pale blue surah, and her hair was done up pompadour. That's all I had time to see."

The Duke of Argyll was once travelling in a railway carriage with the Duke of Northumberland. At one of the stations a little commercial drummer entered. The three chatted familiarly until the train stopped at Alnwick Junction.

Here the Duke of Northumberland went out and was met by a train of flunkies and servants.

"That must be some great swell," remarked the drummer to his unknown companion.

"Yes," said the Duke of Argyll, "he is the Duke of Northumberland."

"Bless me!" exclaimed the drummer. "And to think he should have been so affable to two little snobs like us!"

It was hailing one day, and a little girl looked out of the window, and exclaimed: "O mamma, it is raining tiny little moth-balls!"

house, by some fifty painters, all men of ability and distinction, who attended him to give evidence of the honor in which they held him." So we see that Raphael was a prince of men, as well as a prince of artists; his heart, even more than his genius, commanded the homage of his fellows. Among his attached friends were popes, cardinals and nobles, as well as those in the lower walks of life. Popes Julius II. and Leo X. in turn betrayed for him an affection truly paternal. Stricken down after a brief illness, at the early age of thirty-seven, when his unrivalled powers seemed scarce yet to have attained their utmost reach, Raphael's death brought poignant grief to countless hearts, and was regarded as a calamity to his country and to art; and certainly none have risen equal to him, nor is there yet reason to hope that any ever will.

The last picture that he painted, and upon which he had not yet laid the finishing touches—"The Transfiguration"—is esteemed his greatest work, and, likewise, all things considered, the greatest of all paintings. The lamented artist was laid in state in the chamber in the Vatican in which he was accustomed to work, and beside him was placed his last and noblest creation. As he thus lies in the peaceful beauty of death, his venerable friend, Leo, comes to take his last adieu, and, truly, the Sovereign Pontiff never appeared more worthy of reverence than in the expression of his grief at the decease of his cherished young friend.

night." He went away somewhat abashed, pocketing the mild reproof.

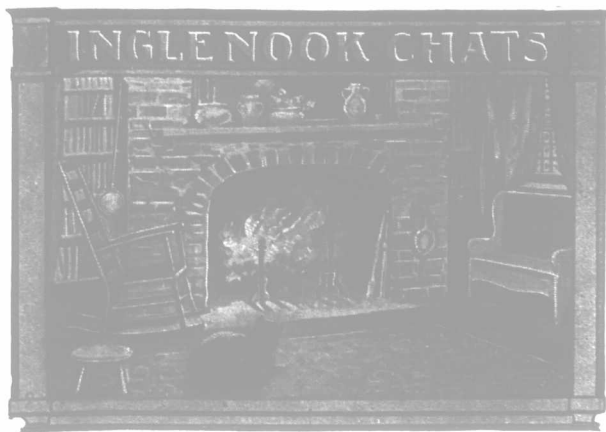

Earth's universal face, deep-hid and chill,
Is one wild dazzling waste that buries wide
The works of man."

How charmingly the poet Thomson, in his famous work, "The Seasons," portrays the first fall of snow, and what pleasure its coming bespeaks for our merry Canadian boys and girls; for is not winter the very season specially adapted to the gay sports of coasting, skating, hockey and curling? What dainty forms the fair snow-crystals assume in their downward flight! Speaking of them reminds me of my first visit, a few days ago, to a kindergarten school. "Kindergarten" is a German word, meaning "child garden," and truly such it seemed to me—a real little garden where children, instead of flowers, were cultivated. The teacher had drawn illustrations representing rain, a rose in bloom, a teakettle with steam issuing from it, a house half-hidden by mist, a boy skating, a snow-man, etc. All these were to illustrate the different forms of water: rain, dew, steam, fog, ice, snow, hail and sleet; by adroit questioning the teacher got the children to tell all they knew of each. Quaint little stories to attract and retain the attention of the tiny pupils (from four to six years of age) were interspersed all through the lesson. Then the teacher gave each child several tiny sticks with which they formed stars and snow-crystals. More sticks were given, and more

elaborate designs constructed, the children in the meantime being taught what squares, right and acute angles, triangles, etc., meant, and also to count all the sticks they had. A general air of good-nature pervaded everywhere, and it seemed to be all play instead of study. Then followed a recreation, the children choosing the games and the teacher taking part in them as merrily as any. Most of the games were played in time to singing or music. This was part of one day's work. In the kindergarten the children are also taught to make many pretty things with bright-colored paper, in every case some useful information being imparted in the most interesting manner, while habits of accuracy, order, neatness and the love of the beautiful are hourly inculcated. The happy, animated faces of these miniature men and women will long remain a pleasant memory.

The Hostess must beg the further indulgence of her Guests for not giving the result of the last contest (it will certainly appear next issue). She does not often have a holiday, and you can scarcely blame her for prolonging it, now can you?

Take another look at last issue and read the rules for the next Memory Gem contest, then send on your work. Address as given below, and have it reach Pakenham by Dec. 10.

THE HOSTESS.

Engle Nook Chats, Pakenham, Ont.

My dear Guests,—

"Through the hush'd air the whitening shower descends;

At first thin, wavering, till at last the flakes Fall broad, and wide and fast, dimming the day With a continual flow. The cherished fields Put on their winter robe of purest white. 'Tis brightness all; save where the new snow melts Along the mazy current. Low the woods Bow their hoar head, and ere the languid sun Faint from the west emits his evening ray

PARLOR SUITE FOR \$21.75

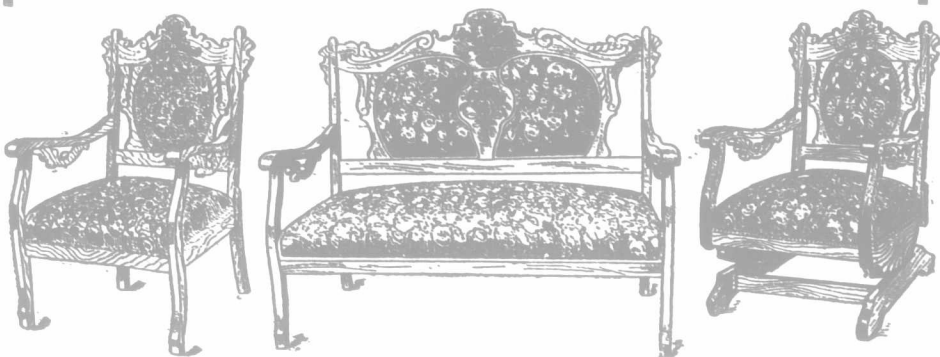

It's like presenting you with \$6.75 to give you this splendid Parlor Suite for \$21.75; our regular price is \$28.50. But to get more closely in touch with the readers of this paper, and to show them how easy and satisfactory it is to do shopping by mail with this store, we're willing

to make this special price on any orders sent to reach us before Christmas.

The Parlor Suite comprises five pieces, as shown in the cut. The frames are of a rich polished mahogany finish. They're upholstered, with full spring seat, and covered with a good velvet velour, which you may have in green, olive, brown or crimson color. (Samples of this covering will be mailed to you if you wish to see the quality.) Our own experts have done the upholstering, which is positive proof that the work has been well done in every detail. This suite is good value at \$28.50, but if ordered from us before Christmas, you can have it for **\$21.75**

Don't delay with your order. Send your money to our Mail Order Department, and tell them you saw the announcement in this paper. If you're not perfectly satisfied when you get the Parlor Suite, we'll refund your money.

THE T. EATON Co. LIMITED
190 YONGE STREET
TORONTO CANADA

GOSSIP.

A thick-fleshed, Scotch-topped Shorthorn bull calf, just over a year old, is advertised for sale in this issue by Mr. H. F. Whetter, London, Ont. He is nicely bred, too, being sired by one of Capt. T. E. Robson's Scotch-bred bulls of the favorite Miss Ramsden family.

CANADIAN HEREFORD BREEDERS.

The 12th annual meeting of the Association, for the report of business done, the election of officers and transaction of new business, will be held in Guelph, Ont., on Wednesday, December 10th, 1902, at 10.30 a. m., at the Royal Hotel.

UP-TO-DATE

TREAD POWER

For 1, 2 and 3 Horses,



WITH THOM'S IMPROVED STEEL TRACK AND QUICK-ACTING GOVERNORS.

In tread powers, feed cutters and grain grinders, we lead in all that is latest and best.

Originators and patentees of Thom's famous blower elevator feed cutters. Beware of imitations.

and infringements now being offered by unprincipled manufacturers. John K. Barr, Sarnia, T. S., writes: "It may interest you to know how I am getting along with your No. 16B machine. It is simply a wonderful machine. The feeder can put the corn out of sight as fast as two men can pass the sheaves. In one instance I held my watch while they put through four loads in 16 minutes, losing one minute changing wagons, using only 80 lbs. of steam, and easy work. More than 100 farmers have seen my machine work." We hold the record for largest capacity with least power. Send for testimonials and all desired information on latest improvements.

(Established 1875).

Thom's Implement Works, WATFORD, ONT.

NOTICES.

THE "SALADA" CEYLON TEA CO. has opened a branch in the Schepp building, corner Hudson and Duane Sts., New York City. The "Salada" Tea Co. now has branches at Toronto, Montreal, Boston, Buffalo, Detroit, Philadelphia, Pittsburg, Cleveland, New York, Washington, Newfoundland, Toledo, Wheeling, W. Va.

THE LOUDEN MACHINERY CO. are advertising some goods which farmers who know the value of modern conveniences should consider. Their feed and litter carrier cannot fail to be of great value in any cow stable. It is the most complete implement of its kind yet introduced. The same firm also manufacture hay carriers and barn-door hangers that give satisfaction.

TYPEWRITERS.—In another column will be seen an advertisement of Messrs. Newsome & Gilbert, of Toronto, sole dealers for the Smith Premier typewriters. Business men have no time to waste in experimenting with typewriters. They require one that is simple, durable and efficient. These qualities are special features of the Smith Premier. This firm now have on hand a complete stock of second-hand machines, and our readers who require a typewriter would do well to get their prices before purchasing elsewhere.

FIGHTING INSECT AND FUNGUS FOES.—The "Farmer's Advocate" the other day received a call from Mr. P. T. Merrill, of Leominster, Mass., representing the Bug Death Chemical Company, accompanied by Mr. E. A. Rogers, of Brunswick, Maine, an extensive grower of potatoes for seed and commercial purposes. Mr. Merrill reports the sale of Bug Death steadily increasing, not only for potatoes, etc., but for spraying fruit trees, being both an insecticide and a fungicide, and promoting a healthy growth of the plants. Mr. Rogers speaks strongly in its favor, claiming a larger yield of potatoes at a profit as compared with Paris green or arsenate of lead applications. It is also claimed to be less injurious to the foliage than Paris green.

HOME STUDY IN AGRICULTURE.—We would advise our readers interested in the subject of home study, now so popular—especially those desirous of taking a good course in agriculture—to look up the announcement of the Canada Correspondence College, Toronto, Ont., and write them at once for circulars containing full particulars. In doing so mention the "Farmer's Advocate." This school has a very competent staff of Canadian specialists.

GOSSIP.

SHORT COURSES AT GUELPH COLLEGE. See the announcement in our advertising columns of the dates for the short courses at the Ontario Agricultural College, at Guelph, in dairying, stock judging and poultry raising. Ladies are admitted to the dairy and poultry courses.

AUCTION SALE OF DAIRY CATTLE.

An important auction sale is that announced in our advertising columns of over 100 head of registered and high-grade Jersey cattle, besides Berkshire swine and Cotswold sheep, the property of Mr. J. L. Clark, of Norval, Ont., to take place at his "Lawridge" farm, on December 18th. This is the oldest herd of Jersey cattle in Ontario, having been founded some thirty years ago on imported stock, of strong constitution and great capacity for dairy work, first-class sires, selected for their individual merit and their breeding from deep-milking families, having been continuously used. The cows in this herd have always been noted for size and capacity of work, and as being heavy milkers, while the young stock, the progeny of the high-class stock bulls used, are of the most promising character. The two stock bulls included in the sale are among the very best of the breed both having been successful prizewinners and breeders. The grade cows to be sold are a strong, vigorous lot, heavy milkers and butter producers, as well as of good size. The location is easy of access from Norval station on the G. T. R., or the C. P. R. at Snelgrove or Brampton.

DOHERTY Organs



STYLE 170
A
PEERLESS PIANO
ORGAN

MADE IN THE
LARGEST
REED
ORGAN
FACTORY

UNDER THE
BRITISH FLAG

DOHERTY

CORRESPONDENCE SOLICITED

W. Doherty & Co'y,
CLINTON, ONT., CAN.

GOSSIP.

DALGETY'S NEW IMPORTATION.
A representative of the "Farmer's Advocate" recently had the pleasure of looking over the splendid new importation of Clydesdale stallions and mares lately received by Dalgety Bros., London, Ont., and now stabled at the Black Horse Hotel, Toronto, which he describes as follows: Sir Oswald, bred by Mr. Peter Crawford, Dargavel, Dumfries, winner of first prize at the Royal Northern at Aberdeen as a two-year-old, first at Glasgow Spring Stallion Show as a four-year-old. He won the Derwent Valley District premium of £60; also second at Royal Counties Show against all breeds; first at International Show, Paris, when six years old; also, the Landerdale District premium of £80. He is sired by Prince of Scotia, by Prince of Wales, and out of a McCamon mare. He is a brown horse, seventeen hands high, weighing 2,200 pounds. A horse of tremendous substance, coupled with an abundance of quality, standing on the best possible kind of feet and legs, and the section of country that gets him will be lucky indeed. County Squire was bred by James Stewart, Corscaplie, Dunblane. His winnings were, as a foal, first at Stirling, second at Doune, first at Dunblane, and first at Forteviot; first at Falkirk and Denny as both a yearling and a two-year-old. He is sired by Kippendavie Stamp, by Sir Everard; dam Madge Carruchan, by Prince of Carruchan. He is a dark bay, five years old, full of quality from the ground up, and an extra good mover, one of the close-coupled, smooth, full-muscled horses, with A1 feet and legs. Prince of Cowal, bred by Mrs. Lamont, Killellan, Twoard, was winner of first as a yearling at Butte Show in 1899. As a two-year-old he tied for the Glasgow junior premium, and on the same day he stood fourth in the open class. He is sired by Gallant Prince, dam Bell II, of Killellan, by Top Gallant. He is a dark bay, five years old, weighs 2,400 pounds, and, all around, is no doubt one of the best horses that ever crossed the Atlantic, for besides his royal breeding, his individuality is as nearly perfect as possible. Prince of Knockann is a big, stylish three-year-old, sired by Balmedie Prince Charming. He is also a prizewinner, has great substance and a fair share of quality for a horse of his stamp, and when developed and finished, will be hard to turn under in any company. Another big, strapping three-year-old is Britannic, sired by Prince Sturdy, and out of a Prince of Wales mare; grandam by Darnley. This colt also shows plenty of substance and quality, and will make something extra. Linns Prince was bred by Mr. Methews, Linns, Dumfries. He is a two-year-old bay, with white points. An exceptionally big, growthy colt, showing a depth of girth and strength of loin rarely seen in one so young, is graced with a perfect set of legs and feet, and can move some, too. Baron Lawrence is a massive black horse who has won first prizes galore, and were a man to set up a Clydesdale ideal he would find it in this horse. He is sired by the great Baron's Pride, and had the Cuper premium last year. Baron Dunraven, by the great Hiawatha, is one of the grandest three-year-olds it has ever been our privilege to look over. Size, quality, style, action, symmetry, bone, he has them all, and, with a bit more finish, can win in any ring. Royal Blantyre is sired by the Cawdor Cup winner, Prince of Carruchan; dam Hatton Beauty. He is a brown horse, seven years old, and is also a prizewinner of note and the sire of some very choice animals. He is a horse choke-full of quality, with beautiful, hard, flat bone, and the action of a hackney, very strong loined, well-sprung rib, and close coupled—altogether an exceptionally handsome animal. Lord Wellwood is a two-year-old, by the champion horse, Royal Carrick. He is a winner of three prizes at the Butte Show, is a very compact horse, full of quality, with the best of feet and legs; not over large, but a very sweet-turned animal, and shows splendid action. Montrose Chief is a big two-year-old brown, sired by Lord Fautleroy; dam Susie of New Bigging, by Gazelle, and although a little shaken up with the voyage, is the making of something extra good, as he is possessed of size, conformation style, and a fair share of quality. Harry's Pride is another two-year-old, a bay; one of the coming horses, combining size and quality to a marked degree, and splendid action. He is sired by Boreland's Pride; dam Bell, by Mackenzie. Ruling Elder is also two years old; a grand type of dray horse, showing a powerful development of muscle, heavy loin, broad, full chest, grand bone, a fair share of quality, and the making of a 2,200 or 2,300 pound horse. He is sired by Prince Regnant; dam Minnie, by Machelth. In fillies, there are three, all of them three years old, big, powerful mares, with strong, flat bone, and combining size with quality, and are show animals. They are Marchioness 5th, by Robin Oig, dam by Prince of Wales;

A Golden Rule of Agriculture:

Be good to your land and your crop will be good. Plenty of

Potash

in the fertilizer spells quality and quantity in the harvest. Write us and we will send you, free, by next mail, our money winning books.

GERMAN KALI WORKS,
93 Nassau Street,
New York.

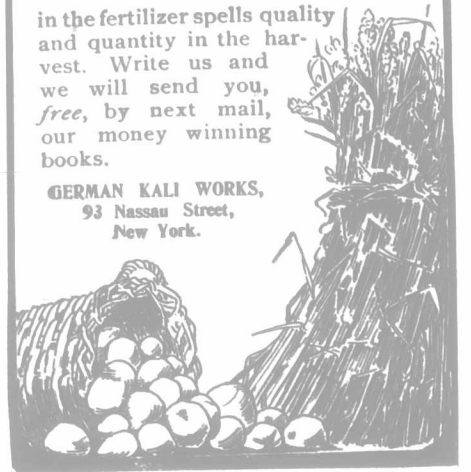

HOME STUDY BY MAIL

A college education for every man and woman in Canada. HOME STUDY IS FOR YOU. It saves time and money. Educate your family. Cheap thorough, practical courses in HIGH SCHOOL and BUSINESS STUDIES, HOUSEHOLD, INDUSTRIAL and AGRICULTURAL SCIENCE. DO YOU WISH TO MAKE MONEY? Agents wanted. FREE booklet. Canadian Correspondence College, Limited, TORONTO, ONTARIO.

Begonia, by Leading Article, dam by Lord Ailsa; and Captain's Alexandra, a filly that possesses more than her share of quality, substance, style and action.

BOOK REVIEW.

Any book reviewed in this department may be ordered through this office, at the price stated.

A book of more than ordinary interest and value is that by Albert F. Elvissell, M. D., entitled, "How to Keep Well," published by Ginn & Co., Boston. Although it is designed as a text-book of health for use in the lower grades of schools, there are lessons in it that anyone might learn. The fundamental principles of anatomy and physiology are presented in such a way as to make their study attractive and interesting. The main facts are there, so arranged that a child may understand. A specially interesting chapter is the one on the five gateways of knowledge, or the five special senses, i. e., touch, taste, smell, hearing, and sight. Altogether there are eleven chapters, making a handsome volume of 250 pages, nicely bound in cardboard and handsomely illustrated. The price is only 45 cents.

"EAST AND WEST."—We are pleased to receive a copy of the new illustrated weekly, "East and West," issued by the Presbyterian Church. Its field is among the Sunday-school publications of the Church, and it is a paper to be commended for young Canadians. It keeps Canadian and British ideals to the front and is refreshing and wholesome compared with a lot of the frothy current literature from the States that occasionally finds its way across the lines and which should be excluded from Canadian homes. It is well printed and illustrated and contains articles instructive and entertaining, from the best of Canadian writers. Rev. R. Douglas Fraser, M. A., Toronto, is the editor and manager.

GOSSIP.

Messrs. D. C. Flatt & Son write to the "Farmer's Advocate" as follows: "Our new importation of Yorkshires arrived home on 24th of November. They are an excellent lot of the right sort, among them being some grand young boars ready for use; also, some gilts fit to breed. We are offering the whole importation at reasonable prices, and we ask those who are in need of good stock or new blood to write us or come and make their own selections."

CANADIAN WHITE WYANDOTTE CLUB.

The meeting for the inauguration of a Canadian White Wyandotte Club will be held in the Council Chamber, Guelph, at ten o'clock Wednesday morning, December 10th, when it is hoped that a large number will interest themselves in the organization.

Combination Shorthorn Sale!

A combination sale of Shorthorn cattle will be held in the
Sale Pavillon of the Hamilton Stock-yards Company,
IN THE

City of Hamilton, Ontario, on January 21st, 1903,

When about 60 head of high-class Shorthorns, contributed by a number of breeders, will be offered. Look for particulars in future issues of the "Farmer's Advocate."
W. D. FLATT, - - - HAMILTON, ONT.

DISPERSION SALE!

ALEX. LOVE, EAGLE, ONT., will sell by public auction, on

JANUARY 22, 1903,

his entire herd of Scotch Shorthorns—38 head. Catalogues ready December 20th.

IMPORTANT SALE

OF
OVER 100 HEAD OF REGISTERED AND HIGH-GRADE

Jersey Cattle

ALSO
BERKSHIRE SWINE and COTSWOLD SHEEP,

The property of J. L. Clark, will be held at "Lawnridge" Farm (situated 2 miles from Norval Station, G. T. R., and 4 miles from Snelgrove, C. P. R.), on

Thursday, December 18, 1902.

The herd includes 50 cows and heifers, milking, majority of which are fresh; a choice lot of young heifers in calf, heifer calves, 4 young bulls, and the two stock bulls, Pride of Alton 4504, A. J. C. C., a grandson of Stoke Prgis 5th, and traces to Sweet Briar of St. Lambert (test 22 pounds 10 ounces), Lily of St. Lambert, dam of four cows testing 16 to 22 pounds, and Eurotas (778 pounds in 11 months), dam of Pedro, 1st prize at World's Fair; and King of Beechlands 53896, grandson of Adelaide of St. Lambert, who holds the world's record of the breed for milk production. A De Laval separator, Abell tread power, and other dairy utensils. No reserve, as the proprietor is going out of the dairy business.
Trains from the east and west will be met at Norval (G. T. R.), and from the north and south at Snelgrove (C. P. R.).
TERMS.—\$10 and under, cash; over that amount, 10 months' credit on approved security.

SALE TO COMMENCE AT 12 NOON. LUNCH AT 11.

Further information may be had by applying to

J. L. CLARK, Norval, or to JOHN SMITH, Auctioneer, Brampton.

CURES PILES

Without Cutting, Danger or Detention from Work, by a Simple Home Remedy.

A Priceless Book Sent Free for the Asking.

Pyramid Pile Cure gives instant relief and never fails to cure every form of this most troublesome disease. For sale by all druggists at 50c. a package. Thousands have been quickly cured. Ask your druggist for a package of Pyramid Pile Cure, or write for our little book which tells all about the cause and cure of piles. Write your name and address plainly on a postal card, mail to the Pyramid Drug Co., Marshall, Mich., and you will receive the book by return mail.—Adv't.

ONTARIO PROVINCIAL WINTER FAIR

A combination exhibition of both Live and Dressed Cattle, Sheep, Swine, and Poultry; also a Dairy Show.

Will be held at

GUELPH, ONT.,
December 8 to 12, 1902

Over \$7,000 offered in prizes.

Live-stock entries close November 22nd.
Poultry entries close November 24th.

Experts will deliver practical lectures on interesting Live-stock, Poultry and Dairy topics.

Increased accommodations this year for the convenience and comfort of visitors, exhibitors and their exhibits.

RAILWAY RATES:

SINGLE FAIR FROM ALL POINTS.

For prize list, entry form, and any further information, apply to

A. W. SMITH, President,
Maple Lodge, Ont.
A. P. WESTERVELT, Secretary,
Parliament Buildings,
TORONTO, ONT.

Private Creamery Outfit FOR SALE

In first-class working order. One Russian separator, capacity 800 to 1,000 pounds per hour. One cream vat, modern. One hundred-gallon churn, square. Also a two-horse tread power will be sold with above or separate. This machinery will handle profitably the milk of from 15 to 75 cows. Apply to

W. F. W. FISHER, BURLINGTON, ONT.

PLEASE MENTION FARMER'S ADVOCATE.

FREE COLUMBIAN WITH 5 PHONOGRAPH RECORDS

This genuine Columbia Phonograph reproduces Song, Speeches, national institutions, instrumental selections, etc., in a most life-like manner. We give it complete with five up-to-date records, for selling at 15c. each only 1 doz. Canadian Home Cook Books and getting 3 of your friends to do the same, or 2nd for selling in all only 2 doz. yourself. These books are nicely printed, beautifully bound and each contains 739 choice recipes. Write to-day and we will send you the Cook Books postpaid. You can easily sell them in a few minutes. **Every House-keeper buys one.** Home Specialty Co., Dept. 574 Toronto

FUR SCARF FREE
Soft, warm, glossy black 3 best 6 inches by 2 1/2 in. wide, made of selected full fur skins with 6 fine tall black tails. A hand-ome stylish fur given 1st for selling at 15c. each only 7 1/2 doz. gold finished Scarf Pins and securing 3 other agents to do the same, or 2nd, for selling in all only 14 doz. yourself. These Pins come in 4 styles: a Deer's Head with a brilliant gem set between the antlers, a subtle Butterfly with an Electric Diamond, a Tortoise shell with a superb Pearl, and a most precious stone, and an Owl holding a rainbow tinted O. in its claws. These Pins are equal to anything sold by jewelers at \$1.00. At our price, 15c., you can sell dozens in a few moments. Write to-day and we will send the Scarf Pins postpaid. **THE NATIONAL JEWELRY CO., DEPT. 562 TORONTO.**

Violin and Case

\$10.00 GRAND CONCERT VIOLIN FOR \$2.95

Now, tuning pipe, extra strings and Instructor Free. SEND NO MONEY, just your name and nearest Express Office, and we will send this high-grade Violin there for examination. When it arrives, call and examine it thoroughly, and when satisfied that it is equal in every respect to Violins sold regularly for \$10.00, pay Express Agent our special price, \$2.95, and express charges, and secure the biggest and grandest bargain ever seen or heard of. This is a genuine Stradivarius model violin, made of selected wood with highly polished top, inlaid edges and ebony finished trimmings, a splendid, clear-toned instrument of remarkable power and sweetness. Handsome, highly polished, black Violin Case, with brass trimmings and pockets for fittings, only \$1.15 extra. Order to-day. **JOHNSTON & CO., BOX 548, TORONTO.**

GOSSIP.

Mr. Jas. A. Russell, Precious Corners, Ont., in writing to the "Farmer's Advocate," says: "I have had good success in getting sales for Yorkshires through my advertisement in your paper. I have shipped one and sometimes two every week at fair prices for the last three months, and have received flattering replies from purchasers, stating that they were extra well pleased. The boars and sows which I am now advertising are all by boars of extra quality, from imported stock. They are lengthy and smooth, and if development at the present rate be continued they will make first-class show animals as well as breeders."

GOODFELLOW BROS.' SHORTHORNS AND COTSWOLDS.

Oak Lane stock farm lies in Peel County, Ont., two miles west of the town of Bolton, on the C. P. R., and is the property of Goodfellow Bros., of Macville, breeders of high-class Scotch Shorthorn cattle and Cotswold sheep. The herd now numbers about thirty head, fully half of which are imported or bred directly from imported stock, and among them are a number of prize-winners at Toronto, London, and several other leading shows. This magnificent herd is represented by such noted families as Jessamines, Golden Drops, Marr Roan Ladies, Lavenders, Cecelias, Mysies, Stamfords, Wantons and Lady Janes, at the head of which is the beautifully-moulded and royally-bred bull, Imp. Famous Pride, bred by Geo. Campbell, Harthill; sired by Golden Fame; dam Fanny 2nd, by Financier; grandam Fanny, by British Leader. This bull shows muscular development, even build and a heart-girth combined with a quality of touch and finish that stamps him at once as a show bull, which he certainly is. A few of the imported cows breeding are as follows: Watercress (imp.), bred by James Thompson, Balbegno, Scotland; sired by the Marr Missie bull, Marshfield, by William of Orange; dam Wilful 4th, by Marshfield. She is a roan three-year-old, and won second at Toronto and first at London. Her seventeen-months-old daughter, Water Lily, by Count Joyful 74294, won first and gold medal in junior yearling class at Toronto and first at London. Orange Blossom 2nd (imp.), bred by John Young, Tilbouries, Scotland, sired by Scottish Prince, by Captain Ripley; dam Orange Blossom, by Remus, is a roan and belongs to the well-known Marr Roan Lady family. Lovatt's Lass (imp.), bred by J. H. Davidson, Old Hall, Scotland; sired by Lovatt's Chief, by Merry Archer; dam Proud Mint, by Ambitious Monarch, is a red cow, and is now in calf to the Missie bull, Conqueror's Crown. Buchan Lass (imp.), bred by Alex. Moir, Waterton, Scotland; sire Pride of Fashion, by Pride of Morning, dam Jessamine 5th, by Royal James, is an extra choice roan, and has an eight-months-old roan bull calf, Favorite (imp.), sired by Golden Fame, by Lord of Fame. This is an exceptionally good calf, and one of the kind so eagerly looked for. Lavender 41st (imp.) is sired by the Duchess of Gloster bull, Dunblane, by Roan Gauntlet; dam Lavender 28th, by the Brawith Bud bull, Lord of the Isles. Lady Fragrance 9th (imp.), bred by John L. Reid, Crombybank; sired by Lochnagar; dam Lady Fragrance 7th, by Cherry Duke, is a rich roan and above the average in form and finish. Tilbouries Fancy (imp.), bred by John Young, Tilbouries, Scotland; sired by Scottish Prince; dam Rothnick Fancy, by Solitaire, is another good one. Among the many good Canadian-bred ones, special mention should be made of the eight-months-old heifer, winner of first at Toronto in the junior calf class and third at London under one year. She belongs to the Stamford family, and is sired by Golden Fame; dam Cecelia Colville 2nd, by Imp. Indian Chief. Lady Primrose, Vol. 19, is a one-year-old heifer that was also a winner at London. Space will not allow of further description. Suffice it to say Oak Lane herd is one of the best in Canada. The animals are all in the pink of condition, and there is nothing reserved, everything being for sale, including the following choice bulls: Shining Light 38920, by Grand Gloster 23774; dam Pansy Ray 29822, by Imp. Indian Chief. This bull won first prize at Toronto in the year-old class and first and sweepstakes at London. Gipsy Lad 23916 is a two-year-old, by Grand Gloster; dam Gipsy Maid 29819, by Imp. Golden Crown. Imp. Golden Fame 2nd is another thirteen-months-old bull, bred by S. Campbell, Kinellar, sire Golden Fame, dam Jessie by Merlin 2nd. He is a big, sappy bull, very deep and thick. In writing Goodfellow Bros., address them to Macville P. O., Ont.

Agricultural College

- (1) Three Weeks' Creamery Course—Dec. 1, 1902.
- (2) Twelve Weeks' Dairy Course—Jan. 2, 1903.
- (3) Two Weeks' Course in Stock and Grain Judging—Jan. 8, 1903.
- (4) Four Weeks' Course in Poultry Raising—Jan. 9, 1903.

Ladies admitted to Dairy and Poultry Courses.

Send for special circulars.

JAMES MILLS, M. A., President.

Guelph, November, 1902.

FREE 97-PIECE DINNER AND TEA SET

full size for family use, made of the finest ware, in the very latest shapes and latest designs suitable for any table. The decorations are clear and distinct, delicate in design, and the whole set is stylish, beautiful and artistic; a set that will give you lasting pleasure because it will stand the wear of years, the colors never losing their brilliancy. This elegant set consists of 12 Dinner Plates, 12 Tea Plates, 12 Soup Plates, 12 Cups, 12 Saucers, 12 Fruit Saucers, 12 Butter Pads, 2 Vegetable Dishes, 2 Covers, 1 10-inch Meat Platter, 1 14-inch Meat Platter, 1 Gravy Boat, 1 Tea Pot and cover, 1 Sugar Bowl and cover, 1 Creamer and 1 Slop Bowl, in all 97 full size pieces, all light in weight, perfect in color, extra smooth, and for beauty and richness equal to any Dinner Set ever sold at retail for less than \$35.00. We give it free for doing 3 things—(1) Selling at 15c. each only 3 doz. handsome pieces of Jewelry: Lockets, Cuff Links, Stick Pins, Brooches, etc.; (2) getting 3 more agents to do the same, or by selling 6 doz. yourself. Every piece of our Jewelry looks worth 50c. Miss Jno. Powless, Danzmore, Ont., says: "The plates are most beautiful and I am so well pleased with them that I do not know how to thank you. The neighbors all think they are grand and my husband is delighted with them." If you have longed to possess a handsome set of dishes but yet felt hardly able to afford one, here is your chance to get one free. Write to-day and we will send the Jewelry postpaid. The National Watch and Jewelry Co., Dept. 572, Toronto.

LADY'S OR GENT'S FREE \$40.00 BICYCLE

Brand new, Lady's or Gent's 1902 model. Not one cent to pay. All we ask is a little of your time. A real Bicycle, High Grade, Brand new, with every up-to-date feature—best seamless steel tubing, finely enamelled diamond frame, all other metal parts made from best steel, well finished and handsomely nickel plated; good pneumatic tires, rock elm rims, bar steel hubs, improved saddle, new style handle bars, etc. High grade ball bearing throughout—in fact a regular \$40.00 Bicycle free, for doing two things: (1) Selling only 3 doz. packages of delicious Lemon, Vanilla and Almond Flavoring Powders, at 15c. each, (2) getting 3 other agents to do the same, or by selling 6 doz. yourself. Our 10c. packages of Flavoring Powders are equal to 25c. worth of liquid flavoring and are far better. Every house-keeper buys one or more. This handsome set will not cost you one cent. All the 97 pieces are full size for family use. We trust you will write to-day and we will send you the same. Don't miss this chance. **THE HOME ART CO., DEPT. 560, TORONTO, ONT.**

97 PIECES FREE DINNER AND TEA SET

Beautifully decorated English China, 12 Dinner Plates, 12 Tea Plates, 12 Soup Plates, 12 Saucers, 12 Fruit Saucers, 12 Butter Pads, 2 Vegetable Dishes, 2 Covers, 1 10-inch Meat Platter, 1 14-inch Meat Platter, 1 Gravy Boat, 1 Tea Pot and Cover, 1 Sugar Bowl and Cover, 1 Creamer and 1 Slop Bowl, in all 97 full size pieces of handsome decorated China given away for doing two things: (1) Selling only 3 doz. packages of delicious Lemon, Vanilla and Almond Flavoring Powders, at 15c. each, (2) getting 3 other agents to do the same, or by selling 6 doz. yourself. Our 10c. packages of Flavoring Powders are equal to 25c. worth of liquid flavoring and are far better. Every house-keeper buys one or more. This handsome set will not cost you one cent. All the 97 pieces are full size for family use. We trust you will write to-day and we will send you the same. Don't miss this chance. **THE HOME ART CO., DEPT. 560, TORONTO, ONT.**

40-PIECE TEA SET FREE 40-Piece China Tea Set—12 Cups, 12 Saucers, 12 Tea Plates, 2 Cake Plates, 1 Creamer and 1 Slop Bowl. Beautiful white porcelain ware, newest pattern, elegantly decorated. A regular \$5.00 set. Given for selling at 15c. each only 14 doz. Gold finished Scarf Pins and securing 3 other agents to do the same, or 2nd, for selling in all only 14 doz. yourself. These Pins come in 4 styles: a Deer's Head with a brilliant gem set between the antlers, a subtle Butterfly with an Electric Diamond, a Tortoise shell with a superb Pearl, and a most precious stone, and an Owl holding a rainbow tinted O. in its claws. These Pins are equal to anything sold by jewelers at \$1.00. At our price, 15c., you can sell dozens in a few minutes. Write to-day and we will send the Scarf Pins postpaid. **NATIONAL JEWELRY CO., DEPT. 578, TORONTO.**

Violin and Case

\$10.00 GRAND CONCERT VIOLIN FOR \$2.95

Now, tuning pipe, extra strings and Instructor Free. SEND NO MONEY, just your name and nearest Express Office, and we will send this high-grade Violin there for examination. When it arrives, call and examine it thoroughly, and when satisfied that it is equal in every respect to Violins sold regularly for \$10.00, pay Express Agent our special price, \$2.95, and express charges, and secure the biggest and grandest bargain ever seen or heard of. This is a genuine Stradivarius model violin, made of selected wood with highly polished top, inlaid edges and ebony finished trimmings, a splendid, clear-toned instrument of remarkable power and sweetness. Handsome, highly polished, black Violin Case, with brass trimmings and pockets for fittings, only \$1.15 extra. Order to-day. **JOHNSTON & CO., BOX 548, TORONTO.**



The World's Regulator

Nearly ten million Elgin watches act as one great pendulum in regulating the hours of business, travel and pleasure the world over. Every

ELGIN Watch

is made of the finest materials by the most skilled hands.

Always look for the watch word "Elgin," engraved on the works of the world's best watches. Send for free booklet about watches.

ELGIN NATIONAL WATCH CO., Elgin, Ill.

GOSSIP.

The fourteenth annual meeting of the American Leicester Breeders' Association will be held in the Council Chamber of the City Hall, Guelph, Ontario, December 11th, 1902, at 9.30 a. m. A. J. Temple, Secretary.

Mr. Alex. Love, of Eagle, Elgin Co., Ont., announces in this issue the public sale of his fine herd of thirty-eight head of Shorthorns, on January 22nd 1902. Owing to the death of his wife, Mr. Love has decided to sell his entire herd, and this will be a splendid opportunity for those desiring to invest in first-class Scotch-bred Shorthorns. See advertisement, and send for catalogue.

Three and one half miles north of Owen Sound, in the County of Grey, lies Maple Grange stock farm, the property of Mr. R. J. Doyle, breeder of Shorthorn cattle. This beautiful farm is situated on the shores of Georgian Bay, which it overlooks. On the farm are built commodious and well-arranged barns, with full-sized basement fitted up on the most modern plans, with row after row of tie and box stalls, in which are housed a splendid herd of 50 head of pure-bred Shorthorns, at the head of which is the typically-formed and richly-bred stock bull, Imp. Golden Abel, bred by R. Napier, Boydnie, Scotland; sired by the noted bull, Golden Fame (76786), by Lord of Fame; dam Annabella, by Watchman, by Watchword. He is a red-one of the very thick, short-legged kind, and a soft, mossy hander. His predecessor was the superior stock-getter, Commodore 31025, by Imp. Clan Campbell, a bull that did Mr. Doyle grand service, leaving his calves very low and thick. Another bull that has been used quite extensively on the herd is Imp. Baron's Heir, a bull that has also done signal service to the herd. Quite a number of the females of the herd were sired by Scottish Bard, a Dryden-bred bull, and one whose equal as a sire of up-to-date animals were few and far between. A large majority of the cows belong to the well and favorably known Lavina family, a family that not only possesses the true Shorthorn form but are especially noted for their great milking qualities. There are a few Beautys and Clarets. The foundation cow of the latter is Imp. Crissy, bred by A. Campbell, Deystone, Scotland; sired by Kintore Hero; dam Crocus, by the great Clan Alpine. There is also a splendid two-year-old heifer out of her, Narcissus, sired by Commodore, and a ten-months-old bull calf, Pure Gold, sired by Imp. Baron's Heir. This youngster is the making of something good, and from his rich breeding will make a valuable herd-header for some man. All told, there are about 18 heifers, from one to two years old, sired by the above named bulls, some of them in calf to the stock bull; a good, even, well-balanced lot; and about a dozen bulls from ten to eighteen months old, among which can be picked some superior-typed, short-legged, thick, evenly-built animals. These youngsters, both male and female, are all for sale, together with a number of older females, and should go quickly at the prices asked. Mr. Doyle is one of the pushing young men of whom we, as Canadians, are justly proud, and having made up his mind to establish a herd of Shorthorns second to none, and being possessed of plenty of the needful, with push, energy and intelligence, we look for great things from him in the future. For prices, etc., write Mr. Doyle, to Owen Sound P. O., which is on the G. T. and C. P. R., and one of the main ports of Georgian Bay navigation.

Death by Neglect.

Dr. D. M. Bye, the eminent specialist, of Indianapolis, says thousands of persons die from cancer every year from no cause save neglect. If taken in time not one case in a thousand need be fatal. The fear of the knife or the dread of the burning, torturing plaster causes a few to neglect themselves till they pass the fatal point where a cure is impossible, but by far the greater portion die because their friends or relatives on whom they are dependent are insensible to their sufferings and impending danger till it is too late. Book sent free, giving particulars and prices of Oils. Address Dr. D. M. Bye, Drawer 505, Indianapolis, Ind.—Advt.

Poultry and Eggs Wanted

CHICKENS Empty crates forwarded on application.
DUCKS Highest market prices paid.
TURKEYS Correspondence solicited.
GEESE

Toronto Poultry and Produce Co.
OFFICE: 740 YONGE ST., TORONTO.

EGGS FOR HATCHING
Barred Rocks (exclusively). From two pens headed by two imported cockerels bred from a \$75 trio of A. C. Hawk's Royal Blue strain; \$1.00 per setting of 13. A. E. SHEERINGTON, Box 100, Walkerton.

Maple Grove Barred Rocks. A special offering of extra choice cockerels and pullets. Can give pairs or trios not akin. Also extra choice White Leghorns at living prices. E. BOLLETT, Cassel, Ont.

Mammoth Bronze Turkeys. A choice lot of young birds sired by imported toms. Pairs and trios mated, not akin. Shropshire sheep and Chester White swine. Write for prices. Wm. E. Wright, Glanworth P.O., Ont. "SUNNYSIDE STOCK FARM."

Mountain View Stock Farm & Poultry Yards has for sale Toulouse geese, Pekin ducks, Buff Leghorns, and Partridge Cockerel cockerels, prizewinners. Prices on application to ANDREW GILMORE, Athelstan, Que.

FOR SALE: 100 Mammoth Bronze Turkeys sired by 43-lb. imported tom. Also a choice lot of White Wyandottes and Black Minorcas. R. G. ROSE, Glanworth, Ont.

Poultry Paper Free

Your name and address on a postal card mailed to **Reliable Poultry Journal**, Box V, Quincy, Illinois, will bring you a free sample copy of the biggest and best Poultry Journal published. Over one hundred pages. **\$500 CASH PRIZES**—Everybody gets paid—Write for full particulars. **A Big Thing For Subscription Agents.**

The Sure Hatch's Latest
An automatic, direct acting regulator that surpasses any other improvement ever made in incubators. Send for new illustrated catalog and free trial offer. **SURE HATCH INCUBATOR CO.** Clay Center, Neb., or Columbus, Ohio.

FOR SALE:

Clydesdale Stallions

Also two aged Clydesdale stallions. Also one very fine young Hackney stallion, winner of first and sweepstakes prizes. At very low prices. Write for particulars and prices to

ROBERT DAVIES,
TODMORDEN, ONTARIO.

OR CITY ADDRESS, om
34 Toronto Street, Toronto, Ontario.

NOTICES.

A PRIVATE CREAMERY OUTFIT, including cream separator and two-horse tread power, is offered for sale in an advertisement in this issue by W. F. H. Fisher, Burlington, Ont.

"A B C"—The Massey-Harris Co., with an eye to the business of the future, have issued an A B C booklet for the little folks, illustrating their farm machinery. We notice that this firm have just received an order for 3,000 sets of harrows for South Africa.

COMFORTS belong to no man more than to the farmer. He labors to earn them and by him they should be enjoyed. No farm home is complete without a parlor properly furnished. It costs but little to secure the necessary furniture. The T. Eaton Co., Toronto, are offering, in another column, a beautiful suite at the remarkably low price of \$21.75. It comprises five pieces, with frames of rich polished mahogany finish, full spring seat, and covered with a good velvet velour, which may be had in almost any color. The money may be sent by mail, and if the purchaser is not satisfied when the goods arrive, the price will be refunded. Nothing could be fairer than this.

GOSSIP.

WINTER FAIR PROGRAMME.

A provisional programme for the Provincial Winter Fair, at Guelph, December 8th to 12th, has been prepared by Secretary Westervelt. Judging will commence Tuesday morning. The various sessions are devoted to one particular subject, so far as the lectures and discussions are concerned, as follows: Tuesday afternoon, bacon hogs; evening, public meeting; Wednesday afternoon, sheep and export cattle; Thursday morning, poultry; afternoon, bacon carcasses; evening, dairy cattle; Friday morning, sheep and cattle carcasses; afternoon, chicken plucking contest, and sale of all carcasses. Word has been received that Prof. C. F. Curtiss, successor to Secretary Wilson as director of the Iowa State Agricultural College, and Mr. Arch. MacNeillage, editor of the Scottish Farmer, of Glasgow, Scotland, will be present to take part in the proceedings. The annual meeting of the Ontario Agricultural and Experimental Union will be held at the Agricultural College, Dec. 8th and 9th, commencing at 1.30 p. m. on the 8th. The meetings are all free to the public. Single fare tickets from Kingston and west will be sold any time between Dec. 7th and 12th, good to return till Dec. 15th.

CLYDESDALES

FOR SALE.



Fifteen Clydesdale stallions, 9 of them imported, 4 of them are by the renowned sire, Baron's Pride. I also have a number of mares and fillies for sale.

O. SORBY, GUELPH, ONTARIO

Belgian Stallions

Just imported, the finest lot of draft horses that ever came to Canada. For sale:

EIGHT BELGIAN STALLIONS

Fully registered; immense size and wonderful action, ranging from 1,700 to 2,200 pounds; all dark colored. All broken to harness. Can pull easy from a road-cart to a six-story house. Don't mistake for the clumsy, sleepy Clyde. Extra short back, splendid high feet; no long hair on legs to be bothered with. The Belgian draft horse awarded the first prize at the Paris Exhibition, 1900, beating everything in that class, including Clydes and Percherons—beaten at their own home. Visitors cordially invited. Correspondence solicited.

"BARON DE CHAMPLouis,"

Proprietor, Importer,
DANVILLE, QUEBEC.

CLYDESDALES

AYRSHIRES and
POULTRY.



R. Ness & Sons, Howick, Que.

importers of Clyde, Percheron and Hackney stallions, Ayrshire cattle, and poultry, have for sale 5 Clyde stallions, sired by Baron's Pride, Sir Everitt, and Royal Carrick, 1 Percheron, and 1 Hackney, winners. Ayrshires of both sexes, and poultry.

\$3 a Day Sure

Send us your address and we will show you how to make \$3 a day absolutely sure; we furnish the work and teach you free; you work in the locality where you live. Send us your address and we will explain the business fully; remember we guarantee a clear profit of \$3 for every day's work, absolutely sure, write at once. IMPERIAL SILVERWARE CO., Box 603, WINDSOR, ONT.

GRAHAM BROS.' GREAT STUD.

Seeing is Believing.



Come to our stables and see 15 Clyde stallions weighing 15 tons, of the best quality, action and color. We also represent the best Hackney blood in America.

GRAHAM BROS.,
CLAREMONT, ONT.

Truman's Pioneer Stud Farm

BUSHNELL, ILL.,

Has for 24 YEARS been headquarters for the CHOICEST

SHIRE, PERCHERON, SUFFOLK AND HACKNEY STALLIONS.

Sixth importation for this season received November 10th.

20 to 30 Good Practical Salesmen Wanted

Best lot of draft stallions in the United States or Canada. Notwithstanding the superior quality of our horses, it is a fact that our prices are lower than can be obtained elsewhere in America. If there is no first-class stallion in your neighborhood please write us. For our 24th annual catalogue, etc., address

J. G. TRUMAN, MANAGER,
BUSHNELL, ILL.

Dalgety Bros.

LONDON, ONT.,

Largest Importers of Horses in Canada.

OUR third consignment for this year of stallions and fillies is now on the ocean, and will be at the

Black Horse Hotel, Toronto,

on and after Monday, November 24th. Come quick, if you want a good one.

DALGETY BROS., LONDON, ONT.

International Importing Barn, Sarnia, Ontario.

J. B. HOGATE, PROPRIETOR.

IMPORTER OF

Clydesdale and Shire Stallions, and Spanish Jacks.

My third importation within the last fourteen months arrived Sept. 4th.

I select every one myself, and it is conceded both in Europe and America that I do get the best ones that cross the Atlantic to America. My stallions are sired by the leading sires of Scotland; ages from two to four years. The Jacks are direct from Spain, and registered, two to four years old, 14 to 15 hands high. I pay cash for my stock. I buy where I can get the best. Write for particulars. Will save you money. Mention this paper when you write.

H. H. CALISTER, Manager and Salesman.

Imp. Clydesdales and Shorthorns

Messrs. Smith & Richardson, COLUMBUS, ONT.,

Importers and breeders of Clydesdale horses and Shorthorn cattle, are now offering 14 stallions, 9 of them imported, including brothers of the world-renowned Baron's Pride, Hiawatha, and Royal Cairnton; also 13 mares bred from imported stock. Shorthorns, imported and home-bred, all ages. Stations:

Oshawa & Brooklin, G.T.R., Myrtle, C.P.R.

Long-distance Telephone, Columbus. Telegraph, Brooklin.

10 CLYDESDALE STALLIONS

FOR SALE:

OF ALL AGES, IMPORTED AND HOME-BRED.

Sired by such noted sires as Baron's Pride, Mains of Airies, Sir Christopher, Prince Thomas, and others. Among them is Prince Fragrant, the first-prize three-year-old at Toronto Industrial, 1902. Stables half mile from town. Parties desiring to purchase, please write or call upon

R. R. Station: Mitchell, G. T. R.

Wm. Colquhoun, Mitchell, Ont.

Clydesdales and Shorthorns

FOR SALE: Seven choice young stallions, and several young mares and fillies. Five young bulls and bull calves, and thirty-five excellent young cows and heifers. Mostly registered in the American Herdbook.

JOHN BRIGHT, MYRTLE, ONTARIO.

Hodgkinson & Tisdale

BEAVERTON, ONT.,

Breeders of

CLYDESDALE AND HACKNEY HORSES AND SHORTHORN CATTLE.

are now offering a number of choice mares and fillies, and a few young stallions, winners at Toronto; also a few nice harness horses. Shorthorns of both sexes for sale.

BEAVERTON P. O. AND STATION.

BAWDEN & McDONELL, EXETER, ONT.

IMPORTERS OF

Clydesdale, Shire and Hackney Horses

are now offering several imp. Clydesdale, Shire and two Hackney stallions, prizewinners in England, Scotland and Canada, and representing the best blood alive; also several choice Canadian-bred ones. These animals are all true to type, and possess substance, quality, style and action.

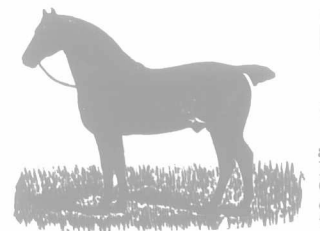
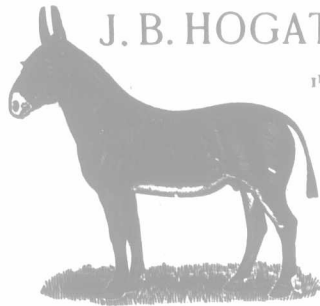
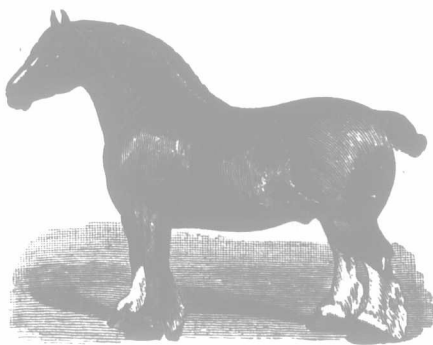

GOSSIP.

John Campbell, of Fairview Farm, Woodville, Ont., changes his ad. to an offer of a young Shorthorn bull and Barred Rock cockerels, specially selected, and he writes: "To any wanting a good Scotch-bred bull to head a herd, this offering is worth looking into, as he is closely related to the noted Strathallan family, while the sire is a good one and royally bred. As but a few of the 'tops' in a well-bred flock of Rocks have been kept, customers may rely on getting good birds."

The following butter tests have been accepted for publication by the American Jersey Cattle Club, for the week ending October 21st, 1902: St. L.'s Daisy of Park Farm 117191—Butter, 18 lbs. 3 1/2 ozs.; milk, 259 lbs. 2 ozs. Test made from September 5 to 11, 1902; age, 6 years 8 months; estimated weight, 1,000 lbs.; fed 3 quarts bran and 2 quarts rye chop daily—good blue grass and timothy pasture during daytime, hay ad lib. in stable during the night. Maury's Rexina 149962—Butter, 14 lbs. 2 ozs.; milk, 233 lbs. Test made from July 21 to 27, 1902; age, 4 years 4 months; estimated weight, 800 lbs.; fed 126 lbs. bran, 7 lbs. shorts, 9 lbs. oil meal and 5 lbs. cotton-seed meal—red-top pasture. Treasure of Millbrook 141364—Butter 15 lbs. 5 ozs.; milk, 241 lbs. 6 ozs. Test made from August 29 to September 4, 1902; age, 3 years 10 months; estimated weight, 700 lbs.; fed 98 lbs. cotton-seed meal, 140 lbs. cotton-seed hulls, and 175 lbs. green corn—Burnuda grass pasture at night.

Mr. Geo. Rice, the noted breeder of Holstein cattle at Curries, Ont. sends the following notes from Brookbank Dairy Farm: "We have now stored for winter feeding a fine variety of fodder—two silos filled with corn, 2,500 bushels roots, mostly sugar beet (large variety), 60 loads hay, 250 bushels barley, 1,000 bushels oats, and the straw from the same, all under cover. The large barns are taxed to their utmost to hold all we have produced on 100 acres, besides pasturing a large stock. Our cattle now number 50 head, all registered Holsteins of Advanced Registry caliber. To meet the 'emergency' of a bumper crop we have imported a carload of cattle, and are now in good shape to convert this feed into the most condensed form. Nothing is sold off this farm in the 'raw' state, but everything is 'manufactured' into milk and it into cheese and butter. We officially tested two cows and one heifer a short time ago. Madonna Clothilde 3rd, four years old, in seven days gave 411 pounds 2 ounces milk, 18 pounds butter, average test 3.55. Lady Wayne Norine Mechthilde, 2 years and 20 days old, in seven days produced 257 pounds 14 ounces milk, 11 pounds 15 ounces butter, average test 3.7. Her dam, Lady Wayne Norine, 6 years old, in seven days produced 431 pounds milk, 22 pounds butter; in twenty-one days produced 1,236 pounds milk, 61 pounds butter; average test, 4% butter-fat. In one week she consumed food to the value of \$1.97, and her product (butter-fat at 25c. per lb., skim milk at 15c. per cwt.) amounted to \$5.00, leaving a clear profit of \$3.00 for seven days, or considerable more than most cows give. Madonna Clothilde also showed the same net profit. The cows not only convert this bulky food into money product, leaving all the manure for the farm to grow richer upon, but show a great profit, or, in other words, we market our product through our cows at about the following prices: Barley, \$1.00 per bushel; oats, 75 cents; hay, \$20.00 per ton, etc., requiring no teaming, and the manure alone is worth a lot. These records, remember, are official; they are not made by drawing upon a 'vivid imagination'; like the man who wrote me offering a cow for sale, that he said had tested 5.6 per cent. fat, and gave over 60 lbs. milk daily. A little figuring shows this: 3.36 lbs. in one day, 23.52 lbs. in seven days—more than any cow has ever done yet. I have got \$1,000 to pay for a cow that will do that, but 'I was not born yesterday' and place no reliance in private tests, neither does anyone that has money enough to buy a good thing. We get some queer letters. One man wanting to buy a bull, some time ago, wrote me. After a month or so I heard from him again, saying he had my letter and 20 others, and he had bought a fine colored bull for \$19.00. The only thing that stuck to this man was the color and price. He took the cheapest one he could get, then wrote me wanting a price on some heifers. Fancy breeding any of my highly-bred heifers to a \$19.00 bull! 'Great Scot!' Most of the men I sell to wouldn't breed a grade cow to such a bull. Yet some men wonder why they are not successful breeders. I refused \$1,500.00 for one of my service bulls. It is a large price, I know, but the records of my cows are now so high that there are very few bulls that I can breed to and not retrograde. And I also know the greatest demand is for these. The cheap trade is not worth going after. I expect to be at the Winter Show with six or seven in the dairy test, and renew acquaintance with the 'bhoys.' With cheese selling at 12c. per pound and upwards, dairymen with good cows are in clover.

HORSEMEN! THE ONLY GENUINE IS

GOMBAULT'S CAUSTIC BALSAM.

Not genuine without the signature of *The Lawrence, Williams & Co.* Sole Importers & Proprietors for the U.S. & CANADA, CLEVELAND, O.

The Safest, Best BLISTER ever used. Takes the place of all liniments for mild or severe action. Removes all Bunches or Blemishes from Horses and Cattle, SUPPRESSES ALL CAUTERY or FIRING. Impossible to produce scar or bump. Every bottle is warranted to give satisfaction. Price \$1.50 per bottle. Sold by Druggists, or sent by Express, charges paid, with full directions for its use. Send for free descriptive circulars. THE LAWRENCE-WILLIAMS CO., Toronto, Ont.

The Flow of Milk will be increased.



Why go to all the trouble of keeping cows and get only about half the milk they should produce.

Dick's Blood Purifier

strengthens the digestion and invigorates the whole system so that the nutriment is all drawn from the food. It takes just the same trouble to care for a cow when she gives three quarts as when she gives a pail. Dick's Blood Purifier will pay back its cost with good interest in a few weeks.

50 cents a package. Leeming, Miles & Co., Agents, MONTREAL. Write for Book on Horses and Cattle free.

Tuttle's Elixir



Cures all species of lameness, curbs, splints, contracted cord, thrush, etc. in horses. Equally good for internal use in colic, distemper, founder, pneumonia, etc. Satisfaction guaranteed or money refunded. Used and endorsed by Adams Express Company.

TUTTLE'S FAMILY ELIXIR Cures rheumatism, sprains, bruises, etc. Kills pain instantly. Our 100-page book, "Veterinary Experience" FREE. Dr. S. A. TUTTLE, 66 Beverly St., Boston, Mass. Beware of so-called Elixirs—none genuine but Tuttle's. Avoid all blisters; they offer only temporary relief if any. LYMAN, KNOX & SON, Agents, Montreal and Toronto, Canada.

DR. PAGE'S ENGLISH SPAVIN CURE.



For the cure of Spavins, Ringbone, Curbs, Splints, Windgalls, Capped Hock, Strains or Bruises, Thick Neck from Distemper, Ringworm on Cattle, and to remove all unnatural enlargements. This preparation (unlike others) acts by absorbing rather than blister. This is the only preparation in the world guaranteed to kill a Ringbone or any Spavin, or money refunded, and will not kill the hair. Manufactured by DR. FREDRICK A. PAGE & SON, 7 and 9 YORKVILLE ROAD, LONDON, E. C. Mailed to any address upon receipt of price, \$1.00. Canadian agents: J. A. JOHNSTON & CO., DRUGGISTS, 171 KING STREET, EAST, TORONTO, ONT.

JOHN GARDHOUSE, HIGHFIELD P. O., ONT.,

Breeder of SHIRES, SHORTHORNS and LEICESTERS. Young stock for sale, both sexes. Scotch and Scotch-topped Shorthorns of such noted families as Imp. Rollas, Claret, Lovelys, Rosebuds, Blossoms, Circos, Roses, and other noted families. The Imp. Lancaster bull, Prince Louis = 32082 = (77486), heads the herd. Farm 3 1/2 miles from Weston station, G.T.E. and C.P.R., and 14 miles north-west of Toronto.

J. M. GARDHOUSE, WESTON P. O., ONT. SHIRE AND CLYDE HORSES, SHORTHORN CATTLE, LEICESTER SHEEP.

One imp. 4-year-old Clyde stallion, half-brother to the champion Hiawatha, for sale. Also Clyde and Shire stud co. ta. Newham's Duke, the gold and silver medal Shire stallion, in service. Chief Ruler, bred by W. S. Marr, Uppermill, heads the herd. Imported and home-bred cattle for sale. Farm, 15 miles from Toronto. Weston station, G. T. R. and C. P. R., telephone and telegraph offices.

PLEASE MENTION FARMER'S ADVOCATE.



Fleming's 3 are free if they fail.

They Put a Stop to Loss on Stock

Few Spavins Now Incurable.

Nearly all can be cured, most can be removed with a single 45-minute application. It is useless to question this because we charge nothing for Fleming's Spavin Cure if it ever fails. Equally certain for Ringbone, Splint and Curb. "I write to thank you for the good accomplished with the Spavin Cure. It is worth its weight in gold." So writes Judge F. R. Tarver, Tusculum, Ga., May 10, 1901. We wish to send you more such reports and a valuable booklet.

FISTULA AND POLL EVIL CURED.

Once seldom cured and then after months of treatment. Now all cases can be cured in 15 to 30 days with Fleming's Fistula and Poll Evil Cure. Not one failure during two years' test of it. Write by next mail for our free treatise.

Lump Jaw Has No Right to Exist.

Fleming's Lump Jaw Cure has made it a perfectly easy matter to exterminate this disease. Severe or mild cases alike yield to the remedy. Easy, common-sense, economical method that has already saved stockmen hundreds of thousands of dollars. Valuable information free. Write us at once for literature on any or all of the above.

Mention this Paper.

FLEMING BROS., Chemists, 36 Front St., West, Toronto, Ont.

Page Acme Poultry Netting

is close meshed at bottom and does not require rail or board support at edges, having strong straight wire (No. 12 gauge) at top, bottom and in centre, cannot sag and is easy to erect. The "Page Acme" netting is of neat appearance, very durable and cheap. We also make farm and ornamental fence, gates, nails and staples. The name of Page is your guarantee of quality.

The Page Wire Fence Co., Limited, Walkerville, Ont. 5

NOTE: CLOSE MESH AT BOTTOM

BOYS! GIRLS!! Sell among friends, at 10c. each, 15 pkgs. Bergamina (a new hair wash powder). When sold, remit 75c. Keep rest for XMAS MONEY. Postal brings goods prepaid. Write to-day. O. COBER, Hespeler, Ont.

The High Price of Coal

is the cause of much present anxiety but there is a practical way of overcoming it to some extent. With an Appleton Wood Saw you can rapidly and with ease and safety

SEE! SAW

your own wood and SAVE COAL, time, labor, money; or saw your neighbor's wood and make \$5 to \$15 DAY

Strong, rigid frame, adjustable dust-proof oil boxes, etc. We make 5 styles. Also the famous "Here" Friction Feed Drag

Saw, Feed Grinders, Ensilage and Podder Cutters, Huskers, Shellers, Sweep Horse Powers, Tread Powers, Wind Mills, etc. Write to-day for Free Catalogue. APPLETON MFG. CO., 53 Fargo St., Batavia, Ill.

California - Oregon Excursions.

Every day in the year the Chicago, Union Pacific and Northwestern Line runs through first-class Pullman and Tourist Sleeping Cars to points in California and Oregon. Three through trains daily. The route of the famous "Overland Limited." Personally conducted excursions from Chicago to San Francisco, Los Angeles, Portland and other Pacific Coast points, leaving Chicago on Tuesdays, Wednesdays, Thursdays and Fridays. Lowest rates. Choice of routes. Finest scenery. Maps, illustrated folders, etc., furnished free. Rates quoted. Address R. H. Bennett, General Agent, 2 East King street, Toronto, Ont.—Adv't.

We are offering some young Durham bulls, cows and heifers, and 20 Berkshires and 10 Yorkshires, of both sexes. Prices reasonable.

Could supply a carload of 2-year-old stock steers. Correspondence solicited, or come and see our stock. No sale, no harm. Visitors welcome to

CAMDEN VIEW FARM,
A. J. C. SHAW & SONS, Thamesville, Ont.

W. R. BOWMAN
MT. FOREST, ONT.,

is offering Yorkshire sows, in farrow, at \$15 to \$20, sired by 2nd-prize boar at Toronto. Suffolk Down rams and ewes, bred close to imported stock, at \$10 to \$15. Two Polled Angus bulls at \$75.

PLEASE MENTION FARMER'S ADVOCATE.

J. Richards, Bideford, P. E. Island,

Importer and breeder of Aberdeen-Angus Cattle, Clydesdale Horses, Shropshire sheep, and Shetland Ponies. Stock always for sale. om

"Tweedhill" Aberdeen-Angus. Individuals from this herd or their calves have been first at all the best shows since 1896. Females and young bulls for sale. **JAMES SHARP, ROCKSIDE, ONTARIO.** Cheltenham station, C. P. R. and G. T. R. om

ABERDEEN - ANGUS.

For Sale: Laird of Tweedhill 29486. A prizewinner, 4 years old; 1-year-old bull and two bull calves, sired by him and out of winners.

W. HALL, Washington P. O.
om Drumbo Station.

CHOICE HEREFORDS.

A. S. HUNTER, DURHAM, ONT., has for sale the following high-bred Herefords:

- 25 Young Registered Bulls.
- 30 Young Registered Heifers.
- 10 Young Registered Cows.

The above stock are in good condition, and are bred from imported and American bred sires. Ranchers will do well to inspect this offering. om

SALE! INGLESIDE HEREFORDS.

Young bulls, cows and heifers of most up-to-date type and breeding. If you want good Herefords at good-value prices, send for illustrated catalogue, and state requirements. Also 1/2 and 3/4 bred Hereford cows and heifers. om

H. D. SMITH, Compton, Que.

The Sunny Side Herefords.

Imp. Sunny Slope Tom 1st at head. We have the best of blood lines, also individual merit. For sale: 8 cows, from 3 to 7 years old; 10 heifers, bred and safe in o if or ready to breed; 1 bull, 2 yrs.; 1 bull, 1 yr., and 12 young bulls ready for service, by our stock bull. Visitors always welcome. **O'NEIL BROS., Southgate, Ont.** Iderton station, L., H. & B. Lucan station, G. T. R. om

SHORTHORN BULL FOR SALE:

12 months old, red, low-set, thick-fleshed, Scotch type. Sire, Duke of Richmond - 28021 - of the Miss Ramsden family. Address **H. FRANK WRITER,** 99 Wellington Road. om London, Ont.

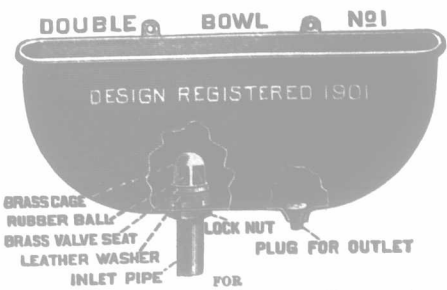

Stock Water Bowls

DOUBLE AND SINGLE. PAINTED OR GALVANIZED. om

Circular and quotations given. Write: **A. M. RUSH, HARRISTON, ONT.**

THE ONTARIO VETERINARY COLLEGE (LIMITED),
TEMPERANCE ST., TORONTO, CANADA

Affiliated with the University of Toronto. Patrons: Governor-General of Canada, and Lieut.-Governor of Ontario. Fee \$65.00 per session. Apply to **ANDREW SMITH, F.R.C.V.S.,** Principal. 18-2-y-om

Centre Wellington Scotch Shorthorns

Young bulls, heifers and young cows for sale. Farm adjoining town on G. T. R. and C. P. R. Correspondence solicited. om

H. B. Webster,
Box 66. **FERGUS, ONT.**

Plaster Hill Shorthorns. We are now offering 45 head, including a number of very heavy milkers, among which are several winners in Provincial dairy tests, also 10 young bulls and 16 heifers. A choice lot and bred in the purple. **F. MARTINDALE & SON,** York P. O., Caledonia Sta om



T. DOUGLAS & SONS, STRATHROY, ONT.,

BREEDERS OF

Shorthorns & Clydesdales

100 SHORTHORNS TO SELECT FROM. Herd bulls (imp.) Diamond Jubilee = 28861 = and Double Gold = 37852 =. We offer for sale a choice lot of young bulls, cows and heifers of all ages. Also one 3-year-old stallion, and one 4-year-old brood mare. Farm one mile north of town. om

S. DYMENT,
BARRIE, ONT.

Breeder of Scotch Shorthorns
Imported Morning Star at head of herd. om

Bulls! Shorthorns Bulls!

IMPORTED and CANADIAN-BRED

ORDERS TAKEN FOR BULLS AND HEIFERS, COTSWOLD AND LEICESTER SHEEP, YORKSHIRE AND BERKSHIRE PIGS, AND DELIVERED TO ANY PART OF MANITOBA OR THE NORTHWEST. Write for prices. Satisfaction guaranteed.

Goodfellow Bros., Macville, Ont. om

Maple Grange Shorthorns

CLARETS, LAVINIAS AND BEAUTYS. Sired by such Scotch bulls as Commodore 31025, Scottish Bard, Imp. Baron's Heir. 18 heifers, 12 bulls, a number of cows (heavy milkers), to be sold well worth the money. om

R. J. DOYLE,
Owen Sound P. O. and Station and Port.

Beechgrove Shorthorns. Present offering: 3 females from 1 to 4 years old, heavy milking strain; also one roan bull calf 8 months old. Prizewinners; a thick, beefy lot. om

C. McNULTY, Rathbura P. O. Orillia and Arthly stations.

RARE YOUNG BULLS

of serviceable age for sale; also females of all ages. Roans and reds. Prices right. om

E. & C. Parkinson, Thornbury P. O. & Stn., G.T.R.

W. G. PETTIT & SONS
FREEMAN P. O., ONT.

IMPORTERS AND BREEDERS OF
Scotch Shorthorns and Shropshire Sheep,

Make a Special Offering for May and June:

One of our imp. stock bulls, 3 years old, red; one imp. bull, 2 years, roan; two bulls imp. in dam, 15 months; four bull calves from imp. cows, 12 and 14 months; four home-bred bulls by imp. bulls, 15 to 18 months; seventy-five imp. and home-bred cows and heifers, all ages. Catalogues on application. om

Burlington Jct., G.T.R. Sta., Tele. & 'Phone.

Shorthorns and Leicesters.

Herd Established 1855. A number of young bulls, cows and heifers for sale. Imported Christopher = 26859 = heads the herd of large cows of grand milking qualities. Also a number of Leicesters of both sexes, from imported foundation. **JAMES DOUGLAS,** CALEDONIA, ONT. om

Shorthorns and Yorkshires In Shorthorns we are offering four young bulls from 7 to 9 months, also a few heifers. In Yorkshires we can supply either sex of various ages. All at o **J. E. McCallum & Son,** living prices, Iona Sta. and P. O., Elgin Co. om

SHORTHORN BULLS FOR SALE: A choice lot of Shorthorn bulls from 10 to 16 months old, sired by Imp. British Statesman (63729) = 20833 =; and cows of the Mara family. They must be sold at once. Prices away down to suit customers. **FITZGERALD BROS.,** om Elmvale Station, G.T.R. Mount St. Louis P. O.

J. & W. B. WATT,
SALEM, ONTARIO.

POST OFFICE AND TELEGRAPH OFFICE.
BREEDERS AND IMPORTERS OF

Shorthorn Cattle, Clydesdales, Leicesters, Oxfords, and Berkshire Pigs.

Our herd represents such families as Matchless, English Lady, Mildred, Village Buds, Missies, Stamford, Mysias, Vanillas, Claretas, Marthas, and others. The imported bull, Scottish Peer, and Coming Star, a prizewinner at Chicago in 1901, head the herd. Imported and home-bred stock for sale. Also twenty registered ewes and lambs.

Farms 2 miles from Elora Sta., G.T.R. and O.P.E., 13 miles north of Guelph. om

Maple Lodge Stock Farm.

ESTABLISHED 1854.

SHORTHORNS.—First-prize milking strains, best Scotch breeding. Young bulls and heifers for sale. **LEICESTERS.**—A grand lot of ewes, bred to our imported rams, and a few choice rams, now for sale.

A. W. SMITH,
Allen Craig Station, Maple Lodge P. O., G.T.R., 3 1/2 miles. om ONT.

SHORTHORNS, SHROPSHIRE, COTS WOLDS.

We are now offering a number of heifers and heifer calves; a few bull calves; a number of cows; all bred in the purple and as good as the best. Also Shropshire and Cotswold sheep. om

JOSEPH BELL ESTATE, Bradford P. O. & Sta.

Spring Grove Stock Farm
Shorthorn Cattle and Lincoln Sheep.

HERD prize and sweep-stake at Toronto Industrial Exhibition, 1897 and 1898. Herd headed by the Marr Missie bull, Imp. Wanderer's Last, last of the get of the great sire, Wanderer, of the Cruickshank Braith Bud tribe. High-class Shorthorns of all ages for sale. Also prizewinning Lincolns. Apply om

T. E. ROBSON, ILBERTON, CNT.

SHORTHORNS FOR SALE!

Six good bulls, fit for service; also females. Imp. Prince William at head of herd. om

JAS. GIBB, - - BROOKSDALE, ONT.

RIVER FARM SHORTHORNS

I am now offering 6 choice young bulls, from 8 to 16 months old, sired by Lord Lavender 26855. They are rare good ones. Price right. om

H. PARKER, DURHAM P. O. and STATION.

CHARLES RANKIN, WYEBRIDGE, ONT.

Importer and breeder of
Shorthorns, Oxford Downs and Berkshire Pigs
Young stock always on hand. om

High Park Stock Farm Galloway Cattle. A few choice young heifers and bulls for sale. Inspection invited. om

SHAW & MARSTON (Late A. M. & R. Shaw)
P. O. Box 294, BRANTFORD, ONT.

PLEASE MENTION FARMER'S ADVOCATE.

Water Basins.



EIGHT REASONS FOR ADOPTING THE Woodward Water Basins.

7th. Price is reasonable. They will owe you nothing after one year. Consequently they are cheap at any price. But we only ask a reasonable price for a valuable article. Try them.

Eighth Reason Next Issue.

Ont. Wind Engine & Pump Co., Ltd. TORONTO.

Canadian Farmers

STOCK - RAISERS

Say Prof. A. V. M. Day's English Tonic Powders are all right for Horses, Cattle, Hogs, Sheep and Poultry (5 separate packages). Makes a Tonic Stock Food. Prevents disease. Makes flesh and fat. Day's Cream for calves enriches skimmed or separated milk, prevents scours, makes healthy, fat calves. Ask your dealer for Day's. No other just as good. A free sample sent to any address.

THE DAY'S STOCK FOOD CO'Y, TORONTO, CAN.

Dehorned Cattle cost less and show better milk and beef results. The job is quickly done with the **KEYSTONE DEHORNERS**. Cuts four sides at once. Leaves it smooth and clean cut, no breaking or crushing of horn. More widely used than all others. Fully guaranteed. R. A. McKenna, V.S. PICTON, Ont.

Rosevale Shorthorns

We are offering for sale several cows and heifers bred to Maringo's Hyden Duke (imp.), son of the great champion Maringo. Also several bred to Golden Able, imp. in dam. Also some choice young bulls. Any wishing to purchase apply at once.

W. J. SHEAN & CO'Y, OWEN SOUND, ONT.

SHORTHORNS (IMP.)

Cows and heifers, imp. and home-bred. Bulls, imp. and home-bred—all ages. Representing the fashionable blood of Scotland.

EDWARD ROBINSON, MARKHAM P. O. & STN.

Shorthorns, Cotswolds & Berkshires

FOR SALE: 9 bull calves from three to nine months old; also cows, heifers and heifer calves. A choice lot of ram lambs, ewe lambs and yearling ewes. Young pigs of the long bacon type, from two to four months old. Can supply pairs not related.

F. BONNYCASTLE & SONS, Campbellford, Ont.

STOCK BULL FOR SALE.

Have decided to offer for sale my noted stock bull, Spicy Robin #28259—winner of second prize at Toronto and London exhibitions, 1902. Also a number of cows and heifers for sale.

GEO. D. FLETCHER, Binkham P. O., Ont.

JOHN DRYDEN & SON,

BROOKLIN, ONTARIO, BREEDERS OF ORUICKSHANK SHORTHORNS AND CHOICE SHROPSHIRE SHEEP.

40 shearing rams and 30 shearing ewes of extra size, substance and quality now for sale. Prices are interesting. Visitors welcome.

Shorthorns, Berkshires and Leicesters.

FOR SALE: Choice two-year-old heifers, well gone in calf; also yearling heifers, bull calves. Boars and sows fit for breeding, and young pigs.

ISRAEL GROFF, ALMA, ONTARIO.

BELLEVUE SHORTHORNS.

Both sexes. Imported and home-bred. All ages. Prizewinners at home and abroad.

EDWIN BATTYE, Gore Bay P. O. and Port Maitoulin Island.

HAWTHORN HERD

of deep-milking Shorthorns for sale. Six young bulls of first-class quality and breeding and from AI dairy cows. **WM. GRAINGER & SON, Londesboro, Ont.**

GEO. ISAAC, BOMANTON, ONT.,

IMPORTER AND BREEDER OF

Scotch Shorthorn Cattle

Have imported, this year, 68 head of Shorthorns—6 bulls and 62 females. Twenty-seven head due to leave quarantine 11th Sept. Intending purchasers should see this stock or correspond.

BOMANTON P. O., COBOURG STATION, G.T.R.

GREEN GROVE SHORTHORNS:

I am now offering a few heifers, Claretas, Floras, and one Missie; also a choice year-old bull, by Aberdeen of Markham.

W. G. MILSON, GOREING P. O. and MARKDALE STATION.

SHORTHORNS (imported)

One imported and one Canadian-bred bull. A few cows and heifers.

THOS. RUSSELL, EXETER, ONT.

SHORTHORNS AND LINCOLNS.

J. K. HUX, Rodney, Elgin Co., Ont., P. O. and Station, now offers 7 young bulls, cows and heifers. Abbotford 19146 now at head of herd. Also ram lambs out of imp. Dudding ewes.

SHORTHORNS.

FOR SALE: 4 females, from 1 year to 4 years. These are served by Imp. Golden Conqueror, Vol. 17. Also two bulls out of Royal Ury #23630.

AMOS SMITH, Listowel Station, Trowbridge P. O.

Craigieburn Shorthorns.

G. A. BRODIE, Bethesda P. O., Stouffville Station, is now offering 10 choice Shorthorn heifers and 10 young bulls. A splendid lot and bred right. Also 12 Shropshire rams, bred from imported stock on both sides.

QUEENSTON HEIGHTS SHORTHORNS

SCOTCH AND SCOTCH TOPPED

In service: Derby (imp.) #39057—; Lord Montalis, by Collynie Archer (imp.) #28860—.

Some choice heifers and young cows with calf at foot or in calf to imported bull at moderate prices.

HUDSON USHER, QUEENSTON, ONT.

FARM 3 MILES NORTH NIAGARA FALLS

SHORTHORNS:

We are offering 3 extra choice yearling bulls, all from imported sires, straight Cruikshank, with Lavendar and Miss Ramsden dams.

THOS. ALLIN & BROS., Oshawa, Ont.

For Sale

Some choice young **YORKSHIRES** (Holywell strain) of both sexes and different ages; also young Shorthorn bulls, sired by British Hope (30946). Price moderate.

Write: **C. & J. CAREUTHERS, Cobourg Station and P. O., Ont.**

Mercer's Shorthorns

Are represented by Missies, Stamfords, Floras, Claret Princesses, Red Roses, Fashions, Crimson Flowers, and Matchless families. Headed by Village Squire #4993, a son of Abbotstford. Stock of both sexes and all ages for sale.

T. MEROER, MARKDALE P. O. & STN.

Shorthorn Cattle, Lincoln Sheep

Imp. Prime Minister at head of herd. Imp. Clippers, Miss Ramsden, and other Scotch families. Lincolns won more than half the money and first for stock at the Pan-American; International, Chicago, 1901 and 1902.

J. T. GIBSON, DENFIELD, ONT.

ASHTON FRONT VIEW STOCK FARM.

Six Shorthorn Bulls for sale, from 8 to 15 months old; all of choice breeding. Also Cotswolds of all ages for sale at all times. Visitors welcome.

A. J. WATSON, Castlederg, Ont. C. P. R. Station and Telegraph Office, Bolton; or G. T. R., Palgrave.

Shorthorns, Clydesdales, Yorkshires

I am now offering the bull, Count Amaranth, imp. in dam, 2 years old, and young bulls 10 months old; heifers, various ages; Clydesdales, American and Canadian registered; and Yorkshires, both sexes and all ages.

A. E. HOSKIN, SPRINGVALE FARM, COBOURG STA. & P. O.

SHORTHORNS.

THORNHILL HERD. ESTABLISHED 27 YEARS.

Imp. Royal Member and Sailor Champion now at head of herd, which are all bred on straight Scotch lines, and are of the up-to-date kind. Present offering: some choice young bulls.

REDMOND BROS., Millbrook Sta. and P. O.

H. J. Davis, Woodstock, Ont.

40 HEAD IMPORTED and CANADIAN-BRED SHORTHORNS.

22 head just home from quarantine, including a choice lot of heifers and young bulls of the best breeding. Herd headed by the Willis Cruikshank-bred bull, Bapton Chancellor (imp.), and the Lovat bull, Viceroy. Woodstock: Main line G. T. R. and C. P. R.

Ladies! This is for you!

FREE 97-PIECE DINNER AND TEA SET

Full size for family use, made of the finest ware, in the very newest shapes and latest designs, suitable for any table. The decorations are clear and distinct, delicate in design, and the whole effect is stylish, beautiful and artistic; a set that will give you a lasting pleasure because it will stand the wear of years. The colors never losing their brilliancy. This elegant set consists of 12 Dinner Plates, 12 Tea Plates, 12 Soup Plates, 12 Cups, 12 Saucers, 12 Fruit Saucers, 12 Butter Pats, 2 Vegetable Dishes, 2 Covers, 1 10-inch Meat Platter, 1 14-inch Meat Platter, 1 Gravy Boat, 1 Tea Pot and cover, 1 Sugar Bowl and cover, 1 Creamer and 1 Slip Bowl, in all 97 full size pieces, all light in weight, perfect in color, extra smooth, and for beauty and richness equal to any Dinner Set ever sold at retail for less than \$25.00. We give it free, just for selling at the each only 2 doz. Canadian Home Cook Books and get the 3 more agents to do the same or send for one free of charge. These books are nicely printed, beautifully bound and each contains 739 choice recipes. Every housekeeper buys one. **THE HOME SPECIALTY COMPANY, DEPARTMENT 572, TORONTO, ONTARIO.**

GIRLS THIS DOLL IS FOR YOU

Not a single cent to pay for her. As pretty as a picture. You will fall in love with her the minute you see her. Golden ringlets, laughing blue eyes, rosy cheeks, stylishly dressed in silk and satin, with velvet and lace trimmings. Lovely trimmed hat, dainty little slippers, real stockings, lace-trimmed underwear. She can be dressed and undressed like any live baby. Her head, arms and legs are movable. She can stand alone or sit in a chair or on the floor. When you get her you will say she is the prettiest doll you have ever seen. **We give her free, for selling at 15c, each only 1 doz. Canadian Home Cook Books.** These books are nicely printed, beautifully bound, and each contains 739 choice recipes. Write to day and we will send you the Cook Books postpaid. You can easily sell them in a few minutes. **Every housekeeper buys one. 20,000 sold already. Don't miss this grand chance but write at once.**

THE HOME SPECIALTY CO., DEPT. 566, TORONTO, ONTARIO

FREE RIFLE

Sure death to Rats, Crows, Squirrels, Rabbits, etc. Long Range. Terrific Force.

All steel barrel and fitting, improved sights, walnut stock. The best Air Gun made. Given for selling at 15c, each, only 1 doz. Canadian Home Cook Books. These books are nicely printed, beautifully bound and each contains 739 choice recipes. Every housekeeper buys one. Write for Cook Books to-day.

THE HOME SPECIALTY CO., TORONTO, ONTARIO.

\$1.89

MAGNETO-ELECTRIC BATTERY

A DOCTOR IN YOUR HOME

Always ready. Cannot get out of order. Never wears out. You turn the crank and generate an electric current which can be regulated at will. Weak enough for a baby or powerful enough to overcome a strong man. Nothing like it for Apoplexy, Neuritis, Paralysis, Neuralgia and all other nervous affections, Dyspepsia, Rheumatism, etc., etc. The best doctors recommend the use of electricity even when everything else fails. It is Nature's own remedy. The first cost is the only cost. **NEVER OBTAIN TO PAY TILL YOU SEE IT.** Just send in your name, address and nearest express office, and we will send you this Electric Machine for examination. When it arrives, test it thoroughly, and if found perfectly satisfactory, and in every way equal to batteries regularly sold at from \$5.00 to \$10.00, pay the express agent our special whole-sale price—\$1.89, and express charges, and you will have one of the finest batteries ever made. Our battery is also a great entertainer. You can have no end of fun giving shocks to your friends. Full instructions sent with each battery. Remember, you don't pay one cent till you see it. Order to-day. If you do not live near an express office and wish to save express charges, send \$1.89 cash with order and we will send the battery postpaid. **THE NATIONAL TRADING CO., Box 547, Toronto.**

97 PIECES FREE DINNER AND TEA SET

Elegantly decorated English China, 12 Dinner Plates, 12 Tea Plates, 12 Soup Plates, 12 Cups, 12 Saucers, 12 Fruit Saucers, 12 Butter Pats, 2 Vegetable Dishes, 2 Covers, 1 10-inch Meat Platter, 1 14-inch Meat Platter, 1 Gravy Boat, 1 Tea Pot and Cover, 1 Sugar Bowl and Cover, 1 Creamer and 1 Slip Bowl—in all 97 full size pieces of handsome decorated China given away for doing three things: (1) Selling at 15c, each only 2 doz. Canadian Home Cook Books, (2) getting 3 other agents to do the same, or by selling 6 doz. yourself. These books are nicely printed, beautifully bound, and each contains 739 choice recipes. Send your order to-day. You can easily sell the Cook Book in a few minutes. Every housekeeper buys one. 20,000 sold already. **THE HOME SPECIALTY CO., DEPT. 566, TORONTO.**

Orchard Hill Shorthorns. I am now offering 13 heifers from six months to two years, 4 bulls from 10 to 13 months old, and 7 very heavy milking cows. Here is a rare chance to get stocked with pure-bred cattle at reasonable terms. A. Johnston, Vandeleur P. O., Markdale Sta.

Lakeview Shorthorns. Herd represented by such noted families as Stamfords, Minas, Marr Floras, Crimson Flowers, Village Girls, Bucan Lassies, and Lavinias. Stock of both sexes and all ages for sale. om James Bowes, Strathclair P. O., Meaford Sta.

Imp. Shorthorns and Lincolns

A. D. MCGUGAN,
RODNEY, ONT., P. O. AND STA.

Imported Aberdeen Hero at the head of the herd which is composed of the best Scotch families. Ten grand shearing and two-year old ewes for sale, in lamb to a Royal winner. Also ewe lambs from imported Dudding ewes at reasonable prices.

A REAL GOOD SHORTHORN BULL
FOR SALE at a moderate price. A good individual, of the very choicest breeding. Sire Minister, first cousin on dam's side to Ruberta, the Chicago International champion; he by Prime Minister; dam a Strathallan, by Imp. Saladin. Just a year old; color, bright red; strong in bone and nicely fleshed. A desirable herd header. A few specially selected Banded Plymouth Rock cockerels at \$1 to \$2 each. o JOHN CAMPBELL, "Fairview Farm," Woodville, Ontario.

R. MITCHELL & SONS,
NELSON P. O., ONT.

Scotch Shorthorns. The Marr Princess Royal heads herd. We have for sale 4 imported bulls, 12 imported heifers, and a large number of home-bred bulls, cows and heifers belonging to the most popular Aberdeenshire families.

Shorthorns, Clydesdales, YORKSHIRES.

Am now offering 7 bulls from 6 to 10 months old, 1 heifer 1 year old, 1 heifer 2 years old (in calf).

W. ORMISTON, JR., COLUMBUS P. O., ONT.
Myrtle, G. P. R.; Brooklyn, G. T. R. om

HIGH-CLASS SHORTHORNS

Now offering 12 bulls, reds and roans, from 6 to 24 months old—the thick, fleshy kind—and a few heifers. Also Clydesdale horses.

JAS. McARTHUR, Goble's, Ontario.

Scotch Shorthorns I
Nonpareils, Myrios, Isabelas, Ury, Minas, Strawberry, and Matchless. Animals of both sexes and all ages for sale. Also choice Berkshires.

J. W. HARTMAN & SONS,
Meaford Farm, Elm Hedge P. O., Meaford Sta.

HIGH-CLASS SCOTCH SHORTHORNS

of the following families, for sale at moderate prices: Village Girls, Broadhocks, Beaufort Roses, Minnie, Clara, Marr Floras, Nonpareils, Minas and other choice families. Write for catalogue. Shropshire rams and ewes for sale as usual.

ROBERT MILLER, Stouffville, Ont.

LEONARD BURNETT, GREENBANK, ONT.,
BREEDER OF om

Shorthorn cattle and Shropshire sheep.

BONNIE BURN STOCK FARM, 40 rods north of Stouffville station, offers Scotch Shorthorns; choice Shropshires and Berkshires from imported and Canadian bred sows. All at farmers' prices. Inspection invited.

D. M. RUSNELL, STOUFFVILLE, ONT

SCOTCH-BRED SHORTHORNS.

Combining size and quality, at "let-live" prices. Bulls from 6 to 15 months old, reds and roans, including the Sultana imported bull, = Gold-finder =, now at the head of herd; also several young cows and heifers.

L. I. WEBER,
Co. Waterloo, Hawkesville P. O., Ont.

SCOTCH SHORTHORNS.

We are now offering a few young bulls, from 6 to 11 months; also a few heifers, from 6 months to 2 years; all showing No. 1 quality.

W. G. HOWDEN,
COLUMBUS P. O. om

SPRINGBANK FARM.

Shorthorn Cattle, Oxford Sheep, and Bronze Turkeys. Young bulls for sale.

JAS. TOLTON, WALKERTON, ONT.

SPRUCE HEDGE SHORTHORNS.

We are offering females of all ages. Among them are prizewinners and youngsters that are sure to win.

JOHN MCKENZIE, Keward P.O. and Chatsworth Station, C.P.R.

SHORTHORNS:

JILTS and MARAS: 6 heifers from 1 to 3 years old; 5 with calves at foot and in calf again to Imp. British Statesman. Also two young bulls (roan).

LOUIS ELLARD, Loretta P.O., Beeton Sta.

GOSSIP.

Messrs. R. Reid & Co., breeders of Ayrshire cattle and Berkshire and Tamworth pigs, Hintonburg, Ont., write: "We have just got our cattle stabled for the winter, and they total an even hundred head. Our stock being so large, we can make prices interesting to both stockmen and dairymen in single animals or car-load lots. We could supply a car-load of cows and heifers at living prices. We have eleven young bulls, several of them this fall calves, all sired by Duke of York 2nd 2001 (imp.). They are a fine lot, and any of them will make good heads of herds. We have a good selection of pigs of both breeds and sexes that are bred from Ottawa and Toronto winners.

Mr. H. J. Davies, of Woodstock, Ont., has recently sold to Mr. Arthur Johnston, Greenwood, Ont., one fine yearling imported Shortnor heifer, Ballachraggan favorite, of the noted Broadhocks family, and bred by Mr. Anderson, of Alness, Scotland. She was said by her purchaser to be the best heifer in quarantine in October last. Also delivered to Messrs. Shore Bros., White Oak, a fine young imported bull, bred by the Earl of Rosebery, Dalmeny Park, sired by Scottish Beau, and from one of the best Cruickshank-bred cows in the Dalmeny herd. This bull is a roan, of fine character, and should do well in this old-established herd of Shorthorns. Have a very fine lot of imported and Canadian-bred bulls and heifers to offer intending purchasers. Have recently sold ten imported Yorkshires and a large number of Canadian-bred boars to different points. Have some extra good boars yet on hand.

THE IMPORTED BELGIAN HORSES.

Attention is again directed to the advertisement in this paper of an importation from France of eight Belgian stallions, by Baron de Champlouis, a young Frenchman who has settled at Danville, Quebec, having spent two years in Canada, and who writes: "I was amazed at the poor class of horses used by Canadian farmers, and thought something could be done. Having a partner in Belgium, one of the principal breeders of the country, I come with Belgian draft horses, combining life, action and weight—sell like hot cakes in Germany, France and the States—large, flat bone, extra short backs, splendid feet, no surplus hair; first prize at Vincennes, Paris Exhibition, 1900. To look at is to fall in love with them. I have received the greatest encouragement and approbation from the Canadian authorities; have only imported eight stallions for this first experience, but they are all first-class, all fully pedigreed and registered in the Belgian Studbook. Each horse sold with his papers. Ages from two to five; dark colors; just the thing for the Western ranches and the Eastern 'urdes agricoles.' One of them in a township or county would immensely improve the breed in five years. We are naming moderate prices to make the breed known. Every stallion is broken to harness and remarkably gentle." Baron de Champlouis' enterprise is certainly a commendable one, and if these horses have the grit, action and endurance of the French-Canadian horses of forty years ago they will be well worth a trial, for never was a more valuable class of work horses known in this country.

OFFICIAL RECORDS OF HOLSTEIN-FRIESIAN COWS.

From October 6th to November 7th, 1902, four thirty-day records, two fourteen-day records and twenty-four seven-day records have been approved. Of the thirty-day records, the highest was made by Koradyke Queen De Kol 41934, age 6 years 7 months 19 days; commencing test 7 days after calving, she produced in 30 days 2,015.8 lbs. milk, containing 77.767 lbs. fat, equivalent to 97 lbs. 3.3 ozs. butter 80 per cent. fat, or 90 lbs. 11.6 ozs. 85.7 per cent. fat. Owners, Henry Stevens & Sons, Lacona, N. Y.

Of the seven-day records, five were made by full age cows; average age 4 years 9 months 10 days; days after calving, 16; milk 468.4 lbs., fat 16.016 lbs., equivalent to 20 lbs. 0.3 oz. butter 80 per cent. fat, or 18 lbs. 10.9 ozs., 85.7 per cent. fat. Six four-year-olds; average age, 4 years 5 months 9 days; days after calving, 24; milk 369.3 lbs., fat 12.072 lbs., equivalent butter 80 per cent. fat, 15 lbs. 1.4 ozs., or 14 lbs. 1.4 ozs. 85.7 per cent. fat. Six three-year-olds; average age, 3 years 5 months 8 days; days after calving, 16; milk 346 lbs., fat 11.569 lbs., equivalent to 14 lbs. 7.4 ozs. butter 80 per cent. fat, or 13 lbs. 8 ozs. 85.7 per cent. fat. Seven two-year-olds; average age 2 years 5 months 23 days; days after calving, 34; milk 295.7 lbs., fat 9.380 lbs., equivalent to 11 lbs. 11.6 ozs. butter 80 per cent. fat, or 10 lbs. 15.1 ozs. 85.7 per cent. fat. Of the matured cows, the second highest record was made by Lady Wayne Norine 53608; age 6 years 4 months 14 days, who, 21 days after calving, yielded of milk 431.1 lbs., butter-fat 17.627 lbs., equivalent butter 80 per cent. fat 22 lbs. 0.5 oz., or 20 lbs. 9 ozs. 85.7 per cent. fat. Food consumed, hay 105 lbs., ensilage 252 lbs., roots 299 lbs., oil cake 26.5 lbs., oats 21 lbs., bran 70 lbs., and chopped barley 28 lbs. Owner, George Rice, Currie's Crossing, Ont. The same owner's heifer, Lady Wayne Norine Mechthilde 54612, age 2 years 20 days, 11 days after calving gave of milk 257.9 lbs., butter-fat 9.555 lbs., equivalent butter 80 per cent. fat 11 lbs. 15.1 ozs., or 11 lbs. 2.4 ozs. 85.7 per cent. fat. Owner, Geo. Rice, Currie's Crossing, Ont.

Splendid Round Cement Silo

BUILT BY OUR H. W. HAGAR FOR MR. P. D. EDE, OF OXFORD CENTRE, ONT., WITH

BATTLE'S "THOROLD" CEMENT



SIZE OF SILO.

16 feet diameter inside; 34 feet high; 16-inch wall at bottom, tapering to ten inches at the top.

COST AS FOLLOWS:

Cement for wall, 80 barrels at \$1.15.....	\$92 00
Gravel, 44 loads (66 cubic yards), 10c. load	4 40
Stone, 10 loads (14 cubic yards), 10c. load	1 00
Labor, 5 men, 9 days each, at \$1.25 a day.....	56 25
Superintendent, 9 days, at \$2.00 a day.....	18 00
Plastering walls, inside and outside, cement, 5 barrels, at \$1.15.....	5 75
Labor 2 men, 3 days, at \$1.25 a day.....	7 50
Superintendent, 3 days, at \$2.00 a day.....	6 00
Wire, 4 strands, No. 9, twisted into a cable, and 5 cables put in between each of the five doors, about	1 50
Rent of moulds.....	7 50
Total cost.....	\$199 90

ESTATE JOHN BATTLE, MANUFACTURERS OF CEMENT, THOROLD, ONT.

H. SMITH, EXETER, ONT.
Scotch-bred Shorthorns.

CHOICE SPECIMENS OF BOTH SEXES FOR SALE.

FARM ADJOINS EXETER, ON THE LONDON AND WINGHAM BRANCH OF THE G. T. R. 30 MILES NORTH OF LONDON. om

Scotch Shorthorns

BREEDING FEMALES ALL IMPORTED.

Imp. Golden Drop Victor our present stock bull. Eleven young bulls and some young cows for sale at reasonable prices.

H. CARGILL & SON,

Cargill Station, G. T. R. CATALOGUE FREE. om Cargill, Ontario.

ARTHUR JOHNSTON
GREENWOOD, ONT., CAN.

HAS 24 HEAD OF

Scotch Shorthorns

Now in quarantine, which he will sell in whole or in part; would prefer to sell a carload. They are

Mostly Yearlings and Two-year-old Heifers. They are Due Home About 10th November. om

DON'T

BUY A SEPARATOR UNTIL
YOU HAVE SEEN THE

National.

EXAMINE

The simplicity of the design.
All wheels and bearings protected, being perfectly safe in the hands of a child.
It has anti-friction ball bearings.
Few parts to wash—only two pieces inside the bowl.

The National is made by The Raymond Mfg. Co. of Guelph, whose success with the celebrated Raymond Sewing Machine is sufficient guarantee of the high finish and workmanship.

In 1901 five machines a day were manufactured. For 1902 the capacity is increased to 25 machines per day, showing the satisfaction given by the National in the past two years.

The 1902 National contains all the strong points found in other separators, and is placed on the market with the guarantee of being the best and most up-to-date machine in every particular offered to the Western farmers to-day.

The National will well repay investigation by intending purchasers.
National No. 1, capacity 330 to 350 lbs. per hour.
National No. 1 A, capacity 450 to 500 lbs. per hour.

AGENTS WANTED IN UNREPRESENTED DISTRICTS.

The Raymond Mfg. Co. of Guelph, LIMITED.

GUELPH, ONT.

WE ALSO MAKE GOOD SEWING MACHINES.

Queenston Cement

WE have reduced our prices, and are prepared to demonstrate that no better value for the money is obtainable anywhere. All work done with our cement according to our instructions is guaranteed to be absolutely perfect. A barrel of Queenston Cement, though weighing less, contains just as many cubic inches of cement as any barrel of Portland. In mixing concrete, the cement is gauged by measure, not by weight. Farmers and others will do well to remember this fact, and not be misled by false statements. Write me, or see my agents, for full particulars.

Isaac Usher,

QUEENSTON, ONT.

We now have

61 SHORTHORNS

in quarantine at Quebec,

consisting of 5 bulls and 56 heifers and young cows. They are equal or superior to past importations made by us. About half of the females and 4 of the bulls are for sale, the balance intended for the farm, it being our desire and purpose to try and breed up a herd of Shorthorns that will be equal to any on the North American continent.

JAS. SMITH, Mgr., Millgrove, Ont. **W. D. FLATT,** Hamilton, Ont.

Scotch Shorthorns :

Of both sexes, of the following noted families: Golden Drops, Rosebuds, Claras, Matchlesses, Strathallans, Vain Duchesses, Marr Beautys, Mayflowers, Crimson Flowers, and others; 56 head to select from. Herd headed by the Imported Bracelet bull, Red Duke = 36084 = (77585).

DAVID MILNE & SON, ETHEL P. O., Huron Co., Ont. Ethel Station, G.T.R., half mile from farm.

SCOTCH SHORTHORNS.
Urys, Stamfords and Matchlesses. Young, vigorous females, all ages, for sale. Shropshire sheep and Yorkshire pigs. **ROBT. BATTY,** Glenbourne Farm, Meaford P. O. & Sta.

WANTED AN EXPERIENCED HERDSMAN for a large Shorthorn herd, also a man competent to take charge of Large Yorkshires. Unmarried men preferred. State references in first letter. **THOS. H. CANFIELD,** Lake Park, Minnesota, U.S.A.

Brookbank Holsteins
16 to 25 lbs. of butter in 7 days' official test are the records of this herd of Holstein cows. Heifers of equivalent records. Bulls for sale whose sires and dams are in the Advanced Registry, with large official butter records.

GEO. RICE, Currie's Crossing, Ontario.
OXFORD COUNTY.

Riverside Holsteins.
10-BULLS FOR SALE-10.
From 3 to 10 months old, sired by Victor DeKol Pieterje and Johanna Rust Lad. A number of these bulls are from officially-tested dams in the Advanced Record of Merit.

MATT. RICHARDSON & SON, Haldimand Co. CALEDONIA, ONT.

Ridgedale Farm Holstein-Friesians for Sale.
3 yearling bulls; also bull and heifer calves; all of choice breeding. Prices always reasonable. Write, or come and see them. **R. W. WALKER,** Utica P. O. Shipping stations: Port Perry, G. T. R.; Myrtle, C.P.R. om

HOLSTEINS, TAMWORTHS, COTSWOLDS.
Present offering: Young boars and sows fit to breed, and younger ones. Choice animals. Ram and ewe lambs and two 2-shear rams. Perfect covering.

E. O. MORROW, Hilton P. O., Brighton Sts.,

4 HOLSTEIN BULLS 4
For Sale: From 4 to 7 months old, having sires in their pedigrees from such strains as Inka, Netherland, Royal Aagrie, and Tritonia Prince, and out of imported females that have proven their worth at the fair. **THOS. B. OAKLAW & SON,** Warkworth.

LYNDALE HERD
now offers for sale Holstein stock of all ages, calves of both sexes, sired by Lady Waldorf's De Kol, whose dam has an official record of 22 lbs. 5 oms. In 7 days, and 86.84 lbs. in 30 days; his sire being De Kol 2nd's Butter Boy 3rd. This herd won gold medal at Ottawa and 1st prize at Sherbrooke and Brookville, including Senator Fulford's special for best dairy herd of any breed.

BROWN BROS., LYN, ONT.

JERSEYS:
Present offering: Two bulls, 8 months old; solid color; choice animals; sired by Nero of Glen Rouge, and out of deep-milking dams.

E. B. MINMAN & SONS, GRAFTON, ONT.

St. Lambert Bull,
15 months old; solid color.
Strong and vigorous. His dam, sire's dam and her dam and grandam are all tested cows. This bull is a snap for a St. Lambert fancier. Also young bulls sired by Brampton Monarch (imp.) and out of tested show cows, and ewes and heifers in calf to him. For prices, etc., address

B. H. BULL & SON, BRAMPTON, ONT.
G. T. R. and C. P. R. stations.

JERSEYS, COTSWOLDS, YORKSHIRES.
Registered Jersey cattle, Cotswold sheep and Yorkshire pigs for sale. A few nice heifers, 6 mos. to 2 years, and 1 yearling bull, by Count of Pine Ridge, grandson of Adelaide of St. Lambert, record 84 lbs. milk daily. om **WM. WILLIS, NEWMARKET, ONT.**

LAWNRIE STOCK FARM.
Jerseys for Sale. Yearling bull and bull eight months old. Registered cows and heifers of choicest breeding and individuality. Some fresh and others coming in soon. 100 head to choose from.

J. L. CLARK, Norval station: G. T. R. Norval P. O.

DO YOU WANT A SNAP?
Jersey cows and heifers, also two young bulls, at low prices, from prizewinning stock. Write for prices.

W. W. EVERITT, Dun-edin Park Farm, GETHAM, ONT.

Best Jersey Bulls
AT LOWEST PRICES.
Owing to the large sale of registered Jersey cows, all in milk (18 head), that I have just made, I offer several bull calves, of unsurpassed breeding and from tested dams, at prices that will surprise purchasers. This, because the sale of 80 many cows in profit leaves me short of milk for the present. Also some choice heifers in calf.

Mrs. E. M. Jones, Brockville, Ont.
Box 324. om

LIVE STOCK EAR LABELS.
Send for circular and price list and tack it up on the wall where you can see it when you want it.

R. W. James, Bowmanville, Ont.

FREE **GOLD WATCH**
LADY'S OR GENT'S SIZE
Double Hunting Case, beautifully Gold finished and richly engraved in handsome Solid Gold design, stem wind and set, imported jeweled works, accurate and reliable. A very beautiful watch. Looks worth \$25.00. We give it, 1st, for selling at 15c. each only 1 doz. Canadian Home Cook Books and getting 3 other agents to do the same, or 2nd, for selling in all 7 doz. yourself. These Books are nicely printed, beautifully bound and each contains 139 choice recipes. Write to-day and we will send you the Cook Books postpaid. You can easily sell them in a few minutes. **Every housekeeper buys one. Don't miss this grand chance. Home Specialty Co., Dept. 565, Toronto, Ont.**

LADY'S WATCH
FREE 1st for selling at 15c. each, only 10 14K gold finished, Scarf Plus and securing 3 other Agents to do the same, or 2nd, for selling in all 7 doz. yourself. These Plus come in 4 styles: a Deer's head with a brilliant gem set between the antlers, a dainty Butterfly set with an electric Diamond, a Tortoise set with a splendid imitation precious stone, and an Owl holding a rainbow tinted Opal in its claws. These Plus are equal to anything sold by jewelers at \$1.00. At our price, 15c., you can sell dozens in a few minutes. This watch is a little beauty with silver nickel case, fancy decorated dial, gold hands and stem wind and set, reliable imported works. Write to-day and we will send you the Scarf Plus postpaid. **National Jewelry Co., Dept. 561, Toronto, Ont.**

FREE **GOLD WATCH**
LADY'S OR GENT'S SIZE
Double Hunting Case, beautifully Gold finished and richly engraved in handsome Solid Gold design, stem wind and set, imported jeweled works, accurate and reliable. A very beautiful watch. Looks worth \$100.00. We give it for doing two things: (1) Selling at 15c. only 1 doz. packages of Lemon, Vanilla and Almond Flavoring Powders, (2) getting 3 other agents to do the same, or by selling 3 doz. yourself. One package equals the worth of Liquid Flavoring and is far better. **Everybody buys.** You can earn in a few minutes. Write to-day and we will send the Flavoring Powders postpaid. **THE HOME ART CO., DEPT. 505, TORONTO.**

WALKING DOLL **FREE**
For selling at 15c. each only 1 doz. Canadian Home Cook Books. These books are nicely printed, beautifully bound, and each contains 139 choice recipes. **Everybody buys one.** This wonderful walking doll is a little beauty, dressed in satin, trimmed with elegant lace. She has jointed neck and arms, golden rinctels, and when you wind up walks as naturally as any living child. Write to-day and we will send the Cook Books postpaid. **Home Art Co., Dept. 561, Toronto.**

LADY'S WATCH
FREE (1st) for selling at 15c. each, only 10 14K gold finished, stone set, Slide Lockets, and getting 3 other Agents to do the same, or 2nd) for selling 30 yourself. These beautiful Lockets, set with brilliant imitation precious stones, look cheap at 50c. At 15c. they go like wildfire. You can earn this watch in a few minutes. It is a little beauty with silver nickel case, fancy decorated dial, gold hands and stem wind and set, reliable imported works. Write to-day and we will send the Lockets postpaid. **THE AGENTS TRADING CO., DEPT. 561, TORONTO, ONTARIO.**

FUR SCARF **FREE**
Soft, warm, glossy black, 3 feet 6 inches long, 6 in. less wide, made of selected full furred skins with 6 fine full black tails. A hand some, stylish Fur given 1st for selling at 15c. each only 7 14K gold finished, stone set Slide Lockets and getting 3 other Agents to do the same, or 2nd) for selling 14 yourself. These beautiful Lockets, set with brilliant imitation precious stones, look cheap at 50c. At 15c. they go like wildfire. Write to-day and we will send the Lockets postpaid. **THE AGENTS TRADING CO., DEPT. 561, TORONTO, ONTARIO.**

FREE OPAL RING
made of Solid Gold alloy, handsomely designed and set with three large beautiful Opals that show all the gorge-ous colors of the rainbow. A very handsome and stylish ring, given free for selling at 15c. each only 1 doz. packages of Lemon, Vanilla and Almond Flavoring Powders. One package equals 25c. worth of Liquid Flavoring and is far better. **Everybody buys.** Write to-day and we will send you the Flavoring Powders postpaid. You can easily sell them and earn this beautiful Opal Ring in a few minutes. **Home Art Co., Dept. 575, Toronto.**

WALKING DOLL **FREE**
For selling at 15c. each only 10 large packages of Lemon, Vanilla and Almond Flavoring Powders. One package equals 25c. worth of Liquid Flavoring and is far better. **Everybody buys.** This wonderful walking doll is beautifully dressed in satin, trimmed with elegant lace. She has jointed neck and arms, golden rinctels, and when wound up walks as naturally as any living child. Write to-day and we will send the Flavoring Powders postpaid. **THE HOME ART CO., DEPT. 561, TORONTO.**

9 CORDS IN 10 HOURS

BY ONE MAN with the FOLDING SAWING MACHINE. It saw down trees. Saws any kind of timber on any ground. One man can saw more with it than 5 in any other way. Man'd at Essex Centre, Ontario. No duty to pay. Write Main Office for illustrated catalogue showing latest IMPROVEMENTS, and testimonials from thousands. First order source agency. Address: FOLDING SAWING MACHINE CO., 55-57 59 St. Jefferson St., CHICAGO, ILL.

GILLETT'S
PURE POWDERED
LYE

BEST,
PUREST,
STRONGEST.

E. W. GILLETT COMPANY LIMITED Toronto, Ont.

"Baby's Own Soap"

Beware of using imitations of our celebrated BABY'S OWN SOAP

It stands at the top for purity. Most imitations are harmful for delicate skins.

Baby's Own Soap is made only by the ALBERT TOILET SOAP CO., MFRS. MONTREAL.

See our name on every box. 1-2

Homecroft Stock and Dairy.
Ayrshires, Chester Whites, B. P. Rooks. Write us for best young bull in Canada. Some A 1 bull calves; also some beauties for young sows. See that you look up our chickens.

J. F. PARSONS & SONS, BARNSTON, QUE.

Menie Stock Farm
Choice young AYRSHIRE bulls and heifer calves, from 2 to 9 months old. Also cows and heifers all ages. Write WM. STEWART & SON, Menie, Ont.

Maple Cliff Dairy and Stock Farm
BREEDERS OF AYRSHIRE CATTLE, BERKSHIRE AND TAMWORTH PIGS.
Cattle of both sexes in single or carload lots. Pigs both sexes, pairs not akin. Farm adjoins Central R. REID & CO., Experimental Farm. Bintonburg, Ont.

FOR SALE: High-class IMPORTED AND HOME-BRED AYRSHIRES, including cows, heifers and young bulls out of our prize and sweepstakes cows. Foundation selected with due regard to quality and productiveness. Come or write.

WM. WYLIE, - HOWICK, QUEBEC.

A QUICK, SHARP CUT
hunts much less than a bruise, crush or tear. Done with the **DEHORNING KEYSTONENIFE** is the safest, quickest, sharp cut. Cuts from four sides at once. Cannot crush, bruise or tear. Most humane method of dehorning known. Took highest award World's Fair. Write for free circulars before buying.

Owned and Manufactured by R. A. MCKENNA, V.S., Picton, Ont.

GOSSIP.
Mr. John Isaac, Markham, reports having had his second importation of Shorthorns for this season landed safely at Quebec on the 11th inst., by the steamship Tritonia of the Donaldson Line.

Volume 48 of the English Shorthorn Herdbook, by courtesy of the editor, has been received at this office. It is a creditable volume of over 1,000 pages of good paper, well printed, and evidently compiled with great care.

Mr. H. Chandos-Pole-Gall, an enthusiastic and wealthy English breeder of Clydesdale and Shire horses and Shorthorn cattle, died October 31st, 1902, in his 74th year. He is reported to have said: "It is not the money value that makes me like Shorthorn breeding, but the animals themselves and the general good they do the country at large."

On November 10th, at Chicago, a sale of Shorthorns was held, composed of cattle from the herds of E. K. Thomas, of Kentucky, and C. E. Blogett, of Wisconsin, at which fifty-one head sold for an average of \$305.50. The highest price, \$1,150, was paid for Imp. Golden Rose 2nd, a roan four-year-old cow, sired by Bell-the-Cat, Imp. Lady Miranda brought \$790, and Imp. Dalmeny Princess 4th sold for \$885.

At a combination sale of several breeders of Hereford cattle, at Sioux City, Iowa, Nov. 7-8, the attendance was small and the bidding slow, though the cattle were good and worth more money had a more appreciative company been present. Six hundred dollars was the highest price reached, and that for Florimel, a five-year-old cow by Correcion. Three hundred and five dollars was reached for one cow and \$300 each for two others.

At a combination sale of Aberdeen-Angus cattle, held at Chicago, November 5th and 6th, 79 head were sold for an average of \$387.40. Sixty-five females averaged \$431.65, and fourteen bulls \$182.85. The highest price was \$1,050, for the two-year-old heifer, Imp. Pride of Aberdeen 167th, by First Quality, Blackbird of Denison 33rd, a three-year-old cow, brought \$1,010. The highest-priced bull was Blackbird of Edgewood 2nd, sold for \$725.

That was a good sale of pedigreed swine made at auction by Mr. Arthur Hiscock, at Motcombe, Dorset, England, on October 31st, when 70 Berkshires brought an average of £12 9s. 4d. (\$62), the highest price being 61 gs. (\$320) for the sow, Manor Perfection, bought by Hon. C. Portman. The sow, Ethel, was bought for Mr. Vanderbilt's Biltmore Farms, U. S. A., at 50 gs. Fifty-two Large Yorkshires brought an average of £8 3s. 6d. (\$41), the highest price being 17½ guineas for Walton Star, sold to Mr. A. J. Carpenter.

Mr. A. D. McGugan, breeder of Shorthorns, writes: "The old champion, Abbotsford, has again changed hands. For the past three years he has been at the head of the herd of A. D. McGugan, Rodney, where he has done splendid service, and he is now at the head of the fine Scotch herd of Mr. J. W. Hartman & Sons, Elmledge, Ont. Although now ten years of age, he is as active and useful as ever. Mr. McGugan has purchased the grand young bull Aberdeen Hero, bred by A. Watson, Achronie, and of the same family, bred by the great Lord Buff, and we should expect splendid results from his use in this well-known herd."

King of Clydes, the superior Clydesdale stallion, portrayed on another page in this paper, property of Hon. Thos. Greenway, Crystal City, Man., has a splendid record as a prizetaker, having won first prize at the Canadian Horse Show, at Toronto, as a three-year-old, in the spring of 1900, and first prize at the Toronto Industrial Exhibition in the fall of the same year. At the Winnipeg Industrial, this year, he won first in the class of mature Clydesdale stallions and the sweepstakes as best draft horse any breed. He is a horse combining sufficient size with superior form, quality and action, and his breeding is of the very best being sired by Ringleader, by Corsewell, by Prince of Kelvin, and his dam was by Young Darnley, by the noted Darnley (222), one of the greatest of Clydesdale sires.

OFFICIAL RECORDS OF GUERNSEY COWS.
The secretary of the American Guernsey Breeders' Association publishes official records of a year's production that have been made by Guernsey cows. In this statement the names of twenty-four cows are given that have produced, within the year, from 6,590.78 to 11,622.65 lbs. milk, and from 313.57 to 602.27 lbs. butter-fat. These records, says the secretary, being for butter-fat, to be compared with butter tests as usually published, should have one-sixth added to the butter-fat. Thus the record of Portia of Maplehurst, the highest on the list, 602.37 lbs. butter-fat, would be equivalent to 702.7 lbs. butter, which he claims is the largest year's record of any cow made under regular and careful public supervision and test each month.

WE WANT TO REACH ROUND

To the homes of every Japan Tea drinker in Canada by sending FREE by mail a large sample packet of the better, uncolored, undoctored Tea as below.

"SALADA"

Natural Green Tea of Ceylon. It's delicious, British Grown, and Pure to a Leaf— Sealed Lead Packets only— same form as the Famous Black Teas of "SALADA" Brand. Your address on a postal will bring response. "SALADA," TORONTO.

AYRSHIRES
WATSON OGILVIE, PROPRIETOR.

Ogilvie's Ayrshires won the herd and young herd prizes at Toronto, London and Ottawa in 1900; also at the Pan-American, in 1901, and in 1902 they won all the herd prizes and medals, sweepstakes and diplomas, with one exception. The cows are all imported, and were carefully selected for strength and constitution, style, size of teats, and milk (quantity and quality). The herd is headed by Douglassdale (imp.), champion at the Pan-American and at Ottawa, Toronto and London, in 1902, ably assisted by Black Prince (imp.). Stock, imported and home bred, for sale at all times.

ROBERT HUNTER, Manager.
Near Montreal. One mile from electric cars. Lachine Rapids, P. Q.

W. F. STEPHEN, Trout River, Que., breeder of Ayrshire Cattle. A few choice bull calves for sale at reasonable prices; sired by Klondike of St. Annes 8897, and from deep milkers with good udder and teats. Carr's Crossing, 1 mile, G. T. R.; Huntingdon, 5 miles, S. L. & A. R. o

DAVID A. McFARLANE, Kelso, P. Q. Breeder of high-class AYRSHIRES. Young stock for sale from imported and home-bred foundation. Prices reasonable.

SPRING BURN STOCK FARM
H. J. WHITEKER & SONS, PROPS. Breeders of North Williamsburg, Ont. AYRSHIRE CATTLE, OXFORD DOWN SHEEP, BERKSHIRE PIGS AND BLACK JAVA FOWLS. For Sale: 5 Bulls, from 6 to 12 months old. Females any age. One 2-year old ram, six shearing rams, and five ram lambs. Winchester, C. P. R. Morrisburg, G. T. R.

AYRSHIRE FEMALES FOR SALE
Carrying the same breeding as our prize-winners, including such offspring as Floss and Tom Brown, the World's Fair winners. We breed for constitution, quality, and production. DAVID BENNING & SON, Williamstown, Ont.

AYRSHIRE CATTLE, Shropshire sheep, Berkshire pigs, and B. P. Rock fowl. A fine lot of shearing and ram lambs for sale. J. Yuill & Sons, - Carleton Place, Ont.

Tredinnock Ayrshires.
Imported bulls at head of herd: Glencairn 3rd, Napoleon of Auchrain, and Lord Dudley. Forty imported females, selected from leading Scotch herds, and their produce from above-named bulls. Size combined with quality and style, well-formed udders, good-sized teats, and capacity for large milk production. Bull calves for sale; also a few young cows and heifers. For prices and particulars address JAMES BODEN, Mgr., St. Anne de Bellevue, Quebec. Farm close to St. Anne Station, G.T.R. & C.P.R., 20 miles west of Montreal.

CHOICE AYRSHIRES.
Present offering: 4 bulls, from 1 to 2 years old, by choice sires, and out of producing dams, and A 1 individuals. N. DYMENT, Clappison P. O., Dundas Sta. PLEASE MENTION FARMER'S ADVOCATE.

AYRSHIRES AND LEICESTERS
We breed for milk and quality, and employ only the best sires. Are now offering young Ayrshires of both sexes. DONALD CUMMING & SONS, Lancaster, Ont.

AYRSHIRES FOR SALE. 2 two-year-old bulls, 2 yearling bulls, and a number of spring calves, both sexes, from deep-milking dams. Prices reasonable. F. W. TAYLOR, Willman's Corners, Ont.

SPRINGHILL FARM. Importers and breeders of choice, deep-milking Ayrshires. Males and females for sale. ROBERT HUNTER & SONS, Maxville, Ont.

HIGH-CLASS AYRSHIRES.
We are now through exhibiting, and offer at bargain prices, if taken before going into winter quarters, the following prizewinning bulls: The winner of 4th prize at Toronto as yearling, and four other 1st prizes; sired by Caspian of St. Annes (imp.). The August, 1901, calf, a very promising light-colored one, sire Hover-a-Blink, Two February, 1902, calves, winners of 3rd and several other 1st and 2nd prizes elsewhere; and an Apr 1, 1902, winner of 4th prize at Toronto. All sired by Prince of Bartheskie (imp. in dam), and light-colored. Two August, 1902, bull calves from imported sires and dams. Correspondence solicited. ALEX. HUME & CO., MENIE P. O., ONT.

Ayrshire Bulls. Two choice August (1901) bulls. Four March (1902) calves, by imported bull and out of dams from imported stock. All good ones. W. W. BALLANTYNE, ("Neidpath Farm" adjoins city.) Stratford, Ont. Main line G. T. R.

FOR SALE:
Three grandly-bred Ayrshire bull calves, 12 to 15 mos. old. Also young calves, by Napoleon of Auchrain (imp.), whose dam has a record of 72 lbs. of milk per day. A few choice young Berkshire and Yorkshire sows could be served before shipping. Collier pups, from Perfection Queen. Address—

T. D. McCALLUM, Danville, Que.
Nether Lea, -om
AYRSHIRES AND YORKSHIRES.
My Ayrshires are all bred from imported stock; Yorkshires from Mr. D. C. Platt's imported stock. Choice young animals for sale. James McCormick, Sr., Rockton, Ontario.

WINDMILLS



DO YOU WANT TO **SAVE** Time, Labor, Money ?

CANADIAN AIRMOTOR

Will do it for you. Always at your service.

ONT. WIND ENGINE & PUMP CO. LIMITED. TORONTO, ONT.



GIRLS LOOK

Little Princess, the prettiest doll in the world, nearly 3 ft. high, elegantly dressed from head to foot in silks and satins, lace and velvet with stylish hat, dainty little slippers, real stockings, and lace-trimmed under-clothing. Can be dressed and undressed like any live baby. As pretty as a fairy Princess, rosy cheeks, pearly teeth, beautiful eyes and golden ringlets. Can stand alone or sit in a chair. Given for selling at 15c. each only 12 1/2c. Gold finished Scarf Pins. These Pins come in 4 styles—a Deer's Head with a brilliant gem set between the Antlers, a dainty Butterfly set with an Electric Diamond, a Tortoise set with a splendid imitation precious stone, and an Owl holding a rainbow tinted Opal in its claws. These Pins are equal in appearance to anything sold by Jewellers at \$1.00. At our price 15c. you can sell dozens in a few minutes. Just try them. Write to-day and we will send the Scarf Pins postpaid. The National Jewelry Co., Dept 570, Toronto, Ontario.

LADY'S WATCH FREE for doing two things: (1) Selling at 15c. each only 10 Canadian Home Cook Books. (2) Getting three more agents to do the same, or by selling 20 yourself. These Books are nicely printed, beautifully bound and each contains 75 choice recipes. You can easily sell the Cook Books and earn this watch in a few minutes. It is a little beauty, with silver nickel case, fancy decorated dial, gold hands and stem wind and set, reliable imported works. Write to-day and we will send the Cook Books postpaid. Premium Co., Dept. 561, Toronto

FUR SOAK FREE Soft, warm, glass-black, 3 feet 6 inches long, 5 in. wide, made of selected full fur skins with 6 fine full black tails. A hand some stylish Fur given 1st for selling 15c. each only 7 Canadian Home Cook Books and getting 3 more Agents to do the same, or 2nd, by selling 24 yourself. These Books are nicely printed, beautifully bound, and each contains 75 choice recipes. Every Housekeeper buys one. Write to-day and we will send the Cook Books postpaid. You can easily sell them and earn this elegant Fur in a few minutes. **HOME SPECIALTY CO., DEPT. 562, TORONTO.**

EUROPEAN ADVERTISEMENTS.

HAMPSHIRE DOWN SHEEP.

"RESERVE" FOR CHAMPION IN THE SHORT-WOOL CLASSES, SMITHFIELD, LONDON, 1901.

Splendid Mutton, Good Wool, Great Weight.

This highly valuable ENGLISH BREED OF SHEEP is unrivalled in its wonderfully early maturity and hardness of constitution, adapted to all climates, whilst in the quality of mutton and large proportion of lean meat it is unsurpassed; and for crossing purposes with any other breed, unequalled. Full information of

JAMES E. RAWLENCE, SECRETARY HAMPSHIRE DOWN SHEEP BREEDERS' ASSOCIATION, SALISBURY, ENGLAND.

Shorthorn Cattle and Lincoln Longwool Sheep.

HENRY DUDDING

Riby Grove, Great Grimsby, Lincolnshire,

Has always for inspection and sale the largest flock of pure Lincoln sheep and Shorthorn herd in the country, and many prizewinners. The sheep are famous for their great size, fine, lustrous wool, and 150 years' good breeding, and at the home sales have made the highest prices on record. The Shorthorns comprise the best Bates, Booth, and Scotch blood, including the best prize strains of Duthie, Marr, Willis, and Harrison. During the last year 86 prizes have been taken by the Riby Shorthorns and Lincoln sheep at the leading shows in England.

Cables: Dudding, Keeiby, England.

REGISTERED Southdown Sheep, Suffolk Sheep AND Berkshire Pigs.

THE Cheveley flocks and herds, the property of Col. H. L. B. McCalmont, C.B., M.P., are unique for the purity of their blood, typical character, and individual merit. In their foundation, etc., no expense has been spared in securing the best and most perfect specimens of the different breeds. In each case full records are kept of individual pedigrees, so that any selections made from these flocks will, in addition to being of the highest merit and typical character, have also the great advantage of individual pedigrees.

The Southdowns have secured the highest show-yard honors during 1900 and 1901 at the leading English shows; in the latter year, besides winning the champion prize, gold medal and breed cup at Smithfield Show, two medals for best Southdown, six firsts, three seconds and numerous minor awards were won at Royal, Birmingham, Royal Counties shows, etc. The Suffolks are equally well bred, and numerous prizes have also been won. In fact, for individual merit, pedigree, and purity of breeding, it would be difficult to find better and more suitable flocks of either of these breeds from which to perpetuate their high individual merits. Apply to—

H. J. GARROD, Cheveley, Newmarket, England.

W. W. CHAPMAN,

Secretary of the National Sheep Breeders' Association, Secretary of the Kent or Romney Marsh Sheep Breeders' Association, and late Secretary of the Southdown Sheep Society.

Pedigree Live Stock Agent, Exporter and Shipper. All kinds of registered stock personally selected and exported on commission; quotations given, and all enquiries answered.

Address: FITZALAN HOUSE, ARUNDEL ST., STRAND, LONDON W. W.

Cables—Sheepcote, London.

Robert W. Hobbs,

Kelmseott, Lechlade, England.

One of the largest flocks in Oxford Down Flockbook. Numerous prizes obtained for ram lambs at principal shows. Rams and ewes always on sale.

FAMOUS ALL OVER THE WORLD

ALFRED MANSELL & CO., LIVE STOCK AGENTS AND EXPORTERS, SHERWESBURY.

BRITISH STOCK selected and shipped to all parts of the world. Write for prices to ALFRED MANSELL & CO., Sherwesbury, England, or to our American representative, Robert Miller, Stouffville, Ont., Canada.

JOHN BRYAN & SON, Southleigh, Witney, Oxon. — One of the oldest registered flocks of pure-bred Oxford Downs. Annual sale of rams. Oxford ram fair. Rams and ewes for sale at home. Inspection invited.

English Shorthorns.

Booth and Bates Shorthorns, topped with Oriskany shank bulls. Young cows, bulls and heifers always on hand for sale. Eligible for the American herdbook. Royal and Highland prizewinners included for the last two years. Close on \$400 won in prizes last year and this. **WM. BELL,** Ratcheugh Farm, Alnwick, Northumberland, Eng.

Dorset Horn Sheep

THE largest flock in America. The most celebrated prizewinners at the Columbian Exhibition and Canadian exhibitions. Contains more Royal winners than any other. Awarded 5 out of 8 first prizes at Toronto, London and Ottawa in 1900. Flock of 300. Stock for sale always on hand.

John A. McGillivray, Uxbridge, Ontario.

I Can Sell Your Farm

or other real estate for cash, no matter where located. Send description and selling price and learn my wonderful successful plan. **W. M. OSTRANDER,** North American Building, Philadelphia, Pa.

PLEASE MENTION FARMER'S ADVOCATE.

THE SHEEP OF THE CENTURY.

PRINCIPAL AWARDS GAINED BY SUFFOLKS AND SUFFOLK CROSSES IN OPEN COMPETITION AGAINST ALL BREEDS, 1898 TO 1901.

SCOTTISH NATIONAL FAT STOCK SHOW—			
Championship of the yard	1898	1900	1901
Reserve number for ditto	1899	1900	1901
SMITHFIELD CLUB SHOW—			
Championship of the yard	1899	1900	1901
Reserve number for ditto	1898	1900	1901
Breed cup—cross-bred section	1899	1900	1901
SMITHFIELD CLUB SHOW (Carcass Competitions)—			
Centenary gold medal (best carcass in the yard)	1898	1900	1901
Reserve number for ditto	1898	1900	1901
First prize—Short-wool lambs	1898	1900	1901
Second prize— " " "	1898	1899	1901
Third prize— " " "	1899	1900	1901
Fourth prize— " " "	1899	1900	1901
First prize—Short-wool wethers	1898	1900	1901
Second prize— " " "	1898	1900	1901
Third prize— " " "	1898	1900	1901
First prize—Long-wool wethers	1898	1900	1901
Second prize— " " "	1898	1900	1901
Third prize— " " "	1898	1900	1901

AN UNEQUALLED RECORD. Pamphlet, with full description of the breed, show-yard honors, live and dead weights of rams, ewes and lambs, can be obtained on application to **ERNEST PRENTICE, Secretary Suffolk Sheep Society, IPSWICH, ENGLAND.**

LITTLE'S PATENT FLUID SHEEP DIP AND CATTLE WASH

THE ORIGINAL Non-Poisonous Fluid Dip

Still the favorite dip, as proved by the testimony of our Minister of Agriculture and other large breeders.

For sheep. Kills ticks, maggots; cures scab; heals old sores, wounds, etc., and greatly increases and improves growth of wool.

Cattle, horses, pigs, etc. Cleanses the skin from all insects, and makes the coat beautifully soft and glossy.

Prevents the attack of Warble Fly.

Heals saddle galls, sore shoulders, ulcers, etc. Keeps animals free from infection.

No danger, safe, cheap, and effective

Beware of imitations. Sold in large tins at 75 cents. Sufficient in each to make from 25 to 40 gallons of wash, according to strength required. Special terms to breeders, ranchmen, and others requiring large quantities.

SEND FOR PAMPHLET. Sole agent for the Dominion, **Robert Wightman, Druggist, Owen Sound**

SHEEP BREEDERS' ASSOCIATIONS

American Shropshire Registry Association, the largest live stock organization in the world. Hon. John Dryden, President, Toronto, Canada. Address correspondence to MORTIMER LEVERING, Secretary, Lafayette, Indiana.

SHROPSHIRE FOR SALE—Shearing rams, ram lambs, ewe lambs, also shearing and older ewes, about 50 head all told. All registered or eligible. Low set, well covered, in fine condition and form. Sires from Campbell and Dryden flocks. **MALCOLM McDOUGALL,** Tiverton, Ont.

PRIZEWINNING COTSWOLDS. Imported and home-bred stock, prizewinners at all the leading fairs. **ELGIN F. PARK,** Box 21, Burgessville, Ontario, Canada.

Southdowns and Collies

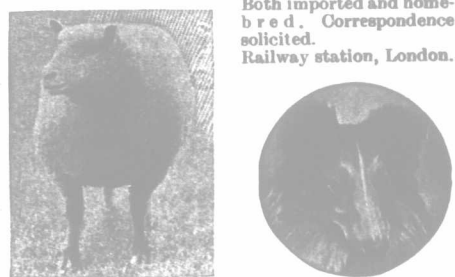

Both imported and home-bred. Correspondence solicited. Railway station, London.

SHROPSHIRE

Special Sale for This Month. 20 Ram Lambs, 5 Shearing Rams, and a Few Choice Ewe Lambs, of superior quality, by imported sires. Prices right, as we must have room.

ISALEIGH GRANGE FARM, DANVILLE, QUE.

SHROPSHIRE

One well-covered yearling ram, with good bone, from imported Mansell ram, and four home-bred ram lambs. Write for prices. **ROWAT BROS., HILLSDALE, ONT.**

This season I am offering for sale **SHROPSHIRE** lambs of both sexes. Also shearing ewes and 3 shearing rams. Prices right and quality guaranteed. **GEO. HINDMARSH, Allsa Craig, Ont.**

SHROPSHIRE

For sale—3 shearing rams, 12 shearing ewes, a number of 2- and 3-year-old ewes and this year's lambs; a low-down, well-covered lot. **C. H. ROWE, ORILLIA P. O. and STATION.**

PENNABANK STOCK FARM. Twenty-five ram lambs; a few ewe lambs and shearing ewes with Imp. William or Knox-bred sires; 1 good two-shear ram. Four fine young Shorthorn bulls. **Hugh Fugh, Whitevale, Ont.**

LEICESTER SHEEP.

Quality, with good size and wool. Address: **C. & E. WOOD, FREEMAN P. O. BURLINGTON ST., ONT.**

Oxford Downs. Present offerings: A choice lot of ram and ewe lambs fit for show, and also one three-year-old ram and one two-year-old ram, one very superior shearing ewe. The above are all fit for show. **SMITH EVANS, Gourock, Ont.**

FAIRFIELD LINCOLNS

Imported ewes and lambs. Can supply show flocks. **J. H. PATRICK, ILBERTON, ONT., CAN.**

Dorsets and Chesters Young stock in Dorset Sheep and Chester White Hogs of good quality for sale, reasonable. **R. H. HARDING, THORNDALE, ONT. "Mapleview Farm."**

W. S. CARPENTER, "MODEL FARM," SIMCOE, ONT.

Importer and breeder of Shropshire sheep. My flock was represented at Toronto, and won first on shearing ram, first and second on aged ewe, and second on the pen. First time exhibiting. If in need of a first-class yearling ram, imported or home-bred, write! Your wants can be supplied, and at prices consistent with quality. Have a choice lot to choose from, and can guarantee satisfaction. Come and see them, or a card will bring them. **Station One-half Mile from Farm, Wabash and G. T. R.**

LEICESTERS.

A splendid lot of rams and ram lambs for sale. Price reasonable. **MAC. CAMPBELL, NORTHWOOD, ONT.**

SHROPSHIRE

We have for sale sixteen Shropshire yearling rams and 12 ewes, from Cooper and Mansell ewes, and sired by Mansell ram, also an extra good lot of ram lambs.

JOHN MILLER & SONS, BROUGHAM, ONT. CLAREMONT STATION, O. P. R.

American Leicester Breeders' ASSOCIATION.

A. W. Smith, Pres., Maple Lodge, Ont. Pedigrees now being received for Vol. 4. For information, blanks, etc., address:

A. J. TEMPLE, GEO., CAMERON, ILL. U. S. A.

FOR SALE, AT MAPLE AVENUE STOCK FARM, CHIOPE

Lincoln Sheep and Shorthorn Cattle

Bred from best English stock. Bred from Scotch bulls of fashionable families. CAN SUPPLY EITHER IN CARLOAD LOTS. Write us before buying elsewhere. Address: **F. H. NEIL, Proprietor, LUAN, ONT. Box 35. Telegraph and Railway Station.**

Going to Bed Hungry.

It Is All Wrong and Man Is the Only Creature That Does It.

The complete emptiness of the stomach during sleep adds greatly to the amount of emaciation, sleeplessness and general weakness so often met with. There is a perpetual change of tissues in the body, sleeping or waking, and the supply of nourishment ought to be somewhat continuous, and food taken just before retiring adds more tissue than is destroyed, and increased weight and vigor is the result. Dr. W. T. Catnell says: "All animals except man eat before sleep, and there is no reason in nature why man should form the exception to the rule."

If people who are thin, nervous and sleepless would take a light lunch of bread and milk or oatmeal and cream and at the same time take a safe, harmless stomach remedy like Stuart's Dyspepsia Tablets in order to aid the stomach in digesting it, the result will be a surprising increase in weight, strength and general vigor. The only drawback has been that thin, nervous, dyspeptic people cannot digest and assimilate wholesome food at night or any other time. For such it is absolutely necessary to use Stuart's Dyspepsia Tablets, because they will digest the food, no matter how weak the stomach may be, nourishing the body and resting the stomach at the same time.

Dr. Stevenson says: "I depend almost entirely upon Stuart's Dyspepsia Tablets in treating indigestion, because it is not a quack nostrum, and I know just what they contain—a combination of vegetable essences, pure pepsin, and they cure dyspepsia and stomach troubles because they cannot help but cure." Stuart's Dyspepsia Tablets are sold by druggists everywhere at fifty cents per package. They are in lozenge form, pleasant to take, and contain nothing but pure pepsin, vegetable essences and bismuth, scientifically compounded. Your druggist will tell you they give universal satisfaction.—Advt. om-

If Your Friend Is Sick

Tell Me the Book to Send.

No money is wanted—not from you nor from him. I ask only a postal card, and I ask it as an act of humanity.

Then I will do this: I will mail the sick one an order—good at any drug store—for six bottles of Dr. Shoop's Restorative. He may take it a month at my risk. If it succeeds, the cost is \$5.50. If the sick one even thinks it has failed, I will pay the druggist myself.

Please note what that means. I furnish a costly treatment that is out a lifetime in perfecting, and whenever it fails the test is entirely free. But failures are rare. My records show that 39 out of each 40 get well, and pay for the remedy gladly.

No other remedy, in chronic and difficult cases, could stand a test like that. The reason is this: My Restorative alone strengthens the inside nerves. There is no other way to bring back that nerve power which alone makes each vital organ do its duty. There is no other way to make weak organs well.

Simply state which book you want, and address Dr. Shoop, Box 52, Racine, Wis.

Mild cases, not chronic, are often cured by one or two bottles. At all druggists. om



FUR SOAF FREE

Soft, warm, glossy black, 3 feet 6 inches long, 5 inches wide, made of selected full fur, with 6 fine full black tails. A handsome, stylish Fur, given for doing two things, (1) selling at 10c, each in packages of Leaven, Vanilla and Almond Flavouring Powders, (2) getting 3 more cents to do the same, or by selling 20 years. If one package equals 20c worth of Liquid Flavouring, and is far better. Every house-keeper buys one or more packages. Write to-day for the Flavouring Powders and we will send the Fur in a few minutes. You can easily sell them and earn this extra Fur in a few minutes. Home Art Co., Dept. 562, Toronto.



FREE STEAM FIRE ENGINE

made entirely of steel, from brass, beautifully finished, with driving wheel, shaft and piston, polished brass boiler and steam chest. Runs on iron or steam. Gives for selling at 15c, each only 1 doz. Canadian Home Cook Books. These books are nicely printed, beautifully bound and each contains 75 choice recipes. Every house-keeper buys one. You can earn this wonderful Fire Engine in a few minutes. Write to-day and we will send you the Cook Books postpaid. THE HOME SPECIALTY CO., Dept. 571, Toronto

GOSSIP.

Mr. Wm. Ormiston, Jr., Columbus, Ont., breeder of Shorthorn cattle, in ordering a change in his advertisement, offers for sale seven young bulls and some heifers, and reports among sales due to his advertisement in the "Advocate," that of a young bull to Mr. W. Locher, Sunderland, Ont., and a heifer to Capt. T. E. Robson, Ilderton, Ont.

Mr. J. G. Truman, manager of the Pioneer Stud Farm, Bushnell, Ill., writes under date November 17th: "Our sixth importation of this year, consisting of Shire, Percheron and Suffolk stallions and Shire mares, arrived here on Thursday last. Our Mr. J. H. Truman came through from our place in England with them, and they are beyond any doubt the highest-priced and choicest lot of horses that ever left the shores of Old England. My father bought them for the express purpose to show at the coming International Show, and in addition to our large selection of stallions on hand will make us about 100 head of the best of the Old Country affords. We have not only quality, but we have the weight, as many of the stallions weigh from 2,200 to 2,300 pounds, and the mares up to 2,200 pounds. Many of them have won laurels in England, one to her credit something like twenty prizes, and was bought at Mr. Crisp's sale at a good round figure. The Shire stallions include Dunsmore Heirloom, bought from Sir P. A. Muntz, Dunsmore stud, a winner of over a dozen prizes, also Stainton Combination, a winner of several prizes; Duke X., one of the kind so much sought for but seldom found. Among the Suffolk stallions we have Ironsides, a winner of seventeen first and two second prizes in England, including the Royal; His Grace, another winner and has to his credit several other good prizes; Record is another of the right sort, and has to his credit a number of prizes at the different shows. In addition to these winners just imported, we have four Shires, all sired by the unbeaten Blaisdon Conqueror, for which Mr. Stubbs refused from us \$15,000.00, and related to the horse, Blaisdon Pluto, that we secured the gold medal with at the International Show last fall. To our readers that are anticipating buying a draft stallion we would ask them to apply for our catalogue and write us what they wish to buy, and we will be pleased to write them fully what we have and prices thereon. We also have a very select lot of dark grey and black Percherons, some of them prizewinners in France this year, with plenty of bone and scale, the three-year-olds weighing up to 2,100 pounds.

One of the most noted stock farms in Northern Ontario is Lakeview, situated in the Co. of Grey, 9 miles south-west of the flourishing town of Meaford, and is the property of Mr. James Bowes, breeder of up-to-date Shorthorn cattle. The herd at present numbers 23 head of Stamfords, Crimson Flowers, Marr Floras, Minas, Village Girls, Buchan Lassies and Lavinias, at the head of which stands the massive, well-formed and short legged bull, Royal Tim 23562, sired by imp. Royal Mever, dam Coristine 18744, by Wm 13079, grandam Onone 16825, by imp. Albert Victor. Royal Tim has proven his ability to sire exactly the kind of stock wanted to-day; he weighs, in breeding condition, 2650 lbs., and is the thickest bull through the heart the writer ever saw, with both ends in proportion. He is now 6 years old, and for sale. Village Girl, Vol. 18, by General Middleton 19407, dam Red Lily 25449, by Village Burgomaster, is a thick, even, red cow, built on true type lines. Buchan Lassie 18805, by Golden Lion 4994, dam Queen of Scots 3rd 4405, by High Sheriff 2nd, is an extra thick, well-balanced cow, smooth and graceful. Crimson Lily, by Scot's Nobleman 17391, dam Rose of Lynden 13072, by Barmpton Hero, is a red roan and an extra nice, even, smooth cow. Out of her is a one-year-old red bull, Crimson Tim, by the stock bull, that is considerably above the average in true type and superior quality. Maggie L. 2nd is a Marr Flora-bred cow, sired by Bell Duke of Oxford 17285, dam Maggie S. 22778, by Stanley of Allenford. She is a very thick roan cow, broad and massive and withal very smooth. Mina Princess 5th, Vol. 18, by imp. Royal Prince, dam Mina Princess 3rd, by imp. Sittytan Stamp, is a one-year-old and a right good one. That grand old milking family, the Lavinias, is represented by Ingram's Lass, by Arkell's Warrior 22485, dam Lily Ingram 21467, by Arthur Fitz Ingram. She is a nice, even, roan cow, and is the dam of a very thick, even, one-year-old roan bull, by the stock bull. There are also five or six heifers of this family that really are something extra good; all reds, low down, thick, square, smooth, and beef from the ground up. There are also two Stamford heifers, one one year old, the other two years old, the latter in calf. This pair are show heifers. There are also several other heifers belonging to the various families mentioned, and we feel safe in saying that any one in want of a dozen choice heifers will not be disappointed when he sees this lot. The animals are all in A1 condition, and anything in the herd is for sale. Write Mr. Bowes, to Strathairn P. O., Ont.

SUMMERHILL HERD OF Large English Yorkshires.

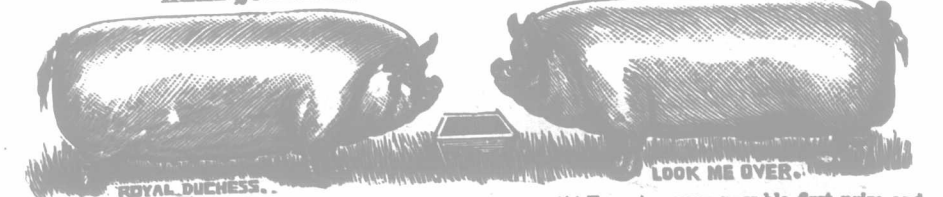

Our winnings at the large shows for 1901, are as follows: At Toronto every possible first prize and five seconds, two silver medals, and first for pen of pure-bred bacon hogs, also sweepstakes on bacon hogs over all breeds; at London every possible first but two; while at the Pan-American, where our herd was divided, half going to Toronto, we won six out of ten possible firsts, also sweepstakes on boar any age. At the Pan-American (Buffalo), Toronto and London there were thirty-six first premiums and medals given; all the medals and every first prize but six won by the Summer Hill Yorkshires. When in need of the best write D. C. FLATT & SON, MILLGROVE, ONT. om Telephone: Millgrove, Ont.

HILLCREST HERD OF Large English Berkshires

My brood sows are imported or show animals, and the sires are big, long fellows of the bacon type. For sale: An excellent lot of young pigs, and a few young sows recently bred. Can supply pairs not akin. Enquiries promptly answered. Vine station, G.T.R.—near Barrie. Jno. Lahmer, Vine, Ont.

HOLWELL MANOR FARM SHROPSHIRE.

Choice shearing rams at farmers' prices. A choice lot of ram and ewe lambs for sale.

D. G. GANTON, ELMVALE, ONT. om

IMP. COTSWOLD SHEEP

Five rams (year-olds), both sires and dams imp.; 10 ewes (year-olds), sire imp. Also this year's lambs, both sexes; Yorkshire and Tamworth hogs. om

BROOKS & LANGMAID, COURTYCE P. O.

BROAD LEA OXFORDS.

An offering at present 30 superior shearing ewes, bred to a good ram, and a number of ewe and ram lambs for sale at reasonable prices. Always pleased to hear from or see sheepmen, whether they buy or not. om

W. H. ARKELL, TEESWATER, ONT. Broad Lea Farm.

MILDMAY, G. T. R. 7 miles from farm. TEESWATER, C. P. R. 3 1/2 miles from farm.

SUMMERHILL OXFORDS.

Present offering: A choice lot of ram lambs and ewe lambs. Also 50 extra nice yearling ewes. om

PETER ARKELL & SONS, Teeswater P. O. and Station.

LINDEN OXFORDS

A choice lot of ram lambs (yearlings) and a few two and three shear rams fit for show and to head pure-bred flocks; imp. and home-bred, well covered, good quality. om

R. J. HINE, Dutton, Ont.

"FARNHAM FARM" Oxford Down Sheep

An offering 40 choice yearling rams to head flocks 50 superior yearling ewes. 70 ranch rams. 100 ram and ewe lambs of 1902. From imported sires, and a number from imported dams. All registered. Barred Rock eggs, 75 cents per setting. om

HENRY ARKELL, ARKELL, ONT.

GLENBURN STOCK FARM.

FOR SALE—Choice young Berkshire boars, ready for use; also young sows. Shorthorn calves. 2-year-old Shropshire ram, ram lambs, and Barred Rock cockerels. om

JOHN RACEY, JR., LENNOXVILLE, QUE.

Imported Chester Swine.

Our present offering is both sexes, all ages, bred from prizewinning and imported stock. We claim to have as good as the country produces, of the true bacon type. We guarantee everything just as represented. Write us, a trial will convince. Pairs not akin. om

GEO. BENNETT, CHARING CROSS P. O. AND STATION.

TAMWORTHS.

Young pigs for sale, from medal-winning sow, O. A. C. 110, and other good ones, sired by Imp. Starlight, Pan-American First, and Bold Boy, Toronto winner. JOHN HORD & SON, om Parkhill P. O. and Station.

Imported Poland-China Hogs.

We are offering choice, of both sexes, any age (pairs not akin), from imported stock, and of the true type. Easy feeders, rapid growers. ROBT. L. SMYTH & SONS, om Fargo P. O. and Station, M. C. R.

WILLOW LODGE BERKSHIRES

Herd headed by Long-fellow 10th of H. F., assisted by the noted prizewinner, Highclere Crown 3rd. Sows, the best money will buy, and are winners. Young stock of both sexes and all ages for sale, not akin. om

W. WILSON, SNELGROVE, ONT.

YORKSHIRES FOR SALE.

Boars fit for service, sows in farrow and ready to breed, and young stock on hand. Prices reasonable. om

WM. HOWE, BRUCE CO. NORTH BRUCE, ONT.

For the Next 30 Days.

Newcastle Herd of Tamworth Swine

Have for a number of years taken a share of the best prizes offered at Toronto Exhibition, but this year has excelled all past records, having taken the sweepstakes for the best herd; also both silver medals for best Tamworth boar and best Tamworth sow, besides many other prizes in the various classes. Our present offerings are several young sows, bred or just ready to breed; also a lot of beautiful young pigs of both sexes, just fit to wean and ship. They are all descendants of our sweepstakes om stock. They will be sold very reasonably during the next 30 days. Pairs supplied not akin. Enquiries promptly answered. Colwill Bros., Newcastle, Ont.

SNELGROVE BERKSHIRES

This old-established herd, having made a continental reputation, is not being exhibited this year, but we are still breeding Berkshires as good as ever, and of the right type for the present-day markets—large, lengthy and smooth. We have boars and sows four to eight months old, not akin, and young pigs two to three months. If you want the best, write us for prices and particulars. om SNELL & LYONS, Snelgrove, Ont.

Coldspring Herd Tamworths

Offer choice Oct. and Nov. boars and sows. Also my stock boar, Advance. This is the spot for the best. Write for prices. They are moderate, quality considered. om

NORMAN M. BLAIN, ST. GEORGE, ONT. BRANT CO.

Spring Brook Stock Farm.

An offering two choice Tamworth boars, ready for service; several sows, ready to breed; also a choice lot of young pigs, ready to wean. Also a few choice Holsteins to offer, of different ages. om

A. C. HALLMAN, BRESLAU, ONT. Waterloo Co.

PINE GROVE FARM HERD OF LARGE ENGLISH YORKSHIRES.

The oldest-established registered herd in America. We have 12 imported boars and sows and 20 home-bred animals breeding, and have a limited number of young boars and sows for sale, suitable for this fall's breeding. Satisfaction guaranteed in all mail orders. om

Joseph Featherston & Son, Streetville Station, G. P. R., and P. O. and Telegraph. Clarkson Station, G. T. R.



One hundred Tamworth and Improved Chester White Spring Pigs of a true bacon type, our herd having won the best prizes offered at the leading exhibitions throughout Ontario and Quebec for the past ten years. Stock for exhibition purposes a specialty. We pay express charges between stations, and guarantee safe arrival of all stock shipped. Pairs furnished not akin. Write for prices. om

H. GEORGE & SONS, Crampton P. O., Ont.

Yorkshires

For the next 3 months I can supply either sex, that for ideal bacon type, smooth, even finish, are unsurpassed. Prices reasonable. om

WM. TRASDALE, Thornhill Sta., and electric cars. Dollar P. O.

Large English Yorkshires

Imported and Canadian-bred Yorkshires, from stock of the best British herds. A choice lot of boars, ready for service, and a number of sows being bred to imported Dalmeny Long Sam, for sale. Also young pigs, all ages. om

H. J. DAVIS, Box 518. WOODSTOCK, ONT.

S. H. D. Chief 6th (Imp.) 9074

Farrowed March 17th, 1902.

Bred by Earl of Roseberry, Edinburgh, Scotland. I will deliver, transportation prepaid, this magnificent imported YORKSHIRE boar for \$40, anywhere in Ontario or Quebec.

GUS. LANGELIER, QUEBEC.

PLEASE MENTION FARMER'S ADVOCATE.

Large English Yorkshires

Sows safe in pig, boars fit for service, sows ready to breed, boars and sows 2 and 4 months old. Satisfaction guaranteed in orders received by mail.

JAS. A. RUSSELL, Precious Corners, Ont.

SPRUCE HERD OF YORKSHIRES. A few choice young boars for sale, 6 months old. Also pairs not akin, 8 weeks old. Sires, Summer Hill Member and Summer Dalmeny Topman 2nd (Imp.). on FRED. C. SMITH, New Hamburg, Ont.

YORKSHIRES AND POULTRY.

Young pigs, 3 weeks to 3 months old (bacon type), easy feeders, strictly choice. Winners for fall fairs in young White Wyandottes, Banded Plymouth Rocks (Hawkins strain) and White and Brown Leghorns—something extra. Also pedigreed collies. on A. B. ARMSTRONG, Codrington, Ont.

FOR SALE:

Yorkshires and Holsteins

Best type and quality. Young stock constantly on hand. Prices right. R. HONEY, on Brickley P. O., instead of Warkworth.

MEN! LOOK HERE



DO YOU SUFFER FROM LOST STRENGTH

Nervous Debility, Varicocele, Early Decay and Waste of Power? They are quickly and forever cured by the Grand Product of Nature, DR. McLAUGHLIN'S Electric Belt, with

FREE ELECTRIC SUSPENSORY FOR WEAK MEN.

This Electric Suspensory carries the current direct to the weak parts and cures all weaknesses of men, varicocele, etc. It develops and expands all weak organs and checks unnatural drains. No case of Falling Vigor, Varicocele or Debility can resist the powerful Electric Suspensory. It never fails to cure. It is free with Belts for weak men.

No man should be weak; no man should suffer the loss of that vital element which renders life worth living. No man should allow himself to become less a man than nature intended him; no man should suffer for the sins of his youth, when there is at hand a certain cure for his weakness, a check to his waste of power.

Most of the pain, most of the weakness of stomach, heart, brain and nerves, from which men suffer, are due to an early loss of nature's reserve power through mistakes of youth. You need not suffer from this. You can be restored. The very element which you have lost you can get back, and you may be as happy as any

man that lives. My Electric Belt, with Special Electric Suspensory (free), will restore your power. It will check all unnatural drains and give back the old vigor of youth.

Hollingshead, Woodbridge, Ont., says:—I feel well satisfied with the Belt. I have doctored and spent hundreds of dollars without relief, and your Belt has made a new man of me in every way. My step is firmer, and I am stronger in every part of my body. The drains have stopped altogether.

This drain upon your power causes Kidney Trouble, Rheumatism and Stomach Ailments. You know it's a loss of vital power and affects every organ of the body. Most of the ailments from which men suffer can be traced to it.

I have cured thousands of men who have squandered the savings of years in useless doctoring.

My Belt is easy to use; put it on when you go to bed; you feel the glowing heat from it (no stinging or burn, as in the old style belts), and you feel the nerves tingle with the new life flowing into them. You get up in the morning feeling like a two-year-old.

This is what Wm. Irvin of Haicro, Sask., writes me:—Before using your belt I was a complete wreck. I can now get up in the morning feeling just like a young fellow of 17. (My age is 58.) I cannot praise your Belt too much, and would like all my fellow-sufferers to give it a trial.

Old men of 70 write me that they feel as strong and young as they did at 35. That shows it renews the vigor of youth.

It cures Rheumatism, Sciatic Pains, Lumbago, Kidney Trouble. It banishes pain in a night, never to return.

You can read what Geo. A. Midgett, 178 Stanley Avenue, Hamilton, Ont., has to say about the Belt:—I must say that the Belt has done me good. It drives the pain out of my back. As I have been bothered since birth, mine is a very hard case. The Suspensory is a grand thing to build up the parts. I have the greatest faith in your Belt, and I must say you are the most honest man I ever dealt with. Most men, when they get your money, lose all interest, as that is all they care for. But you cure and your business ought to prosper. I have praised your Belt to the highest. I know it has done for me what doctors could not do.

What ails you? Write and tell me, and no matter where you are I think I can give you the address of some one in your town whom I have cured. I've cured thousands, and every man of them is a walking advertisement for my Belt.

Every man who ever used it recommends it, because it is honest. It does great work, and those whom I have cured are the more grateful because the cure costs so little.

Dr. McLaughlin's Offer to the Public.

You run no risk, as I guarantee every case I undertake. Failure to cure costs you nothing, as I take all the chances. All I ask is that you give me evidence of your honesty and good faith; that you are willing to pay me. By offering me reasonable security you may then use the Belt and

PAY WHEN CURED.

FREE! Write me to-day for my beautifully illustrated book with cuts showing how my Belt is applied, and lots of good reading for men who want to be "The Noblest Work of God"—A MAN. I will send this book, sealed, free.

DR. M. S. McLAUGHLIN, 130 Yonge Street, TORONTO, ONT.

Office Hours—9 a.m. to 8.30 p.m.

NEVER SOLD BY DRUG STORES OR AGENTS.



GIRLS LOOK

Little Princess, the prettiest doll in the world, nearly 2 feet high, elegantly dressed from head to foot in silks and satins, lace and velvet, with stylish hat, dainty little slippers, real stockings and lace-trimmed underclothing. Can be dressed and undressed like any live baby. As pretty as a fairy princess, rosy cheeks, pearly teeth, beautiful eyes and golden ringlets. Can stand alone or sit in a chair. Given free for selling at 15c. each only 1 doz. beautiful 14k Gold-Finished Stick Pins. These dainty Pins are in a variety of pretty designs set with exquisite imitation Turquoise, Diamonds, Rubies, etc. They look easily worth 50c., and at our price, only 15c. go like wildfire. Write to-day and we will send you the Stick Pins postpaid. The Maxwell Co., Dept. 570, Toronto



GIRLS LOOK

Little Princess, the prettiest doll in the world, nearly 2 feet high, elegantly dressed from head to foot in silks and satins, lace and velvet, with stylish hat, dainty little slippers, real stockings and lace-trimmed underclothing. Can be dressed and undressed like any live baby. As pretty as a fairy princess, rosy cheeks, pearly teeth, beautiful eyes and golden ringlets. Can stand alone or sit in a chair. Given free for selling at 15c. each only 1 doz. handsome pieces of Jewelry, Lockets, Stick Pins, Cuff Links, Hat Pins, etc. Every piece of our Jewelry looks worth 50c. At 15c. you can easily sell the 12 pieces in a few minutes. Write to-day and we will send the Jewelry postpaid. National Watch and Jewelry Co., Dept. 553, Toronto, Ontario.



\$2.69 Rain Coat worth \$8.00

SEND NO MONEY. Simply write us, giving your name, address, nearest express office and chest measurement and we will send you this coat free for examination. When it arrives, try it on and examine it carefully, and if found exactly as represented, and equal to any rain-coat ever sold for \$2.00, pay the Express Agent \$2.69 and express charges and receive this great bargain. This is a genuine English Mackintosh Raincoat, single breasted and made of fine quality popular steel gray waterproof cloth, cut in the latest pattern, velvet collar, dressy black lining, double stitched and contoured seams, concealed pockets, silk-worked buttonholes and reinforced buttons. An easy fitting coat, well finished throughout. Will wear like iron. A perfect protection against cold and wet and all their ills: Heavy Colds, Pneumonia, Consumption, Rheumatism, etc. No one exposed much to the weather can afford to be without one. Looks well, wears well, gives great comfort, and saves doctors' bills. We have only a few dozen of these coats. When they are gone there will be no more at this price. Lady's Waterproof, finer material, 60c. extra. (Give length.) When cash is sent with order we forward coat postpaid. JOHNSTON & CO., DEPT. 575, TORONTO.



GIRLS LOOK

Little Princess, the prettiest doll in the world, elegantly dressed from head to foot in silks and satins, lace and velvet, with stylish hat, dainty little slippers, real stockings and lace-trimmed underclothing. Can be dressed and undressed like any live baby. As pretty as a fairy princess, rosy cheeks, pearly teeth, beautiful eyes and golden ringlets. Can stand alone or sit in a chair. Given free for selling at 15c. each only 1 doz. 14k gold finished, stone set, Slide Lockets. These beautiful Lockets, set with brilliant imitation precious stones, look cheap at 50c. At 15c. they go like wildfire. Write to-day and we will send the Lockets postpaid. THE NATIONAL WATCH AND JEWELRY CO., DEPT. 570, TORONTO, ONTARIO.



TALKING DOLL

Wonderful speaking doll. Talks, cries and talks, says "Mamma" and "Papa" as plainly as any living child. She is a beauty, too, prettier than any baby you ever saw. Has rosy cheeks, laughing eyes, real pearly teeth and long golden ringlets. Get her and you will have the only real talking doll in your part of the country. Not one cent to pay. All we ask you to do is to send us 15c. each only 15 packages of Lemon, Vanilla and Almond Flavoring Powders. One package equals 50c. worth of Liquid Flavoring and is far better. Realism sells like it. Everybody buys. Write to-day and we will send you the Flavoring Powders postpaid. You can easily sell them and earn this wonderful Speaking Doll in a few minutes. The Home Art Co., Dept. 553, Toronto, Ontario.

FREE



STEAM FIRE ENGINE, made entirely of steel, iron and brass, beautifully finished, with driving wheel, shaft and piston, polished brass boiler and steam chest, Russian iron furnace compartment, brass steam pump with a suction hose and a long fire hose, with a brass nozzle, given for selling at 10c. each only 11 doz. packages of Chinese blue-black Ink Powders. Each package makes five 5c. bottles of superior ink. It is so cheap and useful that everybody buys. You can earn this wonderful Fire Engine in a few minutes. Write to-day and we will send you the Ink Powders postpaid. THE NATIONAL PEN AND INK CO., DEPT. 571, TORONTO

PREMIUMS

EXACT SIZE OF KNIFE.

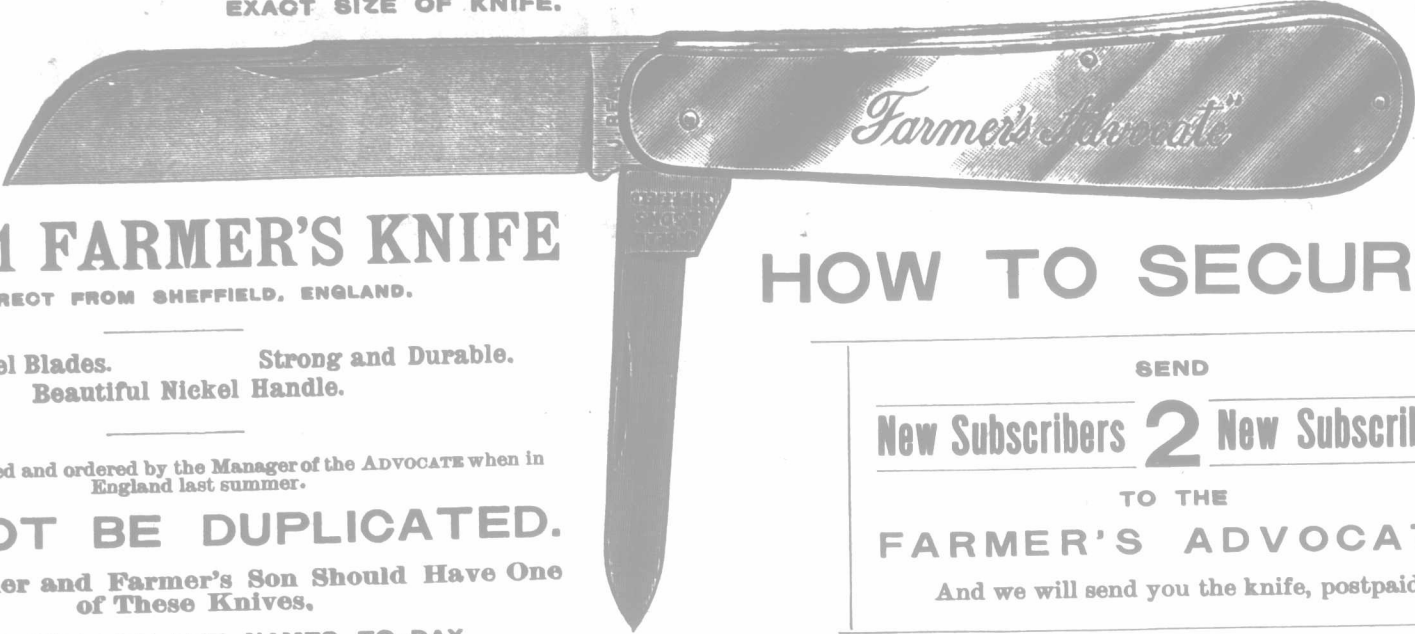

AN A 1 FARMER'S KNIFE
DIRECT FROM SHEFFIELD, ENGLAND.

Finest Steel Blades. Strong and Durable.
Beautiful Nickel Handle.

Specially selected and ordered by the Manager of the ADVOCATE when in England last summer.

CANNOT BE DUPLICATED.
Every Farmer and Farmer's Son Should Have One of These Knives.

START OUT FOR THE NAMES TO-DAY.

SEND

New Subscribers **2** New Subscribers

TO THE

FARMER'S ADVOCATE

And we will send you the knife, postpaid.

THE BIG FOUR THE GREAT PREMIUM PICTURE OFFER, FOR OBTAINING NEW SUBSCRIBERS TO THE "FARMER'S ADVOCATE" AT \$1 A YEAR.

"CANADA'S IDEAL" Admitted by judges, breeders and artists to be the most magnificent engraving of high-class modern Shorthorns ever issued in any country. 24 x 36 inches. Twelve animals.

"CANADA'S PRIDE" Nine celebrated draft horses. Your choice of any two of these for 1 new subscriber, or all four beautiful pictures for only 2 new subscribers.

"CANADA'S GLORY" Eleven celebrated light horses.

"CANADA'S COLUMBIAN VICTORS" Thirteen celebrated Ayrshire cattle.

Handsome! Curb-link Bracelet: Silver Filled

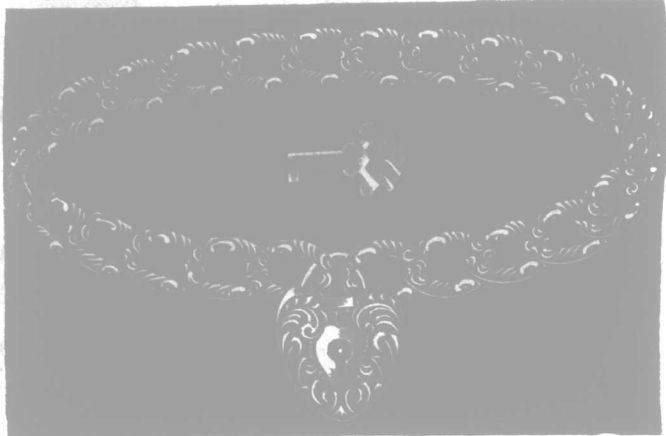

For 2 new subscribers. Sterling silver for 3 new subscribers. For each additional new subscriber, two Sterling Silver Friendship Hearts.

Bagster's NEW COMPREHENSIVE Teacher's Bible,

Containing the Old and New Testaments, according to the authorized version, together with new and revised helps to Bible study—a new Concordance and an Indexed Bible Atlas, with SIXTEEN FULL-PAGE ILLUSTRATIONS, PRINTED IN GOLD AND COLOR.

HOW TO OBTAIN IT—

Would retail at from \$3 to \$4. We will send (carefully packed, post paid) this Bible to anyone sending us the names of THREE NEW SUBSCRIBERS to the FARMER'S ADVOCATE at \$1.00 each.

Our Self-Binder HANDY, DURABLE and ATTRACTIVE. Made to contain the 24 issues of the year. We will forward this Binder, postpaid, to anyone sending us the names of TWO NEW SUBSCRIBERS and \$2.00.

BEGIN TO CANVASS AT ONCE FOR NEW SUBSCRIBERS. The balance of 1902 will be sent FREE, including Christmas number, to all who now subscribe for 1903. Subscription Price, \$1.00 per Annum.

THE

MICROSCOPE



Is a means of great entertainment and instruction in the home and out of doors. To meet the wishes of many subscribers, we have arranged with a first-class firm for a supply of those instruments; which we now offer:

Tripod Microscope, with strong magnifying lens, useful for examining weed and other seeds, insects and other small objects, for obtaining one (1) new subscriber to the FARMER'S ADVOCATE.

A three-inch Magnifying Reading Glass for one new subscriber.

HOW TO GET A

FIRST-CLASS COLLIE

Twelve New Subscribers.

TO ANY SUBSCRIBER sending us the names of 12 NEW yearly paid-up Subscribers we offer a young COLLIE, six weeks old or over, eligible for registration, and bred by Mr. R. McEwen, Byron, Ont., whose stock has been so successful in the leading shows in Canada and the United States.

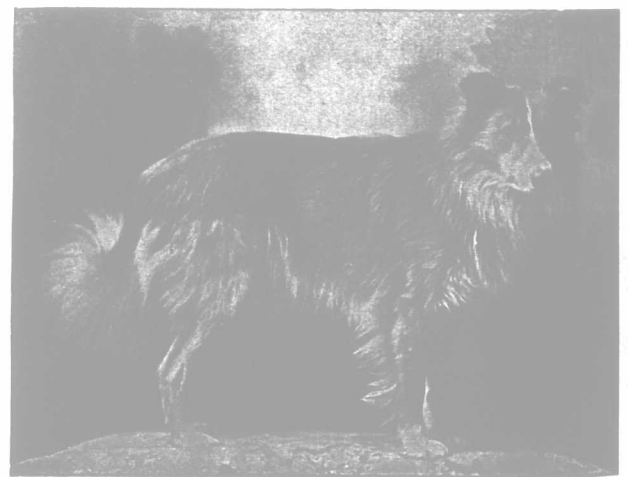

Write for a sample copy of the Farmer's Advocate, and begin to work for these premiums. Cash must accompany new names.

THE WM. WELD COMPANY, LTD., LONDON, ONTARIO.

FARM BOOKS.

The farmer's home without an Agricultural Library is lacking in one of the chief aids to pleasure and success. We have gone over the available first-class works on agricultural subjects, and have selected the best. See below for prices and how to obtain.

SOIL AND CROP.

- THE FERTILITY OF THE LAND.—*Roberts*. 372 pages. \$1.25.
- A BOOK ON SILAGE.—*Woll*. 185 pages. \$1.00.
- SOILING, ENSILAGE, AND BARN CONSTRUCTION.—*F. S. Peer*. 247 pages. \$1.00.
- SOILING CROPS AND THE SILO.—*Shaw*. 366 pages. \$1.50.

LIVE STOCK.

- VETERINARY ELEMENTS.—*A. G. Hopkins, B. Agr., D. V. M.* \$1.50. A practical book for stockmen and agricultural students.
- THE STUDY OF BREEDS (CATTLE, SHEEP, AND SWINE).—*Prof. Shaw*. 400 pages; 60 engravings. \$1.50.
- HORSE BREEDING.—*Sanders*. 422 pages. \$1.50.
- LIGHT HORSES—BREEDS AND MANAGEMENT. 226 pages. \$1.00.
- HEAVY HORSES—BREEDS AND MANAGEMENT. 219 pages. \$1.00.
- CATTLE—BREEDS AND MANAGEMENT. 270 pages. \$1.00.
- SHEEP—BREEDS AND MANAGEMENT. 232 pages. \$1.00.
- ANIMAL BREEDING.—*Shaw*. 406 pages. \$1.50.
- THE DOMESTIC SHEEP.—*Stewart*. 371 pages. \$1.75.
- THE SHEEP.—*Rushworth*. 496 pages. \$1.50.
- PIGS—BREEDS AND MANAGEMENT.—*Sanders Spencer*. 175 pages. \$1.00.
- FEEDS AND FEEDING.—*Henry*. 600 pages. \$2.00.

Vinton Series.

GENERAL AGRICULTURE.

- AGRICULTURE.—*C. C. James*. 300 pages. 30 cents.
- FIRST PRINCIPLES OF AGRICULTURE.—*Voorhees*. 307 pages. \$1.00.
- AGRICULTURE.—*Storer*. 1,875 pages, in three volumes. \$6.00.
- CHEMISTRY OF THE FARM.—*Warrington*. 183 pages. \$1.00.
- FARMYARD MANURE.—*Altman*. 65 pages. 50 cents.
- IRRIGATION FOR THE FARM GARDEN AND ORCHARD.—*Henry Stewart*. \$1.00.
- SUCCESSFUL FARMING.—*Rennie*. 300 pages. \$1.50, postpaid.

DAIRYING.

- AMERICAN DAIRYING.—*H. B. Gurler*. 262 pages. \$1.00.
- THE BOOK OF THE DAIRY.—*Fleischmann*. 330 pages. \$2.75.
- MILK AND ITS PRODUCTS.—*Wing*. 230 pages. \$1.00.
- TESTING MILK AND ITS PRODUCTS.—*Farrington & Woll*. 255 pages. \$1.00.
- DAIRYING FOR PROFIT.—*Mrs. E. M. Jones*. 50 cents.

POULTRY.

- FARM POULTRY.—*Watson*. 341 pages. \$1.25.
- ARTIFICIAL INCUBATING AND BROODING.—*Cypher*. 146 pages. 50 cents.
- PRACTICAL POULTRY-KEEPER.—*Wright*. \$2.00.
- AMERICAN STANDARD OF PERFECTION.—*Pierce*. 378 pages. \$1.00.

APIARY.

- THE HONEYBEE.—*Langstroth*. 621 pages. \$1.50.

FRUIT, FLOWERS, AND VEGETABLES.

- VEGETABLE GARDENING.—*Green*. 224 pages. \$1.25.
- FLOWERS AND HOW TO GROW THEM.—*Rexford*. 175 pages. 50 cents.
- THE PRINCIPLES OF FRUIT-GROWING.—*Bailey*. 514 pages. \$1.25.
- BUSH FRUITS.—*Card*. 537 pages. \$1.50.
- HORTICULTURIST'S RULE BOOK.—*Bailey*. 312 pages. 75 cents.
- SPRAYING OF PLANTS.—*Lodeman*. 399 pages. \$1.00.
- THE NURSERY BOOK.—*Bailey*. 365 pages; 152 illustrations. \$1.00.
- AMATEUR FRUIT-GROWING.—*Samuel B. Green*. 5x7 inches; 134 pages, with numerous fly-leaves for notes; bound in cloth, and illustrated. 50 cents.

PLANT AND ANIMAL LIFE.

- THE STORY OF THE PLANTS.—*Grant Allen*. 213 pages. 40 cents.
- THE STUDY OF ANIMAL LIFE.—*J. A. Thomson*. 375 pages. \$1.75.
- INSECTS INJURIOUS TO FRUITS.—*Saunders*. 436 pages. \$2.00.

MISCELLANEOUS.

- THE HOME PHYSICIAN AND CYCLOPEDIA OF MEDICINE.—By seven eminent physicians, aided by specialists. 1,300 pages; illustrated. Cloth, \$4.75; leather, \$5.75.
- LANDSCAPE GARDENING.—*S. T. Maynard*. 338 pages. \$1.50.
- BIRDS THAT HUNT AND ARE HUNTED.—*Neltje Blanchan*. 360 pages. \$2.25.

HOW TO OBTAIN THESE BOOKS:

We will furnish present subscribers any of the above books for cash or as premiums for obtaining new yearly subscribers to the FARMER'S ADVOCATE at \$1.00 each, according to the following scale:

Books valued at 50c. and under for 1 new subscriber.	
Books valued over 50c. and up to \$1.00 for 2 new subscribers.	
" " " \$1.00 " " " \$1.50 " 3 " "	
" " " \$1.50 " " " \$2.00 " 4 " "	
" " " \$2.00 " " " \$2.50 " 5 " "	
" " " at \$2.75 for 6 new subscribers.	
" " " \$6.00 " 12 " "	

We can furnish any of the above books at the regular retail price, which is given opposite the title of the book. By a careful study of the above list, any farmer can choose a select list of books suited to his needs, and for a small outlay in cash, or effort in obtaining new subscribers for the ADVOCATE, secure the nucleus of a useful library.

Cash to accompany names in every case. Subscriptions credited a year in advance from date received.

The WILLIAM WELD CO., Ltd., London, Ontario.

WANT A GOOD WATCH?

WE have succeeded in procuring from one of the most reliable jewelers in Canada a complete list of Gents' and Ladies' Watches of sufficient variety to suit every one, and have no hesitation in recommending them to our readers as premiums worthy of an effort to secure. These are not by any means trashy goods, but first-class in every particular, and we assure you that you will be pleased with whatever of the above premiums you may obtain. Let us hear from you at an early date with a good list of new subscribers accompanied by the cash, and take your choice.

Gents' Watches.

	New Subscribers.
No. 1. Yankee Nickel Watch.....	2
No. 2. Trump Nickel Watch.....	4
No. 3. Trump Gun Metal Watch....	5
No. 4. No. 14 Silver Watch.....	8
No. 5. 7 Jeweled Gent's Elgin in 3 oz. Nickel Case.....	10
No. 6. 7 Jeweled Gent's Elgin in Gun Metal Case.....	11
No. 7. 7 Jeweled Gent's Elgin in Sterling Silver Case....	14
No. 8. 7 Jeweled Gent's Elgin in 20-year Filled Case.....	18
No. 9. 7 Jeweled Gent's Elgin in 25-year Filled Case.....	21
No. 10. 15 Jeweled Gent's Elgin in 3 oz. Nickel Case.....	15
No. 11. 15 Jeweled Gent's Elgin in Gun Metal Case.....	15
No. 12. 15 Jeweled Gent's Elgin in Sterling Silver Case....	18
No. 13. 15 Jeweled Gent's Elgin in 20-year Filled Case.....	21
No. 14. 15 Jeweled Gent's Elgin in 25-year Filled Case.....	25

Ladies' Watches.

	New Subscribers.
No. 15. Gun Metal Swiss Chatelaine.....	4
No. 16. Sterling Silver Swiss Chatelaine.....	5
No. 17. Nickel American O. F., large size.....	5
No. 18. Gun Metal American O. F., large size.....	5
No. 19. Nickel, small size.....	9
No. 20. Gun Metal, small size.....	10
No. 21. Sterling Silver, small size....	10
No. 22. 7 Jeweled Elgin in 20-year Filled Hunting Case....	20
No. 23. 7 Jeweled Elgin in 25-year Filled Hunting Case....	22
No. 24. 15 Jeweled Elgin in 20-year Filled Hunting Case....	23
No. 25. 15 Jeweled Elgin in 25-year Filled Hunting Case....	25

Description of Watches.

The accompanying cuts fairly well represent all the Ladies' and Gents' Watches, and a description of each as numbered is as follows:

No. 1. American Nickel Key-wind Boy's Watch that is absolutely guaranteed to keep good time and give satisfaction.

No. 2. Gent's Nickel American O. F. Watch; stem wind, and push-in stem and turn to set hands. This is a very strong, reliable Watch.

No. 3. Same as No. 2, excepting that it has Gun Metal case instead of Nickel case.

No. 4. Is a smaller-sized Gent's Watch, has sterling silver case, O. F. Screw Back and Bezel; stem wind, and push-in stem and turn to set hands. This is the lowest-priced and most reliable Boy's or small Gent's Silver Watch that is on the market.

No. 5. Is fitted with 7-Jeweled Nickel, first-quality Elgin movement. The case is a 3-oz. O. F. Nickel case; stem wind and set; screw back and bezel case.

No. 6. Same movement in Gun Metal or Black Steel screw back and bezel case.

No. 7. Same movement with Sterling Silver O. F. screw back and bezel case.

No. 8. Same movement in 20-year guaranteed Gold Filled O. F. screw back and bezel case.

No. 9. Same movement in 25-year guaranteed Gold Filled O. F. screw back and bezel case.

Nos. 10, 11, 12, 13 and 14 are fitted in the same style of cases as Nos. 5, 6, 7, 8 and 9; the difference is in the movement, and the movement is 15-Jeweled Nickel, first-quality Elgin movement.

No. 15. Is a small-sized Swiss O. F. Gun Metal Chatelaine Watch.

No. 16. Is the same, only with Sterling Silver case, which can be had nicely engraved.

Nos. 17 and 18 are a good-quality American Watch, O. F. stem wind, and push-in stem and turn to set hands. These are a little larger than the usual Ladies' Watches, and are smaller than the usual Boys' Watches, though can be used for either Boys, Girls or Young Ladies.

Nos. 19, 20 and 21 are small sized; in fact, are the exact size of cut. These are American Watches, O. F. stem wind, and push-in stem and turn to set hands, and are first-class timekeepers. Will give perfect satisfaction.

If a nice leather wrist case is desired with these watches, send two extra subscribers.

Nos. 22, 23, 24 and 25 are similar to the accompanying cut. These are regular Ladies' Hunting Watches. Nos. 22 and 24 are fitted in 20-year guaranteed Gold Filled cases, nicely ornamented, or to be had in plain or plain engine turned, and the same applies to Nos. 23 and 25, excepting that they are fitted in 25-year guaranteed Gold Filled cases, and 14k Gold Filled; 22 and 23 are fitted with 7-Jeweled Nickel, first-quality Elgin movements. Nos. 24 and 25 are fitted with 15-Jeweled Nickel, first-quality Elgin movements.

When making your choice of Watch as premium, be sure to mention its number as given in premium list, also whether Ladies' or Gents'.

The WM. WELD CO., Ltd., London, Ontario.

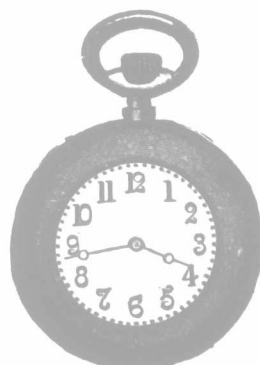
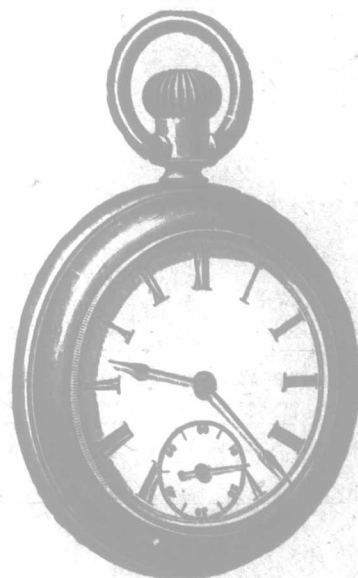



TALKING DOLL
FREE
FREE
FREE

Wonderful speaking doll. Laughs, cries and talks, says "Mama" and "Papa". She is a beauty, too, prettier than any baby you ever saw. Has rosy cheeks, laughing eyes, real pretty teeth and long golden ringlets. Get her and you will have the only real talking doll in your part of the country. Not one cent to pay. All we ask you to do is to send at 15c each only 10 Canadian Home Cook Books. These Books are nicely printed, beautifully bound and each contains 250 choice Recipes. Every house-keeper buys one. Write today and we will send you the Cook Book postpaid. You can easily sell them and earn this wonderful Speaking Doll in a few minutes. Home Specialty Co., Dept. 503, Toronto.

McLachlan Gasoline Engine

IS MOUNTED IN 5, 10, 15, 20 OR 25 HORSE POWER.

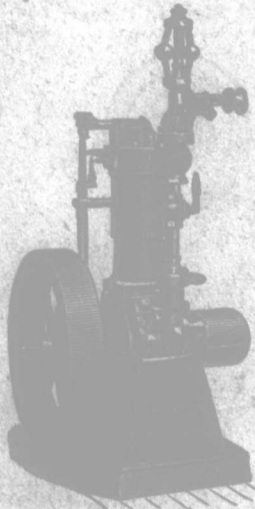

WRITE
THE McLACHLAN GASOLINE ENGINE CO., LIMITED,

201 Queen St. E., TORONTO,

for catalogue and prices. om



Ripley's 1903 Improved Combination Steam Cookers, Hog and Poultry House Heaters and Water-Tank Heater.

Manufactured in Canada.

Will cook 25 bush. of feed or roots in two hours, or heat water in stock tanks or heat buildings 250 ft. from cooker by conveying the steam; made of boiler steel and the best cast iron; on a's blow top can be used outside or attached to a chimney; no flues to fill with soot, or leak. Indorsed and used by Canadian breeders and Experiment Stations. We manufacture 4 styles of cookers and 25 sizes. Catalogue and prices mailed free. Prices, \$10 to \$50. Address, Ripley Hardware Co., London, Ont.; or Grafton, Ill., U. S. A. Box 100. om

Farmers Contemplating Marriage, AS WELL AS Those Already in Wedded Bliss,

should present their bride or family, as the case may be, with a BEAUTIFUL MASON & RISCH PIANO.

Liberal allowance made for old pianos and organs. Call and get our prices before buying.

The Mason & Risch Piano Co., Ltd., 211 Dundas St., London.



H-T-T. Published monthly, 52 pages. Tells all about Hunting, Trapping and Raw Furs. Sample copy, 10c. Hunter-Trapper-Trapper, Box G, Gallipolis, Ohio. om

LUMBER AT HALF PRICE

WE PURCHASED THE PAN-AMERICAN EXPOSITION Send us your lumber bill for our estimate, and we will make you prices delivered free of all charges at your shipping point.

WRITE FOR OUR EXPOSITION CATALOGUE OF MATERIAL. CHICAGO HOUSE WRECKING CO., PAN-AMERICAN, DEPARTMENT 06. BUFFALO, N. Y.



FREE COLUMBIAN PHONOGRAPH RECORDS WITH 5 RECORDS
This genuine Columbia Phonograph reproduces Songs, Speeches, animal imitations, instrumental selections, etc., in a most lifelike manner. We give it complete with five up-to-date records for doing two things: (1) selling at 10c each 15 packages of Lemon, Vanilla and Almond Flavoring Powders, and (2) sending 3 other agents to do the same, or selling 3 doz. yourself. Each package is worth 10c of Liquid Flavoring and is far better. Everybody buys. Write for Favoring Powders today. The Home Art Co., Dept. 571, Toronto.

Joseph Rodgers & Sons Limited.
SHEFFIELD, ENGLAND.

Please see that this EXACT MARK is on each blade.

JAMES HUTTON & CO., MONTREAL, SOLE AGENTS IN CANADA.



The Livingston Linseed Oil Co., Ltd.,
BADEN, ONTARIO,

Manufacturers of strictly pure

Old Process Linseed Oil Cake and Meal, also Ground Flax Seed. Write for prices.

BRANTFORD

Galvanized Steel Windmills

PUMPING OR POWER.

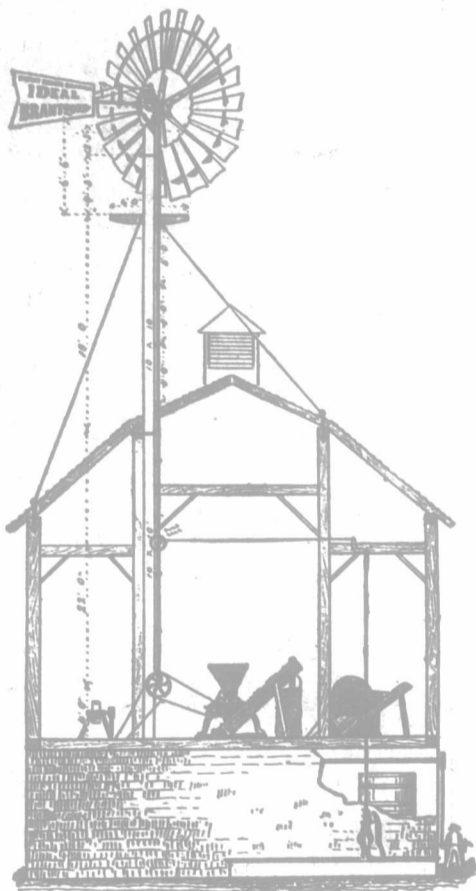

Grain Grinders, Wood Pumps, Iron Pumps, Tanks, Water Boxes, Beekeepers' Supplies, Etc., Etc.

WRITE IF INTERESTED.

Goold, Shapley & Muir Co., Limited

BRANTFORD, ONT.

DISK HARROWS and STEEL ROLLERS

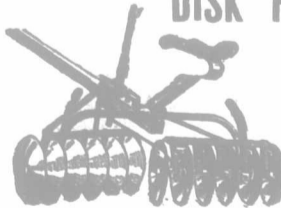

Experienced farmers, who should know, claim that the Bissell Harrows and Rollers are ahead of all others in features of construction, capacity, draft, durability and improvements. Would you care to know the particulars, free? Address: T. E. BISSELL, DEPT. W., ELORA, ONT.



THE Strathy Wire Fence Co. LIMITED,

OWEN SOUND, ONT.,

manufacture the best metal gate on the market. Low prices and fullest guarantee of satisfaction. If they do not suit you, we pay all expenses. Write for particulars. om

SHOWING HINGE MOVEMENT OF STAYS UNDER PRESSURE IT WILL SPRING BACK TO PLACE WHEN PRESSURE IS REMOVED.



"MELOTTE" CREAM SEPARATORS

They are Perfection.

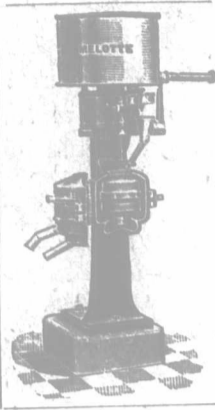

The only Separator fitted with a brake and beautifully-enamelled bowl casing.

The Lightest Running and most durable Separator yet produced.

SENT ON TRIAL.

Agents wanted where we are not already represented. Write for catalogue.

R. A. LISTER & CO., LIMITED, 570 St. Paul Street, Montreal.

Buy the **NEW CENTURY AMERICAN CREAM SEPARATOR**



And have the best.

Nothing as good.

Simple, durable, easy to turn and clean. Five different dairy sizes.

WRITE FOR CIRCULARS AND INFORMATION. AGENTS WANTED.

C. RICHARDSON & CO., P. O. Box 1042, St. Mary's, Ont.

Wide-Tire Metal Wheels

FOR WAGONS. Made to fit any axle, any sized wheel, any width tire. Every farmer should have a set. They are low and handy. They save labor, and the wide tires avoid cutting the farms into ruts. Write for Free Dominion Wrought Iron Wheel Co., Ltd., 9 and 11 Brock Ave., TORONTO, ONT.

LAMB FENCE.

Factory made complete, ready to stretch. The H. R. LAMB FENCE CO., LIMITED, LONDON, ONT.

TORONTO ENGRAVING Co.
92 BAY ST
CUTS BY ALL PROCESSES
LIVE STOCK A SPECIALITY

Family Knitter

Cheapest, Simplest, Best. Price, \$8.00. Write for circular.

Dundas Knitting Machine Company, DUNDAS, ONTARIO.

LADY'S WATCH
FREE for doing two things: (1) selling at 10c each, only 15 packages of Lemon, Vanilla and Almond Flavoring Powders; (2) getting 3 more agents to do the same or by selling 24 doz. yourself. One package equals 20c worth of Liquid Flavoring and is far better. Every housekeeper buys one or more packages. You can earn this watch in a few minutes. It is a little beauty, with silver nickel case, fancy decorated dial, gold hands and stem wind and set, reliable imported work. Write to day and we will send you the Favoring Powders postpaid. We trust you. The Home Art Co., Dept. 561, Toronto.

