

**Technical and Bibliographic Notes / Notes techniques et bibliographiques**

The Institute has attempted to obtain the best original copy available for filming. Features of this copy which may be bibliographically unique, which may alter any of the images in the reproduction, or which may significantly change the usual method of filming, are checked below.

L'Institut a microfilmé le meilleur exemplaire qu'il lui a été possible de se procurer. Les détails de cet exemplaire qui sont peut-être uniques du point de vue bibliographique, qui peuvent modifier une image reproduite, ou qui peuvent exiger une modification dans la méthode normale de filmage sont indiqués ci-dessous.

Coloured covers/  
Couverture de couleur

Coloured pages/  
Pages de couleur

Covers damaged/  
Couverture endommagée

Pages damaged/  
Pages endommagées

Covers restored and/or laminated/  
Couverture restaurée et/ou pelliculée

Pages restored and/or laminated/  
Pages restaurées et/ou pelliculées

Cover title missing/  
Le titre de couverture manque

Pages discoloured, stained or foxed/  
Pages décolorées, tachetées ou piquées

Coloured maps/  
Cartes géographiques en couleur

Pages detached/  
Pages détachées

Coloured ink (i.e. other than blue or black)/  
Encre de couleur (i.e. autre que bleue ou noire)

Showthrough/  
Transparence

Coloured plates and/or illustrations/  
Planches et/ou illustrations en couleur

Quality of print varies/  
Qualité inégale de l'impression

Bound with other material/  
Relié avec d'autres documents

Continuous pagination/  
Pagination continue

Tight binding may cause shadows or distortion along interior margin/  
La reliure serrée peut causer de l'ombre ou de la distorsion le long de la marge intérieure

Includes index(es)/  
Comprend un (des) index

Title on header taken from: /  
Le titre de l'en-tête provient:

Blank leaves added during restoration may appear within the text. Whenever possible, these have been omitted from filming/  
Il se peut que certaines pages blanches ajoutées lors d'une restauration apparaissent dans le texte, mais, lorsque cela était possible, ces pages n'ont pas été filmées.

Title page of issue/  
Page de titre de la livraison

Caption of issue/  
Titre de départ de la livraison

Masthead/  
Générique (périodiques) de la livraison

Additional comments: /  
Commentaires supplémentaires: Some pages are cut off.

This item is filmed at the reduction ratio checked below /  
Ce document est filmé au taux de réduction indiqué ci-dessous.

10X	12X	14X	16X	18X	20X	22X	24X	26X	28X	30X	32X
<input type="checkbox"/>	<input type="checkbox"/>	<input type="checkbox"/>	<input type="checkbox"/>	<input type="checkbox"/>	<input type="checkbox"/>	<input type="checkbox"/>	<input type="checkbox"/>	<input type="checkbox"/>	<input type="checkbox"/>	<input checked="" type="checkbox"/>	<input type="checkbox"/>

# THE CANADA LUMBERMAN



CAMP SUPPLY  
NUMBER

May

1903

THE C.H. MORTIMER PUBLISHING CO. OF TORONTO,  
LIMITED

Toronto and Montreal

**A D A M H A L L**

PETERBORO, ONTARIO, CANADA

MANUFACTURER  
OF . . . . .

**STEEL RANGES**

For Lumbermen's and Railway Camps, Boarding Houses and Hotels

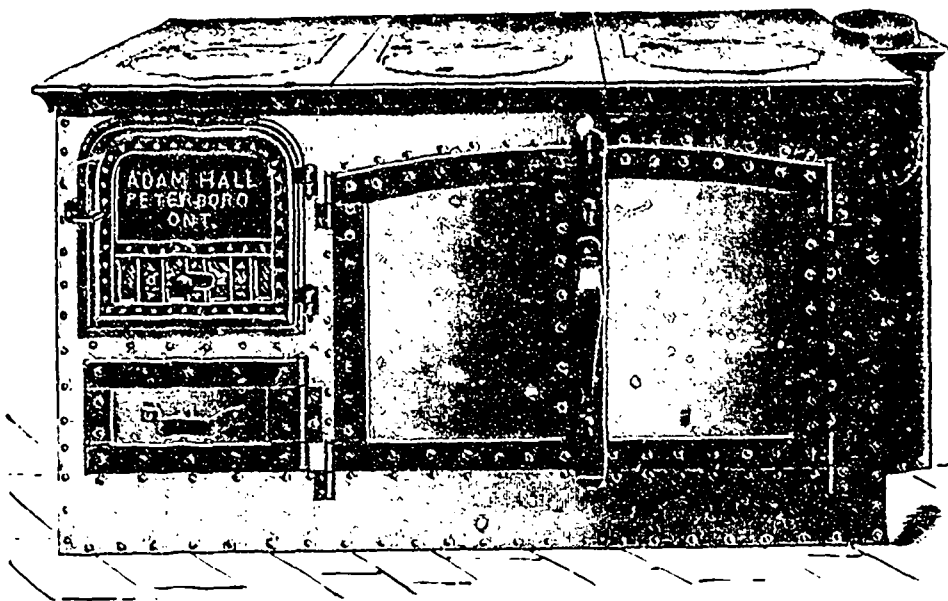

*Lumbermen's Six Pot Hole Range.*

We have been manufacturing Steel Ranges and Heaters for Lumber Camps for the past Twenty-four Years, and have supplied the wants of nearly all the Lumbermen in Quebec, Ontario and Manitoba—they are unexcelled for Baking and Cooking, and are strong and durable.

This No. 1025 Six Pot Hole Range is largely used in Camp of Fifty (50) Men and for use when driving the Rivers. Weighs 400 pounds.

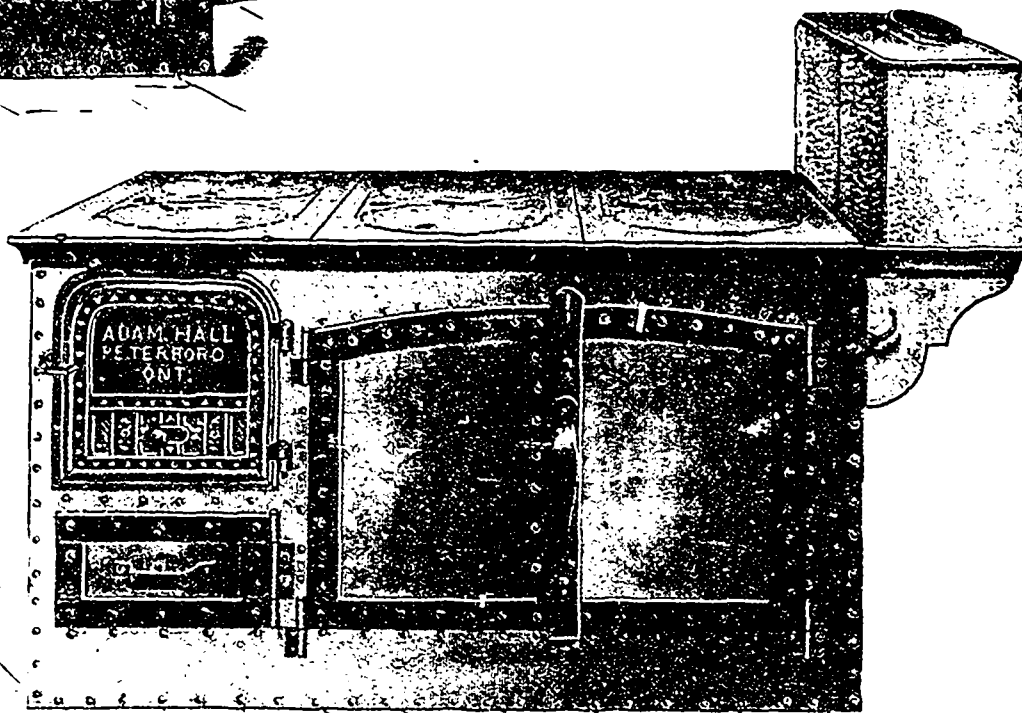

*Lumbermen's Six Pot Hole Range with Reservoir.*

This No. 1025 Range with 25 Gallon Copper Reservoir is the one we sell the most of, owing to the convenience of having a supply of hot water at all times. Will cook for 50 to 60 men. Weighs 450 pounds.

This No. 1026 Leader Range with Front Hearth and Copper Reservoir is made for either Coal or Wood and is largely used in Boarding Houses and Hotels. The Wood Range weighs 500 pounds; the Coal Range weighs 600 pounds.

We make a number of other sizes of Ranges, also a **Lumberman's Box Stove** of Heavy Steel Body and Cast Metal Ends, in 36 inch, 42 inch and 48 inch—they are Excellent Heaters, Strong and Durable.

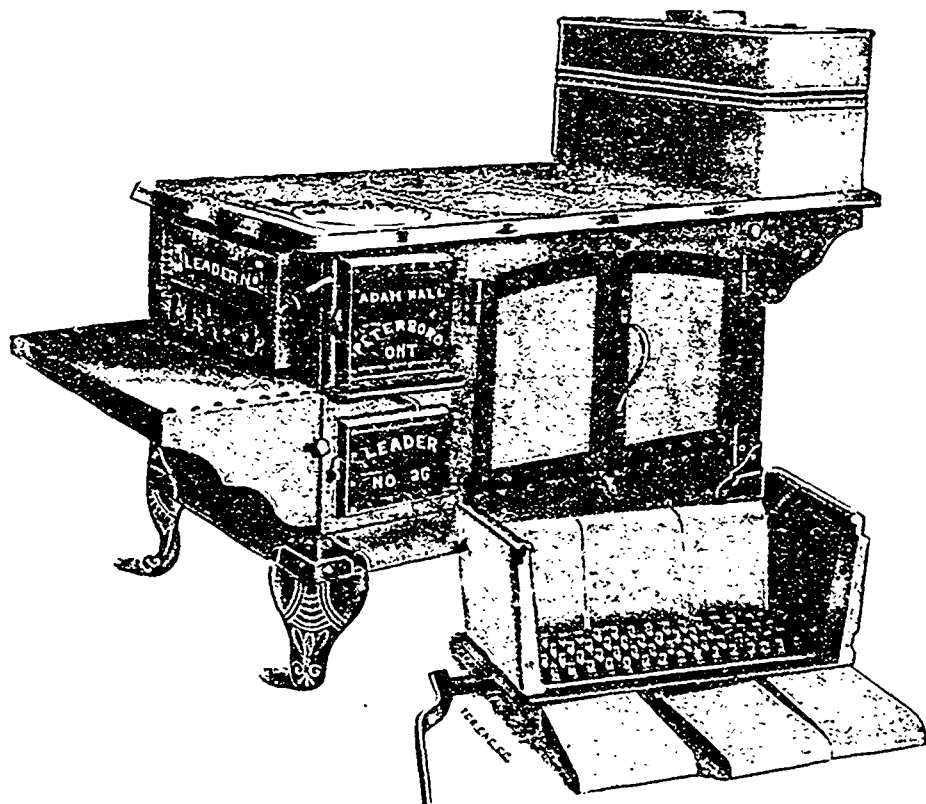

*Coal or Wood Range for Hotels and Boarding Houses.*

Write for Catalogue and Price List

# THE CANADA LUMBERMAN

Wood-Workers', Manufacturers' and Millers' Gazette

VOLUME XXIII.  
NUMBER 5

TORONTO, CANADA, MAY, 1903

TERMS, \$1.00 PER YEAR  
Single Copies, 10 Cents

**"REDDAWAYS"  
BALATA  
AND  
"CAMEL BRAND"  
BELTING**



NOT AFFECTED BY DAMPNES  
THE BEST FOR MAIN DRIVES.  
MOST DURABLE

**W. A. FLEMING & CO.,**  
771 CRAIG ST.,  
MONTREAL.  
Branch  
ST. JOHN, N.B.

**THE OTTAWA SAW CO. LIMITED**

Middle Street, OTTAWA, ONT.

**SANVIK SWEDISH STEEL**

**BAND, GANG AND CIRCULAR SAWS**

**P. M. FEENY,**

Manager.

**There is No Belt Made**

That will wear longer, need less repairs,  
is cut out of better stock, or better able  
to stand hard work on high speed ma-  
chinery than the belts made by . . . . .

**J. L. GODHUE & CO.,**  
DANVILLE, QUE.

**J. J. Turner & Sons**

MANUFACTURERS OF

**L**umbermen's Tents, Waterproof  
Horse and Wagon Covers, Feed  
Bags, Goal Bags and Water-  
proof Clothing

OF EVERY DESCRIPTION.

**PETERBOROUGH, ONT.**

Send for Catalogue "A."

**James W. Woods**

Wholesale Manufacturer of

**LUMBERMEN'S  
SUPPLIES**

Tents and Tarpaulins made of our special non-  
absorbent duck. Overalls, Top Shirts, Driving  
Pants, Shoes and Hats, Underwear, Blankets,  
Axes, Moccasins, etc.

64-66 QUEEN ST. - - OTTAWA, ONT.

**BABBITT METAL**

When repairing your SAW AND PULP MILLS,  
WOODWORKING FACTORIES, etc., use



CHEAPEST AND BEST  
Canadian Factory: WINDSOR, ONT.

**DICK'S  
BELTINGS**

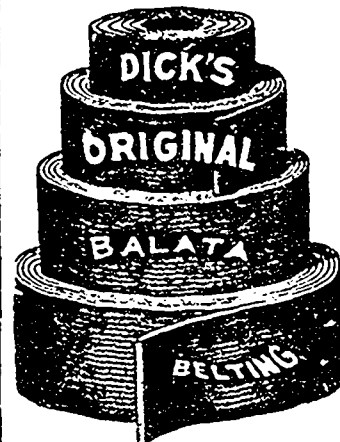

Never is  
affected by  
wetness, and  
does not  
stretch.

Excels in  
Transmission  
Power

Always  
Uniform.

LARGE STOCK  
ON HAND.

WRITE TO SOLE AGENTS:

**J. S. YOUNG,** 15 Hospital Street,  
MONTREAL.

**SPRAYERS**

FOR COLD WATER PAINT, WHITEWASH, LIMEWASH, ETC.  
IN STOCK IN OUR MONTREAL WAREHOUSE

**W. H. C. MUSSEN & CO.**  
Montreal



MANUFACTURERS OF

**HIGH GRADE  
CIRCULAR AND LONG SAWS  
UNEXCELLED  
SHINGLE SAWS**

THE  
**WM. HAMILTON MFG. CO., LIMITED,**  
PETERBOROUGH, ONTARIO.



**Designers and  
Builders . .**

**—of—**

**New and Modern Saw Mills and  
Machinery for same**



**WE ALSO BUILD**

Pulp Mill Machinery,  
Samson Leffel Turbine Water Wheels,  
Tools for the Care of Saws,  
Shingle Machinery, Engines,  
Boilers, Etc.



**The Wm. Hamilton Mfg. Co., Limited**

Branch Office: VANCOUVER, B. C.

PETERBOROUGH, ONT.

# THE MAPLE LEAF SAW WORKS



## Shurly & Dietrich GALT, ONT.

Manufacturers of

- CIRCULAR SAWS
- GANG SAWS
- MILL SAWS
- BAND SAWS
- CROSS-CUT SAWS

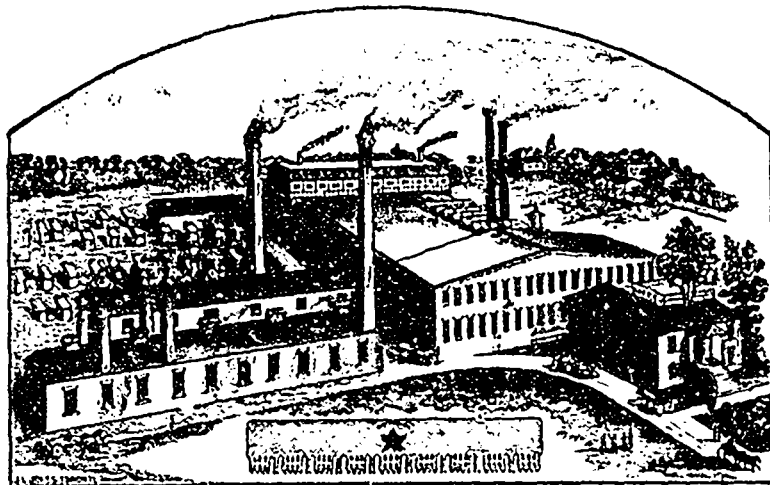

Manufacturers of

- HAND SAWS
- BUCK SAWS
- PLASTERING TROWELS
- BUTCHER SAWS
- STRAW KNIVES, &c.

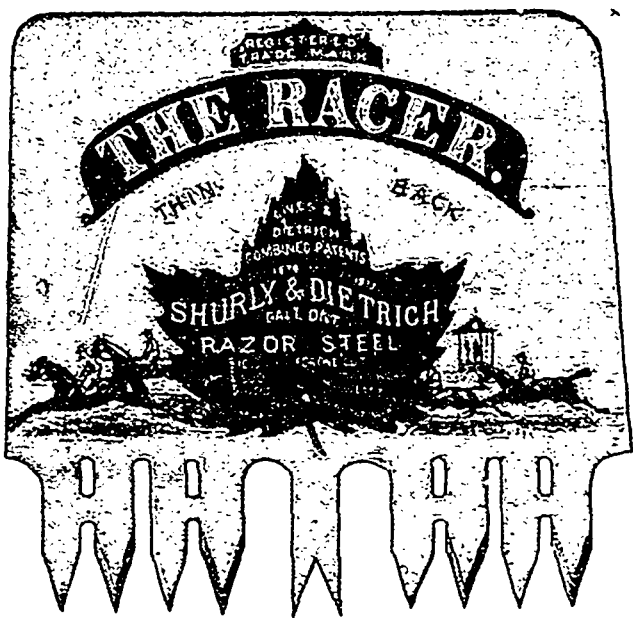

**GROUND THIN ON BACK**  
 Save Labor      Save Gumming  
 Save Time      Save Files

### This Saw Stands Without a Rival

AND IS THE

### FASTEST CUTTING SAW IN THE WORLD!

Its Superiority consists in its Excellent Temper. It is made of "Razor Steel," which is the finest ever used in the manufacture of Saws. We have the sole control of this steel. It is tempered by our secret process, which process gives a keener cutting edge and a toughness to the steel which no other process can approach.

## Maple Leaf Saw Set

MANUFACTURED BY  
SHURLY & DIETRICH, Galt, Ont.

Directions.—Place the set on the point of tooth, as shown in the accompanying cut, and strike a very light blow with a tack hammer. If you require more set, file the tooth with more bevel.  
If you follow directions you cannot make a mistake. Be sure and not strike too hard a blow, and it will set the hardest saw. On receipt of 40 cents we will send one by mail.

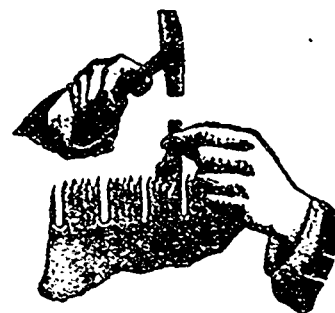

We are the only manufacturers in the world who export Saws in large quantities to the United States.

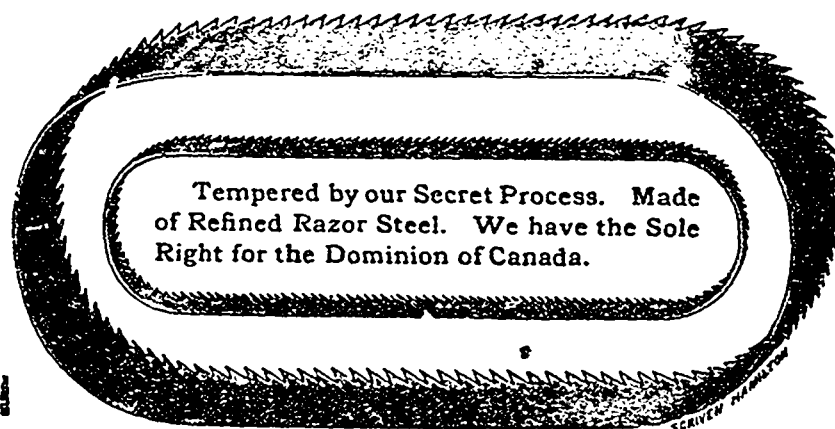

Tempered by our Secret Process. Made of Refined Razor Steel. We have the Sole Right for the Dominion of Canada.

We Manufacture

## HIGH GRADE BAND SAWS

of All Widths and Lengths.

These Saws are made of Refined Swedish Steel imported direct, and tempered by our Secret Process; for Fine Finish and Temper are not excelled.

## Petrie's List of Machinery

(List corrected every issue.)

**BOILERS**

38"x120"-28-3"	Tubes, Hor. Tubular.
38"x120"-33-3"	" " "
38"x165"-30-3"	" " "
44"x137"-35-3"	" " "
44"x143"-45-3"	" " "
44"x156"-45-3"	" " "
44"x116"-45-3"	" " "
44"x166"-45-3"	" " "
48"x156"-53-3"	" " "
48"x197"-43-3"	" " "
60"x165"-84-3"	" " "
77"x189"-95-3 1/2"	" " "
60"x210"-54-4"	" " "
6 h. p. Portable Fire Box Boiler, new	
19"x44"-13-2"	Tubes, Vertical, new.
25"x44"-37-1"	" " "
37"x68"-70-2"	" " "
20"x49"-19-2"	" " "
24"x50"-31-2"	" " "
30"x60"-43-2"	" " "
30"x72"-43-2"	" " "
24"x60"-31-2"	Tubes, Submerged, new.
30"x72"-54-2"	" " "
30"x84"-54-2"	" " "
30"x60"-54-2"	" " "
60"x134"-21-4"	" " "

**ENGINES**

3 and 5 1/2 H. P.	Compound, Doty, new
4 1/2 x 5 1/2	" " "
7 1/2 and 14 x 12	Steeple Compound, Doty.
4 1/2	Marine Engine, Polson.
5 1/2 x 5	" " with Shaft and Wheel.
9 1/2	" " " " " " new.
2 1/2 x 3	" " Dutton, New.
3 1/2	" " "
6 1/2	" " "
7 1/2	" " "
10 to 4 1/2 H. P.	"Triton" Marine Gasoline En-
	gines Complete With Shaft and Wheel, new
10 H. P.	Engine and Boiler on "Wheels, Cornell.
14 H. P.	" " " " " " Waterous.
70 H. P.	Tandem Compound Condensing En-
	gine, Osborne Kelly Make.
7 3/4 and 9 5/8 x 12	Compound Slide Valve En-
	gine, Waterous.
11 x 10	Peerless Self Oiling Engine, Leonard.
10 x 10	" " "
4 1/2 x 6	No. 1 Jewel Automatic, Dutton, new
5 x 7 1/2	No. 2 " " " "
6 x 7 1/2	No. 3 " " " "
7 1/2 x 8	No. 4 " " " "
10 x 15	No. 8 " " " "
11 x 15	No. 9 " " " "
6 1/2 x 8	Centre Crank, Dutton, new
7 1/2 x 8	" " " " " "
8 x 10	" " " " " "
4 1/2 x 8	Hor. Valve Engine, Waterous.
9 1/2 x 12	" " " " " " Northey
9 x 12	" " " " " " Beckett, New.
9 x 14	" " " " " " "
11 x 14	" " " " " " "
16 x 24	Hor. Rocking " " " " " " Waterous
12 1/2 x 18	" " " " " " " " Goldie & McCulloch
10 1/2 x 16	Slide " " " " " " Buffalo
8 1/2 x 12	" " " " " " " " "
4 and 2 1/2 H. P.	Gasoline Engines, Junction make,
	new.
10 and 1 1/2 H. P.	" " " " " " Haggis make,
	new.
1 H. P.	Upright " " " " " " Housley make,
	new.

**WOOD WORKING MACHINERY**

Left Hand Circular Saw Mill, No. 1 Lane.
36 in. Circular Re-Saw, Galt Make.
All Iron Swing Cut-off Saw Frames.
Railway Swing Cut-off Saw Table.
Band Re-Saw, new.
Double Spindle Iron Top Wood Shaper, Galt make, new.
Double Spindle Iron Top Wood Shaper, Galt Make, new.
Double Spindle Wood Top Wood Shaper.
12 inch A. Doig Pony Planer.
20 inch Jackson, Cochrane Pony Planer.
24 inch Major Harper Planer and Matcher.
24 inch Jackson, Cochrane Revolving Bed Sur-
face, new.
24 inch Jackson, Cochrane Heavy Planer and
Smoother, new.
24 inch No. 1 1/2 McGregor, Gourlay Double Sur-
face.
24 inch L. Mitchell & Co. Surfacer.
24 inch No. 6 Goldie & McCulloch Single Surfacer.
13 inch Nicholls Planer, Matcher and Moulder.
28 inch Tompkins Planer, Matcher, Moulder
and Beader.
28 inch Merritt Veneer Cutting Machine, new.
18 inch Wood Turning Lathe.
20 inch Combined Disk and Drum Sander.
No. 1 Single Drum Sander, New
12 inch Four Side Moulder, Ballantyne Make.
26 inch Pedestal Band Saw, new.
40 inch Band Re-Saw, new.

**WATER WHEELS**

12 in. Archimedian Brass, Waterous.
12 in. Right Hand Farrar, new.
21 in. " " Burnham.
23 in. " " Lefel.
25 in. Right-Hand Farrar.
30 in. Left-Hand " " "
36 in. Right-Hand " " "
48 in. " " Vulcan.
No. 9 Tuerk's Water Motor, 1/2 H. P.
No. 12 " " " " " " 4 to 6 H. P.

**STONE CRUSHERS.**

No. 4 Sawyer-Massey Portable.
No. 2 Dodge Stone Crusher.
Rotary Screen for above.

**BRICK MACHINES**

Martin Brick Machine with 5 barrows and
10 moulds.

Prices and Descriptions of the above machi-  
ery, also Catalog of Mill and Engineers' Sup-  
plies, sent on request. I carry a very large line  
of iron working tools and am prepared to make  
close prices on same.

**H. W. PETRIE,**

311-33-35-37-39-41-43-45 Front Street West,  
8-10-12-14-16-18-20-22 Station Street, Toronto.

# MOLASSES

-FOR THE-

## CAMP OR STORE

We have just what you want—good sweer, heavy,  
new crop

### BARBADOS and PORTO RICO

In Puncheons for the Store trade.

In strong barrels (40 gallons) and half-barrels  
(25 gallons) for the Woods.

SEND FOR PRICES AND SAMPLES.

**The Dominion**  
**Molasses Company, Limited**  
Halifax - Nova Scotia.

## Band and Circular Mills, Band Re-Saws, Edgers, Trimmers, Lath Machinery, Slab Slashers,



LUMBER

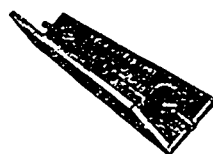

SLAB SAW



COG

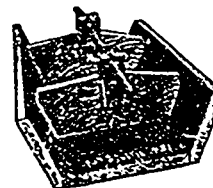

CHIP

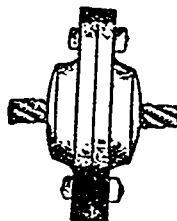
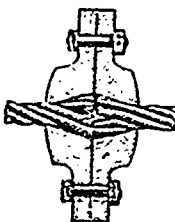
PATENT  
CABLE  
COUPLING

Kline Steam  
Log Decks  
and  
Loaders  
Steam Feeds  
Steam Niggers  
Conveyors  
for all  
Purposes

## The M. Garland Co.

Bay City, Mich., U. S. A.  
Manufacturers of High Grade Saw Mill  
and Conveying Machinery

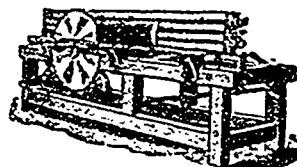

✽ ✽ Saw Mill Architects ✽ ✽

## R. SPENCE & CO.,

Booth File Works

HAMILTON, CNT.

FILE AND RASP MANUFACTURERS  
AND RE-CUTTERS.A trial order solicited. Write for price lists  
and terms.

C. P. MOORE, PROPRIETOR.

—IMHAUSER'S—

## Watchman's Time Detectors

Thief Cannot Fall.

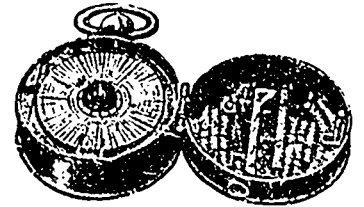

Contain all the modern improvements. Warranted  
in every way. Cannot be tampered with  
without detection. Manufactured by

E. IMHAUSER &amp; CO., 206 Broadway, New York.

Write for Catalogue Highest Award Pan-  
American Exposition.

## WALKERVILLE LOG AND LUMBER SLEIGHS AND WAGONS

ARE THE BEST.

Special Wagons also Built  
to Order.

Write to

**WALKERVILLE WAGON CO.,**  
Walkerville Ont.

## BARGAIN LIST

### Second-Hand Machinery

16x36 Brown Automatic Engine.
13x30 " " " "
12x11 McEwen Automatic Engine, High Speed.
12x11 Robb Automatic Engine, High Speed.
13 3/4 x 30 Slide Valve Engine.
8x12 Slide Valve Engine.
10x15 Centre Crank Engine.
50 h. p. Horizontal Tubular Boiler.
12 h. p. Fire Box Boiler.
8 in. 3-side MacGregor-Gourlay Moulder.
7 in. 3-side Cant Gourlay Moulder.
3x2x3 Duplex Steam Pump and Receiver.
Waymoth Gauge Lathe No. 4, nearly new.
4 h. p. Electric Motor.
1 1/2 Boiler Feed Plunger Pump.

Address—

## Laurie Engine Co.

321 St. James St.,

MONTREAL

Our Celebrated 

# Rotary Cutting Veneer Machines

made in over sixty sizes, have stood the test and proved equal to any proposition to reduce logs into thin lumber and veneers.

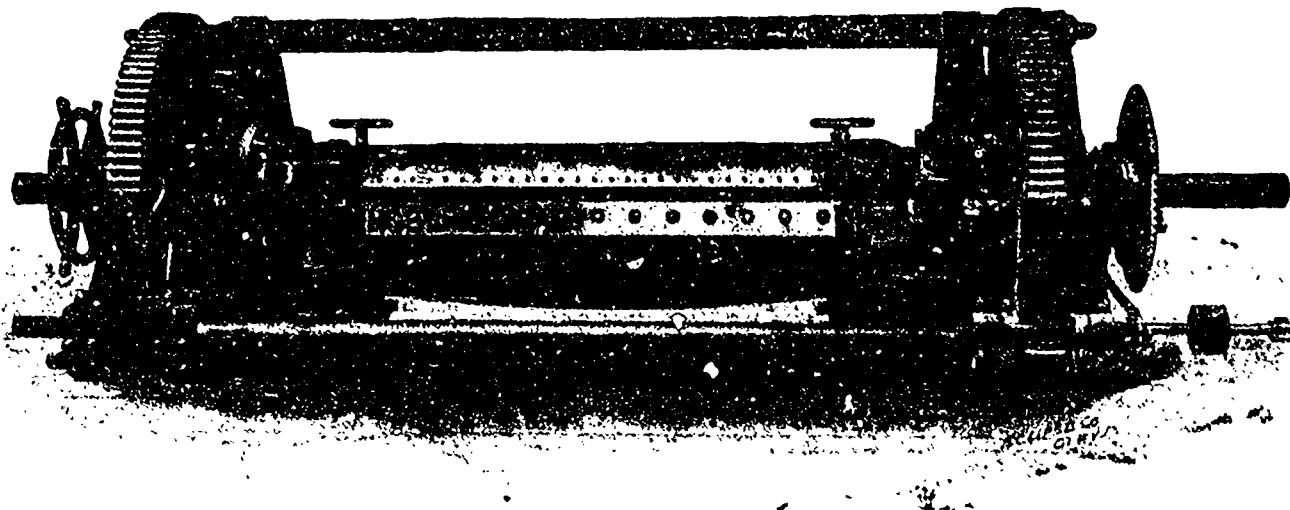

The product is high grade.  
The output is great.  
The cost of operating and maintenance is reduced to a minimum.  
Quite a combination, is it not?

Timber and mill owners should get in early.  
Buy a Coe Veneer Cutting and Drying outfit and prepare to supply thin lumber and veneers which have a healthy growing demand. More money in it than sawing your logs into lumber.

WRITE US.

## THE GOE MANUFACTURING COMPANY, Painesville, Ohio, U. S. A.

Established 1852.

Largest Builders of Veneer Cutting Machinery in the world.

# Improved Double Edger

**B**UILT in sizes from 3 saws up to 8 saws. The front top roller consists of six wheels, space 3 inches apart, thus enabling the operator to see exactly where the saws are. Fitted with one or two moveable saws. By means of removable bracket supporting the mandrel bearing, the entire set of saws can be removed and a new set placed on in a few minutes.

WRITE FOR FULL  
DESCRIPTION TO

**OWEN SOUND IRON  
WORKS CO., LIMITED**  
Owen Sound, Ont.

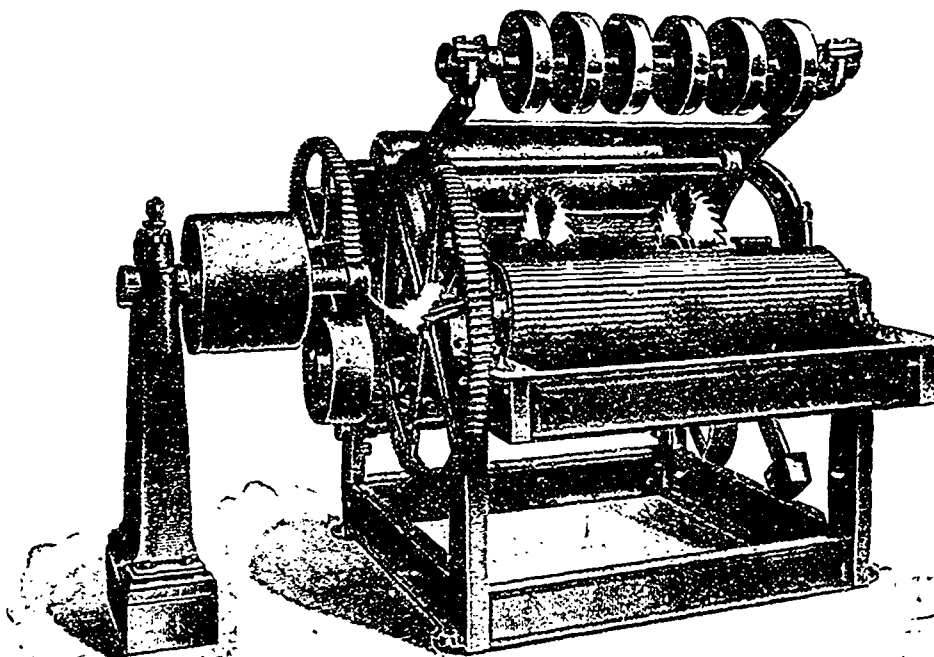

Manufacturers of  
All kinds of **Saw Mill Machinery, Boilers and Engines**



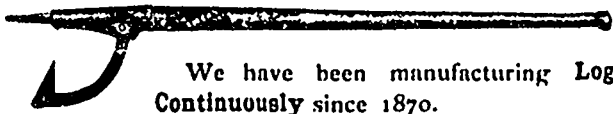

We have been manufacturing Logging Tools  
Continuously since 1870.

Many of our 1870 customers still continue using Champion  
Tools.

## You Know Why

Our illustrated catalogue and price list on application.

Champion Tool & Handle Works,  
Ewart, Michigan,



## ONE BOY AGAINST FIVE MEN

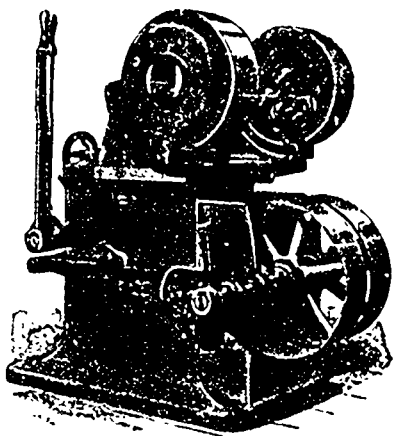

The boy with a Nash Sander will do as much  
work, and do it far better than five expert men  
can do with the old fashioned sand belt. You can

### Figure the Saving Yourself.

It is simply the difference between what you  
will pay one boy and what the five men will cost.  
If you make any kind of round work, such as  
chair legs, spindles, dowel rods, curtain poles,  
shade rollers, handles, etc.,

### You Can't Afford Not to Use it.

The machine will save its own cost in three  
months, besides making an improvement in the  
quality of your work that is a profit in itself.

Costs Nothing to Investigate.

**THE J. M. NASH SANDER CO.**  
Lake and Ferry Sts., WILWAUKEE, WIS.

SEND FOR ILLUSTRATED CATALOGS.

Manufacturers of Wood-Working Machinery, Automatic Double Saw and Chuck  
Machines, 12-Spindle and 4-Spindle Boring Machines.

## Plain Tales from the Hills

(NOT BY KIPLING)

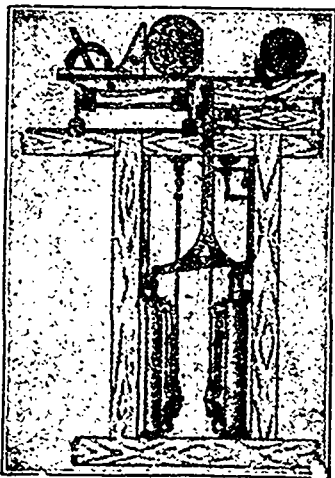

Here is a machine. It  
is called a Hill Steam  
Nigger. With it you  
can increase the cut  
of your mill three to  
five thousand feet per  
day. It can also make  
the two or three men  
now ornamenting your  
log deck superfluous  
luxuries. Now, stop  
and figure out how  
much more money you  
will be worth in a year  
if you can increase  
your cut and decrease  
your pay roll as we  
have said, then you'll  
order a Nigger.

Write for Catalogue B.

**WM. E. HILL & CO.,**

415 N. Rose Street,

KALAMAZOO, MICH.

## The Milner Petrolea Wagon Co.

LIMITED.

—MANUFACTURERS OF—

## HIGH GRADE Lumber Wagons Trucks and Sleighs

FACTORY EQUIPMENT UNEQUALLED

Experienced Management  
Specially Selected Material  
Skilled Workmen

Combine to Make Ours

## The Best Wagon on the Market

Head Office and Works - PETROLEA, ONT.

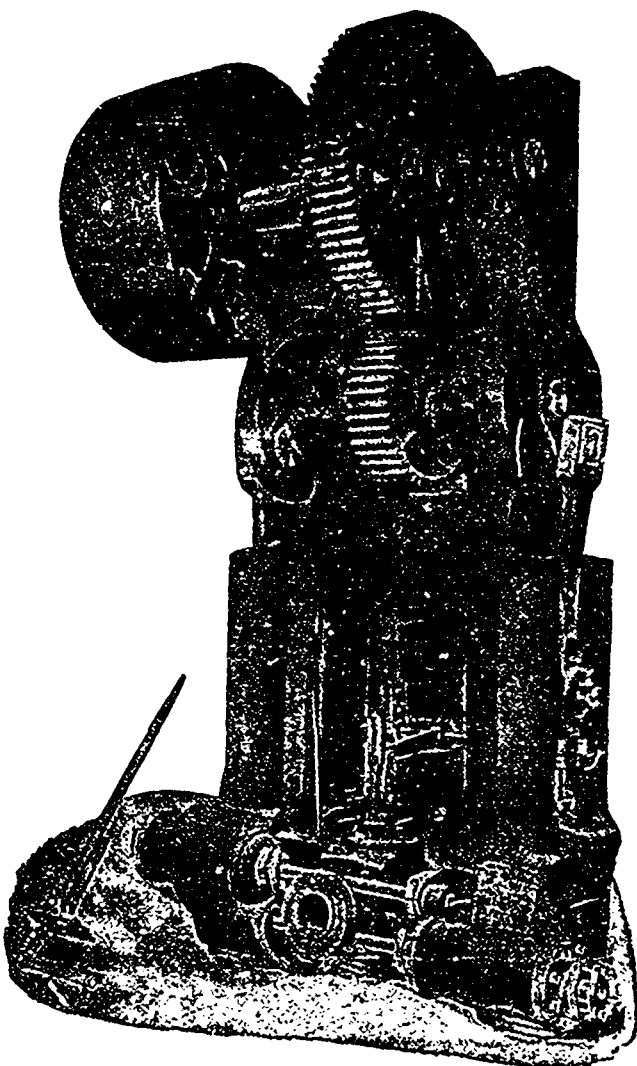

INMAN FOULSEN  
& Co.  
Oregon Pine Lumber.  
Annual Output 75  
million feet.

PORTLAND, OREGON,  
January 8th, 1903.

ZIMMERMAN - WELLS  
MACHINERY CO.,  
Portland, Oregon.

GENTLEMEN, In  
reference to your in-  
quiry regarding the  
workings of the Ray  
Patent Steam Feed  
purchased from you  
about eighteen months  
ago, we have this to  
say regarding the feed,  
that it certainly is not  
only the best feed that  
we have ever used, but  
undoubtedly has no  
equal to-day on the  
Pacific Coast.

We have dropped as  
high as twelve 24-ft. 1"  
boards in one minute.  
In doing this, the car-  
riage would have to  
travel about 650 feet  
and stop and start  
twenty-four times in  
one minute. The  
weight of the carriage,  
head blocks, and log  
would be about ten  
tons. This would give  
you a pretty good idea  
of the Power exerted  
by the feed in hand-  
ling a load of that size  
at such a velocity.

We have run this  
feed night and day  
since we have had it,  
continually, and the  
same ropes are still in  
service that were put  
on when the feed was  
mounted. Everything  
about the feed seems  
to be in as good condi-  
tion to-day as the day  
we got it. We would  
not take it out and put  
back our old feed for  
ten times the cost of  
the new one. You will  
see that we are more  
than pleased with it.

Yours truly,  
INMAN FOULSEN & Co.

GEORGE R. RAY'S PATENT TWIN ENGINE STEAM FEED  
With Drum for Wire Rope or Rack and Pinion.

—MANUFACTURED SOLELY BY—

MANISTEE IRON WORKS CO., MANISTEE, MICH.

# RIVER NAVIGATION

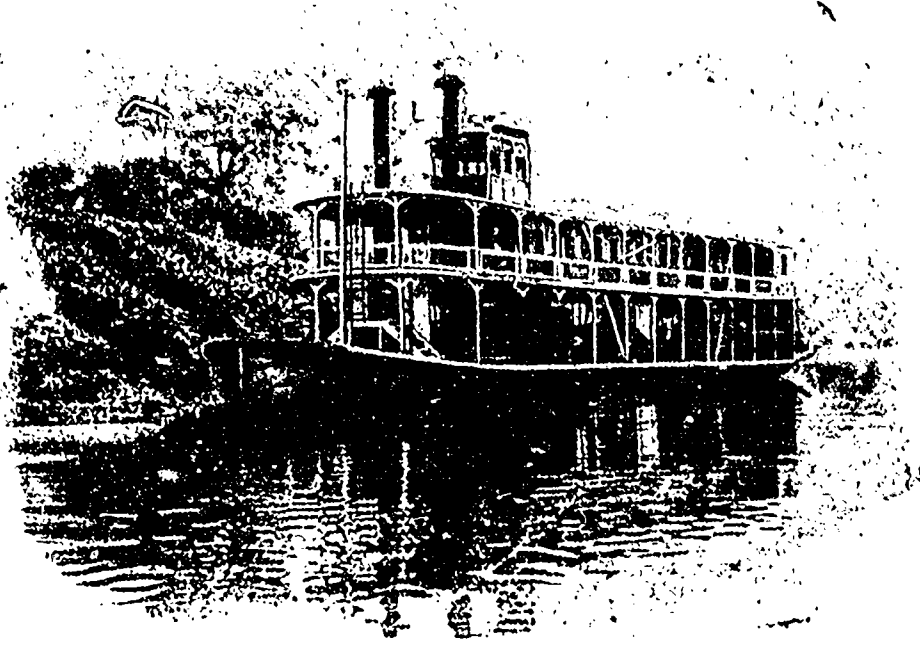

100 Foot River Steamer Designed by Marine Iron Works.  
(From Photograph.)

Our knowledge of river navigation is earned through long experience and exceptional opportunity. We design the boat and build the ENTIRE AND COMPLETE outfits of driving machinery for powerful light-draft vessels, having the best of modern shop facilities to aid us in doing ALL the work. Write to us before you act.

**MARINE IRON WORKS**     Station A.     **Chicago, U. S. A.**

Attention! Ye Lumbermen!!  
Hearken Ye!!!

We Make a Specialty of

**BARRELED PORK**

Suitable for Camp Supply

**OMAHA PACKING COMPANY**

Beef and Pork Packers

ST. JOSEPH

CHICAGO

SO. OMAHA

# "MOOSE HEAD BRAND"

## Lumbermen's Oil Tanned Larigans

If you want goods that will Fit, Wear and Give Satisfaction, be sure you get our make.

Every pair stamped with our trade mark "Moose Head Brand" and are fully guaranteed.



The leather in our goods is thoroughly tanned and they are all right for keep-over stock, as the leather will last for years.

Handled by all the leading jobbers of Boots and Shoes and Lumbermen's Supplies.



MANUFACTURED BY

**JOHN PALMER CO., Limited, Fredericton, N. B., Canada**

# Dymment, Butterfield & Co.

**BARRIE, ONT.**

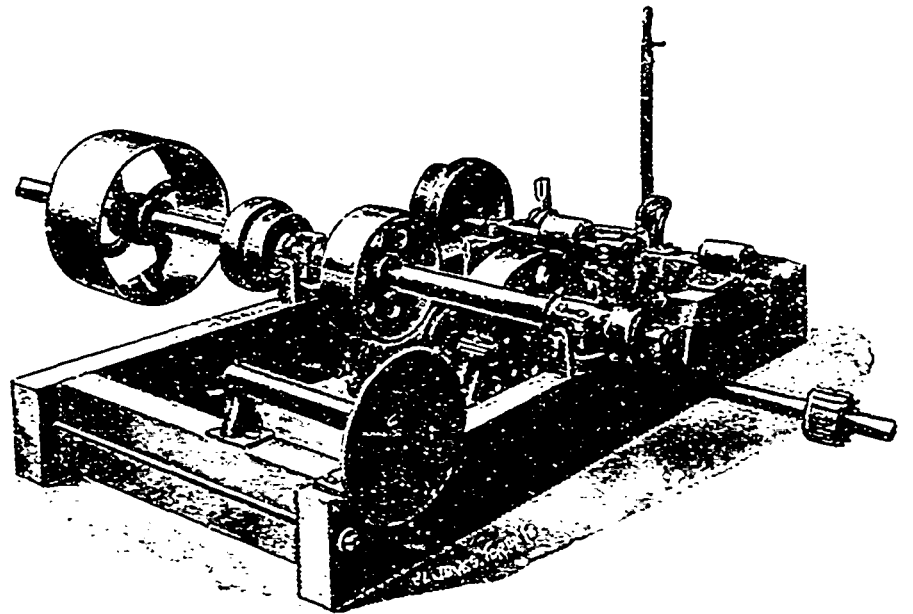
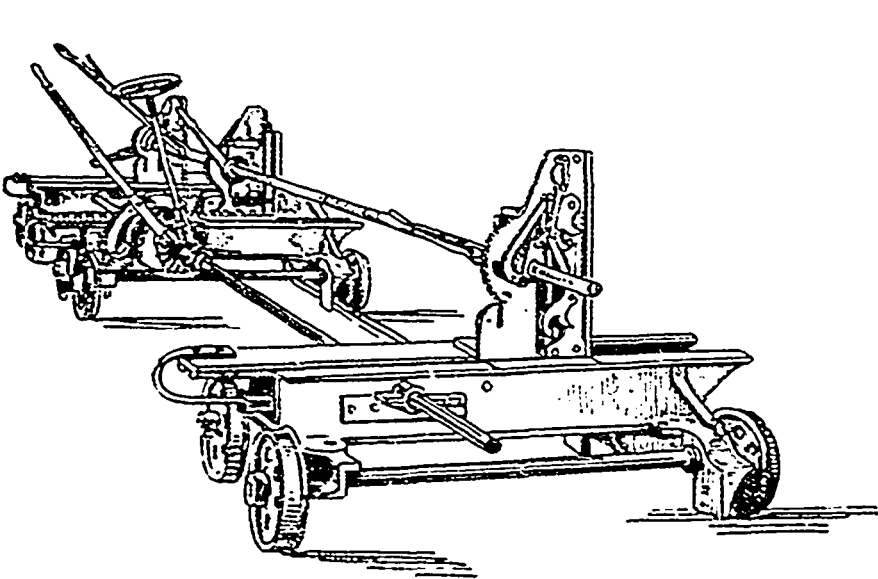

MANUFACTURERS OF . . . .

**Engines, Boilers, Saw, Shingle  
and Lath Mill Machinery**

WHEN IN THE MARKET WRITE US FOR PRICES.

# THE DAVIDSON AND HAY LIMITED

36 Yonge Street, TORONTO,

Wholesale Grocers and Importers

## LUMBERMEN'S SUPPLIES A SPECIALTY

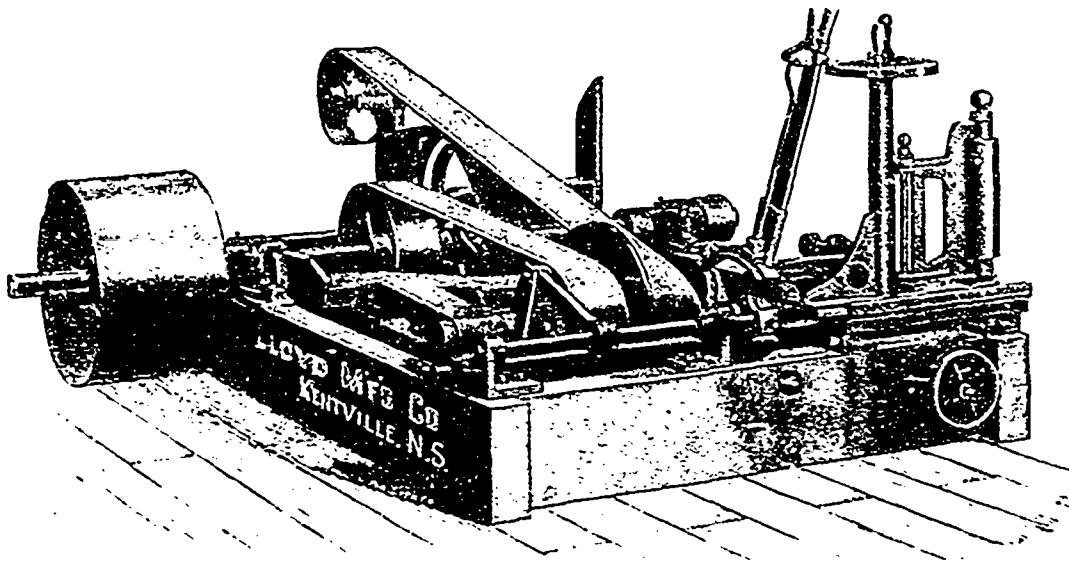

### Lloyd Manufacturing Co'y

JOHN I. LLOYD, Proprietor.

## SAW MILL OUTFITS

Pulp Machinery, Belting, Etc.

#### OUR SPECIALTIES:

- Band Saw Mill Machinery,
- Improved Rotary Saw Mills,
- with Green Mountain Dogs,
- Also Screw Post Dogs,
- Turbine Water Wheels,
- Power Feed Gang Edgers,
- Buzz and Surface Planers,
- Heading Rounders,
- Stave Machines, Stave Jointers,
- Stave Planers.

KENTVILLE, N. S.

## OUR LEADER

### Laurel Brand

# HAMS AND BACON

Dried Beef  
Boiled Hams  
Sausage

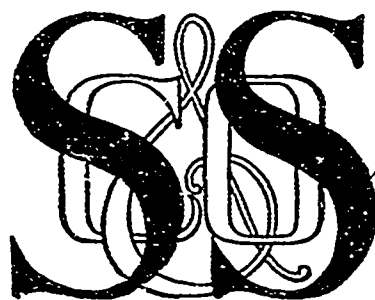

Pure Lard  
Compound  
Canned Meats

### BARRELED BEEF AND PORK OF ALL KINDS

We make a Specialty of Shipping Mixed Cars of Camp Products, Supplying Everything in the Meat Line. Commissaries should secure our Prices before placing their orders. Address Jobbing Department, Chicago.

# Schwarzschild & Sulzberger Co.

NEW YORK

CHICAGO

KANSAS CITY

## We Make Shoes For Log-drivers and Land-Lookers.



AMAZON RIVER SHOE

An experience of thirty years and a first hand knowledge of the hard service such shoes must sustain, has taught us how to make footwear for operative lumbermen that is practical, strong, comfortable and durable.

The shoe here represented is our Amazon. It is made from eight to eighteen inches in height, is built throughout of the very best material and will hold calks.

For Land-lookers we manufacture a line of light-soled high cut shoes that lessen the fatigue and stand the strain incident to hard walking over rough country.

Our catalogue contains descriptions, prices and full particulars regarding our product. Sent on application.

**Rindge, Kalmbach, Logie & Co. Ltd.**  
GRAND RAPIDS, MICH.

## Camp Supplies

**DRIED  
FRUITS  
LARD  
BEANS**

General Groceries  
of all Kinds.

We make a specialty of everything in this line suitable for Camps and Lumbermen's use.

We have had a large trade in this field for years, and know exactly what is required. The right quality of goods at the right prices will always be found with us.

We carry large Stocks of Staple Lines, which enable us to make prompt shipment at all times.

**W. H. Gillard & Co.**

WHOLESALE GROCERS, TEA AND COFFEE IMPORTERS

Write or Telegraph us when open.

HAMILTON, ONT.

## General Groceries <sup>a</sup> <sub>d</sub> Supplies

FOR THE CAMP AND DRIVE.

We can interest you when quality and prices are essential Considerations.

We will be pleased to quote you.

**PERKINS, INCHE & Co.**  
TORONTO.



IN OUR LINE WE LEAD

**McFarlane Patent Wrot Forged Steel  
Socket Cant Dogs**

Leads them all *v v v v*



*Used in every Lumbering District from the Atlantic to the Pacific Ocean*

Extra Fine Quality Split Rock  
Maple Handles.

Round and Duck Bill Peaveys and  
Cant' Hooks

Write for quotations. If once used you will never return to the old malleable sockets.

# OXFORD VULCAN

—A HEAVY STOVE FOR—  
**Logging Camps, Railroad Construction Gangs, Boarding Houses, Etc.**

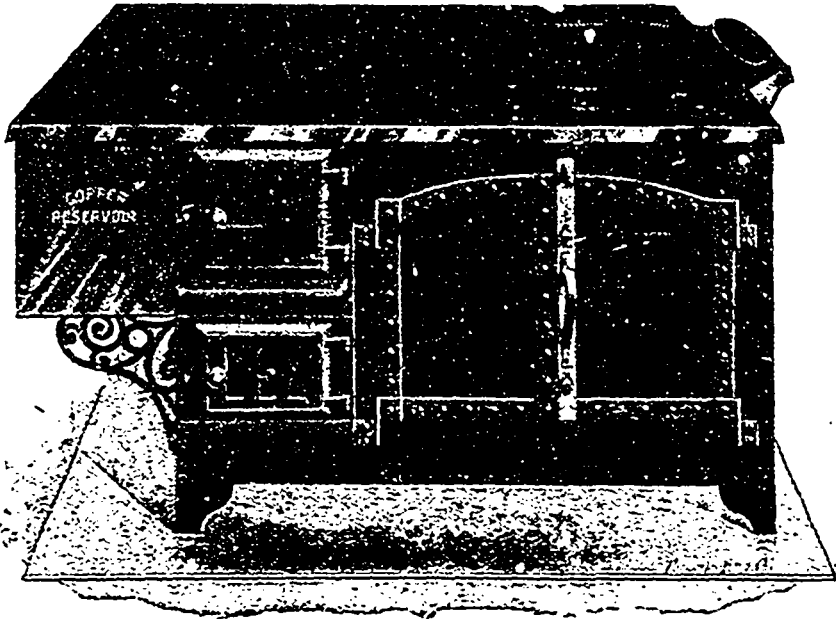

The Vulcan is a Stove made for heavy work and rough usage.

Provided with 6-10" Cooking Holes  
 —28" Fire Box—8x8½" Fire Door  
 —Oven, 25x28x16".

The Body is made of extra heavy steel.

The Top and Fire Box linings exceptionally heavy.

Reservoir of 15 gallons capacity

**THE GURNEY FOUNDRY CO., LIMITED**

**TORONTO, ONT.**

WRITE FOR PRICES.

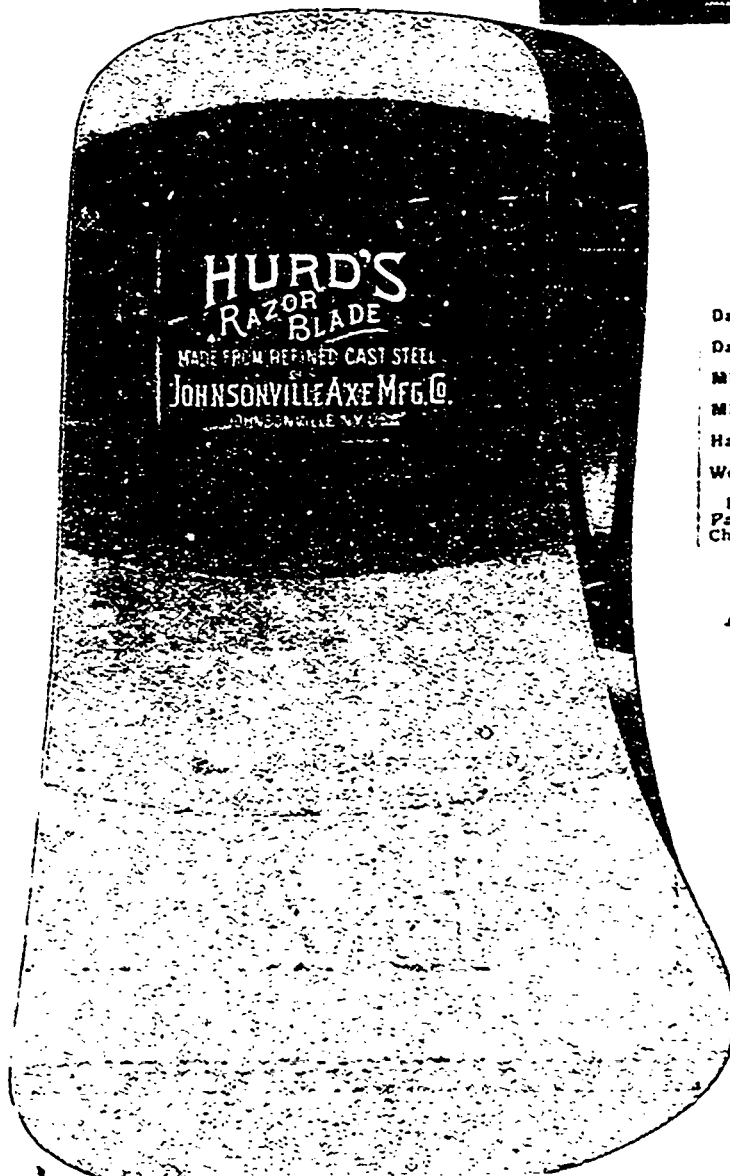

"NOT HOW CHEAP—BUT HOW GOOD"

## HURD'S

### AXES

**SINGLE BIT.**  
 Dayton Pattern  
     Bronzed  
 Dayton Pattern  
     Polished  
 Michigan Pattern  
     Bronzed  
 Michigan Pattern  
     Polished  
 Half Wedge Pattern  
     Bronzed  
 Wedge Pattern  
     Bronzed  
 Hand Made Mich.  
 Pattern, Solid Steel,  
 Charcoal Finish.

**DOUBLE BIT.**  
 Michigan Pattern  
     Bronzed  
 1½ to 4½ lbs.  
 (Hand Made Mich.  
 Pattern, Solid Steel,  
 Charcoal Finish,  
 to 4½ lbs.)

Are the Standard by Which the Merits of all Others are Judged.

Send us Your Orders now for Lumbermen's Supplies, we have what you want.

## Lewis Bros. & Co.

Address all Correspondence to

TORONTO,  
 87 York St.  
 OTTAWA,  
 54 Queen St.

WHOLESALE  
 HARDWARE  
 IRON  
 STEEL

**Montreal,  
 Que.**

H.B.K. Lumbermen's Clothing Supplies are the Best Wear Values in Canada.



H.B.K. Lumbermen's Supplies offer the Highest Range of Choice in Canada.

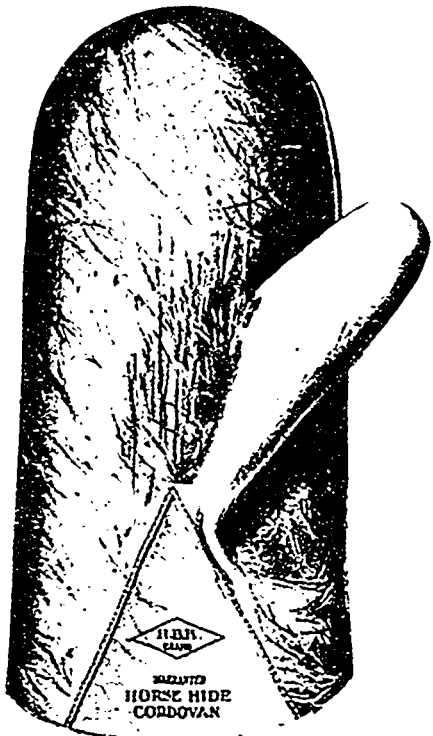

H.B.K. "Pullover" or "Chopper" Mitt.  
\$4.75 to \$8 per doz. according to leather.



H.B.K. Caps  
Leather and Corduroy.



H.B.K. Leather Mitts  
All kinds of good Mitt and Glove Leathers, \$9 to \$13.50 per doz.



H.B.K. Knit "Wrister" Mitt  
\$5 to \$9 per doz.



H.B.K. All Wool Sox.  
Great to Wear, All Wool, from a dollar per doz. up to \$4.



H.B.K. Heavy Wear Gloves  
All the way from \$5 to \$16.50 according to leather.

We are out for the supply business and we've got the goods and the values to get it. If you are afraid our traveller will miss you drop us a line and we'll advise you when he will be with you.

# HUDSON BAY

Montreal, P. Q.

H.B.K. Hardware Lumbermen's Supplies have had a "Tough" Reputation for Years.

A business that grows as fast as the H.B.K. has must have good goods and right methods back of it.

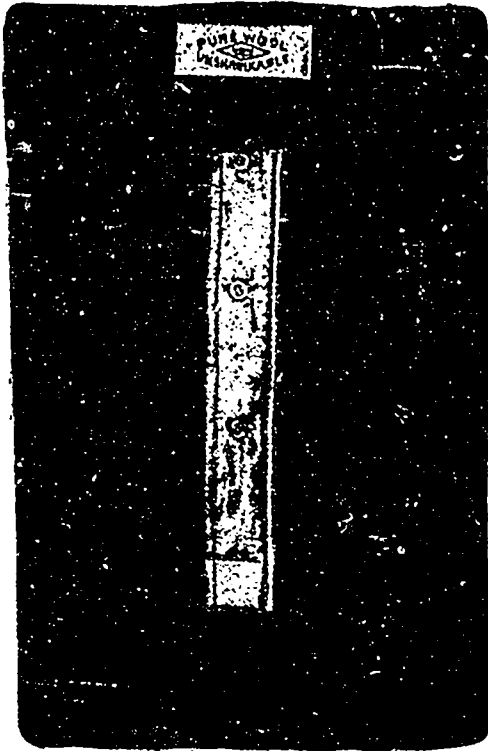

**H.B.K. All Wool Elastic Ribbed Unshrinkable Underwear**  
Good clean wool and lots of it in these H.B.K. underwear lines.



**H.B.K. Lumbermen's Socks**  
A dozen lines from \$3.50 to \$9.00 per dozen.

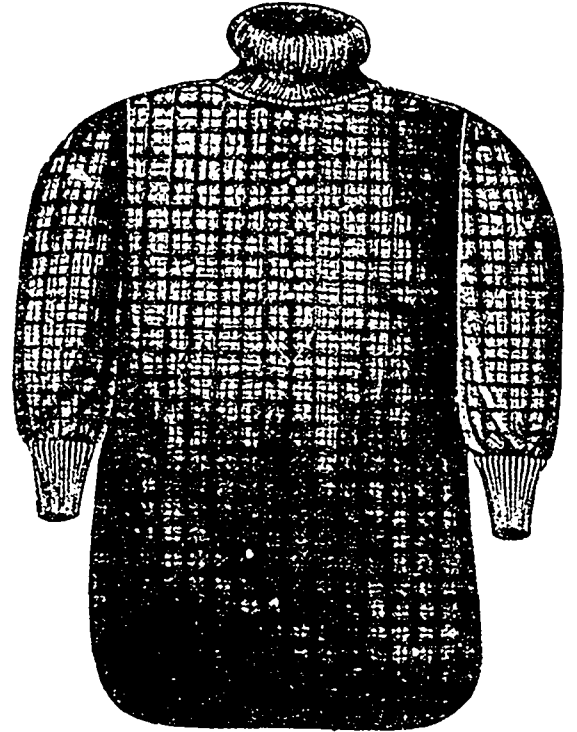

**H.B.K. Sweater Neck Shirt**  
This is a hard-wearing quick seller.



**Oil-Tanned Larrigan—For Men, Boys and Youths**  
Heavy oil-tanned stock, wears like iron, sheds water like a duck, double extra stout wax-thread hand-sewed seams, large eyelets and string lacing, bellows front, a corking good Larrigan for the lumber trade.



**H.B.K. Shearling Lined Jackets**  
Corduroy and Rubberized Duck.

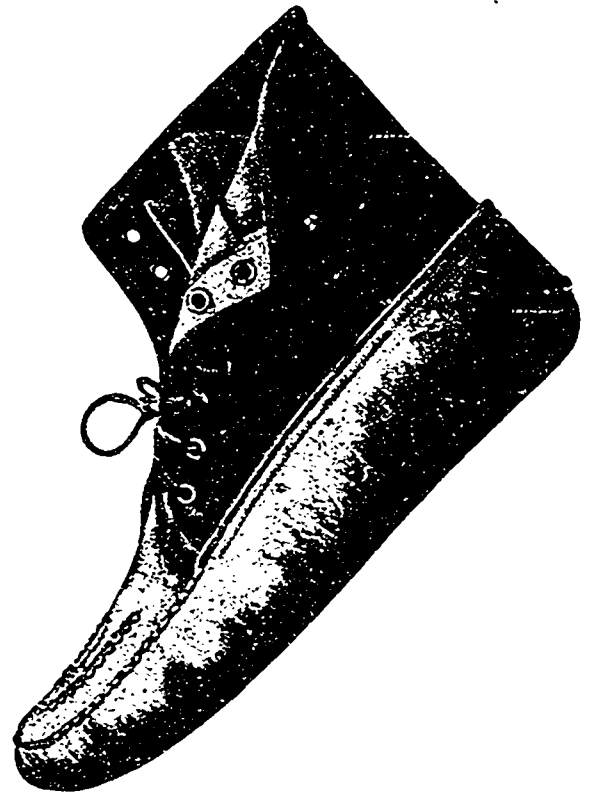

**H.B.K. Elkskin Mocassin**  
No better anywhere at any price.

Short cuts in making, direct buying for cash, up-to-date ideas and push and enterprise have made H.B.K. the best and brightest lines in Canada.

# KNITTING CO.

Winnipeg, Man.



# Why Not Cut Down the Expenses of Your Power Transmission?

It can be done by the installation of the Dodge Rope System.

The Dodge Rope drive is cheaper in its first cost of installation than other systems

It is more positive as to power delivery.

It delivers power with practically no diminution, as slippage and friction are minimized.

It is flexible in operation, distributing power to any desired point at small cost of installation and maintenance.

It combines with the Dodge Split Friction Clutch to make each drive distinct and separate so that a break never delays but the affected drive.

It delivers power positively and without loss, lessening fuel bills.

It is simple, durable and easy to keep in order, always ready for action and never causing complete shut downs from breaks.

We make Dodge Rope Drives to fit every individual case.

Let us submit plans and prices to you and demonstrate that the Dodge system will cut down your expenses.

**THE DODGE MANUFACTURING CO. OF TORONTO, LIMITED,**  
Toronto.

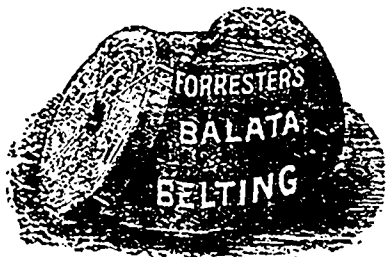

## Flexible Stitched Waterproof

THE THOS. FORRESTER CO.,  
Montreal

## Syracuse Smelting Works

Manufacturers		Importers and Dealers	
Babbit Metals	Phosphor Tin	Pig Tin	Antimony
Solder	and all White Metal Mixtures	Pig Lead	Aluminum and
Type Metals	Canadian made	Ingot Copper	Bismuth, etc.,
Phosphor Bronze		Spelter	etc., etc.

CANADIAN WORKS: William and St. Thomas Sts., Montreal.  
Head Office, American Works, 94 Gold Street, New York City  
Long Distance Telephone Main 398

# WIRE ROPE

.. For all Purposes ..

Alligators, Towing, Boom and Fall Ropes

LARGE STOCK CARRIED—CUT TO ANY LENGTH

## Special Ropes for Lumbering

Blocks, Clips, Thimbles, etc.

The Dominion Wire Rope Co., Limited  
MONTREAL, QUE.

## THOMAS FORMAN COMPANY, LIMITED PETROIT, MICH.

MANUFACTURERS OF

## High Grade Maple and Oak Flooring

polished and finished to perfection.

Please write us for prices, and any other information pertaining to this material.

# WIRE ROPE



Special Alligator Ropes any lengths, fitted with proper attachments.  
Saw Carriage Ropes.  
Haulage Ropes.  
Elevator Ropes.  
Smoke Stack Stays, etc.  
Standard and Lang's Patent Lay.

THE B. GREENING WIRE COMPANY, LIMITED  
HAMILTON, ONT. MONTREAL, QUE.

Every Lumberman wants it 35 cents buys it

## Scribner's Lumber and Log Book

BRIMFUL OF EVERY-DAY, PRACTICAL INFORMATION Address: THE CANADA LUMBERMAN, Toronto

# THE CANADA LUMBERMAN

VOLUME XXIII  
NUMBER 5

TORONTO, CANADA, MAY, 1903

TERMS, \$1.00 PER YEAR  
{Single Copies, 10 Cents

## THE CANADIAN LUMBER CAMP

By P. H. BRYCE, M.A., M.D.

THE stories of voyageur and lumberman have echoed down the years of a century, and the public have, through Parker's "Romany of the Snows," and Gordon's "Man from Glengarry," been given pictures which cause the aroma of a primitive, almost savage civilization to cling to the occupation which for more than one hundred years has been the back-bone of Canadian industry and a means of wealth to her largest capitalists. Whatever of truth there has been in these romances of the lumber woods, there is to-day another history growing by gradual accretion, which, when written, will show that the Canadian lumberwoods is but the rear farm of thousands of lusty frontier Canadians, who having completed the summer's work in their homes, take their surplus energies to one of the best paying labour markets in Canada to-day.

These well-to-do young farmers are not likely to be very different in the camp from what they are at home; neither are they, without protest, likely to endure living conditions which in the ruder days, with smaller and less permanent camps, and fewer transportation facilities, naturally resulted.

A very brief summary of modern conditions, by one who has viewed the camps from neither the employer or employee's standpoint, may perhaps be of interest to the readers of THE LUMBERMAN.

With the enormous extent of lumbering operations in Ontario, extending some 1,200 miles from east to west and hundreds of miles north and south, with the greatly increased investment of capital and the yearly enlarging market for the products of the forest, it is apparent, with railways and steamships constantly increasing transportation facilities, that it has become possible to introduce into lumbering every element of a systematized business which is continuously in operation throughout the year. Within recent years the season's cutting operations have begun much earlier than formerly, and in September and even in August the axemen move toward the woods, erect new camps, take in necessary temporary supplies and begin the season's cut. Overseers or foremen have

already gone over the area of the winter's prospective cut and fixed the number and location of camps with a view to easy access to one another and to the base of operations on some railway or navigable lake or stream, so that the construction of camps and the connecting roads is rapidly completed.

It is at this point where one of the chief differences between past and present may be seen. In former days the limits operated were those nearest the largest streams, and operations were distributed along these; but to-day, the interior townships have to be worked and a



HIGGINS' LUMBER CAMP IN THE SUDBURY DISTRICT OF ONTARIO.

comprehensive plan of campaign, with its central base a permanent camp, and its outlying posts or temporary camps, is necessary to economy of operations. This naturally means better buildings, and as may be seen in the accompanying cut a central lumber camp means a small village in the forest. It consists usually of (1). The main dwelling or dwellings of the men. (2). Cookhouse and eating room in separate compartments. (3). Wash-house and a tub-room. (4). Stables. (5). Store-room and offices.

Such are the common equipments of the head-quarters camp, to which the sanitary regulations of 1901 have added a separate building or tent equipped for the reception of any person suffering from an accident, or if a contagious disease they are housed in a separate tent.

In past years complaint was frequently made that a disregard was frequently shown by foremen while locating a camp in the matter of securing a water supply free from danger of

pollution by the drainage from the stables and camp, and instances were not lacking of outbreaks of typhoid resulting from such neglect. More frequent than this, perhaps, was the complaint that the disposition of the household wastes from the kitchen as well as the location of stables and latrines were wholly at variance with the first principles of sanitation; but when it is remembered how in the permanent homes in many of our villages a similar neglect exists, we do not wonder that these temporary homes in the woods were not infrequently found lacking in this regard.

It was with a view to remedying some of these evils incident to usually some of the smaller camps and enforcing the definite care of the men through hospital and medical attention, that in 1901 the Ontario Legislature passed an

Act providing for definite regulations being made, whereby the camps were required to be constructed on well drained locations, to have a minimum air space per man of 300 cubic feet, that a regular ventilation be supplied by fresh air being brought to a space beneath the stove, while an equal area of exits for foul air was supplied by ducts carried from near the floor to the heated spaces around the stove pipes; that the cookhouse be in a separate building, and that buckets for the kitchen refuse be regularly used for a daily removal to such a distance as would prevent a nuisance, and that latrines or

earth-closets be located and cared for in such a manner as to be approved of by the medical officer of the company or by a provincial health officer.

The manner in which the large number of operators have endeavored to carry out the regulations has been most gratifying, and in the monthly reports received from their medical officers, the almost complete absence during the past winter of contagious disease, as small-pox or diphtheria, in the 30,000 men of the camps, and in the absence of complaints whether from employers or employees, it may be said with truth that nowhere within the Province has any similar population for the same period probably maintained so high a state of general health.

Such, then, are the conditions under which the many thousands of our shantymen now spend their winter evenings; for during the days their labors in the pineries are so absolutely free from the polluting touch of human habita-

tion that, except for the occasional accident, such life in the evergreens is the surest health tonic, and the certain guarantee of an appetite and zest for the slumbers of the night and the camp-fire stories. Formerly the occupations of the men in the shanties during the evenings were not elevating; but to-day in well ordered camps the library and the night-school, through the sacrifice of missionary workers and the liberality of the employers assisted by the government, are supplying not only occupation and entertainment but are being made an increasing source of instruction for many. Nor are legitimate amusements wanting. A visit made by an officer recently to the camps found the graphophone agent plying his trade. A price was set on an instrument and a camp raffle organized. The phone became the property of the fortunate one; but so charmed were the others that not one but many were purchased to be taken home to delight less enfaus "bien aimés."

Equally great are the changes in the drinking habits of the shantymen with those in the older settlements. More than one of the counties whence go the largest number of shantymen voted in the recent plebiscite for prohibition, while the curé and the clergyman are welcome visitors in the many widely distributed camps.

It would not be pardonable in a health officer, in such a general article, to omit a reference to a phase of this life in the northern forests too often overlooked. This is its value as a health asset to our population of young men. The life possesses in the highest degree the three elements of a strenuous life, viz., vigorous exercise in the most glorious atmosphere possible, crisp and balsam scented, an adequate diet of the best nitrogenous and heat-making foods necessary for such labours, and a long night of refreshing slumber. Many have been the dyspeptic young men who have come from the woods at the end of the season strong and well, who elsewhere would by spring have been marked with the hectic of the consumptive.

What the training yearly of so large a number of young men in woodcraft means to a province or country with its millions of acres of untrodden forests with their uncalculated wealth, is not often thought of in the way it deserves. But it is to such, rather than to those drifting to our cities, that we are to look in the future, as in the past, for those captains of industry who build railways, navigate seas, and snatch from the flinty bosoms of the rocks the hidden wealth of a nation. Be it Aleck Lachance or Pierre Delorme, Sandy Macdonald or Duncan Cameron, the echo of the woodman's axe is ever the same. The halloo and chains-rattling of the galloping teams through the bush road stir the blood of the teamster to deeds of skill, and the rafting of the logs in the rivers still calls for the same daring of the river-drivers as of old.

"Dere's a beeg jam up the reever, were rapids is runnin' fast,  
An de log we cut las winter is takin' up all de room.  
So boss of de gang is swearin, for notin'g at all can pass,  
An float away down the current till somebody break de boom."

"Dere was de job for a feller, handy an' young an' smart,  
Willin' to tak hees chances, willin' to risk hees life.  
Cos many a ting is safer, than tryin' de boom to start,  
For if de log wance ketches you, dey're cuttin' you lak a knife."

#### THE GREAT NORTHERN RAILWAY.

It may interest the readers of the CANADA LUMBERMAN to know that the Great Northern Railway of Canada has just taken over the Montfort & Gatineau Colonization Railway extending from Montfort Junction on the C.P.R. Labelle branch northwesterly to Arundel, on the Rouge River, a distance of 33 miles. A survey has already been made from Montfort Junction to connect with the Great Northern main line at St. Jerome, (12 miles), and it is expected the road will be continued through to the new bridge under construction at Bout

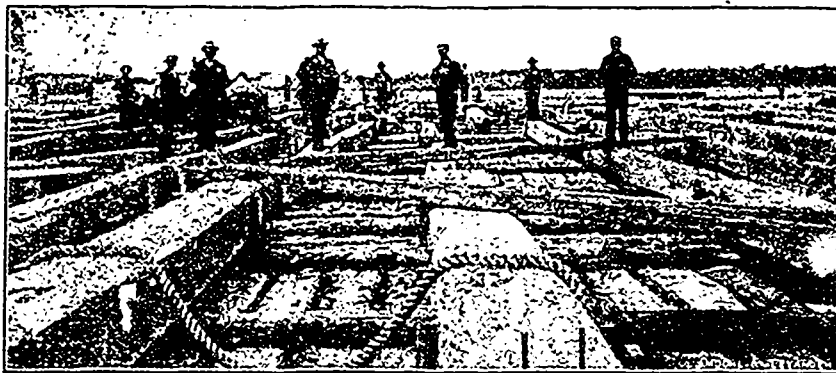

RAFT OF TIMBER ON THE UPPER OTTAWA RIVER.

de l'Isle, making a through line from what is now the Montfort Division to Montreal.

Reports from this section show that there are about 1000 cars of lumber and slabs on hand from last year and this year's cut is estimated at 16 million feet, principally spruce, and the lakes are fairly black with logs. There is also quite a large quantity of square birch being taken out, as this seems to be the best hardwood country in the Province of Quebec. The principal operators in this vicinity are the Laurentian Lumber Company (Williamson & Morrison), W. D. Graham, who also represents the Ottawa Lumber Company, and Rinaldo McConnell, of Ottawa. Mill owners on this road have experienced a great deal of trouble in the past in getting their freight shipped, but now that the road has been taken over by a more powerful corporation, it is expected this will be a thing of the past and already quite a number of cars have been loaded out, principally to Montreal. The country itself is most picturesque, the car window giving one a continuous view of mountain, lake and river. Sixteen Island lake is the gem of the Laurentides. This new deal will give lumbermen of that section the opportunity of exporting via Quebec, as well as Montreal so

far the Great Northern has arranged for a weekly service of the Leyland Line, Quebec to London, of which the first vessel will be the "Iberian", April 25th, every 12 days to Manchester, first sailing "Austriana" May 6th, and fortnightly sailings to Liverpool and Rotterdam are now being arranged.

#### SAW MILLS AND LUMBER IN CUBA.

Mr. Max J. Bachr, United States Consul at Cienfuegos, Cuba, writes as follows:

Many complaints have been made here relative to the lack of milling facilities for dressed lumber. A lumber dealer of this city, Mr. Hunter, states that there are only two saw mills here, neither of much utility, and they charge exorbitant prices for dressing lumber—\$9 per 1,000 feet. He has leased for four years, with the privilege of buying at the expiration of that time, the best milling site in Cienfuegos, and he offers this site free of rent to any enterprising American who will establish a modern saw mill here. He will promise the American all of his own sawing, and no doubt he would receive the work of the many large plantations in this province and that of the new Cuban Central Railroad. Mr. Hunter says that there is a great local demand for doors, window frames and mouldings at very profitable prices, these articles being now imported from the United States under heavy rates of duty.

The fact that an American firm has established a good saw mill in Habana and is now buying logs in this port and shipping them to the mill, paying freight rates equal to a shipment to the United States, makes it apparent that the establishment of a mill in this city under the conditions mentioned would be very profitable. My own investigations

along this line substantiate Mr. Hunter's conclusions.

In connection herewith I would mention that the two principal export woods of Cuba—mahogany and cedar—are steadily enhancing in value, and the holders of the choicest timber lands on the north coast, as well as those holding lands adjacent to the new Central Railroad, are advancing their prices. Nevertheless, there are good mahogany lands on the south coast of Cuba that may yet be bought at a low figure.

#### GOOD LUMBER MARKET IN EGYPT.

Dr. Cartwright, son of Sir Richard Cartwright, Canadian Minister of Trade and Commerce, is on his way from Egypt, where he was officiating as surgeon to an English regiment. He says Egypt has a great future and offers goods prospects for business men.

Dr. Cartwright further said that there was a splendid opening there for Canadian pine. Egypt was timberless, and there was a lumber monopoly. Most of the timber used now came from Norway. He had written to Sir Richard Cartwright urging the Canadian Government to make known the Egyptian market to Canadian shippers.

# The Food Supply for Lumber Camps

A Comparison of the Provisions Furnished To-Day with Those of Earlier Years.

IN the twentieth century lumber camp the commissariat is as important a feature as it is in the modern army. The shrewd operator figures out the problem of food supply a long ways ahead, seven or eight months in fact. Though the work on the limits does not commence till August, the movement of supplies is generally attended to in the preceding months of December, January and February. Thus by taking advantage of the snow and ice roads, transportation is facilitated and cost of same reduced.

The supplies for the camps are purchased nowadays much in the same manner as they were ten or twenty years back. The buying is generally attended to by the head of the lumbering firm. While tenders are not called for, the advantage of such a procedure is secured through the enterprise of the wholesale firms themselves, who are all eager to supply the expansive invoice of goods. Prices are quoted on the different lines of stuff, and the lumberman, buying in quantities, secures the reduced or wholesale rate granted the retail merchant.

There is one difference that the years have brought about, formerly the goods were delivered at the railway station most convenient to the limit, now the purchaser has to pay freight from the city of first shipment. Few of the lumber firms employ a purchasing agent, as do railways and other large corporations.

The stock that can now be found in a well appointed "keep-over," as a food depot is called in lumbering parlance, would do justice to the best general store. It was not always thus. Fifteen years ago the sturdy shanty-man who partook of his humble dish of pork and beans, offered a striking contrast to the axeman of the present day who finds on the limits a table that equals, in quality and variety of food offered, the country hotels and many of the city houses for that matter.

It is generally supposed that the pioneer shantymen waxed strong on pork and beans. This is not historically correct. The pork preceded the beans, the latter being introduced at a later date on the Canadian limits by the American firms. In the early days the bill of

fare in the shanty was a "lean" one, the principal items being pork and hard tack.

An aristocracy was established in the camp-community years ago by this same question of food. The man who could afford the luxury of a cup of green tea was considered a notch higher than his fellow less fortunate. The men had to provide their own tea pots, knives and forks. Sometimes they had to secure their own tea, and where it was furnished by the firms, the men in many camps had to pay for it out of their wages, so that tea was considered a great luxury. The years passed by and beans,

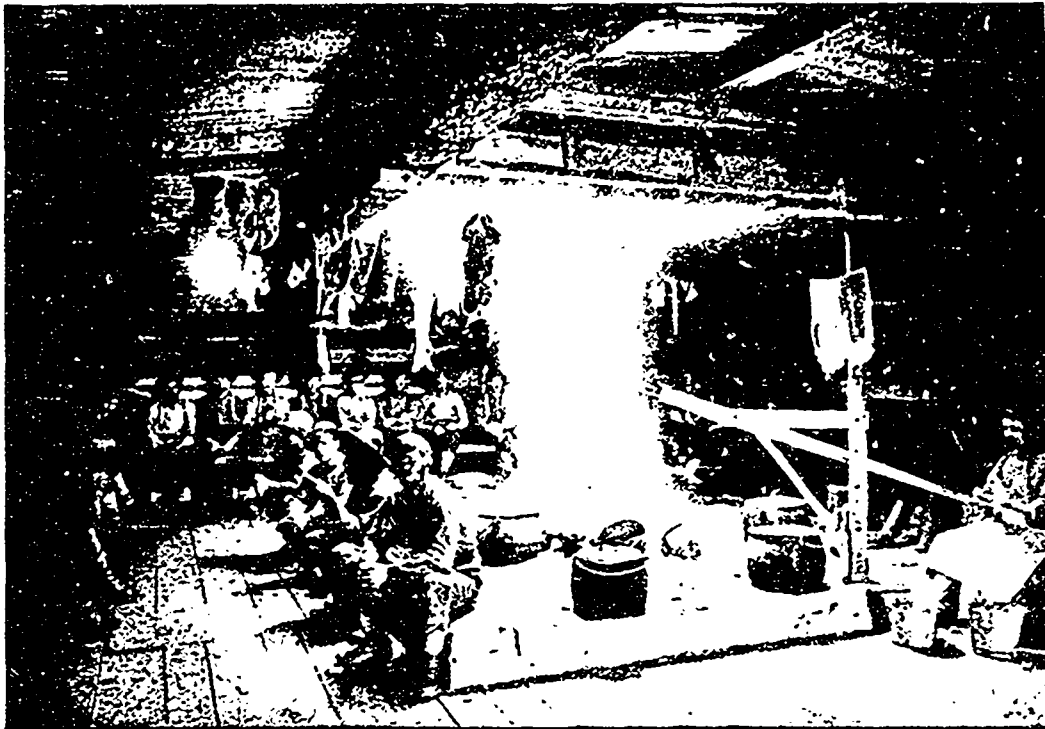

THE "CAMBOOSE" SHANTY.

The "Camboose" Shanty is still in evidence on the Coulonge River. This old style has been abandoned on almost all other streams for the American style—the cooking range and the box stove—which is considered more up-to-date and economical, but there are concerns who prefer to keep up the old style on account of its being more cheerful for the men and because they think it more cleanly and healthful. The cooking is all done over the open log fire. The bread and beans are baked in the hot sand.

peas, rice, dried apples, fish, and molasses, or "blackstrap", found their way into the camps, and bread replaced the hard tack.

It may be asked, why were beans, peas and dried apples selected for camp fare? There are several reasons. In the first place, they were generally moderate in price, readily handled in transit, and easily prepared for the table on the open fire of the "camboose".

In the early days the meal was prepared and partaken of under the roof that sheltered the bunks of the shantymen. Thus the one room served all purposes—eating, cooking, and sleeping apartment. The cook had to bake his bread in the open fire place and the hot sand and ashes furnished him with his primitive oven. Everything baked and boiled had to be so treated in covered pots. The sponge for the bread was placed in one of these receptacles and buried in the hot sand and ashes, the pork, beans or peas were placed in other pots sus-

pending from a crane, and the dinner was "on."

When the men were assembled for the meal, each took his seat on his bunk, plate in hand. From the pots the men all helped themselves, the result being a waste of food, as liberal "leavings" were thrown back into the open fire. This meant a big expense item. It was an uncommon thing in the days of the early eighties to find vegetables in the camps.

How are things now? Vastly different and greatly improved. An invoice of supplies for the limits will contain mention of pork, beef, corned and fresh, salt and fresh fish, flour, beans, peas, rice, butter and lard, jam, evaporated apples and other dried fruits, such as apricots, peaches, dates, prunes, figs, raisins and currants, tea, sugar, yellow and granulated, syrup and molasses, rolled oats, and sometimes even toilet soap, meals and tobacco. Where the firms cannot secure vegetables from the farmers or transport them

in bulk, the table is supplied with vegetables in the evaporated form. Some firms substitute jam in a great measure for the more expensive butter. One Ottawa firm alone supplied four tons of the best butter to its camps this season.

A comparison of the following invoices, one dated 1890 and the other 1902, will give an idea of the change in supplies and prices wrought in the last 12 years alone. The 1902 prices are for goods delivered at the lumberman's nearest station, while the 1890 prices are f.o.b. at the city of shipment, the lumberman paying his own freight.

A run-over the invoices furnishes some interesting comparisons. In November, 1890, for instance, mess pork

was sold at \$13 per barrel, short cut at \$12.25, and long clear bacon at 7 cents per pound, as against mess pork \$21.75, short cut \$23.25 per barrel and 11 1/8 cents for long clear in 1902. Yellow sugar quoted at \$3.63 in 1890 fell to \$3.38 in 1902, molasses at 42 cents per gallon in 1890 dropped to 27 cents in 1902.

INVOICE OF SUPPLIES - 1890.

White beans, per bushel	\$ 1.30
Syrup, per lb	2 5/8
Japan tea, per lb.	14 1/2
Windsor salt, per bbl.	1.30
Split peas, per lb.	2
Raisins, per lb.	4 1/2
Dried apples (not evaporated)	4 1/4
Prince of Wales tobacco	49
Brier tobacco.	53
Royal yeast	100
Yellow sugar	3.63
Molasses	42
Baking powder	20
Nutmegs	1.00
Brooms	2.35
Black pepper	15
Mustard	17
Common soap, per lb	4
Currants, 1/2 bbls	6

## INVOICE OF SUPPLIES—1890 (Continued.)

Dressed hogs	5 1/4
Long clear bacon	7
Mess pork, per bbl.	13.00
Short cut pork	15 25
Beef (fresh), very little used	5 1/4
Pure lard	8 1/4
Compound lard (mostly used)	6 1/4
Tub butter	14
Oats (car load delivered)	30 1/2

## INVOICE OF SUPPLIES—1902.

Prince white beans, per bush.	\$ 1.60
Perf. syrup, per 1/2 bbl.	3 1/2
Young Hyson tea, per lb.	16 1/2
Windsor salt, per bbl.	2.15
Split peas, per bag	2.50
Roller oats, per bbl.	5.00
Fos. raisins, per bbl.	7 1/4
80/90 prunes 50	5 1/4
Evap. apples No. 1	7 1/4
Figs, new	4
P. of W. tobacco	66
Brier	70
Royal yeast	1.00
Rangoon rice	3 1/2
Yellow sugar	3.38
Mincemeat	7
Soda biscuits	6 1/2
Vinegar	18
Molasses, per pail	27
Bi Carb. soda, per keg	2.20
Ocean Wave bkg. powder	11
Nutmegs	50
Heavy brooms, No. 4, per doz.	2.75
Gem. scrub brushes	90
Pure blk pepper	17
Mustard	10
Cream tartar	18
Quintals codfish	5.50
Shell castile soap, 2 lb bars	8
Crash towelling	7 1/2
Linseed meal	3 1/2
Corn meal	4.00
Comfort soap	3.75
Cld. currants	4 1/4
Gran. sugar	4.03
Tomatoes	1.25
Corn	85
Brl raw linseed oil, gal.	80
Crates jam	6 1/4
Lard 20/20	10 1/4
Long clear bacon	11 1/2
Butter (good)	17 1/2
Flour (Manitoba) car load	3.70
Fresh beef (car loads)	
Short cut pork per bbl.	23.25
Mess " per bbl.	21.75

The following is the evolution of the present well laden camp table from the day of salt pork and hard tack twenty years ago. Pork and hard tack followed by beans and peas, followed by "black strap" or molasses, dried apples and bread, followed by tea and corn beef, followed by sugars, meals, dried fruits, fresh beef, biscuits, vegetables, butter, jam, etc.

In the culinary department there has also been a marked change, second only to that mentioned in the make-up of the bill of fare. No longer are the meals prepared and partaken of under the roof that covers the sleeping quarters.

With the introduction of the box stove by the American operators in Canada twelve or fifteen years ago, came the erection of separate buildings to house them. Meals are now prepared on the regulation stoves and served on the regulation tables. In the distribution the cook has the help of several assistants. There is a direct and inseparable connection between the introduction of the box stove and the extension of the bill of fare. The former made the latter possible. Roasts, stews, pastr., etc., which were difficult problems on the open fire place, are easily handled with the stove.

While the cook now has better facilities and better variety of material than formerly, more is expected of him, and he has to prepare everything down to doughnuts and pies. At some camps near the railways beef is received on

the hoof and a daily supply of fresh meat is thus made possible.

If the cook is careless he can waste his month's salary many times over in thirty days. There is now on the part of the shantymen a natural desire to try a little of everything put on the table. His desire over-reaches his appetite, and right here there will be a considerable waste unless the cook who is entrusted with the distribution of the food exercises foresight. The men with a bill of fare ranging from rice to roasts are harder to please than in the days of fat pork and hard tack, when the height of luxury was reached with bean soup. Now-a-days there is but a small percentage of waste compared with former years, owing to the improved and economical preparation and distribution of the food.

It is a difficult matter to say whether or not the cost of running the camp table has been greater in recent years than it was in former seasons. This season's prices were certainly higher. Much depends on that staple article of camp diet, pork—which still finds a prominent place on the camp table, although in some camps, where fresh beef has been substituted, it is not so largely used as before the days of beef and a score of other articles of food, such as dried fruits. Pork was exceedingly high this season, forcing the cost per man per day up to 40 cents, according to the buyer for one leading local firm. The comparative cost ten years ago according to the same informant was 25 cents. Of course, if it should happen that pork would drop in price, a comparison would show that the modern table would cost less than the old time one. The introduction of dried fruits, etc., reasonable in price, and the falling off in the consumption of pork, would also have a tendency, if the "long clear" were low in price, to reduce the cost of the camp table. Much depends, however, on the "razor back" and the cost of other staples and the transportation.

While there is a greater variety of food than formerly, it must be remembered that the prices of sugar, rice, dried fruits, etc., which have been added in the interval, are comparatively low compared with that of pork, the staple food of the early days. Since their introduction the consumption of pork has fallen off, and right here a big saving has been effected. When it is remembered that mess pork has sold as high as \$22 dollars per barrel, it can be seen that the substitution of dried fruits, syrup, corn beef, etc., at greatly reduced prices, is an economical move. Dried fruits can be secured at rates ranging from 4 to 7 cents per pound. Only the best grades are procured, as they are found to be the cheapest by the time they reach the camp table.

The extension of the railway system has reduced the cost of transportation, and hence made a big cut in the general bill of supplies which formerly had to be carried in by man and sleigh.

There can be no question, then, but what in the matter of food supply, conditions have been greatly improved in the last twenty-five years.

The development of the railway systems has also done much to facilitate the movement of supplies, men and horses to the limits. Thirty

years ago all three had to be forwarded from Ottawa, for instance, by toll road to Aylmer, Quebec, and thence sent forward by ice or water, as the case might be, up the long stretches of the Upper Ottawa to the limits. Naturally this was a tedious trip, covering sometimes two and even three weeks. Now the same distance can be covered by the aid of the railway in a couple of days. Later on, with the extension of the railways, the Canadian Pacific Railway was used as far as Pembroke, and later still Mattawa was chosen as the point from which to strike off the railway. With the building of the Temiscamingue branch of the Canadian Pacific, Mattawa in turn lost its prestige.

In the bygone days as now it was the aim to get the supplies in to the limits during the winter season so as to take advantage of the snow and river roads. Naturally it required more men in the absence of the railroads to perform this transportation work, and gangs used to be employed the year round. Men who hired for the woods would frequently be required to give a hand in the movement of supplies.

Even at the present day the supplies for the Gatineau limits have to be moved forward by sleigh from Gracefield, the Gatineau branch of the Canadian Pacific Railway. It speaks well for the honesty of the shantymen that not a single article has ever been stolen despite the fact that the loaded sleighs are left open over night.

## CARE OF RIVER SHOES.

Of interest to the lumber camps will be the method of calking and care of river shoes or boots. To calk them, first thoroughly wet the outer sole, then put a last in the sole that fits solid. Do not make too large a hole to receive the calk. Only drive them between two rows of pegs and in the center. Too many calks weaken the sole.

Shoes when wet should not be allowed to dry too close to a hot fire, as extreme heat will in a short time destroy the fibre of the best leather and render it worthless. Boots constantly worn in and around swamps or streams should be kept greased. A good preparation is one part of beeswax and four parts tallow melted together and then mixed with three parts of castor oil. The beeswax and tallow will keep out the water and the oil will make the leather soft and pliable. Do not apply too hot. Hot grease will often burn the shoe. Blood heat is the proper thing. Place one hand inside the boot and with the other rub the grease into the pores of the leather. Camp foremen should make a note of the above.

## INSERTED OR CHISEL TOOTH SAWS.

Of interest to sawyers and all saw users will be the advertisement of the Jas. Ohlen & Sons Saw Mfg. Company, Columbus, Ohio, to be found in this issue. For over fifty years this company has made saws. Their grinding machines are immense affairs, weighing many tons, and it is impossible for a saw not to come out true. This company make and sell solid as well as inserted tooth saws, with four styles of chisel bit saws. Their "Columbia," 5 to 9 gauge, is adapted for use in British Columbia and on the Pacific coast. They also manufacture shingle, top, resawing, siding, concave and edger saws, as well as drag, grooving and mitre saws. The Ohlen Company's saw gummets, cutter grinders, groovers, ratchet drills, saw and yoke mandrels are favourably known all over the continent. Send for their free illustrated book.

The Rathbun Company have purchased McCormick & McLeod's tie and shingle mill at Baptiste, Ont., together with limits connected therewith.

## THE CANADIAN SHANTYMAN

THE cycle of time, with its changes, has not passed by the shantyman—*homme de chantier* or *bucheron*, as he is better known where the French tongue predominates. Take him thirty years ago and he was a different man from his brother of to-day. In the early seventies, when industrial development was in its infancy in Canada, the shantyman was a power in the land. He was a husky chap, with muscles of iron and nerves of steel, as fond of work, and as steady and obedient during the working hours, as a well regulated machine. Year in and year out the same men worked for the same firms and the relations between employer and employee were as a rule cordial.

August found the man behind the axe on his way to the limits. Railway facilities were then practically unknown and a long journey by wagon and boat was followed by a tramp 75 miles in length, sometimes 125 miles or more. The following April saw the same man returning to civilization on the drive. Steady going chaps rounded the year out in the lumber business by accepting work for the summer months in the mills.

One year the wages dropped as low as \$10 a month and board for shanty work, but the average ran from \$16 to \$18 and board. No one dreamed of securing the \$28 and \$30, with board attached, paid in recent years to inexperienced youths as well as able-bodied men.

There is no denying the fact that the shantyman as he was known thirty years ago is a rarity to-day. Where has he gone? Who has succeeded him? Speaking in general terms, the wave of prosperity has engulfed him and carried him into other channels of labor.

Speaking specifically, it may be stated that the colonization of the North-west and the newer districts of Ontario and Quebec, the wonderful development of the pulp and paper making industry in Canada, the strides made in railroad building, particularly in the west, and the attractions held forth by the industrial centers of the New England States, have all combined to lure the experienced men away from the limits.

Who have taken the places of the sturdy, old-time shantymen? Raw youths, farm help and mediocre mechanics from the towns and cities, attracted by the high wages offered, have stepped forward into the vacancies, which they fill only too often on the pay sheet alone.

Thirty years ago the employment agencies had little or no difficulty securing all the skilled help they wanted from the saw mill towns and central Quebec. In the last few years they have been forced to recruit from Eastern Quebec as well.

In passing it must also be remembered that the scarcity of good men is due in a measure to the increased demand. The development of the Georgian Bay district by American capital in recent years, and the reappearance of old time firms in the limits of the Ottawa river districts after several years' absence, have cre-

ated an unprecedented demand, hence the presence in many camps of an inferior class of men.

A comparison of the shantyman of the seventies and his co-worker of the present day as men, gives everything in favor of the former. He was paid less money, had to undergo more hardships, was worked harder, and received poorer fare; but through it all he proved himself a man, loyal to his foreman and eager to break the record for the log-cut in his camp. He ate his pork and beans with better sense of appreciation and greater relish than is shown by the modern chap who over a bill of fare that excels the table of the average country hotel, clamors for the dismissal of the cook.

Operators agree that the labor problem is the great stumbling block in the present otherwise smooth current of the lumber business. In the seventies the man who earned his meal by his muscle had hardly any alternative in Ottawa and other lumbering districts but to hie himself to the limits for the fall and winter work. He could secure employment there when other avenues were closed by King Winter's iron hand. If there was a slump in the lumber market and wages dropped, it made no difference, \$10 a month and board found him as ready as \$18 a month and board. He asked no questions, his aim being to secure if possible service year after year with the same firm and foreman. The question of discomforts did not come to his mind, and a tramp of 75 miles made necessary by the absence of railroads brought no protest. Nowadays the shantyman who has to walk a third of this distance inland from the railway insists on working at an advance of several dollars over current wages.

The chopper in *Ye Olden Days* had an incentive to good work that was absent until recently. There was a brisk demand for hewers and scorers, and a log maker who showed a knowledge of his business was rewarded by the foreman with a "hand" at the square timber making. In a season he would become proficient at the latter and place himself in possession of a much fatter pay envelope. In the last decade, however, the British demand for square timber fell off to an extent that threatened extinction. Hence the log maker had no chance to acquire the knack of hewing and scoring, with its bigger pay; and about an equal opportunity to exercise his gift even if it were acquired. Thus the experienced square timber workers—a fair percentage of the shanty population—were also deprived of employment by the slump in the market, and while some of the younger scorers and hewers fell back on the log cutting, the older hands gave up the work on the limits altogether. Hence a class of very desirable men were lost to the work. This loss was felt during the past two seasons, when the boom in the square timber trade made a heavy demand on experienced labor. The supply could not fill the demand and the monthly wage rose accordingly to \$55 with board.

In the seventies as nowadays, Ottawa was the great employment bureau for Ontario and Quebec, if not for the Dominion. Men flocked to the Capital from all parts of Quebec, much as political favor seekers do to-day. It was a rare thing then for an agent to have to go off his own street to secure any number of men. But with the development of the pulp and paper making industry, the colonization craze and the general industrial prosperity, the influx of men for the limits has grown less year by year. It's a case now where the agents have to get out and hustle and not the men. Last season several Ottawa firms had men scouring the country as far east as Gaspé. Many of the camps in the Georgian Bay district were manned direct from that far-off district.

While wages have been high in the camps for several years past, the financial consideration has not been sufficient to tempt good steady and experienced men in the way that lower wages did in former years. Why is this? Simply because the demand for the high class of laborers for other lines of labor has been much better in recent years, and the men even at the sacrifice of a few dollars prefer remaining in the bosom of their families, providing they can get steady work, to undergoing voluntary exile in the shanties.

Men must be secured for the limits, however, and hence it follows that the employment agencies have been forced to accept all comers and go out and look for more. The idle class of the towns, cities, and countryside, blinded by the glitter of the gold to the dross of the "shantying," have stepped in eagerly to fill up the gaps, only to drop out, many of them, at the first opportunity. These are the deserters who kick for fresh meat every day, and demand the dismissal of the cook if the fruit pies are not "sugared." In the seventies and early eighties fresh meat and pies were as rare as the parson's visit. It's commonly remarked that the shantyman of the present day has been spoiled by kindness, and events bear out the remark. In the earlier years, the outspoken foremen, brusque to the point of roughness, was considered just the man for the job, now he wouldn't be tolerated; and his dismissal would be clamoured for by the awkward squad forced upon him by the employment agencies.

In the days of pork and beans, when each man ate from the side of his bunk, the cook was a fixture year in and year out, practically unnoticed. Nowadays when the hotel menu is served in a separate shanty the cook is the subject of everyone's criticism. As many as four and five changes have had to be made in one season to satisfy the clamouring of the men who threatened to leave unless the cook was changed. The crank, the crook, and the cheat, are well represented in the shanties of the present day. In the days of the good old shantyman a "jumper" was unknown. Last winter the men were leaving daily, despite the fact that they were far better treated in every way than their predecessors. Young fellows with one and two years' experience are now demanding the wages paid men of ten years' experience.

The average shantyman does not cut as many logs a day now as did the cheerful, con-

tented chaf of former days. There are several reasons for this falling off. In the first place, the man of to-day cannot handle an axe as well as did the man of a by-gone year. In the second place, the latter was cutting the virgin forest where the marked trees were well grouped, while nowadays the axemen have to cover a wider territory to get the same number of logs, so effective has been the thinning out process of the intervening years.

In the seventies the men hired for a whole season, which included fall and winter chopping and the spring "drives". Nowadays out of ten men seven come down ahead of the drives, despite the fact that they can earn \$35 to \$45 working on the latter. As a consequence the agents have to scour the country to engage other help. This year large numbers of Indians are being hired for the river work. To perform it they pass on the way men who are fleeing from it. Some of the latter go up again when they go "broke" in the city.

The passing of the genuine shantyman is not a catch phrase, it's a reality. It's hard to find one, where half a dozen stood in the seventies. Before the railways were built it took the firms two and sometimes three weeks to get a gang into the shanties, but the members stayed and worked there. While the presence of the railway now facilitates the inward movement, it also offers an additional temptation to the restless man to "jump" his job.

In one thing the shantyman of the seventies resembles his brother of to-day, he's a French Canadian, seven out of ten of "him." No other race seems to have made the same successful study of the business.

#### WIRE HOOPS FOR BARRELS.

The Washburn - Crosby Company, of Minneapolis, are disposed to look favorably upon the spiral-steel wire hoop for flour barrels. The type of barrel experimented with has borne four patent hoops and four wire ones, one of each being placed on the heads and one of each on each side of the bilge. The hoop being spiral in form can be readily driven and also is sufficiently elastic to conform to any changes in the barrel from the effect of moisture. In the past week the company have used about 4,000 of these barrels in sending flour eastward, and more of the hoops have been ordered. The present high prices for patent hoops are not relished by the company, and they aim to adopt substitutes to the end that they may in future avoid paying unduly high prices, whatever the supply of wooden hoops may be. The wire hoops are offered at less than \$8 per M f.o.b. Minneapolis. — Northwestern Miller.

#### A BUSINESS GETTER.

Under date of April 16th the Hanchett Swage Works, of Grand Rapids, Mich., write to THE LUMBERMAN as follows: "We want to tell you again that we are very well pleased with the results that we are getting from your paper."

E. C. Atkins & Company, saw and tool manufacturers, Indianapolis, Ind., have received cable advice from New Zealand that the championship sawing contest held on Easter Monday was won by the party using the Atkins saw. Full details will be given later.

## THE CANADIAN READING CAMP MOVEMENT.

By A. O. PATTERSON, M.A.

To be satisfied with the past or present state of things, and to be content that things should solidify as they are and remain forever fixed, is to cultivate intellectual torpor and spiritual inertia. Such a condition is at variance with the whole trend and impulse of this modern age. To keep abreast of the times, to move in the front rank and feel the breeze in his face is the ambition of the man of to-day. Probably he sacrifices too much, at times, in his eagerness to be to the front, but at any rate he is to be praised for his energy. The most ignoble of deaths to-day is the death of sluggishness and the most disenchanted of valleys is "Sleepy Hollow."

This energy and spirit of go-ahead in the 20th century, breeds an optimism and a faith that fears no obstacles. We see on all sides the most astounding results of human progress. So accustomed are we to the wonders of science and discovery unfolding to use very day, that we

Like the two pans of a scale, therefore, must our gains—material and social—be equipoised. Wealth is the blood and sinews of our people, but it is not the full man. It is the man in readiness for his journey, but some one must give him a goal. It is the man equipped for the fight, but some one must tell him how and what to fight. But the present age has been liberal in diffusing enlightenment, has exerted itself in many ways to secure a more wholesome, intelligent way of living, and is still going on to better things. The problem of the slums and submerged masses in great cities has been faced by the Salvation Army and others, and beginning to be solved. The question of child-labour in factories and mines has been treated successfully, the jolly jack-tar is no longer a neglected dog of the sea, going into periodical madness in port. The condition of the toiler everywhere has been alleviated and improved. It is recognized by all enlightened employers that to treat their operatives as machines or chattels causes a distinct deterioration in the work as well as in the workman, whereas



N. N. WRIGHT & COMPANY'S CAMP, 12 MILES FROM CARTIER, ONT.

have almost ceased to marvel. We live in a sort of Arabian Nights atmosphere, and take these great finds and flights of the questing spirit of man as a part of the dramatic program for which we have secured our tickets and have a right to witness to the end.

But heat is not applied to one part of the body without affecting the whole. If great energy is awakened along commercial and scientific lines, almost or quite as great forwardness of spirit is moving along the lines of social betterment. The 19th century has been significant equally by reason of its social and material gains. Indeed the one is quite the compliment of the other, or is contained in the other, as effect in cause. For wealth and prosperity is the food and life-blood of civilization. A weak, impoverished body never effects strong deeds or reaches the heights or profundities of human thought. Nor can a starveling people be a great people. Contrariwise to the glutinous man and pampered sensualist no entrance is given to the kingdom of higher things—and Rome's imperial head lay low when once she had drained to the dregs her Cerecian cup of luxury.

the humanizing of their lot, liberating them from ignorance, recovering them from low and besotted ways, pays in every sense of the word. More and a higher grade of work is done because the operative is more enlightened, contented and industrious. One need hardly refer to examples such as the Patterson works, Dayton, Ohio, and others to prove the truth of such statements.

Of a piece with this improvement of conditions amongst sailors, amongst the masses in cities and operatives in factories, and in keeping with the enlightened progress of the age, is the work of the Canadian Reading Camp Association, called into existence and carried on by the enthusiasm and ability of its General Secretary, Rev. A. Fitzpatrick, of Nairn Centre. To shed the light of its civilization into all parts of its dominion is a country's work as much as the amassing of its wealth; to exploit and build up its mental as well as its material resources. The workers in our lumbering and mining districts and railway construction camps are the pioneers in the opening up and expoliting of the illimitable richness of our fields, forests and mines. These men meet the brunt

of rude, primeval nature. They make the road which civilization in its graceful, easy carriage, may afterwards ride. Is it right that they should toil as mere cattle with dumb endurance, without that liberty and enlightenment of mind which gives freedom and elasticity to the step and clearness to the eye of the man who has been taught and understands? It is not well for our civilization to be a car of Jugernaut riding over the necks of vassals to its conquests.



EXTERIOR VIEW OF READING ROOM, GEORGIAN BAY LUMBER COMPANY'S CAMP, 25 MILES FROM COLDWATER, ONT.

Rather like an army with one thought, one purpose, one enthusiasm diffused through all, should we go forth as brother men to subdue and conquer the land so full of promise and erect the citadel of our country's greatness.

Of the numbers employed in our mines and woods there is no accurate census. But fifty thousand men or more are to be found in the lumbering districts of Ontario alone. Of these fifteen or twenty per cent. are unable to write their own names and three-fourths of the men are wholly illiterate. But even with an education the isolation and neglect which these men suffer for six or eight months of the year tends toward a rapid degeneration of the man. Without high thoughts to occupy him in his



INTERIOR VIEW OF READING ROOM, GEORGIAN BAY LUMBER COMPANY'S CAMP.

leisure, low thoughts soon take possession of him. His toiling, eating, sleeping existence tends to animalism. The Reading Camp Association is endeavoring to change all that, to give these men the full rights of citizenship by keeping them in touch with the life of the nation. Reading rooms or shanties have been built in the lumbering districts of Ontario, Manitoba, and British Columbia, and these rooms are provided with games, current papers,

magazines, music and books, to entertain and instruct the men in their leisure moments. The work is also being extended to railway construction and mining camps, and our popular Canadian author "Ralph Connor" is undertaking the building and maintenance of a reading-camp at a "mine-mouth" in British Columbia. Through the past winter eight young men—three of whom were college graduates—were employed as instructors in the camps. These men "roughed" it in the woods during the day, and conducted classes in the evening. The experiment was in the main satisfactory. Many availed themselves of instruction, and a general interest was awakened.

The centralization of all wealth, all culture and enjoyment in the great centres of population is a thing of the past. With us in Canada it would be absurd and an impossibility. Our greatness consists mainly in our agricultural area. Our citizens must live in their rural homes. They cannot circle in the immediate splendor of the city luminary and at the same time conduct their business of sowing and tilling. The city must come to them, must shed its light to

Quebec, and it is hoped that Ontario will in this as in other matters, carry forward the banner of the nation's progress and glory, and the other provinces may be depended on to be loyal to the flag.

INDUCTION MOTORS IN WOOD-WORKING ESTABLISHMENTS.

In view of the interest which attaches to the use of small power in wood-working shops, it may not be inopportune to call attention to a striking example of the application of induction motors to the driving of shop machinery as afforded by the plant of a concern in Brooklyn manufacturing tobacco pipes and walking sticks. The plant consists of two buildings, a three-storey brick factory, 200x600 feet, and a small brick power house at a distance of but a few feet from the factory. The original intention of the operators of the establishment was to make use of direct current from the distribution system of one of the Brooklyn power companies, but a polyphase alternating system was finally installed on account of its many attractive features. Power for the fac-



A CORNER IN THE ONTARIO LUMBER COMPANY'S READING ROOM, 6 MILES FROM NORTH BAY, ONT.

them. It must and should be a reservoir or distributing centre to all the land of the knowledge and culture of the age. And this has come about in so much that the opprobrium of "hayseed" has fallen into the oblivion it merits. The farmer of to-day is well read and abreast of the times. The good roads movement and system of rural mail delivery being initiated are waves of the same tide that is now set from the city-centers to irrigate and enrich the country far and wide. The Reading Camp Association is merely setting its sails to this general breeze, in trying to enrich and brighten the lives of the hardy toilers in remote sections of the country. It is a work that appeals to our patriotism, our sense of justice and humanity. The Ontario Government was interviewed on the 11th of March last by a strong deputation of lumbermen and educationalists, and has promised the fullest consideration of the matter. It is expected that as a third of the revenue of the province is derived from its timber dues alone, that a liberal grant will be given to this very necessary work. The work has been begun in our prairie and mountain provinces, and will be begun next winter in

tory is furnished by two Westinghouse two-phase compensated field alternators, driven by Corliss and Ball & Wood engines having a close speed regulation. Excitation is furnished by small multipolar dynamos driven from the main generator shafts. The switchboard contains three panels for generators and feeders. The main power system operates at 220 volts, and all motors are wound for this pressure. Lighting is also supplied from the two-phase mains, special balancing transformers being introduced between the 220-volt leads for the purpose of furnishing a 110-volt three-wire lighting service and equalizing unbalanced loads upon the lighting system.

Motive power in the factory is furnished by fourteen Westinghouse type "C" induction motors, varying in capacity from 5 to 20-h. p. The motors are belted to short line shafts, which, in turn, drive various types of belted machinery, including turning and mounting lathes, circular and hand saws, buffers, blowers, drill and machine shop tools. The motors are started at a reduced voltage by means of Westinghouse starting coils, and when near synchronous speed are thrown directly upon the 220-volt system.—Carpentry and Building,



# THE Canada Lumberman

MONTHLY AND WEEKLY EDITIONS

PUBLISHED BY

The C. H. Mortimer Publishing Company  
of Toronto, Limited,

CONFEDERATION LIFE BUILDING, TORONTO.

BRANCH OFFICES:

IMPERIAL BUILDING, MONTREAL.  
22 GREAT ST. HELENS, LONDON, E. C.

The LUMBERMAN Weekly Edition is published every Wednesday, and the Monthly Edition on the 1st day of every month.

## TERMS OF SUBSCRIPTION:

One Copy, Weekly and Monthly, One Year, in advance. \$ 1.00  
One Copy, Weekly and Monthly, Six Months, in advance. .50  
Foreign Subscription, \$2.00 a Year.

## ADVERTISING RATES ON APPLICATION.

THE CANADA LUMBERMAN is published in the interests of the lumber, wood-working and allied industries, being the only representative in Canada of these important interests. It aims at giving full and timely information on all subjects touching these interests, and invites free discussion by its readers.

Special pains are taken to secure for publication in the WEEKLY LUMBERMAN the latest and most trustworthy market quotations throughout the world, so as to afford to the trade at home and abroad information on which it can rely in its operations. Subscribers will find the small amount they pay for the CANADA LUMBERMAN quite insignificant as compared with its value to them. There is not an individual in the trade, or specially interested in it, who should not be on our list, thus obtaining the present benefit and aiding and encouraging us to render it even more complete.

Advertisers will receive careful attention and liberal treatment. For manufacturing and supply firms wishing to bring their goods to the attention of owners and operators of saw and planing mills, wood-working factories, pulp mills, etc., the CANADA LUMBERMAN is undoubtedly the cheapest and most profitable advertising medium. Special attention is directed to "WANTED" and "FOR SALE" advertisements, which are inserted in a conspicuous position on front page of the Weekly Edition.

## THE TIMBER POLICY OF THE BRITISH COLUMBIA GOVERNMENT.

The rapidity with which the lumbering industry of British Columbia is expanding, has impressed upon the government the necessity of adopting regulations governing the disposal of timber lands and cutting of timber that may be regarded as being permanent, that will be likely to give satisfaction to the lumberman, and ensure as far as possible a perpetuation of the timber supply. British Columbia has not yet perfected its timber policy to the same extent as the eastern provinces. That it is proposed to do so is evidenced by regulations that have recently been put into effect. The task is not lightened by the peculiar conditions under which lumbering is conducted in that province. While in the east the timber limits are largely held by the saw mill owners, this is not the case in British Columbia, where a large portion of the timber area is taken up by loggers under special licenses. Thus in framing regulations the government feels called upon to consider the interests of both the logger and the mill owner, although they are sometimes diverse, as was the case with the prohibition of the export of timber.

Special licenses above referred to are granted for one year only, and entitle the holder to not more than 640 acres. They are not transferable, and are renewable only at the discretion of the government. It is claimed that these restrictions are too exacting, and that the industry has now reached a stage where the purchaser of a timber limit should feel more certain that if he should build a railway and make improvements for logging purposes, he will not be compelled to release his right to the property at the end of a year.

Conferences between the Loggers' Associa-

tion and the Lumber Manufacturers' Association have resulted in the framing of a petition containing certain regulations which the government are asked to adopt. One of these is, that licenses be issued for a fixed term of not less than five years. Another is that holders of licenses shall commence operations within three months or forfeit their license, and another, that licenses shall be issued only to parties engaged in logging or manufacturing lumber. The two latter clauses are, in our opinion, very important, as their adoption would remove the opportunity for speculation in timber limits which now exists and which has grown very rapidly of late.

The recent regulation providing that no special licenses to cut timber be granted until after the limits have been surveyed, is strongly opposed by the lumbermen, but as the Honorable Commissioner of Crown Lands seems disposed to assume an attitude of justice and helpfulness towards the lumber industry, it is probable that any grievances will be remedied, and that eventually a timber policy will be framed that will be satisfactory to the lumber trade and in the best interests of the province.

## CANADIAN TRADE AND THE TARIFF.

Canada has too long suffered from fear. Business men have lacked the confidence necessary to inspire them to launch out and capture the greater percentage of foreign trade which was their's for the seeking. Living as we do beside a country of less area, but with a population ten times as great as that of Canada, we have realized our lesser commercial importance to an extent that has proved a barrier to our advancement. This timidity, it is pleasing to observe, is at last passing away, and in a very few years Canada promises to be one of the great manufacturing countries of the world. It is not possible to read the statistical trade reports issued by the government without feeling encouraged. For the nine months ending March 31, the value of our exports was \$162,420,763, and that of our imports \$155,440,030, an increase of \$17,873,890 and \$14,707,327 respectively. This showing of trade expansion is suggestive.

The trade policy of Canada at the present time is one of moderate protection, a policy which, it may fairly be said, is giving satisfaction to the majority. For this reason the budget speech of Honorable Mr. Fielding, Minister of Finance, in which he promised no radical tariff changes, was well received by the country. Mr. Fielding pointed out that there is nothing in the circumstances of the country calling for a general revision of the tariff.

Touching upon the preferential tariff, Mr. Fielding held that a return preference should be given by Great Britain. The Canadian Government had offered, if the British Government would accept the principle of preference, to give Britain a certain preference in the Canadian market. But this, he made quite clear, would be a preference as between the British and foreign manufacturers, not as between the British manufacturer and the Canadian manufacturer. In this he showed the protective sentiments of the government.

The imposition of a surtax of one-third, in-

tended to apply particularly to German goods, will doubtless meet with the approval of Canadians. Germany has long discriminated against Canada, and all effort to induce a discontinuance of the policy have been futile. The result of the surtax will doubtless be to decrease our imports and exports from and to that country, but in this we have everything to gain and little to lose. Canada annually buys from Germany goods of an approximate value of ten million dollars, whereas our exports to that country do not exceed one million dollars in value. Nevertheless, we are told of further retaliatory measures to be adopted by Germany.

It is pertinent to enquire who is likely to be benefitted most by this surtax on goods imported from countries which discriminate unduly against Canada. The surtax is not thought to be applicable to the United States, which, in respect to geographical position and physical equipment, is favorably situated to realize any benefit that may accrue therefrom. The United States press take the view that the new tariff gives that country a distinct advantage over Germany of 33 1/3 per cent. in the Canadian market. This, however, will surely depend upon the attitude assumed in future towards Canada, as a policy of inequality will doubtless result in the application to United States imports of the same retaliatory measure which now applies to German goods.

Canada is desirous of cultivating trade with the United States, on a mutually profitable basis, but the Minister of Finance makes it plain that we will not chase after reciprocity. He is agreeable to a resumption of the Joint High Commission, but if after a preliminary friendly conference it should appear that the American representatives had no reasonable propositions to make, negotiations would be concluded at once.

## EDITORIAL NOTES.

The placing of a contract for timber required by the Ontario Power Company for flume purposes at Niagara Falls has created some comment. The contract, which embraces several million feet, has fallen to redwood manufacturers of California, who, it may be presumed, were the lowest tenderers. To assist in securing the order, the Southern Pacific and Santa Fe Railways offered a through rate of 50 cents per 100 pounds of green redwood weighing 3 1/2 pounds to the foot, or an average of \$16.66 2/3 a thousand feet. This rate is regarded as a very important event in the redwood world.

Perhaps never before in the history of the lumber trade have freight rates to Great Britain been so low. The rail rate on lumber from the Georgian Bay to St. John, N.B., is about 12 cents per hundred pounds, and from St. John to Liverpool 14 cents, making a through rate of less than nine dollars per thousand feet. The rate from Georgian Bay to the Eastern States is between five and six dollars per thousand, or only three dollars less than to Great Britain. Yet the United States is getting the lumber, which is explained by the indisposition of buyers across the water to pay the advanced prices resulting from increased cost of production.

## LOGGING METHODS IN BRITISH COLUMBIA.

BY HENRY H. NEWELL.

The logging industry of British Columbia is as yet in its infancy, and a very precocious infancy at that. The improvement of logging methods has more than kept pace with the general progress of the country. Enormous areas of timber limits lying within easy reach of salt water or large rivers have been eagerly sought and secured, and work upon them has proceeded with none of the speculativeness, and with fewer of the natural hindrances that have been experienced in the mining industry. The development of agriculture, too, has been beset with many natural drawbacks which have somewhat checked its advance in this age of competition; but logging has triumphed all along the line. To-day the logging and lumbering industries in British Columbia dispute with the salmon canning industry the palm of progress in the most modern methods and most effective results. It is not many years ago since the logger went out into the woods equipped with little more than axes, ropes, and teams. Now he creates a veritable industrial vortex as he pushes on strenuously with his railways and all-important donkey engines, and moves forward his bustling and cheery camps through the hitherto trafficless forests.

In British Columbia the forests are dense and in places almost impenetrable, and the impediments to the transport of provisions, of machinery, and finally of timber, are characteristically great, in spite of the country's many invaluable waterways. The finest timber rarely grows quite down to sea water. The packer and the pack-horse had their work cut out for them in the early days. Later the light wooden railway with horse or human traction considerably assisted the labors of the pioneer; but now, the iron rail is laid length by length from the sea beach, reaching slowly but surely into the furthest depths of the forest primeval. The all-prevailing difficulty of transport in British Columbia has, in the matter of logging, been practically overcome for coast and inland timber limits, and for those situated on rivers of sufficient size to float down the logs to the sea; but an important question facing timber men to-day is the utilization of the enormous and magnificent areas of valuable timber which are spread throughout British Columbia's uplands and inland valleys.

Logging methods on the mainland coast and islands necessarily vary to some extent from those up country—in the Kootenays for instance—but the great bulk of the logging in the province is done on the mainland coast and on Vancouver Island. The Victoria Lumber and Manufacturing Company's logging camps on Vancouver Island may be taken as in every way representative of the most efficient and modern methods of logging conducted in British Columbia to-day. The company's mill at Chemainus—the largest in the province—is capable of turning out, in the ordinary way, 320,000 feet of lumber per day. The timber used does not all come from their own camps—some 10,000,000 feet of timber is annually supplied to them by the neighboring Cowichan Lumber Company—but these camps are amongst the largest in the country, and the principles which govern their logging methods are those of the most up-to-date logging camps in the province. The mode of forming and conducting their logging camps is roughly this: having first caught their hare, that is, acquired their timber limit (and they own some 125,000 acres in the Esquimalt and Nanaimo Railway belt), the next thing to do is to survey it and build a railway, to form a camp and lay out their yarders, or landing stations, and then to send the fallers in.

Railway construction through the marketable timber extends about half a mile at a time. The railway to the Victoria Lumber Company's operations is now seven miles to the first camp, and three miles further to the camp where the fallers are. The rails are heavy, of standard gauge, solidly laid, and the road is well ballasted. Spur lines from the main track cover the whole working field. On everything over a 4 per cent. grade geared locomotives are used. Engines geared  $2\frac{1}{2}$  to 1 operate on 14 per cent. grades, but it is not considered advisable to work on grades of more than 10 per cent, except for short pitches.

The camp is built as near as possible to the centre of the timber, the proximity of water being, of course, a governing feature. The camp site is chosen on either side of a small running stream, or else a channel of

water is conducted through it. The banks of this stream are planked, forming wooden sidewalks along which the bunk houses are built. The sleeping quarters are thus arranged on either side of a planked alley with a stream running down its centre for washing purposes. The bunk houses are built of matchwood, and are each separate with a wide space between. They are 12 feet x 14 feet in size, and each accommodates five men. The cook house, store, and dining room are combined in one building 24 x 80 feet. The wages of the men range from \$2.50 to \$4 a day, out of which they pay \$5 a week for their board. This costs the company 38 to 62 cents per man per diem. The food consists of soups, mush, fresh meat, vegetables, pies, etc., and indeed in this, and in most of the camps in the province, the board is equal to that of a good hotel. The company aim to have 60 men working continuously in camp, summer and winter. Health statistics of nearly all British Columbia logging camps are exceedingly favorable, and epidemics practically non-existent.

Having reached marketable timber the yarders are formed. The yarding station is the centre of operations. Here is erected the landing with a platform about  $3\frac{1}{2}$  ft. 6 in. high, the height of the log bunks, for facility in loading the logs on to them. Here is also placed the double drum donkey engine, securely made fast. Each yarder embraces an area of approximately 1200 feet. It is found that an area of 200 feet each way from the landing is the greatest that can be conveniently and economically worked by the donkey engines. The timber having been fallen is sawn into 20 to 110 feet lengths by the buckers, and, the swampers having cleared the ground around them, the logs are handled with the aid of miles of wire cable, and drawn to the landing where they are loaded on to the log bunks. The log bunks are so formed that they can be coupled nearer together or extended to suit the various lengths of timber. The skidways are usually laid about 1200 feet apart. Along them logs are drawn by cable to a double drum loading engine on the main track, this engine being equipped with 1 mile of 1 inch cable and two miles of  $\frac{3}{8}$  inch cable. On level ground a horse is used to draw the ungrappled end of the main cable from the loading engine back to the skid engine (which gathers the logs on to the skidway), but on hilly ground the second drum of the donkey with a  $\frac{3}{8}$  inch cable is used for this purpose—an endless cable being formed. For "trailing" over parts of the track which may be 100 steep for the cars the roadbed is planked with 2 inch planking and the rails protected by scantling, and a 25 ton "Chimax" geared engine is used for traction. Several heavy "turns of logs" are thus often drawn at one time to the loading station. A 40 ton Shay locomotive collects the loaded cars, and makes up the train generally, drawing it to the main loading station, where a powerful road locomotive takes charge and conveys the log train to the company's wharves at Chemainus, where the logs are dumped into the water and "boomed" ready for use in the mill. The cars are loaded five to seven thousand feet to the car.

A general crew for a yarder varies from 15 to 21 men, according to the nature of the ground and the season of the year. It comprises 2 fallers, 1 undercutter, 2 buckers, 2 swampers, 1 to 3 barkers, 1 to 3 snipers, 1 signal man, 1st and 2nd hook tenders, 1 rigging slinger, 1 dogger, engineer and fireman.

A road engine crew consists of 5 men, viz., engineer and fireman, 2 loaders, and 1 hook tender.

The question of the nationality of the woodsmen is an interesting one, but one almost impossible to determine accurately. Roughly speaking, about 10 per cent. are Swedes and Norwegians, a few British, and the remainder in about equal parts Canadian and American. This holds good throughout the province with the exception that in places near the boundary the American element predominates, whilst in others more remote Canadians are the more numerous. Native-born British Columbians have the best name as expert woodsmen.

The Shawnigan Lake Lumber Company, operating a smaller mill some 30 miles south, and also on the E. and N. Ry., has its own logging camp in the neighboring woods. This company, instead of a railroad to its logging operations, uses a pole road. The poles are cut in the wood on the spot and laid, half buried in the ground, in lengths the ends of which are cupped into

each other. If a sufficiently curved pole cannot be found in the woods it is curved during the process of laying down by means of a brace from a convenient stump, one end of it having been pinned into the preceding pole. The donkey engine then with a cable bends it to the required curve, when it is secured by pins and another opposite brace. Curves of as much as 33 degrees have been negotiated satisfactorily on this road, but the object is to keep as straight a track as possible. For bridging, poles are laid crosswise over one another in grooves until the desired elevation is reached and the uppermost poles then serve as the traction lines for the engine. The locomotive is a 17-ton geared "Chimax" with grooved wheels 13 inches wide, and having three inch flanges.

A road gang is here continually working just ahead of the fallers. The foreman goes ahead, and "blazes" the trees where he wants the road to go. If he wants it to the right of the tree he puts his blaze to the right, if to the left he blazes to the left, and if straight through then he makes his chip in the centre. The swampers come in, and after them the road gang lay the pole road keeping, as straight a track as possible. The methods of handling the logs are the same here as already described, though on a smaller scale.

Yet a third and older method of logging is that pursued by the Cowichan Lumber Company, who employ a contractor to do their logging for them. Their timber is at present being taken out mostly in proximity to Cowichan Lake, or near river banks, where the logs are fallen and collected during the year, and in the month of November, or thereabouts, are floated down the Cowichan and Koksilah rivers, which are then in flood, to salt water at Cowichan Bay, where they are boomed and towed round to the Chemainus mill. These limits can be efficiently and more economically operated by means of skidways and horse teams alone. Greased skidways are formed in convenient places upon which the logs are drawn down to the water. A tree having been fallen the swampers come and clear a track for it to the skidway. A team of eight horses is yoked on, and away goes the log. This method requires great judgement on the part of the logger, for the logs will only travel on their heaviest sides, and unless so drawn they will roll over and twist and tangle up the chain.

This method of logging again is yet an improvement on the more ancient system of drawing logs out of the forest with long unwieldy teams of oxen. The way had to be swamped out for them and serious obstacles removed at considerable labour and expense. It is instructive to compare this old-fashioned system with the operations of the wonderful modern donkey engine. It stands secure in its central location with its furlongs of cable stretching like long sinuous arms on either hand, and the heaviest and most ponderous log, once grasped, obeys its invincible pull, and smashes and tears its way through the thickest scrub at the guidance of the hook tender until at length it arrives with a dull thud on the landing ready to be loaded for the mill. Indeed, everything in modern logging depends on the "donkey." It needs to be treated like a new-born babe. If it refuses to work practically all work stops. The fallers are only required to keep a log ahead of the engine, and being ahead of their work they naturally take a rest and have a smoke. The buckers who have to follow them do the same and so on. Logging under such circumstances does not pay. It pays to get the best possible "donkey" and to treat it well.

By the last Government Reports no less than 4,125,100 acres of timber limits are already held under lease in the province of British Columbia (without including the enormous timber rights of the E. & N. Railway on Vancouver Island). During the year 1902 upwards of 187½ million feet of timber were cut from Crown lands, 50½ million from leaseholds, 7½ million from private property, and 30¼ million from the E. & N. Railway belt. Of the last named amount five-sixths was cut by the Victoria Lumber & Manufacturing Company.

Clarke Bros., of Bear River, N. S., have recently built a dry kiln and made other improvements to their mill. By the installation of planers, matchers, etc., they are in a position to supply spruce sheathing and hardwood flooring.

## A VISIT TO THE WISCONSIN LUMBER CAMPS.

(BY OUR TRAVELLING REPRESENTATIVE.)

As the leading producer of white pine of all the States, Wisconsin has some very large logging camps. Most of them are situated in the north-central part of the state and reached only by logging roads.

The Diamond Match Company's and the Williamson-Libbey camps are well known. In conversation with the leading operators they all said the past season had been exceptionally favorable and a successful one. There was plenty of snow, about eighteen inches and two feet on the level, and enough cold weather to make it stay.

Regardless of the fall of snow, Wisconsin loggers now use ice roads and sprinkler wagons to make them, depending only on cold weather for the success of the season, rather than on the fall of the snow. Too much snow, I found, is the only thing that loggers fear nowadays, but that condition did not prevail during my trip through the state. In fact, the weather was just right—cold enough to keep the roads hard, but not too cold to work. One evening just as the men were completing their day's work rain fell heavily and the snow went fast. Everybody thought the season was ended, but during the night it turned very cold, froze up, snowed and hardened the roads again.

Small-pox and grippe were very plentiful in the woods this year, but the former was of so mild a type that little attention was paid to it by the men. Several were laid up by small-pox for three or four days, and then would be at work again inside of a week. There seemed to be no fear of it and few of the men "stampeded." In one or two camps, I was told, all the men had it. The greatest precautions were being used to prevent the germs being taken out by the men when they returned home in the spring.

Men to work in the woods were so scarce in Wisconsin this past winter that it has been necessary for the loggers to pay the very highest wages prevailing in many years. The camps have also had to furnish a table that would do honor to many of the best hotels I stopped at. Even then it has been difficult to keep a full force, and there were few camps where the personnel of the employees had not materially changed since the opening of the cutting season.

Desperate measures were resorted to in order to keep the men from shifting from camp to camp. Chief of these was in the furnishing of superior food. One camp had brought in no less than two tons of mince-meat. Nearly all the camps that I visited had sent in immense quantities of canned peaches, apples, beans, corn, tomatoes, etc., whilst puddings, cakes and pies were of daily consumption.

If the men were poorly fed some of the "lumber-jacks" would tell a tale of how fine the boys were feeding at Camp 20 on the Ontonagon river, which would result in wholesale desertion to the best fed camp.

At some camps novel forms of amusement had been introduced in order to influence the men to remain. Music boxes and phonographs were installed at several, playing everything from "Ain't dat a Shame" to "In the Mansion of Aching Hearts." In one of the largest camps a piano had been furnished, together with a paid pianist and a vocalist.

Other companies supplied their camp with plenty of reading matter, both in daily papers and novels, of which the men have free use as soon as their day's work is completed and on Sundays. Very few men have quit the employ of the concerns giving them these inducements to remain.

I saw a lot of card-playing, dice-throwing, checkers, dominoes, etc., but very little gambling and practically no drunkenness.

There is something picturesque about these Wisconsin camps, situated perhaps on the side of a stream, half a dozen or so shacks with a larger "shake" roofed shanty, twenty by fifty, built of pine logs, cracks stuffed with moss and old leaves.

To the eye of an artist it is the ideal of the picturesque, the ends of the logs alternating across, showing their white and year-ringed sections against the dark bark—the low, broad entrance with its door on wooden hinges and latch. All this framed by the noble, taper-

ing stems and dark evergreen tops of the gallant old pines which seem to be standing there under sentence of death, awaiting the execution. To the ear as the storm whistles through the forest it seems like a vast orchestra of Eolian harps swept with music as wonderful as the varying wind.

Inside the shack it was comfortable and warm to the tired chopper. The atmosphere was one of a mixture of shoe-packs, sox and mitten steam, tobacco smoke and three or four foreign languages, through which could be seen long rows of "bunks" from the muddy floor to the top log under the rafters. The bunks would be filled with marsh hay, two coarse blankets and perhaps a tired form within them.

Let us inspect the cook's shanty. Rough, smoked logs, yellow light, rude table and benches, iron handled knives, tin cups and plates, a smell of cooking meat with an undertone of fried cakes.

To get to one of these modern camps it is not necessary to walk or take a team. We get on an empty logging train and we are landed at the loading place right in the camp. Here all is bustle and a strenuous life. All round are piles of logs, the sound of the keen axe ringing and re-echoing through the forest.

Then the loading begins—a rattling undoing of the binding chain, a scoot of skids on sway-bars, throwing of the loading chain, a number of dexterous cant-hook "flips," and the bunks are full. Another and another tier on top—then the "top loading" or putting a peak on the pyramid of logs. On the top of the growing load is a man of agile proportions, clad in a knit toque, red undershirt, grey pants and spiked "drive" boots. "Chain over!" he calls and they are ready for the binding logs on that chain. Two more up, and he calls "Up, the long skids!" Swamp hook in top log, loading chain around log on skids, under and back to swamp hook, tram of horses on the other end. All ready! "Gee up."—up the half pitch majestically rolls the big stick. The man on top, called the top loader, yells "Whoop!" and the horses dig their shoes in the ground and the log stops half way up. The top-loader sees to the log being straight, and is located, alert and cool, on top of the cone, waiting for that apex log, with a "cant-hook" that seems a living part of him. The "swamp-hook" is hooked to fly out when the upcoming log drops in its place. The top-loader never allows that swamp-hook to touch the ground till the last log is up. Now comes the nip. She breaks over upon the top! "Whoop!" The cant hook flips, and the car is loaded. I look at my watch as the top-loader looks a query at me. Time, nine minutes and twenty seconds.

As they shove this carload out of the way for another empty, I go up the track to a half-filled skidway of two parallel logs, six or eight feet apart, used to roll other logs on for storage. Here I saw the skidder and his big grey team. I note the dress of the "boss teamster"

a pair of rubber shoes, black German socks reaching to the knee, dark pants, somewhat pitchy, leather belt, sheepskin lined jacket, a black moustache and a Windsor cap. He is rolling the logs off his "toad" two iron shod runners six inches broad, three inches thick and six feet long, with a beam for the log to rest on across the middle.

Next I see the "swamper" in among the great masses of the tops of fallen trees. He is called a "swamper" because he is usually swamped in brush. The teamster calls him the "brush monkey." His work is to get the brush out of the skidder's way while he is being sworn at by the rough teamster.

Now, the two logs and toad lie parallel, chain around end of toad-beam, under one log, up and back to the evener on the other side, two horse-steps and the other end of the log lies on the beam even with the toad nose. These logs are too large to roll on with the swamper's cant hook. Again and again this operation is repeated. The swamper bites off a large moon of plug tobacco and extends the same to me. "No thanks!" He does not say it, but his eyes look it—"Tenderfoot!"

I follow the sound of a rapidly running cross-cut saw. The ground is gently undulating, smooth, and spread with a carpet of the yellow tresses from the giants around. There is a pair of sawyers—one carries an axe and wedge with wood filled socket, the other a ten foot pole and a handled band of steel, tough as a

Damascus sword blade. They look at a tree which to me seemed upright as the zenith, but the axeman chooses a leaning for it, and now the chips begin to fly from the notch, no very deep cut, just enough to guide the falling tree.

They hold the saw on the opposite side of the tree, and a jet of yellow dust marks every stroke of the singing steel. When cut two-thirds off a stiff breeze levers the top back, and the saw suddenly stops, "She pinches! Put in the wedge!" In it goes behind the saw under the blows of a four pound axe till the cut opens. "Zip, Zip," they keep right on till the great pine starts and staggers. "Timber—look out!" rings through the forest, the tree moves, cracks, the branch top hisses through the air, the sawyers have side stepped twice backward from the stump, a sound of rumbly thunder and shaking earth. One of the sawyers steps up and calculatingly pokes a measuring pole along the trunk, heretofore scaled only by the squirrel or woodpecker.

The dinner bell rings, a hundred or more keen appetites rush for the men's shanty to get ready for the meal. I follow and see clean trunks around the walls, and to my astonishment white sheets and pillows, shaded hanging lamps, newspaper covered tables. No dirty tramps allowed in these beds, shanty boys of the seventies and eighties you will not believe it. But ye hardy Carucks, 'tis true.

At the door of the cook-shanty, no swearing, bare-armed bull-dog cook, but an orderly family, real women cooks and girls to wait on as fine a table as any hotel for a hundred miles around.

What did they get? Well, to begin with, a good vegetable soup, pork pie, roast beef, pickles, sweet cake, apple pie, coffee or tea, with potatoes, canned tomatoes and string beans. This is varied every day, the "boss cook" tells me. In one of the camps only men cooks and "cookees" were employed. The latter are helpers, generally two for every cook, and the boys call them "bull-cooks."

After dinner the boys have a smoke, until the teams are brought out for watering. Clean and glossy are these horses, and the harness well oiled. The men scatter to their various posts.

In the camp I hear a sound like the squeak of a guinea hen—probably a little too sharp and steely. It is the "filer." With a saw set in a filing horse, breast high, and two or three other blades lying near, you see the man who sends to the sawyers a perfect, sharp saw. To "fit" a cross-cut requires years of practical use of the saw. He lightly planes the cutting teeth and cuts the "rakers" an eighth of an inch shorter than the cutting teeth for the purpose of pulling out the saw dust.

As the early winter twilight slips like a flowing curtain down the eastern sky, I imagine I will hear in dreams to-night the distant crash of the falling timber, see the swing of the steel blade and the rolling of the barkey log, while the beauty of earth before its devastation by man enwrapped it all. As I go into the camp again the savory smell of supper mingles with the life-giving aroma of the pine. After supper there is music, songs of all description, "ancient and modern," games going on, all seen through much tobacco smoke. Before nine the tired laborers are pulling off their socks at the bunk's edge as the lights flicker out.

What is the song of the plummy pine

When gather Night's dreamy shades,

And the tender eyes of the watch-stars shine

O'er his quiet, sleeping glades?

Whispering, whispering, "Sleep, calmly sleep!"

"Lullaby, lullaby," whispering deep.

On thro' dusk dreamland, a soft rippling stream

Bears the tired toiler wrapped in a dream.

In one of the camps I met a timber estimator, or what is known in Wisconsin as a "land-looker." Pretty much all the timber has been looked over dozens of times so that this calling has rapidly died out. This particular "land-looker" told me he had "packed it" on foot for days over miles and miles toward his "descriptions," without seeing a living thing, except wild animals in the forest or the birds. Keeping a sharp look-out he sees a little axe-mark on the side of a tree—probably made years before. Bringing out his compass he consults the portion of the "blazed tree," which tells him at once whether that tree stands on an

east and west or a north and south government survey line. He follows the blazed line, keeping an eye out for "witness" trees which mark a section corner or quarter post. Arriving at his description his duties consist in determining the amount and quality of the timber on the land, the facilities for logging, and the "shape of the surface," which he records in a book.

The land-looker said:—"I have tented for weeks in the Upper Peninsula of Michigan, Wisconsin and Minnesota, when the snow was five feet deep in the pine woods, and have had to dig down into the snow under my snowshoes to find the government blazes and scribe

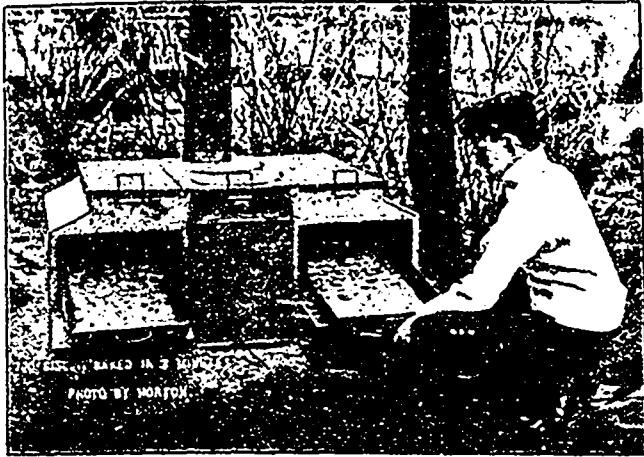

THE PATENT WISCONSIN CAMP STOVE MANUFACTURED BY WATSON BROTHERS, MARINETTE.

on witness trees, with a temperature at 40° below zero. He also stated that he had travelled for many miles on snow-shoes, the intense cold so contracting the strings that walking on them in the crisp snow produced a squeak like a harsh violin note. At that time their diet consisted of oatmeal, cornmeal, condensed milk and flour. From the latter they made a "dough-god" or "cold-shut." This with coffee and pork was considered good living.

He said, "I have been attacked by wolves, been pulled out from under the ice of a freezing lake, and had my blood chilled by the catamount's screech."

Some of the old cooks have been in Wisconsin since they started to "clean out" the forest. In conversation with many of them I found that they had some brilliant ideas. Among other things they knew of was the fact that fresh meat beginning to sour, will sweeten if placed out of doors in the air over night, and milk which has changed may be rendered fit for use by stirring in a little soda.

One of the foremen told me that the getting of good footwear was a prime necessity. Herold Bertsch Co. & Rindge, Kalmbach, Logie & Co., of Grand Rapids, had a good name in the Wisconsin camps.

One of the "cookees" said that kerosene will soften boots or shoes that have been hardened by water. I saw him put a teaspoonful of turpentine in a boilerful of white clothes. He said it was to whiten them. They say it does.

The cooks are all interested in a good camp stove or baker. The Patent Wisconsin Camp Stove made by Watson Brothers, Marinette, they say, is the most convenient stove ever seen in Wisconsin camps. It is adapted for the woods, on the drive or by the cruiser. It bakes as perfectly as the finest high priced range for from ten to one hundred men. I personally saw two of these stoves and they are marvels, inasmuch as they can be used out doors or in a tent, unaffected by rain or weather, baking perfectly. This stove is a portable one, because I folded and carried one myself to feel and know what a portable stove is like. These stoves are used exclusively by the Wisconsin River Boom Company, the Hamilton Merryman Company, and the largest operators in Wisconsin, because they claim they do the work of high priced stoves and ranges and do away with open fires which have caused so much destruction to the forests.

I enquired from the cooks and supply buyers as to the leading supply houses and whose product was liked the best. Next all of them mentioned Swift & Company, Omaha Packing Company and Schwarzschild &

Sulzberger, whose beef, pork, and other products were always first-class and well liked by the men.

There is not so much drinking now among the men after the camps break up as formerly, but hundreds of snares are laid for them when they come out with their hard earned money in the spring.

At Green Bay I saw this notice in one of the papers

"It will soon be time for the boys to come down from the woods now and Marinette booze dispensers are getting ready to give them the glad hand.

At Green Bay as well as other points I saw these and similar signs posted up conspicuously in saloons and liquor joints:

**"LUMBERMEN'S REST.**

"Eat and Sleep here FREE. "Hot Soup FREE all day." "Roast Pork and Mashed Potatoes on a plate FREE

With Every Drink.

"Free Meals all Day and all Night.

Come in Boys!"

These signs with alluring music get the boys in the dive. And the keepers of these dens are not philanthropists.

**LABOR SAVING DEVICES.**

We present herewith an illustration of the double mill with reverse top saw manufactured by the Knight Manufacturing Company, of Canton, Ohio. By combining those points which long experience have proven to produce the best results, this company claim to have in their new line of saw mills met all the requirements of a strictly up-to-date light portable or stationary mill.

The Knight Manufacturing Company's improved variable belt feed has all the valuable features contained in feeds of this class, together with those using the friction disc principle. They believe they have safely overcome all the objectionable features contained in various styles of feeds. All movements are controlled

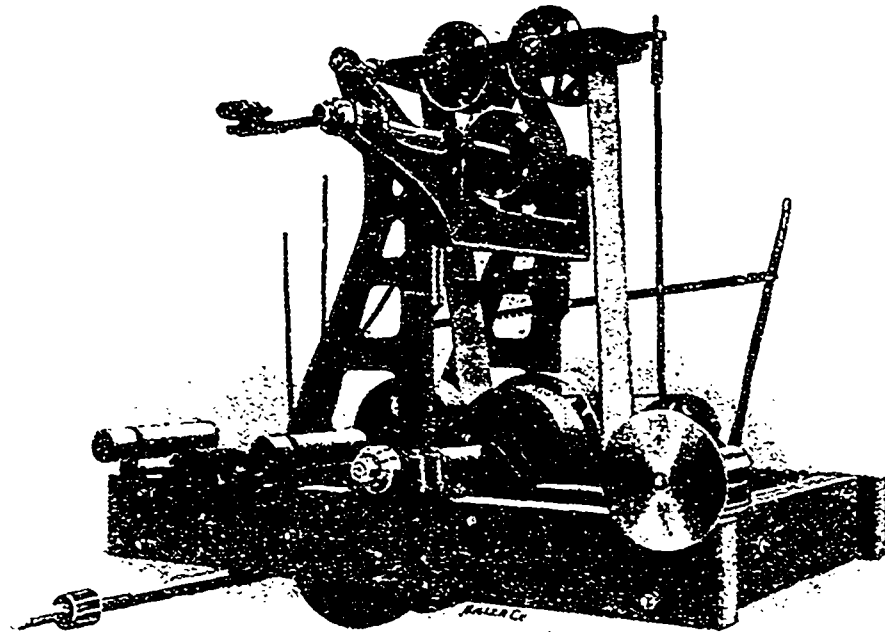

DOUBLE MILL HUSK MADE BY THE KNIGHT MANUFACTURING COMPANY, CANTON, OHIO.

by one lever and the feed and jig, thus always under perfect control of the sawyer.

Knight's steel head block and knee is made in two styles, single and double beam. The forged steel knee securely riveted to a steel base makes a rigid construction adapted to severe service, and the cut rack with cut steel pinion machined from solid metal secures absolute accuracy. The scale is attached to the top of the knee with which it travels, while the pointer remains stationary, permitting of easy reading from any part of the carriage. They also build this style block with a taper attachment, now considered a necessity in modern mills.

Knight's No. 2 single acting friction set works is designed for use on medium class mills and when desired can be furnished with sawyer's lever. The operation

is similar to all single acting set works, coil spring or friction receding devices are used, a brake wheel and lever are not required. The accuracy of nearly all set works depends largely upon their freedom from lost motion. This is especially apparent after the set works have become worn, as the wearing of every joint in them accelerates inaccuracy. They do not depend upon the travel of the lever to regulate the setting, but govern the distance the friction wheel revolves between positive stops for the thickness required. Therefore, any lost motion in the lever does not affect the accuracy of the set works.

Of special interest to all furniture, piano or interior finish men is Knight's Special Quarter Dog, designed for quarter sawing. It is not necessary to turn the quarter when the center is reached, thus saving the centre board, which is the widest and most valuable. The last board can be cut as narrow as one inch.

This company also make single and duplex dogs, swing cut-off saws, single saw side edgers, Dixie gang edgers, lath, picket and boiler machines, binders and trimmers, solid and inserted tooth saws, saw-mills, trucks, etc. All interested should get their beautiful new book of photographs, sent free upon request.

**POWER TRANSMISSION ECONOMICS.**

"Power Transmission Economics" is the name of a 20-page publication to be issued monthly by the Dodge Manufacturing Company of Toronto, and which will make its debut in a few days. This little publication is issued with the view of giving the latest information in regard to the economical distribution of power, and while a good part of its space each issue will be devoted to descriptive matter concerning special transmission machinery manufactured by this concern, space will be given each month to matters of special interest to the manager and head of any manufacturing concern. In the course of its publication, Power Transmission Economics will give a history of the origin and

perfection of the rope drive. The May issue contains the first chapter of this interesting story, and every man interested in power development will not find his time wasted by a perusal of this article. Power Transmission Economics will be sent gratis to anyone sufficiently interested to write for it, and a letter to the Dodge Mfg. Company of Toronto will bring this publication to your desk each month.

The Niagara Falls Power Company has contracted for 3,000,000 feet of California redwood, which is to be used for the construction of water conduits in place of steel. Experience shows that the sand and gravel which are carried in flood periods by the Niagara river rapidly scour and destroy steel, whereas the action of water on redwood is to form a surface of a soapy nature which protects the wood from destruction.

THE TRANSPORTATION OF SUPPLIES.

Since railroads have pushed out in every direction it was thought that the different lumber camps would be well supplied. This has not been actually the case, and there are still camps which have to get in immense quantities of provision for both man and beast, many situated a hundred or more miles from a railroad, which means a long and expensive haul. The waterways upon which the logs are floated naturally offered the best means of getting supplies to the camps.

Recently our lumbermen, especially in the West, have been turning their attention to the use of shallow draft river steamboats, not only for the purpose of bringing in supplies, but for bringing out the logs, as well as intercommunication between camps. In some cases rafts and supplies have to be towed up stream, and thus the small steamboat has come into existence. Many of these little boats will pay for themselves in a year or two.

The elements which enter into the construction of steam craft are more numerous when the boat is to be used for general business purposes on shallow, rapid rivers than is commonly understood. The machinery, equipment and power must be proportioned not only to the hull, the load which the boat is to handle, and the currents it must make, but also to the shallow water and swift currents.

The importance of having a substantial hull, coupled with the necessity for very light draft and yet liberal carrying capacity, presents advantages in favor of certain kinds of wood, rather than of sheet iron or steel, for small and medium size steamers plying on shallow

engines, boilers and auxiliaries, but in operating the complete steamboat, then by noting results and correcting the faults as they may appear from time to time, the most perfect and reliable work can be and is produced, if, mixed in with those qualities, there is an earnest desire to do the best they know how. This is exactly the situation in which the Marine Iron Works, Chicago, Ill., are placed, and within their range of sizes their line is one of the most complete and modern now existing for sending out these river craft either complete or in the "knock-down" shape.

With machine-shop, boiler-shop, pipe and fitting-up shops, as well as boat yard and offices, all together and under one supervision, absolutely reliable work is produced with despatch and on as economical a basis as it is possible to formulate. Their specialty is the designing and building of the entire and complete outfits of marine machinery for boat yards and others putting up their own hulls. Within the past eleven months they have made shipments to nearly every country in the world; the growth of their business being attributable largely to the completeness as well as high character of their product and the fact that even the minute details pertaining to each outfit receive due attention, a text of theirs being that "it is the correct combination of machinery and et-ceteras that goes a long way towards making the successful boat."

We present herewith an illustration of a stern paddle-wheel steamboat built and designed by the Marine Iron Works at Chicago, and specially adapted for lumber operations.

A FENCE FOR LUMBERMEN.

There has arisen a considerable demand for a wire fence by lumbermen, not only for fencing limits, reserves and piling grounds, but to enclose mill premises. One of the best fences especially adapted for

this purpose is the New Century fence, illustrated herewith, and made by the Ontario Wire Fencing Company, Limited, of Picton, Ontario.

A glance at the illustration herewith will show many points of advantage over most wire fences. Sagging is entirely overcome by the heavy horizontal wires. The great strength of the net weave is much increased by adding the heavy middle wires. The mesh wires act in

two ways, by tying the fabric together and adding their full strength to the horizontal wires. It is claimed that no square meshed fencing has this advantage, as the tie wires of the latter give no strength lengthwise to the fabric.

A visit to the immense works of this company by our

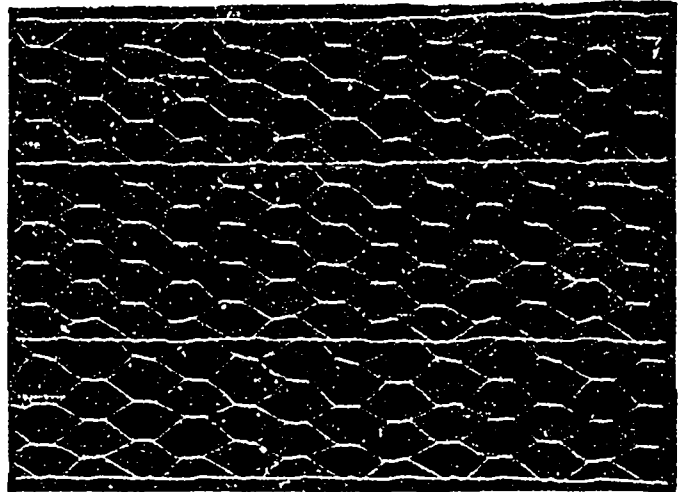

NEW CENTURY FENCE MANUFACTURED BY THE ONTARIO WIRE FENCING CO., LIMITED, PICTON, ONT.

representative revealed a busy scene, with the latest improved machinery in operation. The manager states that no other wire fencing having the same weight of wire per rod equals the New Century fence in strength. A very heavy maple tree blew over on one of these fences, and, although the fence had been erected over fifteen years ago, not a strand was broken. Lumbermen should get prices from this company.

FULP AND PAPER DIRECTORY.

Post's Paper Mill Directory for 1903 has been issued and is now for sale. It is published by Mr. L. D. Post, editor of the Paper Mill, 13-21 Park Row, New York City. It contains upwards of 600 pages and is perhaps the most complete directory of the kind ever issued. Besides a complete list of the paper, pulp and chemical fibre mills of the United States and Canada, it contains a comprehensive list of the mills in foreign countries as well as a complete list of the paper box manufacturers of the United States and Canada, claimed to be an entirely new feature. Officers of each mill, from the president to the secretary, are indexed as well as printed in another part of the book in connection with a detailed account of the mill. The price of the book is \$2. There are shown to be fifty pulp mills in operation and under construction in Canada. Of this number thirty-eight mills manufacture ground wood pulp, eight sulphite fibre and four soda fibre.

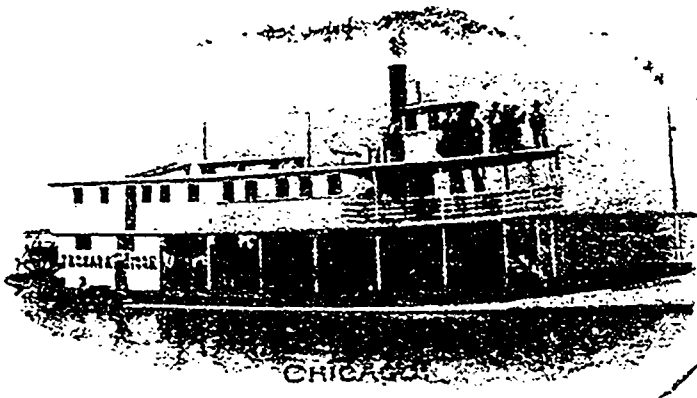

river, where sunken and invisible snags and rocks are a serious menace to light metal plates.

While a modern shop equipment and good location for building marine machinery is an important feature, it requires something else which is less easily purchased, viz., a thorough practical knowledge of the subject in all its details, that can only be gained through long experience not only in designing and building the

Dividend Check from Pennsylvania Lumbermen's Mutual Fire Insurance Co. dated Philadelphia, Pa., February 27th 1903. Pay to the order of Gillies Bros. Ltd. for Dividend on Policies No. 77, 125, 137, 147. Amount: Fifty-seven and 100 Dollars. Signed by Richard Joseph, Treasurer, and First Vice President.

THIS IS THE WAY WE SAVE MONEY FOR LUMBERMEN. THERE ARE OTHERS—WRITE US.



# T E A S



Our CAMP and COYOTE blends are "winners." Bulk, 3 and 5 lb. tins. Pleased to send samples. . . . .

## LUCAS, STEELE & BRISTOL,

HAMILTON, ONT.

### TRADE NOTES.

Lequime & Company, of Smelter Lake, B. C., are being supplied with saw mill machinery by the Waterous Company, of Brantford.

The Hanchett Swage Works, Big Rapids, Mich., manufacturers of the Hanchett swage, have been running nights for over two months in order to keep up with their orders.

A neat catalogue issued by the Robb Engineering Company, of Amherst, N. S., describes and illustrates the Robb-Armstrong engine and shows views of some of the power plants installed by that company.

The E. C. Atkins Saw Co. have removed their Canadian office and showroom to No. 30 Front Street East, Toronto, where Mr. H. P. Hubbard, the Canadian manager, will be pleased to receive a call from readers of THE LUMBERMAN.

The new band saw and engine recently installed by the Bryan Manufacturing Company, of Collingwood, Ont., was supplied by the Waterous Company, of Brantford. This firm also furnished the complete equipment for the saw mill which Senator McLaren is building in Alberta.

The Waterous Company, of Brantford, Ont., are supplying the complete saw mill and planing mill machinery equipment for the new mill of the Crow's Nest Pass Lumber Company at Wardner, B. C. They are also supplying considerable machinery for Uqhahart Bros' mill at Vancouver.

The Sovereign Oil Company have opened offices at 28 and 30 Wellington street west, Toronto, Mr. A. W. Brodie, manager. This company are doing an immense business in lubricating oils, paraffines, boiler compound, etc., and we wish to draw the attention of consumers to the company's advertisement in this issue.

The Fernie Manufacturing Company, of Fernie, B.C., have recently placed an order with J. L. Neilson & Company, of Winnipeg, for a full equipment of wood-

working machinery for the large sash and door factory which they are about to erect at Fernie. The factory when completed will be one of the largest in Canada.

A new company with enlarged capital has taken over the business of James W. Woods, manufacturer of lumbermen's supplies, Ottawa. The company will be known as "Woods, Limited", and is composed of James W. Woods and James Mather, of Ottawa, and John Carroll, Shirley Ogilvie and W. J. White, K. C., of Montreal.

The American Blower Co. is furnishing dry kilns for the Lansing (Mich.) Spoke Co., Severance Tank Works, Lansing, Mich., The Doane & Jones Lumber Co., Eldridge Park, N. Y., The Hazleton (Pa.) Mfg. Co., and the Garetson-Greaves Lumber Co., Fish, Mo. They are also very busy in all the other departments of their business.

Now that the Supreme Court of Maine has issued writs of injunction against a large number of companies and individuals engaged in the manufacture of lumber, forbidding them to discharge refuse into the Kennebec river and its branches, it is suggested that these parties utilize this refuse, which they have heretofore wasted, to run their mills, by putting in the Gordon hollow blast grate, manufactured only by the Gordon Hollow Blast Grate Company, of Greenville, Michigan.

The M. Garland Company, of Bay City, Mich., last

### The Lumberman's Diet

Clark's Corned Beef and Clark's Pork and Beans are the best produced in Canada and equal to the finest imported. Get quotations from your jobber.

W. CLARK, Manufacturer, MONTREAL

### P. PAYETTE & CO.

Manufacturers of Saw Mill and Engine Machinery, and all kinds of Marine Machinery.  
PENTAGON STREET, ONT.

month shipped a carload of stove and heading machinery to the Otter Creek Lumber Company, Otter Creek, Florida, consisting of a combination boiler and sawing machine, arranged with variable friction feed, and gang boiler for converting slabs and trimmings into staves and heading, a two saw stove equalizer for sawing staves to length, and a patent rotary head stove jointer. These three machines make a complete equipment for a first-class stove mill.

Save Time and Expense in Running Your Kilns by Using the

## STANDARD RECORDING THERMOMETER

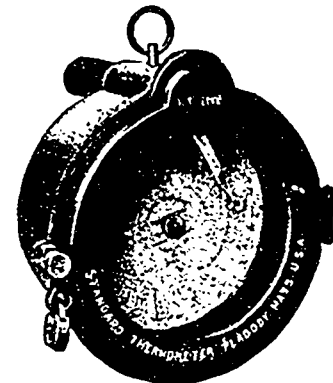

Used by the kiln manufacturers in their kilns they supply the trade.

Information and prices can be obtained from either

A. H. Andrews Co. Chicago, Ill.

Standard Dry Kiln Company, Indianapolis, Ind.

No. 30

OR THE MANUFACTURERS

HELIOS-UPTON COMPANY PEABODY, MASS.

AGENTS- McEachren Heating & Ventilating Co., Galt, Ont.

# LUMBER UNDERWRITERS

NOW OFFER LARGER LINES ON LUMBER YARD RISKS

Absolute protection is assured by reason of stock company reinsurance. Our policy goes to you for full amount, thus relieving you of the annoyance of taking care of many small policies.

\$1,000 to \$40,000 can be written on any unexposed or clear spaced stock of lumber.

For information as to concession in rates address our home office at

66 BROADWAY

NEW YORK



Sole Canadian Agents Waterous Brantford, Canada. Prices Reduced

## WE MAKE A SPECIALTY OF SMALL STEAM POWERS

For every kind of service MILL, AGRICULTURAL and MARINE.

These engines are reliable and easily managed. Remarkably small and compact for the power developed. Light and portable. They will reverse instantly at any point. High-speed, noiseless, and non-vibrative. And they are above all economical engines.

We also devote ourselves to Small Steam Yacht Installations, using Fuel-Oil and Quick-Steaming Boilers, as well as to Direct Connected Lighting Units.

The SLEEPER ENGINE COMPANY, Limited Montreal.

Phone, East 2403.

Office and Works, Cor. Darling and Notre Dame Streets

### A WISCONSIN TRIP.

(By Our Travelling Representative.)

Crossing Lake Michigan I landed at Manitowac, a lumber shipping point. Considerable lumber is brought from the interior of Wisconsin by rail, the same cars being run onto the large lake ferry boats and landed at Ludington, from which point the cars are sent through without transshipment to Toledo, Ohio, and other points.

Two Rivers is still quite a lumber shipping point, and a regular fleet of lake schooners and barges have done a great deal of business in the carrying trade from this section.

Up at Green Bay I saw the effects of a decaying industry. This was formerly a great center of lumbering operations, but nothing of magnitude is to be looked for nowadays. It is said that the Diamond Match Company got out over forty million feet of timber from the Ontonagon river this last winter. The logs were loaded on cars and hauled to Green Bay, where they are being sawed. This company stationed engines along its logging roads and a cable is used to assist the horses up the inclines with the big loads.

A new logging railroad is to be built across Marinette county. It is to be constructed by the Bird & Wells Lumber Company, who own considerable timber in that region. The road will be from 15 to 30 miles long, opening up a quantity of standing timber and making it tributary to Wausaukee and Marinette. The line will run from Athelstane to the Forest County line.

Logging operations at Girard Junction are to be continued through the summer. This will finish up the pine and cedar in that locality. At one of the mills in Green Bay steam was raised as early as February 27th in order to thaw out the ice in the log pond, to secure a place in which to float the logs. The ice was melted by steam passed through a small pipe which is let down just under the surface of the water and the heat melts the ice rapidly. In the past the pipe was laid under the ice.

At the logging camps at Armstrong Creek, over ten million feet of logs were in the water before March 1st. The latter part of February the sun was so strong as to spoil some of the roads, but next season a logging road will be built to get out the timber.

The Diamond Match Company received over forty cars of logs per day in February and started up their plant on March 9th.

At Marinette I found the lumbermen anxiously awaiting the result of the season's cut. The N. Ludington Company are very prominent dealers and do a large trade. I learned that portable sawmills were going through the cut-over lands of Wisconsin cutting down everything and anything marketable.

Watson Bros., of Marinette, are preparing to go largely into the manufacture of lumber camp stoves. They have one of the best in existence and should find a great demand for it.

At Appleton I found the Miller Lumber Company and

the Geo. Jones Lumber Company doing the principal business in this section. Both at this point and at Kaukauna the pulp and paper-mill men told me that never before had there been such a shortage of pulpwood since they commenced the manufacture of paper from wood. They asked me if they could get a supply of pulpwood from Ontario, and I answered that we should be pleased to do more—we would send them the pulp, but not the wood.

The Pulpwood Supply Company, which was under contract to furnish the mills of the Fox River Valley with 175,000 cords of pulpwood, had difficulty in getting the usual amount this year.

Oshkosh has always been noted as a great sash, door and blind center. The general opinion was that the end of the white pine was near, and white pine meant life or death to the sash and door trade. This opinion was not generally shared by all, as some seemed to think the white pine could be easily replaced by yellow pine, hemlock, etc. The larger concerns felt that as long as there was white pine in the north they must have it or run a losing trade with the northern concerns. At Oshkosh they are now turning out a pine veneered door which would be counted a novelty in some parts of Canada. Even to my own mind the very word "veneer" seems to mean a valuable wood. Pine is valuable in Oshkosh—\$65 being a very low price per thousand for the best stock. The door factories now take the cheaper grades, pine culls and hemlock, and veneer it with clear pine, making a No. 1 door, having special machinery for doing this work. Speaking to a leading manufacturer about this, he said laughingly: "Yes, we are using a pine veneer to-day—tomorrow we will stuff them with sawdust!" Another Oshkosh lumberman said to me: "Send over your Canadian travellers to sell us lumber." The same conditions exist in the whole of Wisconsin as in Northern Michigan. Five years or less will see the end of the white pine industry, and Minnesota is rapidly going the same way.

While in the northern part of the state I went right into a lumber section where gripe was raging. As a result I took away a severe attack of gripe as a souvenir. The camps on account of the epidemic were short-handed.

At Oshkosh is situated the E. B. Hayes Machinery Company, manufacturers of wood-working machinery. Dowel, door, sash, blind and furniture machinery is their speciality. They pay special attention to the export trade. This company is now pushing out for the world's trade.

The E. B. Hayes Company manufacture machinery

for all sizes of plants, including double end tenoning machines of several styles. They also make power door clamps, double door stickers and sash machinery. The machine we illustrate is called a Standard New Geared Double End Tenoner. The new feature of this machine is in the "cope arbors," which are driven by means of gears in place of belts. The old style of machine required six belts on this part of the machine, of which this company claim to be the originators. All mechanics in the wood-working line will see that this new way of applying power to the "cope arbors" on the machine is a new feature and a great step in advance along the line of improvements.

Among those I had the pleasure of seeing in Oshkosh



SINGLE EXHAUSTER MANUFACTURED BY WM. BAYLEY & SONS CO., MILWAUKEE, WIS.

were the following: R. McMillen Company, Williamson & Libbey, The Morgan Company, G. Streich & Company, A. Streich & Bro., Gould Mfg. Company, and W. J. Campbell. These concerns number among them the largest in the city. Mr. Dis. W. Denham gave me considerable information respecting the city's progress.

The Star Foundry & Machine Works, of which Mr. J. A. Barnes is the proprietor, manufacture the Climax double tenoner, which class of machine has become in the last few years a necessity because of the large amount of work that can be accomplished with accuracy, as well as other labor-saving qualities.

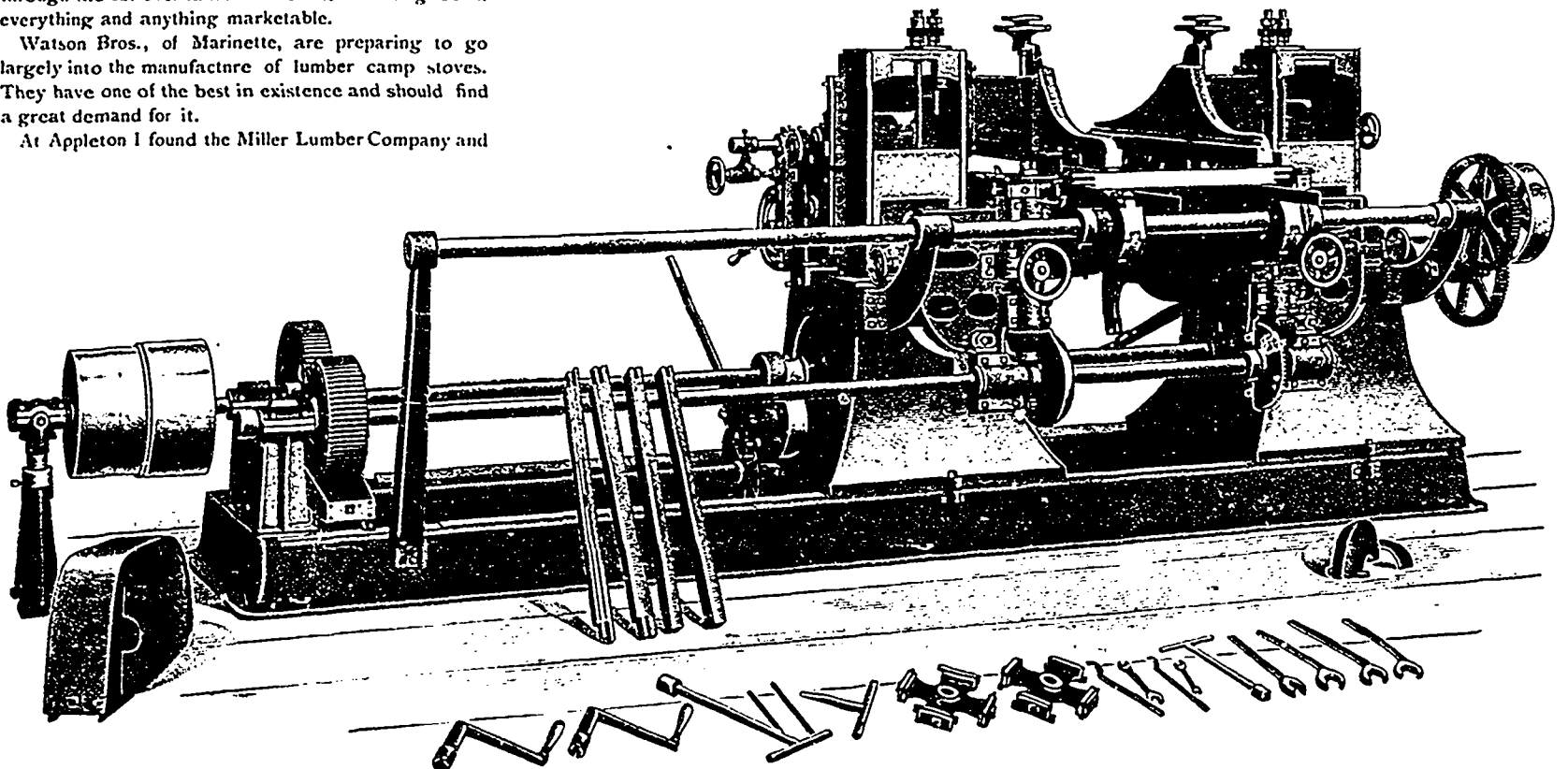

STANDARD NEW GEARED DOUBLE END TENONER MANUFACTURED BY E. B. HAYES MACHINE COMPANY, OSHKOSH, WIS.

In this city there are some wood-working industries, such as the manufacture of heavy lumber wagons, sleighs, logging trucks, etc., for which there is a constantly increasing demand in Canada.

At Fond du Lac there are several industries of considerable magnitude, including the O. C. Steenberg Company, manufacturers of sash, doors and blinds; Giddings & Lewis, saw mill machinery; and B. F. & H. A. Sweet, who make mill carts, lumber wagons, etc., on an extensive scale.

Milwaukee has always been and still is a great lum-

ber

es, shade rollers, hoe, fork rake, shovel and broom handles; also for polishing metal rods, gas pipe and tubing. The machine is thoroughly well built, very strong and substantial in every respect. All of the boxes, bearings and oil holes are so constructed and arranged as to perfectly exclude all sand or dust, thus insuring great durability for the machine. This machine will sand all sizes of stock from 1/4 inch to 2 1/2 inches diameter and any length. These sanders will sand stock at a speed of from forty to sixty running feet per minute. Two sand belts are used and are so

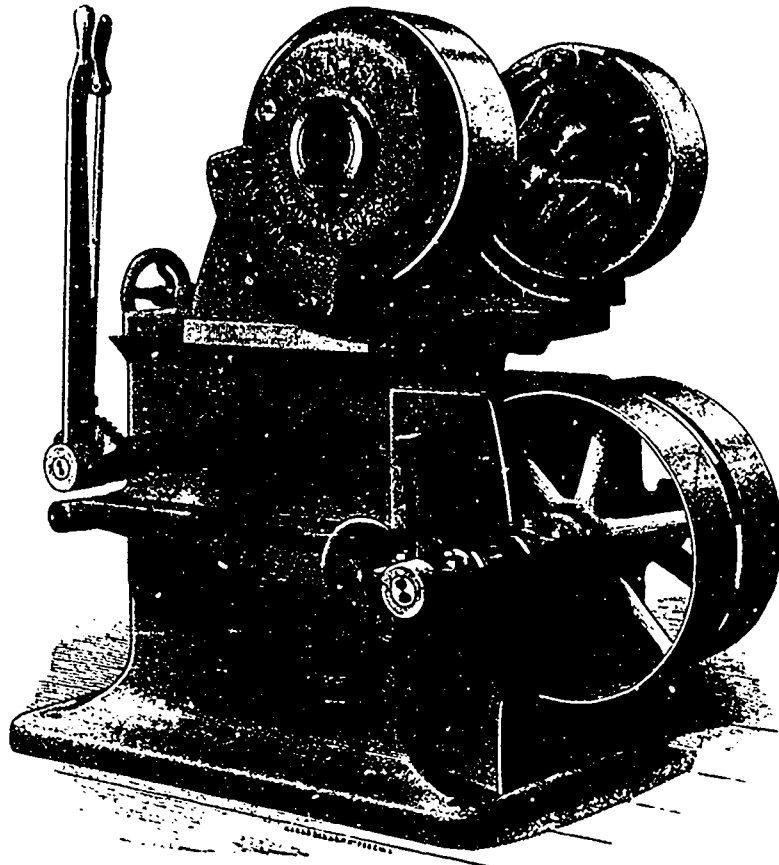

AUTOMATIC SANDER MACHINE MANUFACTURED BY J. M. NASH-SANDER CO., MILWAUKEE, WIS.

ber center. One of the largest concerns, the Quinnesec Lumber Company, whose advertisement will be seen in another column, are pushing out into Canada. Several more companies would like to get in Canadian lumber direct but are not exactly sure how to do it. They have only to consult our columns to see how others are successfully doing it—by the insertion of a card in the CANADA LUMBERMAN.

The middle west has a brilliant future and Milwaukee is pushing along phenomenally in manufacturing. It now takes rank as the second machinery center in the west. It has lately secured a new coke manufacturing plant which will cost \$400,000 and which will put the Chicago and Milwaukee manufacturing district ultimately more on a parity with Pittsburg. This industry will lead to new experimentation, development and mastery of the problem of the west manufacturing its own coke. Mark Hanna is interested in this plant.

Owing to the fact that 75 per cent. of all the iron ore used in the United States comes from the region north of Milwaukee, the Lake Superior district, it was said, decided to make the coke nearer the ore. All the motive machinery recently installed on the New York elevated roads was made in Milwaukee.

There are several firms making saw mill machinery and manufactures of interest to the lumber trade.

Prominent among these is the well-known firm of Wm. Bayley & Sons Company, whose extensive plant on Greenbush street is one of the city's busy hives. They also make the Progressive lumber kilns for drying all kinds of lumber, staves, heading, etc., as well as steel plate blowers and exhausters for removing dust and shavings from wood-working establishments.

Another large plant is that of the Nash Sander Company on Lake and Ferry streets. We have pleasure in showing an illustration in this issue of the automatic Nash sander. This machine is designed for and especially adapted to sanding or polishing all kinds of round work, such as chair stock, dowel rods, curtain

arranged that the one with fine sand follows the one with coarse sand, thus producing finely finished work once through the machine, though the work may have been very roughly turned. The sand belts can be put on or removed very quickly without removing or disconnecting any part of the machine. The pulleys that carry these belts are on the ends of the shafts overhanging the boxes.

These machines turn out in ten hours 15000 chair legs, 10,000 broom handles, 8,000 shovel handles or 2000 16-foot curtain poles.

Of special interest to planing mills and flooring manufacturers are the machines of the W. S. Sherman Company. They make an improved matcher and a face boring machine for boring jointed flooring, which are well and favorably known to all the leading flooring manufacturers. It makes jointed or factory flooring marketable without increasing the cost of labor. Jointed flooring is claimed to be the best for factory floors when it is bored, because nail heads may be set below the surface. Besides being an "order fetcher" the lower grades of flooring stock can be turned into jointed or factory flooring and made marketable by face boring. These machines are a necessity for the close competitor in the business.

Besides the Quinnesec Log & Lumber Company, the Curtis & Yale Company, M. Hilty Lumber Company, and Page & Landeck are leading firms. Hardwood flooring is a specialty with them. The Curtis & Yale Company are large manufacturers of sash, doors and blinds. The M. Hilty Company do quite a trade in lath, shingles and posts as well as all kinds of lumber.

In Madison I met the Frederickson Brothers, A. D. and J. V., both of whom gave me a hearty welcome to their large establishment. Besides being extensive pine, hemlock and hardwood manufacturers and dealers they are builders and contractors. The Miller-Parkinson Company are also doing a business of considerable magnitude.

A lumberman informed me that there was not as much pine standing in Wisconsin as was generally believed. He substantiated my knowledge that a large number of portable saw-mills were now going through the cut-over lands cutting down everything and anything.

A short run brought me to Beeton, near the Illinois border. Mr. L. O. Stordock is the principal lumber dealer here. I visited the R. J. Dowd works and found them rushed with business. They will in the near future do a large trade in Canada. The Berlin Machine Works is one of the largest wood-working machinery plants I have ever visited, employing nearly one thousand hands. Their trade and fame is rapidly extending to all parts of the world, whilst their Canadian trade is assuming great proportions.

After having gone through Wisconsin from north to south and zig-zagged across the state from east to west, I was astonished to find such a very small lot of pine, either standing timber or lumber. Most of the dealers are substituting "any old thing" for pine wherever possible.

In 1900 the lumber product of Wisconsin was valued at \$54,634,816, which was the largest of all the states. 1901 and 1902 saw great cuts made and that is the answer to any question of where the lumber went. The state is still the chief contributor to the country's supply of white pine.

According to information I gleaned at the state capital the amount invested in the lumber industries was as follows:

Logging plants.....	\$36,120,090
Saw-mill plants.....	8,640,420
Planing mills.....	1,527,602
Live capital.....	29,777,881
Timber camps.....	1,300,230

Total capital invested.....\$77,366,223

The following was the value of the products:

Saw mills.....	\$39,944,711
Planing mills.....	15,449,096
Timber camps.....	2,241,009

\$57,634,816

The number of persons engaged in the lumber industry in Wisconsin last year as proprietors, officials and wage earners was 33,107. The amount paid for wages in 1900 was nearly thirteen millions of dollars. This showed a decrease last year.

The officials reckon that there are ten thousand mil-

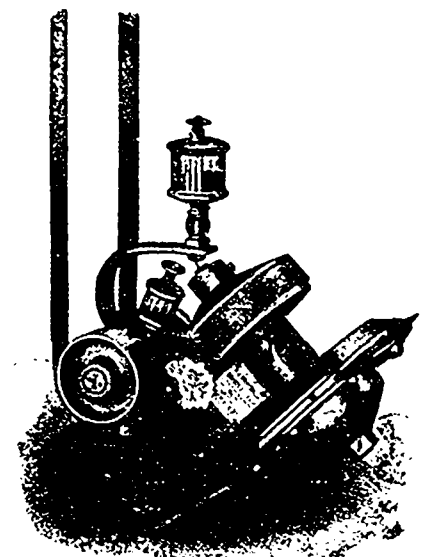

MATCHER AND FACE BOLTER MANUFACTURED BY W. S. SHERMAN CO., MILWAUKEE, WIS.

lions of feet (board measure) of timber in Wisconsin consisting of hemlock, spruce, poplar, white oak, the balance of the pine and other hardwoods. There is a large amount of hemlock in the state. 1890 was the high water mark, the value of the lumber in that year being nearly \$61,000,000. In 1900 it was three millions of dollars less and it is said this year will show at least a decrease of seven or eight millions despite the much higher market prices.

To show how rapidly the great pine forest has been slashed down, Wisconsin did not become prominent in lumbering until 1870. In 1880 it occupied third place in the industry, in 1892 it rose to second place, and in 1900 to first place.

Apparently no attempt whatever has been made in the line of natural reproduction, and as a consequence the pine of Wisconsin is nearly all gone—never to return.

J. R. H.



### ANNUAL MEETING OF THE WESTERN RETAIL LUMBERMEN'S ASSOCIATION.

The annual meeting of the Western Retail Lumbermen's Association was held in Winnipeg on Tuesday, March 31. The attendance of members was unusually large. The principal items of business taken up were the reports of officers, a revision of the constitution and by-laws, and elections.

The members in attendance at the meeting were as follows: Jas. McDole, Cypress River, Man.; F. H. Dagg, Holland, Man.; J. McCutcheon, Glenboro, Man.; A. Renuart, St. Pierre, Man.; A. R. Stevens, Elm Creek, Man.; David Ross, Whitemouth, Man.; A. L. Brown, Saskatoon, Saskatchewan; S. Ashfield, Winnipeg; Henry Stewart, Oak Lake, Man.; A. D. Sinclair, Winnipeg; A. B. McClelland, Winnipeg; Geo. Rogers, Lethbridge, Alberta; W. W. Ireland, Carberry, Man.; John Wake, Minnedosa, Man.; A. Lemay, St. Boniface, Man.; J. H. Hughes, Brandon, Man.; S. Q. O'Brien, Ponoka, Alberta; H. W. Hilliard, Minnedosa, Man.; Edwin Bray, Wolseley, Assa.; W. F. Ramsay, Killarney, Man.; H. H. Ross, Whitemouth, Man.; Jas. M. Hall, Vancouver, B.C.; F. H. Ringwood, Lenore, Man.; R. Law, Douglas, Man.; Peter Schwanz, Altona, Man.; D. J. McDonald, Fort Arthur, Ont.; Wm. Scott, Port Arthur, Ont.; H. M. Klassen, Altona, Man.; S. Milliard, Carroll, Man.; Jas. K. Robson, Treherne, Man.; J. L. Campbell, Melita, Man.; W. H. Duncan, Regina, Assa.; D. E. Fraser, Kenton, Man.; I. E. Gaudin, Napinka, Man.; I. D. Kennedy, Brandon, Man.; Robt. W. Gibson, Wolseley, Assa.; D. H. McDonald, Fort Qu'Appelle, Assa.; T. R. Case, Winnipeg; James A. Ovas, Winnipeg; A. H. Bailey, Winnipeg; G. B. Housser, Portage la Prairie; Wm. Robertson, Rat Portage, Ont.; W. A. Morkhill, Dominion City, Man.; A. A. Ballard, Morris, Man.; S. Caswell, Rathwell, Man.; H. Byrnes, Winnipeg; T. L. Arnett, Souris, Man.; W. T. Storey, Wawanesa, Man.; A. W. Sherwood, Indian Head, Assa.; Alex. Black, Winnipeg; J. C. Graham, Winnipeg; J. Hanbury, Brandon, Man.; G. Silvester, Elkhorn, Man.; Alf. Hill, Underhill, Man.; W. H. Harrison, Neepawa, Man.; Geo. Aulsebrook, Winnipeg; A. Brown, Winnipeg; W. Cowan, Prince Albert, Sask.; Mr. Robinson, Cranbrook, B. C.; Wm. Ansley, Rouleau, Assa.; J. A. Badgeley, Emerson, Man.; D. E. Sprague, Winnipeg; J. E. Parrot, Saltscoats, Assa.

#### PRESIDENT'S ADDRESS.

President J. L. Campbell called the meeting to order and after a few words of welcome to the members proceeded to deliver his annual address, which was as follows:

To Members of the Western Retail Lumbermen's Association:

Gentlemen,—It is proper that I should explain to you why you are called together at this time instead of in February, as has been the custom heretofore. It has been found that for some years past during bonspiel week there were so many counter attractions that the many important affairs of the association were almost neglected. Many subjects were pass-

ed over entirely, and those brought up were only partially discussed, and no satisfactory conclusion arrived at. In fact the usefulness of the association was stifled, and so little of benefit was accomplished that we might almost as well have had no annual meetings. In view of this, your directors have thought it wise to hold this annual meeting at a time when those in attendance could give their undivided attention to the matters presented. You will be asked to give advice as to the continuance of this practice.

Owing to the rapid strides of your association and its extended sphere of usefulness, your directors have considered that the by-laws formulated ten years ago were unsuited to later conditions. As a matter of fact, the workings of the association in practice have been getting far away from the lines laid down in these by-laws. For some time past, the feeling has been growing with your directors that the by-laws should be so modified as to make them more compatible with the actual workings of the association. The by-laws, as amended, will be presented for your consideration and adoption, with the hope that they may be found to express more clearly the objects of the association, and the spirit of the intention.

Like other kindred organizations, it has been thought an opportune time to introduce a scheme of fire insurance applicable only to members engaged in the retail lumber business. Your secretary has obtained valuable information on the subject, through the courtesy of Mr. Hollis, secretary of the Northwestern Lumbermen's Association, which gives us useful data, and much encouragement in presenting for your consideration a plan of fire insurance for our members. When this scheme is laid before you in detail, I am sure it will receive your thoughtful attention.

In order to enlarge the usefulness of our association and to give added interest to its members, it is proposed to establish an information bureau, for the purpose of collecting and disseminating items of general and useful information, for the benefit of our members. This will be done by bulletins sent out at regular intervals. I trust each member will consider it incumbent upon himself to forward to the proper officer any interesting items touching upon the lumber business, or the affairs of the association. In short it is hoped that all will lend their co-operation to make this feature of our association attractive and useful.

It is with the greatest pleasure I testify to the indefatigable and efficient services of the secretary, to whose zeal, more than that of any other person, is due the great success attained by our association in the past.

In conclusion, I wish particularly to draw attention to the great kindness I have experienced at the hands of the individual members in general, making special mention of those of your board of directors. With them the labor incident to the conduct of your affairs has been made a pleasure rather than a task.

The Secretary, Mr. Isaac Cockburn, then presented his annual report. The receipts for the year and cash on hand at time of last report were shown to be \$8,713.28, and the disbursements \$3,045.04, leaving a cash balance

of \$5,668.24. The report concluded as follows:

Our membership with yards on the 31st December, 1902, was 343, as against 244 the year previous, being an increase of 99 active members, and that of our honorary members was 63 as against 37 in the year 1901, being an increase of 26 in number.

When I state yard membership, I wish to distinguish that from membership which I have not included, and for which applications have been granted along the several lines of railway under construction, or about to be, and which will be listed as fast as the roads are opened, so that stocks may be put in.

In the matter of grievances it has been my purpose to bring about reconciliation of differences arising therefrom, and I am strongly of the opinion this is much the better course, than that of harshness. Harmony and friendship prevailing between all members is conducive to bringing about improved conditions of the association, and we are required to always bear in mind that you are simply an association of dealers to promote the betterment of the trade by uplifting each other, and not the thought of the possibility of the dollars that are in it for you, individually. Consequently, it behoves you to give the utmost consideration to each other and inculcate a kindly and friendly feeling in coming in contact one with another, and exercising well defined business ethics.

You will observe that our association has been extending until it has become worthy of the term often applied to this western country, that is, one of magnificent distances, bounded as it is on the east by Ontario, on the west by British Columbia, on the north by Prince Albert in the Saskatchewan district and Edmonton, and northeast in the Alberta district, and on the south by the confines of Montana and Dakota. I might say that while the district of Alberta is great, we are successfully operating it through an advisory board in that locality, and have received quite an impetus there, both north and south, since its organization.

As you know, we are confronted with a very general cry that we are an iniquitous combine, bringing about extortionate prices and unduly restraining the trade. This, of course, is not true, and it is passing strange that all this agitation has just now arisen after an existence of 12 years of the association. To my mind, the retail trade in lumber under this association has been conducted with remarkable fairness to the consumers. The prices over the wholesale cost have been moderate as compared with other mercantile lines of business.

#### ELECTION OF OFFICERS.

The election of officers resulted as follows: President, J. L. Campbell, of Melita, Man., re-elected by acclamation; Vice-president, A. M. Stewart, Morden, Man.; Secretary-Treasurer, Isaac Cockburn, Winnipeg; Directors—D. E. Sprague, Winnipeg; G. E. Davidson, Manitou, Man.; J. K. Robson, Treherne, Man.; W. H. Duncan, Regina, Assa.; W. W. Ireland, Carberry, Man.; J. E. Parrot, Saltscoats, Assa.

A large saw mill in Port Blakeley, Washington, owned by Capt. William Renton and his nephews, John and James Campbell, natives of Pictou, Nova Scotia, has just been sold for \$3,000,000.

## THE NEWS

—J. Conklin is building a planing mill at Kingsville, Ont.

—C. W. Milestone has opened a lumber yard at Moose Jaw, N. W. T.

—The Gilmour Company are making improvements to their woodworking factory at Trenton, Ont.

—The Joanisse planing mill at Buckingham, Que., has passed into the hands of the Parker Company.

—The Sherlock-Manning Company, of London, Ont., purpose building a new kiln for drying lumber for their organ factory.

—A boiler in Angus McKinnon's saw mill at Coleman, P. E. I., exploded recently, killing one man and injuring two others.

—J. D. McArthur has assumed the active management of his lumber business at Winnipeg, Mr. J. M. Chisholm having resigned.

—Joseph Chew, late of Midland, Ont., is installing the machinery in his new shingle mill on False Creek at Vancouver, B. C.

—The Tobique Manufacturing Company have installed a new rotary gang and a resaw in their large mill at Plaster Rock, N. B.

—The Prairie Lumber Company, of Winnipeg, are opening a lumber yard at High Bluff, Man., with Harry Brown as manager.

—W. C. Archibald, of Wolfville, N. S., purposes planting 12,000 trees at Earncliffe, the farm purchased by him last year at Greenwich.

—The Chilliwack Shingle Manufacturing Company are refitting their shingle mill at Chilliwack, B. C., and expect to resume operations at an early date.

—It is understood that John Hanbury, of Brandon, Man., intends building a large mill in British Columbia, where he recently purchased extensive timber limits.

—The Taplin-Anderson Company, Limited, has been incorporated at Novar, Ont., with a capital stock of \$75,000. It is proposed to operate two saw mills in the vicinity of Novar.

—The Georgian Bay Shook Mills, Midland, Ont., have considerably enlarged their plant by the erection of a new dry kiln and installation of planers and other improved machinery.

—The Canada Wood & Coal Company, Limited, is a new corporation at Winnipeg. The powers of the charter include the handling of timber limits and operation of saw mills. The capital is \$20,000.

—The Michigan Land & Lumber Company are reported to have sold their large saw mill at Blind River, Ont., to McEwen & Dolson, of Bay City, Mich., who will probably make improvements to the mill.

—B. J. Gilligan will build a saw mill at Mattawa, Ont., provided he is given a bonus. T. J. Harwood is willing to build a shingle mill at that place if his annual assessment is fixed at \$500 for a period of ten years.

—W. F. Hunting, of Chicago, is reported to have purchased a site at Vancouver, B. C., on which to erect a large saw mill. Cruisers are now surveying timber lands which Mr. Hunting has in view for purchase.

—The Alberta Lumber Company has been organized at Vancouver, B. C. It is proposed to build a saw mill and shingle mill on False Creek. Dr. W. D. McKechnie is president of the company, and C. W. Ford vice-president.

—Thackray & Rawlins, who have been in the sash and door business at Pembroke, Ont., have dissolved partnership. George Rawlins will continue the business, while James Thackray will engage exclusively in the saw-mill business.

—The Soo Manufacturing Company are building a planing mill at Sault Ste. Marie, Ont. The ground floor will be used this season for matching and dressing lumber, but in the fall it is proposed to fit it up for a sash and door factory.

—J. B. Memramcook, C. B. McManus, of Newcastle, and others are seeking incorporation as the J. B. McManus Company, Limited, to carry on a general lumbering, mercantile, contracting and manufacturing business in the province of New Brunswick.

—Robert McNair has made application for water rights on the Coquitlam river. They are required for construction of a flume, Mr. McNair having purchased a large timber limit on Coquitlam lake and being about to erect a shingle mill at Westminster Junction.

—The Alex Black Lumber Company, Limited, has been formed in Winnipeg, to continue the retail lumber business heretofore carried on by Alex. Black. The company have taken over the retail business of the Rat Portage Lumber Company and will combine the two yards.

—Several British Columbia gentlemen have formed a syndicate to purchase a hardwood timber tract in Australia covering 50 square miles, for the purpose of manufacturing hardwood lumber and shipping it to America. J. W. Smith, of Australia, is the promoter of the enterprise.

—The British Columbia Mills, Timber & Trading Company, of Vancouver, B. C., are said to have been given an order for forty "knock-down" houses for the Northwest Territories. The houses are of eight different designs. This is believed to be an experiment so far as Western Canada is concerned.

—A despatch from Vancouver, B. C., says: V. Gaspard, representing Chicago lumber interests, has been in the city negotiating for the purchase of over one hundred thousand acres of timber. The principal members of the firm Mr. Gaspard represents are executors of the Whittie estate, millionaire lumbermen.

—The Imperial Elevator Company, a Minneapolis concern, have decided to enter the Canadian Northwest. Besides building a number of elevators, it is the intention to establish a number of lumber yards at different points throughout Manitoba and the Territories. The Canadian headquarters will be at Winnipeg.

There were eighty-eight special licenses to cut timber issued by the British Columbia Government during the month of March. This means that during that month the Government secured \$9,800 in revenue from special licenses. It is estimated that 1,000 licenses will have been issued by the close of the first half of this year.

The annual meeting of the St. John River Log-Driving Company was held at Fredericton, N. B., on April 1st. A. F. Randolph, of Fredericton, was re-elected president, and J. Fraser Gregory, of St. John, secretary-treasurer. The other directors are R. A. Estey, N. H. Murchie, Donald Fraser, jr., and John Kilburn, jr.

—Messrs. Jenkins, of Minneapolis, and David, of Blaine, Wash., who are interested in the Ross-McLaren saw mills at Barnet, B. C., have placed contracts for improvements to the mills, the intention being to resume operations at an early date. It is probable that about \$150,000 will be expended in improvements and repairs, including new dry kilns and an electric plant. It is stated to be the intention to engage in the export trade, shipping direct by water.

—The workmen employed at the mills of the Hawkesbury Lumber Company at Hawkesbury, Ont., recently went on strike as the result of the refusal of the company to grant increased wages and other concessions. The strikers interfered with the operation of the mills and it was considered advisable to close down. A few of the men were inclined to be riotous, but peace was soon restored by the authorities. Within a few days a settlement was reached, the men returning to work on April 15th under practically the conditions which previously existed.

—The Fredericton Boom Company have applied to the New Brunswick Government for authority to advance the prices charged for booming and rafting timber. It was proposed to increase the rate for rafting spruce and pine from 75 cents to 90 cents per thousand feet, and for rafting cedar from \$1.20 to \$1.40. Lumbermen objected to so great an increase, and as the result of a conference a compromise was reached. The new rate will be 85 cents for pine and spruce and \$1.30 for cedar. In future all logs scaling less than 50 feet will pay a minimum toll of 6 cents each, instead of being charged by the thousand feet. In advocating the increased tolls the Boom Company pointed out that the size of the logs coming down the river is gradually decreasing year by year, and that it is just as expensive to raft a small log as a large one.

From William Rider & Sons, Limited, London, England, publishers of the Timber Trades Journal, we have received two valuable books. One is a copy of the 1903 edition of their "List of Shipping Marks on Timber," which embraces what might be termed the trade mark of the leading shippers in all the timber exporting countries. It indicates great care in its compilation, and, bound in cloth, sells at \$1.50. The other book is designated "English Timber and Its Economical Conversion", and deals with the conversion and manufacture of timber in a manner which makes it of great value to the grower, the timber merchant and the manufacturer. It is claimed to be the first work of the kind. Chapters are devoted to "The Measurement of Round Timber", "Prices for Labour on Round Timber", "Method of Drying", etc.

# Emery Wheels, Corundum Wheels and Grinding Machinery



All our wheels are first-class in every respect. All special shapes supplied without extra charge.

Are you using our Improved Corundum Saw Grinding Wheels? We guarantee them to cut faster and cooler than any other wheels on the market. Will not burn saws and are just what your filer wants.

Send sample order to be supplied on approval.

**Canadian Corundum Wheel Co.**  
Hamilton, Canada

# WOOD PULP ~ DEPARTMENT

## NEW PROCESS FOR PRODUCING MECHANICAL WOOD PULP.

In their new pulp mill, just nearing completion at Fraserville, Quebec, the River du Loup Pulp Company, Limited, have installed a system of machinery which, if equal in efficiency to the claims made for it, will simply revolutionize the pulp manufacturing business.

The actual process of grinding is unchanged, the improvement being in the method used for sheeting the pulp for shipment. Every person familiar with pulp mill machinery is conversant with the faults of the ordinary wet machine used for sheeting pulp, the excessive cost for felts, rolls, repairs, etc., and the comparatively small capacity of each machine, compared with the floor space it occupies. In the "Hughes process," as used by the River du Loup Pulp Company, the wet machine is entirely dispensed with and its place, together with the place of the expensive hydraulic presses, is taken by the Hughes hydraulic pulp machine, which with a capacity equal to a 72 inch wet machine, only occupies a floor space of six feet wide by nine feet long, and besides, dispenses entirely with felts, rolls, gears, belts, and all the other clumsy and complicated machinery now in use. An idea of the saving in floor space gained by the use of these new machines can be formed from the fact that the press room of the River du Loup Pulp Company, with a daily capacity of forty tons dry weight per twenty-four hours is, only 50 feet x 50 feet, and not only that, but sufficient space is left so that additional machines can be added, bringing the capacity up to fifty-five or sixty tons dry weight.

The process is this: From the screens, the pulp passes over a simple form of "slush machine" which extracts the greater part of the water, and leaves the pulp of about the constituency of porridge. In this form it is pumped directly into the hydraulic pulp machines, which consist of a "compression chamber" divided into four spaces by drainer plates covered with wire cloth, attached to which is a hydraulic cylinder on which any desired pressure can be exerted. Pulp is admitted to this compression chamber and pressure applied, which extracts the water through the drainer plates, and delivers the finished product in the form of sheets, 20" x 26" and about 3/4" thick,

a very convenient form for baling. Almost any test desired can be obtained, the dryness of the pulp depending entirely on the length of time that the pulp is left in the compression chamber, together with the amount of pressure applied.

In this process, the fibres of the pulp are not formed into a sheet, as on the ordinary

than the ordinary equipment of a pulp mill, in that the heavy hydraulic presses, which are necessary for extracting the water under the old system of sheeting pulp, are entirely dispensed with. From these hydraulic pulp machines the sheets simply pass through a light baling press, to be made into bundles for shipment, or if for local consumption, the sheets can be shipped without bundling, thus dispensing with the baling press as well. The work being all done by hydraulic pressure no expensive equipment of counter-shafting, belts, etc., is necessary, and everything considered, a noticeable cost of production per dry ton is obtained.

For the accompanying illustration we are indebted to Mr. L. D. Post, of the Paper Mill, a New York trade journal. We are promised by Mr. K. L. Warren, constructing engineer



PULP MILL OF THE RIVER DU LOUP PULP COMPANY AT FRASERVILLE, QUE.

wet machine, and consequently are not matted or interlaced, but simply compressed and the water extracted, leaving the pulp porous and spongy, and consequently much easier to reduce to pulp again in the beating engines of a paper mill. At least 10 per cent. of power can be saved, and in most paper mills power is an important item.

Besides the saving in floor space in construction of the mill, and the saving in felt cost, the installation is also much less costly

of the mill above described, a set of photos of the interior of the press room, machines, etc., as soon as ready, which we hope to publish at an early date.

New paper and pulp mills are being rapidly brought to completion by the Canada Paper Company, of Windsor Mills, Que. The grinder room of the pulp mill is 50x158 feet, one storey, and will be equipped with ten grinders. The wood room is 49 feet wide and 82 feet long, one-storey and basement.

## Walkerville Logs and Lumber Sleighs and Wagons

ARE THE BEST

*Special Wagons Also Built to Order*

WRITE TO . . . .

**WALKERVILLE WAGON CO., WALKERVILLE, ONT.**

## J. J. TURNER & SONS

WHOLESALE MANUFACTURERS OF

### LUMBERMEN'S TENTS

AND ALL KINDS OF

### WATERPROOF GOODS NOSE BAGS

Our New Factory is the Largest and Best Equipped of its Kind in Canada.

Corner George, King  
and Water Streets.

**PETERBOROUGH, ONT., CANADA.**

Long Distance Telephone.

The James Smart Mfg. Co., Limited  
Brockville, Ont.

MANUFACTURERS OF

HIGH-GRADE  
CHOPPING **AXES**



BRANDS.

333 Gatineau, Crown,  
Beaver, Eagle, Forest  
King, Oak Leaf, Cana-  
dian, Hudson's Bay, Mon-  
treal, Quebec Wedge,  
Half Wedge, Beauce and  
Double Bix.

Also Woodsplitting Mauls and Wedges,  
Falling Wedges, Cedar Wedges,  
Hanging Wedges, Tomahawks,  
Brush Hooks, etc.

CATALOGUES AND ALL INFORMATION PROMPTLY FURNISHED.

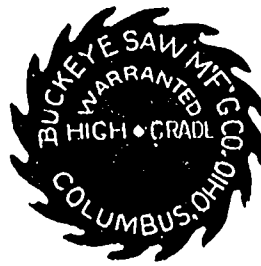

...BUCKEYE SAW M'FG. CO...

MANUFACTURERS OF

High-Grade Saws

Quick and careful work on Repairing.  
All kinds of Mill Supplies.

REYNOLDS BROS., Proprietors  
267 N. Water Street, COLUMBUS, OHIO.



You can get practically twelve good  
Axes to the dozen in buying . . . . **Dundas Axes**

DUNDAS AXE WORKS  
Dundas, Ont.

**CHAS. H. VOGEL**

A. M. Can. Soc. C. E.

47 and 48 Carleton Chambers,  
OTTAWA, CAN.

Long Distance Phone 1791.

MILL AND HYDRAULIC ENGINEER

**PULP MILLS AND WATER POWER**

ESTIMATES, PLANS, SUPERVISION AND CONTRACTS

SPECIALTIES.—Paper, Pulp and Sulphite Fibre Mills, Electric Plants,  
Surveys and Improvements of Water Power.



This illustrates the installation for the Sherbrooke Street  
Railway Company of a

**Crocker Patent Turbine**

Horizontally set under a head of nineteen feet. This  
wheel supplies the power for the electric railway system of  
the city

Our turbines are also used in a number of other plants in  
our own city of Sherbrooke, and we have supplied Crocker  
Patent Turbines to so many customers in different parts of  
the Dominion that we are usually able to refer prospective  
purchasers to installations in their immediate vicinity.

Our catalog, with tables, etc., will be immediately sent  
on request, free.

CORRESPONDENCE WELCOMED.

**The Jenckes Machine Company**

Head Office, 515 Lansdowne Street

SHERBROOKE, QUEBEC.

### WHERE TO BUY SUPPLIES.

There is no part of the lumbering business requiring so much care as the purchase of supplies for the camp or the drive. We have taken considerable care in compiling a carefully selected list of the leading reliable dealers on both sides of the boundary line who make a specialty of catering for this supply trade.

We can confidently recommend to the buyers the following list of well-known firms, and advise the buyers to preserve this list as a handy reference when requiring the very best goods at the lowest prices:—

#### GROCERY SUPPLIES.

Among Canada's leading wholesalers the well-known firm of H. P. Eckardt & Company, of Toronto, rank high. They make a special feature of the lumber camp supply business, and hold a large share of this trade. By studying the wants and needs of the lumbermen they have augmented this trade until at present it has assumed prodigious proportions.

Lucas, Steele & Bristol, Hamilton, are well and favorably known to most lumbermen, but despite this fact they believe in advertising. As a consequence they are doing a great share of the supply business. Many firms when approached on the immense lumber camp supply business say "Oh! we know all of them, and they all know us!"—meaning that the business is not worth much to them. But Lucas, Steele & Bristol cater to this branch of the trade and as a consequence are getting and will get new customers right along.

W. H. Gillard & Company, of Hamilton, make a specialty of everything in the line of grocery supplies, especially dried fruits, lard, beans, teas and coffees. They are a wide-awake, progressive firm, putting out first-class stock.

The Whitehead-Turner Company, of Quebec, is one of the largest firms in that province. They have a large trade with the lumbering interests, and many of the latter have dealt with them exclusively for years.

The Davidson & Hay, Limited, 36 Yenge street, Toronto, are wholesale grocers and importers, doing a considerable camp supply business. The company is well and favorably known by lumbering men.

Perkins, Ince & Company, Front street, Toronto, can interest buyers when quantity, quality, and prices are essential considerations. They are noted for the condition of their supplies.

T. Long & Bro. Company, Limited, Collingwood, have for many years done a great trade with the lumbermen, particularly around the Georgian Bay and Lake Huron districts. They push out for it and get it while other firms are waiting for the buyers to hear of their existence.

Some wholesale grocers imagine that their travellers should catch all the buyers of lumber camp supplies. How such a foolish notion can enter the head of a supposed "business" man is past comprehension. By sending out hundreds of letters and enquiries and by personal canvas of our own travellers, it is found that not ten per cent. of the lumber camp supply business can be reached by travellers, because the buyers are evanescent and are changed frequently, as well as for the additional reason that the camps are changed, new conditions arise and the buyer is often far away from the camp or his firm's headquarters when he buys his supplies.

#### MEATS, PROVISIONS, ETC.

In the travels of our representative throughout Canada, Michigan, Wisconsin, etc., he frequently met with complaints against the meat providers regarding the inferior quality sent into some of the camps. Talks with the buyers, the cooks, and even the men showed in some cases a harsh indictment against the disposers of rancid pork and embalmed beef.

We can vouch for the firms we list herewith as having not a single comment against them, in the above respect, and they are as well the largest in the various lines and spheres.

The attention of lumber camp outfitters is called to the advertisements in this issue. These representative

establishments thoroughly understand and appreciate the needs of the Canadian lumberman. They have made a careful study of the meats best adapted to those men who lead rigorous out-of-door lives and want hearty sustaining foods. In the selection of corn-fed hogs, the preparation of material and the final inspection, the greatest care is manifested at every stage to insure uniform fine quality and maintain the high standard of food product excellence.

The Wm. Davies Company, Limited, Toronto, are doing an immense business in the line of meats, etc. This company have the services of two noted experts, Drs. Smale and Addison. No harmful adulterations or rancid meats are allowed by the company to be put on the market. The Davies brand is noted for its excellence.

Swift & Company, Chicago, is a well-known establishment, and thoroughly appreciate the needs of the lumbermen. In addition to the main house at Chicago covering over 40 acres, they have large packing houses at Kansas City, Omaha, St. Louis, St. Joseph, St. Paul and Fort Worth. Not only are their facilities of the best, but the output is the best that can be produced. Five thousand Swift refrigerator cars quickly and safely transport the company's products to over two hundred and fifty branch houses.

Schwarzhild & Sulzberger Co., Chicago, New York and Kansas City, are large providers to the supply trade, particularly in beef and pork. They have a splendid reputation for fine products.

The Omaha Packing Company, Chicago, whose advertisement appears on another page, will be pleased to quote prices, etc., to all buyers, and guarantee satisfaction.

The Whyte Packing Company, Stratford, Ont., do a good business. Their product is of a superior grade and price as low as any.

Fowler's Canadian Pork Packing Company, Hamilton, are now going into the lumber camp supply business extensively. They have an immense plant at Hamilton and good shipping facilities.

Park, Blackwell & Company, Toronto, general providers, have for years done considerable trade with the larger lumber firms.

The Capstan Mfg. Company, Jarvis street, Toronto, are famed for their mince meats, etc. This company are alone in special lines which they provide for the camp and their product, we are informed, is highly appreciated by those who use it. They certainly have a fine clean way of putting up their goods.

W. Clark, Montreal, makes a specialty of pork and beans and canned corned beef.

#### WEARING APPAREL.

The Hudson Bay Knitting Company's two page advertisement in this issue should be consulted by all lumbermen. This company is one of the largest of its kind in the world. They carry an enormous stock and are able to fill quickly the largest orders.

The Herold-Bertsch Shoe Company, of Grand Rapids, Michigan, make a specialty of larrigans, swamping and cruising boots, etc. This firm is one of the wide-awake companies who are pushing out for the world's trade.

Rindge, Kalmback, Logie & Co., Grand Rapids, of whom we speak in another portion of this issue, do a great business in lumbermen's boots and shoes.

John Palmer, Fredericton, N. B., makes a specialty of foot-wear, etc. His advertisement should be consulted.

Wm. A. Holt, of St. Andrews, N. B., is one of the most reliable dealers in the maritime provinces. See his advertisement in this issue.

Attention is called to the announcement of Clayton & Sons given in this issue. This firm has a splendid reputation with the lumber trade.

J. J. Turner & Sons, of Peterboro, make waterproof clothing, etc. They have one of the largest manufacturing in this line in the Dominion. Considerable quantities of waterproof clothing are needed in the camps and there is nothing better than the make of this firm.

Woods Limited, Ottawa, make a specialty of overalls, top shirts, driving pants, underwear, shoes, hats, moccasins, etc.

#### MEDICAL SUPPLIES.

Immense quantities of medical supplies are used in the camps every season, both for man and beast. For many years Johnston & Company, of Collingwood, Ontario, have held the bulk of this vast trade, solely by reason of the superior quality of their liniments and remedies.

#### CAMP STOVES.

Considerable difficulty has been experienced by lumbermen in securing a stove suitable for the varied needs and hard usage to which such are subjected. In our columns will be found the very best that is produced, either in Canada or the United States, in this line.

Adam Hall, of Peterboro, is a pioneer in the matter of lumbermen's stoves. We will give a fuller description next month of their excellent makes.

The Gurney Foundry Company have for years been putting out a superior stove that has been pronounced as perfect.

We give in another column a description of the Wisconsin stove made by the Watson Bros., of Marinette, Wis. This portable stove will be seen in Canada for the first time this year.

#### GENERAL SUPPLIES.

In the matter of tents, waterproof horse and wagon covers, the J. J. Turner & Sons Company, of Peterboro, rank high. They also manufacture feed bags, coal bags and waterproof goods of every description. Lumbermen should send for their catalogue "A".

Morley Bros., Saginaw, Mich., are manufacturers and dealers in general supplies, including harness, etc. Woods Limited, Ottawa, also make tents and tarpaulins.

Attention is drawn to the advertisement of H. F. Falkner, Toronto, in this issue. His horse blankets, horse covers, sweat pads, collar pads, etc., are the finest in the market. He manufactures his own material and this enables him to secure the trade. He is also a dealer in curry combs, brushes etc.

In one of the camps a motto "What is Home Without a Mother?" was changed to "What is Camp Without Tobacco?" The American Tobacco Company have a great trade with the lumber camps and supply houses.

Of course the horse must be fed, and if you want to get the very best at the lowest quotations send to W. H. Dwyer & Company, Ltd., of Ottawa. They make a specialty of hay, oats etc.

The Dominion Molasses Company, of Halifax, N. S., can supply molasses that is molasses—pure, clean and the real genuine Barbadoes, such as the boys in the woods like.

For flour, pot barley, oatmeal etc., every lumberman should get quotations from Walter Thomson & Son, of London, Ontario, before placing a single order. Their product ranks as high as any in the world, and superior to many.

For the varied uses in the camp, such as marking clothing, blankets, etc., stamps are required. These can be furnished by the C. G. Young Company, corner Yonge and Adelaide streets, Toronto, who make rubber stamps of every description for all sorts of requirements, steel dies for marking or branding logs or lumber, and brass stencils for boxes, barrels, etc.

Many large lumbering firms complain of petty thefts and pilfering of their supplies every year. One company place their loss at many hundreds of dollars each year, whilst another said they calculated on a loss of ten per cent. It is not necessary for these losses if very care at all is given to the supplies. Noble's Dominion Detective Agency, of Toronto, supply men to go with the supplies or to go into the camps and prevent these enormous losses at very small cost. This agency is the very best of its kind and we can confidently recommend them to all lumbermen requiring faithful and efficient service in preventing the loss of supplies.

## NEW CENTURY FENCE

The Strongest Fence Made

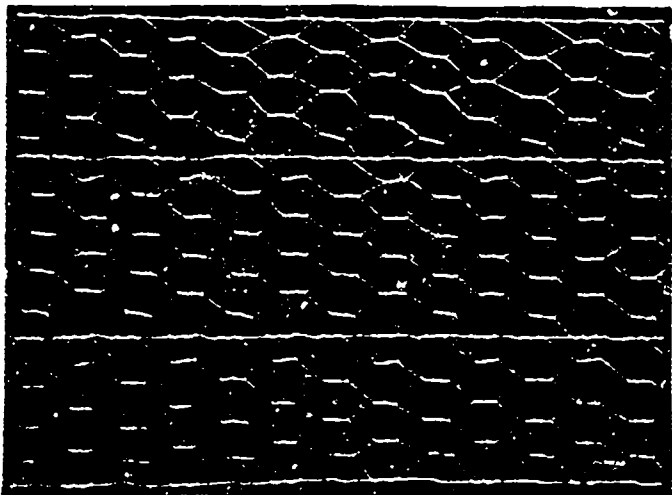

### Advantages

OF

### "New Century Fence"

1. It is the strongest, as every wire counts lengthwise.
2. It does not sag.
3. It is easily put up, and makes a fine appearance.

MANUFACTURED BY

The Ontario Wire  
Fencing Co., Limited  
PICTON, Ont.

Write for prices and particulars.

## NEW CENTURY NETTING

The Latest and Best



1. It is stronger than any other netting.
2. It is easily erected and makes a fine appearance.
3. Less posts are required than for other nettings.

# CAMP SUPPLIES

We have for years made a specialty of Lumbermen's Camp Supplies, including everything required in the Grocery and Provision line. We have been successful in supplying goods in quality and at prices which almost invariably bring repeat orders, for is it not the fact that quality of goods is required now, more than at any other period in the history of the industry. We are usually in a position to supply good quality at very nearly as low a price as the cheapest goods offering, and for this reason they are far more economical. We offer subject to being unsold and market changes:

Choice Evaporated Apples.....	5 <sup>1</sup> / <sub>2</sub> cents
Taps Comadre Figs.....	3 <sup>1</sup> / <sub>4</sub> cents
3 lb. Canned Whole Strawberry Beets, per doz....	45 cents
Boulters 2 lb. Corn, per doz.....	80 cents
Perth 2 lb. Refugee Beans, per doz.....	70 cents
Fine Filiatra Currants, (cleaned).....	4 <sup>3</sup> / <sub>4</sub> cents
Choice Sair Dates.....	3 <sup>3</sup> / <sub>4</sub> cents
100/110 Santa Clara Prunes in 50 lb. boxes.....	3 <sup>1</sup> / <sub>2</sub> cents
90/100 Santa Clara Prunes in 50 lb. boxes.....	4 <sup>1</sup> / <sub>2</sub> cents
80/90 Santa Clara Prunes in 50 lb. boxes.....	4 <sup>3</sup> / <sub>4</sub> cents
60/70 Santa Clara Prunes in 50 lb. boxes.....	5 <sup>3</sup> / <sub>4</sub> cents
40/50 Choice Oregon in bags.....	6 <sup>1</sup> / <sub>2</sub> cents
Trinidad Grocery Sugar.....	2 <sup>7</sup> / <sub>8</sub> cents
Cane Sugar Syrup (good flavor) in half barrels	1 <sup>3</sup> / <sub>4</sub> cents
Pearl Tapioca.....	2 <sup>3</sup> / <sub>4</sub> cents
Choice Quality Black, or Mixed Black and Green, Ceylon Tea.....	16 cents

---

## H. P. ECKARDT & CO.

WHOLESALE GROCERS

Corner Front and Scott Streets

TORONTO.

# SOVEREIGN OIL CO.

Sovereign Oils

High grade lubricating oils, Paraffines and Granite Candles, Greases, Soaps and Powdered Boiler Compound. Send to us for quotations before buying.

SOVEREIGN OIL CO.  
Toronto

## OHLEN SOLID AND INSERTED SAWS

Made from best of Steel, gives entire satisfaction in all kinds of timber.

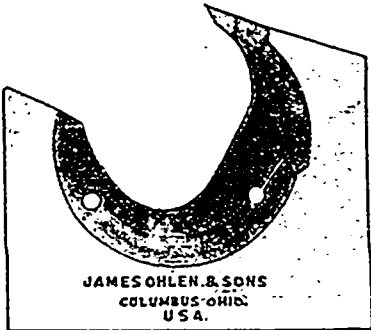

Write for Catalogue No. 51-B.

THE JAMES OHLEN & SONS SAW MFG. CO.  
COLUMBUS, Ohio, U. S. A.  
Or NEW YORK CITY, 120 Liberty St.

Please mention this paper when corresponding with advertisers.

Excellence is Paramount

THE

# "ACME" BRAND

-OF-

Shoepacks, Larrigans and Moccassins

are unexcelled.



--TO THE TRADE--

I confine myself exclusively to the manufacture of this line of goods, having an up-to-date tannery, also years of experience myself. I am prepared to fill all orders promptly and guarantee to give satisfaction at lowest possible prices.

WM. A. HOLT,  
ST. ANDREWS, N. B.

# WALTER THOMSON & SON

MANUFACTURERS AND DEALERS IN . . . . .

## Oatmeals, Split Peas and Pot Barley

LONDON, CANADA

Can supply in Carlots direct, or in less quantities through your Jobber. Quality unexcelled.

OUR 2, 3 and 4 SAW EDGERS

Are Dealers. Capacity up to 35 thousand.

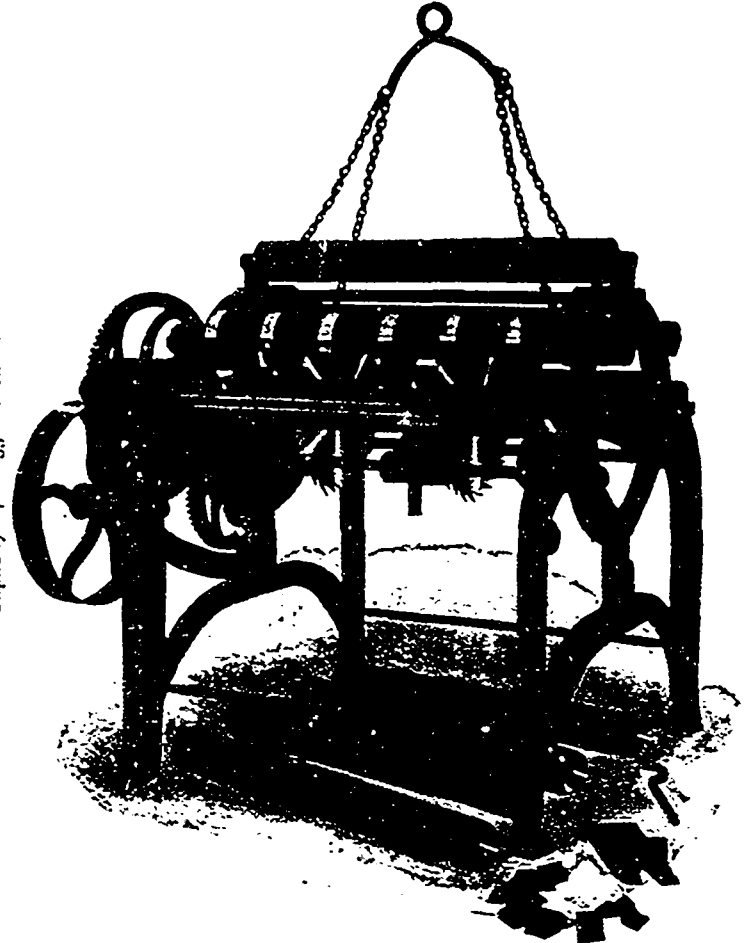

Direct Acting Steam Feed, with D Valve, acknowledged the best. Trimmers and Slash Tables

Improved design. Double and Single Geared Log Jack Works with chain complete.

All other kinds of Mill Machinery, with prices and terms on application.

Clipper Shingle Machine, capacity 25 to 30 thousand in ten hours. Improved Double Tooth or Boss Dogs with cast steel inserted teeth. Lockport Swing Shingle Heading Machine Complete Sawmill Outfits

Descriptive circulars and catalogue.

THE E. LONG MFG. CO., ORILLIA, ONT.

## Noble's Dominion Detective Agency

TORONTO, CANADA

Undertake legitimate Detective business and Confidential Investigations for CORPORATIONS, COMPANIES, BANKS, MERCANTILE HOUSES, LEGAL FIRMS, or individuals in any part of Canada or the United States by experienced and reliable operatives.

WE supply Detectives who are Mechanics, Clerks or Laborers to work in Factories, Warehouses, LUMBER CAMPS, Mines, etc., in order to learn all going on in regard to Unions, present or prospective; contemplated strikes, grievances, Thefts or Leaks of Any Kind, and all general information of value to the employer. We do not operate for rewards nor engage in divorce cases. Terms as reasonable as is consistent with good service. Patronage solicited.

LONG DISTANCE PHONE

ALEX. F. NOBLE, Principal  
A. E. NOBLE, Superintendent

Try the "Wanted and For Sale" Column in the Weekly Edition of the CANADA LUMBERMAN.

# T. LONG & BRO. LIMITED

## Wholesale Grocers and Van Suppliers

Collingwood, Ont.

We are situated on the South-East shore of Georgian Bay, and right in the hay and oat section. Our facilities for handling the Lumber, Mining and Railway supplying business are exceptionally good. We are fully equipped to supply all your wants in Lumbermen's, Miners', Railway and Camp supplies. Write or wire us for quotations. Our experience of fifty years in this business is at your service.

T. LONG & BRO., Limited

# SHERMAN FLOORING MACHINES-PATENTED

# RUSSEL WHEEL and FOUNDRY CO.,

Detroit, Mich., U. S. A.

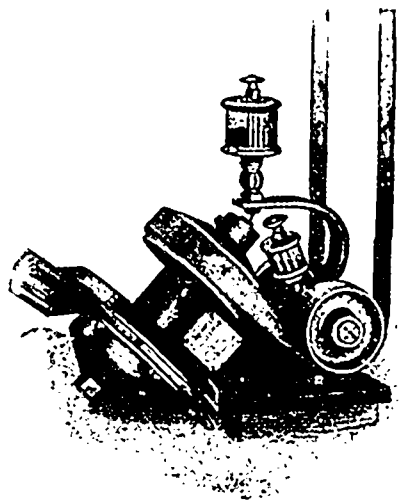

**SIDE BORING MACHINES**  
For attachment to any matcher to bore flooring run face up or face down.

**FACE BORING MACHINES**  
Used as an attachment to any flooring machine to bore jointed flooring.

**END MATCHERS**  
For end matching flooring strips.

Our Machines are the best in the market for the purpose.

Enquire about them. Write for circular with list of users.

**W. S. Sherman Co.**

729 North Water Street.  
Milwaukee, Wis.

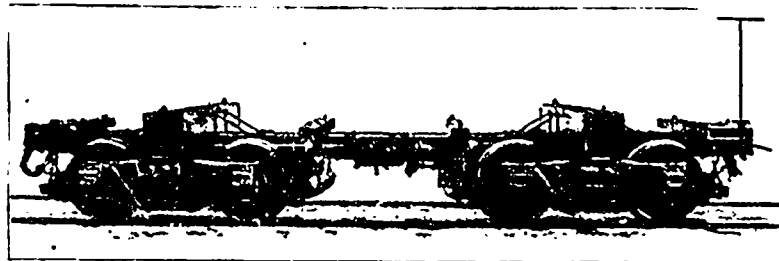

Builders of  
All Styles and Gauges of

# LOGGING CARS

# RUBBER BELTING

For  
Transmitting  
Elevating  
and  
Conveying



Rubber  
Hose  
for  
Water  
Steam  
Air  
Suction  
  
Fire  
Protection

**THE GUTTA PERCHA & RUBBER MFG. CO.**  
OF TORONTO, LIMITED.

45, 47 AND 49 WEST FRONT STREET, TORONTO, CANADA

Branches: Montreal, Winnipeg.

Lumbermen Require the Best

# Acadian Pride Homespun

is a Pure Wool Cloth and registered Purchasers are requested to look for exact name on ticket.

For either Suits or Pants this cloth will stand the stress of circumstances and the test of time.

FAC-SIMILE of ticket used on  
ACADIAN PRIDE HOMESPUN  
PANTS.



Send your address on postal card and we will mail a sample.

**CLAYTON & SONS,**  
HALIFAX, N.S.

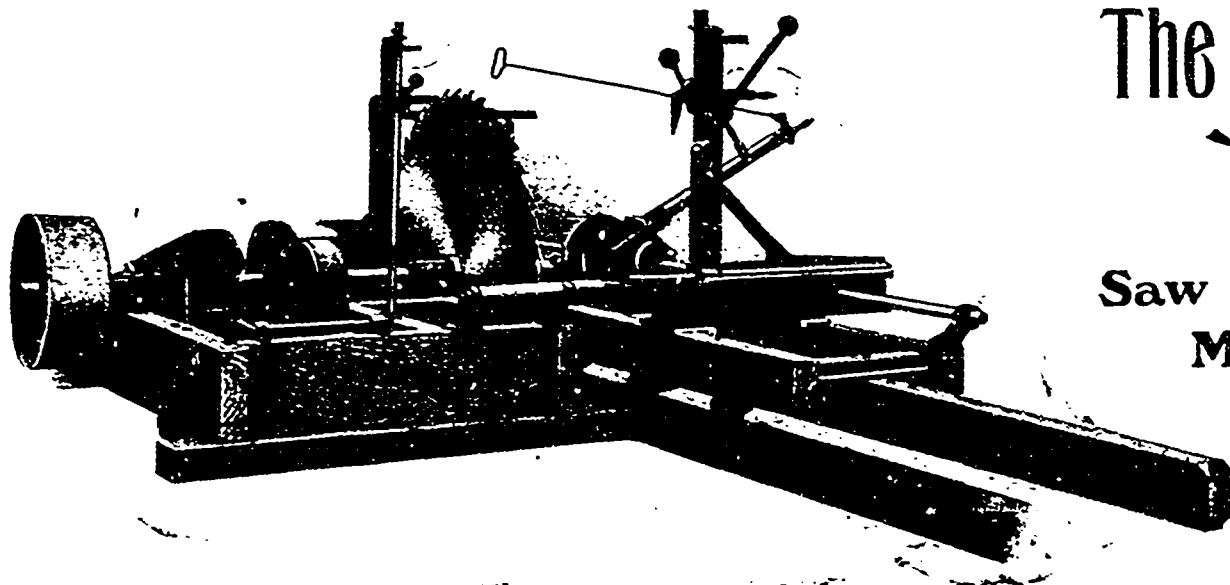

# The Knight M'fg Co.

GANTON, OHIO, U. S. A.

Manufacturers  
of . . .

**Saw Mills,  
Mill Dogs,  
Set Works  
and Edgers**

Correspondence from Canadian Mill Men invited. Send for a copy of our handsome Catalogue. It will interest you.



### NEW HUDSON BAY KNITTING COMPANY FACTORY.

The accompanying illustration represents the new factory of the Hudson Bay Knitting Company in Montreal. Generally speaking the building in which a business is conducted is not so interesting or so important to the customers of the house as the principles upon which the business itself is conducted.

The policy upon which the Hudson Bay Knitting Company has developed from a very small beginning to the present large proportion is one that commends itself to every live retailer in Canada who handles goods which the company manufacture. They make all kinds of warm clothing, caps, lumbermen's coats, lum-

bermen's socks, mitts and gloves and underwear in a very large variety. It is less than fifteen years since this business was started in one room, and during that time the company has been obliged to move and extend its premises half a dozen times, the factory here illustrated now being their new premises. Mr. J. J. Westgate, president and manager of the company, is the moving spirit of the concern, and it is largely due to his foresight and progressiveness that the business has grown to its present unique position. It is unique in the fact that none of its competitors ever succeed in catching up with the lines put out by the Hudson Bay Knitting Company. Always originating something new, always introducing improvements, carefully watching the trend of popular demand, their goods always show points of superiority

### HAND CUT FILES AND RASPS.

The largest hand-cutting file works in the United States is situated at Columbus, Ohio, operated by the

### PERSONAL.

The death occurred recently of Mr. James H. Belton, of London, Ont. Mr. Belton, who was in his eighty-first year, had been engaged in the lumber business for forty years.

Mr. Aubrey White, Assistant Commissioner of Crown Lands, Toronto, received many congratulations last month upon the occasion of the fifty-eighth anniversary of his birthday.

Mr. N. A. Gladding, vice-president and secretary of E. C. Atkins & Company, saw and tool manufacturers, Indianapolis, Indiana, has been appointed as one of the commissioners from Indiana to the Louisiana Purchase Exposition and World's Fair, to be held in St. Louis, 1904.

It is understood that Mr. John Bertram, of Toronto, president of the Collin's Inlet Lumber Company, will be appointed a member of the Government Commission on

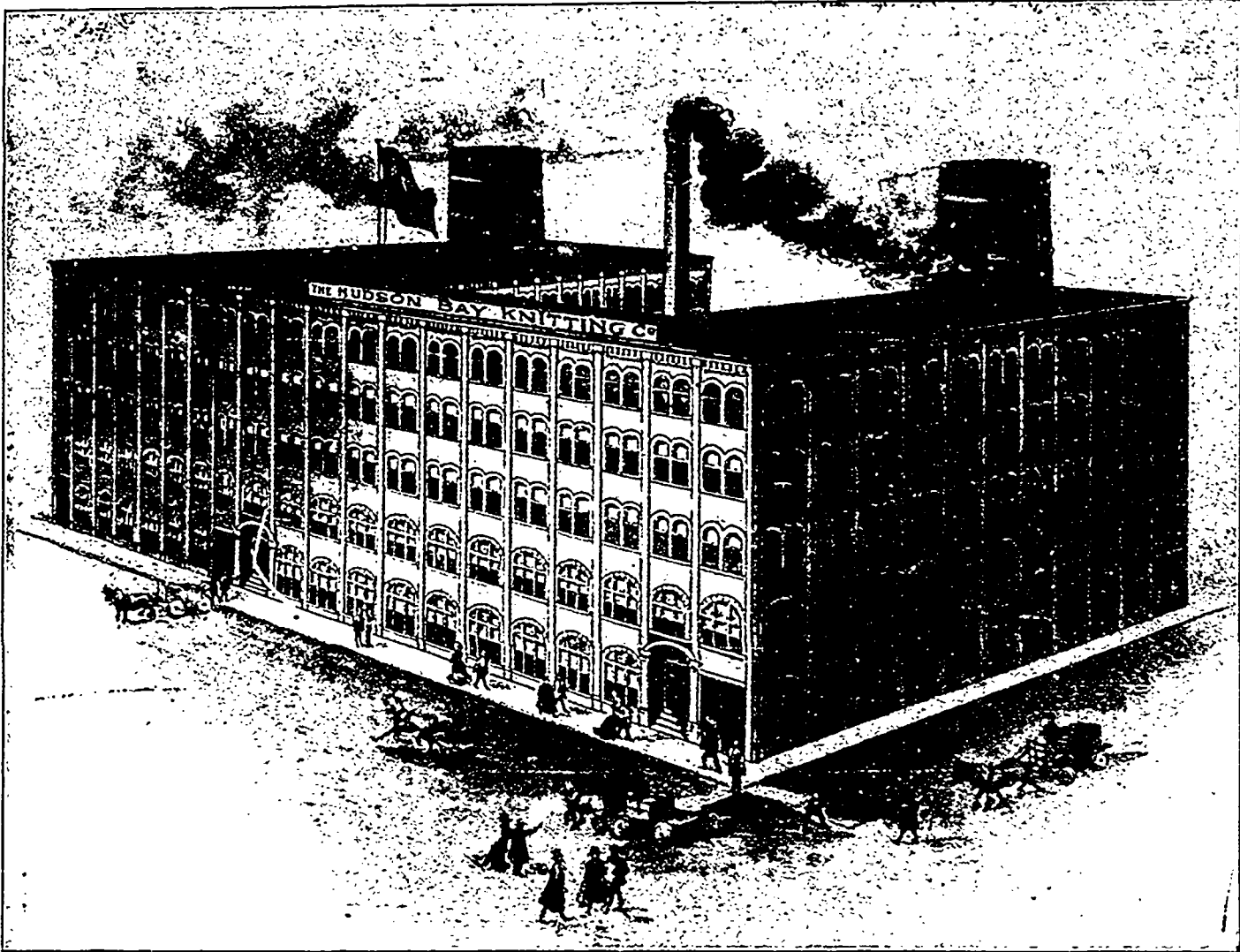

NEW FACTORY OF THE HUDSON BAY KNITTING COMPANY, MONTREAL.

Reynolds Brothers, and known as the Buckeye Saw Mfg. Company. They also manufacture all kinds of circular saws, sending them to all parts of the continent. Their celebrated hand-cut files are world renowned and are made in all sizes and shapes from 1 inch to 50 inches. When our representative called, he was shown over a veritable bee-hive of industry, and the processes from crude steel to the finished article were seen in course of manufacture. Alongside of the dainty little jewellers' file was placed an enormous special hot file which weighed fully 80 lbs., and destined to be handled by two men. Send for this firm's catalogue of saws and files.

James McNair, of Vancouver, B.C., has purchased another mill site at that place. We are told that "one of the most extensive users of hand resaws in the United States, resawing pine, has found 1½ inch spacing, ½ pitch, and tooth ⅜ inch long, the best specification for 6 inch saws, and this spacing preferable to 1½."

Transportation Problems. Mr. Bertram has been deeply interested for many years in the transportation and ship-building interests, and is president of the Bertram Engine Company, of Toronto

### WASTE SAWDUST.

126 Abbot Avenue, Westmount, April 21st, 1903.  
Editor CANADA LUMBERMAN.

Dear Sir,—Being interested in a process for utilizing sawdust I am anxious to obtain information of the amount that is produced annually by the mills in Canada, and to this end I would be pleased to have your readers send post card with answers to the four following questions:

- No. 1. How many months do you run?
- No. 2. How much sawdust does your mill produce? yearly, as near as possible.
- No. 3. What use do you make of it?
- No. 4. Name and address.

Sincerely yours,

CHAS. W. PEARSON.

# Swift & Company

## Pork and Beef Packers

## Lard Refiners

Our Popular Brands of Pork for Canadian Lumbermen

Mess: "Woodlawn Fat Backs"

Franklin Short Cut: "Clear Pork Backs"

Write us for prices on straight or mixed cars.

General Offices, Union Stock Yards, Chicago

Packing Plants at Chicago, Kansas City, Omaha, St. Louis, St. Joseph, St. Paul, and Ft. Worth—Agencies in all the Principal Cities of the World

# THE WM. DAVIES CO. LIMITED

TORONTO

## Pork Packers and Lard Refiners

—OFFER—

LIGHT and HEAVY, LONG CLEAR BACON, HEAVY MESS,  
ROLLS, HAMS and BREAKFAST BACON.

Lard in Tierces, Tubs, Pails and Tins,

Sausages and Sausage Meat,

Mincemeat, Jam and Pickles,

Plate and Mess Beef, Jellied Veal,

Canned Corned Beef, 14s, 6s, 2s, 1s.

**THE DAVIES BRAND THE GUARANTEE OF EXCELLENCE**

Hand Feed Machine \$150.00 and over.  
 Double Blockers - - \$550.00 and over.  
 Ten Blockers - - \$1200.00 and over.

—ALSO—

## COLUMBIA HEADING AND SHINGLE MACHINES

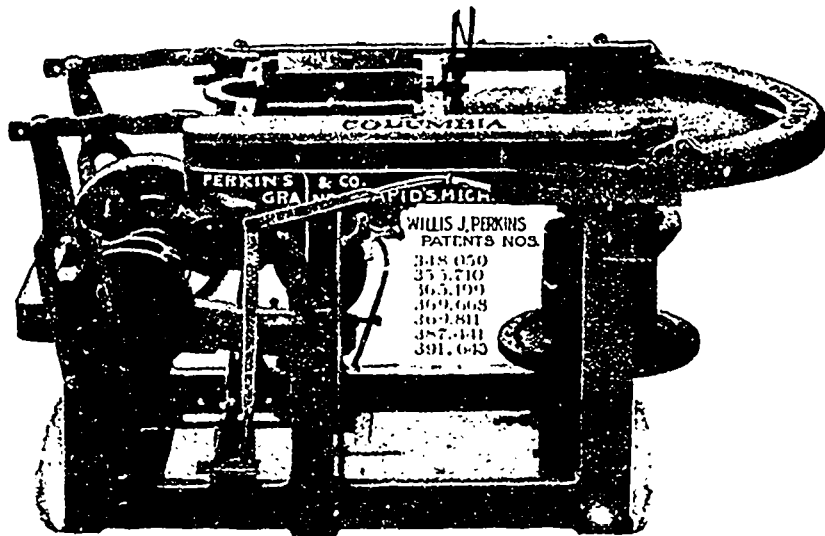

### THEY WERE WELL PLEASED.

PERKINS & CO.

HAMPTON, N. B.

DEAR SIR: -Replying to your favor of 18th inst., Mr. Shives has not called to see the Columbia as yet. Our man is feeding her on the fly now; he don't lose a clip. We are very much pleased with the machine.

Yours truly,

THE G. & G. FLEWELLING MANUFACTURING CO.

WE ARE LEADERS. WILL INCREASE YOUR CUT AND  
 SAVE YOUR MONEY. CATALOGUES ON APPLICATION.

**Perkins & Co., Grand Rapids, Mich.**

# FOWLER'S CANADIAN COMPANY, LIMITED

## Pork Packers

and

## Lard Refiners

WHOLESALE DEALERS IN

## LUMBERMEN'S SUPPLIES

**B**arrel Pork, Barrel Beef, Long Clear Bacon, Hams,  
 Breakfast Bacon, Lard, Sausage, Bologna, etc.

SPECIAL PRICES IN CARLOTS TO LUMBERMEN DIRECT.  
 QUALITY GUARANTEED THE BEST.

HAMILTON, Canada

# W. H. DWYER COMPANY, LIMITED

Commission and Wholesale Dealers in

## HAY, GRAIN and FARM PRODUCE

Room 11, 51 Sparks Street, OTTAWA Phone 1583.

Hay and oats are our specialty. Write or wire us for prices. We will quote you delivered at any railway station in Canada, and only ask for a chance to compete for your trade.

## SWEAT PADS

## HORSE BLANKETS

MY SPECIALTY

JUTE AND DUTCH KERSEY HORSE BLANKETS.

ANY SIZE. COMPLETE LINE.

We manufacture the material. I can quote the price that gets the orders. One trial will convince you.

Dealers in BRUSHES, CURRY COMBS and General Horse Supplies.

**H. F. FALKNER,** 60 GEORGE STREET, Toronto

We have the Finest Quality of

Long Clear Bacon

Short Cut Pork

Hams

Breakfast Bacon

Roll Bacon

and Lard.

Also Butter, Eggs and Cheese

Wire or Write for Quotations.

**The Whyte Packing Co., Limited,**  
STRATFORD - ONT.

# WHITEHEAD & TURNER

Wholesale Grocers.

Lumber and General Merchants

QUEBEC, P. Q.

Lumbermen Supplies

A Specialty

- |          |                   |       |
|----------|-------------------|-------|
| Pork     | Evaporated Apples | Rice  |
| Beans    | Molasses          | Peas  |
| Teas     | Matches           | Rope  |
| Tobacco  | Canned Goods      | Sugar |
| Raisins. |                   |       |

Hams

Bacon

Lard

Fresh Beef

Mutton

Veal

Butter

Eggs

Cheese

## THE PARK, BLACKWELL CO. LIMITED

TORONTO

Pork and Beef Packers, Wholesale Provisions.

WRITE US FOR PRICES.

## SPECIAL TO LUMBERMEN AND MINERS



WE ARE MANUFACTURERS OF

**MINCE MEAT, BAKING POWDER, SPICES,**

And all Kinds of Grocers' Sundries for Camp Use.

**SAUER KRAUT AND SAUSAGE MEAT.**

SPECIAL ATTENTION GIVEN TO MAIL ORDERS.

**THE CAPSTAN MANUFACTURING CO., Toronto, Ont.**

# "LIGHTNING" FLOORING MACHINE

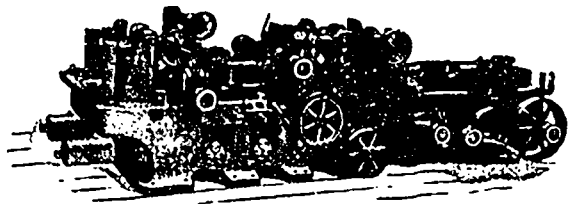

**Planers  
Surfacers and Matchers  
Timber Dressers**

For these or other

**J. A. FAY & EGAN CO.**

Cincinnati, Ohio, U.S.

**WOODWORKING MACHINERY**

WRITE

**PEACOCK BROTHERS**

Canada Life Building, MONTREAL

AGENTS FOR EASTERN CANADA

# WOOD - WORKING MACHINERY

of every description, in shingle tools or complete outfits. Complete catalogue free. Lumber Mill Machinery a specialty.

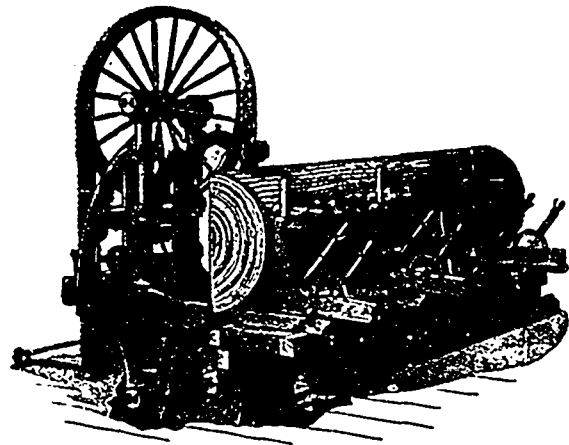

All interested in this machinery are invited to write us for particulars of any tools they may need. Illustrated matter, terms and information on demand.

Send for new pamphlet on care of Band Saws. Invaluable to all woodworkers.

**F. H. BRYDGES & SONS, WINNIPEG,**

GENERAL AGENTS FOR MANITOBA AND N. W. T. OF

**J. A. FAY & EGAN CO., CINCINNATI, OHIO.**

# A. F. BARTLETT & CO.

MANUFACTURERS OF AND DEALERS IN

**Engines, Boilers**

**Saw Mill Machinery, etc.**

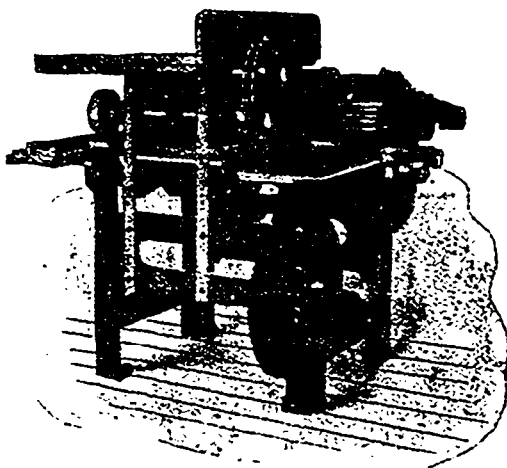

This is our new combined

**LATH MILL**

and

**BOLTER,**

the simplest and strongest machine on the market.

Write for circular and quotations.

Ask for our stock list of New and Second-Hand Machinery. . . . .

**A. F. BARTLETT & CO., SAGINAW, MICH.**

# BUFFALO TOOL AND MACHINE CO.

176 Terrace - BUFFALO, N.Y.

172 Front St. West, Toronto, Ont.

MANUFACTURERS AND DEALERS IN

# Wood and Iron Working Machinery

Save your money. Save middlemen's profits. Buy direct from factory. All goods fully guaranteed.

*Band Saws  
Jointers or Buzz  
Planers  
Cabinet Planers  
Surfacers  
Planers and Matchers  
Shapers*

*Turning Lathes  
Engines and Boilers,  
all sizes  
Saw Tables  
Moulders  
Saw Mills*

# Hanchett's Adjustable Saw Swages

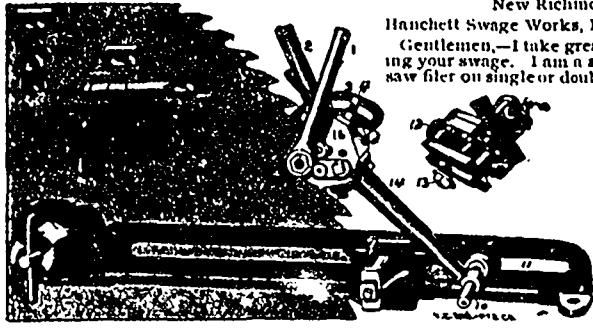

New Richmond, Wis., March 17, 1903.  
Hanchett Swage Works, Big Rapids, Mich. :  
Gentlemen,—I take great pleasure in recommending your swage. I am a saw maker and expert band saw filer on single or double cutting bands, and have used the different makes of swages now on the market, and consider the Hanchett superior to all others for circular or band.  
Yours truly,  
M. E. ALLEN

Mr Allen is with Willow River Lumber Co. at a salary of \$10 a day.  
The accompanying cut represents our Swage and Jointer for circular saws. Without question the best Swaging Machine in existence.

We also make Swages for Band Saws, Gang Saws and Band Resaws.  
We invite correspondence from Canadian mill operators and supply houses, mentioning this paper.  
**HANCHETT SWAGE WORKS, Big Rapids, Mich.**

## “ THE REEVES ”

For Saw or Planing Mill work  
“ The Reeves ” Wood Split Pulley is the favorite. A good, strong, durable pulley made honestly and made right.

**Reeves Pulley Manufacturing Company, Limited**  
17 PEARL STREET,  
**TORONTO, ONT.**

GET OUR PRICE LIST AND DISCOUNTS

### THE BEST IN THE WORLD

There is no doubt about the fact that the

## RODGERS

# Adjustable Log Siding Machine

[is without a peer.

This machine will slab opposite sides of a log in one operation at the rate of two thousand logs in 10 hours.

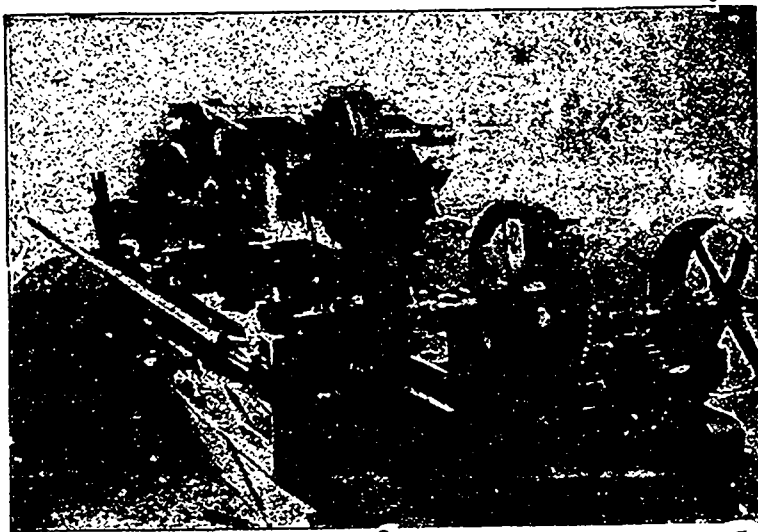

**A MONEY MAKER**

**A MONEY SAVER**

HUNDREDS OF LETTERS RECEIVED LIKE THIS :

Rock Island, Ill., Nov. 25, 1902.

RODGERS IRON MANUFACTURING CO., Muskegon, Mich.

Gentlemen,—Replying to yours of recent date and referring to your adjustable log siding machine, must say it has given us general satisfaction, and we have done good work with it. Anyone desiring a machine of this style for the purpose of slabbing small logs, we would recommend yours.  
Respectfully,  
WEYERHAUSER & DENKMAN.

For full particulars and literature, mention this paper and address :

**RODGERS IRON MFG. CO.**  
**MUSKEGON, MICH.**

# HIGH GRADE RUBBER BELTING

“ MONARCH ” “ RED STRIP ” AND “ LION ” BRANDS.

These well known grades of Rubber Belting are used by the principal lumber and saw mills from the Atlantic to the Pacific. Unequaled for durability, tensile strength and power-transmitting qualities

## “ REDSTONE ” SHEET PACKING

The most satisfactory Sheet Packing. Remains flexible under the highest pressures. Does not blow out or require any following up.

## MILL AND FACTORY FIRE HOSE

Are you sufficiently supplied with Fire Hose, and if so, is it in good condition for immediate use? If not, let us send you a Post Graduate treatise on the subject. We are the largest manufacturers of Fire Hose in Canada.

## THE GUTTA PERCHA & RUBBER MFG. CO.

of TORONTO, Limited.

Head Office and Warerooms,  
45, 47 and 49 West Front Street **TORONTO, CAN.**

Branches, Montreal and Winnipeg.

## THE WORLD'S HEADQUARTERS

—FOR—

# Blast Grates, Edgers and Trimmers

## THE GORDON HOLLOW BLAST GRATE

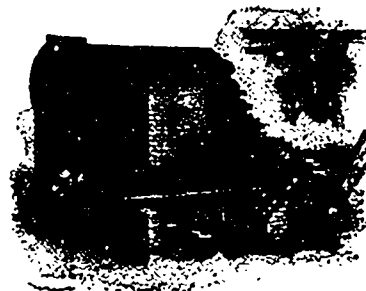

Makes the hottest fire of any device in existence. Burns anything and everything, wet or dry.

### CHEAPEST EDGERS AND TRIMMERS FOR SMALL MILLS ON EARTH !

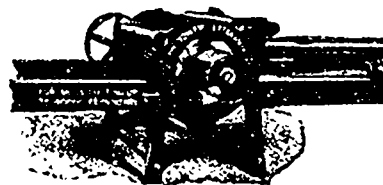

THE TOWER 2 and 3-Saw Edgers, Improved. For mills cutting not to exceed 20,000 ft. in ten hours.

THE TOWER EXTRA 3-Saw Edger. A larger and heavier edition of the TOWER. For mills cutting up to 30,000 ft. in ten hours.

That the TOWER and TOWER EXTRA Edgers possess merit of no common order is proved by the fact that there are 1,000 in daily use.



The TOWER One-man 2-Saw Trimmer. With this trimmer one man can easily trim the output of a mill cutting up to 30,000 ft. in ten hours. Will do more work in a given time than any other trimmer of the same size on the market.

**Gordon Hollow Blast Grate Co.**  
Greenville, Michigan.

ESTABLISHED 1839.

SEND FOR CATALOGUE D





WE MAKE A BIG LINE OF  
**River Shoes and Cruisers**

AND ALL KINDS OF HEAVY SHOES  
 FOR RIVER AND CAMP

WE HAVE MADE THEM FOR YEARS. WE KNOW HOW  
 TO DO IT. SEND FOR OUR CATALOGUE.

**Herold-Bertsch Shoe Co.,**  
 Makers of Shoes GRAND RAPIDS, MICH.



**Watson's Portable Air Tight Baker**



The most convenient stove ever constructed for use in the Woods, on the Drive, in the Camps. Bakes as perfectly as the finest range.

Read What Experienced Woodmen Say of It:  
 "We used your Portable Woods Baker all last season with a crew of men in the woods, travelling from place to place. We found it convenient to handle and the best steel range cannot beat it in baking. It is a perfect baking oven and a success in every way."  
 The cooking is not affected by rain or weather and can be used outdoors or in a tent.

Yours truly,  
 MEMONING RIVER BOOM Co.,  
 Per Wm. H. Stephenson, Gen'l Supt

We make these stoves in three sizes. Our No. 10 will cook for ten men; our No. 20 for twenty men, and No. 50 for from fifty to one hundred persons. We want those interested in a stove of this kind to write us for full description and prices.

**WATSON BROS.**  
 Manufacturers  
 MARINETE, WIS.

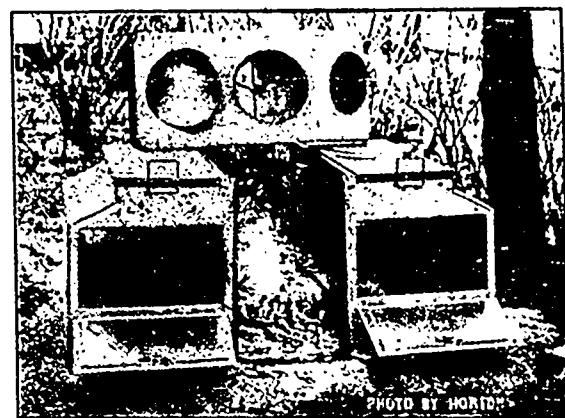

**Horse Sense**

Could be taken to mean Common Sense in the treatment of your horses. All Lumbermen depend largely on the efficiency of their horses. This can easily be maintained if

**Johnson's Veterinary Remedies**

are used.

The following valuable preparations have been largely in use amongst the Lumbermen of the Dominion for years. They are put up in bulk and are therefore more economical than similar lines, as the cost of packages, bottling, etc., etc., is saved:

**Johnson's Horse Liniment No. 1**

A penetrating Alcoholic Liniment for Sprains, Strains, Bruises, Swellings, Lameness, Curbs, Splints, etc., etc., \$4.50 per Imp. gallon.

**Johnson's Horse Liniment No. 2**

An excellent Oil Liniment for the same purposes, \$3.00 per gallon.

**Johnson's Horse Colic Remedy**

An absolutely safe and quick remedy for Colic of all kinds, \$5.00 per Imp. gallon.

**Johnson's Veterinary Healing Ointment**

Positively the best all round Healing preparation on the market for Cuts, Corks, Sore Shoulders, Wounds, Galls, Scratches, etc., etc., \$2.25 per 2 pound tin. Put up in 4 ounce tins if preferred.

Ten per cent. discount off orders amounting to \$50.00 or upwards. A full stock of all Drugs and Patent Medicines kept always on hand and at lowest wholesale rates. Correspondence solicited. Orders by mail receive special attention. Let me figure on your requirements.

**A. H. JOHNSON**  
 WHOLESALE DRUGGIST COLLINGWOOD, ONTARIO



**THE C. G. Young Co.**  
 Manufacturers  
**RUBBER STAMPS**  
 Cor. Yonge and Adelaide  
 Streets,  
**TORONTO**  
 Send for Quotations.



**OUR EXTRA  
 HAND-MADE  
 AXE**

This Axe stands better in frosty weather than any axe made. . . . Send for sample. Can supply any pattern.

**CAMPBELL BROS.**  
 Mfrs.  
 St. John, N.B.



ESTABLISHED 1849.  
**CHARLES F. CLARK, JARED CHITTENDEN,**  
 President, Treasurer.

**BRADSTREET'S**  
 Capital and Surplus, \$1,500,000.  
 Offices Throughout the Civilized World

Executive Offices  
 Nos. 346 and 348 Broadway, NEW YORK CITY, U.S.A.

THE BRADSTREET COMPANY gathers information that reflects the financial condition and the controlling circumstances of every seeker of mercantile credit. Its business may be defined as of the merchant, by the merchants for the merchants. In procuring, verifying and promulgating information, no effort is spared, and no reasonable expense considered too great, that the results may justify its claim as an authority on all matters affecting commercial affairs and mercantile credit. Its offices and connections have been steadily extended, and it furnishes information concerning mercantile persons throughout the civilized world.

Subscriptions are based on the service furnished, and are available only by reputable wholesale, jobbing and manufacturing concerns, and by responsible and worthy financial, fiduciary and business corporations. Specific terms may be obtained by addressing the company or any of its offices. Correspondence invited.

**THE BRADSTREETS COMPANY.**  
 OFFICES IN CANADA: Halifax N.S. Hamilton, Ont. London Ont.; Montreal, Que.; Ottawa, Ont.; Quebec, Que.; St. John, N.B. Toronto, Ont. Vancouver, B.C.; Winnipeg, Man.  
 THOS. C. IRVING,  
 Gen. Man., Western Canada, Toronto

The . . .

**QUEEN CITY OIL CO.**  
 LIMITED  
 Head Office: TORONTO.

HIGHEST GRADES OF

**Refined Oils**  
**Lubricating Oils**

AND ALL

**Petroleum  
 Products**

RE-OPENED FOR ORDERS  
**Blyth Handle Works**  
 BLYTH, ONT.  
 MANUFACTURERS OF . . .  
**Tool Handles**  
 of all Sizes.

**LUMBER CAMP SUPPLIES A SPECIALTY**  
 White Rock Maple and secu ul Growth  
 Rock Elm Furnished to the Trade . . .  
 Catalog on Application. E. LIVINGSTONE, Prop.

**Glass  
 Patent  
 Duplex  
 Mill Dogs**

These dogs have no springs, no ratchet, no pawls, nothing to get out of order, but have a positive grip so that no log can become loose or turn while being sawed. Dogs can be fastened on any head block knee and will hold small blocks on single head block if necessary to do so. Upper and lower dogs can be used together or independent of each other.

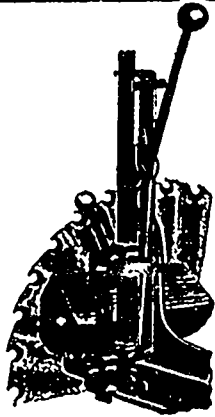

Right Hand Duplex Dog

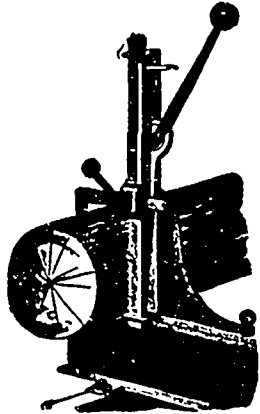

Right Hand Single Dog

**THE CANTON SAW COMPANY**  
 Manufacturers of Saws, Saw Mill  
 Dogs and Supplies.  
 South Rex Street, CANTON, OHIO

FRANK DENTON, Q. C. HERBERT L. DUNN  
 W. MULOCK BOULTBEE.  
**DENTON, DUNN & BOULTBEE**  
 Barristers, Solicitors, Notaries, etc.  
 National Trust Chambers. TORONTO

For Logging Tramways, Switches  
 Etc.  
 New and Second Hand.  
**RAILS  
 YARD LOCOMOTIVES**  
 John J. Gartshore  
 83 Front St. West,  
 (Opposite Queen's Hotel.) Toronto.

ESTABLISHED 1879.  
**The Stuart-Arbutnot Machinery Co.**  
 Limited.  
 WINNIPEG, MANITOBA  
 . . . Dealers in . . .  
**Saw Mill Machinery, Woodworker's Machinery,  
 Engines and Boilers**  
 MACHINERY AND MACHINERY SUPPLIES OF ALL KINDS.  
 REPAIRING PROMPTLY ATTENDED TO.  
**Just Received—One Carload Dodge  
 Pulleys and Self-oiling Hangers**  
 . . . Write us for Quotations

**THE ST. LOUIS LUMBERMAN**  
 Fullerton Building, St. Louis, Mo.

Twice a Month 1st and 15th	IF YOU WANT TO KEEP POSTED READ IT.	Subscription Price \$2.00 per year
-------------------------------	--	---------------------------------------

*Everybody* wants to buy something sometime,  
 wants to sell something sometime,  
*Constant Advertising Strikes that "Sometime."*

*Somebody* always wants to buy what  
 wants to sell,  
*Constant Advertising Brings Them Together*

*Nobody* knows where to buy if  
 advertises what he wants to sell,  
*Constant Advertising tells the "Where."*

*Anybody* nowadays must advertise,  
 nowadays reads advertisements.  
*Constant Advertising Strikes Constant Readers.*

SEND FOR SAMPLE COPY AND ADVERTISING RATES.

**ONE DOLLAR**  
 Will pay your Subscription to the Weekly and Monthly CANADA  
 LUMBERMAN for  
**ONE YEAR**

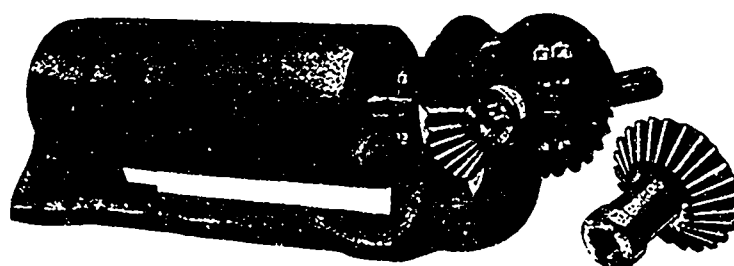

**LIVE ROLLS**  
 Rolls with connected stands. No wear on  
 your shaft. Very easily put on.

**Chilled Tooth Rolls**

These are the best made. They are cast on  
 end. The teeth do not wear. Rolls are made  
 any length. Split pinions for repairs. They are  
 cheap. Pinions will bolt on the shaft anywhere.

**CONCAVE ROLLS** for log decks.  
**SCREW ROLLS** with sharp thread.

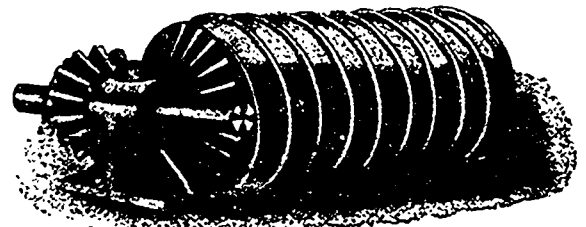
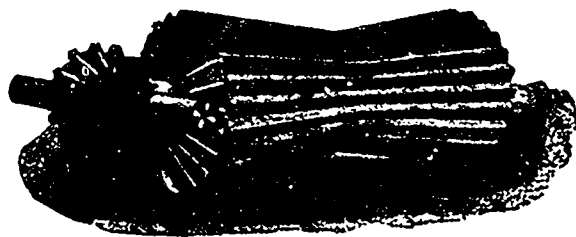

We also make Log Chains, Log Decks, Friction Log Turners, Log Loaders, Steam Niggers, Saw Carriages, any size that you want, and Shingle Machinery, Saw and Knife Jointers, etc. Send to us for Catalogue.

**MOWRY & SONS, Gravenhurst, Ont.**



Please mention CANADA LUMBERMAN when corresponding with advertisers.

## OILS

Manufacturers High-grade Cylinder, Machine and Sawmill Oils.

### Calypsol Grease

for Sawmill Purposes a Specialty. Our products are made from finest Pennsylvania stocks. We solicit your correspondence.

St. John St. MONTREAL. Commercial Oil Co., Hamilton, Ont.  
 Offices and Works: Manchester, Eng. Hamburg, Germany. Newark, N. J. Chicago, Ill.

## SCRIBNER'S LUMBER AND LOG BOOK

A handy book for Lumbermen. Gives Correct Measurements of Scantlings, Boards and Planks; Cubical Contents of Square and Round Timber, Doyle's Rules, and much other practical information.

PRICE 35 CENTS.

Address: The Canada Lumberman TORONTO, ONT.

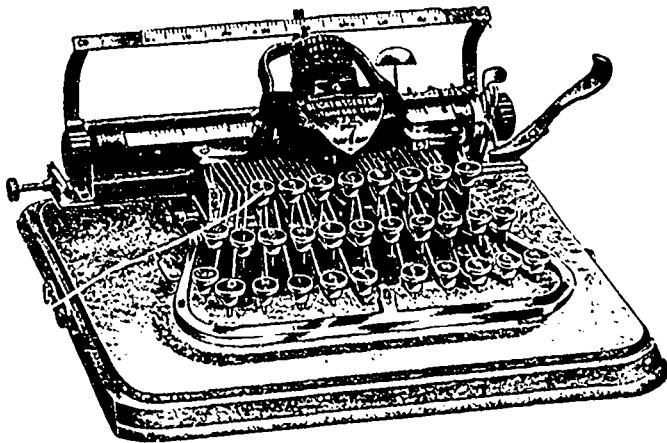

Model No. 7, \$50.00 Model No. 5, \$35.00

Write for particulars to

H. W. Knack, Sales Agent, Bay City, Mich.

A STANDARD MACHINE that will do as much work in a neater and better manner than any machine on the market and costing twice the money. For manifolding and mimeographing it has no equal. Has interchangeable type and line spacing, visible writing, perfect and permanent alignment, is simple, durable and portable.

## Detachable Chain Belt

—AND—

## CONVEYING

## MACHINERY

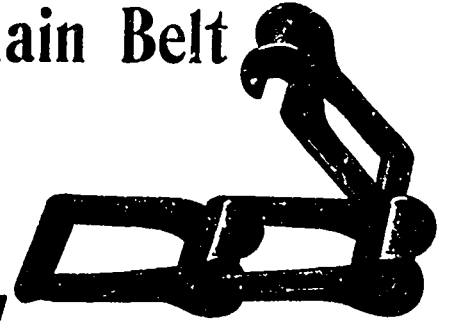

William R. Perrin & Company

TORONTO, CANADA.

The first of its kind on the market. New and original and first introduced by us  
**E. B. HAYES MACHINE CO., Oshkosh, Wis.**

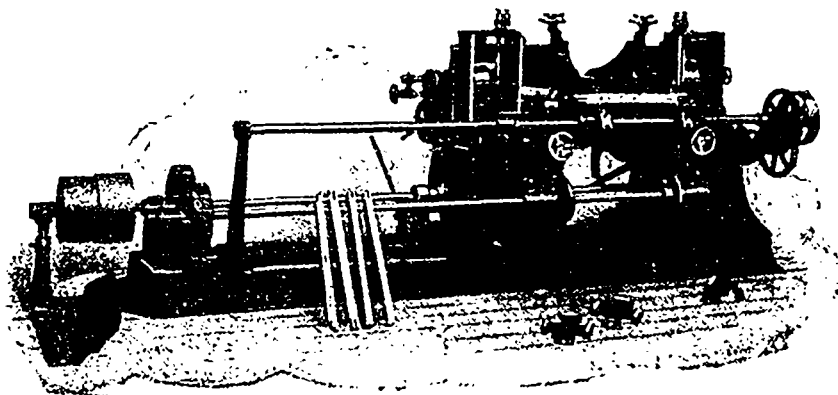

When a new and improved machine that has great merit in it like this one, is put onto the market, often times other machinery manufacturers will recognize the fact that it will be a good seller and they will try and start in to copy, of course providing they can do it. We expect it may be the case with this machine, but we know that all the mill men purchasing machines will want the Original, for many mill men in the past have met with great disappointment in buying copied machines. Write for full information.

OVER 35,000 IN USE IN EVERY KIND OF TIMBER

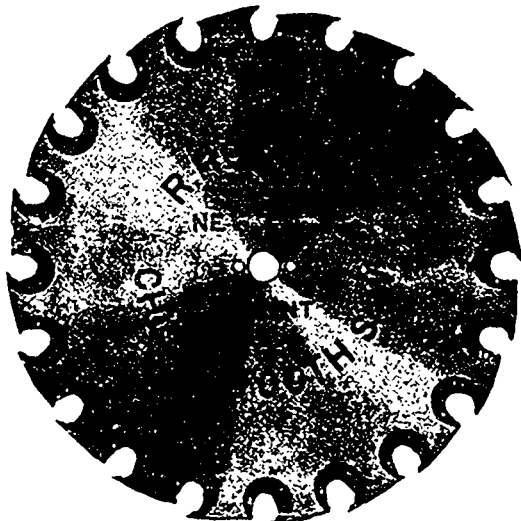

THE ONLY SUCCESSFUL INSERTED-TOOTH SAW.

# THE TWENTIETH CENTURY SAW

Our Chisel-Tooth Saw is adapted to all kinds and conditions of sawing, and does equally well in hard or soft woods, winter or summer, large or small mills.

It increases the output of the mill, requires less power and makes better lumber at less cost than any other saw.

**BEWARE OF IMITATIONS.**

THE GENUINE IS MADE ONLY BY

**R. HOE & CO.**

504 to 520 Grand Street, NEW YORK, U. S. A.

Catalogues with Prices and Further Particulars Sent on Application.

The **Wm. Kennedy & Sons, Limited**  
 Hydraulic and Mechanical Engineers, &C.

— **OWEN SOUND, ONT.**

Manufacturers of  
 the latest and best

**Turbine  
 Water  
 Wheels**

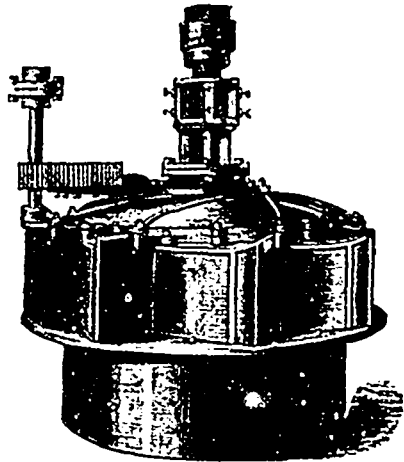
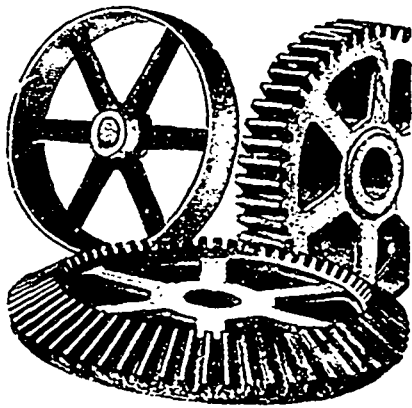

Heavy Machine Dressed  
 Gearing, Iron Bridgetrees,  
 Rope or Belt Pulleys, &c.,  
 for Mills or Factories.  
 Swing Shingle Machines.  
 Superior Steel Castings.  
 Iron or Steel, Sectional or  
 Solid Propeller Wheels for  
 all purposes.

**"DURHAM"**

is the Name of the

**BEST RUBBER BELT**

We Guarantee Satisfaction  
 Under Hardest Kind of Work

If you use Belts, Hose or  
 Packings we KNOW we can  
 INTEREST YOU.

WRITE TO US FOR FURTHER INFORMATION

THE  
**DURHAM RUBBER CO.**  
 LIMITED  
 BOWMANVILLE, ONT.

**High Grade Lumbermen's Tools**



For Quality our Tools have no  
 Equal on this Continent.

Our NEW PEAVEY is absolutely  
 Perfect in Design and Quality.



WRITE US FOR PRICE LISTS ON \_\_\_\_\_

**Cant Hooks, Peavies and Axes**

Ask for WARNOCK'S and if You Don't Get Them Write Us Direct.

**JAMES WARNOCK & CO. - GALT, ONT.**

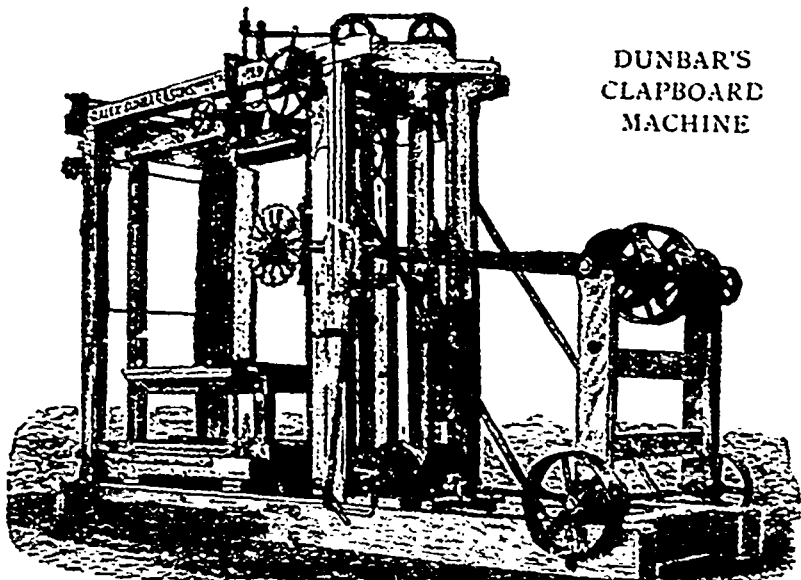

DUNBAR'S  
 CLAPBOARD  
 MACHINE

**ALEX. DUNBAR & SONS**

**Woodstock, N. B.**

Manufacturers of

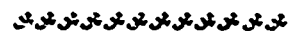

**Saw Mill Machinery**

OF ALL KINDS

Including ROTARY SAW MILLS (3 sizes), CLAPBOARD SAWING  
 MACHINES, CLAPBOARD PLANING AND FINISHING MACHIN-  
 ERY, SHINGLE MACHINES, STEAM ENGINES, Etc.

WRITE FOR FURTHER PARTICULARS

**ALEX. DUNBAR & SONS - Woodstock, N. B.**

# Improved Gang Lath Machine

This machine is entirely self contained—does not require a counter-shaft and pulley to drive the feed from.

It has a solid iron frame. The feed rolls are milled from solid steel bar and case hardened. In fact the machine is constructed of the best material throughout. Carries four 12 inch saws and will do fully as much work as any other machine made for the same purpose.

I manufacture other lath machines much heavier than this cut shows, and lath bolters of various capacities.

I also have a full line of saw mill and shingle mill machinery, and can quote low figures, especially to cash customers.

CATALOGUE FREE.

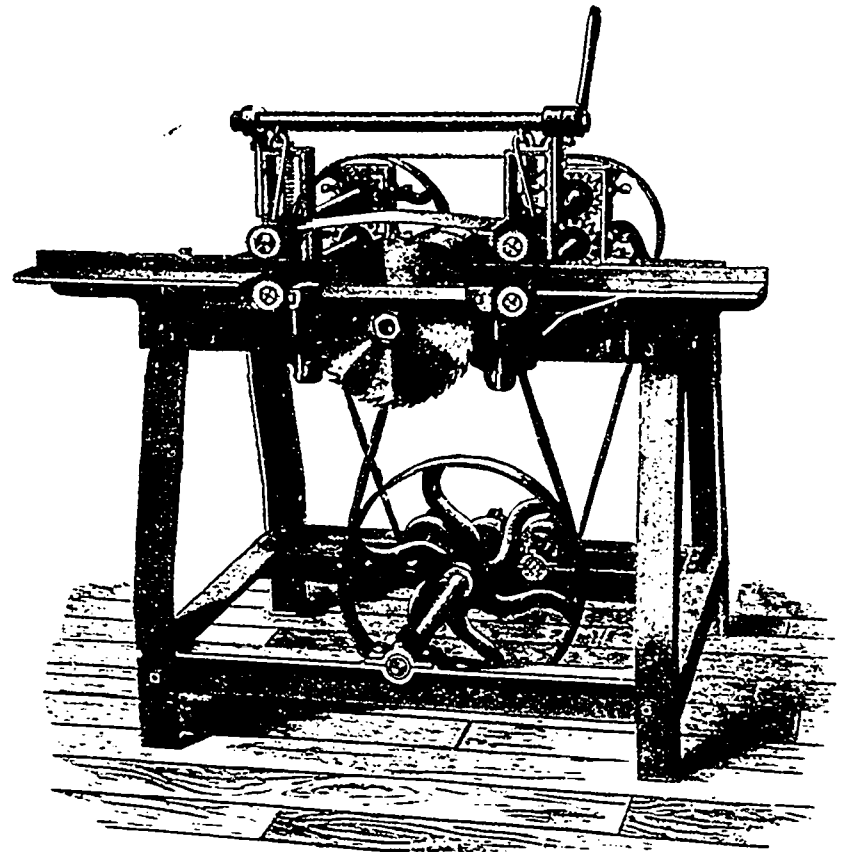

F. J. DRAKE, - Belleville, Ont.

## Do You Need a Turbine?

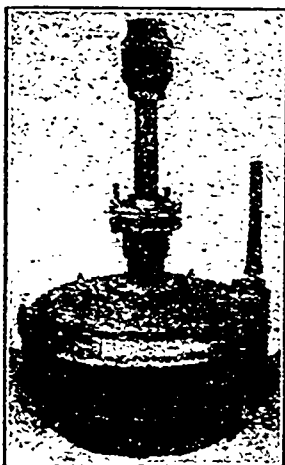

Now is the best possible time for replacing your old, worn-out wheel with a new Turbine that will save Worry, save Time, and make Money for you. If you want a well built wheel, a wheel that will give you steady reliable power every day, a wheel that will save water, a wheel that will last you a lifetime, and that is sold at a reasonable price, then write us for catalogue and prices on the

**Standard Leffel and Vulcan Turbines.**

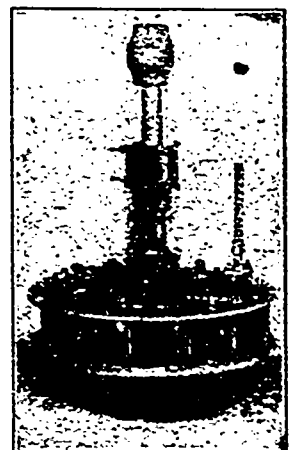

They are better developers to-day than ever before, and are growing in popularity, as our order books show.

We have now for distribution our new **SAW** and **SHINGLE MILL MACHINERY CATALOGUES**, with engravings and descriptions of our machines with their latest improvements. We will be glad to send you one on receipt of your address. You cannot buy a better Portable Mill than the "Lane Improved".

**MADISON WILLIAMS, PORT PERRY, ONT.**

H. E. PLANT, Agent,  
Cor. Common & Nazareth Sts., MONTREAL.

SUCCESSOR TO  
PAXTON, TATE & CO.

Winnipeg Machinery & Supply Co.  
Western Selling Agents, Winnipeg.

# ENDLESS CHAIN BULL-WHEELS OR LOG JACKS

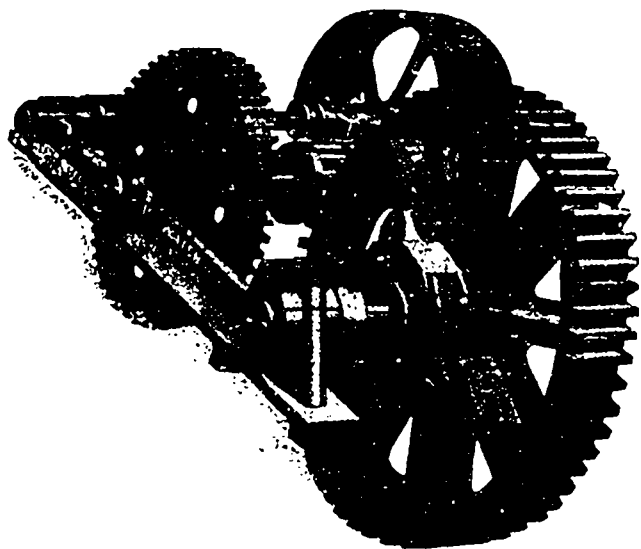

**WATEROUS NO. 0 DOUBLE-GEARED LOG JACK**

With spur gear to drive from shaft running across mill.  
When needed to drive from shaft running lengthwise of mill, we replace smaller spur gears with bevel gears or frictions placed outside of iron frame.

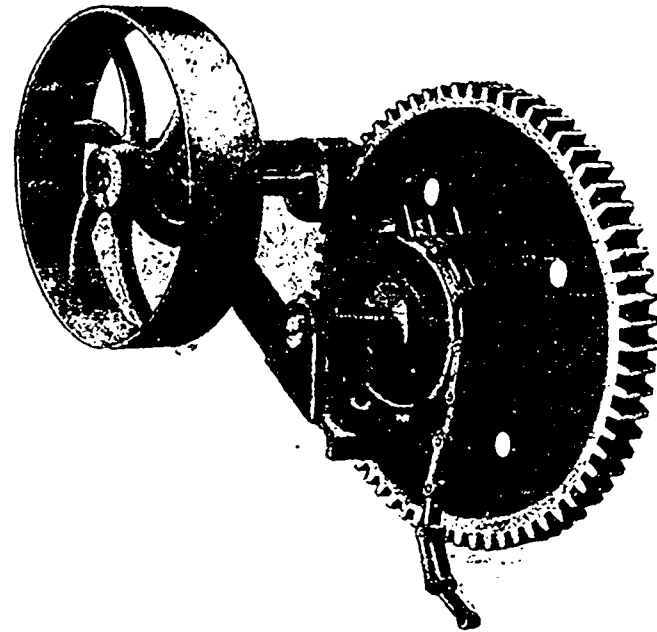

**WATEROUS NO. 1 SINGLE-GEARED LOG JACK**

With No. 86 log chain. Cast steel spurs and centre links, steel side links, 6" pitch. No. 80 log chain is the same style but heavier with drop forged center links, 8" pitch.

PULLEYS CAN BE READILY REPLACED BY STRAIGHT FACE FRICTIONS.

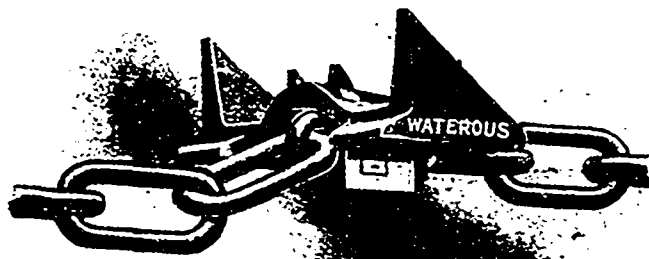

**Cable Chain with Cast Iron Log Spurs**

Chilled wearing shoes 4x12" on each side round link. Made 10", 12", 14" wide for 1", 1 1/4" and 1 1/2" chain. Can't turn on chain.



Malleable Log Chains—Detachable, readily applied.

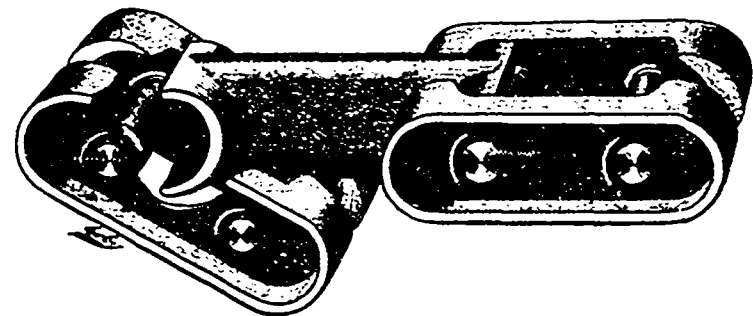

No. 1050 and 1075—Giant Chains, Detachable.

Not recommended for salt water—but there is no better chain for fresh water.

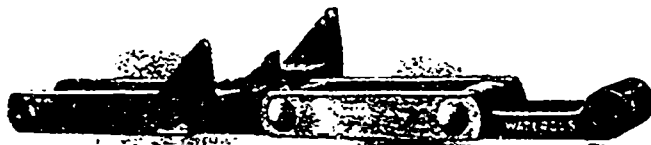

**No. 86 Steel Chain (Cast Steel Log Spurs).**

Rivets 3/4", side bars 1 1/4 x 3/8", 8" pitch, center (cast steel) 2 1/2 x 6" pitch. Spurs 9" point to point.

**No. 80 Steel Chain**

Is 8" pitch similar to above, except that solid link is a drop steel forging the pin is 1 1/2" in diameter (like illustration) and is fixed in position connecting side bars, presenting a large wearing surface for solid link. Side bars 2 x 1 1/2"



PIN OF NO. 80 CHAIN.

Taking a safety of 4 1/2\* this chain gives a 10,000 lbs. working strain. Log spurs same as No. 86 or of heavy forged steel, any spread desired.

## Forged Refuse Chains



R. Double.

Outside width 12 1/2 in.—Made of 1 1/2 x 1 1/2 in.

The 10 to 15 Tons of Ewart Detachable Link Belting we carry in stock insures prompt shipments.

# WATEROUS ENGINE WORKS CO., Brantford, Can.

# McEachren Heating & Ventilating Co.

GALT, ONTARIO.

Our Dry Kiln Installations are all giving the best of satisfaction. We make both a natural draft kiln and a blower kiln. Our Steel Trucks and Transfer Cars are worth examining; they are cheap yet strong and durable.

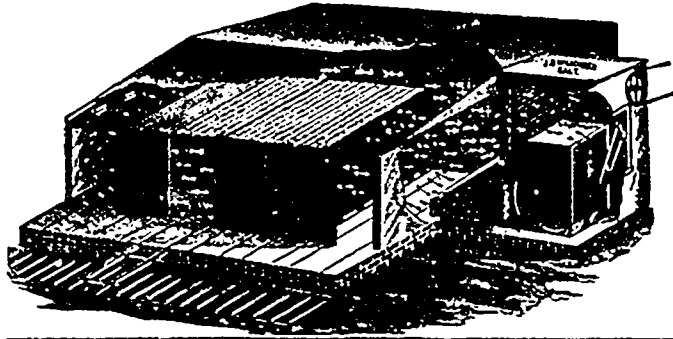

- Durability
- Efficiency
- Simplicity
- Economy

## WE CAN EXPLAIN

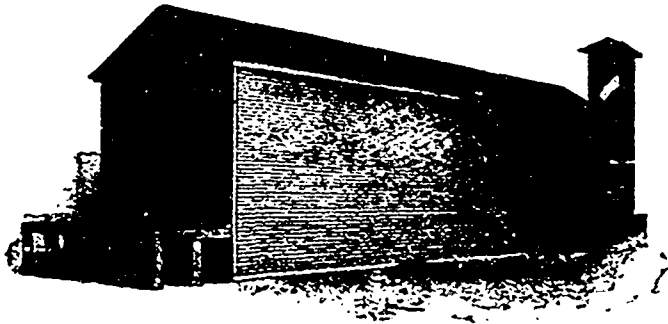

The "Whys and Wherefores"

of the excellence of the

## "ABC" Moist Air Dry Kilns

But we cannot do it in the small compass of this advertisement. We do, however, enter quite fully into such discussion in our catalogue, a copy of which is yours for the asking, also a solution of your drying problem if you will submit it.

Catalogue Number 139L.

**American Blower Company - - Detroit**  
 NEW YORK      CHICAGO      LONDON

## Popularity Proves Merit

in drying systems. And the greatest merit produces the widest popularity.

For over fifteen years the best-liked system has been

## THE STANDARD MOIST AIR DRY KILN

THE DRY KILN THAT DOES NOT DISAPPOINT

THE DRY KILN THAT DOES NOT DISAPPOINT

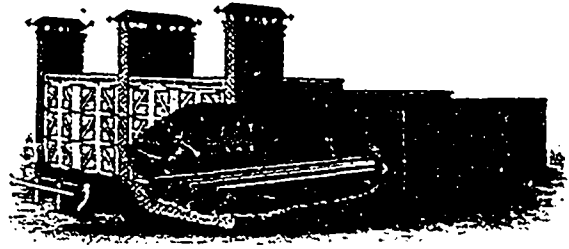

Catalogue "D" gives the reasons. Will you have it?

**THE STANDARD DRY KILN CO.,**

Indianapolis, Ind.

PRACTICALLY STRETCHLESS  
 STRONG  
 FLEXIBLE  
**Canadian Oak Belting Co. Limited**  
 BROCKVILLE, ONT.  
 SATISFACTION GUARANTEED

# The Morton Moist Air Dry Kiln

There is no other Kiln like the Morton.  
 SEND FOR CATALOGUE

Many say they thought they had good kilns before they bought the Morton, but would be satisfied with nothing else now.

What Constitutes the Best Dry Kiln?

The one that gives the most universal satisfaction, which, without question, is the Morton.

Manufacture: No. 149 rue Prince-Edouard, St. Roch.

Bureau: No. 142, rue de l'Eglise.

MESSRS. THE A. H. ANDREWS CO., Chicago, Ill.

GENTLEMEN:—Replying to yours of the 25th inst. I am pleased to say the Dry Kiln I purchased of you is giving good satisfaction. I am drying all kinds of lumber in it, and use exhaust steam in the day time and live steam at night. I am well pleased with the Morton Patent Moist Air Down Draft Dry Kiln, and have no hesitation in recommending same.

Yours truly,  
 (Signed) J. H. GIGNAC.

QUEBEC, January 31st., 1902.

**The A. H. Andrews Co.,**

300 Wabash Avenue,

Chicago, Illinois.

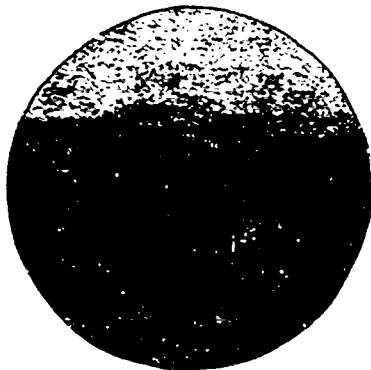

**THE JAMES ROBERTSON CO., Limited.**

Manufacturers of Saws of All Description

Full line of Mill  
Rubber and Leather  
Metal, &c., always

Supplies, including  
Belting, Babbit  
carried in stock.

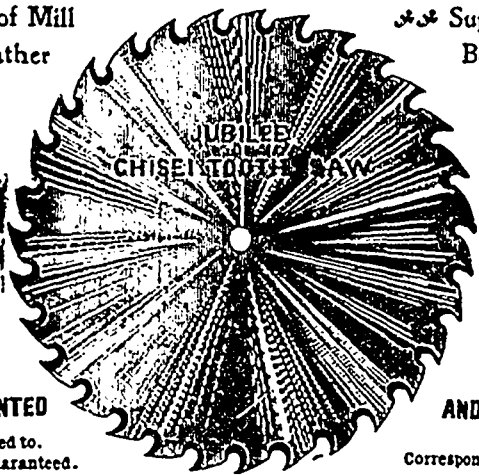

Head Office:  
144 William St.  
MONTREAL

Factories at  
MONTREAL,  
TORONTO,  
and  
ST. JOHN, N.B.

ALL OUR SAWS  
FULLY WARRANTED

Orders promptly attended to.  
Satisfaction Guaranteed.

CIRCULAR, GANG  
AND MILL SAWS  
A SPECIALTY

Correspondence Solicited.

**RIGE, LEWIS & SON**

Limited

**Lumbermen's Supplies**

S  
A  
W  
S

Chain  
Bolts  
Files

Steel  
Iron  
Horse Shoes

A  
X  
E  
S

Peveys  
Pike Poles  
Cant Hooks

Boot Calks  
Lumber Leads  
Timber Grips

R  
O  
P  
E

**TORONTO.**

Write for Prices

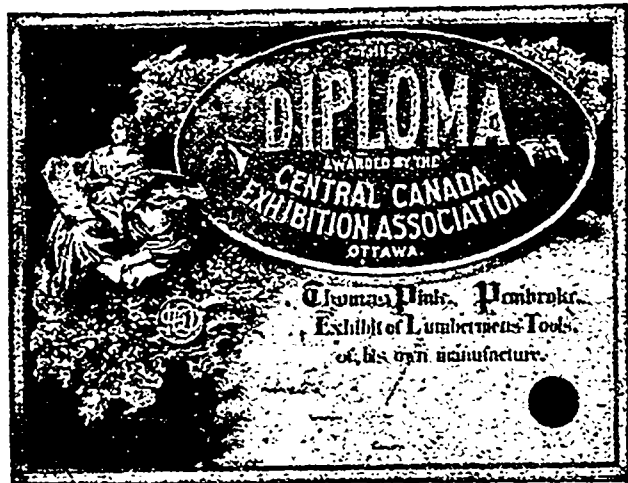

**THOMAS PINK**  
Pembroke, Ont.

Send for Catalogue and Price List.

**PINK LUMBERING TOOLS**

The Standard Tools

In Every Province of the Dominion, \* \* \* \* \*  
\* \* \* \* \* New Zealand, Australia, Etc.



Pink Round Bill Peavey, Handled in Split Maple

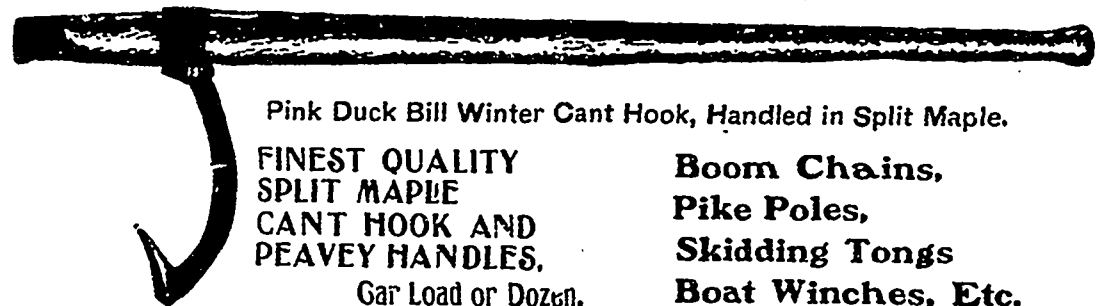

Pink Duck Bill Winter Cant Hook, Handled in Split Maple.

FINEST QUALITY  
SPLIT MAPLE  
CANT HOOK AND  
PEAVEY HANDLES.

Boom Chains,  
Pike Poles,  
Skidding Tongs  
Boat Winches, Etc.

Gar Load or Dozen.

Sold Throughout the Dominion by all Wholesale and Retail Hardware Merchants.

**LUMBER  
AND  
PULP**

**SAW MILLS.**—Complete equipments, on either the Circular, Band or Gang systems, manufactured, erected and handed over under guarantee to produce a specified output. We have been doing this sort of thing for years.

**PULP MILLS.**—The most advanced type of Pulp Mill Machinery and Supplies.

**MILL SUPPLIES.**—Absolutely everything required in manufactories, engine rooms or workshops. We carry extensive lines and can fill orders promptly.

**SPECIAL MACHINERY.**—No other establishment has the facilities we enjoy for constructing machinery required for special purposes.

*Your inquiries are requested.*

*Estimates prepared on application.*

We make liberal allowances  
for old machinery replaced by  
our modern plants \* \* \*

**CARRIER, LAINE & CO.**

Levis, Que.

SMOKE

# RED CROSS

PURE NATURAL LEAF.

ROUGE

QUESNEL

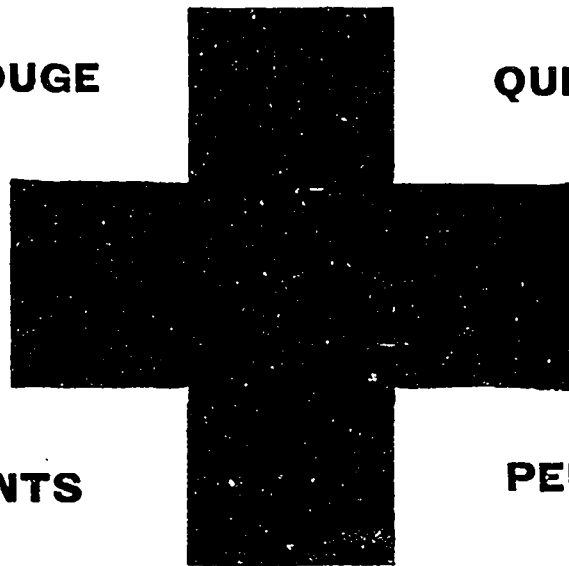

5 CENTS

PER PACKAGE

MILD SMOKING TOBACCO.

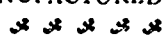
MANUFACTURED  
BY 

The B. Houde Company, Limited, Quebec, Canada.

Save the Coupons, they are valuable.

## “DON'T THROW THEM AWAY”

It is like throwing away money to throw away the Snow Shoe Tags which are on every plug of

# “BOBS” CHEWING TOBACCO

Save them and you can have your choice of over 600 presents. Tags are good up to January 1st, 1906.

Write for our new pamphlet describing the premiums; sent free on request.

### The Empire Tobacco Co., Limited

Hamilton Branch, 25 John Street. HAMILTON, ONT.



# WOODS LIMITED

OTTAWA

Successors to James W. Woods  
Wholesale Manufacturers

The Only Firm in Canada  
Making a Specialty of . . .

## Lumbermen's Supplies

Buy Direct From Us—Save Middlemen's Profit—Secure the Best Materials.  
Assure Satisfaction Among Your Men . . . . .

"Woods" Celebrated  
Etoffe Pants and Smocks

Bird's Mackinaw, 34 oz.,  
untearable Pants, Knickers  
and Belted Smocks

"Woods" Tweed, 16 oz., in  
Pants, Knickers and Coats

Duck Coats  
Rubberized Tweed and Mackinaw Linings.

Duck Coats  
Fur Lined, Tweed or Kersey Lining.

ALL FINISHED WITH STORM CUFFS, BALL AND  
SOCKET BUTTONS AND COLLAR TABS.

Corduroy Coats  
Lined and Unlined.

HATS

CAPS

SOCKS

MITTS

PIPES

SNOW-

SHOES

MATCH

SAFES

TICKING

TOWELING

"Woods" Ribbed Elastic Underwear,  
Unshrinkable, \$6.75, \$7.50, \$8.75.

See 223—Hand Knit \$10.00.

All Wool Hudson Bay Point Blankets  
White, Grey or Colored.

Genuine Deer Skin Moccasins  
Oil Tans, Palmer's and Henderson's, every pair  
selected.

Larrigans and Beef Skin  
Moccasins

Fowler's Celebrated Axes

Bags in Cotton or Jute

Mitts and Gloves for drivers  
or Choppers  
Deer Skin, Mule Skin, Sheep, Pig  
or Horse Hide.

All above goods are made on power machines in our own factory, and will hold together as long as the material.  
Our travellers are showing a full range of your requisites, immediate or fall delivery.  
Prompt shipments are our pride—test us with a telegram.

### SHIRTS

"WOODS" KERSEY 7, 8, 9, 10 OZ.  
MACKINAW  
DRUGGETT  
BLUE FLANNEL  
GREY FLANNEL  
COLORED FLANNEL  
FANCY TWEED  
HALIFAX TWEED  
FLANNELETTE  
BLUE DERRY  
BLACK SATEENS, \$4.50, \$6.75, \$9.00,  
\$12.00.

Try us for Tents, Tarpaulins,  
Dunnage Bags, Flags  
and Horse Covers

"Woods" Special Non-Ab-  
sorbent Duck Used in  
All Tents

Send Specifications for Our  
Quotations.

Get Our Catalogue and Discounts.

### OVERALLS

BIBS AND SMOX  
SEE OUR 7 OZ. GOODS  
DENIMS }  
DRILLS } \$6.75  
COTTONADE }  
9 OZ. \$8.75

THESE WERE ORDERED BEFORE  
RECENT ADVANCES.—GET RE-  
PEATS IN EARLY.—HEAVY  
STOCK ON HAND BUT  
VERY HEAVY DE-  
MAND.

We thank you for your very liberal patronage in the past; in bespeaking a continuance of your evident appre-  
ciation of our efforts, much larger premises will be necessary and are in course of erection, by which you may  
expect the same careful attention, prompt deliveries and high standard goods as in the past.

Woods, Limited, Ottawa, Canada