

Technical and Bibliographic Notes / Notes techniques et bibliographiques

The Institute has attempted to obtain the best original copy available for filming. Features of this copy which may be bibliographically unique, which may alter any of the images in the reproduction, or which may significantly change the usual method of filming, are checked below.

L'Institut a microfilmé le meilleur exemplaire qu'il lui a été possible de se procurer. Les détails de cet exemplaire qui sont peut-être uniques du point de vue bibliographique, qui peuvent modifier une image reproduite, ou qui peuvent exiger une modification dans la méthode normale de filmage sont indiqués ci-dessous.

Coloured covers/  
Couverture de couleur

Coloured pages/  
Pages de couleur

Covers damaged/  
Couverture endommagée

Pages damaged/  
Pages endommagées

Covers restored and/or laminated/  
Couverture restaurée et/ou pelliculée

Pages restored and/or laminated/  
Pages restaurées et/ou pelliculées

Cover title missing/  
Le titre de couverture manque

Pages discoloured, stained or foxed/  
Pages décolorées, tachetées ou piquées

Coloured maps/  
Cartes géographiques en couleur

Pages detached/  
Pages détachées

Coloured ink (i.e. other than blue or black)/  
Encre de couleur (i.e. autre que bleue ou noire)

Showthrough/  
Transparence

Coloured plates and/or illustrations/  
Planches et/ou illustrations en couleur

Quality of print varies/  
Qualité inégale de l'impression

Bound with other material/  
Relié avec d'autres documents

Continuous pagination/  
Pagination continue

Tight binding may cause shadows or distortion along interior margin/  
La reliure serrée peut causer de l'ombre ou de la distorsion le long de la marge intérieure

Includes index(es)/  
Comprend un (des) index

Blank leaves added during restoration may appear within the text. Whenever possible, these have been omitted from filming/  
Il se peut que certaines pages blanches ajoutées lors d'une restauration apparaissent dans le texte, mais, lorsque cela était possible, ces pages n'ont pas été filmées.

Title on header taken from:/  
Le titre de l'en-tête provient:

Title page of issue/  
Page de titre de la livraison

Caption of issue/  
Titre de départ de la livraison

Masthead/  
Générique (périodiques) de la livraison

Additional comments:/  
Commentaires supplémentaires:

This item is filmed at the reduction ratio checked below/  
Ce document est filmé au taux de réduction indiqué ci-dessous.

10X	12X	14X	16X	18X	20X	22X	24X	26X	28X	30X	32X
									✓		

# CANADIAN MANUFACTURER

AND INDUSTRIAL WORLD

DEVOTED TO THE MANUFACTURING INTEREST OF THE DOMINION

VOL. 53.

TORONTO, AUGUST 3, 1906.

No. 3.

## B. & W. PATENT WATER-TUBE BOILERS

Specially designed for the  
**RAPID, ECONOMICAL and SAFE**  
Generation of Steam up to the  
highest pressures.

Over 5,000,000. H.P. in use.

**BABCOCK & WILCOX,**

LIMITED

HEAD OFFICE FOR CANADA:

NEW YORK LIFE BLDG., MONTREAL.

BRANCH—114 King St. West, - TORONTO.

## "REDSTONE" HIGH PRESSURE SHEET PACKING

MAKES PERFECT JOINTS.

Does not blow out and requires no following up.

Try a sample lot and be convinced of  
its merits.

MANUFACTURED SOLELY BY

**The Gutta Percha & Rubber Mfg. Co.**  
of TORONTO, LIMITED

Head Offices—47 Yonge Street,  
TORONTO, CANADA

BRANCHES—Montreal, Winnipeg, Vancouver.

## THE Queen's Run Fire Brick

CO.

HIGHEST GRADE  
SHAPES A SPECIALTY

LOCK HAVEN, PENN.

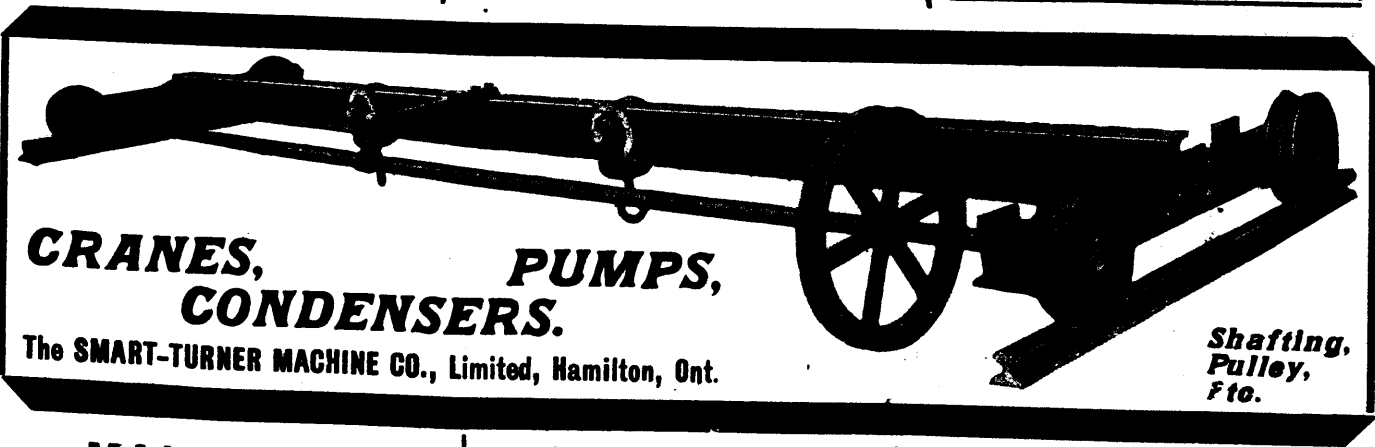

## CRANES, CONDENSERS, PUMPS,

The SMART-TURNER MACHINE CO., Limited, Hamilton, Ont.

Shafting,  
Pulley,  
Etc.

## MALLEABLE IRON CASTINGS

CAPACITY 3,000 TONS

**McKinnon Dash &  
Metal Works Co.,**

LIMITED

ST. CATHARINES, - ONT.

MAPLE LEAF  
STITCHED COTTON DUCK  
BELTING  
DOMINION BELTING CO. LTD.  
HAMILTON CANADA

## "CARRON" PIG IRON

Oldest and Best Scotch Make.

More Popular Than Ever.

**A. C. LESLIE & CO.,**  
MONTREAL

## High Grade Wood Working Machinery

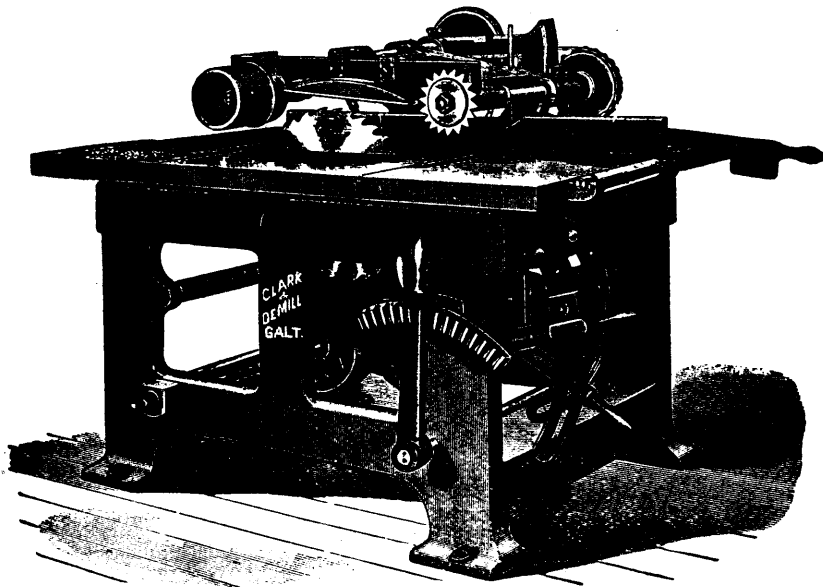

...Our No. 24 Variable Self-feed Rip Saw. A simple, substantial saw, designed for heavy work in Planing Mills, Furniture and Sash and Door Factories.

We aim to Lead in the Manufacture of New and Improved Wood Working Machinery

WRITE FOR CATALOGUE AND PRICES

**CLARK-DEMILL CO.,**  
LIMITED

(Successors to Clark & Demill,  
Galt, Ont.) **Hespeler, Ont.**

Western Representatives

The WATEROUS ENGINE WORKS CO., LIMITED, Winnipeg, Man.  
Agents for Manitoba, Saskatchewan and Alberta.

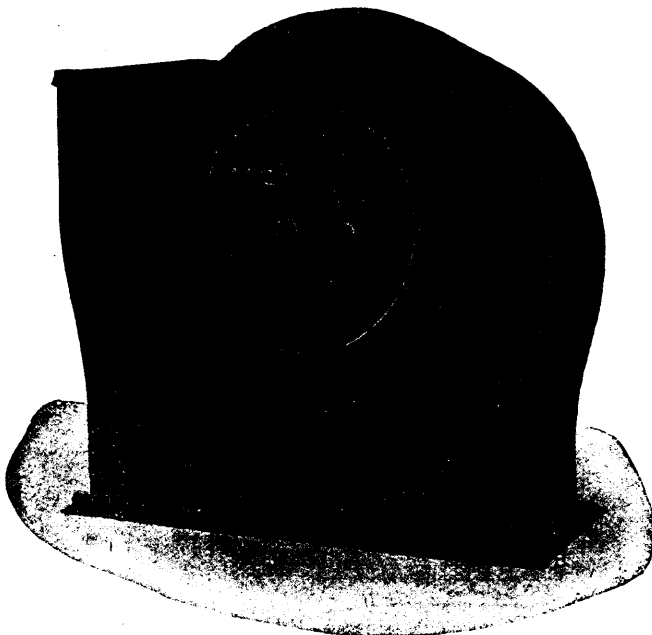

## HOT BLAST HEATING

### MECHANICAL DRAFT

DRYING SYSTEMS OF ALL KINDS  
FOR DRYING ANY MATERIAL

SHAVINGS EXHAUST SYSTEMS  
INSTALLED COMPLETE

Dry Kiln Trucks and Wheels, Lumber Dryers,  
Brick Dryers, Steel Brick Cars,  
Transfer Cars, Turntables, Etc.

Stationary and Portable Forges, Cupola Blowers, Exhaust Fans, Planing Mill Exhausters  
Dust and Shavings Collectors, and Steam Specialties, such as Back Pressure  
Valves, Oil Separators, Exhaust Heads, Etc.

VERTICAL AND HORIZONTAL STEAM ENGINES

## SHELDONS, LIMITED

Engineers and Manufacturers

GALT, ONT.

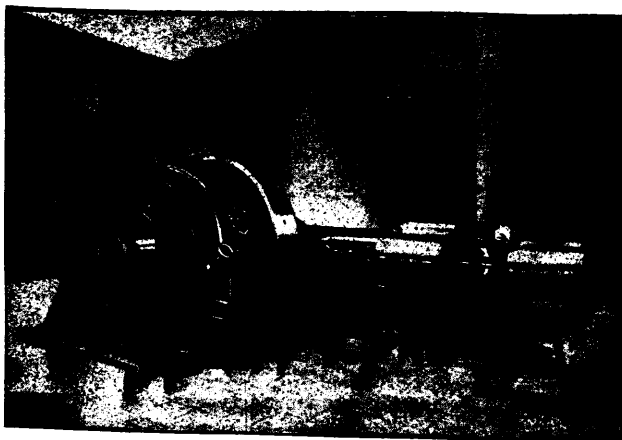

## IDEAL ENGINES

Perfection in High Speed Engine Design,  
Noiseless Running, Perfect Lubrication,  
Accessibility, Economy.

The **GOLDIE & McCULLOCH Co., Limited**  
Galt - Ontario - Canada

**WE MAKE** Wheelock Engines, Corliss Engines, Ideal Engines, Boilers,  
Pumps, Flour Mill Machinery, Oat Meal Mill Machinery, Oat  
Meal Steam Pan Kilns, Wood Working Machinery, Iron Pulleys,  
Wood Rim Split Pulleys, Shafting, Hangers, Gearing, Friction  
Clutch Pulleys, Friction Clutch Couplings, etc., Safes, Vaults  
and Vault Doors.

## KAYE'S Latest Patent Serrated Seamless Oil Can

Fitted with **NEW PATENT THUMB BUTTON**  
**SEAMLESS SPOUT** and **SLIDE FEED HOLE**

**IN COPPER OR  
BRASS FOR  
ELECTRICAL  
PURPOSES**

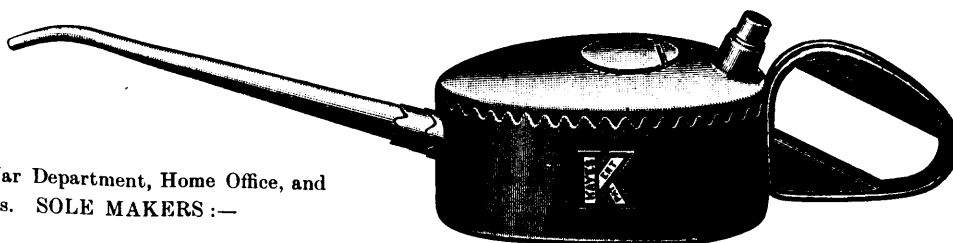

Contractors to H.M. Navy, War Department, Home Office, and  
Indian State Railways. **SOLE MAKERS :-**

**JOSEPH KAYE & SONS, Ltd.,** Lock Works, LEEDS, Cable Address: "LOCKENCARS," LONDON,  
Agent—The N. L. PIPER RAILWAY SUPPLY CO., 314 Front St. W., TORONTO, Ont., Can.

## MORISON Suspension Furnaces

For Land and Marine Boilers

With Plain Ends or Flanged to any required shape.

Uniform Thickness, Easily Cleaned, Unexcelled for  
Strength, Unsurpassed for Steaming Capacity.

*The universally satisfactory record of "THE MORISON" proclaims it the best furnace made.*

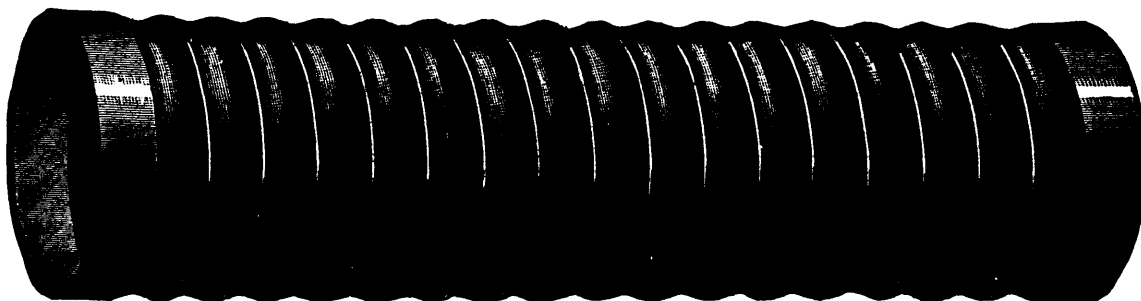

MANUFACTURED BY

**THE CONTINENTAL IRON WORKS,** WEST AND CALYER STS., BOROUGH OF BROOKLYN, New York  
Near 10th and 23rd Street Ferries.  
Sole Canadian Agent—**MR. GEORGE HOLLAND, M. C. Soc. C. E., P. O. Box 529, MONTREAL**

When writing to Advertisers kindly mention THE CANADIAN MANUFACTURER.

## THE ALCOMA STEEL CO., Limited

SAULT STE. MARIE, ONT.

is now booking orders for

# STEEL RAILS

For delivery during the Season of 1906.

Parties intending purchasing will find it to their interests to let us have their specifications at an early date so as to ensure desired deliveries.

**DRUMMOND, McCALL & CO.,**

General Sales Agents.

OFFICE:

Canada Life Building, MONTREAL.

## CANADA IRON FURNACE CO., Limited

Montreal, Radnor and Three Rivers

Manufacturers of the well-known

**"C.I.F." Three Rivers  
Charcoal  
Pig Iron**

Suitable for Car Wheels, Cylinders and Fine Castings, where the utmost strength is required.

UNSURPASSED IN STRENGTH BY SWEDISH, RUSSIAN OR AMERICAN CHARCOAL IRON.

Offices: Canada Life Insurance Building, MONTREAL.

What those who have dealt with  
us longest think of our service.

Cleveland, O., June 19, 1906.

To Whom it may Concern:

We get best results with our tools when we leave the selection of Tool Steel to Mr. Scott. Anything he will recommend is good enough for us.

The AMERICAN SHIP BUILDING CO.,  
Omer N. Steele, Local Manager.

THE  
BOURNE-FULLER CO.  
Cleveland, Ohio.  
TOOL STEEL DEPARTMENT  
J. C. SCOTT, Manager.

Pittsburg Office,

1126 Frick Bldg.

# NOVA SCOTIA STEEL and COAL CO.

LIMITED

MANUFACTURERS OF

## BRIGHT COMPRESSED STEEL SHAFTING

FROM  $\frac{1}{2}$  TO 5 INCHES IN DIAMETER. GUARANTEED STRAIGHT AND TRUE TO WITHIN  $\frac{1}{16}$  OF AN INCH.

Spring, Reeled Machinery, Tire, Toe Caulk, Sleigh Shoe, Angles, Special Sections and all Merchant Bar Steel. Sheet Steel up to 48 inches wide.

**RAILWAY AND ELECTRIC RAILWAY CAR AXLES**

**FISH PLATES, SPIKES AND TRACK BOLTS**

TEE RAILS, 12, 18, 24 and 28 lbs. per yard

**..HEAVY FORGINGS A SPECIALTY..**

**"SCOTIA" PIG IRON for Foundry Use**

Works—TRENTON, N.S., and SYDNEY MINES, N.S.

Head Office—NEW GLASGOW, NOVA SCOTIA

When writing to Advertisers kindly mention THE CANADIAN MANUFACTURER.

**NICKEL**  
 THE CANADIAN COPPER COMPANY.  
**NICKEL FOR NICKEL STEEL**

THE ORFORD COPPER COMPANY.

**WRITE US FOR PARTICULARS AND PRICES.**

General Offices: 43 Exchange Place, NEW YORK.

**UNION DRAWN STEEL CO., LIMITED**

**COLD DIE-ROLLED  
STEEL AND IRON**



**For Shafting, Piston Rods  
Screw Steel and  
Roller Bearing Rods**

True to Size and Highly Polished.

**ROUNDS, SQUARES, FLATS AND HEXAGONS.**

**ASK US FOR PRICES.**

Office and Works: **HAMILTON, CANADA.**

**What is Your Bookkeeper's Time Worth?**

Is your ledger arranged on any special system?

You thought Smith's account would run two pages and here it has run four.

You had to mark in at the bottom, "Transferred to page 600."

And how many more are there like Smith's?

\*\*\*

Your ledger accounts can be made to run alphabetically; if Smith's account runs over the page you gave it, it is the simplest thing in the world to drop in another leaf.

C.  
Dept.  
Send to the address below full information about Business Systems.

You can keep all your live accounts in one ledger—you don't need two or three big cumbersome books each indiscriminately full of live and dead accounts.

\*\*\*

Business System's Loose Leaf ledgers permit of easy insertion or removal of sheets.

Business Systems Loose Leaf ledgers open perfectly flat and give you a level writing surface.

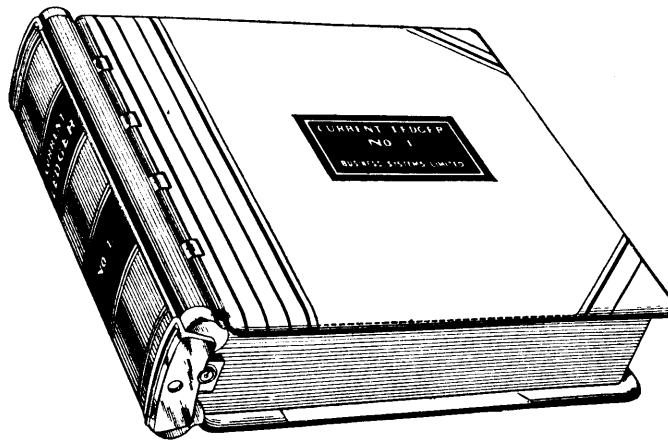

Business System's Loose Leaf ledgers are strongly made, durable and with no rough edges to scratch the desk.

\*\*\*

There are other advantages about which we have not space to tell you. But we would like to have you know.

If you will fill in your name and address on the coupon in the corner and send it to us, we will send you further detailed information.

Address Dent. C.



**BUSINESS  
SYSTEMS  
LIMITED**

**TORONTO, CANADA.**

BRANCHES AT  
WINNIPEG, MONTREAL,  
HALIFAX and ST. JOHN, N.B.

# THE NICHOLS CHEMICAL COMPANY OF CANADA, LIMITED

Head Office—222 ST. JAMES ST., MONTREAL.

Works—CAPELTON, P.Q.

MANUFACTURERS OF HIGHEST QUALITY CHEMICALS

Sulphuric, Muriatic and Nitric Acids, Glauber's Salt, Salt Cake, Mixed Acid for  
**DYNAMITE MAKERS, Etc.**

AGENTS FOR STAR and TRIANGLE BRANDS

**BLUE VITRIOL.**

PUREST AND STRONGEST

**PAPER MAKERS' ALUM.**

Address all Correspondence to the Head Office, - MONTREAL.

## NORTHERN ALUMINUM CO., LIMITED

Shawinigan Falls, P.Q.

Business Office Pittsburgh, Pa.

# ALUMINUM

INGOTS—SHEETS—TUBING, ETC.

*Aluminum Stamped, Cast, Spun Articles of any Description to Order.*

ALUMINUM WIRE and CABLES (BARE OR INSULATED) for Electrical Conductors.



## SODA ASH

LIGHT or HEAVY

THE MOST ECONOMICAL FORM OF SODA FOR MANUFACTURERS OF  
**GLASS, SOAP, PAPER, WOOD PULP**  
and **COLORS**, and for **PRINTERS**  
and **BLEACHERS**

## BLEACHING POWDER,

HIGH STRENGTH, 35/37% IN  
HARDWOOD CASKS.

ALSO CAUSTIC SODA, SALSODA, CONCENTRATED SALSODA  
SALAMMONIAC, Etc.

## BRUNNER, MOND & CO., LIMITED, NORTHWICH, ENG.

WINN & HOLLAND, Montreal, SOLE AGENTS FOR CANADA

## The Jenckes Machine Co., Limited

Mining Machinery; Pulp Mill Machinery;  
Steam and Water Power Plants.

Catalogues and Estimates on request. Correspondence Invited.

EXECUTIVE OFFICE—60 Lansdowne St., SHERBROOKE, QUE.

Sales Offices : TORONTO, ROSSLAND  
HALIFAX, VANCOUVER

Plants : SHERBROOKE, Quebec  
ST. CATHARINES, Ont.

# The Canada Chemical Manufacturing Company, Limited

MANUFACTURERS OF

COMMERCIAL  
QUALITY

## Acids and Chemicals

Chemically Pure  
Quality

**ACIDS:** Sulphuric, Muriatic, Nitric, Mixed, Acetic, Phosphoric, Hydrofluoric.

**CHEMICALS:** Salt Cake, Glauber's Salts, Soda Hypo, Silicate, Sulphide, Epsom Salts, Blue Vitrol, Alumina Sulphate, Lime Bisulphite, Nitrate of Iron, C.T.S. and Calcium Acid Phosphate.

Chemical Works and Head Office  
LONDON.

Sales Office  
TORONTO.

Warehouses  
TORONTO and MONTREAL

### CASSELLA COLOR COMPANY

(American Branch of Leopold Cassella & Co.)

ARTIFICIAL

# DYESTUFFS

New York, 182-184 Front Street.

Boston, 68 Essex Street.

Philadelphia, 126-128 South Front St.

Providence, 64 Exchange Place.

Atlanta, 47 North Pryor Street.

Montreal, 86 88 Youville Square.

## ANILINES

St. Denis Dyestuff and Chemical Co.,

(A. POIRRIER), of Paris, France.

Manufacturers of

Aniline Colors, Aniline Oil and Salt, Archil Extracts  
Cudbear, Cachou de Laval, Thiocatechines, etc.

A Complete Assorted Stock of the above always on hand.

**W. T. Benson & Co.,**

Sole Agents for Canada.

164 St. James St., MONTREAL

### THE WELLINGTON MILLS

LONDON, ENGLAND.

## Genuine Emery

Oakey's Flexible Twilled Emery Cloth.  
Oakey's Flint Paper and Glass Paper.  
Oakey's Emery Paper, Black Lead, etc.

Prize Medal and Highest  
Award Philadelphia, 1876,  
for Superiority of Quality,  
Skillful Manufacture,  
Sharpness, Durability, and  
Uniformity of Grain.

Manufacturers

**JOHN OAKEY & SONS, Limited**

Wellington Mills, Westminster Bridge Road, London, England.

Enquiries should be addressed to

**JOHN FORMAN, 708 Craig St., Montreal.**

## THE IMPERIAL OIL COMPANY, Limited

Highest Awards at the World's Fair, Chicago, upon

Lubricating, Water White Illuminating Oils,  
Paraffine Wax, Etc.

We manufacture all grades of oils, greases, soap stocks, candles, wool stocks, leather and tanners' oils, fuel gas, machinery, cylinder oils, &c. And solicit opportunity to compete against any oil on the market. Write for prices and samples.

Refineries at **SARNIA and PETROLIA, CANADA.** Merchandising Branches at:

HALIFAX, N.S. HAMILTON, ONT. QUEBEC, QUE. LONDON, ONT. TORONTO, ONT. WINNIPEG, MAN. ST. JOHN, N.B. GUELPH, ONT.  
MONTREAL, QUE. CHATHAM, ONT. PETERBORO, ONT. VANCOUVER, B.C. MONCTON, N.B. STRATFORD, ONT. KINGSTON, ONT. WINDSOR, ONT.

When writing to Advertisers kindly mention THE CANADIAN MANUFACTURER



# PROFESSIONAL DIRECTORY.

Patent Attorneys, Mechanical and Electrical Engineers, Hydraulic and Constructing Engineers, Chemical and Mining Experts, Contractors and Builders, Architects, Auditors, Accountants, Etc.

## C. H. VOGEL

A. M. Can. Soc. C.E. ENGINEER  
OTTAWA, CAN.  
Surveys, Plans, Specifications and Supervision  
**WATER POWER**  
PAPER, PULP and SULPHITE FIBRE MILLS

## K. L. AITKEN

*Consulting Electrical Engineer.*

164 Bay Street, TORONTO.

Long Distance Phones (Office, Main 1482.  
Res., North 2239.

## T. A. MORRISON & CO.

202 St. James Street MONTREAL  
Contractors' Plant, New and Second-hand.  
Steel Jaw Stone Crushers, all sizes.  
Sturtevant Roll Jaw and Rotary Fine Crushers.  
Balanced and Centrifugal Rolls, Emery Mills,  
Steam Road Rollers, Boilers and Engines,  
Rock Drills, Concrete Stone,  
Bridge and Building Limestone, Bricks, etc., etc.

## C. J. FENSOM, B. A. Sc.

*Consulting Engineer*

ABERDEEN CHAMBERS, - TORONTO  
Phones (Office, - - M. 1923  
Residence, N. 2967

Machinery Designed, Supervised, Inspected and  
Contracted for. Tests, Reports, Electric Light  
Plants, Power Plants, Pumping Plants.

## PATENTS PROMPTLY SECURED

We solicit the business of Manufacturers,  
Engineers and others who realize the advisability  
of having their Patent business transacted  
by Experts. Preliminary advice free. Charges  
moderate. Our Inventor's Adviser sent upon re-  
quest. Marion & Marion, Reg'd., New York Life  
Bldg, Montreal; and Washington, D.C., U.S.A.

## RODERICK J. PARKE

A.M. AMER. INST. E.E.  
A.M. CAN. SOC. C.E.

**CONSULTING ENGINEER**

Janes Building, - TORONTO  
Long Distance Telephone.

**TO MANUFACTURERS:**— Advice and speci-  
fications covering Industrial Applications of Elec-  
tricity—Lighting—Power Transmission—  
Factory Power Distribution—Steam  
Plants.

TESTS—REPORTS—VALUATIONS.

## Keystone Engineering Co.

Limited

129 Bay Street, TORONTO, CAN.

Consulting and Contracting Electrical Engineers  
Complete Power Plants Designed and Equipped.  
National Electric Code Standard Wiring.  
Advisory Reports. Repairs, Alterations, Etc.  
Phone, Main 3021.

## ROBERT W. HUNT & CO.

*Bureau of Inspection, Tests and Consultation.*

66 Broadway, New York; 1121 The Rookery,  
CHICAGO; Monongahela Bank Bldg., PITTSBURGH;  
Norfolk House, Cannon St., E.C. LONDON.  
Inspection of Rails and Fastenings, Cars, Loco-  
motives, Pipe, etc.; Bridges, Buildings and other  
Structures. Chemical and Physical Laboratories.  
Reports and estimates on properties and processes.

## PATENTS

TRADE MARKS, Etc.

**HANBURY A. BUDDEN**

NEW YORK LIFE BUILDING,  
MONTREAL.

## NEFF & POSTLETHWAITE

*CHARTERED ACCOUNTANTS*

26 Wellington St. East, TORONTO  
Phone Main 1880.

Audits and Investigations a Specialty.

## S. V. Huber & Co. Consulting Engineers

BESSEMER and OPEN HEARTH  
STEEL WORKS, BLAST FUR-  
NACES, ROLLING MILLS, STEAM  
and HYDRAULIC MACHINERY,  
ETC. HOOP, MERCHANT and  
CONTINUOUS MILLS.

Ferguson Building, Pittsburg, Pa.

Cable Address: "Huber," Pittsburg

Established 1873. Telephone Main 1889.

## THOMAS HEYS & SON

CHARLES H. HEYS, Manager.

**CHEMICAL and MINING EXPERTS.**

Analyses of all commercial products, etc. Plans  
and reports on mines and mining locations.  
124 Yonge Street, TORONTO, ONT.



*Draughting and  
Designing of  
Special  
Machinery  
Industrial Plants*

14 Leader Lane  
Phone, Main 6035  
TORONTO, ONT.

## H. D. PETRIE

*Barrister, Solicitor, Notary*

Spectator Building,  
HAMILTON, ONT.

Companies Incorporated.  
Commercial Law and Collections.

## S. DILLON - MILLS

*MINING EXPERT*

Mining Properties examined and developed,  
reports furnished. Twenty years experi-  
ence in Furnace and Mining Work.

588 HURON STREET. - TORONTO

## Sprinkler Leakage Insurance

is indemnity paid for losses sus-  
tained by the accidental dis-  
charge of water from installed  
Sprinkler Systems.

Are you insured against  
Sprinkler Leakage Damages?

The  
**Canadian Casualty  
and Boiler  
Insurance Company**

TORONTO

Insures Sprinklers, Boilers, Elevators and all  
Personal and Property Risks.

A. G. C. DINNICK, Managing Director.

Head Offices:  
22-24 ADELAIDE ST. E. and 55 VICTORIA ST.  
Phone Main 4091



THE industrial future of Canada is so pregnant with great possibilities that no manufacturer can afford to permit any loss through leaks in his business—either through such leaks as out-of-date plant or equipment or through bad management in factory or office. The opinion of an expert is often of such value as to make the procuring of it an investment that yields exceptional returns from the start and for all time.

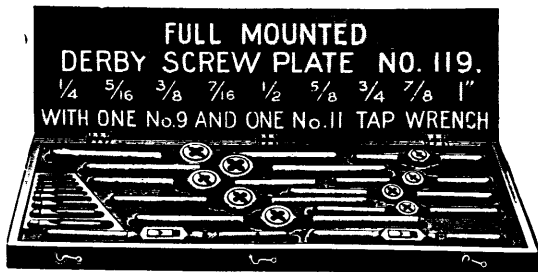

WE MANUFACTURE

STAY BOLT TAPS, all diameters and lengths up to 94 inches.  
SPINDLE STAY BOLT TAPS and TAPS for Screw  
Machines, and TAPS for all uses.

Regular and Full Mounted Reece and Derby Plates, Bicycle  
and Machinists' Plates, etc., etc.

**BUTTERFIELD & CO.,**  
Rock Island, Que.

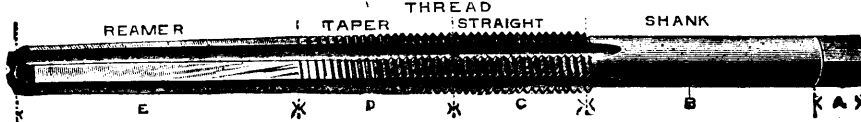

# ELK FIRE BRICK CO.

ST. MARY'S, PA.

Best Fire Brick for Any Purpose.

There are none "just as good."

# DUNBAR FIRE BRICK CO.

Manufacturers of High Grade FIRE CLAY and SILICA BRICK for Heating and Malleable  
Iron Furnaces, Glass Works, Cement Works—also Bee Hive and By-Product Coke  
Ovens, Brick and shapes of all kinds.

Pittsburgh Office : 1504 Arrott Building.

Office and Works : Dunbar, Pa.

Best Grades of  
Steam and  
Blacksmiths' **COAL**  
BEST GRADES OF FOUNDRY COKES  
Shipments made direct from mines to any  
point in Canada. Write for quotations.  
**The MILNES COAL CO., Limited**  
HEAD OFFICE 79 KING ST. EAST, TORONTO, ONT.

**THE TELEPHONE**  
Is a Companion, Friend and Servant Combined.  
Invaluable for convenience in the household.  
**LONG DISTANCE TELEPHONE SERVICE**  
has no equal for the facility it affords in busi-  
ness life.  
Full particulars as to rates and service at the  
nearest office of the  
**BELL TELEPHONE COMPANY  
OF CANADA.**

# "Beech Creek" FIRE BRICK

STRICTLY HIGH GRADE

MADE ONLY BY

**PENNSYLVANIA FIRE BRICK CO.,**  
BEECH CREEK, PA., U.S.A.

Special Mixtures for use in Rolling Mills,  
Malleable Iron Works, Steel Works, Blast  
Furnaces, Glass Tanks, Cement Kilns  
Locomotive Blocks, and all  
High Grade Uses.

*Difficult Shapes a Specialty.*

Send for Catalogue and Prices.

BRANDS: BEECH CREEK, BEECH CREEK ROOF, BEECH CREEK BUNG.

When writing to Advertisers kindly mention THE CANADIAN MANUFACTURER.

# 5 h.p. For 1 HOUR FOR 1 CENT

This looks impossible but we absolutely guarantee to give it with the best of English Gas Engines and Producers.

*Write for particulars, or better still, come and talk it over.*

**Dominion Henderson Bearings**  
LIMITED  
 785 King St. West,  
**TORONTO ONTARIO**

## POWER HACK SAWS

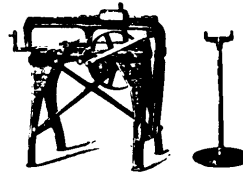

None Faster. None Stronger.  
 None Cheaper.

WRITE FOR PRICES

**KRUG & CROSBY**  
 HAMILTON

Also manufacturers of upright, bench and friction drills, drill chucks, etc.

## Trucks

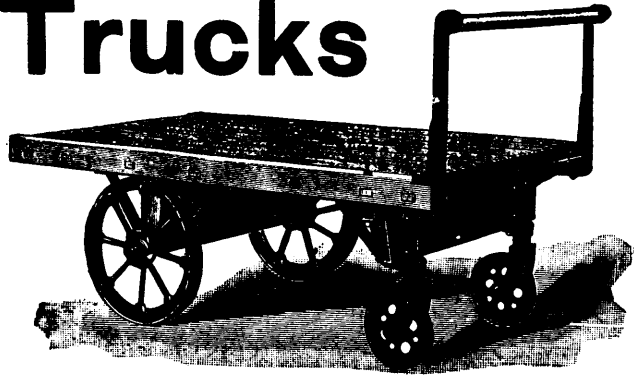

**For Warehouses and Factories**

STEEL FRAMES. WOOD FRAMES.

**ALL** Kinds  
 Styles  
 Sizes  
 Shapes  
 Capacities

**Monteith-Nixon, Limited**

MAKERS OF GOOD TRUCKS

256 Macdonell Avenue,

TELEPHONE

TORONTO

## The Samson Turbine

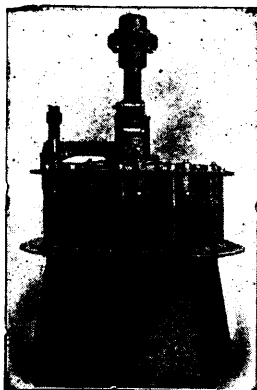

Can be adapted to all water power requirements, and will give the very best results under all conditions.

It is a very strong and durable wheel, and is unequalled for ease of regulation.

Develops more power per inch of diameter than any other wheel, and costs less to install per horse power developed.

Our catalogue tells all about it—send for a copy.

**THE WM. HAMILTON MFG. CO., Limited**

350 Reid St.

Peterborough, Ont.

STRENGTH

POWER

RIGIDITY

PRACTICAL

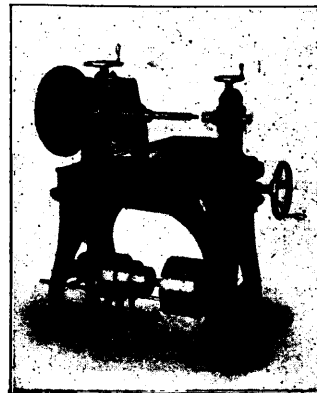

NEW MODEL No. 7—Plain Horizontal Miller

This machine is built to meet the increasing demand for a powerful miller for general manufacturing purposes, and embodies many improvements in power, stability and convenience. It is especially adapted to the manufacture of gun, sewing machine, typewriter and electrical work, bicycle and automobile parts. Write for catalogue. It will pay you.

**BECKER-BRAINARD MILLING MACHINE CO.,**

HYDE PARK, MASS., U.S.A.

Branch Office: THE BOURSE, PHILADELPHIA, PA.

A. R. WILLIAMS MACHINERY CO., Toronto, Can.

Canadian Agents.

## JEFFREY APRON CONVEYER

With Reversible Drive Connections Permits Carrier to Run in Either Direction



For Handling

**Grain, Cotton Bales, Barrels and General Merchandise**

**OTHER ELEVATING, CONVEYING SPECIALTIES**

Illustrated in Chain Catalogue No. 72A. Mailed Free.

CORRESPONDENCE SOLICITED

**THE JEFFREY MFG. COMPANY**

COLUMBUS, OHIO, U.S.A.

NEW YORK CHICAGO BOSTON ST. LOUIS DENVER

Toronto Agents—A. R. WILLIAMS MACHINERY CO.

Montreal " —WILLIAMS & WILSON.

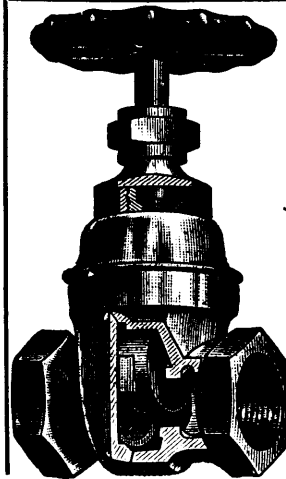

## IF YOU WOULD SAVE MONEY

Pay a few cents more for a good Valve, and save Dollars in Steam-Fitter's bills.

**Buy "KERR" Valves**

and you will find a big saving during the year.

QUALITY COUNTS

**THE KERR ENGINE CO., LIMITED**

Manufacturers

WALKERVILLE, - ONT.

## EXPANDED

The highest type of modern fireproof construction is Concrete reinforced with EXPANDED METAL.

**FLOORS - - ROOFS - - WALLS**

Write for Catalogue and Prices.

**EXPANDED METAL AND FIREPROOFING CO., LIMITED**

100 King Street West, TORONTO.

# METAL

## THE CHEAPEST POWER KNOWN

Pintsch Suction Gas Plants and National Gas Engines.

### PLANTS

- No Smoke
- No Pressure
- No Danger
- No Leakage
- No Gas Holder
- No Noise
- No Boiler
- No Chimney

Engines in sizes from 2 to 800 B.H.P.

Suction Gas Plants in sizes from 10 to 1000 B.H.P. in single generators.

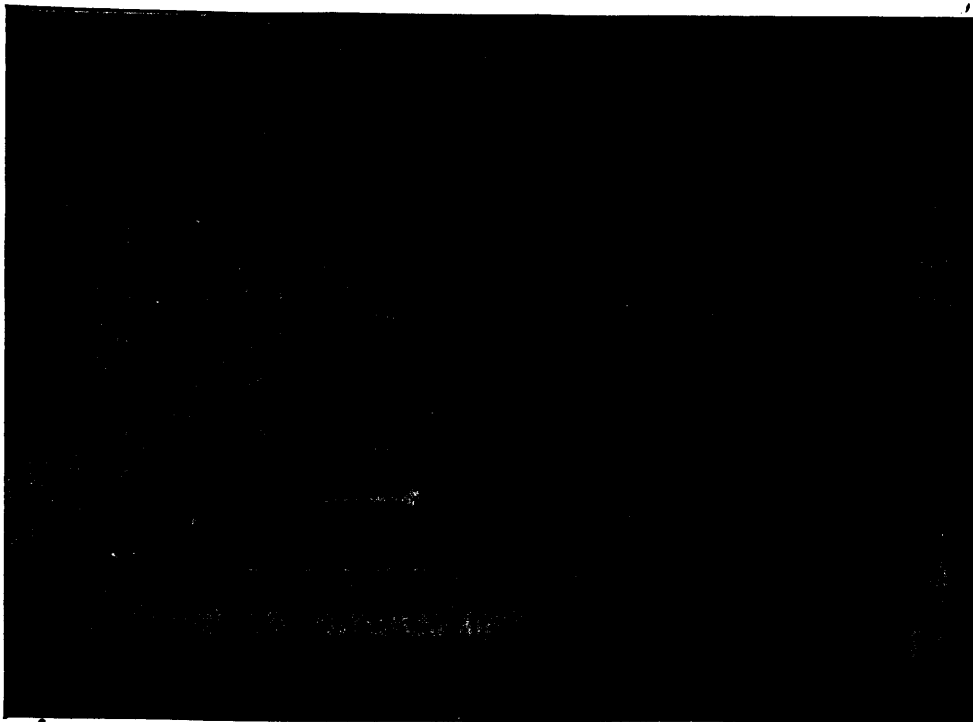

### ENGINES

- Simplest
- Most Durable
- Perfect Regulation
- Small Gas Consumption
- Easy Starting
- No Noise
- Low Cost
- Loose Links
- Vertical Ball Governors

Total Power already installed, over 200,000 B.H.P.

Send for Catalogue and Prices.

**THE ECONOMIC POWER, LIGHT & HEAT SUPPLY CO., Limited,**

**40 YORK STREET, TORONTO**

When writing to Advertisers kindly mention THE CANADIAN MANUFACTURER.

## Dependable Power For Your Factory

**T**HERE is no better power available.  
No more economical, steady and dependable power.  
No power that will increase the capacity and decrease the cost of production so effectually, as that afforded by an

### I.H.C. Gas and Gasoline ENGINE

Any man of ordinary intelligence can run an I.H.C. gasoline engine without previous experience.

We would like to show you how much more simple they are than any other engines made—how much more easily they are operated and kept in perfect running order, and why they develop more power from the same amount of fuel.

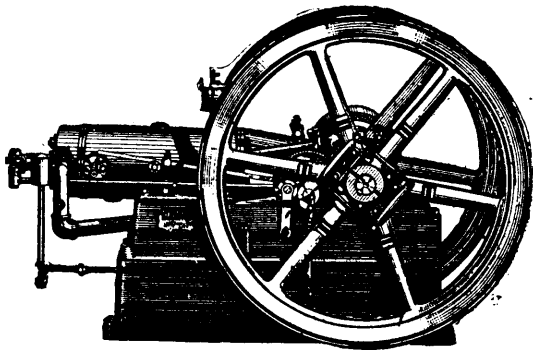

We illustrate and explain these points and every other detail in our complete catalogue. Every man who uses power or contemplates installing it ought to get this book.

You will find that the I.H.C. line of engines includes just the style and the size best suited to your requirements.

Guaranteed to develop rated horse power. Adapted to the use of Gasoline, Gas or Denatured Alcohol.

#### HORIZONTAL ENGINES:

Stationary, 4, 6, 8, 10, 12 and 15 H.P.  
Portable, 6, 8, 10, 12 and 15 H.P.  
Vertical, 2, 3 and 5 H.P.

**SEND FOR THE CATALOGUE TO-DAY.**

## International Harvester Co.

of America  
(INCORPORATED)

7 GG MONROE ST.

CHICAGO, ILL.

## THE FAMOUS McVICKER

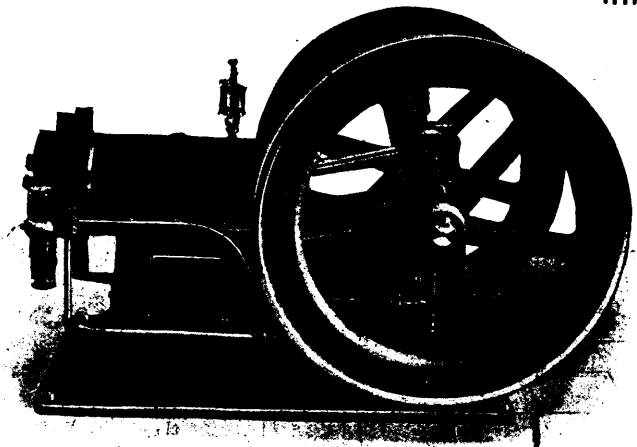

¶ One-third the number of parts.

¶ The only four-cycle engine that will run either way.

¶ The only improvement in gas engines for forty years.

¶ Governor ten times as sensitive as any other.

¶ No gears, cams, eccentrics or trigger work of any kind.

THE  
Canadian McVicker Engine Co.

Limited

GALT

ONTARIO

# THE PETER HAY KNIFE CO., Limited



GALT, ONT.

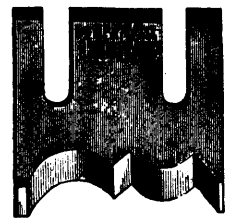

Manufacturers of

## MACHINE KNIVES

For WOOD-WORKING,  
PAPER CUTTING and LEATHER SPLITTING  
MACHINES,

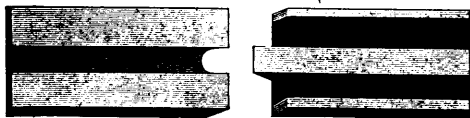

Quality Warranted.

Send for Price List.

SHEAR BLADES,

BARK and RAG KNIVES,

Etc., Etc., Etc.

# The A. R. Williams Machinery Co.,

LIMITED MANUFACTURERS  
IMPORTERS AND DEALERS

TORONTO



—IN—

Engines, Boilers  
Iron Machinery  
Tools  
Wood-Working  
Machinery

—AND—

GENERAL MILL  
MACHINERY and  
SUPPLIES

Write for.....

CATALOGUE and  
QUOTATIONS

OUR NEW BELL PATENT HIGH SPEED AUTOMATIC ENGINE

# BABBITT METAL

PURCHASED FROM

# SYRACUSE SMELTING WKS.

is guaranteed to give entire satisfaction.

## Advise us

your requirements of solder, type metal, ingot copper, ingot brasses, spelter aluminum, antimony, pig tin, pig lead, nickel, phosphor tin and bismuth.

**Toronto Office and Warehouse 87 Jarvis Street**  
MONTREAL and branches NEW YORK

When writing to Advertisers kindly mention THE CANADIAN MANUFACTURER.

# Canadian National Exhibition

1906

of Toronto

1906

**AUG. 27th**  
**SEPT. 10th**

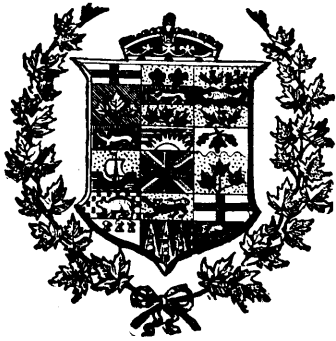

**Entries Close**  
**August 4th**

## TWENTY-EIGHTH ANNUAL

**T**HE National Show of Live Stock, Agricultural and Horticultural Products, Art and Manufactures. Processes of Manufacture are an educational Feature of the Exhibition—demonstrating the progress of Canadian Manufactures. Special inducements are offered to Exhibitors for displays in this department. Correspondence requested. **ADVANCEMENT AND IMPROVEMENT IN EVERY DEPARTMENT**

**BAND OF THE 2ND LIFE GUARDS** (acknowledged to be one of the finest military musical organizations in the United Kingdom) will give two concerts daily.

**BRILLIANT SPECTACLE EVERY EVENING** taken from Sir Walter Scott's most picturesque work, **IVANHOE**. With Tilting tournament and gorgeous pageants.

### SPECIAL EXCURSIONS AND LOW RATES ON ALL LINES OF TRAVEL

For Price Lists, Entry Blanks and all Information Address

**J. A. MCGILLIVRAY, Lieut.-Col.,**  
President.

Office:  
City Hall, Toronto.

**J. O. ORR,**  
Manager and Secretary.

# CROCKER-WHEELER COMPANY



ALTERNATING CURRENT GENERATORS.

Outputs—Belt Type, 25 K.V.A. up.

Engine Type, 75 K.V.A. up.

Canadian Representatives

**THE PACKARD ELECTRIC CO., Limited**

MONTREAL.

ST. CATHARINES.

WINNIPEG.

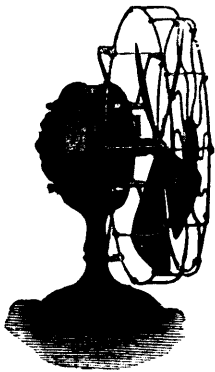

# FAN MOTORS

ALL STANDARD TYPES AND SIZES, IN ANY FINISH

**LARGE STOCK**

QUICK DELIVERY OF ORDERS PLACED AT ONCE.

**Canadian General Electric Company, Limited**

Head Office, TORONTO, ONT.

DISTRICT OFFICES - Montreal.

Halifax.

Ottawa.

Winnipeg.

Vancouver.

Rossland.

## EUGENE F. PHILLIPS ELECTRICAL WORKS

MONTREAL - CANADA - TORONTO LIMITED

### Bare and Insulated Electric Wire

Electric Light Line Wire, Incandescent and Flexible Cords,

### Railway Feeder and Trolley Wire

Americanite, Magnet, Office and Annunciator Wires,  
Cables for Aerial and Underground Use.

LONG DISTANCE PHONE 1108.

The Electrical Construction Company of London, Limited

32-40 Dundas St., London, Can.

Perfection  
TYPE

## DYNAMOS and MOTORS

Multipolar or Bipolar, Direct-Connected or Belted.

OVER 1500 OF OUR MACHINES  
IN USE.

We contract for complete installations, including wiring of factories.  
We repair machines of any make.

Descriptive matter and estimates furnished on application.

Branches at Vancouver, Winnipeg, Toronto, Montreal, Halifax

## TELEPHONES OF EVERY DESCRIPTION



Telephone and Line  
Supplies

**JOHN FORMAN**

708 and 710 CRAIG ST.

**MONTREAL, QUE.**

## TORONTO and HAMILTON ELECTRIC CO.

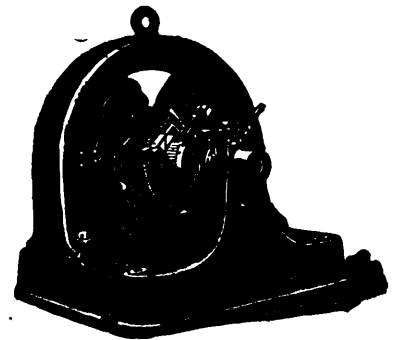

## MOTORS and DYNAMOS

MODERATE and SLOW SPEED OF HIGH EFFICIENCY.  
EITHER BELTED OR FOR DIRECT CONNECTION.  
REPAIRS PROMPTLY EXECUTED ON ALL  
ELECTRICAL APPARATUS.

**T. & H. ELECTRIC CO.**

99-103 McNAB N., - HAMILTON, ONT.

## The Jones & Moore

ELECTRIC CO., Limited

ELECTRICAL CONTRACTORS

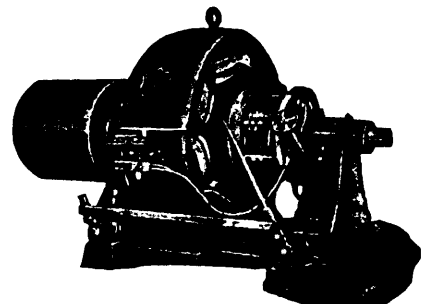

DYNAMOS, TELEPHONES, SLOW  
SPEED MOTORS, MOTORS, SUPPLIES,  
DIRECT CONNECTED DYNAMOS.

We manufacture Direct Current Machinery in  
all sizes and for any purpose.

**196 ADELAIDE WEST,  
TORONTO.**



# How Much of Your Power is Wasted ?

¶ During 1895-96 a series of experiments were conducted by Prof. C. H. Benjamin, of Cleveland, Ohio, to determine the ratio of the power required to drive shafting and belts, to the total power consumed, in 12 manufacturing plants on both light and heavy work. ¶ The results were as follows :

T A B L E S

Manufacturing Plant Number.	Total Horse-Power.	Horse-Power to drive Shafting.	Per Cent. to Drive Shafting.	Manufacturing Plant Number.	Total Horse-Power.	Horse-Power to Drive Shafting.	Per Cent. to Drive Shafting.
1.....	400	157	39.2	7.....	40.4	20.7	51.2
2.....	74	57	77	8.....	74.3	40	53.8
3.....	38.6	25.3	65.6	9.....	47.2	24.5	51.8
4.....	59.2	47.9	80.7	10.....	190	108	56.9
5.....	112	64	57	11.....	107	74.5	69.7
6.....	168	91	54.2	12.....	241	114	47.3
Average, heavy machine work,	....	....	62.3	Average, light machine work,	....	....	55.1

**75 per cent. saving is what we guarantee on shaft friction.**

Over 200 of the leading Canadian factories are equipped with Chapman Double Ball Bearings.

**Send for Catalogues and Letters from Manufacturers who have them in use.**

**THE CHAPMAN DOUBLE BALL BEARING CO. OF CANADA, LIMITED**

Office—89 Scott St., Factory—89 Pearl St., TORONTO.

# The Best Value <sup>ever</sup> offered in Forges

**O**UR "specials" have won such popularity that we have a few more to offer. Here's one of the best—the Petrie portable forge. Every contractor, every bridge builder, every manufacturer having a repair shop or a blacksmith shop, every saw mill, every planing mill in Canada should have one of these. Note the price.

**The Petrie Portable Forge, \$7.00**  
(CASH WITH ORDER)

and it's a first-class forge. Weight, 110 lbs.; diameter of fan, 8 inches; diameter of hearth, 18 inches; height to top of bowl, 32 inches. Send in your order to-day—we will send you the forge at once.

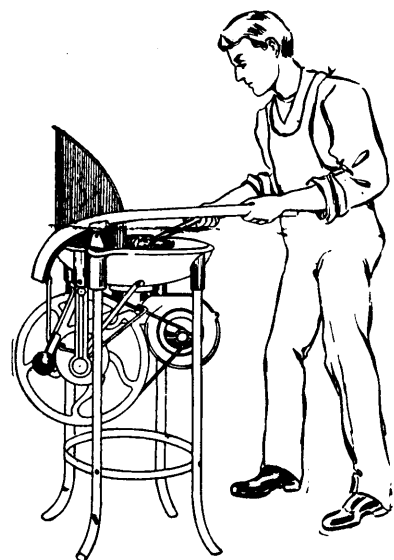

**MACHINERY HEADQUARTERS**

**H. W. PETRIE** Front Street West, Toronto  
St. James Street, Montreal



ESTABLISHED IN 1890.

PUBLISHED ON THE FIRST AND THIRD FRIDAYS OF EACH MONTH

**The Canadian Manufacturer Publishing Co., Limited.**

McKinnon Building, Cor. Melinda and Jordan Sts., Toronto.

Cable address: "CANAMAN." Western Union Telegraphic Code used.

**SUBSCRIPTIONS:**

Canada and United States \$1.00 per year. All other Countries in Postal Union ten shillings sterling, including postage.

J. J. CASSIDEY, - - - Editor.  
D. O. McKINNON, - - - Business Manager.

Classified Index .....Page 42  
Index to Advertisers .....Page 49

**NEW ADVERTISERS IN THIS ISSUE:**

- A. Berg & Sons, Toronto.
- Canadian McVicker Engine Co., Galt, Ont.
- H. Dickenson, Toronto.
- Dominion Henderson Bearings Co., Toronto.
- A. Fleishhacker & Co., San Francisco, Cal.
- The Goldschmidt-Thermit Co., Montreal.
- International Harvester Co., Chicago, Ill.
- Krug & Crosby, Hamilton, Ont.

**CANADA'S FOREIGN TRADE IN 1906.**

The foreign trade of Canada for the year ending June 30, 1906, was five hundred and fifty-two million dollars, an increase of nearly eighty-two millions over the previous year. This illustrates the great prosperity which exists and the marvellous development which has taken place all over the Dominion. The great increase in trade is not confined to any one particular branch, but is general. The imports entered for consumption amount to \$ 90,342,408, an increase of \$28,450,937 over 1905. Exports of domestic produce amounted to \$245,483,956, which is \$44,529,010 in excess of the fiscal year 1905. There was also an excess for the year of about nine millions in the exports of foreign produce. Taking the trade of Canada by decades since 1876 the following is the result:

1876.....	\$174,176,781
1886.....	189,675,875
1896.....	239,025,360
1906.....	552,000,000

The exports of Canadian farm produce were \$120,518,297, as compared with \$93,331,608 for the previous year, an increase of \$27,186,689. The forest gives an increase of five millions, the fisheries five millions, and manufacture three-and-a-half millions.

	1905.	1906.
Imports for consumption, dutiable goods.....	\$150,914,668	\$173,027,710
Free goods.....	100,688,332	110,236,095
Coin and bullion.....	10,708,435	7,078,603
<b>Totals</b> .....	<b>\$261,911,435</b>	<b>\$290,342,408</b>
Duty collected.....	42,021,386	46,668,259

Exports domestic product—

The mine .....	\$31,932,329	\$35,469,631
The fisheries .....	11,114,318	16,025,840
The forest .....	33,235,683	38,824,170
Animals and their produce..	63,337,458	66,455,960
Agriculture .....	29,994,150	54,062,337
Manufactures .....	21,191,333	24,561,112
Miscellaneous .....	49,675	84,906

Total .....\$190,854,946 \$255,483,956  
Exports of foreign produce.. 12,461,926 21,102,674

For the month of June the imports for home consumption amounted to \$32,920,981, an increase of \$4,284,175. There was an increase of the exports of domestic produce of \$2,495,162, and of \$886,236 in foreign.

**MR. GRIGG AND HIS MISSION.**

The Shareholder notes with approval that the Commercial Department of the British Board of Trade has sent a Commissioner to Canada to ascertain by direct enquiry the extent and degree of the effectiveness of foreign competition with British trade in Canada, the best means of successfully combatting the same, and the opportunities which may exist for the further development of the trade of the United Kingdom. It says that such a mission has a grand field of operations, the results of which will bring under the consideration of British manufacturers information of which they have long been in need, and that is how to cater for the Canadian market. Heretofore, it says, the productions in many lines made by the British manufacturers have not been entirely suited to the requirements of Canada, and the information which will be furnished will enable British manufacturers to become thoroughly acquainted with what is actually needed. That done, no doubt a much larger volume of trade will be the result. This country, the Shareholder tells us, desires that Great Britain's trade with it should receive a preference over that of other countries—that if this can be accomplished, taking into consideration our British preferential tariff, the wisdom of the step taken by the British Board of Trade, will be realized and appreciated.

Perhaps so. Unfortunately, however, for British manufacturers who are more or less willing to enlarge their Canadian trade, in many lines now being rapidly reduced to the vanishing point, instead of themselves getting a move on, and applying such methods as have enabled their American competitors, to a large and increasing extent, to drive them out of the Canadian market; instead of themselves coming to Canada and making personal inspection of the prevailing conditions, they allow their Board of Trade to undertake the matter for them. No doubt Mr. Richard Grigg is a most estimable gentleman, and for the time he may be in Canada he will be edified at the words of wisdom that he may hear at the festivities that may be accorded him by the professional after-dinner speakers of the Manufacturers' Association and other similar bodies; but what will all that amount to? No doubt he will be brought in contact with some of the many thousands of Canadian

Manufacturers who compose that body who will tell him that Chamberlainism, preferential trade and an Imperial Zolverin is just the thing, and when he leaves our shores, via New York, as he came, he will possess no more practical knowledge of the matter he is here to investigate than before he came.

The solvement of the question cannot remain with Mr. Grigg. All he can do is to discover facts, and report them to those in whose interests he came, and it will be for them to "wake up" as advised by the Prince of Wales, and apply the remedy. It is not worth the expense of his trip to Canada to learn facts which he no doubt could have found ready at hand in any public office or library anywhere in his own country—we refer to the Blue Books published by the Dominion Government, which contains annual statements of the trade of the country. No doubt now that Mr. Grigg is in Canada the obliging officers in the Department of Finance, or of Trade and Commerce, would have pleasure in handing him all the statistics necessary to enlighten him in the facts he seeks.

It was in this direction that in a recent issue of this journal—that of October 6, last, was published a tabulated classified statement showing in detail the values of 250 different manufactures of dutiable merchandise imported into Canada during the fiscal years 1904 and 1905, and the duties imposed thereon by the general tariff, a rebate of 33⅓ per cent. being allowed upon goods made in Great Britain, and similar statements were also shown giving in detail the values of 104 different non-dutiable semi-manufactured and raw products of similar character imported in the same years, indicating the source of origin of what, to Canadian manufacturers, are their raw materials. There are no official facts available for a later date than those of 1905, and we have much pleasure in reproducing a summary some of them for that year for the edification of Mr. Grigg and British manufacturers generally. They were compiled from Canadian Blue Books.

#### 1.—IRON AND STEEL AND MANUFACTURES OF—57 ITEMS

	Great Britain under Preferential Tariff.	United States under General Tariff.
1905	\$2,717,941	\$18,568,016
2.—BRASS AND COPPER AND MANUFACTURES OF—8 ITEMS.		
"	\$98,237	\$684,482
3.—HARDWARE—36 ITEMS.		
"	\$575,433	\$3,430,916
4.—METALS AND MANUFACTURES OF—19 ITEMS.		
"	\$162,566	\$813,033
5.—ELECTRICAL MACHINERY AND APPLIANCES—7 ITEMS.		
"	\$28,380	\$3,080,827
6.—FUELS—3 ITEMS.		
"	\$116,996	\$8,271,850
7.—CLAYS, ETC., AND MANUFACTURES OF—11 ITEMS.		
"	\$214,721	\$1,462,052
8.—MINERALS—12 ITEMS.		
"	\$27,303	\$1,618,099

9.—PAINTS, PIGMENTS AND COLORS—9 ITEMS.		
1905	\$245,372	\$719,873
10.—AGRICULTURAL IMPLEMENTS—21 ITEMS.		
"	\$18,971	\$1,721,989
11.—VEHICLES—15 ITEMS.		
"	\$21,098	\$1,506,726
12.—MUSICAL INSTRUMENTS—6 ITEMS.		
"	\$14,935	\$324,415
13.—PAPER AND MANUFACTURES OF—14 ITEMS.		
"	\$508,206	\$2,148,431
14.—LEATHER AND MANUFACTURES OF—7 ITEMS.		
"	\$280,476	\$1,546,235
15.—MISCELLANEOUS—25 ITEMS.		
"	\$353,828	\$3,461,955
	<u>\$5,384,471</u>	<u>\$49,358,897</u>

The value of all merchandise imported into Canada for home consumption from Great Britain in 1905 was

Under General Tariff.....	\$5,895,951
" Preferential Tariff.....	38,444,668

Total dutiable.....	\$44,340,619
Free Goods.....	15,243,182

Total dutiable and free.....\$59,583,801

The value of all merchandise imported for home consumption from the United States in 1905 was—

Dutiable.....	\$78,797,440
Free.....	83,941,131

Total.....\$162,738,571

These are the facts which we submit to the attention of Mr. Grigg. The application to be observed by British manufacturers consists in making goods as the Yankees do, adapted to the requirements of Canadian consumers, sell them at as reasonable prices, push the business and advertise them as liberally. There is no other way to keep up with the procession.

#### DENATURED ALCOHOL.

A great deal of misunderstanding exists in Canada regarding the freer use of denatured alcohol in the arts, sciences, and in manufacturing and industrial operations. The conditions are different in Canada from what they are in the United States and some other countries, having reference to the control by the Department of Inland Revenue over the traffic in alcoholic productions. In the United States the law in that matter, passed on May 24 last, provides that on and after January 1 next domestic alcohol of such degree of proof as may be prescribed by the Commissioner of Revenue, may be withdrawn from bond for use in the arts and industries, and for fuel, light and power, without payment of internal revenue tax, provided said alcohol shall have been mixed in the presence and under the direction of an authorized government officer, with denaturizing material which destroys its character as a beverage, and renders it unfit for liquid medicinal purposes. The bill does not specify the de-

naturizing materials, but wood alcohol is generally used in that country; wood alcohol and some other substances being used in Germany, France, and other European countries.

There is a general desire in Canada that, to enable the use of denatured alcohol in the same manner it is used in other countries for industrial purposes, the restrictions that are placed upon its use shall be removed, and the cost of it reduced to a minimum, so as to enable the people to enjoy its advantages to the utmost; and to obtain further light on the subject, at the request of this journal we are in receipt of a letter from Hon. William Templeman, Minister of Inland Revenue, in which he informs us that there is already in Canada untaxed alcohol for use in the arts and sciences—that this has been the case for very many years. Prior to 1889, he tells us, the manufacture of methylated spirits (denatured alcohol), was carried on in licensed establishments under the supervision of officials of the Department of Inland Revenue. In that year the Government, in order to protect the revenue from fraud, took over the production of the article, and the making of methylated spirits has been conducted by the department in Ottawa ever since. There is no tax whatever on methylated spirits, which, according to his definition, is a combination of wood and grain alcohol.

The prices at which methylated spirits are now sold by the department are \$1.10 per gallon and \$1.50 per gallon, according to grade. The \$1.10 grade is composed of 25 per cent. wood and 75 per cent. grain alcohol; and the \$1.50 grade is composed of 50 per cent. wood and 50 per cent. grain alcohol. The first-mentioned grade is supplied to manufacturers under a bond, and is used in certain lines of manufactures. The second grade is sold to any person without bond.

The Minister, discussing the matter, informs us as follows:

"You will see that the question for solution in Canada is not free alcohol legislation, which we have had for twenty or thirty years, but a process of manufacture that will very materially reduce the price of both grain and wood alcohol, that is, if alcohol is to be brought into general use as a fuel, or in the arts and manufactures. The question is engaging the attention of this department, and, it is to be hoped, if a safe denaturizing agent less expensive than wood alcohol can be procured, that the price of alcohol thus treated would be very materially reduced."

The minister also enclosed with his letter a copy of a circular issued by his Department respecting conditions under which methylated spirits are supplied to the trade. This circular bears date March 20, 1896, and is signed by E. Miall, Commissioner of Inland Revenue. It is as follows:

Methylated spirits of the undermentioned grades, will, from the date hereof, be supplied by this Department under the provision mentioned below:

GRADE No. 1, containing not more than 25 per cent. of wood napha, will be supplied only to varnish manufacturers and other parties engaged in the mechanical

arts holding permits from the Department and having entered into substantial bonds in the sum of two thousand dollars, that the methylated spirits so received by them shall be used solely for the purposes named in their application for a permit, and solely in the premises described in the permit. Applications for permits, which will be issued from this Department, should be made on the printed forms supplied for that purpose, to the Collector of Inland Revenue of the Division in which the business of applicant is carried on, and by him forwarded to the Department for approval. When returned approved the bond is to be executed for the sum of two thousand dollars and transmitted to the Department whence the permit will be issued and forwarded through your office, in order that you may keep a record of the names of those to whom issued. Price as follows: When consigned to points East of Toronto and West of Quebec, both inclusive, \$1.10 per Imperial gallon; when consigned to points beyond Toronto and Quebec \$1.08 per Imperial gallon.

GRADE No. 2, containing not more than 50 per cent. of wood napha will be supplied for burning or other purposes without the issue of a permit and without entering into bonds. Price \$1.50 per Imperial gallon.

All methylated spirits will be shipped in iron drums containing about 80 gallons, except where barrels are specially ordered and shipped at risk of consignee. No claim for loss by leakage will be allowed when methylated spirits are shipped in barrels.

All orders must be for a quantity not less than one barrel, and methylated spirits must be paid for on delivery.

The freight charges on all methylated spirits shipped by the department, are to be borne by the person to whom consigned.

The charge made for packages—bbls. \$3.00, drums \$10.00, will be refunded upon their return, in good order, freight prepaid, to the Departmental Warehouse, 321 Queen Street, Ottawa.

#### DENATURING GRAIN ALCOHOL.

In our preceding editorial re "Denatured Alcohol" is embodied the substance of a most interesting letter addressed to the editor of this journal by Hon. William Templeman, Minister of Internal Revenue, in which we are informed that the manufacture of denatured alcohol in Canada is done only at the laboratory of his department in Ottawa, and that no internal revenue tax whatever is imposed upon it. There are two grades of the article made by the department, consisting of the admixture only of wood and grain alcohol in certain proportions; and the prices at which it is sold to consumers are the same as those mentioned in a circular of the department issued more than ten years ago. The cheaper grade—the charge for which is \$1.10 per gallon, contains 25 per cent. of wood alcohol, and is not available for general use, and is only supplied to certain manufacturers under a bond of \$2,000 that the spirits received by them shall be used solely for the purposes named in their application and solely in the premises described in the permit. This restriction shuts out the use of denatured alcohol in Canada in the hundreds of purposes to which it is so generally put in other countries. We are pleased to note, however, that Hon. Mr. Templeman intimates that the government has in contemplation some possible relief in this direction. The other grade of which he speaks,

the purchase of which is unrestricted, is sold at the higher rate of \$1.50 per gallon, which constitutes a barrier to its general use much more onerous than the lower-priced article. We notice that the New York Commercial quotes the price of wood alcohol at about 70 cents per standard gallon in that market.

The Minister speaks of a safe denaturizing agent less expensive than wood alcohol which, if it can be procured, would alleviate the situation. It is to be wished that it may be discovered, and in the meantime it is interesting to know the methods now in use in Germany that makes denatured alcohol available in the industries in that country, which we find described in the Scientific American. It says :

For industrial purposes, and to render alcohol impossible of consumption as a beverage, the spirit may be either methylated or denatured. Methylated means the addition of wood alcohol (methyl alcohol) to the spirit (ethyl alcohol). Wood alcohol is a poisonous substance, and at the same time possesses an extremely disagreeable taste, which renders it im potable. The denaturization of alcohol signifies the addition of such substances other than, or together with, wood alcohol, which renders the ethyl alcohol unfit for use as a drink. The following are some German methods of rendering alcohol im potable:

I. Complete denaturization is accomplished by the addition to every 100 liters (equal to 26½ gallons) of spirits :

(a) Two and one-half liters of the "standard denaturizer," made of four parts of wood alcohol, one part of pyridin (a nitrogenous base obtained by distilling bone oil or coal tar), with the addition of 50 grammes to each liter of oil of lavender or rosemary.

(b) One and one-fourth liters of the above "standard" and two liters of benzole with every 100 liters of alcohol.

Of alcohol thus completely denatured there was used in Germany, during the campaign year 1903-4, 931,406 hectoliters denatured by process (a), as described above, and 52,764 hectoliters which had been denatured by process (b). This made a total of 26,080,505 gallons of wholly denatured spirits used during the year for heating, lighting, and various processes of manufacture.

II. Incomplete denaturization—i.e., sufficient to prevent alcohol from being drunk, but not to disqualify it from use for various special purposes, for which the wholly denatured spirits would be unavailable—is accomplished by several methods as follows, the quantity and nature of each substance given being the prescribed dose for each 100 liters (26½ gallons) of spirits:

(c) Five liters of wood alcohol or one-half liter of pyridin.

(d) Twenty liters of solution of shellac, containing one part gum to two parts alcohol of 90 per cent. purity. Alcohol for the manufacture of celluloid and pegamoid is denatured.

(e) By the addition of one kilogramme of camphor or two liters of oil of turpentine or one-half liter benzole to each 100 liters of spirits. Alcohol to be used in the manufacture of ethers, aldehyde, agaricin, white lead, bromo-silver gelatins, photographic papers and plates, electrode plates, collodion, salicylic acid and salts, aniline chemistry, and a great number of other purposes is denatured by the addition of—

(f) Ten liters sulphuric ether, or one liter of benzole, or one half liter oil of turpentine, or 0.025 liter of animal oil.

For the manufacture of varnishes and inks alcohol is, denatured by the addition of oil of turpentine or animal oil, and for the production of soda soaps by the addition

of one kilogramme of castor oil. Alcohol for the production of lanolin is prepared by adding five liters of benzine to each hectoliter of spirits.

The whole amount of incompletely denatured alcohol of the several grades above described which was consumed in Germany last year was 385,946 hectoliters, equal to 10,227,569 gallons. In addition to all the foregoing, 21,779 hectoliters of alcohol were used duty free and without denaturization of any kind for governmental or public purposes, such as hospitals, government laboratories, and for the manufacture of fulminates and smokeless powder.

#### EDITORIAL NOTES.

The Canadian government have adopted the following rules governing the entry and appraisal of architects' plans:

Rates of duty on drawings, blueprints, and building plans, 20 per cent. ad valorem. Specifications, however, are free as "manuscript" when written of typewritten. Special plans of building or blueprints as substitutes, therefore, are to be valued for duty at charge usually made by architect for drawings without specifications. This charge may be fixed for duty purposes at one per cent. of estimated cost of building to be erected. Detailed drawings or blueprints as substitutes therefore, if imported separately, are to be appraised at valuation of one per cent. of estimated cost of such detail. When building is estimated to cost less than \$10,000, plans or blueprints thereof may be appraised, at usual charges for furnishing same, according to the special circumstances in each case, irrespective of the preceding rule. Blueprints or copies of building plans may be admitted at cost of production when duty has been once paid on original or copy in Canada. Blueprints of cars and machinery, being copies of standard designs, may be valued for duty at 75 cents per pound.

A number of large buildings in this locality are designed by American architects, the same being true of other parts of Canada. No doubt they will be called upon for further plans, especially for large buildings of modern construction, and the order will therefore be of interest to them.

In business circles there seems to be a misunderstanding in regard to the agreement reached by the Universal Postal Congress recently held at Rome, Italy, and the date fixed for making effective the postal changes decided upon. The convention fixed the international prepaid letter rate at 25 centimes (5 cents) for the first weight of 20 grams (about two-thirds of an ounce) and 15 centimes for each additional 20 grams; but any country which for good cause is unable to carry this stipulation into effect upon the date fixed by the convention for making it effective may postpone it temporarily, and meanwhile continue the present rate of 25 centimes for each 15 grams. Also those countries which have not adopted the metric system of weights are allowed to substitute for 20 grams the ounce avoirdupois as the unit of weight. No change has been made in the postage rates applicable to articles other than letters. The convention will not go into operation until October 1, 1907.

The regulations under the Australian Trade Marks Act are somewhat elaborate and complicated. Those relating to the workers' mark are most important. Such a mark may be registered for 14 years by an Australian worker or an association of Australian workers, corporate or incorporate, showing that the goods are "manufactured under conditions as to remuneration of labor described, required, or provided by an industrial award, order, or industrial agreement, or industrial law under which they are made." The place of manufacture is also to be given, together with other particulars. This means the legalization of the union label, and will be used as a means of boycotting non-union made goods.

Mr. Richard Grigg, the Commercial Commissioner appointed by the British Government to visit Canada, arrived in this country a few days ago. It would have perhaps been a happier augury had he chosen the St. Lawrence route of travel, which he did not do. He will spend some seven months in various Canadian centres investigating the reasons for the greater success of the foreign competitors of the United Kingdom in the Canadian market, and what steps British traders might take in order eventually to meet this competition. He will also seek to ascertain the effect on British trade of (1) shipping rings or conferences, (preferential railway and shipping rates), (2) bounties, (3) systems of payment for goods on credit, (4) false marking of foreign goods, and (5), the system of consular reports and statistics. It will be part of his duty to select correspondents for the Board of Trade. He is instructed to exercise the greatest care in selecting these gentlemen, and he has to supply the reasons which satisfy him as to their suitability.

The Executive Council of the Canadian Manufacturers' Association are requesting an expression of the views of the members of the Association regarding the advisability of organizing within the Association an Employment Department for the purpose of assisting in providing help for members, and employment for those looking for positions. A special committee has been appointed to outline a scheme for organization, maintenance and financing of an office in Great Britain for the purpose of supplying help to manufacturers. The matter will be more fully discussed at the forthcoming convention of the Association in Winnipeg. The move is an excellent one, and it is to be hoped that a workable scheme will be adopted and carried out. If the government cannot see its way clear to assist in the matter, as it does with regard to the bringing in of laborers to supply agricultural and domestic wants, the Association is itself abundantly able to establish and carry on an agency in Great Britain.

The activity of the labor party in Great Britain, and the extraordinary representation and influence it has secured in the present British Parliament are apparently the inciting cause of a movement on the part of British manufacturers to combine to protect their interests. A provisional committee has been chosen, consisting of well-known manufacturers in different industries, who repre-

sent many million pounds of invested capital. The name suggested for the organization is the Manufacturers' Association of Great Britain. Its principal objects are thus summarized:

"To represent to the government and the country the principles, aims and needs of manufacturers; to bring about closer relations between employers and employees; to deal with matters of common interest affecting manufacturers, such as legislation, taxation, rates, etc.; to deal with matters of international interest, such as tariffs, trusts, etc. It is believed that relation between employers and employees will be greatly improved if an attempt be made to show that certain conditions of trade must affect both in similar proportion, that increased prices mean increased wages, that increased competition must lower prices and wages, and that bad trade must bring reduced employment.

"It is felt that the time has come when workmen should be instructed in the economies of production, in questions affecting organization, management of factories, the effect of tariffs and unlimited competition. The relative importance which manufacture bears to the prosperity of the country should also be more generally appreciated, and an effort will be made to show that its encouragement will help more than any other agency in solving the great national problem of the unemployment of labor. A fundamental principle of the association will be that party politics in every form shall be rigidly excluded."

In New York State there are 28,250 automobiles registered, and it is estimated that for the United States the number exceeds 80,000. The annual cost and operation of the New York automobiles are said to aggregate \$30,000,000, from which it is assumed that the entire country spends about \$70,000,000 annually for the delights of motoring. In France, owing to the strikes, the automobile manufacturers have lost a great deal of business, but a British publication asserts that France has been given undue prominence in regard to the manufacture of automobiles, other nations doing just as good work and increasing the production of such machines at a much greater ratio than has been the case in France.

The value of the copper produced in the United States in 1905 was \$137,498,727, as compared with \$105,629,845 in 1904. The product of 1905 was much the largest ever recorded in the United States. Exports of copper to Germany, Holland, and other countries continue to increase. During the month of May 11,072,320 pounds were shipped to Germany, as compared with 6,381,340 pounds in April. Exports to Holland were 14,197,120 pounds in May, an increase of over 1,000,000 pounds as compared with the preceding month. France took 6,948,480 pounds and the United Kingdom 5,125,120 pounds, being a considerable increase over the previous month's shipments. The Michigan mines produced 20,000,000 pounds of refined copper in May, which sold for approximately \$3,760,000. That was the largest output secured in any month since copper was first mined in the Lake Superior region. It indicates an annual production of 240,000,000 pounds, but an even larger product is expected as a result of preparations made by the mine owners to handle a greater output.

## Manufactured Stone and its Relation to Concrete Construction.

BY CHARLES D. WATSON, C.E.,

Paper read before the New York Concrete Association, March, 1906.

Some years have passed since the prophecy was made by one of America's most prominent inventors that the building of the future instead of being constructed of units of different materials that required bonding and framing together would be built of monolithic concrete cast in place by the use of permanent and standard forms. While this prophecy may prove true for some classes of structures, the expert builder, architect and engineer knows too well the limitations of reinforced concrete as a building material to believe that such a method of construction can ever become general. Such conditions could never be tolerated by the architect, duplication of design being the one thing that he abhors. It is indeed this very tendency towards similarity and monotony of appearance of buildings where concrete cement is used for exterior finish whether monolithic or of cement blocks that makes the average architect so antagonistic to the material. While great progress has been made in improving the appearance of the surfaces of structures built of monolithic concrete and while the manufacturers of hollow blocks are rapidly coming to realize that they are making a mistake in trying to imitate stone, especially when rock faced and, with the assistance of the architects in their designs, are learning to treat

use of cement concrete or the ordinary building block is entirely prohibited for exterior finish and the structure is faced with the more common materials such as brick, terra cotta or cut stone.

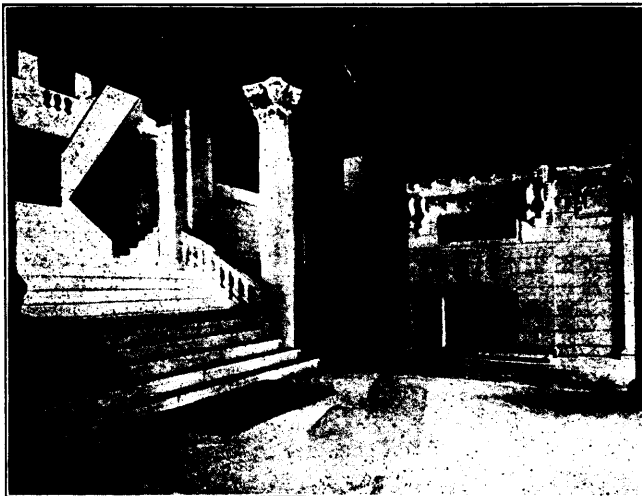

MONTREAL AMATEUR ATHLETIC ASSOCIATION.  
(D. Brown and J. M. Miller, Architects.)

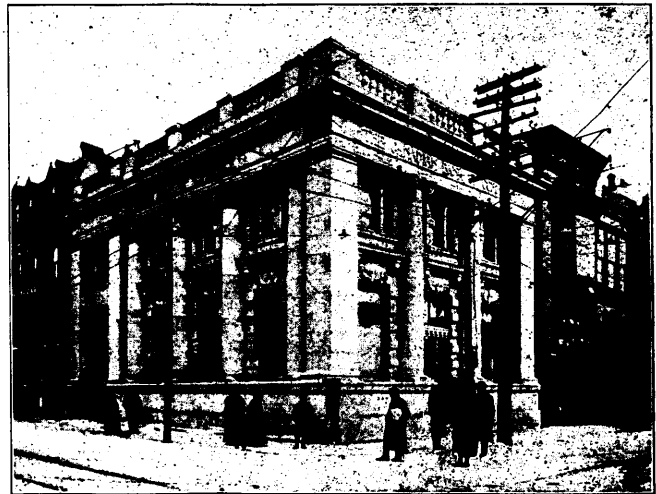

CANADIAN BANK OF COMMERCE, LONDON, ONT.  
(Darling & Pearson, Architects.)

This condition is unfortunate for the welfare of concrete construction. It is well known that good Portland cement concrete is more durable than the majority of the materials heretofore ordinarily used for the exterior facing and it is to be regretted that its appearance prohibits its use for this purpose.

There has been in the last few years a wonderful development in the use of concrete as a structural material. The popularity of this form of construction would seem to indicate that it is going to be the standard of construction for fireproof buildings. Are we then going to be compelled to face these concrete structures with different material similar to the manner we are now compelled to face a steel



RESIDENCE GEO. GALL, TORONTO.  
(R. J. Edwards, Architect.)

the material not as an imitation of stone, but as a new distinct and individual material; yet there undoubtedly still remains much to be desired in the appearance of structures where cement concrete is employed for facing.

How to improve the appearance of structures built of concrete is the greatest problem that confronts the architect or builder who is inclined to its use for exterior work, and in fact this fault of appearance has been the one great impediment in the way of its ultimate victory over all other building materials.

For the majority of the buildings in the larger cities the use of the monolithic wall is practically impossible if its surface is to be exposed to the general view; few of the many methods employed to improve their appearance seem to be satisfactory or if satisfactory not permanent. With the heavier type of masonry construction such as abutments and bridges this difficulty is not so apparent since the environments of structures so built are usually such that the appearance of the monolithic concrete surface is not out of harmony with its surroundings.

In such structures the process of finishing exposed surfaces with tools, acid or water wash or other similar methods in common use often produces quite pleasing and satisfactory results, however, for the majority of structures to which concrete is adapted the condition still remains that if the building requires any architectural merit the

frame building? Certainly not. The appearance of concrete can and will be so improved as to warrant its use for building the whole structure both exterior and interior without the least sacrifice to the architectural merit of the structure. While most wonderful progress has been made in structural design there has also been a great progress made in the processes to improve the external appearances

of this material. This improvement is just as important if not more so than the development of its use as structural material.

That a product can be obtained by the use of Portland cement, sand or crushed stone that will equal in appearance our best building stone seems certain, and from present appearances it is by the use of manufactured stone that this problem is to be solved.

#### WET MIXED CONCRETE IS THE ORDER OF THE DAY.

There has been during the last few years a decided change in the processes used in mixing concrete. Originally it was the theory of all engineers that the amount of water which should be mixed with the cement and aggregate in making mortar or concrete should not be more than enough to thoroughly moisten it. This practice has been entirely reversed, experience having taught that the best concrete is made when gauged with plenty of water, a surplus being always better than a deficiency. Proof of the superiority of wet concrete has become so abundant that to-day it is considered by the best engineers as being the only acceptable method of mixing it. With this change in the manipulation has come the process of manufacturing stone by casting, the cement being mixed with a moderately fine aggregate and enough water added to make the mass run so that it can be cast into absorbant moulds. This method was first used and patented by C. W. Stevens, of Harvey, Illinois, in 1899. The results obtained have been so highly satisfactory as regards density, texture, uniform appearance and color that we are able to say without question that we have at last a method (with the improvements that have been made since the process was invented, especially in the last two years) by which we can manufacture stone which is quite equal in appearance to the original and is in many ways superior to it especially as regards durability and cost.

As man has, by following the conditions required in nature been able to manufacture ice, which is in many ways superior to the natural, so has he by producing conditions similar to what are required in nature been able to manufacture stone, equally as good in appearance as the natural, superior in durability and without the flaws and blemishes found in the natural rock.

The resemblances of the process of manufacturing stone by the wet process to the manner in which natural stone is made is most marked. Geology teaches us that our best building stones, outside of the original rocks, such as granite and gneiss are made by the depositing at the bottom of large bodies of water the fine particles of minerals that are held in suspension. These particles being deposited in strata or beds, which are afterwards cemented together and sometimes altered by the chemical action produced by the heat involved in the enormous pressure of the earth's crust. The processes and methods employed in making cast stone are practically the same, except that the chemical action required to cement the particles is produced in a few hours by the use of our modern highly developed Portland cement while nature has required centuries to produce conditions by which she has brought about practically the same chemical action. In making stone by the wet process the aggregate of crushed stone and cement are mixed with water to such a consistency that separation takes place so slowly that the slightest agitation of the mass keeps the materials properly separated, and then by making the mould into which the material is cast so porous that the surplus water is absorbed almost instantaneously we get substantially the same result as is obtained in nature by depositing the stone in water. It is by the use of this new method that the highest class of cement stone is being made to-day.

#### OLD AND NEW METHODS.

Manufactured stone has been made ever since cement was known, but the principle difficulty has heretofore been in getting sufficient pressure to properly compress the particles. The methods employed to produce density by pounding or pressing the particles together have never resulted in a stone whose specific gravity was over 75 per cent. of the materials used. The result has been a porous product and consequently one that would easily stain and whose durability was questionable. The results obtained by the wet process entirely overcome this. The settling of the particles into the form due to excess of water so closely packs them that when crystallization of the mass is complete, the resulting product has nearly the same specific gravity as the particles themselves, and the mass is absolutely homogeneous. The process of compacting the mass by the wet process is not unlike the practice of flooding a trench with water in order to compact loose earth in refilling.

Like any other manufactured product the quality of the article produced depends largely upon the quality of the materials used and

too much attention cannot be paid to the proper grading and proportion of the ingredients as well as the handling of the cast while setting and hardening is taking place. Cast stone as it is now being made by the leading companies in America is made entirely in sand moulds.

#### DESCRIPTION OF METHOD OF MANUFACTURE AND HANDLING.

The work illustrated in connection with this article was made by the Roman Stone Company of Toronto by this process, only a brief description of which is possible in this paper. The company have in connection with their factory a crushing plant for the crushing and grinding of rock of any color or texture to any size required.

The stone used for making the majority of the work illustrated

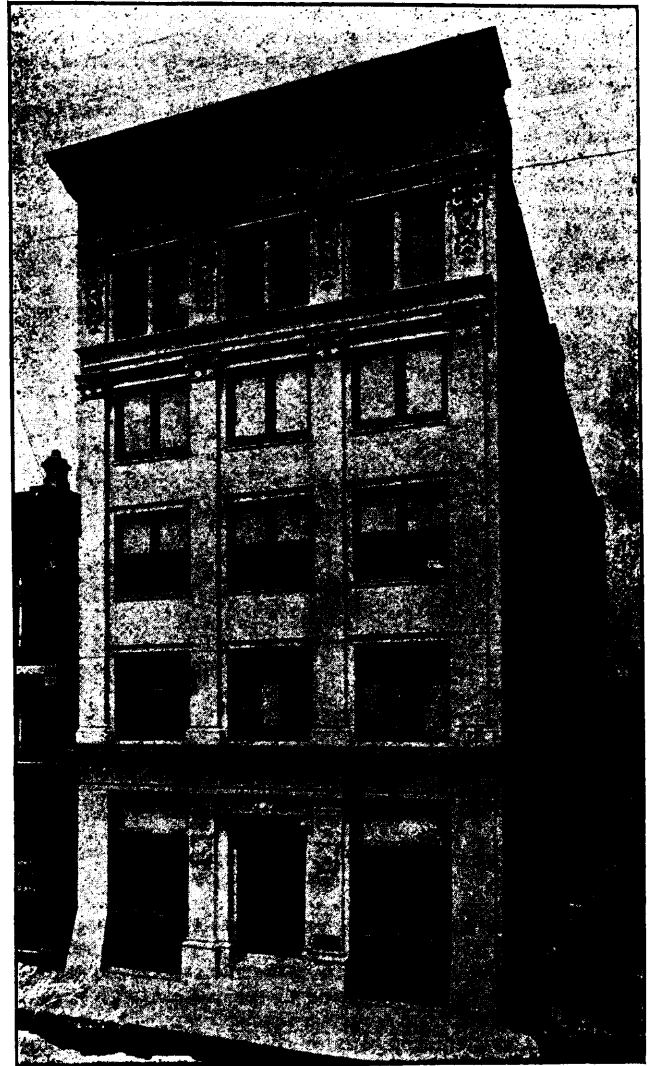

JOHN D. IVEY, WAREHOUSE, TORONTO.  
(H. C. McBride, Architect.)

was a hard, coarse, crystalline limestone of a light gray color, but the company are now making stone from pure white marble. Nothing but carefully selected quarry chippings are used and these are crushed and ground at the factory and carefully screened in three sizes, the largest about the size of a grain of corn. The importance of the proper proportions of the aggregates of stone need hardly be mentioned, being too well-known by the engineer and the cement user to be enlarged upon. Daily granulometric tests of the crusher output are kept to properly regulate the amount of each size obtained from the machines.

#### THE IMPORTANCE OF PROPER PROPORTIONS.

Next in importance to properly graded aggregates is the gauging of the amount of water used in the mixture. This is done by an automatically filled tank into which lead both hot and cold water and in which is fixed a thermometer to properly regulate the temperature. In gauging the mix about 20 per cent. of water is used, but of course



when the cast is made the surplus is immediately drawn off into the sand where it is retained and serves as a wet blanket to protect the cast and supply it with the proper amount of water during crystallization.

The method of handling the mix and casting is quite simple and almost identical with the practice in iron foundries. The mixture is made in a batch mixer to about the same consistency as molasses, from which it is poured into a mechanical agitator and carried about the foundry by a travelling crane. This agitator is so constructed that it keeps the materials in motion constantly and prevents their segregation. In each cast is inserted the proper reinforcing rods, lifting hooks, and tie rods and the casts are allowed to remain for a proper period in the wet sand after they are poured; they are then taken to the seasoning room which is kept at as constant a temperature as it is practical to maintain. Each cast is marked with the number which determines its location in the building and the date it was cast and it is then kept in the storage shed a fixed time before shipping.

Records are kept of each cast made and we are able to get, as in mills rolling structural steel, the exact number and location of all casts made from the same mix. Careful records are always kept of the tests of cement and material, and test cubes are made from each consignment of cement so tested; in this way all danger of defective stone through inferior cement is eliminated. The patterns used in making the moulds and the method of moulding is quite similar to

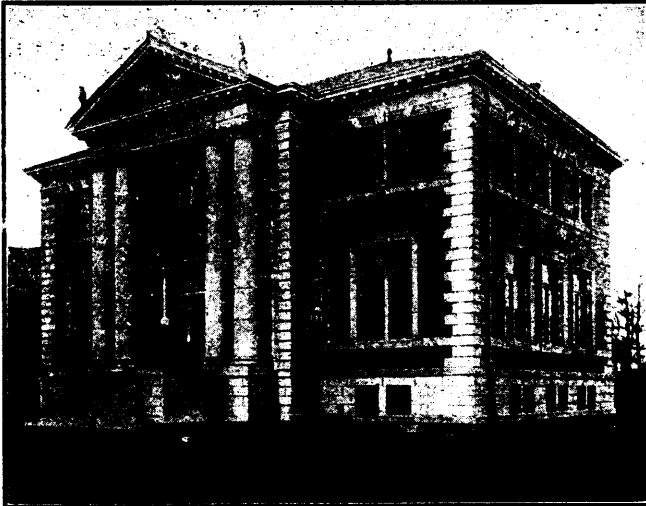

CARNEGIE LIBRARY, ST. CATHARINES.  
(S. R. Badgely, Architect.)

ordinary iron foundry practice except that the sand used is of especial nature. The finish of the stone is generally tooled finish formally moulded in the sand, the different textures of natural stone being produced by the veneering of the pattern with thin strips of wood which are run through a machine producing the different finishes, but now the company are finishing all stone by hand, by which method the exact appearance of cut stone is produced. Each stone is provided with setting hooks cast in the blocks which take the place of the ordinary lewis holes used in cut stone. The handling of the blocks in setting is thus much simplified. Erection diagrams are always furnished for each job showing the location of each piece in the building with the corresponding number on the cast. In this way consignments can be shipped long distances from the factory and erected with perfect ease.

#### HOW MANUFACTURED STONE IS REPLACING NATURAL STONE

Manufactured stone is to-day being used in constantly increasing amounts in place of natural stone, the blocks being made in size and finished to exactly reproduce the original. On account of certain characteristics of the material it is especially adapted for use in combination with reinforced concrete structures, and with the highly perfected manufactured stone now being made we are able to erect the very highest type of building entirely out of concrete, the interior of which will have all the advantages of what is beyond a

doubt the very best fireproof construction, and whose exterior appearance will be equal to and whose durability will be superior to the best natural stone now used.

## As Seen from the Inside.

BY THE  
BUSINESS  
MANAGER.

### STEADY PROGRESS.

Since we announced, some three months ago, that improvements in THE CANADIAN MANUFACTURER were contemplated, we have been much impressed and greatly encouraged by the ready response to our efforts.

Our first improvement was a department in the second issue of each month devoted to "Office Methods and Appliances." This proved at once to be a popular feature and from present indications we expect it to become one of the most valuable departments in the paper.

Then we followed with an increase in the attention given to "Machinery and Engineering," which has, we believe, enabled us to bring our advertisers and our readers into closer touch than would otherwise have been possible. Further extensions will be made to this department.

The next step toward enhancing the value of the paper to its readers was the addition of a department devoted to "Building and Construction." For this department we have several splendid articles in preparation and we hope to make it so valuable that every manufacturer will read it thoroughly to keep in touch with the new ideas in factory, mill and warehouse construction.

At the same time we have improved the quality of paper used and we have carried on a strong subscription campaign which has met with gratifying success. In this issue we are adding four pages to the paper, an increase made advisable by the amount of new advertising which has been secured during the last few weeks.

Thus, the progress has consisted, not in a great splurge but in a steady, persistent pressing toward the goal we desire—to make THE CANADIAN MANUFACTURER of the greatest possible value to the manufacturers in all classes of industry throughout Canada.

For much of the success of our efforts we can thank the readers who have not only read the articles and advertisements but have been good enough to mention the paper in writing to advertisers. This, we feel, increases the responsibility resting on us to continue to improve the paper.

### TO THE HEADS OF THE FIRMS.

Among expert advertising managers the question of quality in circulation is becoming more and more important. One subscriber may be a purchaser to the extent of thousands while others have practically no authority in purchasing.

While we have no apology to make for the "extent" of our circulation, we feel that the more thought given to its "quality" the more the real worth of the paper will be appreciated. THE CANADIAN MANUFACTURER goes to the heads of manufacturing establishments—to the men who have won their way to power and authority, the men who dominate not only their own works but are often the best and safest influence in municipal life, the men who by their industry and progressiveness are the great factor in building up Canada. When any purchases of any consequence is to be made these men insist on being consulted. Therefore their good-will is essential.

These men read THE CANADIAN MANUFACTURER: they respect its editorial utterances, are interested in its news service and are influenced by its advertising pages.

## CAPTAINS OF INDUSTRY.

The following items of information, which are classified under the title "Captains of Industry," relate to matters that are of special interest to every advertiser in these pages, and to every concern in Canada interested in any manufacturing industry whatever, this interest extending to supply houses also.

Mr. B. Muscat, manager of the Syracuse Smelting Works, at Toronto, with office and warehouse at 87 Jarvis Street, informs us that he has been doing a large business for his principals since opening up, particularly in babbitt metal, type metal, solder, ingot copper and phosphor tin. The Syracuse Smelting Works have only recently opened up an office and warehouse in Toronto, and intend putting up one of the most modern smelting manufacturing plants in that vicinity in the near future.

A large hotel will be erected at Fort William, Ont., at a cost of about \$250,000. Those interested include P. J. Manion, G. H. Graham, and T. J. Horn, Fort William.

The ratepayers of Port Hope, Ont., voted favorably on a by-law to exempt the Central Foundry Co. from taxation. The company will improve their buildings at a cost of several thousand dollars, and will commence manufacturing within three months.

The moulding shop of the Hamilton Brass Mfg. Co., Hamilton, Ont., was damaged by fire recently. Loss about \$800.

The Banwell-Hoxie Fence Co., Hamilton, Ont., will erect an addition to their factory at a cost of about \$2,500.

The Peterborough Shovel & Tool Co., Peterborough, Ont., will erect a warehouse, 100x40 feet, at a cost of about \$3,000.

The ratepayers of Norwich, Ont., will vote on a by-law to grant a loan of \$5,000 to Messrs. West, Taylor, Bickle & Co., broom manufacturers.

The McKinnon Dash & Metal Works Co., St. Catharines, Ont., have reduced the amount of their common stock from \$400,000, to \$100,000.

The Brien Heater Co. recently organized at Welland, Ont., have purchased the factory of the Niagara Metallic Furniture Co., Welland, Ont.

J. F. Mills, Buffalo, N.Y., will organize an automobile company at Welland, Ont.

The Verity Plow Co., Brantford, Ont., will erect a three story addition to their warehouse at a cost of about \$3,000.

The Stevens-Hepner Co., Port Elgin, Ont., have been organized with a capital of \$150,000, to manufacture brushes, woodenware, etc. The provisional directors include H. H. Stevens, J. Hepner, Port Elgin, Ont., and C. M. Bowman, Southampton, Ont.

The Petrolia Gas Co., Petrolia, Ont., will erect a gas plant at that place.

The Grand Trunk Railway Co. will erect a power house at Sarnia, Ont.

The T. Eaton Co., Toronto, will erect another factory at a cost of about \$30,000.

The Jamson Avenue Collegiate, Toronto, will be enlarged at a cost of about \$34,500.

The Miller Cartage Co., Toronto, will erect a large warehouse on Dupont Street, Toronto.

The Ottawa Pulp & Paper Co., Ottawa, have been incorporated with a capital of \$25,000, to manufacture paper, cardboard,

etc. The provisional directors include D. Armour, V. E. Mitchell and E. F. Surveyer, Montreal.

The Read Timber & Lumber Co., Ottawa, have been incorporated with a capital of \$1,000,000, to manufacture lumber, timber, doors, furniture, etc. The provisional directors include C. E. Read, W. G. White, and G. A. Perley, Ottawa.

The Arundel Lumber Co., Ottawa, have been incorporated with a capital of \$100,000, to manufacture furniture, doors, sashes, pulp, paper, etc. The provisional directors include G. H. Perley, W. G. White and F. W. Avery, Ottawa.

The German-Canadian Smelting & Refining Co., Toronto, have been incorporated with a capital of \$1,000,000, to carry on a mining, milling and reduction business. The provisional directors include T. E. McCracken, F. F. Philips and J. E. Morden, Toronto.

The Department of Railways and Canals, Ottawa, invite tenders up to August 20, for the construction and delivery of an 80 foot steam tug for the Rideau Canal.

The Toronto Construction Co., Toronto, have been awarded the contract for the construction of the Georgian Bay branch of the Canadian Pacific Railway, which will run from Victoria Harbor to Peterborough via Orillia.

The cheese factory of Messrs. Vanluven Bros., Moscow, Ont., was destroyed by fire, July 21.

It is stated that M. J. Haney, Toronto, has been awarded the contract to build the tunnel under the Detroit River for the Michigan Central Railway Co.

The button factory of the J. B. Gateman Co., Berlin, Ont., was destroyed by fire July 20. Loss about \$9,000.

The Young Woman's Christian Association, Hamilton, Ont., will erect a new building at a cost of about \$50,000.

The Peterborough Steel Rolling Mills, Peterborough, Ont., have been organized with a capital of \$200,000. W. Davidson and A. Elliott are interested.

Messrs. Green, Swift & Co., London, Ont., will erect a three story building at that place.

The congregation of the Centennial Methodist Church, Toronto, will erect a new church building at a cost of about \$30,000.

The Canadian Pacific Railway Co. will build a large dock at Goderich, Ont.

Messrs. Line, McDonald & Co., London, Ont., cigar manufacturers, will erect a large warehouse there.

The National Club, Toronto, will erect a building on Bay Street, at a cost of about \$115,000.

The large cheese factory of Messrs. Holmes & Merkley, near Brockville, Ont., was destroyed by fire recently.

A science building will be erected in connection with McMaster University, Toronto, at a cost of about \$50,000.

The grist mill of Messrs. McCracken Bros., Tiverton, Ont., was destroyed by fire July 20.

The Hamilton council granted the concessions asked for by the Cataract Power Co. as inducement to construct a terminal electric railway station at a cost of about \$200,000.

The Hamilton, Ancaster & Brantford Railway Co., Hamilton, invite tenders for the construction of their road. The Westinghouse Co. will supply the electrical machinery required.

A waterworks system will be installed at Palmerston, Ont., at a cost of about \$35,000.

The Canadian Pacific Railway Co. will erect a large office building at Hamilton, Ont.

The Defiance Iron Works, Chatham, Ont., and the Toronto Gas & Gasoline Engine Co., Toronto, will amalgamate with a capital of \$500,000.

The Port Credit Brick Works, Port Credit, Ont., will erect an office building at a cost of about \$8,000.

The Indestructible Fibre Co., Massena, N.Y., have secured a site and will establish a branch at Ottawa.

The congregation of the Roman Catholic Church, Wolfe Island, Ont., will erect an edifice at a cost of about \$40,000.

The Michigan Central Railway station, Walkers, Ont., was destroyed by fire July 25. Loss about \$1,000.

The paint warehouse of Messrs. Sanderson Percy & Co., Toronto, was damaged by fire July 26. Loss about \$10,000.

The Forwell Foundry Co., Berlin, Ont., will double the capacity of their plant there.

The Transcontinental Railway Commission, Ottawa, invite tenders up to August 14, for the construction of eight steel bridges in the province of Quebec.

The Canadian Castile Soap Co., Berlin, Ont., will erect a factory there.

Messrs. Mather & Finnie, Ottawa, will erect a foundry and machine shop at that place.

The Canadian Oil Co., Toronto, will erect a warehouse at Fort William, Ont.

Messrs. Skinner & English, Forest, Ont., purpose establishing an evaporating plant at Wyoming, Ont.

The Brantford Screw Co., Brantford, Ont., have increased their capital from \$50,000 to \$100,000.

A post office will be erected at Owen Sound, Ont., at a cost of about \$75,000.

The congregation of the Baptist Church, Belleville, Ont., will erect a church building at a cost of about \$15,000.

A Normal School will be erected at North Bay, Ont., at a cost of about \$50,000.

The congregation of the Metropolitan Tabernacle, Toronto, will erect an edifice at a cost of about \$15,000.

Messrs. McGillivray & LaBelle, North Bay, Ont., have been awarded the contract to build a new public building there at a cost of about \$35,000.

The Hamilton Terminal Co., Hamilton, Ont., have been incorporated with a capital of \$200,000, to construct stations, factories, warehouses, etc. The provisional directors include W. W. Osborne, J. R. Moodie and W. C. Hawkins, Hamilton.

The elevator of the Dowd Milling Co., Pakenham, Ont., was destroyed by fire July 29. Loss about \$80,000.

The Department of Public Works, Ottawa, invite tenders up to September 10, for the construction of a concrete lock and dam at St. Andrew's Rapids, Red River, Man.

The New Idea Buckle Co., Toronto, have been incorporated with a capital of \$60,000, to manufacture buckles, hardware, etc. The provisional directors include B. R. Hawley, R. S. Beaver, Toronto, and T. J. McKeown, Portland, Ore.

The Right of Way Mining Co., Ottawa, have been incorporated with a capital of \$500,000, to carry on a mining, milling and reduction business. The provisional directors include J. B. MacLaren, J. P. Dickson and E. S. Leetham, Ottawa.

The Allith Mfg. Co., Hamilton, Ont., have been incorporated with a capital of \$40,000, to manufacture door hangers, ladders, etc. The provisional directors include J. D. Spence, G. A. Walker, and R. S. P. McCormick, Toronto.

Mrs. J. A. McIntyre, Montreal, will erect three seven-story warehouses at a cost of about \$143,000.

Henry Birks, Montreal, will erect a new store there at a cost of about \$150,000.

The Grand Trunk Railway Co., have ordered twenty new locomotives from the Locomotive & Machine Co., Montreal, and the American Locomotive Co., Schenectady, N.Y., aggregating about \$200,000.

Messrs. T. S. Vipond & Co., Montreal, will erect a four story warehouse at a cost of about \$12,000.

The Montreal Reduction & Smelter Co., Montreal, will erect a new smelter at North Bay, Ont., at a cost of about \$1,000,000.

The corporation of Kenora, Ont., has awarded to Allis-Chalmers-Bullock, Limited, Montreal, the contract for the municipal lighting plant, consisting of three alternating current generators, of the water-wheel type, each 625 k.w. 2,400 volts, 3 phase, 60 cycles, 150 r.p.m., with two direct current generators, each 175 k.w. 120 volts, 175 r.p.m. to be used as exciters. The contract includes switch-board and other accessory apparatus. The plant will be built at the works of the company in Montreal.

The Leclaire Lumber Mills, St. Bonaventure, Que., have been incorporated with a capital of \$45,000, to manufacture lumber, timber, etc. The charter members include J. F. Bugeauld, St. Bonaventure, Que.; J. L. B. Leclaire, and G. Magnan, Sorel, Que.

The St. Canut Lumber, Light & Power Co., St. Canut, Que., have been incorporated with a capital of \$250,000, to manufacture wood pulp, paper, etc., and to carry on the business of an electric light, heat and power company. The charter members include J. Cyr, St. Canut, Que.; J. W. Weldon, and S. J. LeHuray, Montreal.

The Canadian Pacific Railway Co., Montreal, have awarded the contract to their shops at Angus, Que., for a large number of cars, aggregating in value about \$2,000,000.

The Canadian Converters' Co., Montreal, have been incorporated with a capital of \$3,000,000, to manufacture linen, woolen, cotton, etc. The charter members include

A. H. Sims, J. P. Black and G. H. Harrower, Montreal.

Messrs. J. H. Blumenthal's Sons, Montreal, have been incorporated with a capital of \$100,000, to manufacture harness, boots, shoes, etc. The charter members include I. Blumenthal, R. H. Blumenthal and D. Fredman, Montreal.

The Desmarteau Plumbers Supply Co., Montreal, have been incorporated with a capital of \$195,000, to manufacture metal pipes, tools, plumbers' supplies, etc. The charter members include J. A. Desmarteau, H. Hebert, and H. Hamel, Montreal.

The Smart Bag Co., Montreal, will erect a three story factory near Charlevoix, Que.

The Montreal Steel Works, Montreal, will erect a warehouse at a cost of about \$14,800.

The Last Mfg. Co., Granby, Que., will enlarge their factory there.

The lumber yards of T. Paradis, Levis, Que., were damaged by fire, July 19.

Wm. Clark, Montreal, will erect a large meat canning factory there at a cost of about \$150,000.

The large foundry of Messrs. Carrier, Laine & Co., Levis, Que., was destroyed by fire July 19.

The town hall, Richmond, Que., will be remodeled at a cost of about \$8,000.

An immigration building will be erected at Breakwater, Que., at a cost of about \$200,000.

The Gas Co., Fredericton, N.B., will improve their plant at a cost of about \$10,000.

Messrs. D. Fraser & Sons, Fredericton, N.B., will rebuild the Aberdeen lumber mill destroyed recently.

Messrs. Rhodes, Curry & Co., Amherst, N.S., have been awarded the contract by the Grand Trunk Pacific Co., for 2,500 cars, the value of which will be \$2,000,000.

The rail mill of the Dominion Iron & Steel Co., Sydney, N.S., was damaged by fire July 23. Loss about \$3,000.

The contract has been renewed with Messrs. Pickford & Black, Halifax, N.S., for a continuation of the Canadian West Indies and Demarara steamship service for a further period of four years.

The municipality of Colchester, N.S., invite tenders up to August 14 for the erection of a home for the poor and insane.

The sewerage and waterworks systems, Amherst, N.S., will be extended at a cost of about \$90,000.

The J. McDiarmid Co., Winnipeg, Man., have been incorporated with a capital of \$50,000, to manufacture boilers, machinery, brick, tiles, etc. The provisional directors include J. McDiarmid, E. Cass and P. Muir, Winnipeg, Man.

The Northern Shirt Co., Winnipeg, Man., have been incorporated with a capital of \$5,000, to manufacture boat sails, shirts, hammocks, flags, etc. The provisional directors include W. J. Bawlf, F. C. Lawson and T. S. Ewart, Winnipeg.

The V. C. Maddock Co., Winnipeg, Man., will erect a brewery at Moose Jaw, Sask.

The Fire, Water & Light Committee, Winnipeg, Man., invite tenders up to August 27 for supply of two turbine pumps and electric motors for the city waterworks.

The Simpson-Hepworth Co., Winnipeg,

Man., have been incorporated with a capital of \$20,000, to manufacture engines, machinery, etc. The provisional directors include F. G. Simpson, H. S. Simpson and A. T. Hepworth, Winnipeg, Man.

The Geo. H. Archibald Co., Winnipeg, Man., have been incorporated with a capital of \$60,000, to construct buildings of all kinds. The provisional directors include G. H. Archibald, R. Lawson and W. B. Lawson, Winnipeg, Man.

The Brandon Machine Works Co., Brandon, Man., will erect a new building.

A public school will be erected at Swift Current, Man., at a cost of about \$10,000.

D. C. McKinnon, Winnipeg, Man., will erect a four story hotel at Dauphin, Man.

The Swan River Hotel Co., Swan River, Man., will erect an hotel there.

The Crescent Creamery Co., Winnipeg, Man., will erect a large addition to their plant there.

The stables of the Hamburg Mfg. Co., Brandon, Man., were destroyed by fire July 19. Loss about \$3,000.

The Consolidated Elevator Co., Winnipeg, Man., have been incorporated with a capital of \$400,000, to construct elevators, warehouses, mills, etc. The provisional directors include A. Reid, K. B. Stoddart, and E. James, Winnipeg, Man.

The Canada West Coal & Coke Co., Winnipeg, Man., have been incorporated with a capital of \$2,000,000, to manufacture coal, oil, gas, machinery, etc. The provisional directors include J. S. Hough, C. Williams and W. M. Graham, Winnipeg, Man.

The premises of the sash and door factory of A. E. Holston, Winnipeg, Man., were destroyed by fire recently.

The premises of the Manitoba Gypsum Co., Gypsumville, Man., were destroyed by fire recently. The company will rebuild in Winnipeg at a cost of about \$75,000.

The ratepayers of Calgary, Alta., will vote on a by-law to raise another \$10,000 for the municipal power plant.

The North-West Thresher Co., Stillwater, Minn., will erect a warehouse at Regina, Sask.

The Banff Springs Hotel, Banff, Alta., owned by the Canadian Pacific Railway Co., will be enlarged and improved at a cost of about \$300,000.

The Canadian Pacific Railway Co. have purchased large tracts of land at Saskatoon, Sask., for freight depots, etc.

A. S. Corbett, Olds, Alta., will erect a hotel, 60x50 feet, at a cost of about \$15,000.

A new Roman Catholic church will be built at Grayson, Sask.

The congregation of the Presbyterian Church, Caron, Sask., will erect a new church building.

The Western Canada Milling Co., Winnipeg, Man., will erect an elevator at Creelman, Sask.

The Canadian Pacific Railway Co. will make a test at Medicine Hat, Alta., to ascertain whether there is oil underlying the natural gas field. Drilling machinery has arrived at Medicine Hat sufficient to reach a depth of 3,500 feet.

Messrs. Revillon Bros., Edmonton, Alta., will erect a warehouse at a cost of about \$1,200.

The Y.M.C.A., Moose Jaw, Sask., will erect a large building there.

The Dominion Meat Co., Calgary, Alta., will erect a building at a cost of about \$45,000.

The Lethbridge Coal Mines Co., Lethbridge, Alta., will improve their plant at a cost of about \$75,000.

The electric light plant, Prince Albert, Sask., will be improved at a cost of about \$30,000.

It is stated that Messrs. Sprout, Waldron & Co., Minneapolis, Minn., will erect a flour mill at Lethbridge, Alta.

R. Howson, Revelstoke, B.C., is preparing plans for the erection of a business block to cost about \$40,000.

Messrs. Kavanough & Holden, Vancouver, B.C., will erect a fifty room hotel there.

The Pacific Steam Whaling Co., Victoria, B.C., will erect three whaling stations on Vancouver Island.

A Baptist College will be erected at Sumnerland, B.C.

The Pacific Coast Lumber Co., Vancouver, B.C., will erect a large saw mill on Burrard Inlet, B.C.

The Sutton Lumber & Trading Co., Mosquito Harbor, B.C., will erect a large saw mill at Friendly Cove, B.C.

## ELECTRICITY.

**Electrical machinery and appliances of all kinds, electrical power plants and other progress in the electrical industries will be noted here.**

The Strangen-Wick Railway Co., which operates a suburban line near the city of Stockholm, the capital of Sweden, has contracted with the Westinghouse Electric & Mfg. Co., Pittsburg, Pa., for the electrical equipment of the cars to operate this road with the single-phase system. This recognition of the superiority of American electric railway apparatus is the result of an elaborate test instituted by the Swedish government about a year ago. In this test, manufacturers of electric railway systems from America and Europe entered into competition and the palm was finally awarded to the Westinghouse Co., which was then given an order for an alternating current single-phase locomotive. The order from the Strangen-Wick Co. calls for the same type of electric railway motors.

### THE ELECTRICAL ERA IN CANADA.

It is estimated that between \$50,000,000 and \$60,000,000 are now invested in Canadian electrical undertakings, and at the meetings of the International Electrical Commission in London, in July, Canada's electrical status among the industrial nations was recognized by the grant to her of a full vote. That is to say, Canada is no longer lumped with Great Britain and the rest of the Empire—she is placed on a par in this respect with Great Britain, the United States, and Germany, and given one vote, as is each of them.

The meetings of the Commission marked the opening of a new chapter in the electrical

industry, says the Canadian Gazette. Every industrial country of any standing was represented. The chairman was Mr. Siemens, the world-famed electrician. The Canadian representative, delegated by the Canadian Society of Civil Engineers, the Canadian Electrical Society and the Canadian Manufacturers of Electrical Machinery, was Professor L. A. Herdt, Professor of Electrical Engineering at McGill University, Montreal.

The Commission adopted rules for the formation of a permanent International Electrical Commission, upon which the technical societies of the world will be represented, and it will be the purpose of this influential body to bring about the standardization of nomenclature and ratings in the electrical industry. The advantage of such a standardization was fully realized by the distinguished European and American electricians who attended the gathering. Illustrations may be given of the need of such a step.

In these days of protective tariffs and highly developed nationalism, standardization between competing countries would, one might think, be discouraged. Professor Herdt was asked whether the new standardization in respect of electrical machinery would not tend to stimulate importations into Canada of British, German, and United States machinery to compete with machinery of Canadian manufacture. "We do not look at it that way," was his reply; "we want to understand each other, as we cannot easily do now. Canada makes her own electrical machinery for the most part, and the standardization must have an enormous influence upon the industry in the way of expansion." As we have shown, Canada's status as an electrical manufacturing country is now given world-wide recognition. Yet it is only at the beginning of its career, and the development is almost entirely due to Canadian initiative and capital. There is the Canadian Electrical Co., whose works at Niagara are one of the modern marvels of Canada; the Canadian Westinghouse Co., in which the lynx-eyed United States capitalist shows his appreciation of Canada's industrial importance; the Montreal Light, Heat & Power Co., of which Senator Forget is the leading spirit; and such large undertakings as Allis-Chalmers-Bullock, Limited, Montreal. The Sarnia Tunnel is being electrified by the Grand Trunk Railway Co., and the Canadian Pacific Railway Co. have begun the electrification of their line between Quebec and Montreal. Of course, the unlimited water power to be found in almost every section of the Dominion is a factor of enormous value in the expansion of the industry, and such developments as the formation of the Ontario Government Electrical Commission is an indication of the vigilance with which the authorities are keeping watch over the progress of events.

### COBALT STORAGE BATTERIES.

As is well known in the electrical trade, says the New York Commercial, Thomas A. Edison has been for some time working on a new type of storage battery which, when finally finished, is expected to be cheaper than the present types, and at the same time combine increased power with decreased weight and bulk. Mr. Edison has been hampered in his work by difficulty in obtaining sufficient quantities of cobalt, but recent discoveries of

large deposits of cobalt will go a long way toward solving his problem.

The new storage battery is expected to be of the greatest value, perhaps, on small pleasure craft, where space is at a premium and thus the manufacturers of motor boats are possibly as deeply interested as anyone else in Edison's reported discovery of cobalt deposits.

The motor boat appliances that will be most benefited by this new discovery are the hydroplane and the motorgodille. Both are new inventions. The hydroplane consists of a series of thin plates fixed to the boat below the water line and tilted at such an angle that when the boat is set in motion the hydroplanes lift it out of the water in the same manner that a kite or aeroplane is lifted. This makes the boat skim over the surface of the water rather than plough through, and by lessening the water friction, increase the speed.

A small boat weighing with two men, 550 pounds, was lifted clear from the water while going at the moderate speed of 15 miles an hour. Larger boats have been lifted from the water at higher speed, and the discoverers of this principle claim boats can make from 45 to 50 miles an hour when equipped with it. They believe that with a battery of small compass and great power, records so far never attempted can be made.

The motorgodille is an invention recently brought out in France. Like the hydroplane, it requires a light and powerful battery for the best results. It consists of a screw propeller fixed upon a shaft and fastened to a socket in the stern of the boat. The power of the storage batteries is conveyed to the propeller shaft through a small portable motor.

Like a sculling oar it can be used to either steer or propel the craft to which it is attached. The principle of sculling with a single oar thrust through a row-lock in the stern of a boat is, in fact, responsible for the invention of the motorgodille. It can be fastened to or removed from any row boat in a few minutes and requires no alterations in the boat to which it is fastened. With a motorgodille an ordinary skiff can be converted into a motor boat in a few minutes. The inventors believe that with powerful batteries of small size and great power, such an improvised motor boat can beat most of the swift racers equipped with ordinary engines.

### ELECTRICITY DIRECT.

"We are groping on the verge of another great epoch in the world's history," said Mr. Edison, in a recent interview. "It would not surprise me any morning to wake up and learn that someone, some group of the 300,000 scientific men who are investigating all over the earth, has seized upon the secret of electricity by direct process and begun another practical revolution in human affairs. It can be done. It will be done. I expect to see it before I die.

"The first great change in the production of electricity will abolish carrying coal for that purpose," he said. "Instead of digging gross material out of the earth, loading it on cars, and carrying it, say, 500 miles, there to put it under a boiler and burn, and so get power, we shall set up plants at the mouths of mines, generate power there and transmit it wherever it is needed by copper wire. It is preposterous to keep on putting

coal mines on wheels. It is too clumsy. It is too costly. There is no necessity for it. It is easier to carry molecular vibration by millions of waves a second than freight cars full of crude matter.

"We can ship 100,000 h.p. over the wire quicker and more economically than we can send the equivalent in coal over a railroad track. We must eliminate the railroad altogether from this problem. What's the use of it? We don't want coal anyhow. It does us no good to look at it. What we want is the resultant of the utmost energy that can be produced. And there is no sense in carrying around millions of tons of raw material like coal when we can get a product delivered to us by wire. Now the truth is that it will cost a third less to transport electrical power by wire than to carry it in the form of coal in railroad cars. Assume the price of coal to be \$1 at the mouth of a mine, and assume the freight to be \$1.90. Now, we can turn coal into electricity at the mine and convey it by wire less than half of the cost of the freightage of coal."

## PUBLICATIONS.

The publishers of The Canadian Manufacturer solicit in advance, if possible, catalogues, circulars, and other industrial publications issued by manufacturers. We wish to review such literature, and bring the principal points to the attention of our readers.

**WIRE WEAVING MACHINE.**—A four page circular giving description and illustration of Lloyd's automatic machine for weaving bed mattresses, a new invention in wire weaving. The Lloyd-Thompson Wire, Limited, Toronto.

**NERNST STREET LIGHTING SYSTEM.**—A 12-page pamphlet giving detailed description of the Nernst Series Alternating Vertical Glower Street Lighting System, originated by the Nernst Lamp Co., and handled in Canada by the Canadian Westinghouse Co., Hamilton, Ont.

**PHILADELPHIA TEXTILE SCHOOL.**—A 140-page book constituting the "Circular of the School of Industrial Art of the Philadelphia Museum" for 1906-07, giving illustrations of the lecture rooms, laboratories and applied science or mechanical departments. For copies write to the Philadelphia Textile School, Broad and Pine Streets, Philadelphia.

**TANKS AND SUBSTRUCTURES.**—Catalogue No. 47 (48 pages) devoted to descriptions of tanks and substructures erected on or near mills, factories and warehouses of all kinds by one of the leading firms in this line, Flint & Walling Mfg. Co., Kendallville, Ind.

**GASOLINE ENGINE IGNITION.**—One of the features of a gasoline engine which should be understood by every person who operates one is the ignition. Owing to the need of authoritative information on this subject the Gas Engine Publishing Co., Cincinnati, Ohio, have published a book under the above title, written by E. J. Williams, a recognized authority. This firm also publish other books dealing with the gas engine and its needs.

**DEVELOPMENT OF THE ONTARIO POWER COMPANY.**—A 32-page booklet giving the history of the Ontario Power Co. from its

inception to the completion of its great plant at Niagara Falls. The booklet is replete with splendid views of the falls, the situation of the plant and of the mechanical equipment installed throughout. Accompanying it is a wonderful map giving bird's eye view, in colors, of the developments about the falls. As this work is from the pen of P. N. Nun it is one which is so correct both from historical and mechanical viewpoints, that everyone interested in power development would find it worthy of a place in their library. The Ontario Power Co., Niagara Falls, Ont.

**APPLICATION OF STORAGE BATTERIES TO RAILWAY CAR LIGHTING.**—An 8-page pamphlet describing with illustrations car lighting installations made by the Electric Storage Battery Co., Philadelphia, Pa. This firm are also issuing a 4-page pamphlet devoted to application of storage batteries in railway, electric signal and interlocking devices.

**CONCISE HISTORY OF LEAD PENCIL MAKING.**—An 8-page pamphlet giving speech made by Hon. John A. Walker, vice-president and general manager of the Joseph Dixon Crucible Co., Jersey City, N.J., before the "Boost Club," New York.

**THE ECONOMICS OF POWER PRODUCTION.**—A 48-page report of addresses delivered before the Canadian section of the Society of Chemical Industry. The subjects discussed are "Economics of Combustion," "Boiler Waters," "Producer Gas," "The Commercial Development of Power from Gas." Appendices are devoted to "The Sampling and Valuation of Coal," "Parr's Calorimeter," "The Dasyrometer." The honorary secretary of the Society is Alf. Burton, 44 York St., Toronto.

**JEFFREY CONVEYORS AND ELEVATORS.**—Chain catalogue No. 80, a 376-page book bound in cloth, illustrating the elevating, conveying, power transmitting machinery and chains made by the Jeffrey Mfg. Co., Columbus, Ohio. As this firm are leaders in their line, as they make equipment for every kind of industry and as this book contains over one thousand illustrations reproduced from photographs taken of installations made by this company throughout the world, and of the various lines made by them, it is a work of immense value. It is, in fact, too valuable to send out promiscuously but it will be sent to any reader of THE CANADIAN MANUFACTURER who is connected with any recognized industrial concern and who will send his request on his firm's own letter paper.

**VALVES AND HYDRANTS.**—A 64-page catalogue describing in detail, with illustrations the full line of brass and iron valves, fire hydrants, valve fittings, machine bolts, etc., made by the Kerr Engine Co., Walkerville, Ont. As this is the standard catalogue of one of the leading firms in their line it should be in the library of every manufacturer, every dealer and every firm of steamfitters.

**"A SONG OF JOY."**—A calendar for August, illustrating a bookkeeper who saves so much time by keeping his accounts in a modern way that he gets home early every evening, instead of late at night, as formerly. The Copeland-Chaterson Co., Toronto.

**BRICK MAKING MACHINERY.**—A 24-page catalogue describing with illustrations the

Berg brick presses and other brick making equipment made by A. Berg & Son, Toronto

**ECONOMICAL LIGHTING OF INDUSTRIAL PLANTS.**—A 32-page booklet giving full information re the use and advantages of the Cooper Hewitt Mercury Vapor Lamps. The Cooper Hewitt Lamp Co., Pittsburg, Pa.

**ELECTRICITY IN HEAVY RAILWAY SERVICE.**—A 48-page booklet giving information regarding the tests, experiments of and victories for electricity in heavy railway service in America and Europe. This subject is bound to arouse widespread attention during the next few years. The Canadian Westinghouse Co., Hamilton.

**STAR BUSHINGS.**—A 24-page pocket catalogue of star bushings and other contractors' supplies made by the Steel City Electric Co., Third St. and Penn Ave., Pittsburg, Pa.

**DIXON'S GRAPHITE BRUSHES.**—A 12-page pamphlet giving details, with cuts, of the graphite brushes for electric generators and motors instead of carbon brushes. The Joseph Dixon Crucible Co., Jersey City, N.J.

**DO YOU TUMBLE?**—One of the most artistic little booklets we have seen for some time, devoted to the improved Globe oblique tilting tumbling barrels made by the Globe Machine & Stamping Co., Cleveland, Ohio. The argument in this booklet is made by illustrations of old method of tumbling as compared with the up-to-date Globe method.

**LINE SHAFTING.**—A 4-page leaflet giving report of test with comparative data and statement of saving effected by the use of Chapman double ball bearings in the Orswell Mills, Fitchburg, Mass. The Chapman Double Ball Bearing Co., Toronto.

In amplified form the American Textile Directory for 1906-7 has just come from the press. This annual publication, compiled by the Textile World Record, Lord & Nagle Co., Boston, Mass., is an authoritative work and contains full reports of all of the textile manufacturing establishments in the United States, Canada and Mexico. It comprises a complete list, also of all the yarn trade and all concerns selling to or buying from textile mills. The directory is published in two forms. One, an office edition, is a 600-page book at \$3.00. The other a travellers' edition at \$2.00. By a careful cross index system the products of mills are classified, bleaching, dyeing and printing plants are indicated, and handlers of raw materials in wool and cotton are enumerated. The work also contains a list of manufacturers' selling agents and dry goods commission merchants.

The sixteenth annual edition of the Farm Implement News Buyer's Guide follows the general plan and arrangement of the last edition. It has been thoroughly revised from reports furnished by the manufacturers and contains all additions, changes or corrections that were included in such reports. Its contents are so arranged as to enable one to find all of the manufacturers of any particular kind of machine or any one of them—or to find the manufacturer's name and address if only the name of a machine should be known,—or, to find the full line made by any manufacturer and all other goods made in the same town in the lines represented herein. In no other similar publication can this information be obtained.

# MACHINERY AND ENGINEERING.

A Review of New Machinery, Power Appliances and Factory Equipment of all Kinds.

## THE CANADIAN McVICKER ENGINE.

The Canadian McVicker Engine Co., Limited, whose incorporation with capital stock of \$300,000 (\$100,000 paid up) was announced in a previous issue, are going ahead rapidly with the construction of their factory in Galt, Ont.

This company have four acres of ground situated on the Canadian Pacific Railway and Grand Trunk Railway tracks, on which there is now a machine shop built, 83x48 feet, equipped with over \$20,000 worth of the latest machine tools and equipment necessary for the manufacture of gas engines, besides which there are the storage building, 65x30 feet, the assembling shop, 100x30 feet, the office building, 32x22 feet, and the pattern and pattern storage building, 50x30 feet, all

vantages of this, besides its simplicity, are that no power is taken from the crank shaft for the operation of the valve and an unignited charge is preserved instead of being expelled through the exhaust port, as in engines with mechanically operated valves.

The method of governing is of the "hit and miss" style, and the company guarantee that the engine will govern on variable loads within a fraction of one per cent.

In the McVicker carbureter the gasoline is atomized by mixing it mechanically with air. The atomizer requires no adjustment for varying loads, and thus the needle valves need not be moved after once set.

The base of the engine is a heavy casting reinforced at crank bearing. The cylinder is provided with an extra large water jacket,

is out of line or is not level or there may be a lack of oil. On some lines of shafting there are bearings on which the caps have a large opening and in which is placed some waste.

Before long the waste will fill up with dust, and when more oil is poured in the dust will be worked into the bearing. This invariably results in a hot bearing. Then the engineer or oiler wonders why the bearing runs hot after having run along smoothly for perhaps a long time.

Then again in some bearings grease is used in place of oil, and in some time dust will settle on the grease. When the latter becomes worked into the bearing, the dust will also get in and cause heating. The remedy is to cover the grease.

Change of temperature in an engine room may cause a hot bearing, for when a door or window is opened for a long time it will lower the temperature and cool the oil in the cups. Then they will feed slower or stop altogether. Were this to go unnoticed by the engineer a hot bearing will result.

When a bearing gets hot, shut down if possible, then wash out the bearing with kerosene oil and use graphite mixed with cylinder oil. In some cases the oil is at fault. It may not be adapted to the purpose for which it is used. It may be too light or too heavy. If the oil is too light then again the addition of flake graphite will help matters immensely and prevent heated bearings.

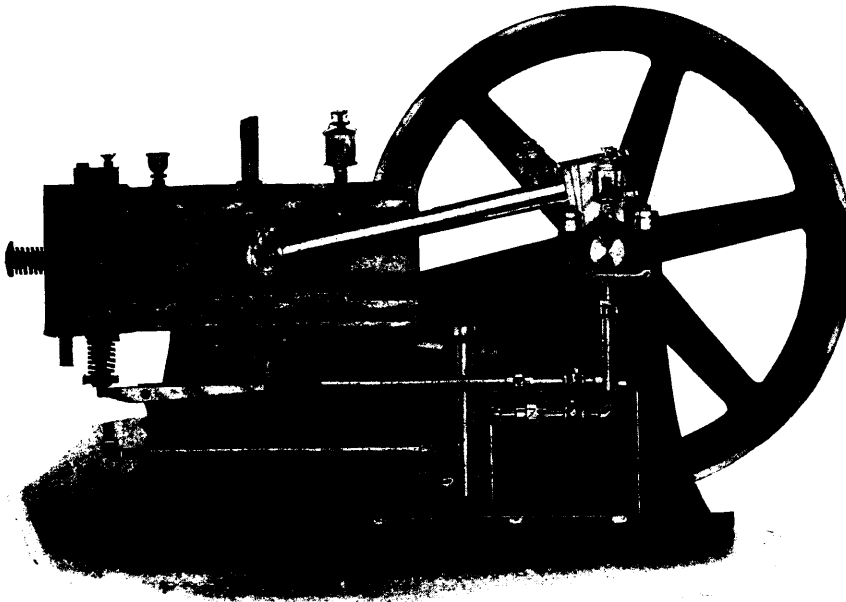

THE McVICKER ENGINE.

of which are now nearing completion. They also have in prospect a finishing and testing shop, 100x30 feet, a foundry building, 100x50 feet, a traction engine machine shop, 100x50 feet, and a traction engine assembling and storage building, 100x50 feet.

As the company is associated with the Alma Mfg. Co., Alma, Mich., which was organized four years ago to make the McVicker engine in the United States, they will have Canadian rights for this engine. At present it will be made in sizes from 2 h.p. to 30 h.p. but will ultimately make them up to 1,000 h.p.

This engine has several distinct features. It is four-cycle, but is built without gears, cams, eccentrics or trigger work of any kind. The arrangement of the valves may be seen from the accompanying sectional view of the engine. The inlet valve is of the simple poppet type placed in the back of the combustion chamber, which is situated directly behind the piston, the full force of the explosion thus being obtained on the piston. The exhaust valve also is of the poppet type operated by the exhaust itself through a bypass as seen in the sectional view. The ad-

and is fitted in planed ways to secure good alignment. The crank and connecting rod are drop forgings, and the bearings are made of special composition brass. The piston rings are four in number, and are turned concentric. The igniter is a positive "make and break" type, and is located on the top of the cylinder. The points can be readily examined by simply removing two screws. As the parts are made jigs they are interchangeable.

## HOT BEARINGS: THE CAUSE AND REMEDY.

One of the troubles in a power plant, according to the Southern Engineer, is the heating of bearings on engines and line shafting and oftentimes the cause cannot readily be found. Sometimes the cap nuts are not filled up evenly all around, with the result that one side of the cap cramps the shaft. This is a common occurrence, and if no attention is given it a serious accident may result.

When a hot bearing occurs there is always a reason for it. It may be that the shafting

## DRYING DAMP GOODS IN WET WEATHER.

There are various processes of manufacture in which goods have to be wet while under manipulation and dried again before they are finished. Tea, tobacco, cotton, wool, silk, and other materials are subject to those processes; and as in all manufactories each operation must be completed within a certain time, it has been unsafe to depend upon the state of the weather for the purpose of drying although at certain times it may offer every facility for the operation. There are many cases also where a factory has not sufficient space to expose its goods to the action of the air and the sun; it is then necessary to provide means of producing a rapid current of a certain desired velocity, which, when directed through the goods, will carry off the surplus moisture they contain. Wet clothes may be rapidly dried in this manner by being hung upon racks in a room so that a current of air may circulate between them. The rate of drying will depend partly upon the dryness and partly upon the temperature of the air passing through the goods. During the rainy season, when the air is nearly saturated with moisture, drying takes place very slowly under ordinary circumstances even if a steady current should pass the material to be dried; but as the capacity of air to absorb moisture varies with the temperature, it may be made more absorbent merely by heating it. For example, when the rain falls heavily in Bombay the temperature is frequently 82 degrees Fahr., while the moisture is 90

per cent. of saturation. This represents 11 grains of water per cubic foot. By heating the air to 110 degrees, the saturation is reduced to from 90 to 42 per cent., roughly, and the air is thus able to absorb as much again of water as it at first contained without being damper than its original condition. In this manner by simply controlling the temperature of the current of air its drying power may be assured whatever the state of the weather may be.

In many industries the drying chamber is such a necessary part of the plant that drying apparatus has become a speciality of certain manufacturers. Prominent among these is the B. F. Sturtevant Co., of Boston, Mass., who have made this subject one of careful study and investigation, and who are building in conformity with these principles a special type of their hot blast heating apparatus. This apparatus which has so extensively applied for the heating and ventilating of buildings consists primarily of a cased fan with proper means of driving the same, a steel pipe heater encased in a steel plate jacket, through which air passes in the process of heating, and a system of ducts through which it is delivered to its destination.

As ordinarily constructed the fan is equipped with either a direct-connected engine or an electric motor, which renders the operation

of the fan independent of any other source of power.

The steel plate construction makes it possible to meet the exact requirements, while the sectional form of the heater renders it adaptable to all locations. The sections of the heater consist of either two or four rows of one inch steel pipe through which the steam circulates. The cast iron bases of these sections are bolted up together so as to form a common inlet for steam, and outlet for the water of condensation. The heater is designed to use either live or exhaust steam, and may be arranged so that any number of sections may be employed at a given time.

In such industries as the drying of glue, or fish for manure manufacture, etc., the hot air fan is indispensable. There is one important consideration in the use of hot air for animal or vegetable substances, the safe limit of temperature which may be used without injuring the material. The drying of tea for instance is a process of great delicacy, as undue heat carries off a part of the aroma which forms one of the most attractive qualities of tea. Fruits have also to be treated with care for the same reason. Goods which have to be packed for protection in air tight cases should first be dried with great care, as any moisture they contain is liable in hot weather to produce mildew.

at once put in hand to use the latest vantage ground as a base for further progress. So also in engineering. Mr. Dowson showed how a water gas making process previously intermittent and cumbersome could be converted into a practically continuous operation with simpler appliances and in doing so, he disclosed a wider horizon. Now his fellow engineers have used the position gained by his invention and have shown how a still simpler apparatus can give practically similar service. The field has again been extended thereby, and now almost every power user, if he will, may take advantage of the most economical form of power yet devised and in doing so, can save in working expenses a sum that, a few years ago seemed quite impossible and incredible. And this with less risk of fatalities, fires or breakdowns.

In 1895 M. Bernier, of Paris, invented a gas making plant working upon the Dowson principle of a simultaneous blast of steam and air through incandescent fuel, but designed to utilize the waste heat of the generated gas, in making steam. It was M. Bernier's ambition to make all the steam from the sensible heat of the gas, as in the proper operation of engines gas has to be cooled in any case and, until his experiments, all the sensible heat had been wasted. M. Bernier was successful in raising some steam at atmospheric pressure, but it was then evident that some apparatus had to be devised to force or draw the steam and air through the fire. He decided to provide an auxiliary piston by the side of the working cylinder of a gas engine, and arrange this to suck the gas from the plant and deliver it to the engine. He evidently did not consider whether or not the engine could draw its own gas or probably he thought to obtain all the power he could from a well filled cylinder even at the expense of loss in mechanical efficiency. M. Bernier's plant, while encouraging, was not very successful, although considerable improvements were made later on. M. Taylor & Co., of Paris, still further developed the producer and in their hands it became a commercial success both in France and in England. A few examples are still to be seen at work in the latter country.

In 1895 Messrs. Koerting Bros., of Koertingdorf, Germany, were also experimenting in the regenerative principles and as a result, instructed their agent, C. Wiegand, of Hannover, in July, 1895, to take out patent rights for a producer which made gas only when air and steam were drawn through the fuel under the influence of a negative pressure caused by the piston of a gas engine during charging strokes. The results obtained from these experiments were discouraging and the patent abandoned. According to Mr. John Koerting, irregular working of the engine under light loads due to fluctuating low pressures through the plant, was experienced, and it was felt that the pressure type was the more effective. In the light of the experience since gained it is not difficult to imagine the poor results achieved. The separate steam boiler was still an essential feature as was also a gasholder which, however, provided with balance weights and rollers, would give very unsatisfactory variations of pressures due to friction of moving parts and the inertia effects of the bulky "bell." Far from feeling that safety was increased by the gas being below atmospheric pressure, Koerting Bros. thought that the possible leakage of air into the system, due to any defective joints or seals

## History of the Suction Gas Producer.

By EMIL STERN\*.

Within a few years the suction gas producer has developed from a theoretical idea and a half dozen discouraging experiments into one of the mightiest factors in generating power.

A brief review of its development may help readers of THE CANADIAN MANUFACTURER to understand it better and to make it easier to decide what in it is good and what is bad.

This development has been recent. The introduction of the producer into all kinds of factories, where power is wanted, dates back only five years. The suction gas producer and suction gas itself, is one of those inventions that did not rise at once in one man's mind. Its history is almost as old as the gas engine itself.

Since the early days of the gas engine, people had the idea to get a cheaper gas and to make themselves independent of the gas mains of the larger cities, to be able to use the advantages of the gas engine out of town, in the country, and for farming purposes.

Suction gas is, in popular language, a mixture of water gas (H) and carbonmonoxide (C.O.) the former being produced by decomposition of overheated steam (H. 2.0) into hydrogen H. and oxygen O., the latter generated by the combustion of coal (C.) under a want of air. This mixture is sucked through the apparatus by the gas engine during the loading stroke.

\* Mr. Stern has been in touch with the development of the Suction Gas Producer from its earliest stages, having been associated with Julius Pintsch, Berlin, until a few weeks ago, when he came to Canada to act as consulting engineer for the Economic Power, Light and Heat Supply Co., Limited, Toronto.

The earliest predecessor of the suction gas plant was the water gas producer, which, in a complicated intermediate process, separated the hydrogen from the carbonmonoxide and wasting the carbonmonoxide used the hydrogen collected in a gas holder for driving gas engines and for other purposes, melting, welding, etc.

In 1878 Mr. Emerson Dowson made a step forward by the invention of the Dowson pressure plant. He saw first that it was not necessary to produce the hydrogen for itself wasting the C. O. for blowing hot the generator. He left the two processes beside one another and was the first who made that mixture which we now call producer gas. He wanted a separate steam boiler that involves the consumption of about 25 per cent. more fuel than is actually used in gas making within the generator.

The importance of Mr. Dowson's discovery cannot be overestimated when one considers first how rapidly the gas engine has developed in size and popularity in consequence of the resulting cheap supply of power gas and second, how it has been possible by the experience gained from the larger engines thus called into existence to go on increasing the unit power per cylinder year by year until we now may see single and multi-cylinder gas engines in successful operation of sizes that seemed quite impossible then. These largest engines are operated with blast furnace gas but the gradual evolution from 20 h.p. to 2,000 h.p. unit has been made impossible by the experience gained with those of intermediate power.

In campaigning no sooner is a position gained and made secure than preparations are

might prove dangerous and they preferred to use further the pressure type.

In 1901 the firm of Julius Pintsch, of Berlin, made and erected a suction plant of their own design for T. Geotz & Conrad, to serve a gas engine driving an electric light and power plant at Heusy, a suburb of Verviers in Belgium. The Geotz Co., when accepting the order for the engine, were very doubtful about the proper working of the engine with the producer and made it quite clear from the first that, in their opinion, successful operation would only be obtained by the addition of a separate boiler and gas holder. After erection ten days were spent in trying to start the engine, and it looked as if the gas engine firm's distrust was justified. Mr. H. Gerdes, chief engineer to Messrs. Pintsch, was then sent for and after properly adjusting all details and superintending the proper blowing up of the fuel, he had the satisfaction of seeing the engine started off splendidly and the installation has ever since been in successful operation. To emphasize this success it should be mentioned that under a brake test with an inferior quality of coke, containing about 20 per cent. of moisture and ash, the consumption of fuel was 1½ pounds per b.h.p. per hour. This starting day was the real birthday of our modern suction gas plant.

The advantages of the new system of generating power were so striking as to excite the whole world to competition, and really since this day, some hundreds of manufacturers have been offering suction gas plants of any size and for any price. Those who used to state that the suction gas producer was an impossibility now build and praise it. Besides a few good firms working on a scientific basis, dozens of manufacturers, attracted by the success and the splendid simplicity of the Pintsch suction gas plant have made their appearance.

So, as a suction gas plant is not good if it is not a well designed one, it is not surprising that many complaints about unsatisfactory and unreliable working came to the public and discredited the whole trade, the reliable as well as the unreliable. The installations, in some cases, stopped shortly after they started and were not to be restarted by any means.

I know and have seen plants supplied by inferior companies that have never been in use. For this purpose, I would advise all people who desire to profit by this splendid invention and all using power (and they certainly should do so), to have their plant and engine supplied by a reliable firm, who give numerous guarantees. It would be wise, further, to see first that they are able to fulfill them.

Some 300,000 h.p. are now worked with suction gas in all parts of the world. It will be easy for the user to find a system the reliability of which is proved by its success.

I will not forget to mention at this place one item that does not concern individuals only, but the public generally.

Leave on a week day one of our large cities. Take, for instance, the ferry leaving Toronto for the Island and turn your head back to see the town. You will some days see little else, but a cloud of smoke consisting of wasted carbon, a cause of sickness and consumption.

With the suction gas producer the power user saves not only his money but he saves carbon, as no smoke is raised by it. A sign for the simplicity and safety of this power,

is that no public supervision or permission of any kind is wanted for suction gas plants as is necessary for every steam plant.

### THE TORONTO INDUSTRIAL EXHIBITION.

The new buildings on the Toronto exhibition grounds are getting along finely and the magnificent process and agricultural implements building is now so near completion that exhibits are already commencing to come in, some of them being already in place. The structure would well repay a visit, for it is impossible to have a conception of its magnitude without an actual view. Its front extends from and includes the old stove building on the main road right down to the administration offices, having taken in the old telephone and telegraph offices, old implement building and the press bureau, as well as quite a piece of land to the south. It is built almost entirely of brick and steel, and has a floor space of over 86,000 square feet. It is one of the most unique and the best buildings devoted to exhibition purposes on this continent. It has a more imposing front and possesses the additional virtue of showing the greatest possible variety of articles under the one roof. While the processes of manufacture will be the principal feature of the building, sections of it will be devoted to stoves, agricultural implements, miscellaneous manufactures and other exhibits for which space cannot be found in the special buildings.

The processes of manufacture will this year be on a scale of magnitude and interest that will completely dwarf anything that the exhibition has previously had. There will be some thirty processes in all, including carpet weaving, motor car building, motor boat building, and glass cutting, crystal bowls, epergnes, plates and dishes being made on the spot. Pure food manufacture of every description, including candies, cakes, loaves, biscuits, and all things appertaining to the bread and biscuit business and confectionery, will be demonstrated.

There will be a tobacco plantation and a factory showing the complete process of tobacco making, cigar and cigarette making from the raw material to the completion. Textile weaving will be another process in which many articles of value and usefulness, including curtains, bed quilts, cloths, etc., will be made. There will be a variety of metal working machinery that will turn out a quantity of articles daily and turn them out in a style of the best possible workmanship and design. Spring mattresses, wire door mats, and wire goods in great variety will also be produced. There will be a complete demonstration of the manufacture of underwear, stockings, socks, and all manner of knitted goods. The printer's art will be illustrated by means of the very latest inventions. There will be automatic type setting, lithographing, engraving and in fact a clear exposition of all the branches of the art. There will be men at work on envelope making machines and blue print machines. Graphophone records will be made while you wait, and there will be a most varied and numerous exhibit of the latest developments applied to mercantile uses. Especially interesting will be an exhibit of gasoline machines as applied to motor boats, and from time to time other processes will be added, including, probably, complete machinery for canning and for

packing. In consequence of the number of applications for space in the manufactures and liberal arts building over-flow arrangements have been made in the new process building and in an annex.

### PRODUCER GAS POWER PLANT.

Producer gas power has recently been adopted by the Norton Co. for extending their present steam plant at Worcester, Mass. The horizontal double acting heavy duty type gas engine built by the Westinghouse Machine Co., Pittsburg, Pa., has been adopted with Loomis-Pettibone producers using bituminous coal.

The new gas engine will be 500 b.h.p. rated capacity, direct connected to a Westinghouse 250 volt 300 k.w. generator running at a speed of 150 revolutions per minute. This unit will operate in parallel with two belted steam units, the entire plant supplying current to the various motor drives in the factory, and also for lighting.

The Westinghouse engine will be of the tandem cylinder single crank style; water jacketed throughout. Pistons will be supported practically clear from the cylinder by front, middle, and rear crossheads. All valves are located directly in the cylinder body in a vertical line; inlet at the top and exhaust at the bottom. A sensitive governing system of the relay type places each inlet valve independently under the direct control of the governor, by which arrangement extremely close speed regulation is secured. Similar engines of this type are now operating the Warren & Jamestown Railway Interurban System at Warren, Pa., at the Carnegie Technical Schools, Pittsburg, Pa., at the Standard Steel Car Co., Butler, Pa., and at the Carnegie Steel Works, Pittsburg. Engines of 3,500 h.p. are now under construction for the latter plant, designed to use blast furnace gas.

At the Norton Co.'s plant the gas used will be a mixture of two gases averaging about 125 B.T.U. per cubic foot. The producer process is intermittent, water gas being made during a short run, and "blast" or "air" being made while the producers are being blown preparatory to the succeeding water gas run. After a thorough cleansing in wet and dry scrubbers, the gas is sent to a holder of sufficient capacity to secure a thorough mixture of the alternating charges of the two different gases. In this case a 20,000 cubic foot holder will be used—sufficient to run the engine for about 25 minutes.

### CANADIAN BERLIN COMPANY.

The new plant that the Berlin Co., Beloit, Wis., wood-working machinery manufacturers, are putting up in Hamilton, Ont., as announced in last issue, will be a large one. Buildings are now projected of the following dimensions: 200x180 feet; 360x50 feet; 100x30 feet; 200x20 feet; 80x40 feet. At least 200 men will be employed at the start. A Canadian company is being formed with a capital of \$500,000.

The ventilating apparatus for the new ward of the Hamilton City Hospital, Hamilton, Ont., is being furnished by the B. F. Sturtevant Co., Boston, Mass. It will consist of a steel plate fan which will insure positive ventilation at all times, a heater, tempering coil and a distributing system.



## BUILDING AND CONSTRUCTION.

### BRICK CHIMNEY OBJECT LESSON.

While the writer was visiting a brickyard, recently, the proprietor called attention to a new brick chimney they had built to take the place of their old smokestack. He said they were led, or really driven into building it, by their old iron stack becoming worn out and full of holes, but since erecting it he had found it such a paying investment that he is sorry he did not do it sooner. He said he was simply astonished at the saving it effected in fuel. He claimed that it actually reduced their fuel consumption 25 per cent. in the steam boiler. It is probable that this is an extreme case. The delapidated condition of the steam iron smokestack probably furnished a better illustration of the economy of a good brick chimney than would obtain in plants where the iron smokestacks were in normal condition. Still, the difference is so wide, and the saving so great, that it furnishes a pretty strong argument in favor of the brick man giving more attention to brick smoke stacks for fuel economy. Nor is that all. It suggests an opportunity for enlarging the field of brick consumption by preaching the doctrine of brick smokestacks instead of iron. If it will save fuel for a brick man, it will save fuel for any man operating a steam plant, and when a thing gives promise of saving fuel, it is not much trouble to get attention for it in the industrial world. This smokestack idea is one that the cement people have promoted industriously, but the brick men, as a rule, appear to have said very little about it with a view to enlarging the market for their product. There are lots of brick chimneys, of course, but how many of these have been inspired by the brickmakers themselves? Probably not many, the brickmakers contenting themselves with the supplying of brick after the idea of building a brick chimney has made itself manifest through other sources. The brick chimney business is not a big thing itself in any community, but every little bit helps, and with the object lesson given by the brickmaker himself in his own experience for a working basis, the brick manufacturers should be able, by proper effort, to encourage the building of more brick smokestacks than would otherwise be built, and to this extent enlarge the market for brick. It all helps, and things of this kind should never be neglected, but kept in mind and made use of when the opportunity presents itself.—The Clay Worker.

### WHEN STARTING A BRICK PLANT.

By T. WELLS, IN THE CLAY-WORKER.

Don't fail to buy and read all the literature on the material you expect to manufacture. Don't fail to take all the trade journals; don't fail to read them.

Don't fail to attend the national convention, and, if possible, attend at least the State convention in which you are located.

Don't feel that because you have found clay or shale on your land that you have found such a priceless treasure that you dare not even tell your friends about it lest they should give away the secret, or if you do communicate the good news to your friends, it must be in a whisper lest some one will hear

you. Don't feel that all other brick manufacturers are your enemies. You have no greater friends on earth. There is a fraternal good feeling among clayworkers toward and for each other which is hard to find in any other class of men.

Don't fail to visit ten or twelve plants such as the one you expect to build.

Don't fail to introduce all the labor and coal-saving devices possible.

Don't fail to avoid a multiplied system of turntables and transfers; one transfer between the machine and dryer and one between dryer and kiln should be all that is necessary.

Don't fail to remember that because a man has been a success at one place he may not be for you; some men fail to adapt themselves under different environments. Don't fail to remember that he may have been only a tool in some one else's hands, and not the head.

Don't fail to have your agreement with the railway company before you turn sod for the plant.

Don't fail, if you are going to make paving brick, to know where you are going to find a market for your second grade and culls. Don't be flattered with the idea that you won't get any.

Don't fail to remember that after every precaution you may lose every cent. of your own and other people's hard-earned money.

Don't be discouraged; there is money in the clayworking business, only get into it with your eyes wide open.

### ROMAN USE OF CONCRETE.

The use of concrete masonry probably begins with the Romans, who employed it in road building and foundation work. Coming down from the time of the Romans, says the Scientific American, the ancient city of Ciudad Rodrigo has walls existing at the present day in which are buried large boulders of stone. These walls are in a good state of preservation at the present time; in fact, so much so that they still bear the prints of the boards which made up the forms which held the concrete in its semi-liquid state at the time it was put in. It is an interesting matter to note that the modern practice of putting large masses of stone in concrete masonry follows exactly the scheme used in building these ancient walls of Ciudad Rodrigo. This method not only reduces the cost of the resulting fabric, but also makes it stronger.

### MILL VENTILATION.

Mr. Osborne, the late factory inspector in England, in referring to this matter of ventilation has said that the use of fans, both for blowing in and exhausting air is the cheapest and most effective system for such buildings as weaving sheds, owing to the large cubic space (some containing more than 8,000,000 cubic feet), and the consequent impossibility of bringing uncontaminated air from the side inlets to the central parts.

The point here made will be appreciated when attention is called to the very wide buildings that are now a part of mill construction. It is the ventilation of the central portion that is the most difficult to obtain.

Another English factory inspector made the remark some time ago that "the figures shown for cotton weaving are of special interest in view of the prophecies freely made not long since to the effect that the increased stringency of the sanitary regulations made in 1898 by the Secretary of State for artificially humidified cotton factories would cause the occupiers of the factories to relinquish the use of artificial humidity rather than comply with the regulations."

"So far from this being the case," he says, "the number of cotton weaving factories with artificial humidity steadily increased," a fact that, he thinks, shows that the improved sanitation insisted upon has not had the inimical effect upon the industry that some people feared.

He mentions a conspicuous example of a manufacturer who installed at a great expense an improved system of ventilation in his weaving sheds, in which nearly 2,000 operatives are employed. He took a sample of air from the middle of a number of the sheds and found that the carbonic acid therein averaged 7.37 volumes per 10,000 only; a condition as good as that to be found in our best ventilated buildings.

The manufacturer referred to has adopted other improved methods, such as providing a purer steam for moistening purposes and in fitting up electric lighting in place of gas.

### IMPORTANT TESTS IN BUILDING MATERIALS AND FUELS.

For some time past the United States Geological Survey has been conducting a series of experiments on the Exposition Grounds at St. Louis with coals, lignites and other fuel substances, which have proven satisfactory to the engineers and others in charge. It has been stated that the people of this country spent about \$1,500,000,000 for fuels during the last year, and the officials of the Geological Survey say that if the results of their investigations can save to the country even one per cent. of this expenditure, the investment will certainly be a good one.

This branch of the government has also been conducting experiments with structural materials entering into the construction of public and other buildings. The money being spent by the government on its public buildings and its great engineering projects, such as the Isthmian Canal, and through the different branches of the army and navy, will aggregate from 40 to 50 million dollars. In addition the amount spent by different cities and states and by the people generally in engineering and constructing work during the past year has aggregated more than \$1,000,000,000. "In all of this work, both by the government and by the people in all parts of the country," said Director Walcott, of the Geological Survey, "building materials are being used that are but little understood and the general sentiment of the engineers bears out the statement that these materials are used wastefully, and in many cases with great uncertainty.

"The German government has built large testing works, and is carrying on extensive investigations, and it seems to me to be an

excellent use of money in getting practical results that will be of permanent service and value not only to the government, but to the people of the country. There is a great necessity for the government to make these tests for the purpose of securing the best and most economical fuel and material in the work that it is doing. As a people we have a coal supply that nature has given us and if we can make that supply go two or three times as far as it normally would under existing conditions, the benefit will go to the nation, to the people as a whole and to the government. In the tests thus far carried on I think it has been demonstrated and accepted by engineers and experts that the energy of coal, which can be obtained has been clearly shown to be two and one half times what it was four years ago."

Mr. Walcott was asked if this increased energy resulted from the utilization of more of the heat units than has been used before in consuming fuel, to which he replied: "It is in the making of gas and using it through the gas engines in the form of fuel instead of burning the coal under a boiler to produce steam. That is wherein the benefit comes. Our greatest work has been in showing how new processes could be made use of in burning our various coals and lignites for heat, power and light. This applies also to lignites and peats."

Prof. Holmes of the Geological Survey is of the opinion that cement and concrete will in the course of time supplant the use of iron and steel in the construction of the framework of buildings. "During the next ten years the expenditures of the government for building and construction work will exceed \$100,000,000," said Mr. Holmes. "During this period the amount expended by the people of the country will approximate \$10,000,000,000. The purpose of the investigations will be to indicate how the structural materials can be used most efficiently and economically."

During the past two years the Geological Survey has tested more than 85 different kinds of coals from 17 states in the country, from which 1,600 chemical analyses have been made. In these tests it has been found that in the mining of coal in the United States fully 50 per cent. of the coal remains in the ground. It has also been found that from 5 to 10 per cent. is lost in handling and transportation.

#### HINTS re ROOFING.

In roofs, concrete slabs, 3 inches thick, may be used for spans up to 8 feet and 4-inch slabs up to 12 foot spans.

A good rule to use in calculating roof trusses of the ordinary kind is to take the snow and wind load combined at 30 pound per square foot of horizontal projection for all slopes. This will fit all ordinary cases; if the roof is flat, that load is produced by snow alone; if the slope is greater than 45 degrees, in which case the snow load need not be considered, it is all wind, and proportionately for intermediate slopes.

The weight of roof covering of different kinds per square foot of sloping surface may be assumed as follows: Corrugated steel, 3 pound; slate on 2-inch plank, 15 pound (add 3 pound for each additional inch in thickness of plank); tar and gravel on 2-inch plank, 13 pound (add 3 pound for each additional inch in thickness of plank);

tar and gravel on 3-inch concrete, 32 pound (add 8 pound for each additional inch in thickness of concrete); slate on 3-inch book-tile, T purlins, 26 pounds.

Large roofs should be proportioned to carry, in addition to their own weight: A live load, representing snow, per horizontal square foot of roof of: 15 pounds for all slopes not exceeding 35 degrees; and 10 pounds for all slopes between 35 and 45 degrees. The possibility of a partial snow loading should also be considered. The snow load can be neglected in certain climates, also in roofs having slopes exceeding 45 degrees, providing that there are no snow guards or other obstructions.

#### THE USE OF CONCRETE.

Practically speaking Canadians have merely begun to realize the importance of reinforced concrete for construction purposes, and in spite of the amount of literature published on the subject, there are many, even in the building trade, who do not understand its application.

In a recent interview, in an exchange, Henry Holgate, vice-president of the Dominion Engineering & Construction Co., and one of the acknowledged Canadian authorities on the use of concrete, gave some interesting information in this regard, which is herewith repeated:

"The extensive use of reinforced concrete," said he, "is a matter of such recent growth in Canada that it is no wonder that the public has not grasped the full significance of its adoption in important structural enterprises. It is only a question of time, however, when its qualities will be as well known as those of brick or stone, which materials it is fast supplanting for building purposes wherever its advantages are appreciated.

"Concrete is composed of cement, sand and gravel or crushed stone. As cement is easily available, and as sand and gravel abound, it follows that concrete can be advantageously made in any part of the country. As concrete possesses in itself great power to withstand compression stresses, it has proved of tremendous value in building canals, retaining walls, and all manner of construction work where it is not subjected to great tensile stresses. When a structure is designed to meet tensile stresses, like a sky scraper or a large factory it becomes necessary to use in connection with the concrete some materials capable of taking up this additional burden. Steel does this to the best advantage, and when employed in conjunction with the concrete, furnished the combination known as 'reinforced concrete.'

"Concrete alone is cheaper than stone or brick, but steel is extremely expensive, so that the problem confronting the man who designs a structure of reinforced concrete is how to use the minimum of steel and yet get out of it the maximum of strength. He aims to distribute his reinforcing rods in such a way that each will supplement the other and all will supplement the concrete. If he does this successfully he produces a monolithic structure in which every strain and stress, no matter how great, is distributed through and borne by the whole.

"As soon as architects, engineers and contractors began to use reinforced concrete for complicated work, numerous methods of reinforcement were invented. All these methods

aim to increase the load-bearing power of the concrete and to insure accuracy of construction, and all have their advocates. It can not be doubted, however, that the best mode of procedure is to design the reinforcement not only so that it will fill its own function efficiently, but so that it will contribute its proper part toward strengthening the structure as a unit.

"It goes without saying that skill and experience in the use of reinforced concrete are requisites without which no successful structure of this kind can be either designed or erected. Not only must the design be without flaw, but the actual construction work must be done under the closest supervision to insure reliability. The reinforced concrete structure once successfully completed will stand practically forever, for the older concrete grows the harder it becomes. One of its most important attributes is its resistance to fire. To all intents it is fireproof. Steel is not, but imbedded in concrete steel is so well protected that the combination, or reinforced concrete, is as fireproof as concrete alone. This was the great lesson taught by the San Francisco disaster and by the Baltimore fire. The fire-resisting quality of concrete carries its own sequel; insurance rates on concrete structures are so low as to be almost negligible. In connection with its use with steel, concrete has another remarkable and unique advantage; it protects the steel absolutely from rust—something that no other material yet discovered has been able to do."

#### DUTY ON ARCHITECTS' PLANS.

The government have adopted new rules for guidance in the entry and appraisalment of architects' plans, as follows:

Rates of duty on drawings, blue prints and building plans 20 per cent. ad valorem. Specifications, however, are free as "manuscript" when written or typewritten.

Special plans of building or blue prints as substitutes therefor are to be valued for duty at charge usually made by architect for drawings without specifications. This charge may be fixed for duty purposes at one per cent. of estimated cost of building to be erected.

Detailed drawings or blue prints as substitutes therefor, if imported separately, are to be appraised at valuation of one per cent. of estimated cost of such detail.

When building is estimated to cost less than \$10,000, plans or blue prints thereof may be appraised at usual charges for furnishing same, according to the special circumstances in each case, irrespective of the preceding rule.

Blue prints of copies of building plans may be admitted at cost of production when duty has been once paid on original or copy in Canada.

Blue prints or cars and machinery, being copies of standard designs, may be valued for duty at 75 cents per pound.

The Supreme Court of Georgia held, in the case of Watson vs. Augusta Brewing Co., that a company manufacturing and bottling a beverage was liable to a person injured by swallowing pieces of glass while drinking from a bottle which he had procured from a merchant, who had purchased the same from the manufacturing company.

**HIGH TENSION SWITCH.**

The Toronto & Hamilton Electric Co., Hamilton, Ont., are finding a demand for a new switch which they are making. This switch, which is shown in the accompanying sketch, is used largely on high potential circuits, to open the main line to affect repairs, make alterations, etc. It is also used in main and sub-stations as a selector switch for connecting up transformers. It is intended to ensure the safety of the operator, it being opened from the ground by a long hooked pole.

**THE LABATT MFG. CO.**

The style of Canadian Brass and Supply Co., London, Ont., has been changed to the Labatt Mfg. Co. The company is to be enlarged and extended, and besides plumbers' supplies the company will manufacture power and waterworks machinery on a large scale. Branch offices will be continued at Toronto and Winnipeg, the Toronto office being moved to 367 Queen Street West.

**LOW SUMMER TOURIST RATES WEST.**

During the entire summer the Chicago & North-Western Railway will have in effect very low round trip tourist rates to Colorado, Utah, California, Oregon, Washington and British Columbia points. Choice of routes going and returning with favorable stopovers and time limits. Very low excursion rates to the Pacific Coast from June 25th to July 7th. For further particulars, illustrated folders, etc., write or call on B. H. Bennett, General Agent, 2 East King St., Toronto, Ont.

Prof. A. P. Coleman, of the Ontario Bureau of Mines, speaking of the world's production of nickel in a recent report of the Bureau, says:—The only real competitor of Ontario as a nickel producer is the French penal colony of New Caledonia. Though the United States has dropped out of the race as a producer of nickel ore, it is still one of the most important countries for the refining and utilization of the metal nickel, much the greater part of the Canadian metal being treated at Constable Hook, New Jersey. The Sudbury nickel field has long been known as the most important source of that metal in America, if not in the world, but the work of the last three years has brought out more and more strikingly the unique character of this mining region. It has been proved that all the ore deposits of any economic importance are at or near the outer margin of a huge laccolithic sheet of eruptive rock a mile and a quarter thick, 36 miles long and 17 miles wide. This sheet is now in the form of a boat-shaped syncline, with its pointed end to the south-west and its square end to the north-east. The rock composing this sheet is norite at the outer and lower edge, merging into granite or granodiorite at the inner (upper) edge. The ore bodies are round the margin of the norite, or along dike-like offsets from it, and have evidently segregated from the rock while still molten, though they may have undergone later rearrangement by circulating water. In a chapter devoted to the uses of nickel it is pointed out that Switzerland, Austria-Hungary, and France within the last few years have adopted pure nickel instead of the nickel-copper alloy for their coinage. The pure

metal does not tarnish or change color, but keeps bright and attractive, and, as it is harder, the imprint stands wear much better. It is more difficult to counterfeit, since the minting requires more powerful presses. "Why," asks Professor Coleman, "should not Canada, the producer of half the nickel of the world, replace her ugly cents by clean, untarnishable nickel coins, almost as handsome as silver and much more durable." Canada is presently to have a mint, and it

and securely attached to it by a thumb screw. No extra handle is provided, as the extension is tapped to receive one of the stock handles. The ratchet may be adjusted for turning the stock in either direction. This tool should be of great service to pipe-fitters, enabling them to use regular stocks for threading pipe in positions where they would otherwise have to take down the pipe.

He has achieved success who has lived well, laughed often and loved much; who has gain-

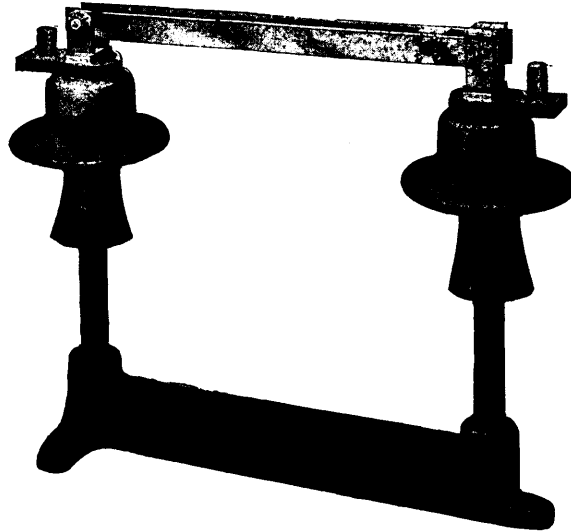

T. &amp; H. HIGH TENSION SWITCH.

should begin its work by coining one-cent and five-cent pieces of pure nickel, making use of a distinctively Canadian metal. The nickel production of the Sudbury field for the calendar year, 1904, is given as 4,729 tons, valued at \$1,513,280, and the total production of the district since the discovery of the nickel deposits there up to and including the year 1904, at 43,877 tons, valued at \$12,660,069.

A ratchet attachment for die stocks has been placed on the market by the Armstrong Mfg. Co., of Bridgeport, Conn. The frequent necessity for doing pipe work and for making alterations and repairs to piping in close and cramped quarters has brought several ratchet stocks on the market. The Armstrong ratchet consists of a malleable iron ring carrying the ratchet and pawl, and which is slipped over the barrel of the stock

ed the respect of intelligent men and the love of little children; who has filled his niche and accomplished his task; who has left the world better than he found it, whether by an improved poppy, a perfect poem or a rescued soul; who has never lacked appreciation of earth's beauty or failed to express it; who has always looked for the best in others and given the best he had; whose life was an inspiration; whose memory a benediction.

If the engine stops suddenly the trouble can be attributed to an ignition fault. If it slows up, then the fault will most likely be in the mixture of gas supply, or to the battery running down. Misfiring can generally be put down to a sooty plug or exhausted battery. If the engine slows up and stops, then after a minute or two starts up again and runs for a mile, it is a sure sign that the battery is down.—The Gas Engine.

**Berg Brick Machinery.**

One not acquainted with modern methods of manufacturing brick would probably be much surprised, in an examination of a thoroughly up-to-date plant, to note the great weight and exceptional power of the brick presses installed.

In fact a close examination of an improved Berg press, of which an illustration is given on page 35, would emphasize the fact that as much mechanical genius had been devoted to its manufacture and as high a point had been reached in its development as in the machinery used by any class of manufacturer.

The Berg press was invented in 1898 by Anton Berg, then of Chicago, now of Toronto.

In 1905 improvements to this model resulted in the present machine. Over 150 plants have installed this press in the United States. Installations have also been made throughout Europe.

About eighteen months ago Mr. Berg turned his attention to the Canadian market and already fourteen plants have been equipped in this country, under his personal direction, with his presses. In the majority of cases these plants have two or three presses.

The essential qualities of a good brick machine are that it be absolutely simple in all parts, so that the brick maker need not be a mechanic; that it be capable of putting all kinds of brick making material in perfect



ANSON BERG, INVENTOR OF THE BERG BRICK PRESS.

form; that it be absolutely unbreakable in legitimate work and that it should have all its bearings above the clay-line.

As the weight of the Berg press is 14 tons and as its strength is correctly placed, a working pressure of 400 tons on each brick is maintained. The pressure can, however, be increased to 1,700 tons without overstraining the machine.

Yet, notwithstanding this great weight the Berg press is a model of simplicity. Mr. Berg's intention in designing his press was to discard unnecessary parts, strengthen every weak point and to overcome defects which he had found in machines he had been familiar with while in the service of one of the largest brick machinery firms in the United States. His success has been such that the mechanical feature of his press is that it is stripped of unnecessary bearings, joints, working and wearing parts and that though it will press any brick material it is practically unbreakable and never out of working order.

The productive features of the improved Berg press are that it will put an exceptional amount of clay into a brick; that Roman and shape brick, or square blocks, can be made without change of tables or loss of time; that only one-half hour is required to change one mould to an ornamental shape, and all four moulds can be changed in less than an hour.

The machine runs smoothly and noiselessly, without backlash or jar even in the heaviest work.

It will work any kind of brick-making material, all the brick being of exactly the same size and thickness, with polished faces and strong edges and corners, and without any sign of granulation through the centre of the brick. The thickness of the brick can be changed in two minutes without the use of shims or adjusting plungers.

Plungers and plates are adjustable, both upper and lower.

The feeding mechanism is so arranged that the lower plates remain up until the charger has passed entirely over them, thus filling

the moulds evenly instead of allowing the clay to roll to the front end of the mould on account of lower plates dropping too soon.

This machine, as originally built, has three distinct pressures and an up-and-down movement of the clay in the moulds. First presses from the top, then from the bottom, then it presses the centre and relieves, then comes the third pressure from both top and bottom together, with the movement of the clay under pressure in the moulds; then the lift-out. This press also gives an unusually long dwell on the brick while in the mould.

The Berg press is built of the strongest materials securable, the parts subject to strain being of hammered steel with steel cut gearing and in every way the best workmanship has been devoted to its manufacture.

A. Berg & Sons, in addition to this press, make complete brick-making outfits for either clay, shale, cement or sand-lime. This makes it possible to equip a plant according to the raw materials at the disposal of the brick manufacturer. The firm make an exceptional guarantee of all plants they instal. Each installation is made under the personal supervision of Mr. Berg and thus the guarantee is to the effect that it will make the prescribed number of brick up to a certain standard of quality, or it need not be accepted.

Each press is capable of producing 20,000 bricks per day of ten hours. The sand-lime brick process is the newest and, at the same time, the most remarkable. With it brick can be made one day and built into the wall the next day. This process includes steaming in steel cylinders at a temperature of 125 degrees. The clay or shale bricks are burned in the ordinary way.

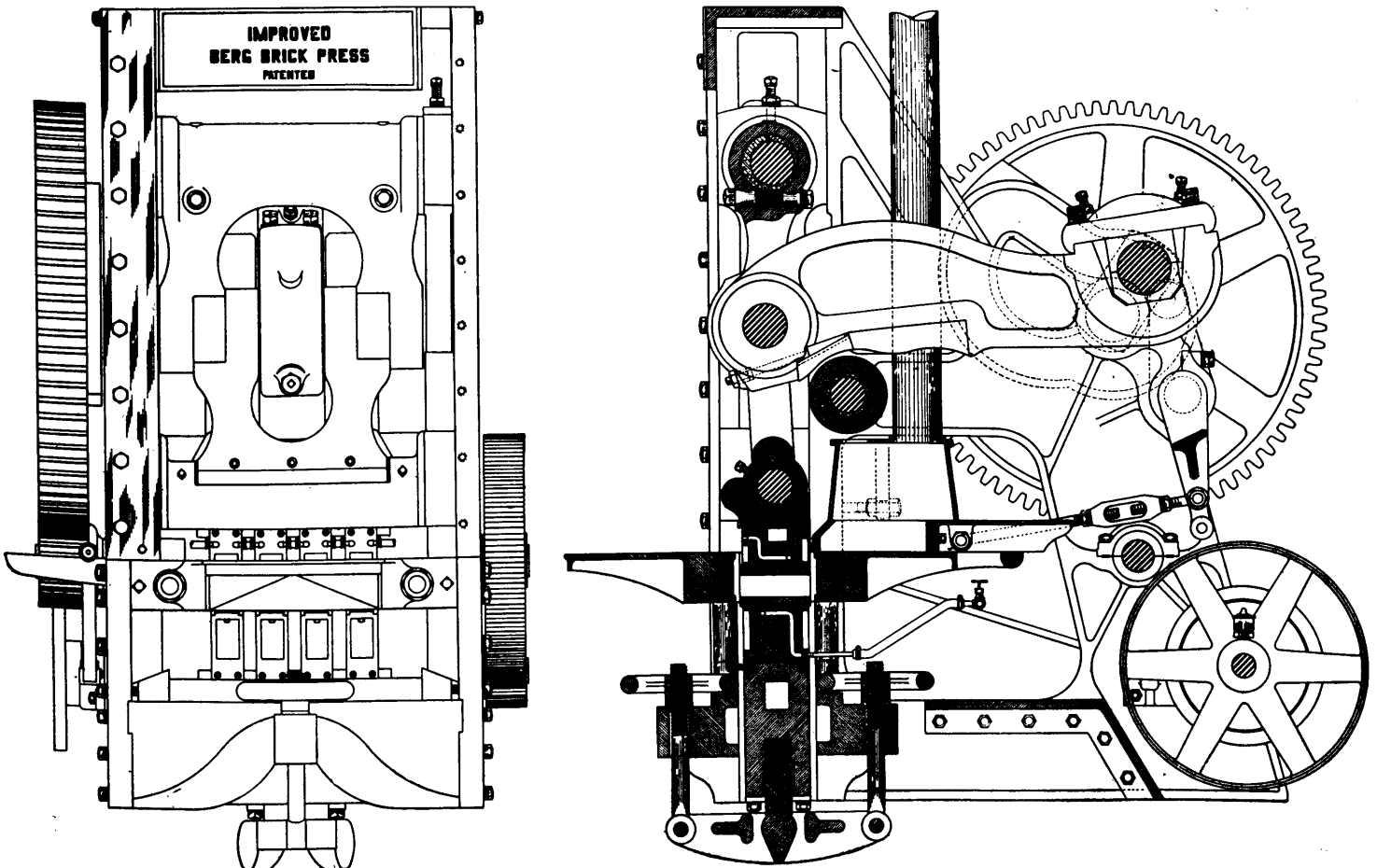

SECTIONAL VIEWS OF THE BERG BRICK PRESS.

When writing to Advertisers kindly mention THE CANADIAN MANUFACTURER.

Phone  
PARKDALE 1809



Post Office and  
Telegraph Address:  
SWANSEA, - ONT.

Vitrified  
Salt-Glazed

# SEWER PIPES

In Sizes from  
4 in. to 24 in.

Manufacturers of  
PRICE LIST AND DISCOUNTS ON APPLICATION.

**THE DOMINION SEWER PIPE CO., Limited** - Works and Office, **SWANSEA**  
(near Toronto)

INTERNATIONAL

# FIRE

## INSURANCE RATES



Reduced 40 to  
70 per cent. by  
equipping your  
buildings with

### INTERNATIONAL AUTOMATIC SPRINKLERS



Our systems com-  
mended by all insur-  
ance bodies.

"Full Size"

## W. J. McGUIRE & CO.

TORONTO AND MONTREAL.

# WANTED

## Building Specialties

We desire the exclusive agency  
for a few BUILDING MA-  
TERIALS and APPLIANCES  
of merit, which by our energy  
and influence, we can perma-  
nently introduce in San Fran-  
cisco and throughout the Pacific  
Coast. . . . .

**A. Fleishhacker & Co.**  
BUILDING SPECIALTIES  
362 Grant Ave., San Francisco

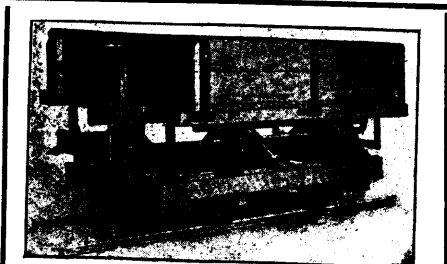

# Cars! Cars! Cars!

of all descriptions for  
ORE, BRICK, COAL, TRAM, MINE, COKE, FOUNDRY, RAILWAY  
PUSH AND HAND CARS

SPECIAL CARS CONSTRUCTED UPON RECEIPT OF SPECIFICATION  
LIGHT RAILS AND SWITCHES

# F. H. HOPKINS & CO., MONTREAL

When writing to Advertisers kindly mention THE CANADIAN MANUFACTURER

What's  
in a  
Name

SIMPLICITY  
**B**  
STRENGTH  
DURABILITY

ACCESS  
**E**  
TO ALL  
PARTS

GREATEST  
**R**  
PRESSURE

BEST  
**C**  
PRODUCT

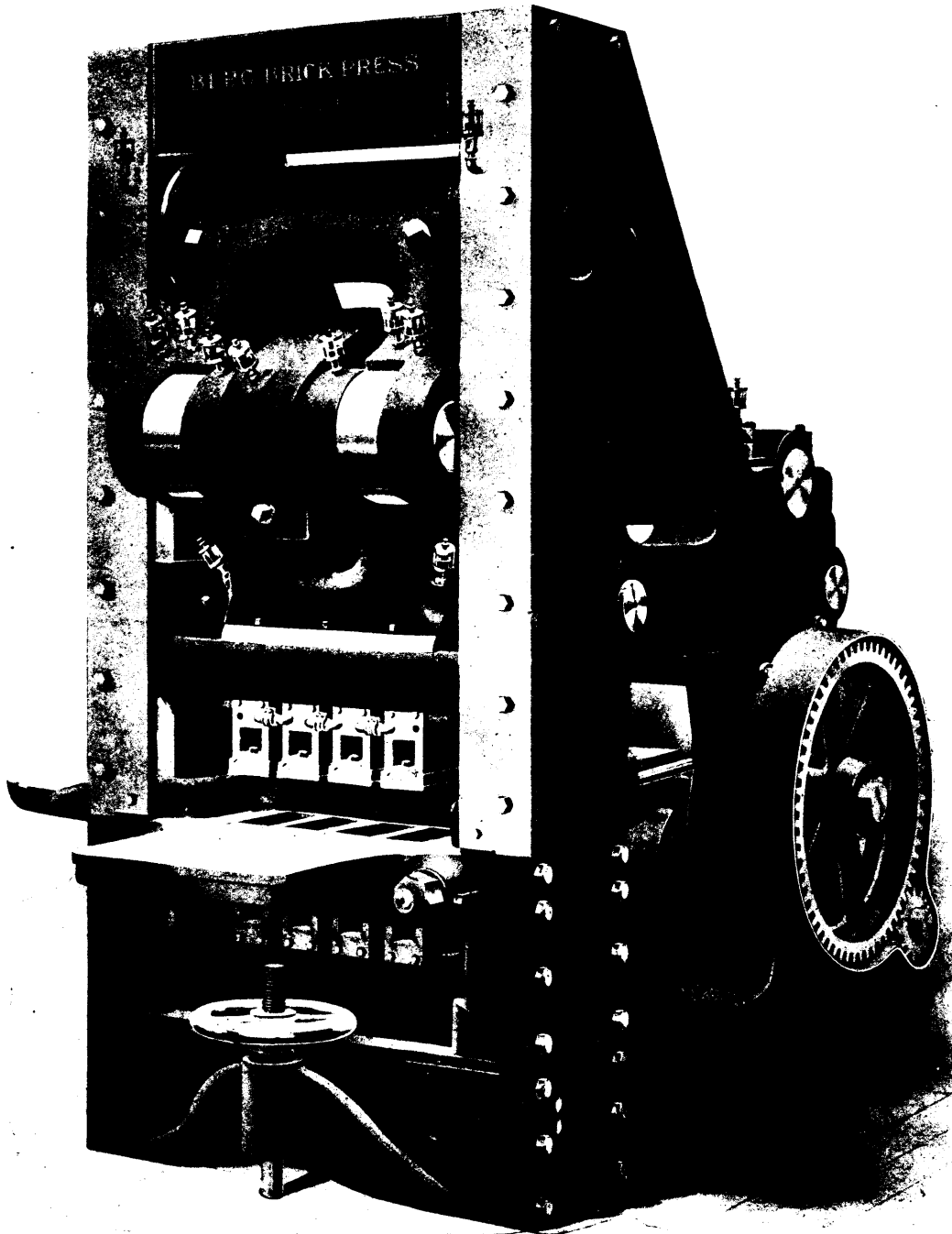

IMPROVED BERG BRICK PRESS.

The BERG is built for quality, for simplicity and for strength.



The BERG is built for work; long work; hard work; steady work—and it never fails to do its work, day after day, year after year.



The Berg saves the most time and saves the most labor—and it makes the most money for the brick manufacturers.





Correspondence invited.

Manufactured by its inventor in Toronto, Canada, exclusively.  
All equipment for Pressed Brick Plants to make Sand Lime Brick, Sand Cement Brick, Shale Brick, Clay Brick and Fire Brick.

**A. Berg & Sons,** Manning Chambers  
TORONTO, CANADA

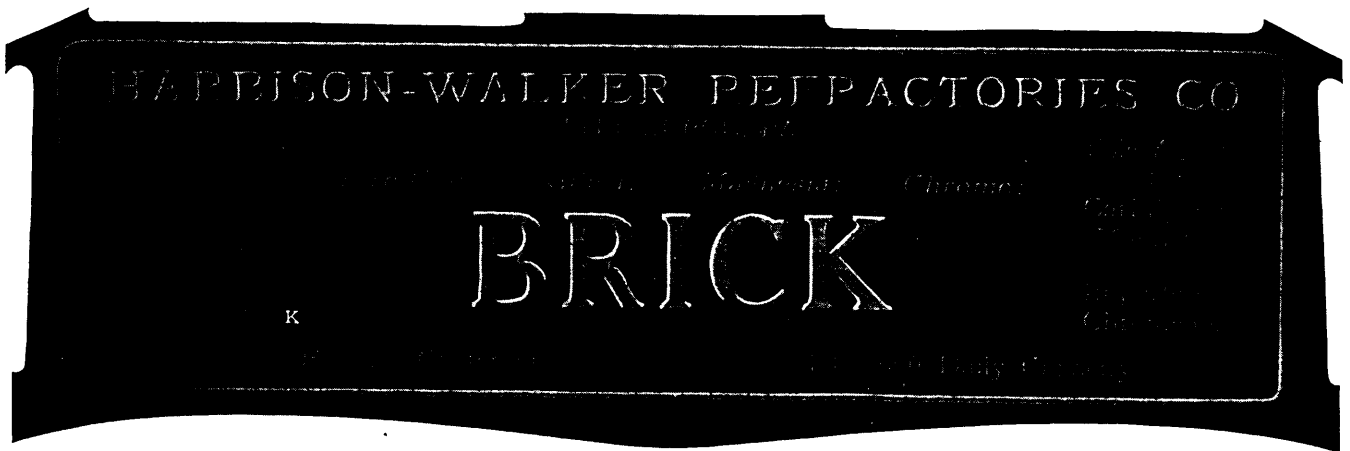
When writing to Advertisers kindly mention THE CANADIAN MANUFACTURER





**T**WO good points, among many others, in favor of McCullough-Dalzell Crucibles: They will not "skelp;" each holds three pounds of molten metal to the number. Write for prices to-day.



**MCCULLOUGH-DALZELL CRUCIBLE COMPANY, - PITTSBURG, PA.**

Canada's foreign trade continues to show steady and remarkable growth. Figures have just been issued covering the ten months to the end of April. The aggregate inward and outward trade for this period exceeds that of any similar period in the

history of the country, reaching the large sum of \$435,000,000, which is at the rate of \$522,000,000 for the year. The aggregate for ten months represents a gain of \$69,000,000 over the same period last year, an increase of about 16 per cent. The value of

exports during the ten months was \$189,000,000, as compared with \$153,000,000 for the same ten months of the previous year, a gain of nearly 20 per cent. Imports are valued at \$225,000,000, as compared with \$200,000,000, or less than 12 per cent.

## TO THE VARNISH BUYER

the most serious considerations are quality, reliability and uniformity, and these qualifications are of special importance to the dealer who is trying to build up a permanent varnish trade.

Berry Brothers' label or brand may be safely relied upon as ensuring the above conditions.

Our Varnishes are the safest goods to handle and the surest and most reliable goods to use.

### BERRY BROTHERS, Limited

VARNISH MANUFACTURERS

WALKERVILLE, ONT.

Write for our 100 page illustrated catalogue. Every dealer should have a copy for reference.

# "ACME" BRAND

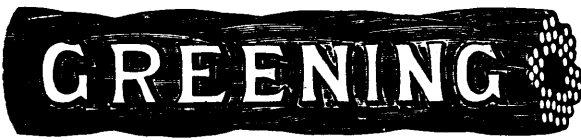

HIGHEST GRADE OF HOISTING ROPE MADE  
 EXTRA TENSILE STRENGTH FOR HEAVY WORK  
 USE GREENING'S ROPE GREASE FOR LUBRICATION

HAMILTON, Ont. The B. GREENING WIRE CO., Limited MONTREAL, Que.

## MONTREAL PIPE FOUNDRY CO., LIMITED

SUCCESSORS TO

DRUMMOND-McCALL PIPE FOUNDRY CO. (Limited)

"Specials," Hydrants, Valves, Etc.

Manufacturers of



Offices: - - - Canada Life Building,  
 MONTREAL

James Thomson, Pres. and Man. Dir. J. G. Allan, Vice-Pres. James A. Thomson, Secretary. Alex. L. Gartshore, Treasurer.

### The GARTSHORE-THOMSON PIPE & FOUNDRY CO. LIMITED



3 in. to 60 in. diameter.  
 For Water, Gas, Culverts and Sewers Special Castings and all kinds of Flexible and Flange Pipe  
 WATER WORKS SUPPLIES HAMILTON, ONT.

## BANK OF HAMILTON

J. TURNBULL, General Manager  
 HEAD OFFICE, - HAMILTON, ONT.

Capital.	Reserve.	Total Assets.
\$2,500,000	\$2,500,000	\$29,000,000

90 Branches Throughout the Dominion of Canada.

Collections made in all parts of Canada on most favorable terms.

F. W. HORE & SON, Limited, HAMILTON, ONT. Manufacturers of CARRIAGE, WAGGON, AND SLEIGH WOOD WORK.

W. H. STOREY & SON, Limited, Acton, Ont. Manufacturers of... FINE GLOVES and MITTS In every variety and style, Moccasins

# The GRIFFIN Mill

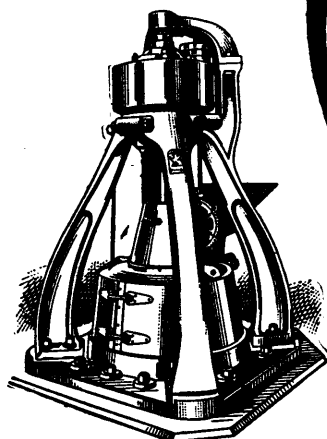

### The Greatest Pulverizing Machine in the World

Used Wherever Portland Cement is Made

OVER 50 PER CENT. OF THE PORTLAND CEMENT MANUFACTURED IN THE UNITED STATES TO-DAY IS GROUND IN THE GRIFFIN MILL.

The Griffin Mill pulverizes more cement than the combined output of all other machines used for this purpose.

Thoroughly tested by continually successful and constantly increasing use during the past sixteen years.

Portland Cement Clinker reduced from 1/2 inch to required fineness in one operation, with no auxiliary apparatus. No other machine made will do this.

Buy the GRIFFIN MILL and get the BEST. It holds the world record from every standpoint.

Send for Catalogue and full information.

Bradley Pulverizer Company, 92 State St., Boston



When writing to Advertisers kindly mention THE CANADIAN MANUFACTURER



THESE SHORT "ADS" SHOULD HAVE YOUR ATTENTION TO-DAY.

**FACTORY LOCATIONS.**

The following Canadian municipalities are offering inducements to secure manufacturing establishments. Inquiries should be addressed to the Mayor, Town Clerk or Board of Trade of the respective cities:

- Barrie, Ont.
- Brantford, Ont.
- Hamilton, Ont.
- Peterborough, Ont.
- Regina, N.W.T.
- Sherbrooke, Que.
- Toronto, Ont.

**BOILER FOR SALE.**

Fifty Horse Power Boiler—used one year; fittings complete; will sell cheap.  
H. DICKENSON,  
607 Sherbourne St., Toronto.

**FOR SALE, CHEAP!**

Fine 3-story brick factory building, besides other storage buildings. If you are contemplating starting a branch in Canada this is a grand opportunity. Cheap electric power and natural gas. For further particulars apply to  
WM. CHAPLIN,  
St. Catharines, Ont., Canada.

First-class mills use

**LOWELL CRAYONS WHY? THEY ARE WORTH THEIR COST.**

Will you try our Samples?  
LOWELL CRAYON CO., - Lowell, Mass.  
Original Manufacturers.

**WM. BARBER & BROS.**  
Georgetown, Ont.

Manufacturers of.....

**Book and Fine Papers.**

THE.....

Toronto Paper Manufacturing Co.,  
Cornwall, Ont.

Manufacturers of Engine Sized Superfine Papers, White and Tinted Book Papers, Blue and Cream Laid and Wove Foolscaps, Account, Envelope and Lithographic Papers, etc.

**R. SPENCE & CO.**  
HAMILTON, ONT.

**FILE and RASP MANUFACTURERS AND RE-CUTTERS.**

A trial order solicited. Write for terms.  
C. P. MOORE, PROPRIETOR.

**RAWHIDE GEARS**

MANUFACTURED BY  
THE HORSBURGH & SCOTT CO.  
Cleveland, Ohio.

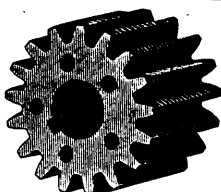

**Cheap Power for Sale**

Twenty h.p. for forty cents a day; thirty h.p. for sixty cents a day; fifty h.p. for a dollar a day; same proportion for larger or smaller powers. This is not Niagara electric power, but it is cheaper, better, and, above all, safer; information free for the asking. W. Gillespie, 98 East Front Street, Toronto.

**THE BEST GASOLINE ENGINE**

On the continent for all purposes is the Sylvester. Parties wanting cheap power will consult their own interest in purchasing a Sylvester, built in sizes 1 1/2 to 32 horse power; portable, stationary and marine; best and cheapest power available; if you want an easy starting, simple and reliable engine that will give full rated power in coldest weather, buy the Sylvester; works as easy in January as July on gasoline, coal oil or distillates; write for catalogue. **The Sylvester Mfg. Co. Limited, Lindsay, Ont.**

*The Howe-Buller Co.*  
CLEVELAND, O.

**FIRE BRICK** SILICA FIRE CLAY  
ALUMNITE  
SILICA CEMENT

MAGNESITE BURNT MAGNESITE

Our factories are the most complete in the country. Located in Pennsylvania, Ohio, and Kentucky—and controlling the largest known bodies of Refractory materials for different work. Operated by experienced managers. We manufacture material for all heat work—second to none.  
Capacity over 200,000 Brick and Special Shapes per day Write for catalogue.

**Dominion Oil Cloth Co.**

LIMITED  
Manufacturers of **Oilcloths** of Every Description.

Floor Oil-Cloth, Table Oil-Cloth,  
Carriage Oil-Cloth, Enamelled  
Oil-Cloth, Stair Oil-Cloth, etc.

OFFICE AND WORKS:  
Cor. St. Catherine and Parthenais Streets  
MONTREAL, Que.

**Keep Posted on Coal**

You will save money by reading THE RETAIL COALMAN. We guarantee the largest paid circulation of any coal trade paper. That's the best proof of its practical worth and genuine merit.

**A Whole Year for only \$1**

Sample Copy free for the asking.  
Special attention given Canadian news.

THE RETAIL COALMAN,  
1536 Monadnock Building,  
CHICAGO, ILL.

**JOHN J. GARTSHORE**

88 Front St. W., Toronto.

**Rails and SUPPLIES,**

New and Secondhand,  
For RAILWAYS, TRAMWAYS, Etc.  
Old material bought and sold.

Send for Catalogue and Price List to



Mfrs. of Set, Cap and Special Screws, Studs, Finished Nuts, etc.

**GASOLINE ENGINES**

FOR LAUNCHES AND CANOES.  
2-H.P. ENGINE COMPLETE FOR \$65.  
M. O. CROSS ENGINE CO.  
DETROIT.

**CANADIAN OFFICE & SCHOOL FURNITURE CO. LIMITED**  
PRESTON ONT.

FINE BANK OFFICE, COURT HOUSE & DRUG STORE FITTINGS. OFFICE, SCHOOL, CHURCH & LODGE FURNITURE. SEND FOR CATALOGUE.

WORK AND PRICES RIGHT  
**GALVANIZING** ONT. WIND ENGINE & PUMP CO. TORONTO, ONT. LIMITED

**CASTINGS** GREY IRON  
IN ROUGH OR MACHINED.  
**PATTERNS** WOOD OR IRON.  
ESTIMATES FURNISHED.  
**DAVID MAXWELL & SONS**  
ST. MARY'S, ONT.

**WOOD ENGRAVING**  
**PHOTO ENGRAVING**  
**HALF TONES**  
OR ANY CLASS OF ENGRAVING FOR ADVERTISING PURPOSES. CATALOGUES, MAGAZINES, &c.  
**J. L. JONES ENG. CO.**  
**'168 BAY ST.-TORONTO**

# CORRUGATED IRON

“Keeping Everlastingly at it Brings Success.”

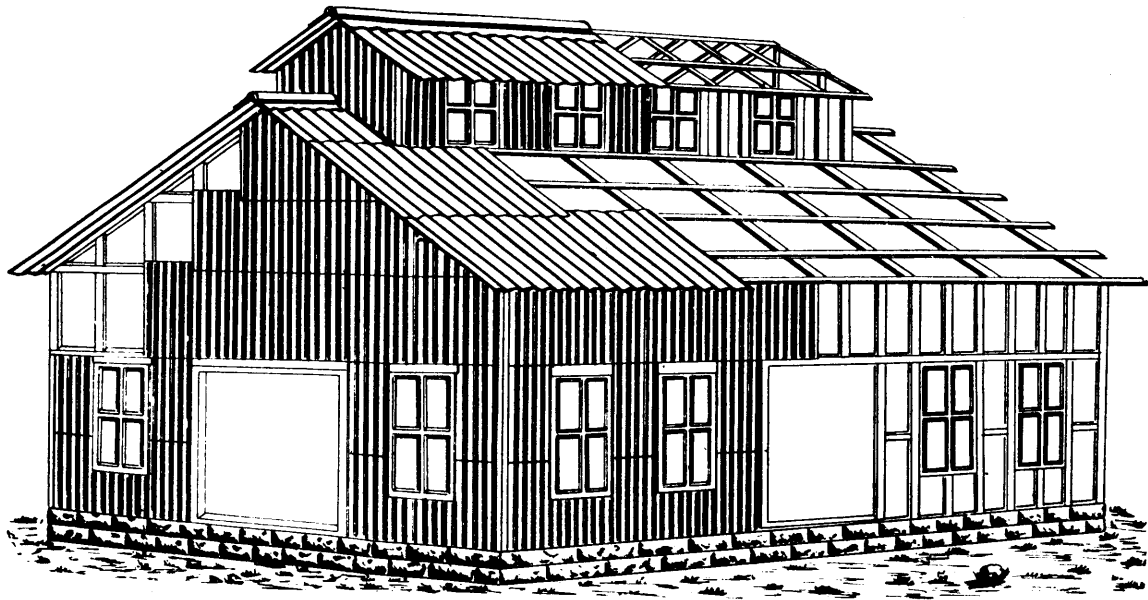

**PEDLAR'S CORRUGATED IRON** is made on a 38,000 lb. Press (the only one in Canada) one corrugation at a time, and is guaranteed true and straight to size.

We carry a 600 ton stock in Oshawa, Montreal, Ottawa, Toronto and London and can ship ordinary requirements the same day order is received.

Made in 1", 2", or 2 $\frac{3}{4}$ " corrugations in sheets any length up to 10 feet in 28, 26, 24, 22, 20, 18 gauge, both painted and galvanized.

This class of material is most suitable for fireproofing, **Factory, Mill, Barns and Warehouse Buildings** and is water and wind proof.

Corrugated Ridges, Lead Washers and Galvanized Nails carried in stock.

Send specifications to your nearest office for catalogues and prices.

## The PEDLAR PEOPLE

**Montreal, Que.**  
767-769 Craig St.

**Ottawa, Ontario**  
423 Sussex Street

**Toronto, Ontario**  
11 Colborne Street

**London, Ontario**  
69 Dundas Street

**Winnipeg, Man.**  
76 Lombard Street

**Vancouver, B.C.**  
615 Pender Street

WRITE YOUR NEAREST OFFICE. HEAD OFFICE AND WORKS, OSHAWA, ONT.

**LARGEST MAKERS OF SHEET METAL BUILDING MATERIALS UNDER THE BRITISH FLAG**

# "IMPERIAL" PNEUMATIC TOOLS



## ECONOMY IN BELT PRESERVATION

Belt economy does not end with the purchasing. The belt is worth its cost price only so long as its original condition which fixes the price is maintained.

Shop conditions always affect the elasticity and "life" of the belt. Dixon's Solid Belt Dressing counteracts these evil effects, preserves efficiency, and keeps the belt at "par value." Get sample 33-O.

**Joseph Dixon Crucible Co., Jersey City, N.J.**

## DO YOU WASTE WHAT OTHERS ARE SAVING OR SAVE WHAT OTHERS ARE WASTING ?

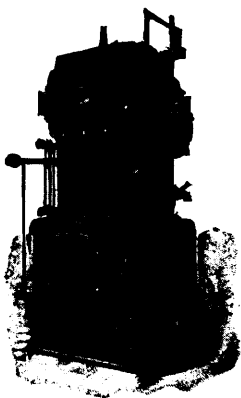

**T**HIS is the day of by-products. In many important lines of business the profit now lies in what used to be thrown away.

In your line there are two classes—those who save the "by-products" and those who waste them.

The wasters cannot successfully compete with the savers.

**WEBSTER FEED WATER HEATERS and HEATING APPLIANCES** have made economy a fine art. In many businesses their saving has swung the balance over from the "Loss" side to the "Profit" side.

Webster Steam Appliances now hold undisputed the highest place in steam engineering economy.

MANUFACTURED BY

**DARLING BROTHERS, Limited**  
TORONTO — MONTREAL — WINNIPEG

When writing to Advertisers kindly mention THE CANADIAN MANUFACTURER.

## CLASSIFIED INDEX.

### Abrasives

Williams, A. R. Machinery Co., Toronto.

### Acids

Canada Chemical Co., London, Ont.  
Canada Process Co., Toronto.  
Nichols Chemical Co. of Canada, Montreal.

### Air Compressors

Allis-Chalmers-Bullock, Limited, Montreal.  
Canada Foundry Co., Toronto.  
Canadian Rand Drill Co., Sherbrooke, Que.  
Darling Bros., Montreal.  
Smart-Turner Machine Co., Hamilton, Ont.

### Alum

Nichols Chemical Co. of Canada, Montreal.

### Aluminum

Northern Aluminum Co., Pittsburg, Pa.  
Syracuse Smelting Works, Montreal.

### Angles, Beams and Girders

Bourne-Fuller Co., Cleveland, Ohio.  
Canada Foundry Co., Toronto.  
Hopkins, F. H. & Co., Montreal.  
Nova Scotia Steel & Coal Co., New Glasgow, N.S.

### Aniline Colors and Dyewood Extracts

Benson, W. T. & Co., Montreal.  
Brunner, Mond & Co., Norwich, England.  
Canada Chemical Mfg. Co., London, Ont.  
Canada Process Co., Toronto.  
Cassella Color Co., New York City.  
McArthur, Corneille & Co., Montreal.  
Nichols Chemical Co. of Canada, Montreal.  
Winn & Holland, Montreal.

### Annealing Muffles and Furnaces (Wire)

Leslie, A. C. & Co., Montreal.  
Turner, Vaughn & Taylor Co., Cuyahoga Falls, Ohio

### Antimony

Syracuse Smelting Works, Montreal.

### Anvils and Vises

Hopkins, F. H. & Co., Montreal.  
Leslie, A. C. & Co., Montreal.

### Architects

Gearing, H., Toronto.  
Parke, R. J., Toronto.  
Vogel, C. H., Ottawa.

### Automatic Gear Cutting Machines

Becker-Brainard Milling Machine Co. Hyde Park, Mass.

### Axles

Hopkins, F. H. & Co., Montreal.  
Nova Scotia Steel & Coal Co., New Glasgow, N.S.

### Babbitt Metal

Petrie, H. W., Toronto.  
Syracuse Smelting Works, Montreal.

### Banks

Bank of Hamilton, Hamilton, Ont.

### Bar Iron and Steel

Bourne-Fuller Co., Cleveland, Ohio.  
Hopkins, F. H. & Co., Montreal.  
Leslie, A. C. & Co., Montreal.  
London Rolling Mills, London, Ont.  
Union Drawn Steel Co., Hamilton Ont.

### Belt Dressing

McLaren, J. C. Belting Co., Montreal and Toronto.  
Petrie, H. W., Toronto.  
Sadler & Haworth, Montreal and Toronto.  
Williams, A. R. Machinery Co., Toronto.

### Belt Fasteners

Bristol Co., Waterbury, Conn.  
McLaren, D. K., Montreal and Toronto.  
Petrie, H. W., Toronto.  
Williams, A. R. Machinery Co., Toronto.

### Belting (Cotton)

Dominion Belting Co., Hamilton, Ont.  
McLaren, D. K., Montreal and Toronto.  
McLaren, J. C. Belting Co., Montreal and Toronto.  
Petrie, H. W., Toronto.  
Sadler & Haworth, Montreal and Toronto.

### Belting (Leather)

McLaren, D. K., Montreal and Toronto.  
Petrie, H. W., Toronto.  
Williams, A. R. Machinery Co., Toronto.

**CLASSIFIED INDEX.**

(CONTINUED).

**Belting (Rubber)**

Gutta Percha & Rubber Mfg. Co., Toronto.  
McLaren D. K., Montreal and Toronto.  
Petrie, H. W., Toronto.

**Belting and Supplies**

Bristol Co., Waterbury, Conn.  
Dominion Belting Co., Hamilton, Ont.  
Gutta Percha & Rubber Mfg. Co., Toronto.  
Jeffrey Mfg. Co., Columbus, Ohio.  
McLaren, D. K., Montreal and Toronto.  
Petrie, H. W., Toronto.  
Williams, A. R. Machinery Co., Toronto.

**Blast Furnace Brick**

Dunbar Fire Brick Co., Pittsburgh, Pa.  
Elk Fire Brick Co., St. Mary's, Pa.  
Hamilton Facing Mill Co., Hamilton, Ont.  
Harbison-Walker Refractories Co., Pittsburgh, Pa.  
Pennsylvania Fire Brick Co., Beech Creek, Pa.  
Queen's Run Fire Brick Co., Lock Haven, Pa.  
Stowe-Fuller Co., Cleveland, Ohio.

**Blowers**

Hamilton Facing Mill Co., Hamilton, Ont.  
Sheldon & Sheldon, Galt, Ont.  
Sturtevant, B. F. Co., Boston, Mass.

**Boiler Compounds**

Canada Chemical Mfg. Co., London, Ont.  
Canada Process Co., Toronto.  
Hamilton Facing Mill Co., Hamilton, Ont.

**Boiler Inspection**

Boiler Inspection & Insurance Co., Toronto.  
Canadian Casualty & Boiler Insurance Co., Toronto.

**BOILERS (See Engines and Boilers)****Bolts and Nuts**

London Rolling Mills, London, Ont.  
Morrow John Machine Screw Co., Ingersoll, Ont.

**Brass Founders**

Hamilton Brass Mfg. Co., Hamilton, Ont.

**Building and Paving Brick**

Dunbar Fire Brick Co., Pittsburgh, Pa.  
Hamilton Facing Mill Co., Hamilton, Ont.  
Harbison-Walker Refractories Co., Pittsburgh, Pa.  
Pennsylvania Fire Brick Co., Beech Creek, Pa.  
Queen's Run Fire Brick Co., Lock Haven, Pa.  
Stowe-Fuller Co., Cleveland, Ohio.

**Building Iron and Steel**

Bourne-Fuller Co., Cleveland, Ohio.  
Canada Foundry Co., Toronto.  
Expanded Metal & Fireproofing Co., Toronto.  
Metallic Roofing Co., Toronto.  
Pedlar People, Oshawa, Ont.

**Builders' Materials**

Albert Mfg. Co., Hillsboro, Ont.  
Canada Foundry Co., Toronto.  
Conduits Company, Limited, Toronto.  
Expanded Metal & Fireproofing Co., Toronto.  
Gartshore, John J., Toronto.  
Hopkins, F. H. & Co., Montreal.  
Metallic Roofing Co., Toronto.  
Pedlar People, Oshawa, Ont.  
Sheldon & Sheldon, Galt, Ont.

**Cables**

Dominion Wire Rope Co., Montreal.  
Greening, B. Wire Co., Hamilton, Ont.  
Phillips, Eugene F. Electrical Works, Montreal.

**Canada Plates**

Leslie, A. C. & Co., Montreal.  
Nova Scotia Steel & Coal Co., New Glasgow, N.S.

**Canoes**

Peterborough Canoe Co., Peterborough, Ont.

**Caps**

McCullough-Dalsell Crucible Co., Pittsburg, Pa.

**Card Clothing**

McLaren D. K., Montreal and Toronto.

**Cast Iron Pipe**

Canada Foundry Co., Toronto.  
Montreal Pipe Foundry Co., Montreal.  
McCullough, John, Caledonian Iron Works Co. Montreal.

**Castings (Grey Iron, Malleable Iron and Brass)**

Jenckes Machine Co., Sherbrooke, Que.  
Kerr Engine Co., Walkerville, Ont.  
McCougall, John, Caledonian Iron Works Co., Montreal.  
McKinnon Dash & Metal Works Co., St. Catharines, Ont.  
Maxwell, David & Sons, St. Mary's, Ont.  
Smart-Turner Machine Co., Hamilton, Ont.

**Cement Machinery**

Allis-Chalmers-Bullock, Limited, Montreal.  
Bradley Pulverizer Co., Boston, Mass.  
McCougall, John, Caledonian Iron Works Co., Montreal.

**Centrifugal Pumping Machinery**

Morris Machine Works, Baldwinville, N.Y.  
Smart-Turner Machine Co., Hamilton, Ont.

**Chain Making Machinery****(Welded Coil Chain)**

Turner, Vaughn & Taylor Co., Cuyahoga Falls, Ohio.

**Channels**

Bourne-Fuller Co., Cleveland, Ohio.  
Canada Foundry Co., Toronto.  
Leslie, A. C. & Co., Montreal.  
Nova Scotia Steel & Coal Co., New Glasgow, N.S.

**Charcoal Pig Iron**

Canada Iron Furnace Co., Montreal.  
McCougall, John, Caledonian Iron Works Co. Montreal.

**Chemicals**

Canada Chemical Co., London, Ont.  
Canada Process Co., Toronto.  
Nichols Chemical Co. of Canada, Montreal.

**Chemists**

Heys, Thomas & Son, Toronto.

**Clay Working Machinery**

Turner, Vaughn & Taylor Co., Cuyahoga Falls, Ohio.

**Coal, Coke and Charcoal.**

Bourne-Fuller Co., Cleveland, Ohio.  
Hamilton Facing Mill Co., Hamilton, Ont.  
Milnes, James H. & Co., Toronto.

**Coal Cutting Machines**

Allis-Chalmers-Bullock, Limited, Montreal.  
Canadian Rand Drill Co., Sherbrooke, Que.  
Jeffrey Mfg. Co., Columbus, Ohio.

**Coal Triples**

Jeffrey Mfg. Co., Columbus, Ohio.  
Jenckes Machine Co., Sherbrooke, Que.

**Coil Chains**

Greening, B. Wire Co., Hamilton, Ont.  
Leslie, A. C. & Co., Montreal.

**Coke Oven Brick**

Dunbar Fire Brick Co., Pittsburgh Pa.  
Stowe-Fuller Co. Cleveland Ohio.

**Collection Agency**

Petrie, H. D., Hamilton, Ont.

**Concrete Mixers**

Hopkins, F. H. & Co., Montreal.

**Condensers**

Smart-Turner Machine Co., Hamilton, Ont.

**Conduits (Interior)**

Conduits Company, Limited, Toronto.

**Contractors' Machinery**

Allis-Chalmers-Bullock, Limited, Montreal.  
Gartshore, John J., Toronto.  
Hopkins, F. H. & Co., Montreal.  
Jenckes Machine Co., Sherbrooke, Que.  
McCougall, John, Caledonian Iron Works Co., Montreal.  
Smart-Turner Machine Co., Hamilton, Ont.

**Contractors' Plants**

Allis-Chalmers-Bullock, Limited, Montreal.  
Hopkins, F. H. & Co., Montreal.  
Jenckes Machine Co., Sherbrooke, Que.  
Petrie, H. W., Toronto.  
Smart-Turner Machine Co., Hamilton, Ont.  
Williams A. R. Machinery Co., Toronto.

**Conveying Machinery**

Allis-Chalmers-Bullock, Limited, Montreal.  
Babcock & Wilcox, Limited, Montreal.  
Canada Foundry Co., Toronto.  
Jeffrey Mfg. Co., Columbus Ohio.  
McCougall John, Caledonian Iron Works Co. Montreal.  
Perrin, William R. & Co., Limited, Toronto.  
Smart-Turner Machine Co., Hamilton, Ont.

**Copper Materials**

Greening, B. Wire Co. Hamilton, Ont.  
Phillips, Eugene F. Electrical Works, Montreal.  
Syracuse Smelting Works Montreal.

**Corrugated Iron**

Metallic Roofing Co., Toronto.  
Pedlar People, Oshawa, Ont.

**Covers**

McCullough-Dalsell Crucible Co., Pittsburg, Pa.

**Cranes (Electric and Hand Power)**

Smart-Turner Machine Co., Hamilton, Ont.

**Crayons**

Lowell Crayon Co., Lowell, Mass.

**Crucibles**

Dixon, Joseph, Crucible Co., Jersey City, N.J.  
Hamilton Facing Mill Co., Hamilton, Ont.  
McCullough-Dalsell Crucible Co., Pittsburg, Pa.  
Syracuse Smelting Works, Montreal.

**Crucible Caps**

Hamilton Facing Mill Co., Hamilton, Ont.  
McCullough-Dalsell Crucible Co. Pittsburg, Pa.

**Crucible Covers**

McCullough-Dalsell Crucible Co., Pittsburg, Pa.

**Cutter Grinding Machines**

Becker-Brainard Milling Machine Co., Hyde Park, Mass.

**Dashes**

McCinnon Dash & Metal Works Co. St. Catharines, Ont.

**Dies (Socket, Sewer Pipe and Tile)**

Turner, Vaughn & Taylor Co., Cuyahoga Falls, Ohio.

**Directories**

Kelly's Directories, Limited, Toronto

**Draw Benches (Wire)**

Turner, Vaughn & Taylor Co., Cuyahoga Falls, Ohio.

**Dredges**

Allis-Chalmers-Bullock, Limited, Montreal.

**Drills**

Allis-Chalmers-Bullock, Limited, Montreal.  
Canadian Westinghouse Co., Ltd., Hamilton, Ont.  
Petrie, H. W., Toronto.

**Drills (Pneumatic and Rock)**

Allis-Chalmers-Bullock, Limited, Montreal.  
Canadian Rand Drill Co., Sherbrooke, Que.  
Jeffrey Mfg. Co., Columbus, Ohio.

**Drop Forgings**

Globe Machine & Stamping Co., Cleveland, Ohio

**Drop Forging Dies**

Globe Machine & Stamping Co., Cleveland Ohio.

**Dry Kiln Apparatus**

Sheldon & Sheldon, Galt, Ont.  
Sturtevant, B. F. Co., Boston, Mass.

**Dust and Shavings Separators**

Sheldon & Sheldon, Galt, Ont.  
Sturtevant, B. F. Co. Boston, Mass.

**Dye Stuffs and Chemicals**

Benson, W. T. & Co., Montreal.  
Brunner, Mond & Co., Northwich, England.  
Canada Chemical Mfg. Co., London, Ont.  
Canada Process Co., Toronto.  
Cassella Color Co., New York City.  
McArthur, Corneille & Co., Montreal.  
Nichols Chemical Co. of Canada, Montreal.  
Winn & Holland, Montreal.

**DYNAMOS (See Motors and Dynamoes)****Electric Meters and Transformers**

Allis-Chalmers-Bullock, Limited, Montreal.  
Packard Electric Co., St. Catharines, Ont.

**Electric Mine Locomotives**

Canadian General Electric Co., Toronto.  
Canadian Westinghouse Co., Ltd., Hamilton, Ont.  
Jeffrey Mfg. Co., Columbus, Ohio.

**Electrical Repairs**

Keystone Engineering Co., Toronto.

**Electrical Supplies**

Allis-Chalmers-Bullock, Limited, Montreal.  
Bristol Co., Waterbury, Conn.  
Canadian General Electric Co., Toronto.

# CLASSIFIED INDEX.

(CONTINUED).

Canadian Westinghouse Co., Ltd., Hamilton, Ont.  
Electrical Construction Co., London, Ont.  
Forman, John, Montreal.  
Jones & Moore Electric Co., Toronto  
Keystone Engineering Co., Toronto.  
Packard Electric Co., St. Catharines, Ont.  
Toronto & Hamilton Electric Co., Hamilton, Ont.

## Elevators and Conveyors

Allis-Chalmers-Bullock, Limited, Montreal.  
Darling Bros., Montreal.  
Jeffrey Mfg. Co., Columbus, Ohio.  
Jenckes Machine Co., Sherbrooke, Que.

## Elevator Insurance

Canadian Casualty & Boiler Insurance Co., Toronto

## Emery and Emery Wheels

Forman, John, Montreal.  
Hamilton Facing Mill Co., Hamilton, Ont.  
Petrie, H. W., Toronto.

## Engineers (Chemical)

Heys, Thomas & Son, Toronto.  
Hunt, Robert W. & Co., Chicago, Ill.

## Engineers (Civil)

Parke, R. J., Toronto.  
Vogel, C. H., Ottawa.

## Engineers (Consulting)

Aitken, K. L., Toronto.  
Electrical Construction Co., London, Ont.  
Fensom, C. J., Toronto.  
Gearing, H., Toronto.  
Hunt, Robert W. & Co., Chicago, Ill.  
Keystone Engineering Co., Toronto, Ont.  
Marion & Marion, Montreal.  
Parke, R. J., Toronto.  
Perrin, William R. & Co., Limited, Toronto.  
Vogel C. H., Ottawa.

## Engineers (Contracting)

Babcock & Wilcox, Limited, Montreal.  
Canada Foundry Co., Toronto.  
Darling Bros., Montreal.  
Electrical Construction Co., London Ont.  
Fensom, C. J., Toronto.  
Keystone Engineering Co., Toronto.  
McDougall, John, Caledonian Iron Works Co., Montreal.  
Robb Engineering Co., Amherst, N.S.

## Engineers (Electrical)

Aitken, K. L., Toronto.  
Allis-Chalmers-Bullock, Limited, Montreal.  
Canadian General Electric Co., Ltd., Toronto.  
Canadian Westinghouse Co., Ltd., Hamilton, Ont.  
Canadian White Co., Montreal.  
Crooker-Wheeler Co., St. Catharines, Ont.  
Electrical Construction Co., London, Ont.  
Fensom, C. J., Toronto.  
Jones & Moore Electric Co., Toronto.  
Keystone Engineering Co., Toronto.  
Marion & Marion, Montreal.  
Toronto & Hamilton Electric Co., Hamilton Ont.

## Engineers (Mechanical)

Allis-Chalmers-Bullock, Limited, Montreal.  
Babcock & Wilcox, Limited, Montreal.  
Darling Bros., Montreal.  
Electrical Construction Co., London, Ont.  
Fensom, C. J., Toronto.  
Gearing, H., Toronto.  
McDougall, John, Caledonian Iron Works Co., Montreal.  
Hunt, Robert W. & Co., Chicago, Ill.  
Kerr Engine Co., Walkerville, Ont.  
Marion & Marion, Montreal.  
Robb Engineering Co., Amherst, N.S.  
Sheldon & Sheldon, Galt, Ont.  
Smart-Turner Machine Co., Hamilton, Ont.

## Engineers (Mill and Hydraulic)

Fensom, C. J., Toronto.  
Smart-Turner Machine Co., Hamilton, Ont.  
Vogel, C. H., Ottawa.

## Engineers (Mining)

Heys Thomas & Son, Toronto  
Mills, S. D. Toronto.

## Engineers and Contractors

Jeffrey Mfg. Co., Columbus, Ohio.  
Jenckes Machine Co., Sherbrooke, Que.  
Smart-Turner Machine Co., Hamilton, Ont.

## Engines and Boilers

Allis-Chalmers-Bullock, Limited, Montreal.  
Babcock & Wilcox, Limited, Montreal.  
Canada Foundry Co., Toronto.  
Goldie & McCulloch Co., Galt, Ont.

Hamilton, Wm. Mfg. Co., Peterborough, Ont.  
Hopkins, F. H. & Co., Montreal.  
Jenckes Machine Co., Sherbrooke, Que.  
Morris Machine Works, Baldwinville, N.Y.  
McDougall, John, Caledonian Iron Works Co., Montreal.  
Petrie, H. W., Toronto.  
Robb Engineering Co., Amherst, N.S.  
Sheldon & Sheldon, Galt, Ont.  
Smart-Turner Machine Co., Hamilton, Ont.  
Sturtevant, B. F. Co., Boston, Mass.  
Williams, A. R. Machinery Co., Toronto.

## Engravers

Canadian Manufacturer, Toronto.  
Jenes, J. L. Engraving Co., Toronto.

## Exhaust Fans

Hamilton Facing Mill Co., Hamilton, Ont.  
Sheldon & Sheldon, Galt, Ont.  
Sturtevant, B. F. Co., Boston, Mass.

## Exhaust Heads

Darling Bros., Montreal.  
Sheldon & Sheldon, Galt, Ont.  
Sturtevant, B. F. Co., Hyde Park Mass.

## Exhausters

Sheldon & Sheldon, Galt, Ont.  
Sturtevant, B. F. Co., Hyde Park, Mass.

## Factory Sites

(See Factory Locations, page 31.)

## Feed Water Heaters

Babcock & Wilcox, Limited, Montreal.  
Darling Bros., Montreal.  
McDougall, John, Caledonian Iron Works Co., Montreal.  
Pittsburg Filter Mfg. Co., Pittsburg, Pa.  
Robb Engineering Co., Amherst, N.S.  
Smart-Turner Machine Co., Hamilton, Ont.

## Feed Water Purifiers

Pittsburg Filter Mfg. Co., Pittsburg, Pa.

## Files

Spence, R. & Co., Hamilton, Ont.

## Fillet (Pattern)

Hamilton Facing Mill Co., Hamilton, Ont.  
Sadler & Haworth, Montreal and Toronto.

## Filters (Oil)

Babcock & Wilcox, Limited, Montreal.  
Darling Bros., Montreal.  
McDougall, John, Caledonian Iron Works Co., Montreal.  
Perrin, William R. & Co., Limited, Toronto.

## Filters and Filtering Systems (Water)

Babcock & Wilcox, Limited, Montreal.  
Jenckes Machine Co., Sherbrooke, Que.  
McDougall, John, Caledonian Iron Works Co., Montreal.  
Pittsburg Filter Mfg. Co., Pittsburg, Pa.

## Financial

Bradstreet's, New York City.  
Dun, R. G. & Co., Toronto.  
Neff & Postlethwaite, Toronto.  
Petrie H. D. Hamilton, Ont.

## Finials

Metallic Roofing Co., Toronto.  
Pedlar People, Oshawa, Ont.

## Fire Brick and Clay

Dunbar Fire Brick Co., Pittsburg, Pa.  
Elk Fire Brick Co., St. Mary's, Pa.  
Hamilton Facing Mill Co., Hamilton, Ont.  
Harbison-Walker Refractories Co., Pittsburg, Pa.  
Pennsylvania Fire Brick Co., Beech Creek, Pa.  
Queen's Run Fire Brick Co., Lock Haven, Pa.  
Stowe-Fuller Co., Cleveland, Ohio.

## Fire Escapes

Darling Bros., Montreal.

## Fireproof Partitions

Metallic Roofing Co., Toronto.  
Pedlar People, Oshawa, Ont.

## Flour Mill Machinery

Allis-Chalmers-Bullock, Limited, Montreal.  
Goldie & McCulloch Co., Galt, Ont.

## Forges and Blowers

Canada Foundry Co., Toronto.  
Hamilton Facing Mill Co., Hamilton, Ont.  
Sheldon & Sheldon, Galt, Ont.  
Sturtevant, B. F. Co., Boston, Mass.

## Founders

Canada Foundry Co., Toronto.  
Goldie & McCulloch Co., Galt, Ont.  
Hamilton, Wm. Mfg. Co., Peterborough, Ont.  
Jenckes Machine Co., Sherbrooke, Que.  
McDougall, John, Caledonian Iron Works Co., Montreal.  
Robb Engineering Co., Amherst, N.S.  
Smart-Turner Machine Co., Hamilton, Ont.

## Foundry Facings and Supplies

Hamilton Facing Mill Co., Hamilton, Ont.

## Fuel Economizers

Babcock & Wilcox, Limited, Montreal.  
Sturtevant, B. F. Co., Hyde Park, Mass.

## Furniture (Lodge, Opera and School)

Canadian Office & School Furniture Co., Preston, Ont.

## Galvanizing

Ontario Wind Engine & Pump Co., Toronto.

## Galvanizing and Tinning Machinery and Furnaces (Wire)

Turner, Vaughn & Taylor Co., Cuyahoga Falls, Ohio

## Gas and Gasoline Engines

Economic Power, Light & Heat Supply Co., Toronto.  
Morrison, T. A. & Co., Montreal.  
Smart-Turner Machine Co., Hamilton, Ont.

## Gauges (Recording Pressure)

Bristol Co., Waterbury, Conn.

## Gauges (Steam)

Petrie, H. W., Toronto.  
Williams, A. R. Machinery Co. Toronto

## Gauges (Water)

Babcock & Wilcox, Limited, Montreal

## Generating Sets

Sturtevant B. F. Co., Hyde Park, Mass

## Generators

Allis-Chalmers-Bullock, Limited, Montreal.  
Canadian General Electric Co., Toronto.  
Canadian Westinghouse Co., Ltd., Hamilton, Ont.  
Electrical Construction Co., London, Ont.  
Forman, John, Montreal.  
Jeffrey Mfg. Co., Columbus, Ohio.  
Jones & Moore Electric Co., Toronto.  
Phillips, Eugene F., Electrical Works, Montreal.  
Toronto & Hamilton Electric Co., Hamilton, Ont.

## Gloves, Mittens and Moccasins

Storey, W. H. & Son, Acton, Ont.

## Government Notices

Factory Inspectors.  
Minister of Agriculture.

## Graphite

Dixon, Jos. Crucible Co., Jersey City, N.J.  
Hamilton Facing Mill Co., Hamilton, Ont.  
McCullough-Dalzell Crucible Co., Pittsburg, Pa.

## Hames.

McKinnon Dash & Metal Works Co., St. Catharines.

## Hardware

Butterfield & Co., Rock Island, Que.  
Gartshore, John J., Toronto.  
Globe Machine & Stamping Co., Cleveland, Ohio.  
Hopkins, F. H. & Co., Montreal.  
Morrow John Machine Screw Co., Ingersoll, Ont.

## Heating and Ventilating Apparatus

Darling Bros., Montreal.  
Sheldon & Sheldon, Galt, Ont.  
Sturtevant, B. F. Co., Boston, Mass.

## Hoisting Engines

Allis-Chalmers-Bullock, Limited, Montreal  
Jenckes Machine Co., Sherbrooke, Que.

## Holsts (Chain and Pneumatic)

Allis-Chalmers-Bullock, Limited, Montreal.  
Canadian Rand Drill Co., Sherbrooke, Que.  
Hopkins, F. H. & Co., Montreal.

## Hose (Fire and Pneumatic)

Gutta Percha & Rubber Mfg. Co., Toronto.

## Hydrants

Kerr Engine Co., Walkerville, Ont.  
Jenckes Machine Co., Sherbrooke, Que.  
McDougall, John, Caledonian Iron Works Co., Montreal.

## Hydraulic Accumulators

Jenckes Machine Co., Sherbrooke, Que.  
McDougall, John, Caledonian Iron Works Co., Montreal.  
Smart-Turner Machine Co., Hamilton, Ont.

## Hydraulic Machinery

Canada Foundry Co., Toronto.  
Darling Bros., Montreal.  
Hamilton, Wm. Mfg. Co., Peterborough, Ont.  
Jenckes Machine Co., Sherbrooke, Que.  
McDougall, John, Caledonian Iron Works Co., Montreal.  
Perrin, William R. & Co., Limited, Toronto.  
Petrie, H. W., Toronto.  
Smart-Turner Machine Co., Hamilton, Ont.

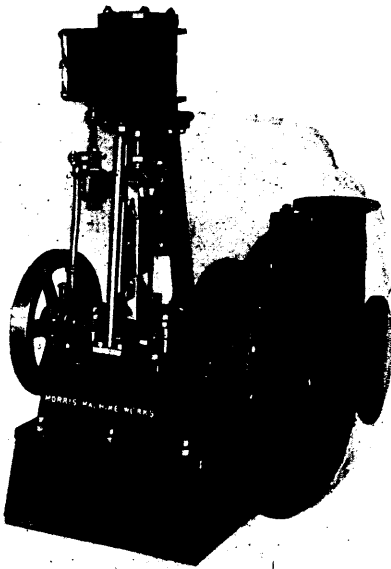

## Morris Machine Works.

BALDWINVILLE, N.Y.

MANUFACTURERS OF

### Centrifugal Pumping Machinery and Steam Engines

SPECIAL PUMPING OUTFITS TO SUIT  
SPECIAL REQUIREMENTS

Estimates Furnished upon Application.

**H. W. PETRIE, Agent**  
TORONTO, CANADA.

NEW YORK OFFICE: 39-41 CORTLANDT ST.

HENION & HUBBELL, Agents  
61-69 North Jefferson St., CHICAGO, ILL.

## Eastlake

### Steel Shingles

either Galvanized or Painted

**Are Always Reliable** They are more economically durable and quicker to apply than any others, fitting accurately—and therefore most easily laid.

They have been thoroughly tested in all kinds of climates, invariably proving **Fire, Lightning, Rust and Weather Proof.**

If you're building, make sure of satisfaction by ordering EASTLAKES for the roof—fullest information if you write.

**Metallic Roofing Co., Limited,**  
WHOLESALE MFRS., TORONTO, CANADA.



## DEEP WELL PUMPS

Steam Geared or Electrically Driven.

Deep Well Pumping Systems for Cities, Railroad,  
Mines, Factories, etc.

**DOWNIE PUMP CO., Downieville, Pa., U.S.A.**



## The Mercantile Agency

ESTABLISHED 1841.

## R. G. DUN & CO.

Offices in 169 of the leading business centres of the world.

### CANADIAN OFFICES

TORONTO,	MONTREAL,
HAMILTON,	QUEBEC,
LONDON,	OTTAWA,
WINNIPEG,	ST. JOHN,
VANCOUVER,	HALIFAX.

W. C. MATTHEWS, Toronto,  
General Manager for Canada.

Established 1849.

## BRADSTREET'S

Capital and Surplus, \$1,500,000

Offices Throughout the Civilized World.

EXECUTIVE OFFICES,

346 & 348 Broadway, New York City, U.S.A.

CORRESPONDENCE INVITED.

### OFFICES IN CANADA:

Halifax, N.S.	Hamilton, Ont.
London, Ont.	Montreal, Que.
Ottawa, Ont.	Quebec, Que.
St. John, N.B.	Toronto, Ont.
Vancouver, B.C.	Winnipeg, Man.

THOMAS C. IRVING, Gen'l Manager Western Canada  
TORONTO.

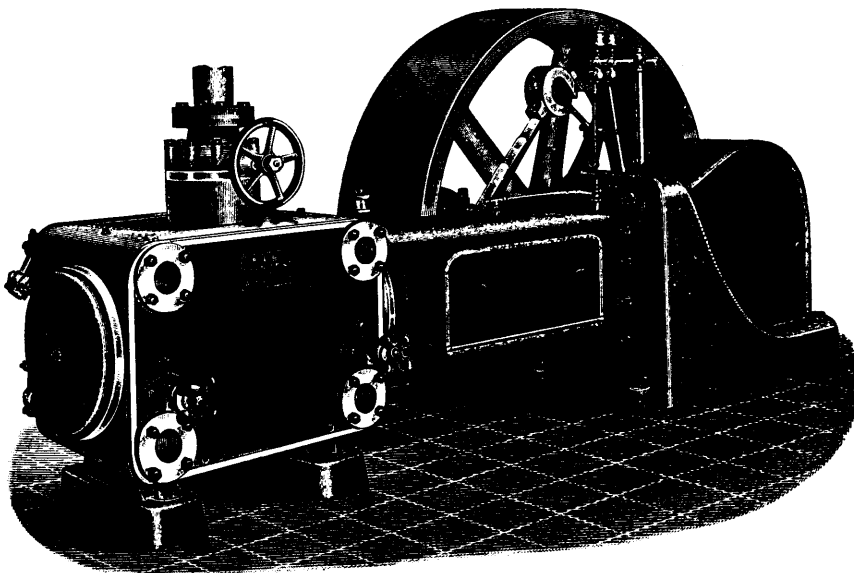

Our Corliss engines are fitted with Robb-Armstrong Corliss valve gear, which has the following good points.

**Positively Driven**  
Encased in Oil

**Minimum Wear**

**Runs Noiselessly**  
Minimum Friction

## Robb Engineering Co., Limited

AMHERST, N.S.

District Offices { 320 Ossington Ave., Toronto, WILLIAM McKAY, Manager.  
Bell Telephone Bldg., Montreal, WATSON JACK, Manager.  
355 Carlton Street, Winnipeg, J. F. PORTER, Manager.

**CLASSIFIED INDEX.**

(CONTINUED).

**Insulated Wires and Cables**

Phillips, Eugene F., Electrical Works, Montreal.

**Iron and Steel Specialties**

Armstrong Mfg. Co., Bridgeport, Conn.  
 Bourne-Fuller Co., Cleveland, Ohio.  
 Canada Foundry Co., Toronto.  
 Leslie, A. C. & Co., Montreal.  
 London Rolling Mill Co., London, Ont.  
 Lyssaght, John, Limited, Bristol, England and Montreal.  
 Metallic Roofing Co., Toronto.  
 Nova Scotia Steel & Coal Co., New Glasgow, N.S.  
 Pedlar People, Oshawa, Ont.  
 Petrie, H. W., Toronto.  
 Union Drawn Steel Co., Hamilton, Ont.

**Injectors**

Canada Foundry Co., Toronto.  
 Hamilton Brass Mfg. Co., Hamilton, Ont.  
 Williams, A. R. Machinery Co., Toronto.

**Iron and Steel Inspection**

Hunt, R. W. &amp; Co., Chicago, Ill.

**Lamps—Electric**

Allis-Chalmers-Bullock, Limited, Montreal.  
 Canadian General Electric Co., Toronto.  
 Canadian Westinghouse Co., Ltd., Hamilton, Ont.  
 Forman, John, Montreal.  
 Packard Electric Co., St. Catharines, Ont.

**Lathes**

Petrie, H. W., Toronto.  
 Williams, A. R. Machinery Co., Toronto

**Lathes (Wood-working)**

Goldie & McCulloch Co., Galt, Ont.  
 Petrie, H. W., Toronto.  
 Williams, A. R. Machinery Co., Toronto.

**Lubricators**

Hamilton Facing Mill Co., Hamilton, Ont.

**Machinists**

Goldie & McCulloch Co., Galt, Ont.  
 Robb Engineering Co., Amherst, N.S.  
 Smart-Turner Machine Co., Hamilton, Ont.

**Machinists' Supplies**

Armstrong Mfg. Co., Bridgeport, Conn.  
 Butterfield & Co., Rock Island, Que.  
 Goldie & McCulloch Co., Galt, Ont.  
 Gutta Percha & Rubber Mfg. Co., Toronto.  
 Hopkins, F. H. & Co., Montreal.  
 Jeffrey Mfg. Co., Columbus, Ohio.  
 Morrow, John, Machine Screw Co., Ingersoll, Ont.  
 Petrie, H. W., Toronto.

**Machine Tools**

Becker-Brainard Milling Machine Co., Hyde Park, Mass.  
 Darling Bros., Montreal.  
 Petrie, H. W., Toronto.

**Malleable Castings**

McKinnon Dash & Metal Works Co., St. Catharines, Ont.  
 Smith's Falls Malleable Castings Co., Smith's Falls, Ont.

**Marine and Stationary Engines and Boilers**

Allis-Chalmers-Bullock, Limited, Montreal.  
 Jenokes Machine Co., Sherbrooke, Que.  
 Smart-Turner Machine Co., Hamilton, Ont.

**Mechanical Draft**

Babcock & Wilcox, Limited, Montreal.  
 Sheldon & Sheldon, Galt, Ont.  
 Sturtevant, B. F. Co., Boston, Mass.

**Metal Doors**

Metallic Roofing Co., Toronto.  
 Pedlar People, Oshawa, Ont.

**Metal Stamping**

Globe Machine & Stamping Co., Cleveland, Ohio.  
 Metallic Roofing Co., Toronto.  
 Pedlar People, Oshawa, Ont.

**Metallurgists**

Mills, S. D., Toronto.

**Mill Machinery and Supplies**

Allis-Chalmers-Bullock, Limited, Montreal.  
 Armstrong Mfg. Co., Bridgeport, Conn.  
 Becker-Brainard Milling Machine Co., Hyde Park, Mass.  
 Darling Bros., Montreal.  
 Gartshore, John J., Toronto.  
 Goldie & McCulloch Co., Galt, Ont.  
 Gutta Percha & Rubber Mfg. Co., Toronto.  
 Hamilton Brass Mfg. Co., Hamilton, Ont.  
 Hamilton, Wm., Mfg. Co., Peterborough, Ont.  
 Hay, Peter Knife Co., Galt, Ont.  
 Hopkins, F. H. & Co., Montreal.  
 Jeffrey Mfg. Co., Columbus, Ohio.  
 Jenokes Machine Co., Sherbrooke, Que.  
 Morrow, John, Machine Screw Co., Ingersoll, Ont.  
 McDougall, John, Caledonian Iron Works Co., Montreal.  
 McLaren, D. K., Montreal and Toronto.  
 Petrie, H. W., Toronto.  
 Robb Engineering Co., Amherst, N.S.  
 Smart-Turner Machine Co., Hamilton, Ont.  
 Spence, R. & Co., Hamilton, Ont.

**Milling Cutters and Machines**

Becker-Brainard Milling Machine Co., Hyde Park, Mass.

**Miners' Lamps**

Allis-Chalmers-Bullock, Limited, Montreal.

**Mining Machinery**

Allis-Chalmers-Bullock, Limited, Montreal.  
 Canadian Rand Drill Co., Sherbrooke, Que.  
 Gartshore, John J., Toronto.  
 Hamilton, Wm. Mfg. Co., Peterborough, Ont.  
 Hopkins, F. H. & Co., Montreal.  
 Jeffrey Mfg. Co., Columbus, Ohio.  
 Jenokes Machine Co., Sherbrooke, Que.  
 McDougall, John, Caledonian Iron Works Co., Montreal.  
 Perrin, William R. & Co., Limited, Toronto.  
 Petrie, H. W., Toronto.  
 Williams, A. R. Machinery Co., Toronto.

**Motors and Dynamos**

Allis-Chalmers-Bullock, Limited, Montreal.  
 Canadian General Electric Co., Toronto.  
 Canadian Westinghouse Co., Ltd., Hamilton, Ont.  
 Electrical Construction Co., London, Ont.  
 Forman, John, Montreal.  
 Jeffrey Mfg. Co., Columbus, Ohio.  
 Jones & Moore Electric Co., Toronto.  
 Keystone Engineering Co., Toronto.  
 Petrie, H. W., Toronto.  
 Sturtevant, B. F. Co., Hyde Park, Mass.  
 Toronto & Hamilton Electric Co., Hamilton, Ont.

**Moulding Sand**

Hamilton Facing Mills Co., Hamilton, Ont.

**Moulders Supplies.**

Hamilton Facing Mill Co., Hamilton, Ont.

**Municipal Filtration Plants (Water)**

Pittsburg Filter Mfg. Co., Pittsburg, Pa.

**Nickel**

Canadian Copper Co., New York, N.Y.  
 Orford Copper Co., New York, N.Y.

**Nozzles**

McCullough-Dalszell Crucible Co., Pittsburg, Pa.

**Office and Bank Fittings**

Canadian Office &amp; School Furniture Co., Preston, Ont.

**Oils and Lubricants**

Dixon, Jos. Crucible Co., Jersey City, N.J.  
 Hamilton Facing Mill Co., Hamilton, Ont.  
 Imperial Oil Co., Petrolea, Ont.  
 Queen City Oil Co., Toronto.

**Oil Cloth**

Dominion Oil Cloth Co., Montreal.

**Paints and Colors**

Berry Bros., Walkerville, Ont.  
 McArthur, Corneille & Co., Montreal.

**Paper Manufacturers**

Barber, Wm. & Bros., Georgetown, Ont.  
 Toronto Paper Mfg. Co., Cornwall, Ont.

**Patents**

Budden, Hanbury A., Montreal.  
 Fetherstonhaugh & Co., Toronto.  
 Marion & Marion Montreal.

**Patterns (Wood and Iron)**

Maxwell, David &amp; Sons, St. Mary's, Ont.

**Perforated Metals**

Globe Machine & Stamping Co., Cleveland, Ohio.  
 Greening, B. Wire Co., Hamilton, Ont.  
 Metallic Roofing Co., Toronto.  
 Pedlar People, Oshawa, Ont.

**Personal Accident**

Canadian Casualty &amp; Boiler Insurance Co., Toronto.

**Phosphorizers**

McCullough-Dalszell Crucible Co., Pittsburg, Pa.

**Piano Action and Key Machinery**

H. Gearing, Toronto.

**Pig Iron**

Bourne-Fuller Co., Cleveland, Ohio.  
 Canada Iron Furnace Co., Montreal.  
 Nova Scotia Steel & Coal Co., New Glasgow, N.S.  
 Syracuse Smelting Works Montreal.

**Pipe (Riveted, Iron and Steel)**

Babcock & Wilcox, Limited, Montreal.  
 McDougall, John, Caledonian Iron Works Co., Montreal.

**Pipe Threading Machines**

Armstrong Mfg. Co., Bridgeport, Conn.  
 Butterfield & Co., Rock Island, Que.  
 Petrie, H. W., Toronto.

**Pipes and Tubes**

Bourne-Fuller Co., Cleveland, Ohio.  
 Canada Foundry Co., Toronto.  
 Montreal Pipe Foundry Co., Montreal.

**Plaster**

Albert Mfg. Co., Hillsborough, N.B.

**Plates**

Bourne-Fuller Co., Cleveland, Ohio.  
 Nova Scotia Steel & Coal Co., New Glasgow, N.S.

**Plumbago**

Hamilton Facing Mills Co., Hamilton, Ont.  
 McCullough-Dalszell Crucible Co., Pittsburg, Pa.

**Pneumatic Tools**

Allis-Chalmers-Bullock, Limited, Montreal.  
 Canadian Rand Drill Co., Sherbrooke, Que.  
 Hamilton Facing Mill Co., Hamilton, Ont.

**Pointer Rolls (For Rods and Wire)**

Turner, Vaughn &amp; Taylor Co., Cuyahoga Falls, Ohio.

**Power Plants—Equipments**

Allis-Chalmers-Bullock, Limited, Montreal.  
 Babcock & Wilcox, Limited, Montreal.  
 Canadian General Electric Co., Toronto.  
 Canadian Westinghouse Co., Ltd., Hamilton, Ont.  
 Darling Bros., Montreal.  
 Economic Power, Light & Heat Supply Co., Toronto.  
 Electrical Construction Co., London, Ont.  
 Goldie & McCulloch, Galt, Ont.  
 Gutta Percha & Rubber Mfg. Co., Toronto.  
 Hamilton, Wm. Mfg. Co., Peterborough, Ont.  
 Jeffrey Mfg. Co., Columbus, Ohio.  
 Jones & Moore Electric Co., Toronto.  
 Keystone Engineering Co., Toronto.  
 McDougall, John, Caledonian Iron Works Co., Montreal.  
 Packard Electric Co., St. Catharines, Ont.  
 Perrin, Wm. R. & Co., Limited, Toronto.  
 Petrie, H. W., Toronto.  
 Phillips, Eugene F., Electrical Works, Montreal.  
 Robb Engineering Co., Amherst, N.S.  
 Smart-Turner Machine Co., Hamilton, Ont.  
 Sturtevant, B. F. Co., Boston, Mass.  
 Toronto & Hamilton Electric Co., Hamilton, Ont.

**Presses (Tile, Sewer Pipe, Nozzles and Sleeves)**

Turner, Vaughn &amp; Taylor Co., Cuyahoga Falls Ohio.

**Pulleys**

Darling Bros., Montreal.  
 Goldie & McCulloch Co., Galt, Ont.  
 Hamilton, Wm. Mfg. Co., Peterborough, Ont.  
 Jeffrey Mfg. Co., Columbus, Ohio.  
 McDougall, John, Caledonian Iron Works Co., Montreal.  
 Petrie, H. W., Toronto.  
 Smart-Turner Machine Co., Hamilton, Ont.

**Producer Gas Plants**

Economic Power, Light &amp; Heat Supply Co., Toronto.

**Pumps and Pumping Machinery**

Allis-Chalmers-Bullock, Limited, Montreal.  
 Canada Foundry Co., Toronto.

When writing to Advertisers kindly mention THE CANADIAN MANUFACTURER.

# CLASSIFIED INDEX.

(CONTINUED).

Darling Bros., Montreal.  
 Downie Pump Co., Downsville, Pa.  
 Goldie & McCulloch Co., Galt, Ont.  
 Jenckes Machine Co., Sherbrooke, Que.  
 Kerr Engine Co., Walkerville, Ont.  
 Morris Machine Works, Baldwinsville, N.Y.  
 McDougall, John, Caledonian Iron Works Co., Montreal.  
 Ontario Wind Engine & Pump Co., Toronto.  
 Petrie, H. W., Toronto.  
 Smart-Turner Machine Co., Hamilton, Ont.

**Punches and Shears**  
 Globe Machine & Stamping Co., Cleveland, Ohio.  
 Petrie, H. W., Toronto.

**Purifiers**  
 Babcock & Wilcox, Limited, Montreal.  
 Goldie & McCulloch Co., Galt, Ont.  
 McDougall, John, Caledonian Iron Works Co., Montreal.

**Purifying and Softening Systems (Water)**  
 Babcock & Wilcox, Limited, Montreal.  
 Darling Bros., Montreal.  
 McDougall, John, Caledonian Iron Works Co., Montreal.

**Railroads**  
 Chicago & North-Western Ry., Toronto and St. Paul, Minn.

**Railway Supplies**  
 Algoma Steel Co., Sault Ste. Marie, Ont.  
 Allis-Chalmers-Bullock, Limited, Montreal.  
 Gartshore, John J., Toronto.  
 Greening, B. Wire Co., Hamilton, Ont.  
 Gutta Percha & Rubber Mfg. Co., Toronto.  
 Hopkins, F. H. & Co., Montreal.  
 Nova Scotia Steel & Coal Co., New Glasgow, N.S.  
 Phillips, Eugene F., Electrical Works, Montreal.

**Reamers**  
 Butterfield & Co., Rock Island, Que.

**Rivets**  
 Bourne-Fuller Co., Cleveland, Ohio.  
 London Rolling Mills, London, Ont.

**Rock and Ore Crushers**  
 Allis-Chalmers-Bullock, Limited, Montreal.  
 Bradley Pulverizer Co., Boston, Mass.

**Rolling Mill Engineers**  
 Bourne-Fuller Co., Cleveland, Ohio.

**Roofing**  
 Bourne-Fuller Co., Cleveland, Ohio.  
 Metallic Roofing Co., Toronto.  
 Pedlar People, Oshawa, Ont.

**Rubber Goods**  
 Gutta Percha & Rubber Mfg. Co., Toronto.

**Rubber Packing**  
 Gutta Percha & Rubber Mfg. Co., Toronto.

**Rubber Washing Tubs**  
 Turner, Vaughn & Taylor Co., Cuyahoga Falls, Ohio.

**Rural Mail Boxes**  
 Globe Machine & Stamping Co., Cleveland, Ohio.

**Saddlery Hardware**  
 McKinnon Dash & Metal Works Co., St. Catharines, Ont.

**Safes and Vaults**  
 Goldie & McCulloch Co., Galt, Ont.

**Saw Mill Machinery**  
 Allis-Chalmers-Bullock, Limited, Montreal.

**Screws**  
 Morrow, John, Machine Screw Co., Ingersoll, Ont.

**Screw Plates**  
 Armstrong Mfg. Co., Bridgeport, Conn.  
 Butterfield & Co., Rock Island, Que.

**Sewer Pipes**  
 Dominion Sewer Pipe Co., Swansea, Ont.

**Shafting**  
 Allis-Chalmers-Bullock, Limited, Montreal.  
 Bourne-Fuller Co., Cleveland, Ohio.  
 Goldie & McCulloch Co., Galt, Ont.  
 Jeffrey Mfg. Co., Columbus, Ohio.  
 McDougall, John, Caledonian Iron Works Co., Montreal.  
 Nova Scotia Steel & Coal Co., New Glasgow, N.S.  
 Petrie, H. W., Toronto.  
 Smart-Turner Machine Co., Hamilton, Ont.

**Shear Knives**  
 Hay, Peter Knife Co., Galt, Ont.

**Sheets (Iron and Steel)**  
 Bourne-Fuller Co., Cleveland, Ohio.  
 Leslie, A. C. & Co., Montreal.  
 Lysaght, John, Limited, Bristol, England, and Montreal.  
 Metallic Roofing Co., Toronto.  
 Pedlar People, Oshawa, Ont.

## Sheet Metal Goods

Globe Machine & Stamping Co., Cleveland, Ohio.  
 Metallic Roofing Co., Toronto.  
 Pedlar People, Oshawa, Ont.

## Sheet Metal Stamping

Globe Machine & Stamping Co., Cleveland, Ohio.  
 Metallic Roofing Co., Toronto.  
 Pedlar People, Oshawa, Ont.

## Shovels.

Hamilton Facing Mill Co., Hamilton, Ont.

## Smoke Stacks

Gearing, H., Toronto.  
 Hamilton, Wm. Mfg. Co., Peterborough, Ont.  
 McDougall, John, Caledonian Iron Works Co., Montreal.  
 Robb Engineering Co., Amherst, N.S.  
 Smart-Turner Machine Co., Hamilton, Ont.

## Solder

Globe Machine & Stamping Co., Cleveland, Ohio.  
 Syracuse Smelting Co., Montreal.

## Special Machinery

Allis-Chalmers-Bullock, Limited, Montreal.  
 Globe Machine & Stamping Co., Cleveland, Ohio.  
 Smart-Turner Machine Co., Hamilton, Ont.

## Speed Recorders

Bristol Co., Waterbury, Conn.

## Sprinkler Insurance

Canadian Casualty & Boiler Insurance Co., Toronto.

## Stamps and Stencils

Globe Machine & Stamping Co., Cleveland, Ohio.

## Steam Pumps

Allis-Chalmers-Bullock, Limited, Montreal.  
 Canada Foundry Co., Toronto.  
 Darling Bros., Montreal.  
 Goldie & McCulloch Co., Galt, Ont.  
 McDougall, John, Caledonian Iron Works Co., Montreal.  
 Petrie, H. W., Toronto.  
 Smart-Turner Machine Co., Hamilton, Ont.  
 Williams, A. R. Machinery Co., Toronto.

## Steam Separators

Babcock & Wilcox, Limited, Montreal.  
 Darling Bros., Montreal.  
 Robb Engineering Co., Amherst, N.S.  
 Sheldon & Sheldon, Galt, Ont.  
 Smart-Turner Machine Co., Hamilton, Ont.

## Steam Shovels

Allis-Chalmers-Bullock, Limited, Montreal.

## Steam Specialties

Darling Bros., Montreal.  
 Sheldon & Sheldon, Galt, Ont.  
 Sturtevant, B. F. Co., Hyde Park, Mass.

## Steam Valves

Babcock & Wilcox, Limited, Montreal.  
 Darling Bros., Montreal.  
 Kerr Engine Co., Walkerville, Ont.  
 Petrie, H. W., Toronto.  
 Williams, A. R. Machinery Co., Toronto.

## Steel Rails

Algoma Steel Co., Sault Ste. Marie, Ont.  
 Drummond, McCall & Co., Montreal and Toronto.  
 Gartshore, John J., Toronto.  
 Hopkins, F. H. & Co., Montreal.

## Steel Shafting

Darling Bros., Montreal.  
 Goldie & McCulloch Co., Galt, Ont.  
 Hamilton, Wm. Mfg. Co., Peterborough, Ont.  
 Leslie, A. C. & Co., Montreal.  
 McDougall, John, Caledonian Iron Works Co., Montreal.  
 Nova Scotia Steel & Coal Co., New Glasgow, N.S.

## Stocks and Dies

Armstrong Mfg. Co., Bridgeport, Conn.  
 Butterfield & Co., Rock Island, Que.  
 Petrie, H. W., Toronto.

## Stoppers

McCullough-Dalzell Crucible Co., Pittsburg, Pa.

## Structural Steel

Bourne-Fuller Co., Cleveland, Ohio.  
 Canada Foundry Co., Toronto.  
 Hopkins, F. H. & Co., Montreal.

## Sulphate of Alumina

Nichols Chemical Co. of Canada, Montreal.

## Suspension Furnaces

Continental Iron Works Co., New York City.

## Tanks (Oil and Water)

Canada Foundry Co., Toronto.  
 Goldie & McCulloch Co., Galt, Ont.  
 Hamilton, Wm. Mfg. Co., Peterborough, Ont.  
 Jenckes Machine Co., Sherbrooke, Que.  
 McDougall, John, Caledonian Iron Works Co., Montreal.  
 Ontario Wind Engine & Pump Co., Toronto.

## Taps and Dies

Butterfield & Co., Rock Island, Que.  
 Globe Machine & Stamping Co., Cleveland, Ohio.

## Tees

Bourne-Fuller Co., Cleveland, Ohio.  
 Canada Foundry Co., Toronto.

## Textile Manufacturers

Dominion Oil Cloth Co., Montreal.  
 Storey, W. H. & Sons, Acton, Ont.

## Thermometers (Recording)

Bristol Co., Waterbury, Conn.

## Tin

Leslie, A. C. & Co., Montreal.  
 Syracuse Smelting Works, Montreal.

## Tool Steel

Bourne-Fuller Co., Cleveland, Ohio.  
 Hopkins, F. H. & Co., Montreal.  
 Leslie, A. C. & Co., Montreal.

## Trucks

Hopkins, F. H. & Co., Montreal.  
 McDougall, John, Caledonian Iron Works Co., Montreal.  
 Sheldon & Sheldon, Galt, Ont.

## Trucks (Railway)

Canada Foundry Co., Toronto.

## Trucks (Wire Mill Supplies)

Turner, Vaughn & Taylor Co., Cuyahoga Falls, Ohio.

## Tubs (Cleaning and Coating Wire)

Turner, Vaughn & Taylor Co., Cuyahoga Falls, Ohio.

## Tumbling Barrels

Globe Machine & Stamping Co., Cleveland, Ohio.  
 Petrie, H. W., Toronto.  
 Smart-Turner Machine Co., Hamilton, Ont.

## Turbines

Canada Foundry Co., Toronto.  
 Hamilton, Wm. Mfg. Co., Peterborough, Ont.  
 Jenckes Machine Co., Sherbrooke, Que.

## Valves

Babcock & Wilcox, Limited, Montreal.  
 Canada Foundry Co., Toronto.  
 Hamilton Brass Mfg. Co., Hamilton, Ont.  
 Kerr Engine Co., Walkerville, Ont.  
 Petrie, H. W., Toronto.  
 Smart-Turner Machine Co., Hamilton, Ont.  
 Williams, A. R. Machinery Co., Toronto.

## Valves (Rubber)

Gutta Percha & Rubber Mfg. Co., Toronto.

## Varnishes

Berry Bros., Walkerville, Ont.

## Ventilators

Darling Bros., Montreal.  
 Metallic Roofing Co., Toronto.  
 Pedlar People, Oshawa, Ont.  
 Sheldon & Sheldon, Galt, Ont.  
 Sturtevant, B. F. Co., Boston, Mass.

## Wagon and Carriage Wood Work

Hore, F. W. & Son, Hamilton, Ont.

## Washers or Hollinders (Cleaning Rubber)

Turner, Vaughn & Taylor Co., Cuyahoga Falls, Ohio.

## Water Power Development

Vogel, C. H., Ottawa.

## Water Purifying Chemicals

Canada Chemical Mfg. Co., London, Ont.  
 Canada Process Co., Toronto.

## Water Softening Plants

Pittsburg Filter Mfg. Co., Pittsburg, Pa.

## Wheelbarrows.

Hamilton Facing Mill Co., Hamilton, Ont.

## Windmills

Ontario Wind Engine & Pump Co., Toronto.

## Wiping Rags for Waste

Schienman, I. L. & Co., Detroit, Mich.

## Wire Mill Supplies

Turner, Vaughn & Taylor Co., Cuyahoga Falls, Ohio.

## Wire and Wire Rope

Dominion Wire Rope Co., Montreal.  
 Greening, B. Wire Co., Hamilton, Ont.  
 Leslie, A. C. & Co., Montreal.  
 Phillips, Eugene F. Electrical Works, Montreal.

## Wire Rope Fittings

Dominion Wire Rope Co., Montreal.

## Wire Cloth

Greening, B. Wire Co., Hamilton, Ont.

## Wire Drawing Machinery

Turner, Vaughn & Taylor Co., Cuyahoga Falls, Ohio.

## Wood-Working Machinery

Goldie & McCulloch Co., Galt, Ont.  
 Petrie, H. W., Toronto.  
 Sheldon & Sheldon, Galt, Ont.  
 Williams, A. R. Machinery Co., Toronto.

## Zinc

Leslie, A. C. & Co., Montreal.  
 Syracuse Smelting Works, Montreal.



**Spinner Wanted.**

To take charge 6 mules D. & F. Permanent situation to reliable man. Apply direct.  
**GAUNT & JESSOP,**  
 Markham, Ont.

**English Card Clothing  
 Genuine Oak Belting**

**D. K. McLAREN,**  
 MONTREAL, TORONTO, QUEBEC, ST. JOHN



**NOTICE** The following are the Factory Inspectors for the Province of Ontario:

- JAS. T. BURKE, Parliament Buildings, Toronto.
- THOMAS KELTY, Parliament Buildings, Toronto.
- ARTHUR W. HOLMES, Parliament Buildings, Toronto.
- JOHN ARGUE, Parliament Buildings, Toronto.
- MARGARET CARLYLE, Parliament Buildings, Toronto.
- MRS. JAS. R. BROWN, Parliament Buildings, Toronto.

Persons having business with any of the Inspectors will find them at the above address. HON. NELSON MONTEITH, Minister of Agriculture.

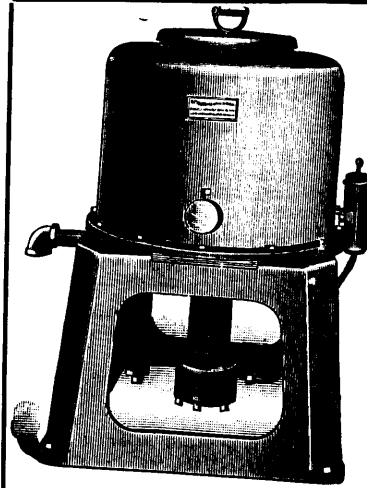

**Save the Oil**

From Chips, Screws, Nuts, Bolts, or any other small parts which are finished in oil, and

**Save the Waste**

Get 90% of the oil returned and have waste perfectly clean for use again.

Ask for the Catalogue

**THE CANADIAN OIL AND WASTE SAVING MACHINE COMPANY**

BROCKVILLE, ONT.

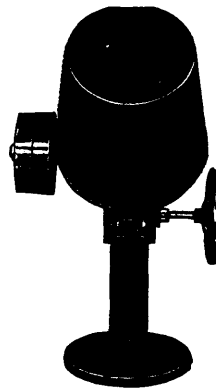

**IMPROVED**

**TUMBLING BARRELS**

The Globe Tilting Tumblers being CHEAPEST to operate are the CHEAPEST TO BUY.

SEND FOR CIRCULAR. WRITE FOR AGENCIES. MANUFACTURED BY

**THE GLOBE MACHINE & STAMPING CO.**

977 Hamilton St., CLEVELAND, OHIO.

**H. W. PETRIE, Canadian Agent,**  
 131-145 Front Street West, TORONTO, ONT.

**Albert Manufacturing Co.**

MANUFACTURERS OF THE WELL-KNOWN

**"Hammer Brand" Calcined Plaster** AND **PATENT ROCK WALL PLASTER.**

HILLSBOROUGH, N.B., CANADA.



**ARMSTRONG'S  
 RATCHET  
 ATTACHMENT  
 FOR  
 ARMSTRONG  
 DIE STOCKS**

For threading pipe in position close to walls or ceilings, in corners or wherever there is limited space.

Write for Catalogue and Prices.

**THE ARMSTRONG MFG. CO.,**  
 281 KNOWLTON ST.,  
 BRIDGEPORT, CONN., U.S.A.

**The STURTEVANT ENGINE**



stands in a class by itself. It represents the highest standard yet obtained in a relatively small reciprocating engine. Forced lubrication insures continuous operation, the enclosing features prevent all escape of oil and the watershed partition gives ready access to the piston rod stuffing box.

Send for Bulletin 125

**B. F. STURTEVANT CO., Boston, Mass.**

General Office and Works, Hyde Park, Mass.

New York Philadelphia Chicago London  
 Designers and Builders of Heating, Ventilating, Drying and Mechanical Draft Apparatus;  
 Fans, Blowers and Exhausters; Steam Engines, Electric Motors and Generating Sets; Fuel Economizers; Forges, Exhaust Heads, Steam Traps, Etc.

575

# INDEX TO ADVERTISEMENTS.

Where the folio is not given the Advertisement appears at intervals.

See Classified Index Beginning on Page 87

ofc ..... outside front cover.		obc.....outside back cover.	
<b>A</b>	<b>PAGE</b>	<b>PAGE</b>	<b>PAGE</b>
Agriculture, Ontario Minister of, Toronto.....	48	Canadian Casualty & Boiler Insurance Co. Toronto.....	8
Aitken, K. L., Toronto.....	8	Canadian Copper Co., New York, N.Y.....	5
Albert Mfg. Co., Hillsborough, N.B.....	48	Canadian General Electric Co., Toronto.....	15
Algoma Steel Co., Sault Ste. Marie, Ont.....	4	Canadian Manufacturer Pub. Co., Toronto.....	14
Allis-Chalmers-Bullock, Ltd., Montreal.....	51	Canadian National Exhibition, Toronto.....	40
American Carpet & Upholstery Journal, Philadelphia, Pa.....	48	Canadian Office & School Furniture Co., Preston, Ont.....	40
Armstrong Mfg. Co., Bridgeport, Conn.....	48	Canadian Oil & Waste Saving Machine Co. Brockville, Ont.....	48
<b>B</b>		Canadian Rand Drill Co., Sherbrooke, Que.....	42
Babcock & Wilcox, Limited, Montreal.....	ofc	Canadian Westinghouse Co., Ltd., Hamilton, Ont.....	51
Bank of Hamilton, Hamilton, Ont.....	39	Carter Publishing Co., London, Eng.....	7
Barber, Wm. & Bro., Georgetown, Ont.....	40	Cassella Color Co., New York and Montreal.....	7
Becker-Brainard Milling Machine Co., Hyde Park, Mass.....	10	Central Ontario Power Co., Peterboro, Ont.....	40
Bell Telephone Co.....	9	Chaplin, Wm., St. Catharines, Ont.....	16
Benson, W. T. & Co., Montreal.....	7	Chapman Double Ball Bearing Co., Toronto.....	30
Berg, A. & Sons, Toronto.....	37	Chicago & North-Western Railway, B. H. Bennett, General Agent, Toronto.....	2
Berry Bros., Walkerville, Ont.....	38	Clark-Demill Co., Hespeler, Ont.....	obc
Boiler Inspection & Insurance Co., Toronto.....	obc	Conduits Co., Limited, Toronto.....	3
Bourne-Fuller Co., Cleveland, Ohio.....	4	Continental Iron Works, New York, N.Y.....	12
Bradley Pulverizer Co., Boston, Mass.....	39	Copeland-Chatterson Co., Toronto.....	12
Bradstreets, Toronto and New York.....	45	Creelman Bros., Georgetown, Ont.....	12
Bristol Co., Waterbury, Conn.....	obc	Crocker-Wheeler Co., St. Catharines, Ont.....	40
Brunner, Mond & Co., Northwich, England.....	6	Cross, M. O., Engine Co., Detroit, Mich.....	42
Budden, Hanbury A., Montreal.....	8	<b>D</b>	
Business Systems, Toronto.....	5	Darling Bros., Montreal.....	42
Butterfield & Co., Rock Island, Que.....	9	Department Public Works, Ottawa.....	40
<b>C</b>		Dickenson, H., Toronto.....	42
Canada Chemical Mfg. Co., London, Ont.....	7	Dixon, Jos., Crucible Co., Jersey City, N.J.....	42
Canada Foundry Co., Toronto.....	4		
Canada Iron Furnace Co., Montreal.....	4		
Canada Process Co., Toronto.....	obc		
		Dominion Belting Co., Hamilton, Ont.....	10
		Dominion Henderson Bearing Co., Toronto.....	36
		Dominion Oil Cloth Co., Montreal.....	45
		Dominion Sewer Pipe Co., Swansea, Ont.....	4
		Dominion Wire Rope Co., Montreal.....	45
		Downie Pump Co., Downieville, Pa.....	4
		Drummond, McCall & Co., Montreal.....	45
		Dun, R. G. & Co., Toronto.....	9
		Dunbar Fire Brick Co., Pittsburg, Pa.....	
		<b>E</b>	
		Economic Power, Light & Heat Co., Toronto..	15
		Electrical Construction Co., London, Ont.....	9
		Elk Fire Brick Co., St. Mary's, Pa.....	11
		Engineering Review, London, England.....	
		Expanded Metal & Fireproofing Co., Toronto..	
		<b>F</b>	
		Factory Inspectors, Ontario.....	39
		Factory Locations.....	40
		Fell, I. C. & Co., Toronto.....	8
		Fensom, C. J., Toronto.....	obc
		Fetherstonhaugh & Co., Toronto.....	36
		Fleishhacker, A. & Co., San Francisco, Cal.....	7-15
		Forman, John, Montreal.....	
		Gartshore, John J., Toronto.....	40
		Gartshore-Thomson Pipe & Foundry Co., Hamilton, Ont.....	39
		Gearing, H., Toronto.....	8
		Gillespie, W., Toronto.....	40
		Globe Machine & Stamping Co., Cleveland, Ohio	48

**Working Iron in Common or Refined Bars**

London Bars are made in the following sizes:

Flats, - - - - -	7/16 inch to 4 inch x 3/16 inch to 1 1/4 inch
Round Edge Tire, 1 inch to 3 inch	Rounds, 3/16 inch to 2 1/4 inch
Squares, - 1/4 " to 2 1/4 "	Ovals, 1/2 " to 1 1/2 "
Half Ovals, - 1/2 " to 2 1/2 "	Half Rounds, 1/2 " to 2 1/4 "

54

**London Rolling Mills**  
London, Canada.

**PERRIN'S**  
HYDRAULIC AND POWER SCREW

**PRESSES**  
WILLIAM R. PERRIN & COMPANY LIMITED,  
TORONTO, CANADA.

When writing to Advertisers kindly mention THE CANADIAN MANUFACTURER.

INDEX TO ADVERTISEMENTS (Continued).

	PAGE	M	PAGE		PAGE
Goldie & McCulloch Co., Galt, Ont.....	3	Marion & Marion, Montreal.....	8	Petrie, H. D., Hamilton, Ont.....	8
Grand & Toy, Toronto.....	39	Maxwell, David, & Sons, St. Mary's, Ont.....	40	Phillips, Eugene F., Electrical Works, Montreal.....	15
Greening, B. Wire Co., Hamilton, Ont.....	39	Metallic Roofing Co., Toronto.....	45	Piper, N. L. Railway Supply Co., Toronto.....	11
Gutta Percha & Rubber Mfg. Co., Toronto.....	ofc	Mills, S. D., Toronto.....	8	Pittsburg Filter Co., Pittsburg, Pa.....	50
<b>H</b>					
Hamilton Brass Mfg. Co., Hamilton, Ont.....	14	Milnes, J. H. & Co., Toronto.....	9	<b>Q</b>	
Hamilton Facing Mills Co., Hamilton, Ont.....	ofc	Monteith-Nixon, Limited, Toronto.....	10	Queen City Oil Co. Toronto.....	ofc
Hamilton, Wm. Mfg. Co., Peterborough, Ont.....	10	Montreal Belting Co., Montreal.....	8	Queen's Run Fire Brick Co. Lock Haven, Pa.....	ofc
Harbison-Walker Refractories Co., Pittsburg, Pa.	38	Montreal Pipe Foundry Co., Montreal.....	39	<b>R</b>	
Hay, Peter Knife Co., Galt, Ont.....	13	Morris Machine Works, Baldwinsville, N.Y.....	45	Robb Engineering Co., Amherst, N.S.....	45
Henry & Adams, Toronto.....	38	Morrison, T. A. & Co., Montreal.....	8	Roman Stone Co., Toronto.....	
Heys, Thomas & Son, Toronto.....	8	Morrow, John, Machine Screw Co., Ingersoll, Ont.	40	<b>S</b>	
Hopkins, F. H. & Co., Montreal.....	36	<b>Mc</b>		Schienman, I. L. Co., Detroit, Mich.....	
Hore, F. W. & Son, Hamilton, Ont.....	39	McArthur, Corneille & Co., Montreal.....	ofc	Sheldon & Sheldon, Galt, Ont.....	2
Horsburgh & Scott, Cleveland, Ohio.....	40	McCullough-Dalsell Crucible Co., Pittsburg, Pa.	38	Smart-Turner Machine Co., Hamilton, Ont.....	ofc
Hunt, Robert W. & Co., Chicago, Ill.....	8	McDougall, John, Caledonian Iron Works Co.,	40	Smith's Falls Malleable Castings Co., Smith's	
<b>I</b>					
Imperial Oil Co., Petrolea, Ont.....	7	Montreal.....		Falls, Ont.....	ofc
International Harvester Co., Chicago, Ill.....	12	McGuire, W. J. & Co., Toronto and Montreal.....	36	Spence, R. & Co., Hamilton, Ont.....	40
<b>J</b>					
Jeffrey Mfg. Co., Columbus, Ohio.....	11	McKinnon Dash & Metal Works Co., St.	ofc	Storey, W. H. & Son, Acton, Ont.....	39
Jenokes Machine Co., Sherbrooke, Que.....	6	Catharines, Ont.....		Stowe-Fuller Co., Cleveland, Ohio.....	40
Jones & Moore Electric Co., Toronto.....	15	McLaren, D. K., Montreal and Toronto.....	48	Sturtevant, B. F. Co., Boston, Mass.....	48
Jones, J. L., Engraving Co., Toronto.....	40	<b>N</b>		Sylvester Mfg. Co., Lindsay, Ont.....	40
<b>K</b>					
Kays, Joseph & Sons, Limited, London, Eng...	3	Neff & Postlethwaite, Toronto.....		Syracuse Smelting Co. Montreal and New York	13
Kelly's Directories, Toronto and London, Eng-	50	Nichols Chemical Co. of Canada, Montreal.....		<b>T</b>	
land.....	50	Northern Aluminum Co., Shawinigan Falls, Que.	6	Toronto & Hamilton Electric Co., Hamilton,	
Kerr Engine Co., Walkerville, Ont.....	11	and Pittsburg, Pa.....		Ont.....	15
Keystone Engineering Co Toronto.....	8	Nova Scotia Steel & Coal Co., New Glasgow,	6	Toronto Paper Mfg. Co., Cornwall, Ont.....	40
Krug & Crosby, Hamilton, Ont.....	10	N.S.....		Turner, Vaughn & Taylor, Cuyahoga Falls,	
<b>L</b>					
Leslie, A. C. & Co., Montreal.....	ofc	<b>O</b>		Ohio.....	ofc
London Rolling Mill Co., London, Ont.....	49	Oakey, John & Sons, London, England.....	7	<b>U</b>	
Lowell Crayon Co., Lowell, Mass.....	40	Ontario Wind Engine & Pump Co., Toronto.....	40	Union Drawn Steel Co., Hamilton, Ont.....	5
Lysaght, John, Limited, Bristol, England and		Orford Copper Co., New York, N.Y.....	5	<b>V</b>	
Montreal.....		<b>P</b>		Vogel, C. H., Ottawa.....	8
		Packard Electric Co., St. Catharines, Ont.....	14	<b>W</b>	
		Parke, Roderick J., Toronto.....	8	Wardlaw, T. D., Toronto.....	
		Pedlar People, Oshawa, Ont.....	41	Westinghouse Electric & Mfg. Co., Pittsburg,	
		Penman & Sprang, Windsor, Ont.....		Pa.....	51
		Pennsylvania Fire Brick Co., Beech Creek, Pa.		Williams, A. R. Machinery Co., Toronto.....	13
		Perrin, William R. & Co., Limited, Toronto and		Winn & Holland, Montreal.....	6
		Chicago, Ill.....	49		
		Petrie, H. W., Toronto.....	16		

The JOHN McDUGALL CALEDONIAN IRON WORKS CO., Limited

MONTREAL, P.Q.

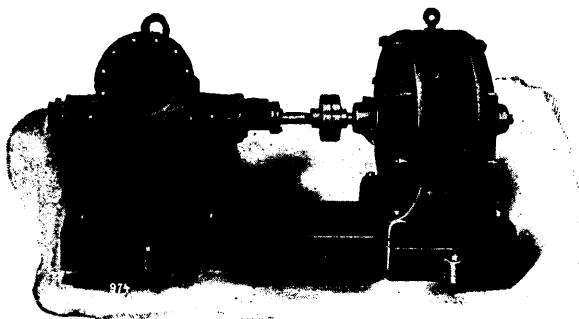

**BOILERS:** Return Tubular, McDougall Water Tube, etc.

**TANKS:** Water Tanks, Penstocks, Filters.

**MACHINERY:** Complete Power Plants designed and installed.

Sole Manufacturers in Canada for Worthington Turbine Pumps and Doble Impulse Water Wheels.



EXPORTERS

desiring full and up-to-date lists of buyers in Great Britain and Foreign Countries should consult Kelly's Directory of the Merchants, Manufacturers and Shippers of the World, (endorsed by the British Government) containing

LISTS OF

MANUFACTURERS OF THE WORLD, EXPORTERS AND IMPORTERS, BANKS, CHAMBERS OF COMMERCE, CONSULS AND SHIPPING AND FORWARDING AGENTS.

All classified and arranged by countries. The Directory is easy of reference, is indexed to articles as well as to countries and towns, and contains nearly 4,000 pages and over a million names.

KELLY PUBLISHING CO.,

Head Office: LONDON, W.C., ENGLAND, and at New York, Paris, Hamburg, Melbourne, Sydney, Dunedin, Cape Town, Bombay, Buenos Ayres, etc., etc.

Dominion Branch—70 Dunn Ave., TORONTO

Pittsburgh Filter Mfg. Co.

PITTSBURGH, PA.



FILTERS Softeners

City or Industrial

# WESTINGHOUSE MOTOR QUALITY

**Is a Fact  
Not an Expectation**

The inspection and tests given every part during every stage of manufacture, guarantee both quality and performance.

**Nothing is left to Chance**

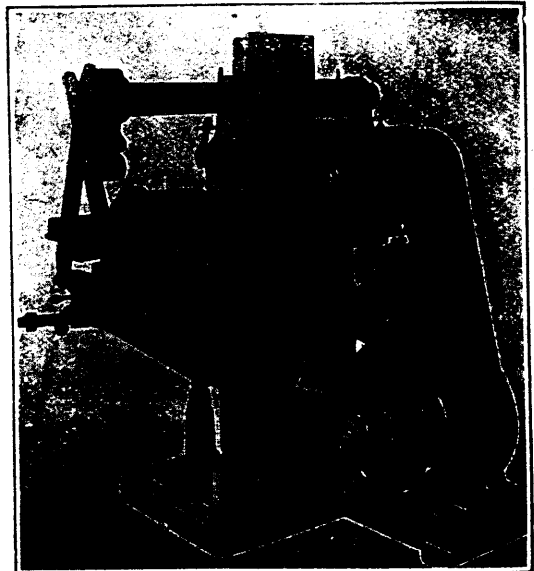

**WESTINGHOUSE TYPE S MOTOR**  
Driving Cincinnati Machine Co.'s No. 3 Plain Miller.

## Canadian Westinghouse Co., Limited

General Office and Works, HAMILTON, ONTARIO.

Lawlor Bldg., King and Yonge Sts.,  
TORONTO.  
152 Hasting Street,  
VANCOUVER.

For particulars address nearest office:  
HAMILTON.  
922-928 Union Bank Bldg.,  
WINNIPEG.

Sovereign Bank of Canada Bldg.,  
MONTREAL.  
184 Granville Street,  
HALIFAX.

# ALLIS - CHALMERS - BULLOCK LIMITED

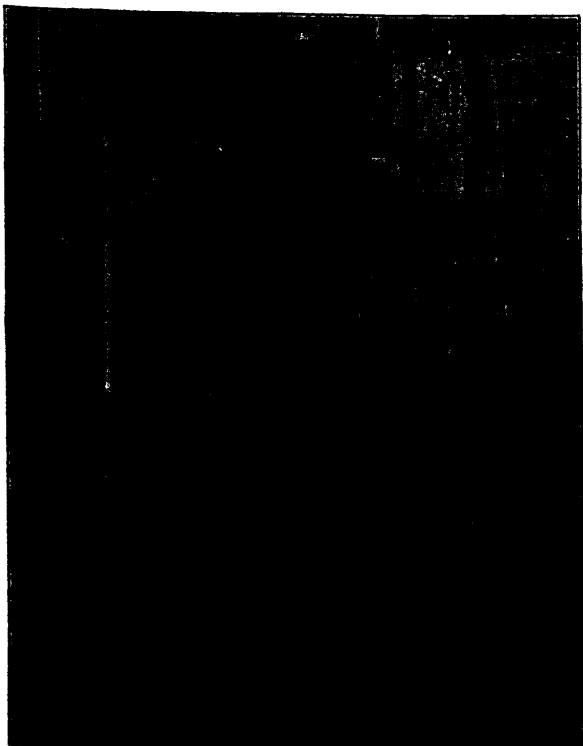

## IDEAL SMALL LIGHTING PLANT

TWO OF OUR 12 K.W. GENERATORS  
AND AUXILIARY APPARATUS FORM-  
ING THE LIGHTING PLANT AT WM.  
DOW & CO.'S BREWERY, MONTREAL.

**Head Office and Works  
MONTREAL**

### District Offices

TORONTO,	-	-	McKINNON BUILDING.
WINNIPEG	-	-	CANADA LIFE BUILDING.
NELSON	-	-	JOSEPHINE ST.
MONTREAL	-	-	SOVEREIGN BANK BUILDING.
VANCOUVER,	-	-	416 SEYMOUR ST.
NEW GLASGOW,	-	-	N.S. TELEPHONE BUILDING.

**THE QUEEN CITY OIL CO. LIMITED, LUBRICATING AND REFINED OIL**  
 TORONTO.

**McARTHUR,  
CORNEILLE & CO.**

**310 to 316 ST. PAUL ST.  
MONTREAL**

**OILS, CHEMICALS, DYESTUFFS  
AND  
TANNING EXTRACTS**

*Waxes, Gums, Shellacs,  
Glues, Gelatines, Etc.*

**CANADIAN AGENTS  
FOR THE**

**BERLIN ANILINE CO.  
BRITISH ALIZARINE CO. and  
MILLER'S TANNING EXTRACT CO.**

**THE BOILER INSPECTION  
and INSURANCE CO. of CANADA**

**CANADA LIFE BUILDING  
TORONTO**

Thirty Years' Experience as Consulting Engineers

Toronto, November 29th, 1904.  
**THE BOILER INSPECTION & INSURANCE CO.  
OF CANADA,**  
 Canada Life Building,  
 City.

Gentlemen:—

We have much pleasure in signifying our appreciation of the various engineering services you have rendered us during the many years we have had a Boiler Insurance Policy with you, and would say further, that the benefits we have derived from the advice given by your Engineers and Inspectors, from time to time, has been of great value to us.

Wishing you every success,

We remain,  
Yours truly,

**KEMP MANUFACTURING COMPANY,  
Per W. A. Kemp.**

**CONDUITS COMPANY  
LIMITED**

SUCCESSORS TO

**The Richmond Conduit and Mfg. Co.  
Limited**

Sole Manufacturers

Under U.S. and Canadian Patents

**GALVADUCT**

AND

**LORICATED**

**CONDUITS**

**For Interior Construction**

**TORONTO, CANADA**

**MANUFACTURING CHEMISTS**

**THE CANADA PROCESS COMPANY, LIMITED**

Office and Works, Queen's Wharf, BATHURST STREET, TORONTO

Manufacturers and Importers of High Grade Chemicals

Glauber Salts, Hypo-Sulphite of Soda, Nitrate of Iron,  
 Sulphuric Acid, Nitric Acid, Muriatic Acid,  
 Pure Liquid Carbonic Acid Gas "Zenith Brand."

Also Sulphite of Lime, Bi-Sulphite of Lime, Sulphite of Soda, Bi-Sulphite of Soda, Hydrofluoric Acid, Liquid Sulphur Dioxide and Specialties for Dyeing, Tanning and Manufacturing Industries.

**MACHINERY**

FOR

**Wire Drawing.  
Chain Making.**

Core Machines for general foundry practice.

Vitrified Sewer Pipe.

Rubber Washing.

Reclaimed Rubber Water Separators.

Write us—

**The TURNER, VAUGHN & TAYLOR CO.  
Cuyahoga Falls, O., U.S.A.**

**BRISTOL'S  
Recording Instruments**

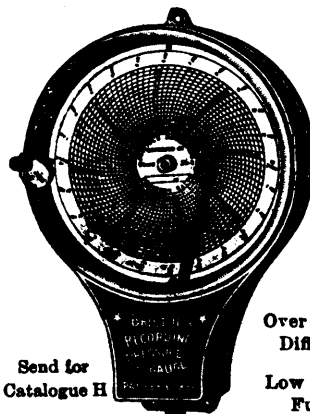

Send for  
Catalogue H

For.....

**Pressure,**

**Tempera-  
ture and**

**Electricity.**

Over One Hundred  
Different Varieties.

Low Prices and  
Fully Guaranteed

Gold Medal, St. Louis Exposition.

**THE BRISTOL CO.**

**WATERBURY, CONN., U.S.A.  
NEW YORK—114 Liberty St.  
LONDON—23 College Hill.**

**Smith's Falls Malleable  
Castings Company, Limited**

**CAPACITY 4,000 TONS**

MANUFACTURERS  
OF

**MALLEABLE  
IRON  
CASTINGS**

**Smith's Falls, Ont., Can.**

HAMILTON, ONT. Manufacturers of Ceylon Plumbago Supplies also Extra Fine Quality Moulding Sand. Pipe and Core Sand. Write for prices.

**PATENTS Fetherstonhaugh & Co.**  
 Head Office—TORONTO Branch Offices—Montreal, Ottawa, Winnipeg