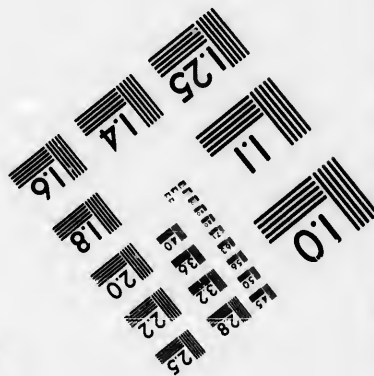
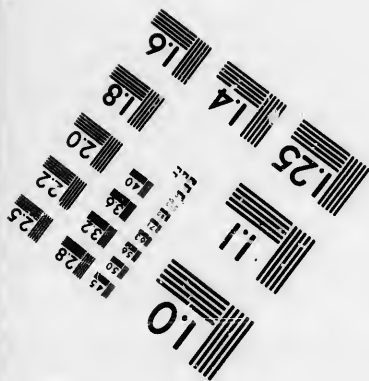
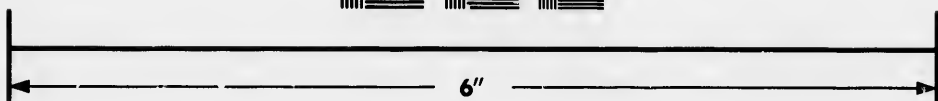
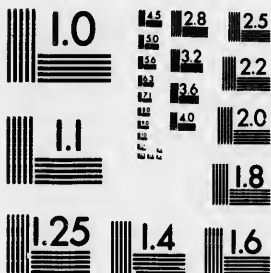


**IMAGE EVALUATION  
TEST TARGET (MT-3)**



**Photographic  
Sciences  
Corporation**

23 WEST MAIN STREET  
WEBSTER, N.Y. 14580  
(716) 872-4503

**CIHM/ICMH  
Microfiche  
Series.**

**CIHM/ICMH  
Collection de  
microfiches.**



Canadian Institute for Historical Microreproductions / Institut canadien de microreproductions historiques

**© 1986**



Technical and Bibliographic Notes/Notes techniques et bibliographiques

The Institute has attempted to obtain the best original copy available for filming. Features of this copy which may be bibliographically unique, which may alter any of the images in the reproduction, or which may significantly change the usual method of filming, are checked below.

- Coloured covers/  
Couverture de couleur
- Covers damaged/  
Couverture endommagée
- Covers restored and/or laminated/  
Couverture restaurée et/ou pelliculée
- Cover title missing/  
Le titre de couverture manque
- Coloured maps/  
Cartes géographiques en couleur
- Coloured ink (i.e. other than blue or black)/  
Encre de couleur (i.e. autre que bleue ou noire)
- Coloured plates and/or illustrations/  
Planches et/ou illustrations en couleur
- Bound with other material/  
Relié avec d'autres documents
- Tight binding may cause shadows or distortion  
along interior margin/  
La reliure serrée peut causer de l'ombre ou de la  
distorsion le long de la marge intérieure
- Blank leaves added during restoration may  
appear within the text. Whenever possible, these  
have been omitted from filming/  
Il se peut que certaines pages blanches ajoutées  
lors d'une restauration apparaissent dans le texte,  
mais, lorsque cela était possible, ces pages n'ont  
pas été filmées.
- Additional comments:/  
Commentaires supplémentaires:

L'Institut a microfilmé le meilleur exemplaire qu'il lui a été possible de se procurer. Les détails de cet exemplaire qui sont peut-être uniques du point de vue bibliographique, qui peuvent modifier une image reproduite, ou qui peuvent exiger une modification dans la méthode normale de filmage sont indiqués ci-dessous.

- Coloured pages/  
Pages de couleur
- Pages damaged/  
Pages endommagées
- Pages restored and/or laminated/  
Pages restaurées et/ou pelliculées
- Pages discoloured, stained or foxed/  
Pages décolorées, tachetées ou piquées
- Pages detached/  
Pages détachées
- Showthrough/  
Transparence
- Quality of print varies/  
Qualité inégale de l'impression
- Includes supplementary material/  
Comprend du matériel supplémentaire
- Only edition available/  
Seule édition disponible
- Pages wholly or partially obscured by errata  
slips, tissues, etc., have been refilmed to  
ensure the best possible image/  
Les pages totalement ou partiellement  
obscurcies par un feuillet d'errata, une pelure,  
etc., ont été filmées à nouveau de façon à  
obtenir la meilleure image possible.

This item is filmed at the reduction ratio checked below/  
Ce document est filmé au taux de réduction indiqué ci-dessous.

10X	12X	14X	16X	18X	20X	22X	24X	26X	28X	30X	32X
					/						

The copy filmed here has been reproduced thanks to the generosity of:

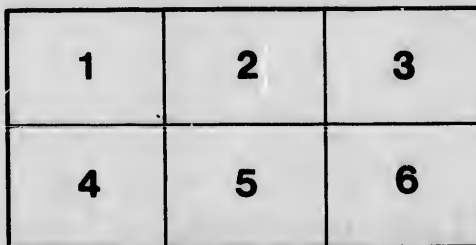
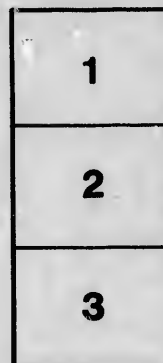
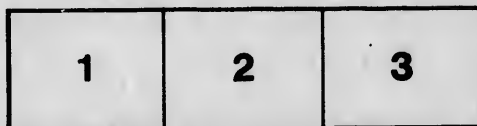
Library of the Public  
Archives of Canada

The images appearing here are the best quality possible considering the condition and legibility of the original copy and in keeping with the filming contract specifications.

Original copies in printed paper covers are filmed beginning with the front cover and ending on the last page with a printed or illustrated impression, or the back cover when appropriate. All other original copies are filmed beginning on the first page with a printed or illustrated impression, and ending on the last page with a printed or illustrated impression.

The last recorded frame on each microfiche shall contain the symbol  $\rightarrow$  (meaning "CONTINUED"), or the symbol  $\nabla$  (meaning "END"), whichever applies.

Maps, plates, charts, etc., may be filmed at different reduction ratios. Those too large to be entirely included in one exposure are filmed beginning in the upper left hand corner, left to right and top to bottom, as many frames as required. The following diagrams illustrate the method:



L'exemplaire filmé fut reproduit grâce à la générosité de:

La bibliothèque des Archives  
publiques du Canada

Les images suivantes ont été reproduites avec le plus grand soin, compte tenu de la condition et de la netteté de l'exemplaire filmé, et en conformité avec les conditions du contrat de filmage.

Les exemplaires originaux dont la couverture en papier est imprimée sont filmés en commençant par le premier plat et en terminant soit par la dernière page qui comporte une empreinte d'impression ou d'illustration, soit par le second plat, selon le cas. Tous les autres exemplaires originaux sont filmés en commençant par la première page qui comporte une empreinte d'impression ou d'illustration et en terminant par la dernière page qui comporte une telle empreinte.

Un des symboles suivants apparaîtra sur la dernière image de chaque microfiche, selon le cas: le symbole  $\rightarrow$  signifie "A SUIVRE", le symbole  $\nabla$  signifie "FIN".

Les cartes, planches, tableaux, etc., peuvent être filmés à des taux de réduction différents. Lorsque le document est trop grand pour être reproduit en un seul cliché, il est filmé à partir de l'angle supérieur gauche, de gauche à droite, et de haut en bas, en prenant le nombre d'images nécessaire. Les diagrammes suivants illustrent la méthode.

ails  
du  
modifier  
une  
page

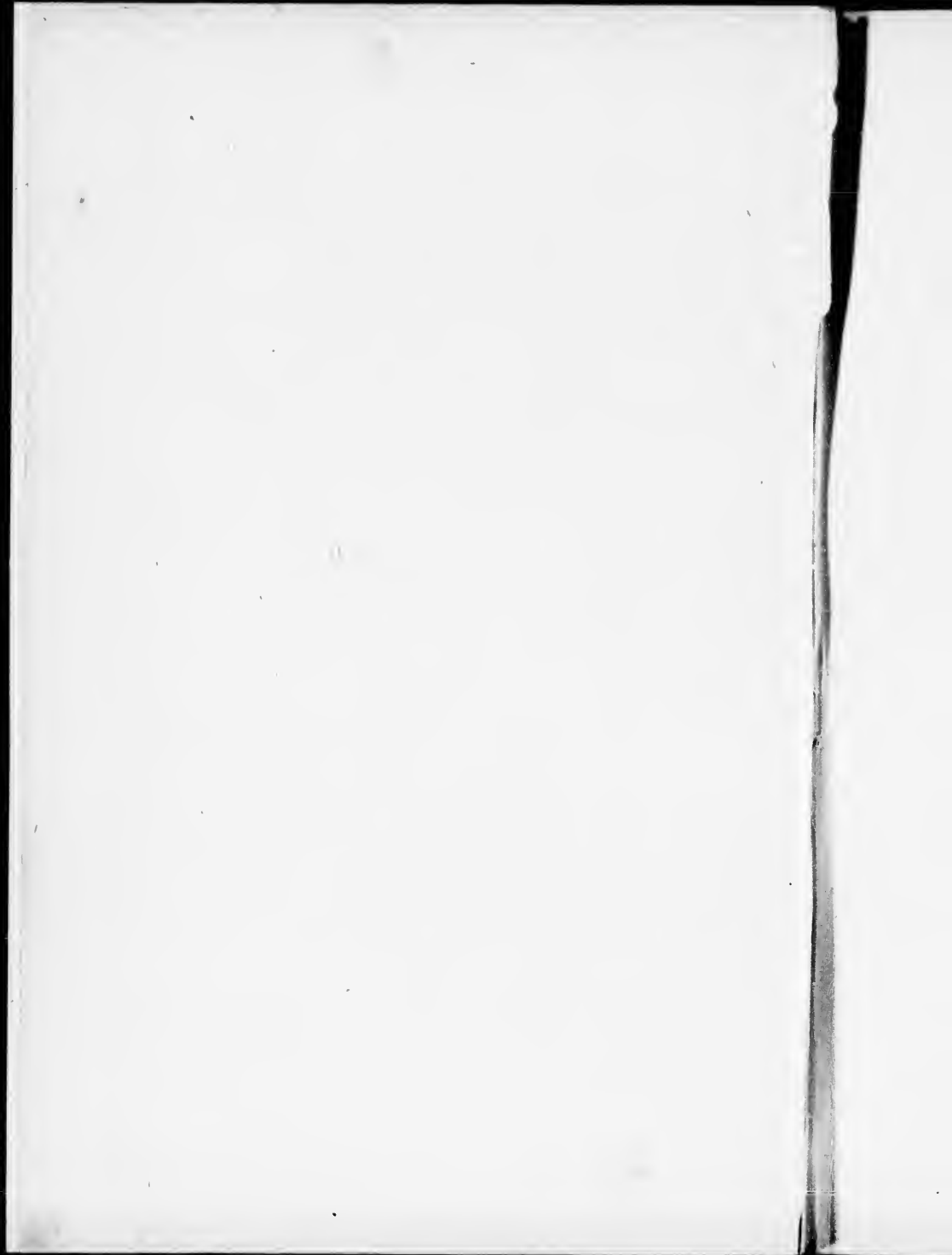
rata  
o

velure,  
à

32X



THE ATLANTIC FERRY.







*From an old aquatint.*

THE BRITISH QUEEN, 1839.  
(The P resident, 1840, was identical in build.)

*Frontispiece, see page 16.*

WHITT

G.

TH

THE ATLANTIC FERRY,  
ITS SHIPS, MEN, AND  
WORKING.

BY

ARTHUR J. MAGINNIS.

MEMBER OF THE INSTITUTION OF NAVAL ARCHITECTS.

*With numerous Illustrations, Diagrams, and Plans.*



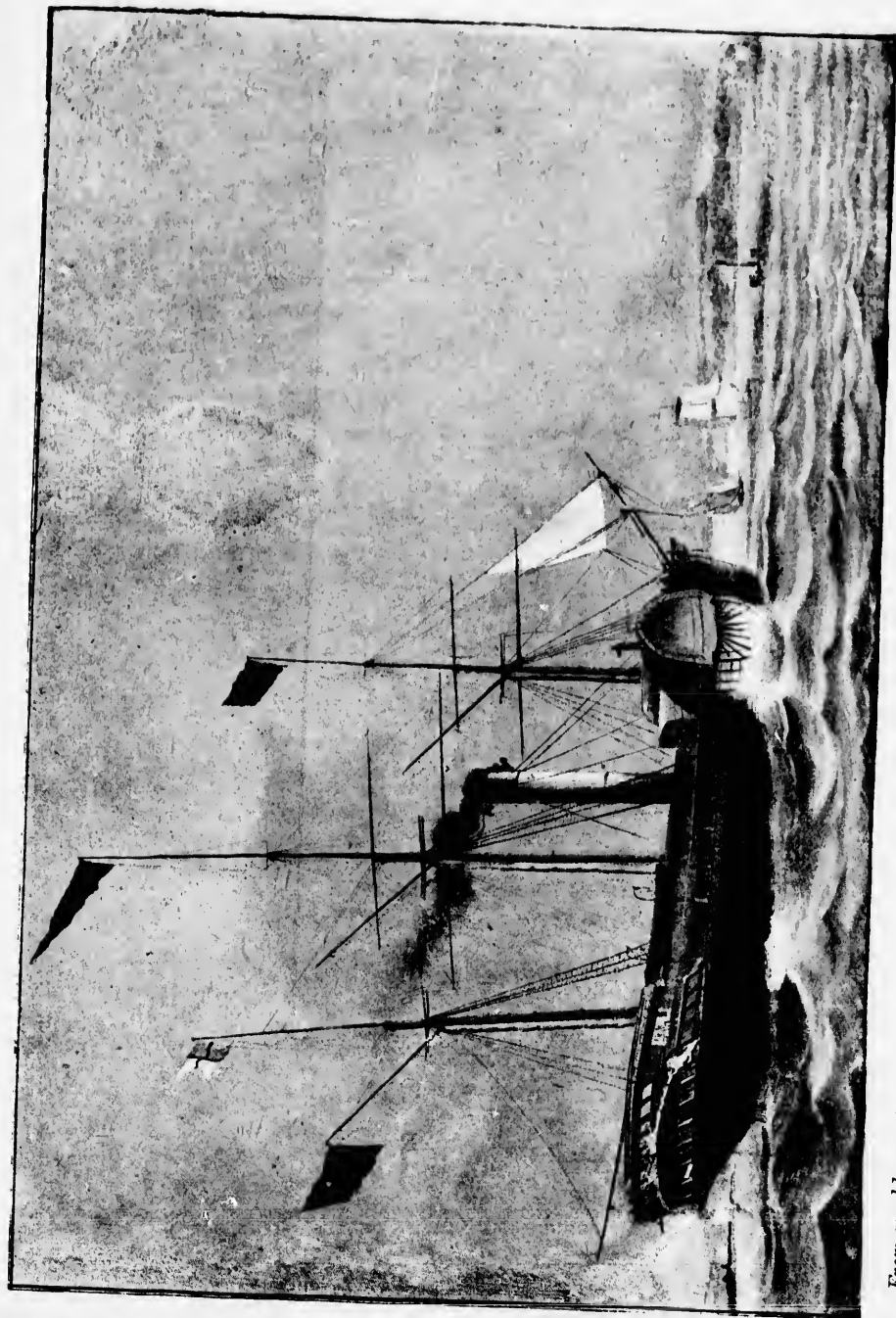
LONDON :

WHITTAKER AND CO., PATERNOSTER SQUARE.

G. BELL & SONS, YORK ST., COVENT GARDEN.

1892.





*From an old aquatint.*

THE BRITISH QUEEN, 1839.  
(The President, 1840, was identical in build.)

*Frontispiece, see page 16.*

*Frontispiece, see page 16.*

THE BRITISH QUEEN, 1839.  
(The P resident, 1840, was identical in build.)

*From an old aquatint.*

# THE ATLANTIC FERRY, ITS SHIPS, MEN, AND WORKING.

BY

ARTHUR J. MAGINNIS.

MEMBER OF THE INSTITUTION OF NAVAL ARCHITECTS.

*With numerous Illustrations, Diagrams, and Plans.*



LONDON :

WHITTAKER AND CO., PATERNOSTER SQUARE.

G. BELL & SONS, YORK ST., COVENT GARDEN.

1892.

VM  
" 615  
M3

CHISWICK PRESS:—C. WHITTINGHAM AND CO., TOOKS COURT,  
CHANCERY LANE.

10427

THE in  
trade h  
of man  
and sci  
publica  
give an  
routine  
sary to  
great s  
time, s  
chants  
the serv  
remark  
they ha  
It ma  
to the  
but in  
pose, to  
various  
viduals;  
describ  
which th  
The c

## PREFACE.

THE importance and extent of the Transatlantic steam trade has, ever since its commencement, been the occasion of many interesting articles in magazines, newspapers, and scientific periodicals; but, so far as I can trace, no publication has yet been issued which would, in itself, give an ordinary reader or passenger an idea of the routine, forethought, and general arrangements necessary to carry on such a far-reaching organization as a great steamship line, and which would, at the same time, set forth the various efforts of the noted merchants and scientists who have initiated and carried on the service, and also the nature and results of the more remarkable examples of vessels and machinery which they have employed.

It may perhaps be thought that the chapters relating to the working and management are somewhat brief; but in a book of this kind it would not serve any purpose, to describe minutely the minor details of the various departments, or duties appertaining to individuals; consequently, only such leading points are described as would serve to show the general system by which the organization is carried on.

The chapters devoted to a description of the inspection

made by the Governmental Supervising Authorities will, I trust, be reassuring to those who, for health, pleasure, or business, are constantly travelling by the great Liners, as they fully explain the careful and searching nature of the inspection and survey which is made periodically by an able staff of Surveyors, to insure safety under all circumstances; and as these gentlemen are solely in the service of their respective Governments, they are removed from all liability of being influenced by any personal interest or question of cost to the ship-owners, which may be entailed by the due fulfilment of the requirements enacted from time to time.

The retrospect of the trade was, in a brief form, brought forward in a paper entitled "Transatlantic Lines and Steamships," read by me before the Liverpool Engineering Society in 1878, then in its infancy, but now one of the most important associations in the provinces. Owing to the favourable manner in which that paper was received, I have since continued to keep note of all the leading events and records, and from this material I have endeavoured to produce a handy and simple book of reference for the numbers engaged in the Atlantic service, and also for the thousands of passengers who are ever passing to and fro on the great Ferry.

With a view of rendering the work pleasant and agreeable reading, all harrowing descriptions of losses which have occurred have been purposely omitted; mention of some being made in a few cases where brief reference is unavoidable, but the general particulars of the vessels lost, if required, will be found fully set out in Table No. 7.

Th  
gathe  
period  
perien  
firms  
in the

CEN

The events noted of the earlier periods are almost all gathered from my own scrap-book; those of the later periods have either come directly under my own experience, or are from information kindly given by various firms and gentlemen formerly, and at present, engaged in the trade, to whom I must express my indebtedness.

A. J. M.

CENTRAL BUILDINGS, NORTH JOHN STREET,  
LIVERPOOL, *March*, 1892.

AT

First stea

„ Briti

„ Pass

„ Cun

„ Colli

„ Inma

„ Allar

„ Anch

„ Natio

„ Guio

„ White

„ Amer

„ Ham

„ North

„ Atlan

„ „

„ „

„ „

„ „

„ „

„ „

„ „

„ „

„ „

„ „

„ lit wit

„ lit wit

## ATLANTIC RECORDS AND EVENTS.

First steamer	{ to cross the } Atlantic }	Savannah	DATE	PAGE
" British steamer	"	<b>Royal William</b>	1819	4
" Passenger vessel	"	<b>Second Royal William</b>	1838	5
" Cunard Line	"	<b>Britannia</b>	1840	21
" Collins Line	"	<b>Atlantic</b>	1849	41
" Inman Line	"	<b>City of Glasgow</b>	1850	45
" Allan Line	"	<b>Canadian</b>	1854	64
" Anchor Line	"	<b>Tempest</b>	1856	62
" National Line	"	<b>Louisiana</b>	1863	67
" Guion Line	"	<b>Manhattan</b>	1866	70
" White Star Line	"	<b>Oceanic</b>	1871	77
" American Line	"	<b>Pennsylvania</b>	1873	111
" Hamburg American Line	"	<b>Borussia</b>	1856	121
" North German Line	"	<b>Bremen</b>	1858	124
" Atlantic screw-steamer	"	<b>Great Britain</b>	1845	16
" " iron steamer	"	<b>Great Britain</b>	1845	16
" " iron paddle-steamer	"	<b>Persia</b>	1856	32
" " twin screw-steamer	"	<b>Notting Hill</b>	1881	117
" " compound engines	"	<b>Holland</b>	1869	68
" " compound 3-crank engines	"	<b>Arizona</b>	1879	72
" " triple expansion engines	"	<b>Martello</b>	1884	113
" " express twin screw	"	<b>City of New York</b>	1888	58
" " steel steamer	"	<b>Buenos Ayrean</b>	1879	36
" " midship saloons	"	<b>Oceanic</b>	1871	80
" " steamer lost	"	<b>President</b>	1841	16
" lit with gas	"	<b>Adriatic</b>	1872	91
" lit with electric light	"	<b>City of Berlin</b>	1879	55



		DATE	PAGE
Last wooden vessel built . . . .	Collins' <b>Adriatic</b>	1857	43
„ sailing of Collins' Line . . . .	<b>Baltic</b>	1858	43
„ side-lever engines . . . . .	Cunard <b>Scotia</b>	1862	32
„ paddle-wheel built . . . . .	Cunard <b>Scotia</b>	1862	32
Oldest vessel now in Atlantic trade . .	<b>Palestine,</b> built 1855		113
Longest steamer afloat . . . . .	<b>Teutonic,</b> 580 ft. overall		96
„ „ proposed 1891 . . . . .	<b>New Cunard,</b> 600 ft. overall		281
„ „ ever built . . . . .	<b>Great Eastern,</b> 691 ft. overall		118
Greatest displacement afloat . . . . .	<b>City of Paris,</b> 17,350 tons		58
„ „ ever built . . . . .	<b>Great Eastern,</b> 32,160 tons		118
„ indicated horse-power, paddles . . . . .	<b>Great Eastern,</b> 5,000 tons		118
Greatest indicated horse-power, single screw . . . . .	<b>Etruria,</b> 14,350 tons		38
Greatest indicated horse-power, twin screw . . . . .	<b>City of Paris,</b> 18,500 tons		58
Greatest daily consumption, paddles . . . . .	<b>Scotia,</b> 160 tons		32
Greatest daily consumption, screw . . . . .	<b>Etruria,</b> 320 tons		38
Greatest average speed per hour, paddles . . . . .	<b>Scotia,</b> 14 knots		32
Greatest average speed per hour, single screw . . . . .	<b>Etruria,</b> 18·8 knots		38
Greatest average speed per hour, twin screw . . . . .	<b>Teutonic,</b> 20·3 knots		276
Greatest distance run in one day . .	<b>Teutonic,</b> 517 knots		275

## QUEENSTOWN TO NEW YORK.

		d.	h.	m.
First passage, under 9 days, 1864, Cunard	<b>Scotia</b>	8	13	0
„ „ 8 „ 1872, White Star	<b>Adriatic</b>	7	23	17
„ „ 7 „ 1884, Guion	<b>Oregon</b>	6	9	48
„ „ 6 „ 1889, Inman	<b>City of Paris</b>	5	19	18

## NEW YORK TO QUEENSTOWN.

First passage, under 9 days, 1863, Cunard	<b>Scotia</b>	8	3	0
„ „ 8 „ 1869, Inman	<b>City of Brussels</b>	7	22	3
„ „ 7 „ 1882, Guion	<b>Alaska</b>	6	22	0
„ „ 6 „ 1889, Inman	<b>City of Paris</b>	5	23	38

Fastest

Fastest p

Savan  
Royal  
Sirius  
Liverp  
Great  
Presid

## ATLANTIC RECORDS AND EVENTS.

xi

			d.	h.	m.
857	43	Fastest passage, 1840, Cunard <b>Acadia</b> , Liverpool to New York	11	4	0
858	43	" 1846, Cunard <b>Europa</b> " "	11	3	0
862	32	" 1852, Collins' <b>Baltic</b> " "	9	13	0
862	32	" 1864, Cunard <b>Scotia</b> , Queenstown " "	8	15	45
855	113	" 1872, White Star <b>Adriatic</b> " "	7	23	17
rall	96	" 1876, White Star <b>Britannic</b> " "	7	16	36
rall	281	" 1880, Guion <b>Arizona</b> " "	7	10	47
rall	118	" 1884, Guion <b>Oregon</b> " "	6	9	42
	58	" 1887, Cunard <b>Umbria</b> " "	6	4	42
	118	" 1889, Inman <b>City of Paris</b> " "	5	19	18
		" 1891, White Star <b>Teutonic</b> " "	5	16	31
	118				
	38	Fastest passage, 1841, Cunard <b>Acadia</b> , Halifax to Liverpool	9	21	0
		" 1852, Collins' <b>Atlantic</b> , New York to Liverpool	9	17	15
	58	" 1856, Cunard <b>Persia</b> , New York to Queenstown	9	1	45
		" 1863, Cunard <b>Scotia</b> " "	8	3	0
	32	" 1869, Inman <b>City of Brussels</b> " "	7	22	3
	38	" 1875, Inman <b>City of Berlin</b> " "	7	15	28
		" 1876, White Star <b>Britannic</b> " "	7	12	47
	32	" 1882, Guion <b>Alaska</b> " "	6	22	0
		" 1887, Cunard <b>Etruria</b> " "	6	4	36
	38	" 1889, Inman <b>City of Paris</b> " "	5	22	50
		" 1891, White Star <b>Teutonic</b> " "	5	21	3
	276				
	275				

## NOTED STEAMERS.

	1819 TO 1840.	PAGE
h. m.		
13	<b>Savannah</b> . . . . . First.	4
23	<b>Royal William No. 2</b> . . . . . First British.	5
9	<b>Sirius</b> . . . . . First actual liner.	13
19	<b>Liverpool</b> . . . . . Liverpool liner.	6
	<b>Great Western</b> . . . . . Bristol liner.	15
	<b>President</b> . . . . . Liverpool liner.	16
3		
3		
22		
3		
22		
3		
23		
38		

NOTED STEAMERS—*continued.*

## 1840 TO 1850.

	PAGE
Britannia . . . . .	Cunard liner . . . . . 22
Acadia . . . . .	" . . . . . 21
Great Britain . . . . .	First iron and screw . . . . . 16
America . . . . .	Cunard . . . . . 30
Niagara . . . . .	" . . . . . 30
Asia . . . . .	" . . . . . 30
Africa . . . . .	" . . . . . 30
Adriatic . . . . .	Collins' last wooden . . . . . 43

## 1850 TO 1860.

Arctic . . . . .	Collins' Line . . . . . 42
Pacific . . . . .	" . . . . . 43
Great Eastern . . . . .	Largest ever built . . . . . 118
Arabia . . . . .	Last wooden Cunard . . . . . 30
Persia . . . . .	First iron Cunard . . . . . 32
City of Glasgow . . . . .	First Inman . . . . . 49

## 1860 TO 1870.

Scotia . . . . .	Cunard last paddle-wheel . . . . . 33
China . . . . .	First screw Cunard . . . . . 34
Russia . . . . .	Cunard . . . . . 35
City of Boston . . . . .	Inman . . . . . 50
City of Paris No. 1. . . . .	" . . . . . 50
City of Brussels . . . . .	" . . . . . 51

## 1870 TO 1880.

Oceanic . . . . .	First White Star . . . . . 79
City of Richmond . . . . .	Inman . . . . . 54
City of Berlin . . . . .	" . . . . . 54
Britannic . . . . .	White Star . . . . . 85
Germanic . . . . .	" . . . . . 85
Gallia . . . . .	Cunard . . . . . 35
Arizona . . . . .	Guion . . . . . 72

City  
Ala  
Ore  
Am  
Etru  
City  
City  
Teut  
Maj

NOTED STEAMERS—*continued.*

1880 TO 1890.

PAGE		PAGE
22	<b>City of Rome</b> . . . . .	<b>Inman</b> . . . . . 53
21	<b>Alaska</b> . . . . .	<b>Guion</b> . . . . . 74
16	<b>Oregon</b> . . . . .	<b>Guion, then Cunard</b> . . . . . 75
30	<b>America</b> . . . . .	<b>National</b> . . . . . 69
30	<b>Etruria</b> . . . . .	<b>Cunard</b> . . . . . 39
30	<b>City of New York</b> . . . . .	<b>Inman, third of name</b> . . . . . 58
30	<b>City of Paris</b> . . . . .	<b>Inman, second of name</b> . . . . . 58
43	<b>Teutonic</b> . . . . .	<b>White Star</b> . . . . . 97
	<b>Majestic</b> . . . . .	” . . . . . 97

. 42

. 43

. 118

. 30

. 32

. 49

heel 33

. 34

. 35

. 50

. 50

. 51

. 79

. 54

. 54

. 85

. 85

. 35

. 72

CHAPTER

- I.
  - II.
  - III.
  - IV.
  - V.
  - VI.
  
  - VII.
  - VIII.
  - IX.
  - X.
  - XI.
  - XII.
  
  - XIII.
  - XIV.
  - XV.
  
  - XVI.
- APPEND
- INDEX

## CONTENTS.

CHAPTER	PAGE
I. EARLY ATLANTIC STEAMERS . . . . .	1
II. THE CUNARD AND COLLINS LINES . . . . .	21
III. THE INMAN, ANCHOR, AND ALLAN LINES . . . . .	45
IV. THE GALWAY, NATIONAL, AND GUION LINES . . . . .	66
V. WHITE STAR LINE . . . . .	77
VI. DOMINION, AMERICAN, STATE, WARREN, WILSON, AND BEAVER LINES . . . . .	110
VII. LEYLAND, JOHNSTON, AND LONDON LINES . . . . .	115
VIII. CONTINENTAL LINES . . . . .	121
IX. THE WORKING OF ATLANTIC LINES . . . . .	133
X. AT SEA ON AN ATLANTIC LINER . . . . .	153
XI. MACHINERY OF ATLANTIC LINERS . . . . .	173
XII. THE MEN WHO HAVE MADE AND CONDUCT THE ATLANTIC FERRY . . . . .	202
XIII. EARLIER EVENTS . . . . .	231
XIV. EVENTFUL PASSAGES AND SCENES . . . . .	259
XV. THE MANNING, EXPENSES, AND COST OF ATLANTIC LINERS . . . . .	265
XVI. ATLANTIC RECORDS AND TABLES . . . . .	270
APPENDIX . . . . .	279
INDEX . . . . .	297

## LIST OF ILLUSTRATIONS.

	PAGE
BRITISH QUEEN . . . . .	<i>frontispiece</i>
SAVANNAH . . . . .	4
SIRIUS . . . . .	12
GREAT WESTERN, 1838 . . . . .	15
"    "    1843 . . . . .	17
BRITANNIA, 1840 . . . . .	22
"    SECTION AND DECK PLANS . . . . .	<i>opposite</i> 22
"    IN ICE AT BOSTON, 1844 . . . . .	24
PERSIA AND SCOTIA . . . . .	33
CHINA, DECK PLAN . . . . .	<i>opposite</i> 34
UMBRIA AND ETRURIA, DECK PLAN . . . . .	38
"    "    VIEW . . . . .	39
ATLANTIC AND ARCTIC . . . . .	42
CITY OF GLASGOW . . . . .	49
CITY OF BRUSSELS . . . . .	51
CITY OF ROME . . . . .	53
CITY OF NEW YORK, BULKHEAD ARRANGEMENT . . . . .	56
"    "    VIEW . . . . .	57
"    "    STERN VIEW . . . . .	59
"    "    DECK PLAN . . . . .	<i>opposite</i> 60
CANADIAN, 1854 . . . . .	64
AMERICA . . . . .	69
MANHATTAN . . . . .	71
OREGON . . . . .	75
OCEANIC . . . . .	79
"    AND GERMANIC, DECK PLAN . . . . .	<i>opposite</i> 80
"    ENGINES, SIDE VIEW . . . . .	81
"    "    THWARTSHIP VIEW . . . . .	82
BRITANNIC AND GERMANIC (MODEL) . . . . .	82
GASWORKS FITTED ON CELTIC, 1872 . . . . .	91
STERN OF BRITANNIC WITH LOWERING PROPELLER . . . . .	93
BRITISH KING . . . . .	95

TEU

GRE  
NOR  
ALL

"  
VATE  
FRIE  
BUR  
MAU  
CITY  
ARCT  
ETNA  
CHINA  
MONT

"  
TWO  
THRE  
MART  
STERN  
TEUC

"  
"     "  
SIR SA  
SIR GE  
SIR DA  
MR. R  
MR. E.  
MR. W  
MR. S.  
SIR WI

# LIST OF ILLUSTRATIONS.

xvii

		PAGE
	TEUTONIC AND MAJESTIC . . . . .	97
	" " DECK PLAN . . . . . <i>opposite</i>	98
	" " GRAND STAIRCASE . . . . .	99
	" " GRAND SALOON . . . . .	101
	" " SMOKING SALOON . . . . .	103
	GREAT EASTERN, 1858 . . . . .	119
	NORMANNIA . . . . .	123
	ALLER . . . . .	125
	" ENGINES OF . . . . .	127
	VATERLAND . . . . .	129
	FRIESLAND . . . . .	131
	BURNING OF THE LIVERPOOL LANDING STAGE . . . . .	151
	MAURY'S LANES (ATLANTIC TRACK CHART) . . . . .	155
	CITY OF NEW YORK, SALOON . . . . .	165
	ARCTIC, ENGINES OF . . . . .	174
	ETNA, " . . . . .	176
	CHINA, " . . . . . <i>opposite</i>	176
	MONTANA AND DACOTA, ENGINES OF, SECTION . . . . .	178
	" " " " ELEVATION AND PLAN . . . . .	179
	TWO CRANK COMPOUND ENGINES . . . . .	181
	THREE CRANK TRIPLE ENGINES . . . . .	182
	MARTELLO, ENGINES OF . . . . . <i>opposite</i>	182
	STERN OF SINGLE SCREW STEAMER . . . . .	185
	TEUTONIC AND MAJESTIC, STERN, SHOWING PROPELLERS . . . . .	187
	" " A, VIEW OF TOPS OF ENGINES . . . . .	190
	" B, LINK MOTION . . . . .	191
	" C, STARBOARD ENGINE . . . . .	193
	" THRUST-BLOCK . . . . . <i>opposite</i>	194
	" TUNNEL . . . . .	194
	" REFRIGERATING CHAMBERS . . . . .	198
	" " " " " " . . . . .	198
	" STEERING GEAR . . . . .	198
	SIR SAMUEL CUNARD . . . . .	203
	SIR GEORGE BURNS . . . . .	205
	SIR DAVID MACIVER . . . . .	207
	MR. ROBERT NAPIER . . . . .	208
	MR. E. K. COLLINS . . . . .	209
	MR. WILLIAM INMAN . . . . .	211
	MR. S. B. GUION . . . . .	213
	SIR WILLIAM PEARCE . . . . .	215.



LIST OF ILLUSTRATIONS.

	PAGE
MR. T. H. ISMAY . . . . .	217
MR. J. SPENCE . . . . .	219
SIR E. HARLAND . . . . .	221
MR. J. B. THOMSON . . . . .	223
MR. J. ELDER . . . . .	225
MR. ALEX. C. KIRK . . . . .	227
SOVEREIGN OF THE SEAS, 1853 . . . . .	245
DIAGRAM ILLUSTRATING THE DEVELOPMENT OF ATLANTIC STEAMERS . . . . .	296

Page x,  
 Page 9,  
 Page 40  
 wa  
 Ma  
 of  
 Page 92  
 Page 19  
 Page 27  
 Page 28  
 for  
 of

NOTE  
 Steame  
 scale, c

PAGE  
217  
219  
221  
223  
225  
227  
245  
296

## THE ATLANTIC FERRY.

### ERRATA.

- Page x, line 7, for " 600 feet " read " 620 feet. "
- Page 9, line 11, for " 1,150 feet " read " 1,150 tons. "
- Page 46, substitute for footnote, " The City of Glasgow was afterwards lost in the North Atlantic ; she sailed for Philadelphia March 1, 1854, with 480 souls on board, and was never heard of again. " This should be inserted in Table No. 7, page 287.
- Page 92, footnote, for " £20,000 " read " £200,000. "
- Page 194, Plate D, for " Funnel " read " Tunnel. "
- Page 270, line 11, for " 100 feet per inch " read " 200 feet per inch. "
- Page 291. In the totals of lives lost, for " 6,369 " read " 6,849, " and for " 6,969 " read " 7,449 " (owing to the omission of the City of Glasgow).

NOTE.—The diagram illustrating the development of the Atlantic Steamers from 1840 to 1890 can be had separately, on a larger scale, coloured and neatly mounted for hanging up, price 2s. 6d.

	PAGE
MR. T. H. ISMAY . . . . .	217
MR. J. SPENCE . . . . .	219
SIR E. HARLAND . . . . .	221
MR. J. B. THOMSON . . . . .	223
MR. J. ELDER . . . . .	225
MR. ALEX. C. KIRK . . . . .	227
SOVEREIGN OF THE SEAS, 1853 . . . . .	245
DIAGRAM ILLUSTRATING THE DEVELOPMENT OF ATLANTIC STEAMERS . . . . .	296

STRANGE  
travellers  
fifty year  
their own  
Ball Lin  
in 1816,  
and other  
to New Y  
out recor  
the "Lit  
author's  
ailed fro  
portsmou  
owing th  
independe  
made a p  
sovereign  
which ma

## THE ATLANTIC FERRY.

### CHAPTER I.

#### THE EARLY ATLANTIC STEAMERS.

STRANGE as it may seem to the present generation of travellers, it is nevertheless true, that it is but some fifty years since the sailing clippers had things all their own way upon the Atlantic highway. The Black Ball Line of sailing vessels, founded in New York in 1816, with its vessels the **Pacific**, **New York**, **Canada** and others, boasted an average passage of forty days out to New York, and twenty-three days home to Liverpool; but records are also given in an old English paper called the "Literary Panorama," dated June, 1815, in the author's possession, of a ship named the **Galatea** having sailed from St. John's, Newfoundland, in eleven days to Portsmouth without having made a single tack. Following these are the **Red Jacket**, the **Harvest Queen**, the **Independence** (which, although built so far back as 1834, made a passage to Liverpool in fourteen days), the **Sovereign of the Seas**, and the **Dreadnought**, the latter of which may be termed the last of the famous American

clipper fleet. This vessel, the **Dreadnought**, became very celebrated by having made the passage from New York to Liverpool under fourteen days in 1858, and from New York to Queenstown in nine days seventeen hours. She was long in active service, and was only recently (in 1890) wrecked upon the American coast. Some of these sailing clippers gained great renown in the early days of steam navigation by beating the steamers themselves, notably the clipper **Tornado**, of the Morgan line, which, in 1846, arrived in New York, before the Cunard steamer, which sailed at the same time, arrived in Boston.

Before describing the steamships of the Atlantic trade it will not be out of place to relate briefly the early efforts made to apply steam-power to the propulsion of vessels.

The first attempt to propel vessels by steam is claimed by the Spanish to have been made at Barcelona, by a paddle-wheel vessel, under the direction of Blasco de Garey, in 1543. Papin, in France, about 1707; Jonathan Hulls, in England, in 1736; William Henry, in Pennsylvania, United States, also are mentioned in connection with it; but the first steamer worthy of being so called was that of John Fitch, which he placed for hire upon the Delaware, at Philadelphia, in 1787. This primitive craft was propelled by a system of paddles or oars working vertically, and was the forerunner of the palatial vessels now plying on the great rivers of the United States. Some remarkable statements of John Fitch, as showing how far-seeing he was, deserve mention. It is

stated th  
to finish

"This,  
be the m  
and arm  
praising  
following

"Well,  
time, you  
other me  
After whi  
what a pi

About t  
his boat,  
Miller, Ta

After F  
ame into  
the Huds  
wards, in  
the Clyde  
avigation  
orth stea  
escription

The first  
as made  
his far-se  
e called  
which was  
New York,  
fterwards

ame very  
New York  
from New  
rs. She  
ntly (in  
e of these  
arly days  
rs them-  
gan line,  
e Cunard  
rived in

atic trade  
the early  
oulson of

s claimed  
ona, by a  
Blasco de  
Jonathan  
in Penn-  
onnection  
so called  
hire upon  
primitive  
or oars  
e palatial  
e United  
Fitch, as  
on. It is

stated that, on writing to a friend for the loan of £50 to finish this boat, he stated :

“ This, sir, whether I bring it to perfection or not, will be the mode of crossing the Atlantic, in time, for packets and armed vessels.” And on another occasion, when praising his hobby to two visitors, he made use of the following words :

“ Well, gentlemen, although I shall not live to see the time, you will, when steamboats will be preferred to all other means of conveyance, especially for passengers.” After which, one visitor said to the other, “ Poor fellow ! what a pity he is crazy ! ”

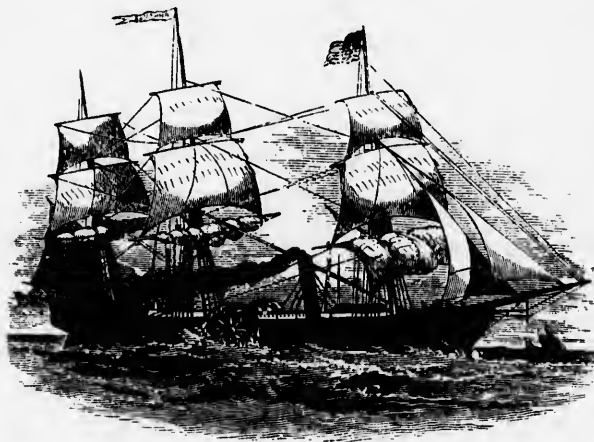
About the same time that Fitch was experimenting with his boat, attempts were also being made in Scotland by Miller, Taylor and Symington.

After Fitch came, in 1807, Robert Fulton, who first came into notice through his steamer, the **Clermont**, on the Hudson, in 1807. This steamer was soon afterwards, in 1812, followed by Bell's **Comet**, the first on the Clyde, from which date it may be said that steam navigation became fairly launched, as from that time north steamships began to be built of all kinds and descriptions.

The first actual attempt at Atlantic steam navigation was made by Colonel John Stevens, of New York, in 1819. This far-seeing gentleman despatched what would now be called an auxiliary steamship named the **Savannah**, which was built by Crocker and Fickett, at Corlears Hook, New York, as an ordinary sailing vessel, but was soon afterwards fitted with engines and boilers, and steamed

from the city of Savannah on the 25th of May, 1819, arriving in Liverpool, after a passage of thirty-five days, on the 29th of June. Steam-power was used eighteen days, the paddle-wheels being so designed that they could be unshipped, so as not to interfere with the sailing qualities. This operation required over half an hour's time to effect.

Her bunker capacity was but limited, as she could



SAVANNAH. 1819. FIRST ATLANTIC STEAMER.

only carry eighty tons of coal, besides a quantity of wood fuel. Notwithstanding her successful trip across the Atlantic, her machinery was afterwards taken out, and she continued to trade for some years as a sailing vessel, until, like so many other famous vessels, she came to an ignominious end, by being wrecked on Long Island in 1822. The engines of the *Savannah* consisted of an inclined direct-acting cylinder, of 40 inches

diameter  
was 20  
alone av

The n  
steamer  
Three Ri

She wa  
deep, of 3  
London  
at Graver  
over forty

In Jun  
from the  
despatch  
ship Com  
pool, by V  
Fawcett,  
side-lever  
ders 48½ i  
wheels we  
ten knots  
steamer t  
to sail fro  
the first t  
iron bulkl  
York, on  
homeward

diameter and 6 feet stroke, and the boiler pressure used was 20 lbs. per square inch. Her speed under steam alone averaged six knots.

The next vessel to cross the Atlantic was a Canadian steamer named the **Royal William**, which was built at Three Rivers, near Quebec, in 1831.

She was 160 feet long, by 44 feet broad, and  $17\frac{3}{4}$  feet deep, of 363 tons burden. The **Royal William** sailed for London from Quebec on August 5th, 1833, and arrived at Gravesend on September 16th following, a passage of over forty days.

In June, 1838, another **Royal William** was chartered from the City of Dublin Steam-packet Company, and despatched from Liverpool by the Transatlantic Steamship Company to New York. She was built at Liverpool, by Wilson. The engines were made by the firm of Fawcett, Preston and Co., of the same place, and were side-levers, of 276 nominal horse-power, having cylinders  $48\frac{1}{2}$  inches diameter and  $5\frac{1}{2}$  feet stroke. The paddle-wheels were 24 feet diameter, and her speed was about ten knots an hour. This was the first real passenger steamer to cross the Atlantic, and also the first steamer to sail from Liverpool (on July 5th, 1838). She was also the first to be divided into watertight compartments by iron bulkheads, of which she had four. When in New York, on the first voyage, she was advertised for the homeward passage in the papers as follows :



“BRITISH STEAMSHIP **Royal William**, 617 tons. Captain Swainson, R.N.R., Commander.

“This fine steamer, having lately arrived, will be dispatched again to Liverpool on Saturday, August 4th, at 4 P.M. She is only sixteen months old, and from her peculiar construction (being divided into five sections, each watertight) she is considered one of the safest boats to England.

“Her accommodations are capacious, and well arranged for comfort. The price of passage is fixed at 140 dols., for which wine and stores of all kinds will be furnished. Letters will be taken at the rate of 25 cents for the single sheet, and in proportion for larger ones, or one dollar per ounce weight. For further particulars apply to Abraham Bell and Co., or Jacob Harvey, 28, Pine Street.”

After making a few passages across the Atlantic, she was returned to her owners, in whose possession she remained as a coal hulk until about four years ago (1888), when she was sold for the sum of £11. Some idea of this vessel's size may be formed from the following table, giving her dimensions as compared with one of the powerful English tugboats of to-day :

**Royal William**, 145 feet by 27 feet broad, and 17½ feet deep, and 817 tons (540 horse-power).

Tugboat, 1890, 212 feet by 30 feet broad, and 15¼ feet deep, and 712 tons (1,000 horse-power).

To take the place of the **Royal William**, the Transatlantic Steamship Company put upon the station the **Liverpool**, a steamer with 10 knots speed. The company was announced by the following advertisement in the “**Liverpool Mercury**,” Oct. 5, 1838 :

“The steam navigation of the States of interest, arranged, Company immediate the power 464 horse and 1,120 Milerest atlantic

“The purpose of the investment being now built burthen Messrs. available

“Share amount

“In its situation will be stalment three mo

“On a be lodge Company the same

“Trust Esq.; J

“Man pool; F.

“Man

Captain

“TRANSATLANTIC STEAMSHIP COMPANY.

“Capital £800,000, in Shares of £100 each.

“The arrangement for establishing an intercourse by steam navigation between the British Isles and the United States of America being finally completed, and an union of interests in Liverpool being now satisfactorily arranged, the Directors of the Transatlantic Steamship Company have to announce that with the view of giving immediate effect to the operations, they have purchased the powerful and splendid steamship, the **Liverpool**, of 464 horse-power, by Messrs. George Forrester and Co., and 1,150 tons burthen, built by Messrs. Humble and Milcrest for Sir John Tobin, and intended for Transatlantic intercourse.

“The Directors have also to state that for the purpose of securing an efficient and permanent establishment between Liverpool and New York, two vessels are now building of 450 horse-power each, and 1,250 tons burthen each, by Messrs. Fawcett, Preston and Co., and Messrs. W. and J. Wilson, and will, it is expected, be available in the course of next year.

“Shares in the first instance will be issued to the amount of but one half the capital above-mentioned.

“In issuing the remaining half, priority of subscription will be given to the then existing proprietors. Instalments to be called for at intervals of not less than three months, and not exceeding £10 per share.

“On allotment of shares a deposit of £5 per share to be lodged to the credit of Trustees with any of the Company’s Bankers who will give necessary receipt for the same.

“*Trustees.*—James Ferrier, Esq.; Richard Williams, Esq.; James Jameson, Esq.

“*Managing Directors.*—C. W. Williams, Esq., Liverpool; F. Carleton, Esq., Dublin.

“*Managing Committee in Liverpool.*—Harold Little-

dale, Esq.; Joseph C. Ewart, Esq.; Thomas Booth, Esq.

“*Bankers.*—Liverpool: The Royal Bank of Liverpool. Dublin: John David Latouche and Co. London: Glyn, Halifax, Mills and Co.

“*Solicitors.*—John North, Esq., Exchange Alley, Liverpool; P. D. Mahony, Trafalgar Square, London, and Dame Street, Dublin; J. C. Shaw, Superintendent of the Marine and Machinery Departments.

“Applications for the unappropriated shares may be made to the Company’s Bankers or Solicitors or at the offices of the Company in Liverpool, Dublin, and London; or to D. and J. B. Neilson, Stock and Share Brokers, Exchange Street East, Liverpool.

“JOHN POLLOCK,

“Agent, 24, Water Street.

“Liverpool, September 15th, 1838.”

As an instance of the great attention paid to the earlier Atlantic steamers, the following account of this notable vessel, condensed from the “Liverpool Mercury” of October 12th, 1838, will be of interest :

#### “The Liverpool Steamship.

“As this vessel is not only the largest steamer hitherto built at this port, but the first that has been fitted up *à priori*, expressly for Transatlantic conveyance, much interest and curiosity have been excited by the appearance of so noble a specimen of the united skill of the naval architect and the engine-builder; and so numerous have been the visitors who have inspected her as the works approach towards completion, that some account of her dimensions and equipments may be acceptable to those of our readers who take an interest in the success already developed, and the high promise presented by the application of steam to the purposes of ocean navigation.

“The year for crest, a pool T branchi enterpr for stea prosper her bea boxes); 1,150 fe

“She the first genius thirty y its wom means c against he woul over wh ful eye.

“Such science, which i wishing British Q dict that gress of these in immedia pected, v about 70

“She indentur paddle-w appear li be safely

“The f

"The **Liverpool**, it is generally known, was built last year for Sir John Tobin by Messrs. Humble and Milcrest, and was purchased some months ago by the Liverpool Transatlantic Steam Company, an association branching out of the Dublin Steam Company, to whose enterprise and exertions for years Liverpool, as a port for steam vessels, is mainly indebted for its growing prosperity. Her length is 235 feet from stem to taffrail; her beam 35 feet (exclusive of the breadth of her paddle-boxes); the depth of hold is 21 feet; and she admeasures 1,150 feet.

"She is considerably longer (we believe 25 feet) than the first-rate man-of-war, and had the mechanical genius in his aspirations imagined and depicted, some thirty years ago, such a floating Leviathan, bearing in its wonderful, and we may add, sublimely powerful means of rapid transit for thousands of miles, even against the adverse winds and the current of the ocean, he would have been set down as a rambling enthusiast, over whose safe keeping his friends should exert a watchful eye.

"Such, however, are the rapid strides of modern science, and such the enterprise and liberality with which it is cherished and encouraged, that without wishing to disparage the high merits of the **Liverpool** or **British Queen** as modern steamships, we venture to predict that in thirty years more vessels will, in the progress of improvement, be produced as much surpassing these in size and power, as they surpass them that have immediately preceded them. The **Liverpool**, it is expected, will carry (independently of 450 tons of coals) about 700 tons of goods.

"She is what is termed 'shipbuilt,' there being no indentures or dimples in her sides for the reception of paddle-wheels, so that were these removed, she would appear like an ordinary sailing ship, and as such, might be safely navigated. . . .

"The fineness of her bottom, her length, and excellence

of her engines, are all favourable to this supposition, and the solution of the problem will in a few days put an end to further vague speculation. Steam being the principal, or almost sole motive power in contemplation, the rigging of the **Liverpool** is very light.

"She has three masts, a foremast like that of a ship, with a top and yards, taut, but light both in spars and rigging, and a mainmast and small mizenmast, each with a plain topmast and cross-trees like a schooner, also very light, and of moderate height, so that the foremast will spread as much sail as both.

"The paddle-boxes are of great size and height; the figure-head and cut-water look well; and her stern, which is decorated with carved work, emblematic of England and America, is extremely neat and appropriate. Some of the standing rigging and chimney-stays are, we learn, partly composed of wire, and are thus stronger than common cordage of a greater thickness, while they present less resistance to the atmosphere.

"The diameter of the paddle-wheels is 29 feet.

"The engines, built by Messrs. Forrester and Co., Vauxhall Foundry, are well worthy of inspection, both in regard to their compactness and beauty in construction, the extraordinary strength, and their superior finish. They are 468 horse-power. The cylinders are each 75 inches diameter, and the stroke of the piston-rod is 7 feet. The propelling force of these machines, (enough to drive the thousands of movements in ten or a dozen of our largest cotton-mills), will be prodigious.

"The iron shaft or spindle that turns the paddle-wheels is equal in girth to a man's body, and but fairly proportioned to the revolutionary force which the cranks will communicate.

"There are two distinct boilers, and two funnels, placed at some distance from each other, and ranging with the masts. The fire-rooms are spacious; the coals are supplied from lateral bunkers, made of plate iron; and large water-taps are at hand in case of danger from fire.

"The  
of 58 f  
end, sh  
it is 8  
them.

"Th  
modiou  
each w  
which  
a part  
the roc  
serving

"Th  
pink, w  
of Fre  
broad  
retiring  
elegant  
fort an

"Th  
water  
ratus fi  
so as t  
the 'cr  
in the  
and the

"The  
4 inche  
dormito  
fitted i  
scarcely  
pannelle  
and sep

She s  
but put  
of Cork  
on Nove

position,  
lays put  
eing the  
nplation,

f a ship,  
ears and  
st, each  
chooner,  
the fore-

ght; the  
er stern,  
matic of  
l appro-  
ey-stays  
are thus  
ickness,  
here.

and Co.,  
on, both  
construc-  
superior  
ders are  
e piston-  
achines,  
ten or a  
gious.

e paddle-  
ut fairly  
e cranks

funnels,  
ranging  
the coals  
ron; and  
rom fire.

"The 'main or after cabin' is a splendid apartment of 58 feet in length, and 28 feet 9 inches in width at one end, slightly narrowing to 22 feet 4 inches at the stern; it is 8 feet in height to the beams, and 8½ feet between them. . . . .

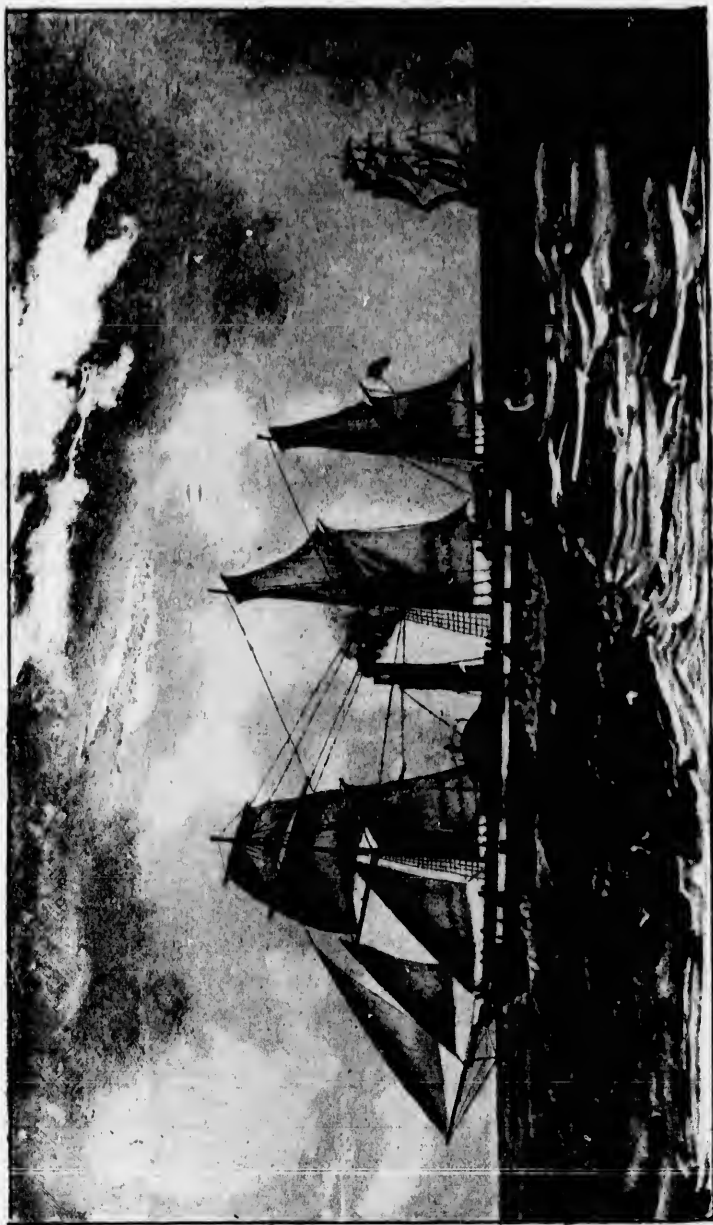
"The state-rooms are exceedingly handsome and commodious. There are in this cabin sixteen in number, each with two berths or beds, with the exception of two, which are each fitted, for the peculiar accommodation of a party, with three beds. They are well lighted from the roofs and sides by patent lights, those in the sides serving also, on being opened, as ventilators.

"The colouring of these rooms is a warm, delicate pink, with gorgeous damask silk hangings to correspond, of French white, with crimson satin stripes. At the broadest or midship end of this main cabin is the ladies' retiring or private room, where several beds are also elegantly fitted up, and every convenience for the comfort and adornment of 'the fair' is provided. . . . .

"There are tanks in abundance, in addition to which water will be daily and hourly distilled by an apparatus fixed for the purpose, and will undergo filtration, so as to be equal in purity and coolness to that of the 'crystal well' of the hermit. It may be added that in the main cabin, including the ladies' state-rooms, and the sofas, no fewer than fifty beds are provided.

"The 'fore cabin' is 45 feet in length, by from 29 feet 4 inches to 23 feet 10 inches in width, and has eight dormitories or state-rooms on each side. This room is fitted in a style somewhat different to the other, but scarcely less beautiful or costly. The walls are empanelled in rosewood and other woods, with rich style, and separated by circular-topped pilasters."

She sailed from Liverpool on the 20th October, 1838, but put back to Queenstown (then called the "Cove of Cork"), on the 30th October, sailing thence again on November 6th, and reaching New York on November



THE GREAT BRITAIN, 1843. THE FIRST STEAMSHIP TO CROSS THE ATLANTIC.

CHAP. I.

23rd.

teen days  
Peninsular  
to the Gulf  
Finisterre

It is, however,  
(178 feet long,  
703 tons),  
the greatest  
little vessel  
engined  
Glasgow,  
having carried  
fitted with  
now in use  
and the ship  
named the  
pany (the  
afterwards  
St. George  
from Queen  
under the  
was after  
Like the  
Christophe  
one only  
mination  
port, owing  
mutinous  
in so small



23rd. She made several voyages which averaged seventeen days out, and fifteen home; and was then sold to the Peninsular and Oriental Company, who changed her name to the **Great Liverpool**. She was afterwards wrecked off Cape Finisterre, on February 24th, 1846, with a loss of two lives.

It is, however, to the plucky little steamship **Sirius** (178 feet long, by  $25\frac{1}{2}$  feet broad, and  $18\frac{1}{4}$  feet deep, of 703 tons) that belongs the real honour of commencing the great Atlantic ferry of to-day. This memorable little vessel was built by Menzies, of Leith, and was engined by Messrs. Wingate and Co., of Whiteinch, near Glasgow. The engines were on the side-lever principle, having cylinders 60 inches diameter and stroke of 6 feet, fitted with a surface condenser exactly similar to those now in use. The paddle-wheels were 24 feet diameter, and the steam pressure 15 lbs. A newly-formed company named the British and American Steam Navigation Company (the leading spirit of which was Mr. John Laird, afterwards M.P. for Birkenhead) chartered her from the St. George's Steam-packet Company, and despatched her from Queenstown for New York on April 5th, 1838, under the command of Lieutenant Roberts, R.N., who was afterwards lost in the ill-fated **President**, in 1841. Like the world-famous voyage of the great discoverer, Christopher Columbus, the first voyage of the **Sirius** was one only carried out to its end by the energy and determination of the commander; as shortly after leaving port, owing to continuous head winds, the crew became mutinous, and declared it was utter madness to proceed in so small a vessel, she being not quite so large as the



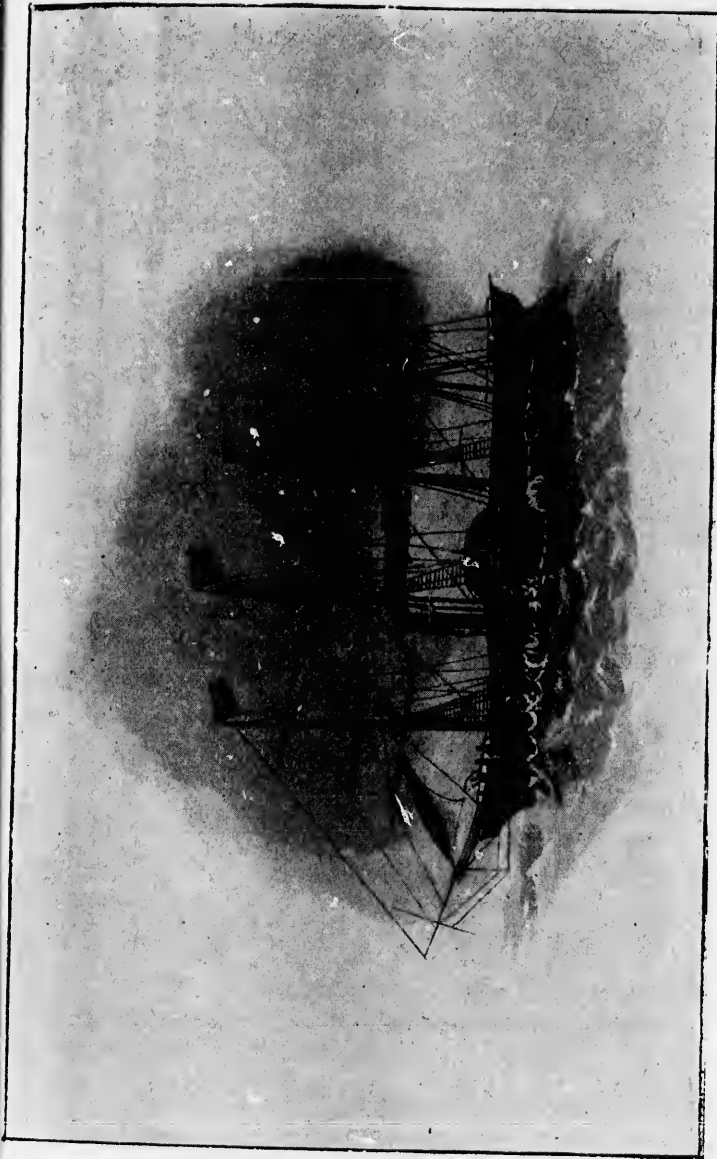
tugboats of to-day. However, thanks to stern discipline and the persuasive arguments of loaded firearms, the gallant little vessel arrived at New York on April 24th, after an eventful passage of  $18\frac{1}{2}$  days, during which she maintained an average speed of  $8\frac{1}{2}$  miles per hour on a consumption of about 24 tons of coal per day.

A few hours after the arrival of the **Sirius**, another steamer, named the **Great Western**, owned by the Great Western Steam Navigation Company, of Bristol, also arrived, having left Bristol on April 8th, 1838, thus making the passage in  $13\frac{1}{2}$  days. This "huge vessel," as she was then styled, was built at Bristol, by Patterson, and launched on July 19th, 1837, her dimensions being 236 feet long, by  $35\frac{1}{3}$  feet broad, by  $23\frac{1}{4}$  feet deep, and 1,340 tons. She was towed to London to have her engines put on board. The engines were built by Maudslay, Sons, and Field; they were of the side-lever type, having two cylinders  $73\frac{1}{2}$  inches diameter, and stroke of 7 feet, indicating 750 horse-power. The paddles were  $28\frac{1}{2}$  feet diameter, and the revolutions about fifteen per minute. Steam was generated in four iron return-flue boilers, carrying 15 lbs. pressure, and the daily consumption was about 33 tons. The average duration of the passages by the **Great Western** between Bristol and New York was 15 days, the fastest being about  $12\frac{1}{2}$  days, and the average speed about  $8\frac{1}{2}$  knots per hour. In 1847 she was sold to the Royal Mail Company for £25,000, and continued in their possession until 1856, when she was broken up.

Another steamer, the **British Queen** (see frontispiece)

[CHAP. I.

ern dis-  
firearms,  
on April  
during  
miles per  
per day.  
another  
the Great  
tol, also  
88, thus  
vessel,"  
atterson,  
as being  
eep, and  
ave her  
uilt by  
ide-lever  
ter, and  
he pad-  
as about  
our iron  
and the  
average  
between  
st being  
3½ knots  
ail Com-  
on until  
ispiece)



THE GREAT WESTERN. 1838.

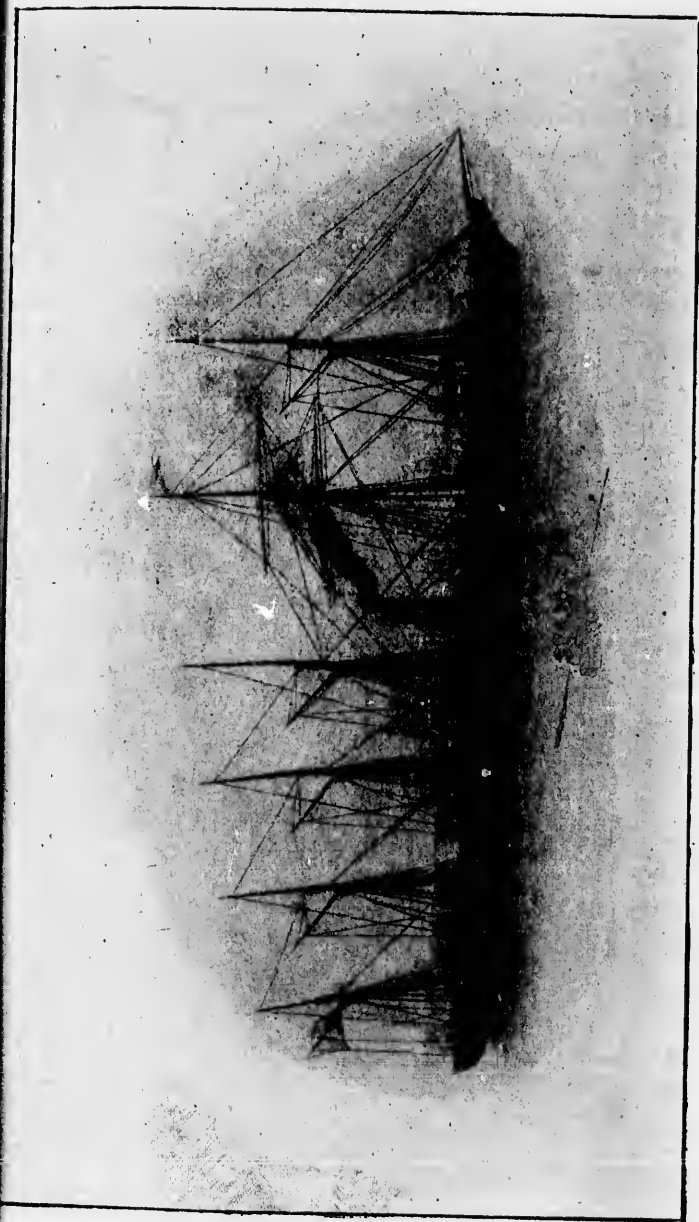
was built by Curling and Young, on the Thames, for the British and American Steam Navigation Company, to trade in conjunction with the **Sirius**, the engines being supplied by Napier, on the Clyde. Her dimensions were 275 feet long,  $37\frac{1}{2}$  feet broad, 27 feet deep, and of 1,863 tons. The engines were of the side-lever type, with cylinders  $71\frac{1}{2}$  inches diameter, and 7 feet stroke, of 700 horse-power, driving paddles 30 feet diameter. She sailed from Portsmouth on her first voyage on July 12th, 1839, and, after trading for some time, was sold to the Belgians in 1841. This was owing to the financial collapse of the company, which misfortune was largely brought about by the loss of the **President**, which first sailed from the Mersey on July 17th, 1840, and, after two or three long and unsuccessful voyages, eventually disappeared, after leaving New York on March 11th, 1841, with what would now be called a few passengers. This ill-fated vessel was also built by Messrs. Curling and Young, with engines built by Messrs. Fawcett and Preston, of Liverpool, having cylinders 81 inches diameter and  $7\frac{1}{2}$  feet stroke.

Having now briefly enumerated the earliest vessels which were produced to create the first Transatlantic lines, it will perhaps be convenient to here notice another of the earlier steamships, the venerable **Great Britain**, still extant. This, the first iron steamer of large size, was 322 feet long, 48 feet broad, and  $31\frac{1}{2}$  feet deep, and of 3,270 tons, and was built at Bristol, by Patterson, for the Great Western Steamship Company, fitted with engines made by them from designs by Guppy. There

[CHAP. I.

s, for the  
pany, to  
es being  
ons were  
of 1,863  
pe, with  
e, of 700  
r. She  
on July  
me, was  
g to the  
tune was  
nt, which  
nd, after  
eventually  
ch 11th,  
ssengers.  
Curling  
cett and  
hes dia-

t vessels  
atlantic  
e notice  
ble **Great**  
of large  
eet deep,  
atterson,  
ted with  
There

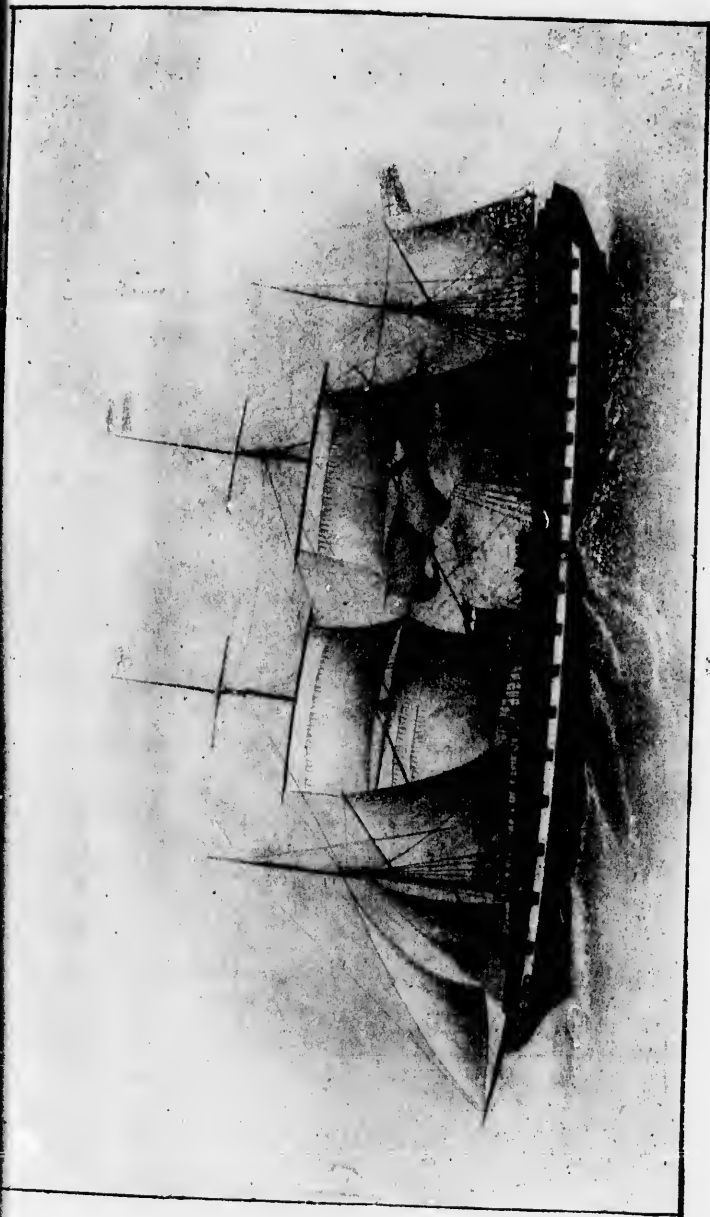


THE GREAT BRITAIN, AS ORIGINALLY RIGGED. 1843.

were four diagonal cylinders, each 80 inches diameter, 72 inches stroke, indicating 1,500 horse-power, and burning 65 tons per day, working upwards on the crank-shaft, from which motion was brought down to the screw-shaft by means of four endless chains. The propeller was six-bladed, of widely different form from that now in use; the pitch was about 25 feet, and the diameter  $15\frac{1}{2}$  feet. Steam at 25 lbs. pressure was generated in three double-ended boilers, fired fore and aft, but without the present system of tubes. Each boiler was 34 feet long, 10 feet wide, and 24 feet high, and had eight furnaces, each 7 feet 6 inches long, by 1 foot 11 inches wide. These engines were, however, found to be very defective, and were replaced after a short time. The career of this wonderful craft has been a varied and chequered one. Launched on July 19th, 1843, she was detained for nearly a year in the dock on account of her beam being too great to allow her to pass out through the dock gates. On July 26th, 1845, she sailed on her first voyage from Liverpool for New York, and continued on that station until September, 1846, when she was stranded on Rathmullin Point, County Down, Ireland, where she remained intact for a whole winter, thus early proving the great strength of iron vessels. In 1853 she was entirely refitted with new masts and engines, and placed upon the Liverpool and Australian trade, in which she was fairly successful until 1874, when she was withdrawn. In 1882 she again underwent a complete change, being altered to a full-rigged sailing vessel, as which she only ploughed the waters of the sea for a

[CHAP. I.

diameter,  
power, and  
the crank-  
the screw-  
propeller  
that now  
diameter  
erated in  
but with-  
er was 34  
had eight  
11 inches  
o be very  
me. The  
aried and  
3, she was  
unt of her  
t through  
ed on her  
continued  
n she was  
, Ireland,  
thus early  
n 1853 she  
gines, and  
trade, in  
when she  
nt a com-  
ing vessel,  
e sea for a



THE GREAT BRITAIN *as altered*. 1853.

brief period, having put into the Falkland Islands leaking, and having been condemned, has remained there ever since as a hulk.

In concluding this early history it only remains to just notice the oft-quoted saying of Dr. Lardner,<sup>1</sup> and we come to the foundation of the great regular lines which to-day bridge the wild and tempestuous Atlantic with swift, silent messengers of peace and plenty.

<sup>1</sup> This noted saying has been constantly referred to, owing to its showing in a remarkable manner the great strides made in steam navigation. It was only in the year 1838 that, at a scientific meeting held in the Royal Institution, Liverpool, Dr. Lardner, a leading scientist of that day, after giving some statistics which he thought proved the difficulty to be insurmountable, stated "that, as to the project which was announced in the newspapers of making the voyage directly from New York to Liverpool, it was, he had no hesitation in saying, perfectly chimerical, and they might as well talk of making a voyage from New York to the moon."

THE found  
should ra  
ceptional  
conceived  
and hono  
Samuel (a  
gentleman  
was of Ca  
advantage  
for regula  
and togeth  
existing in  
gow, and  
an agreem  
the earlier  
commence  
vice, from  
subsidy of  
four stean  
1840), Aca  
by Robert  
each being  
deep, and c  
ever type,



nds leak-  
ed there

mains to  
ner,<sup>1</sup> and  
lar lines

Atlantic  
ty.

o, owing to  
s made in  
at a scien-  
Dr. Lard-  
e statistics  
mountable,  
the news-  
Liverpool,  
erical, and  
w York to

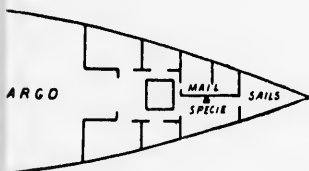
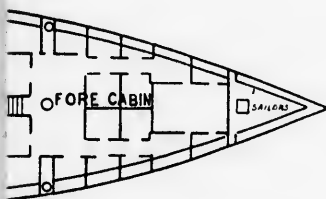
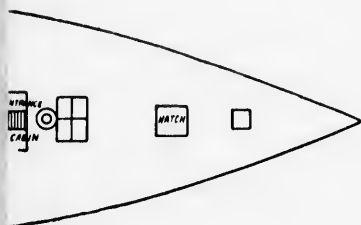
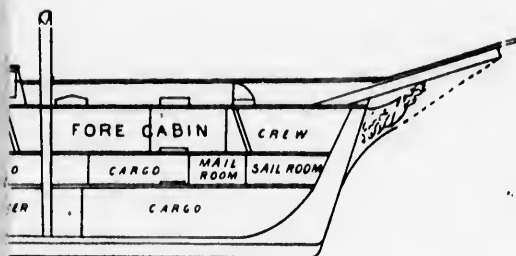
## CHAPTER II.

### THE CUNARD AND COLLINS LINES.

THE foundation of the modern transatlantic lines—which should rank as one of the great stepping-stones of an exceptionally eventful age—had but a modest origin. It was conceived by a gentleman bearing a name now well known and honoured wherever a steamship floats, namely, Mr. Samuel (afterwards Sir Samuel) Cunard. This famous gentleman, whose likeness is to be found on a later page, was of Canadian birth and origin. Early perceiving the advantages possessed by steamers over sailing vessels for regularity, Mr. Cunard came to England in 1839, and together with two of the ablest shipping men then existing in Great Britain, Mr. George Burns, of Glasgow, and Mr. David McIver, of Liverpool, entered into an agreement with the British Government (owing to the earlier vessels already noted being withdrawn) to commence a monthly Transatlantic mail steamship service, from Liverpool to Halifax and Boston, for an annual subsidy of £60,000 per annum. To carry on this trade four steamers, the *Britannia* (launched February 5th, 1840), *Acadia*, *Columbia*, and *Caledonia*, were built of wood by Robert Duncan and Co. and others, at Port Glasgow, each being 207 feet long, by 34½ feet broad, and 22½ feet deep, and of 1,156 tons. The engines were of the side-lever type, having two cylinders, each 72 inches diameter

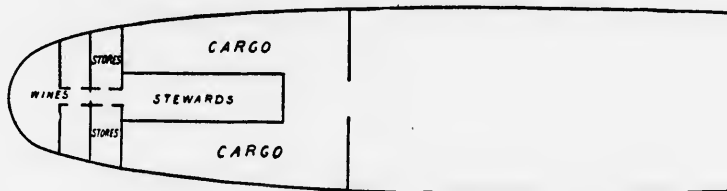
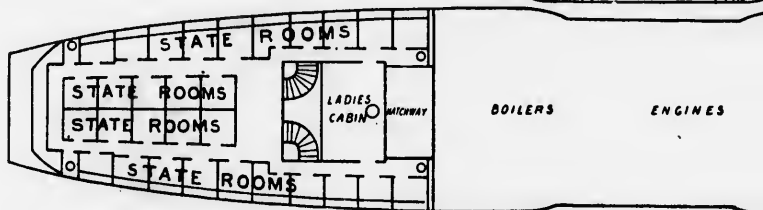
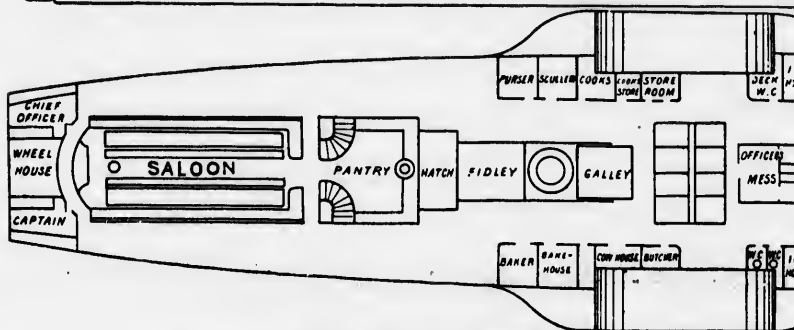
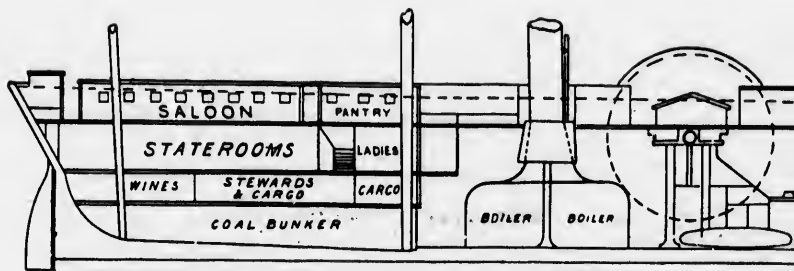




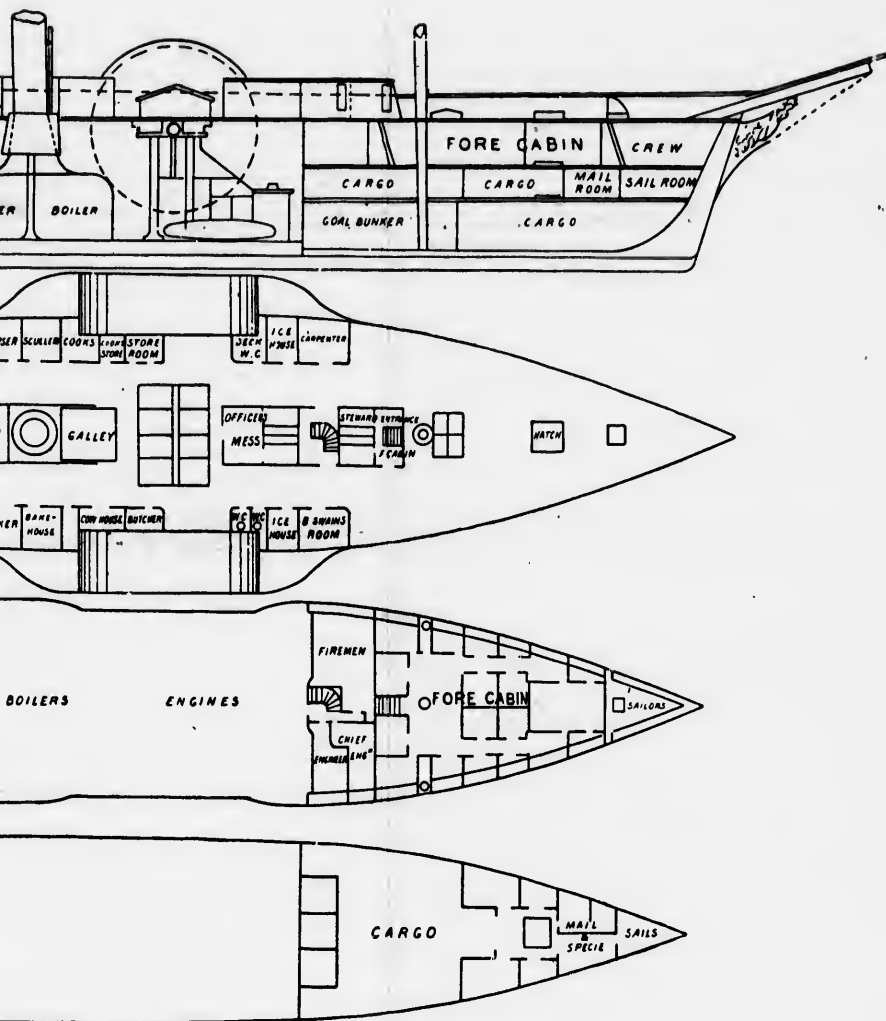


RD STEAMER).

Face page 22.



SECTION AND DECK-PLAN OF THE BRITAN



DECK-PLAN OF THE BRITANNIA (CUNARD STEAMER).

and 82 inches  
horse-power, and  
gave an average  
were of the ret  
furnaces worki  
sumption of ab  
whole of the m  
Robert Napier,  
famous in the  
mencement of  
advertisement  
1840:

“British and  
of 1,200 tons an

“Appointed  
ing at Halifax  
mails:

- Britann
- Acadia.
- Caledon
- Columb

“The **Britann**  
July; the **Acadia**

“Passage, incl  
guineas; to Bost

“The steamsh  
Quebec, in conn

the mails and pa

“For passage  
J. B. Foord, 52

Liverpool to D. a

“The **Britann**  
morning (Friday)  
should be sent o

and 82 inches stroke, working up to about 740 indicated horse-power, and driving-paddles  $28\frac{1}{2}$  feet diameter, which gave an average speed of 9 knots per hour. The boilers were of the return-flue type, four in number, with twelve furnaces working at 20 lbs. pressure, and having a consumption of about 38 tons per twenty-four hours. The whole of the machinery was made and fitted by Mr. Robert Napier, a name destined afterwards to become famous in the maritime engineering world. The commencement of this line was announced by the following advertisement in the "Liverpool Mercury," July 3rd, 1840:

"British and North American Royal Mail Steamships of 1,200 tons and 440 horse-power each.

"Appointed by the Admiralty to sail for Boston, calling at Halifax to land passengers and her Majesty's mails:

**Britannia**, Captain Woodruff.

**Acadia**, Captain Edward C. Miller.

**Caledonia**, Captain Richard Cleland.

**Columba**.

"The **Britannia** will sail from Liverpool on the 4th July; the **Acadia** on the 4th August.

"Passage, including provisions and wine, to Halifax, 34 guineas; to Boston, 38 guineas. Steward's fee, 1 guinea.

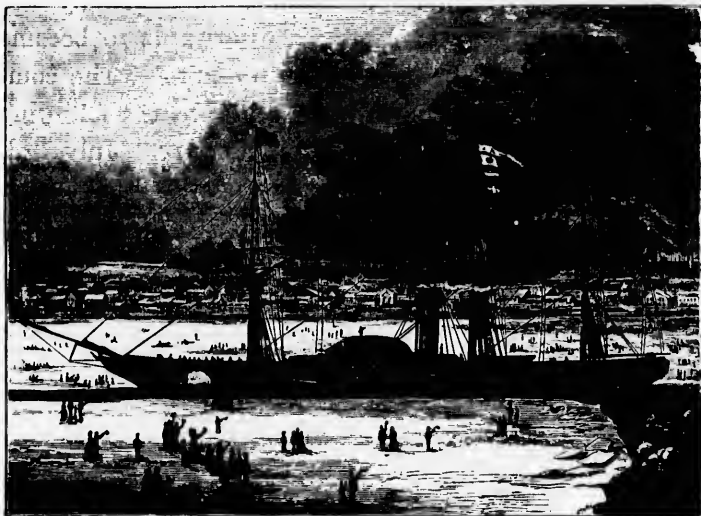
"The steamship **Unicorn** plies between Pictou and Quebec, in connection with the above vessels, carrying the mails and passengers.

"For passage, apply to G. and J. Burns, Glasgow; J. B. Foord, 52, Old Broad Street, London; or in Liverpool to D. and C. MacIver, 12, Water Street.

"The **Britannia** goes out of the Coburg Dock this morning (Friday), the 3rd inst., and all heavy luggage should be sent on board before that time. To-morrow

(Saturday morning) at ten o'clock, a steamer will be at the Egremont Slip, south end of Prince's Dock, to take off the passengers."

The great importance of these early mail steamers is clearly shown by the successful attempts made by the people of Boston to release her from the ice which is de-



BRITANNIA IN ICE AT BOSTON, 1844.

scribed in the following extract from the "Liverpool Albion." The illustration is taken from an old print issued by the people of Boston to commemorate the event.

"*Release of the Britannia from the Ice at Boston.*—Looking into the windows of a print-shop, I saw an engraving of our good ship the **Britannia**, which we had just quitted, represented as in the act of forcing her way through the

ice of Boston. The scene is an Arctic scene, and the ship is seen at New York, where she was enjoyed by the regular steamer. I am that, I would never print, as it is a monument should the sea never freeze. I had heard of an adventure which appears to me as had not which caused the death of Boston, and the ocean. More than five miles or five miles whole body to that amount standing the ice unbroken, and the continuation have been on February 1st, when it was found to be and 2 feet thick that waggons and freights from ships were taken understood to the spirit of the money instantly miles long and began the opening 7 inches deep then sawed to the diameter. V

ice of Boston harbour in the winter of 1844, a truly Arctic scene. A fellow-passenger, a merchant from New York, where they are jealous of the monopoly hitherto enjoyed by their New England rival, of a direct and regular steam communication with Europe, remarked to me that, if the people of Boston had been wise, they would never have encouraged the publication of this print, as it was a clear proof that the British Government should rather have selected New York, where the sea never freezes, as the fittest port for the mail-packets. I had heard much during the voyage of this strange adventure of the **Britannia** in the ice. Last winter it appears there had been a frost of unusual intensity, such as had not been known for more than half a century, which caused the sea to be frozen over in the harbour of Boston, although the water is as salt there as in mid-ocean. Moreover, the tide runs there at the rate of four or five miles an hour, rising twelve feet, and causing the whole body of the ice to be uplifted and let down again to that amount twice every twenty-four hours. Notwithstanding this movement, the surface remained even and unbroken, except along the shore, where it cracked. Had the continuance of this frost been anticipated, it would have been easy to keep open a passage; but on February 1st, when the **Britannia** was appointed to sail, it was found that the ice was 7 feet thick in the wharf, and 2 feet thick for a distance of seven miles out; so that waggons and carts were conveying cotton and other freights from the shore to the edge of the ice, where ships were taking in their cargoes. No sooner was it understood that the mail was imprisoned, than the public spirit of the whole city was roused, and a large sum of money instantly subscribed for cutting a canal, seven miles long and 100 feet wide, through the ice. They began the operation by making two straight furrows, 7 inches deep, with an ice-plough drawn by horse, and then sawed the ice into square sheets, each 100 feet in diameter. When these were detached, they were made



to slide, by means of iron hooks and ropes fixed to them, under the great body of the ice, one edge being first depressed, and the ropes being pulled by a team of horses, and occasionally by a body of fifty men. On February 3rd, only two days after her time, the steamer sailed out, breaking through a newly-formed sheet of ice, 2 inches thick, her bows being fortified with iron to protect her copper sheathing. She burst through the ice at the rate of seven miles an hour without much damage to her paddles; but before she was in clear water all her guard of iron had been torn off. An eye-witness to the scene told me that tents had been pitched on the ice, then covered by a slight fall of snow, and a concourse of people followed and cheered for the first mile, some in sleighs, others in sailing-boats fitted up with long blades of iron, like skates, by means of which they are urged rapidly along by their sails, not only before the wind, but even with a side wind, tacking and beating to windward as if they were in the water. The *Britannia*, released from her bonds, reached Liverpool in fifteen days, so that no alarm had been occasioned by the delay; and when the British Post Office department offered to defray the expense of the ice-channel, the citizens of Boston declined to be re-imbursed."—LEYELL'S *Second Visit to the United States*.

The following notices from the "Liverpool Albion," Feb. 18th, 1850, will also serve to show the great interest taken in the Cunard vessels, and also the duration of passages then prevailing:

"*The Halifax Steam Squadron*.—As the British and North American Royal Mail Company's magnificent fleet stands pre eminent among ocean steamers, the following tabular statements of their performances for the past year (1849) will be found interesting. The first shows the time taken by each vessel on her *homeward* passage, including the deviation to, and detention at, Halifax:

Europa
America
Canada
Niagara
Europa
America
Canada
Niagara
Europa
Cambria
America
Hibernia
Canada
Niagara
Caledonia
Niagara
Europa
Cambria
America
Hibernia <sup>1</sup>
Canada
Caledonia
Niagara
Europa
Hibernia <sup>2</sup>
Cambria
America
Canada
Caledonia
Niagara <sup>3</sup>
Europa
Hibernia
Cambria
America
Caledonia
Canada
Europa
Hibernia

<sup>1</sup> S<sup>2</sup> D<sup>3</sup> H

Names.	Port.	Sailed.	Arrived.	Time.	
				Days.	Hours.
Europa . . .	New York	Jan. 10	Jan. 22	11	18
America . . .	Boston	" 24	Feb. 4	11	3
Canada . . .	New York	Feb. 7	" 19	12	4
Niagara . . .	Boston	" 21	March 6	13	0
Europa . . .	New York	March 7	" 20	12	16
America . . .	Boston	" 21	April 3	12	7
Canada . . .	New York	April 4	" 19	14	12
Niagara . . .	Boston	" 18	" 30	11	12
Europa . . .	New York	May 2	May 14	12	3
Cambria . . .	Boston	" 9	" 24	12	7
America . . .	New York	" 16	" 28	11	12
Hibernia . . .	Boston	" 23	June 4	12	6
Canada . . .	New York	" 30	" 12	12	10
Caledonia . . .	Boston	June 6	" 18	11	19
Niagara . . .	New York	" 13	" 25	11	9
Europa . . .	Boston	" 20	July 1	10	14
Cambria . . .	New York	" 27	" 10	13	0
America . . .	Boston	July 4	" 15	11	0
Hibernia . . .	New York	" 11	" 24	12	10
Canada . . .	Boston	" 18	" 28	9	22
Niagara . . .	New York	" 25	Aug. 6	12	4
Caledonia . . .	Boston	Aug. 1	" 14	12	18
Europa . . .	New York	" 8	" 20	11	17
Cambria . . .	Boston	" 15	" 26	11	2
America . . .	New York	" 22	Sept. 3	11	10
Hibernia <sup>1</sup> . . .	Boston	" 29	—	—	—
Canada . . .	New York	Sept. 5	Sept. 17	12	0
Caledonia . . .	Boston	" 12	" 25	12	18
Niagara . . .	New York	" 19	Oct. 2	13	6
Europa . . .	Boston	" 26	" 7	10	8
Hibernia <sup>2</sup> . . .	New York	" 29	" 13	14	0
Cambria . . .	New York	Oct. 3	" 18	14	11
America . . .	Boston	" 10	" 21	11	6
Canada . . .	New York	" 17	" 28	11	0
Caledonia . . .	Boston	" 24	Nov. 6	12	9
Niagara <sup>3</sup> . . .	New York	" 31	" 13	12	17
Europa . . .	Boston	Nov. 7	" 18	11	12
Hibernia . . .	New York	" 14	" 28	13	16
Cambria . . .	Boston	" 21	Dec. 3	11	14
America . . .	New York	" 28	" 12	13	16
Caledonia . . .	Boston	Dec. 5	" 19	12	18
Canada . . .	New York	" 12	" 24	11	22
Europa . . .	Boston	" 19	" 30	11	3
Hibernia . . .	New York	" 26	Jan. 8	13	8

<sup>1</sup> Struck off Halifax and returned to New York.

<sup>2</sup> Did not call at Halifax.

<sup>3</sup> Had only one engine working.

"We extract from a New York contemporary the following table of the *outward* voyages of British mail steamships during the past year :

"Annexed is a table, exhibiting the date of arrival, length of passage, number of passengers, with the day of departure, etc., of each steamer between New York and Liverpool during the past year ; also one showing the time of arrival, passengers, etc., at Boston during the same period :

Names.	Arrival.	Pas- sage.	Passengers from		Day of Departure	Passengers to	
			Liver- pool.	Hali- fax.		Liver- pool.	Hali- fax.
Canada .	Jan. 29	16	50	7	Feb. 7	38	10
Europa .	Feb. 24	13 $\frac{3}{4}$	86	—	Mar. 7	71	3
Canada .	Mar. 25	14 $\frac{1}{2}$	88	20	April 4	138	5
Europa .	April 19	12 $\frac{1}{2}$	82	7	May 2	129	—
America .	May 5	14 $\frac{1}{2}$	71	4	" 16	118	11
Canada .	" 17	11 $\frac{1}{2}$	71	3	" 31	139	6
Niagara .	June 2	13 $\frac{1}{2}$	65	5	June 13	115	11
Cambria .	" 15	13 $\frac{1}{2}$	61	3	" 27	94	—
Hibernia .	" 29	13 $\frac{1}{2}$	95	2	July 11	63	10
Niagara .	July 14	14	83	—	" 25	92	12
Europa .	" 27	12 $\frac{3}{4}$	123	—	Aug. 8	87	6
America .	Aug. 9	12	92	8	" 22	94	3
Canada .	" 25	13 $\frac{1}{2}$	125	3	Sept. 5	84	7
Niagara .	Sept. 7	13	127	8	" 19	48	—
Cambria .	" 22	13 $\frac{3}{4}$	71	11	Oct. 3	51	5
Canada .	Oct. 4	12	72	1	" 17	72	4
Niagara .	" 19	13 $\frac{1}{2}$	148	—	" 31	14	5
Hibernia .	Nov. 5	16	85	6	Nov. 14	48	9
America .	" 18	14	84	3	" 23	76	3
Canada .	Dec. 1	13 $\frac{1}{2}$	46	13	Dec. 12	78	2
Hibernia .	" 13	17	69	6	" 26	36	5

"The average passages to this port from Liverpool were made in 13 days and 16 hours.

"The following table exhibits the time of arrival, etc., at Boston :

Names.

America  
Niagara  
America  
Niagara  
Cambria  
Hibernia  
Caledonia  
Europa  
America  
Canada  
Caledonia  
Cambria  
Hibernia  
Caledonia  
Europa  
Cambria  
Caledonia  
Europa  
Cambria :

"The  
days and

"The  
and the H  
made the s

The act

line took

first sailed

carrying t

port on th

8 hours, in

<sup>1</sup> The Hib

Halifax and l

for repairs, a

with nineteen

the follow-  
l steam-

arrival,  
the day  
New York  
showing  
during

Passengers  
to  
Halifax.

10  
3  
5  
—  
11  
6  
11  
—  
10  
12  
6  
3  
7  
—  
5  
4  
5  
9  
3  
2  
5

Liverpool  
al, etc.,

Names.	Arrival.	Passage.	Passengers from		Day of Departure.	Passengers to	
			Liverpool.	Halifax.		Liverpool.	Halifax.
America .	Jan. 12	13	53	7	Jan. 24	49	2
Niagara .	Feb. 11	15	50	7	Feb. 21	54	8
America .	Mar. 9	13	80	17	Mar. 21	88	14
Niagara .	April 7	14	43	24	April 18	110	11
Cambria .	" 27	13	41	10	May 9	77	12
Hibernia .	May 12	13½	52	12	" 23	35	3
Caledonia	" 26	13½	38	6	June 6	44	5
Europa .	June 7	11½	53	—	" 20	105	7
America .	" 21	10¾	57	8	July 4	83	5
Canada .	July 4	11¼	84	10	" 18	126	12
Caledonia	" 20	13¼	45	—	Aug. 1	38	9
Cambria .	Aug. 3	13	57	6	" 15	28	4
Hibernia <sup>1</sup>	" 16	11½	68	4	" 29	26	19
Caledonia	" 31	13	65	18	Sept. 12	18	4
Europa .	Sept. 12	10¾	114	18	" 26	50	8
America .	" 27	11¾	83	6	Oct. 10	84	10
Caledonia	Oct. 12	12½	83	13	" 24	17	16
Europa .	" 25	12½	123	15	Nov. 7	76	7
Cambria .	Nov. 10	13¼	86	5	" 21	38	3
Caledonia	" 24	14½	14	6	Dec. 5	20	5
Europa .	Dec. 9	14¾	52	4	" 19	16	7
Cambria .	" 29	14½	82	—	Jan. 9	—	—

“The average passage to Boston from Liverpool is 12 days and 22 hours.

“The **Canada** made the shortest passage to this port, and the **Hibernia** the longest. The **America** and **Europa** made the shortest to Boston, and the **Niagara** the longest.”

The actual commencement of this now justly-famed line took place on July 4th, 1840, when the **Britannia** first sailed from the Mersey for Halifax and Boston, carrying the British mail, and arrived at the latter port on the 19th, having made the passage in 14 days 8 hours, including a stop of several hours at Halifax.

<sup>1</sup> The **Hibernia** on this trip sprung a leak, and returned to Halifax and left her passengers and mails; then came to New York for repairs, and sailed on the 29th September for Liverpool direct, with nineteen passengers.

Since this event to the present time the regular sailings of the steamers of this line have been kept up without interruption, though special efforts have sometimes been required. As the gradual expansion of the trade took place other steamers were built and put upon the station; namely, in 1848 the **America**, **Niagara**, **Canada**, and **Europa**; in 1850 the **Asia** and **Africa**, with 1,000 indicated horse-power, burning 76 tons per day, and steaming  $12\frac{1}{4}$  knots per hour. Each was built of wood, of improved designs, as experience pointed out, but with no radical departures from the **Britannia** until the year 1856, when the **Persia**, the first iron steamer, owned by this line was put upon the station to maintain the supremacy which was now being contested by other lines.

Another extract is worth printing as showing the financial working of steam shipping forty years ago.

*“The British and North American Royal Mail Company.—*The following particulars respecting the Cunard steam fleet will be found interesting, as showing how the company maintained the service in 1850:—**Arabia**, building, 950 horse-power and 2,500 tons (lately sold to the West India Royal Mail Company); **Persia**, building, 950 horse-power and 2,500 tons; **Asia**, 800 horse-power and 2,226 tons; **Africa**, 800 horse-power and 2,226 tons; **America**, 650 horse-power and 1,826 tons; **Canada**, 650 horse-power and 1,831 tons; **Europa**, 650 horse-power and 1,834 tons; **Niagara**, 650 horse-power and 1,824 tons; **Cambria**, 1,423 tons. But, besides these, there are some subsidiary lines which require to be mentioned. Thus, there are two steamers, the **Admiral**, of 929 tons and 388 horse-power, and the **Commodore**, of 800 tons and 350 horse-power, which maintain a communication between Liverpool and Havre; and two vessels, the

CHAP. II.]  
**Camilla**, of 548 tons a  
 munication  
**garet**, also,  
 the **Laurel**,  
 sometimes  
 commonly,  
 Mediterranean  
 Glasgow.  
 tained by a  
 horse for th  
 and subsidi  
 receives fro  
 rate of nea  
 whole fleet  
 official or a  
 the financi  
 proprietors  
 capitalists,  
 ings, the re  
 mate the a  
 ships be ta  
 power. Th  
 capital of £  
 ture, plate,  
 stations, etc  
 municate, th  
 amount just  
 short of £1,  
 pany, after  
 have a balan  
 enjoy any ne  
 experience o  
 mercial comp  
 working a lin  
 to the accou  
 fund, insuran  
 capital involv

**Camilla**, of 529 tons and 220 horse-power, and the **Lyra**, 543 tons and 275 horse-power, which maintain a communication between Liverpool and Glasgow. The **Margaret**, also, a vessel of 700 tons and 310 horse-power, and the **Laurel**, a vessel of 428 tons and 180 horse-power, are sometimes employed upon these subsidiary lines, though, commonly, the **Margaret** plies between Liverpool and the Mediterranean, and the **Laurel** plies between Belfast and Glasgow. Thus this great enterprise was (1851) maintained by a fleet of steamers, the power of which is 6,100 horse for the main line, and 1,723 horse for the feeding and subsidiary lines. The subsidy which the enterprise receives from the British Government is, therefore, at the rate of nearly £24 per annum per horse-power upon the whole fleet, feeders and subsidiary lines inclusive. No official or authorized statement has been published of the financial condition of the Cunard Company. Its proprietors are limited in number, and generally to large capitalists, who arrange their interests in private meetings, the results of which are not made public. To estimate the amount of the capital, let the value of the ships be taken, in round numbers at £120 per horse-power. Thus, for 7,823 horse-power, we should have a capital of £936,760. To this must be added the furniture, plate, etc., of the ships, the offices, warehouses, stations, etc., at the several ports with which they communicate, the capital engrossed by which, added to the amount just stated, will make a total which cannot fall short of £1,500,000. It follows, therefore, that this company, after having defrayed its current expenses, must have a balance of about £375,000 before it can begin to enjoy any net profit; for it has resulted from the general experience of England, both by Government and commercial companies, that besides the current expenses of working a line of steamers, it is necessary to carry yearly to the account of the capital, to cover interest, sinking fund, insurance, etc., a sum equal to 25 per cent. of the total capital involved."—*Liverpool Albion*, February 2, 1852.

The **Persia**, like her later sister the **Scotia**, which came out in 1862, was 380 feet long, by 45 feet broad, and 31 feet deep, of 3,870 tons, and was built and engined by Mr. Robert Napier and Sons, Glasgow. The engines were on the "side-lever" principle so often mentioned, having two cylinders each 100 inches diameter and 12 feet stroke, and indicated 4,000 horse-power. The paddle-wheels were 40 feet diameter; the boilers were eight in number, having forty furnaces, the steam-pressure carried being 20 lbs., and the consumption of coal reached 160 tons per day to propel the ship at a speed of  $13\frac{1}{2}$  knots.

No efforts were spared to render these the crack boats in the service, and with very satisfactory results, as the rates of passage-money were raised for these boats, and a sort of express service for passengers was now practically first introduced across the Atlantic.

Owing to the superiority of the screw-propeller being by this time admitted, these two noble vessels proved to be the last of the ocean-going paddle-wheel vessels, and both were sold; the **Scotia** being afterwards converted into a twin-screw telegraph-ship, in which capacity she still exists under her original name.

Concerning the invention of the screw-propeller, this, like most other matters connected with early engineering, is much disputed, the credit being claimed for Mr. Edward Shorter, of Southwark, who is reported to have taken out a patent for it, and tried it in 1802 on H.M.S. **Doncaster**, working it by means of an ordinary capstan with gearing; other names mentioned as the inventors

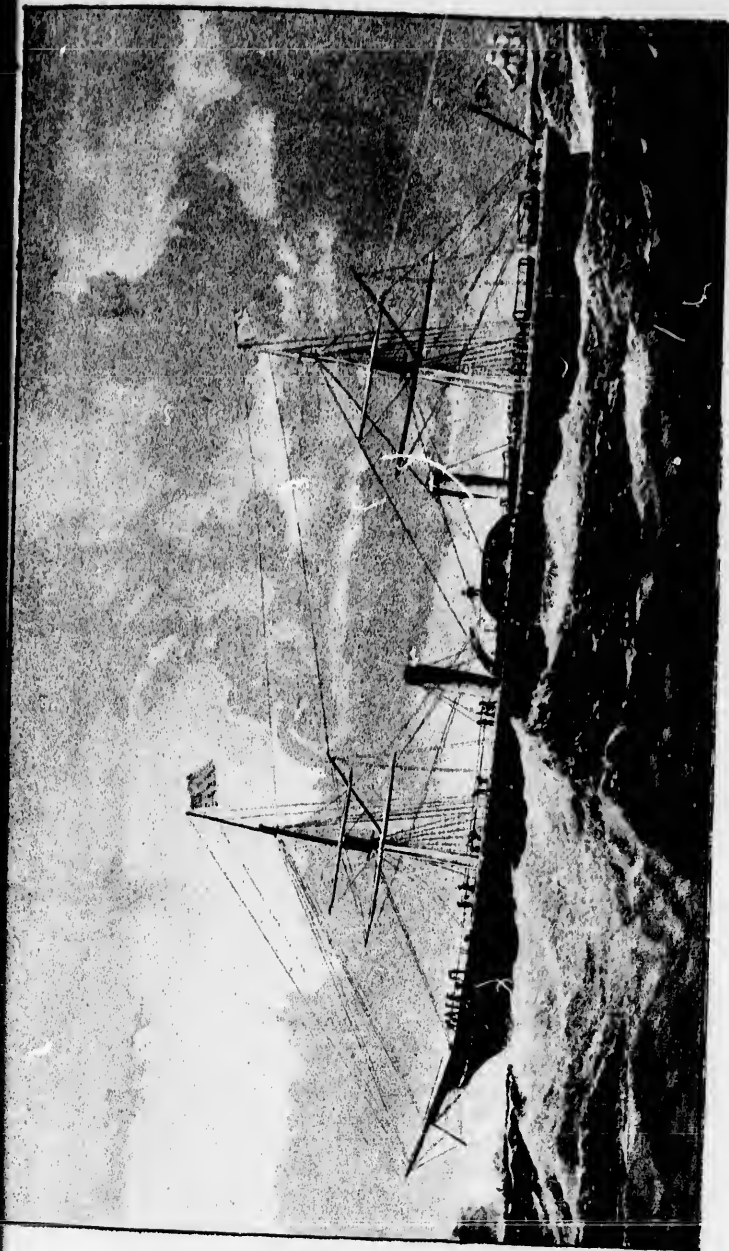


, which  
t broad,  
uilt and  
w. The  
so often  
hes dia-  
0 horse-  
ter; the  
aces, the  
onsump-  
the ship

ack boats  
s, as the  
boats, and  
w practi-

ler being  
proved to  
sels, and  
onverted  
acity she

ler, this,  
engineer-  
l for Mr.  
to have  
n H.M.S.  
capstan  
nventors



THE CUNARD STEAM-SHIPS PERSIA (1856) AND SCOTIA (1862) THE LAST PADDLE-WHEEL ATLANTIC STEAMERS.



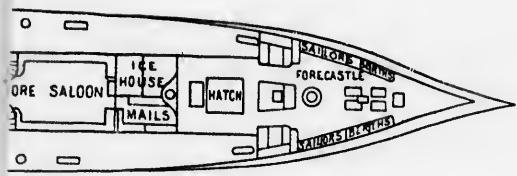
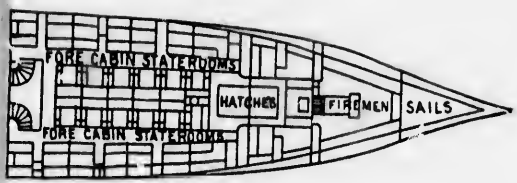
are Robert Hooke, David Bushnell, and Frederic Sauvage, a Frenchman ; but to Mr. F. P. Smith must be given the credit of first having made it successful. Having obtained his patent in 1836, he had it tried on a small vessel named the **Archimedes**, which was built by Henry Wimshurst, who also claims to have had a share in working out the screw-propeller. This little vessel was first tried on the Thames in 1839, and obtained a speed of  $8\frac{1}{2}$  miles. Afterwards it was improved upon by Mr. Bennet Woodcroft and Mr. Robert Griffiths, the latter being the introducer of the form now in general use.

The first "screw" steamer brought out by the Cunard company for their Transatlantic service was the **China**, which was put on the station in 1862, her dimensions being 326 feet long, by  $40\frac{1}{2}$  broad, and  $27\frac{1}{2}$  deep. She was built by Messrs. Napier and Sons at Glasgow, as were the engines, which were surface-condensing, and of a type then in vogue ; these consisted of two oscillating cylinders (each  $80\frac{1}{4}$  inches diameter, and 5 feet 6 inches stroke) working upwards, and being geared down to the propeller shaft by ordinary tooth gearing. The pressure carried was 25 lbs., and her average speed was about 12 knots.<sup>1</sup>

Another famous screw-steamer brought out by this company was the **Russia**, which was put on the service in 1867. She was of slightly larger dimensions than the **China**, being 370 feet long, by 43 feet broad, and 29 feet deep, and 3,100 tons. She was propelled by inverted direct-acting engines, having two cylinders, each 85 inches diameter, and 45 inches stroke. The vessel

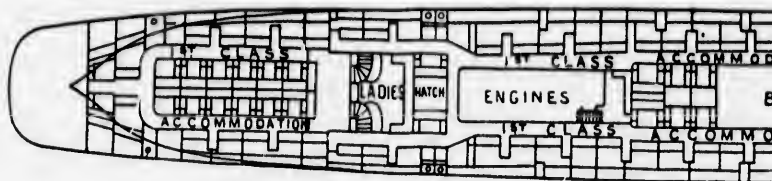
<sup>1</sup> For illustration of engines, see p. 166.

ric Sau-  
 must be  
 successful.  
 ried on a  
 built by  
 a share  
 le vessel  
 tained a  
 upon by  
 he latter  
 use.  
 e Cunard  
 e China,  
 mensions  
 She was  
 were the  
 f a type  
 ylinders  
 s stroke)  
 ropeller  
 e carried  
 2 knots.<sup>1</sup>  
 by this  
 e service  
 ns than  
 ad, and  
 d by in-  
 ers, each  
 e vessel



ouse and high bulwarks.

Face page 34.

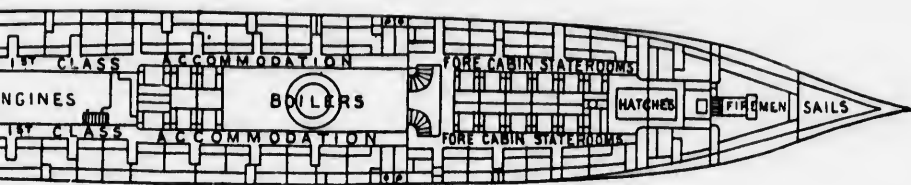


Middle Deck.

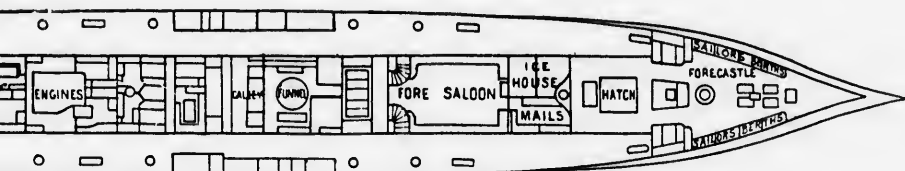


Main Deck, showing arrangement with a long wheelhouse.

DECK PLAN OF SS. C



Middle Deck.



arrangement with a long wooden deckhouse and high bulwarks.

DECK PLAN OF SS. CHINA.

Face page 34.

and engine  
She carried  
pany for a  
the fastest  
soon after  
for high speed  
by the machine  
1881 she was  
and by the  
engines, and  
to "bridge the  
refitted with

After the  
to add new  
out none of  
rather behind  
pull, and made  
Their first voyage  
brought out  
Algeria and A  
ical engines.  
itted with co  
wing to a large  
nd were followed  
rank compound  
nge vessel, like  
as built and  
ydebank. She  
nd 8,500 tons  
ound vertical

and engines were built by Messrs. J. and G. Thomson. She carried on the express service of the Cunard Company for a few years with the **Scotia**, but the honour of the fastest passage having been wrested from this line soon after she came out, she did not become noted for high speed, although she continued to be patronized by the majority of the saloon passenger traffic. In 1881 she was sold to the Red Star Line of Antwerp, and by them lengthened and fitted with compound engines, and re-named the **Waesland**; and still continues to "bridge the ocean," having recently (1890) been again refitted with triple engines.

After the **Russia**, the Cunard Company still continued to add new iron screw-propelled vessels to their fleet; but none of them became prominent, as they were rather behind the time in design and arrangements of hull, and machinery, and in passenger accommodation. Their first vessel with compound engines was the **Parthia**, brought out in 1870, followed in the same year by the **Algeria** and **Abyssinia**, which had ordinary expansion vertical engines. In 1874 came the **Bothnia** and **Scythia**, fitted with compound engines (the latter becoming noted owing to a large whale striking the propeller in July, 1875), and were followed in 1879 by the **Gallia**, fitted with three-crank compound engines, and in 1881 by the **Servia**. This large vessel, like the other Cunarders about this period, was built and engined by Messrs. J. and G. Thomson, of Clydebank. She was 478 feet long, 52 broad, 41 deep, and 8,500 tons; the engines were of the ordinary compound vertical three-crank type, the high-pressure

cylinder in the centre being of 72 inches diameter, and each of the low-pressure 100 inches, with a stroke of 6 feet 6 inches.

This vessel was practically the first of what may be called the Express Transatlantic Service, as, owing to the immense space required for the powerful machinery necessary for the high speed beginning to prevail, but little room was left for cargo. Another reason for the greater attention given to passenger traffic was the large number of slow small-powered big-carrying modern cargo-boats commonly called "tramps," which were flooding the freight market with tonnage and so cutting down rates.

Although the first steel vessel, and the first with a cellular bottom in the Express Service, the **Servia** was not the first in the North Atlantic trade, that honour belonging to the Allan Liner **Buenos Ayrean**, built and engined by Denny, of Dumbarton, in 1879, and the **Parisian**, built by Napier in 1881. In 1882 another Cunarder, the steel **Aurania**, also built by J. and G. Thomson, came out, and represented a new departure suggested by the builders, which was, in fact, a reaction against the then prevailing proportions of length to beam, which was generally 10 or 11 to 1. In this craft these proportions were altered to about 8 to 1, the dimensions being 470 feet long, 57 $\frac{1}{4}$  feet broad, 37 $\frac{1}{4}$  feet deep, and 13,360 tons. The engines were almost of the same design and size as the **Servia's**.

Neither of these vessels attained the honour of the much-prized "fastest record passage," and beyond the fact of the **Aurania** having become noted for a series

breakdown  
they have

As may  
about this

Line, they  
tion" on t

for over fif

by the purc  
which had

succeeded i

cent but ill  
sailed June

later. Sufi

of very suc

short exper

during whi

career was

American w

York Bay, c

This mer

world, and

about bulkh

that the in

ship-owners

distinctly b

their noted

life, wherea

identical wi

and Wolff) r

thus enblin

breakdown of machinery which disabled her for months, they have not been famous.

As may be surmised by the number of vessels which about this time were being brought out by the Cunard Line, they were endeavouring to gain the "premier position" on the Atlantic which they had now relinquished for over fifteen years; and it is remarkable that it was by the purchase of a vessel from a competing company, which had already beaten the record, that they at last succeeded in regaining it. This vessel was the magnificent but ill-fated *Oregon*, which they purchased and first sailed June 7th, 1884, and which will be commented on later. Suffice it here to say, that after two short years of very successful working for the Cunard Line, and a short experimental service under the British Admiralty, during which she afforded admirable experience, her career was suddenly terminated by colliding with an American wooden schooner off Fire Island, outside New York Bay, on March 11th, 1886.

This memorable event startled the whole maritime world, and the usual alarming statements and prophecies about bulkheads once more became fast and furious; but that the ingenuity and care of both ship-builders and ship-owners had not been thrown away, is shown very distinctly by the fact that the Cunard Line still retain their noted record of *never having lost a passenger's life*, whereas had the bulkhead division (which was identical with that first introduced by Messrs. Harland and Wolff) not been efficient and of sound workmanship, thus enabling her to be kept afloat for some hours, it is



more than probable that the loss of life would have been appalling.

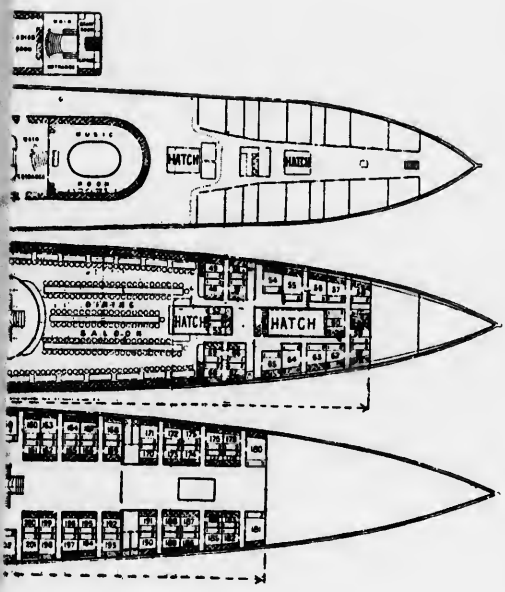
Up to the present the last vessels brought out by the Cunard Line to maintain the premier position, are the well-known **Umbria**, which first sailed October 31st, 1884, and the **Etruria**, on April 25th, 1885. They were of steel, 500 feet long, 57½ feet broad, 41 feet deep, and 13,300 tons. They were built by the firm of John Elder and Co., then reconstituted under the name of the Fairfield Ship-building and Engineering Co., which had also built the **Oregon**, whose satisfactory performances had no doubt led to the placing of the order with them; and it is worthy of notice that these were the first vessels actually built for the line which succeeded in making the fastest record passage in recent times.

Following the usual Cunard custom, there were no pronounced innovations upon the **Oregon**, the outline of rig being simply modified to correspond with the usual appearance of the fleet, and notwithstanding that the triple engines were then being generally adopted, the machinery was of ordinary three-crank compound type, the diameter of the high-pressure cylinder being 71 inches, and of each of the others, 105 inches, with a stroke of 6 feet. The boiler pressure was 110 lbs., the steam being generated in nine boilers having seventy-two furnaces, and consuming 320 tons per day, with 14,000 indicated horsepower which drove her at 19 knots per hour. These particulars and dimensions are interesting, as being in all probability the highest which will ever be reached in compound engines, owing to the ensuing introduction of the

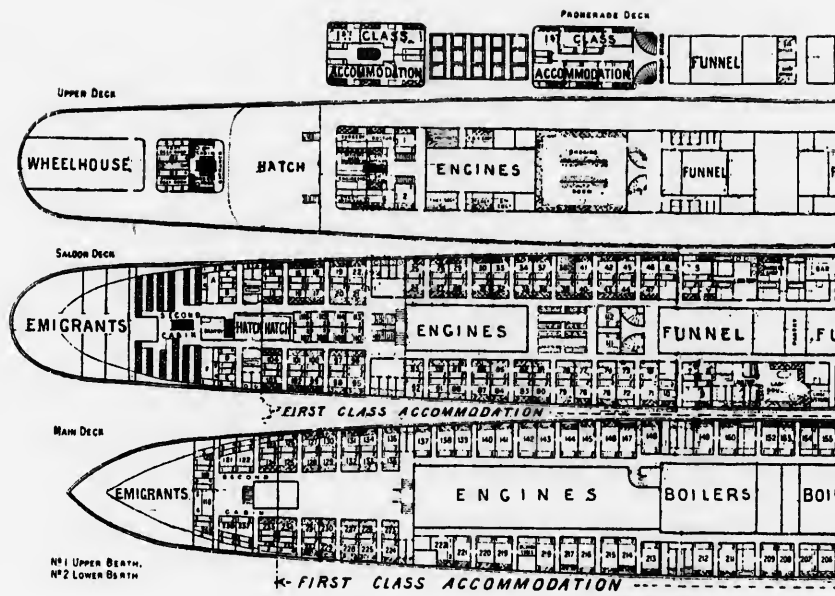
have been

ut by the  
a, are the  
1st, 1884,  
e of steel,  
d 13,300  
and Co.,  
eld Ship-  
built the  
no doubt  
and it is  
actually  
ne fastest

were no  
outline of  
he usual  
that the  
ted, the  
nd type,  
being 71  
a stroke  
am being  
aces, and  
ed horse-  
. These  
being in  
ached in  
on of the



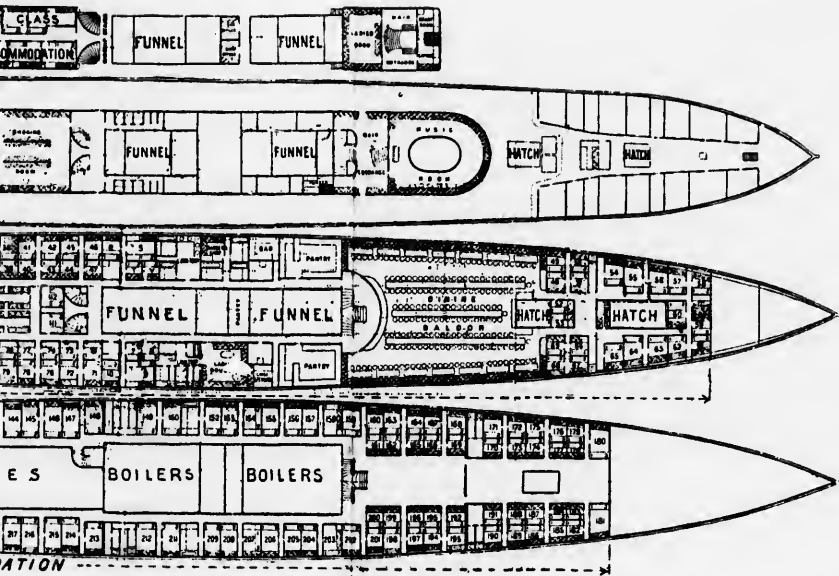
Face page 38.



№ 1 Upper Berth.  
 № 2 Lower Berth

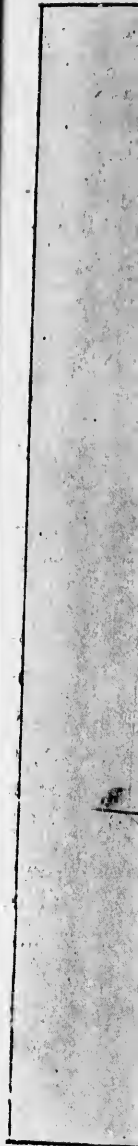
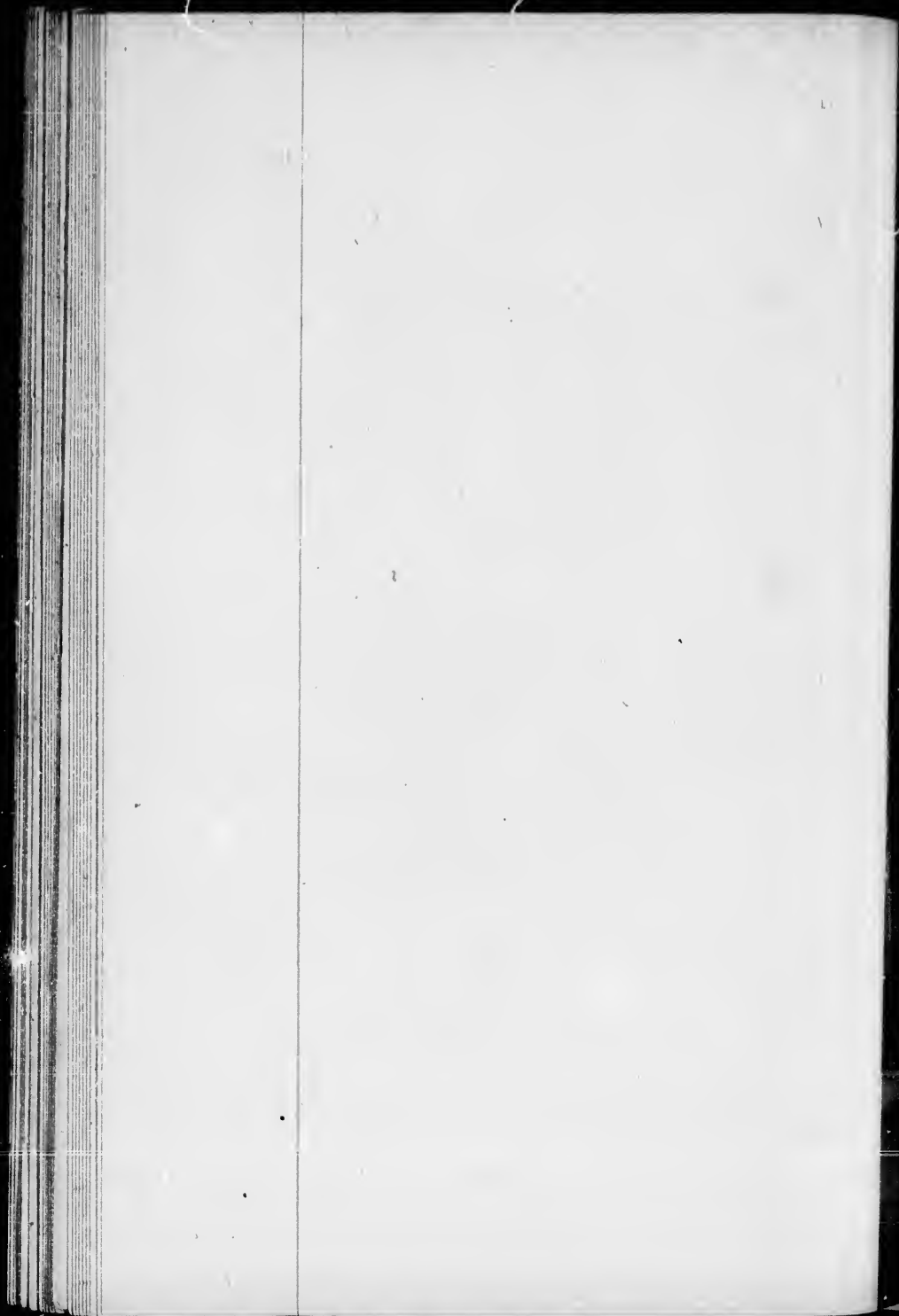
CABIN PLAN OF UMBRIA AND ET

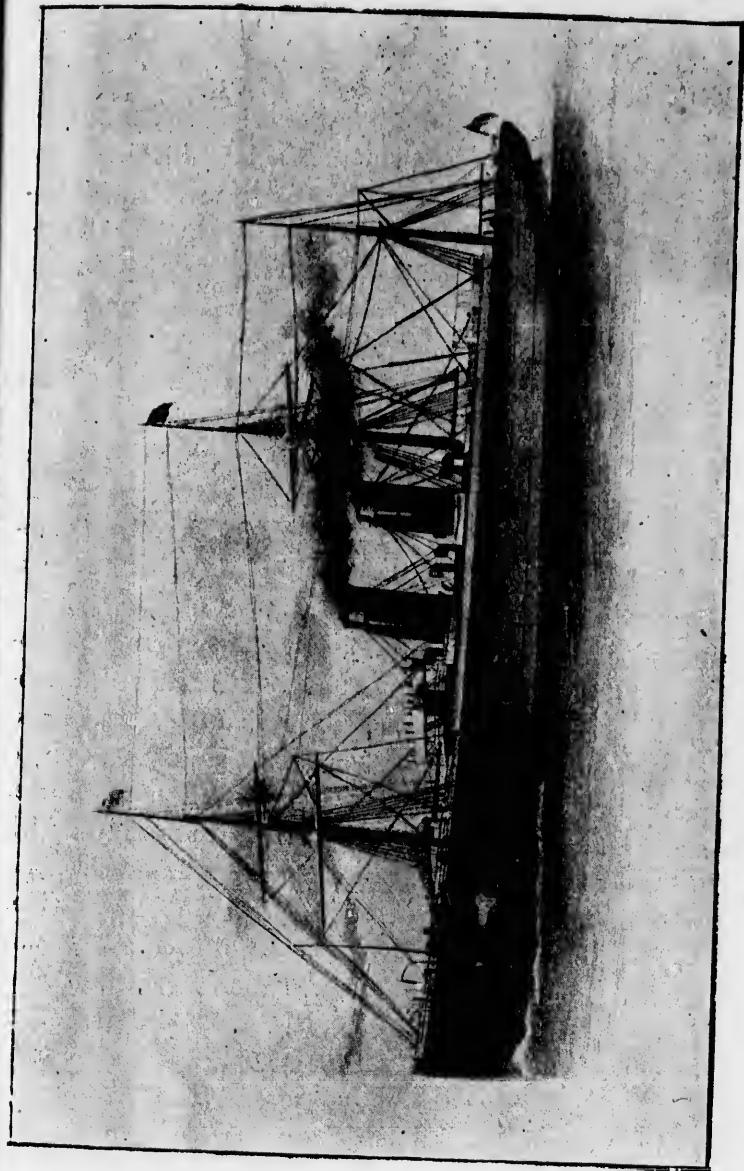
POORHARD DECK



PLAN OF UMBRIA AND ETRURIA.

Face page 38.





R.M.S. UMBRIA (1884) AND ETRURIA (1885). CUNARD LINE.

“twin screws,” which divide the power into two separate sets of machinery of considerably more than half the horsepower hitherto used, and also to the introduction of the triple expansion engine, which has rendered the compound now obsolete. Since their advent these handsome vessels have been largely and deservedly well patronized, but have had to yield the palm to the former rivals of the Cunard Line, and as there is no finality in such affairs, and the line is eager to regain and hold the fastest record passage, “Faint murmurs of improvement come,” so that man’s daring and constructive skill, in surmounting the difficulties and trials of advancing still further in the noble kindred sciences of naval architecture and marine engineering, is now being put to further test in producing new Cunarders.<sup>1</sup>

Following the inevitable laws of nature and the dictates of the great manipulator, Father Time, the proprietary of this great line, like its vessels, has had to undergo change; the first being the handing over of the private ownership from the founders, Cunard, Burns, and MacIver, in 1878, to a private company entitled “The Cunard Steamship Company, Limited,” and registered on February 23rd, 1878, with a capital of £2,000,000 in 20,000 shares of £100 each. This was changed again to a public company in 1880, the shares being eagerly taken up by the public. Some time afterwards, early in 1883, the Messrs. MacIver withdrew from the company, and the management was taken over by the directors, assisted by a responsible manager and

<sup>1</sup> See Appendix.

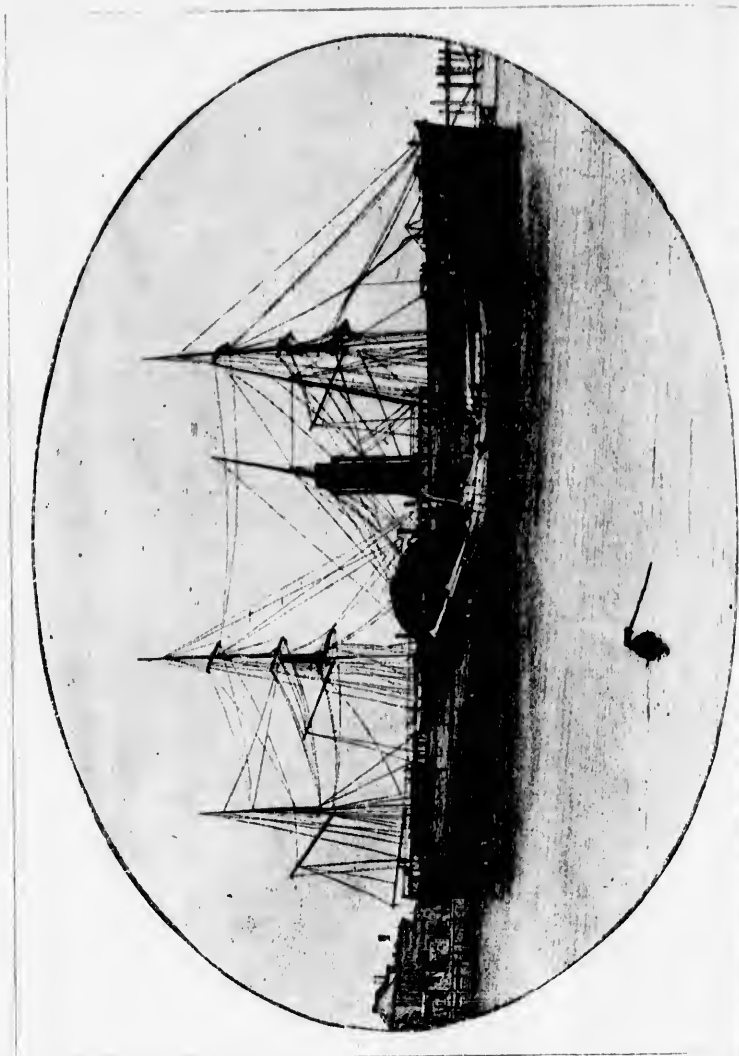
officials under  
John Burns  
it now remains

Following  
effort to be  
famous Col  
States in 1  
English ste  
ing on Apr  
by despatch  
steamships  
Pacific, each  
broad, and 3  
by William  
constructed  
and was c  
inches diam  
in number,  
one above t  
2 inches dia  
sure on a c  
paddles wer  
12½ knots pe  
could comm  
vessels, eac  
sidered no  
performance  
successful,  
doubt, to t  
1854, they

officials under the direct supervision of Mr. (now Sir) John Burns, the present chairman, under which *régime* it now remains.

Following the Cunard, the next great steamship effort to be noticed is the commencement of the once famous Collins Line, which was founded in the United States in 1848, to wrest, if possible, the trade from the English steamers. This line commenced its first sailing on April 27th, 1849, from New York for Liverpool, by despatching the **Atlantic**, one of four splendid wooden steamships, the others being named **Arctic**, **Baltic**, and **Pacific**, each of which measured 282 feet long,  $45\frac{1}{2}$  feet broad, and 32 feet deep, with a tonnage of 2,860 tons, built by William Brown, at New York. The machinery was constructed by the Novelty Ironworks of the same place, and was of the side-lever type, having cylinders 96 inches diameter, and 9 feet stroke. The boilers, four in number, were arranged with two rows of furnaces, one above the other, and were fitted with vertical tubes 2 inches diameter. Steam was carried at 17 lbs. pressure on a consumption of about 85 tons per day. The paddles were  $35\frac{1}{2}$  feet diameter, the average speed about  $12\frac{1}{2}$  knots per hour. Every effort which skill and science could command was put forth in the equipment of these vessels, each costing over £100,000; but cost was considered no object so long as they outstripped the best performances of the Cunard vessels. In this they were successful, but financially they were not, owing, no doubt, to the lavish expenditure, and in September, 1854, they received a terrible blow in the loss of the





**Arctic**, wh  
 named th  
 with a los  
 son, and c  
 and prom

About t  
 them in th  
 pool on Ju  
 known, th  
 of," being  
 living fre  
 The last of  
 brought ou  
 in Decemb  
 vessel buil  
 Steers, at  
 broad, and  
 The machi  
 works, New  
 ders each  
 indicating  
 20 lbs., the  
 revolutions  
 daily consu  
 drawal of t  
 laid up, the  
 (Ireland), p  
 cessful she v  
 wards sold t  
 she still exist

**Arctic**, which was run into by a small French steamer named the **Vesta**, off Cape Race in a dense fog, and sunk with a loss of 322 lives, amongst whom were the wife, son, and daughter of Mr. Collins, the managing director and promoter of the line.

About two years after this another great disaster befell them in the loss of the **Pacific**, which sailed from Liverpool on June 29th, 1856, but as to her fate nothing was known, the brief and terrible sentence, "Never heard of," being the only tale of how a noble vessel and her living freight were suddenly engulfed in eternity. The last of the great wooden paddle-steamers, the **Adriatic**, brought out by the Collins Line, arrived in Liverpool in December, 1857, and was by far the finest and fastest vessel built up to that date. She was constructed by Steers, at New York, and was 355 feet long, by 50 feet broad, and 33 feet deep, her gross tonnage being 3,670. The machinery was constructed at the Novelty Ironworks, New York, and consisted of two oscillating cylinders each 100 inches diameter and 12 feet stroke, indicating 2,500 horse-power, with a boiler pressure of 20 lbs., the paddles were 40 feet diameter, and at 17 revolutions per minute gave a speed of 13 knots on a daily consumption of 85 to 90 tons. Upon the withdrawal of the Collins Line in January, 1858, she was laid up, then sold to be put upon the service from Galway (Ireland), promoted in 1861; but the line being unsuccessful she was again laid up in Birkenhead, and afterwards sold to serve as a hulk in the west of Africa, where she still exists. The two remaining vessels, **Atlantic** and

**Baltic**, were converted into sailing-ships and were afloat until recent years, but have now disappeared.

The continued success of the Cunard Line soon brought forth others anxious for a share of the great profits which were being reaped. In 1847 the Americans established a line to trade between New York and Bremen, touching at Cowes in the Isle of Wight: it was called the Ocean Steam Navigation Company, and contracted to carry the United States mails twice a month. It lasted, however, only a few years, being very unsuccessful.

In 1848 the Americans formed another line of vessels to ply from New York to Havre, touching at Southampton, under the name of the New York and Havre Steam Navigation Company. They commenced running in 1850, with a large subsidy from the United States Government for carrying the mails. The vessels of this line were also very unfortunate, two of them having been lost within twelve months, a misfortune which caused the company to be dissolved some time afterwards.

Just ten y  
(namely in  
beginning  
from the  
known In  
by the fol  
eury," De

"*Steam  
delphia.*—  
B. E. Mat  
1,610 ton  
under:

"From  
12 Feb., 1  
1851; Th

"This v  
between G  
room acco  
passengers

"*Rates*  
guineas; ;  
1st Cabin,

"These  
not wines

"*Rates*  
measurem  
ment.

## CHAPTER III.

### THE INMAN, ANCHOR, AND ALLAN LINES.

JUST ten years after the foundation of the Cunard Line (namely in 1850), another of the great lines made a small beginning, but with an entirely different type of vessels from the form then existing. This was the now well-known Inman Line, and was announced in the papers by the following advertisement in the "Liverpool Mercury," Dec. 6th, 1850 :

*"Steam communication between Liverpool and Philadelphia.*—The powerful screw steamship **City of Glasgow**, B. E. Matthews, late of the **Great Western**, Commander, 1,610 tons, 350 horse-power, is intended to sail as under :

*"From Liverpool.*—Wednesday, 11 Dec.; Wednesday, 12 Feb., 1851. *From Philadelphia.*—Thursday, 16 Jan., 1851; Thursday, 13 March.

This vessel is well known from her successful voyages between Glasgow and New York, and has ample stateroom accommodation for about 120 first and second cabin passengers, no steerage passengers taken.

*"Rates of Passage.*—*From Liverpool.*—1st Cabin, 22 guineas; 2nd Cabin, 13 guineas. *From Philadelphia.*—1st Cabin, 100 dollars; 2nd Cabin, 60 dollars.

These rates include provisions and steward's fee, but not wines or liquors, which can be had on board.

*"Rates of Freight.*—*From Liverpool*—£4 per ton measurement. *From Philadelphia.*—According to agreement.

"Passengers and shippers will find Philadelphia the most central port, possessing railway communication in a few hours and at trifling expense to New York for the North; being also on the main line from the North through Baltimore to Washington and the Southern States, and the great central railway (now open to within 80 miles of Pittsburg on the Ohio) forms the shortest and most direct route to the Western States. All goods sent to the agents in Philadelphia will be forwarded with economy and despatch.

"For further particulars apply in Philadelphia and New York to Richardson, Watson and Co.; in Belfast, to Richardson, Brothers and Co.; in Glasgow to Patrick Henderson and Co., and in Liverpool to

"RICHARDSON, BROTHERS AND Co.,  
 "12 and 13, Tower Buildings,  
 "Liverpool."

This service was founded by Mr. William Inman, of Liverpool, in conjunction with the firm of Richardson Brothers, of the same place, the intention being to trade between Philadelphia and Liverpool. Their first steamers were the **City of Glasgow**<sup>1</sup> and **City of Manchester**, the former, which was originally built for trade between Glasgow and New York, was described as follows by the "**Glasgow Courier**."

"A NEW ATLANTIC STEAMER.

"Our citizens will shortly have the gratification of witnessing the starting from the Broomielaw of the first ship of a line of magnificent steamships to sail direct between Glasgow and New York. The honour of this undertaking is due to the enterprise of our townsmen,

<sup>1</sup> The **City of Glasgow** was afterwards lost in the Black Sea with all hands, but was not then in the Atlantic trade, so is omitted in table of losses.

Messrs. Tod  
 vessel in a  
 pected to b  
 end of Febr

"The Cit  
 ing name of  
 ing complet  
 built of iron  
 her beauty  
 real magnitu  
 tons measur  
 screw 13 fee  
 be worked by  
 The machin  
 the sweep of  
 spar-deck w  
 weather, an  
 ample space  
 lated, and pr  
 of the main  
 On each side  
 clear in the c

"The acco  
 admirable an  
 or first-class,  
 age emigrant  
 firemen, stev  
 about 70, so  
 upwards of 6  
 passengers ha  
 only two. T  
 have four an  
 for ladies are  
 sitting-rooms  
 main-cabin.  
 sions, and wil  
 a well-assorte  
 with panelling

Messrs. Tod and M'Gregor, who have already their first vessel in a state of considerable forwardness, and is expected to be ready for launching from the stocks by the end of February.

"The **City of Glasgow**, for such is to be the distinguishing name of the splendid steamship now rapidly approaching completion in Messrs. Tod and M'Gregor's yard, is built of iron, and is of imposing dimensions, although her beauty and symmetry apparently detract from her real magnitude. She is a three-decker, of about 1,600 tons measurement over all, and is to be propelled by a screw 13 feet in diameter and 18 feet pitch, which is to be worked by two lever beam-engines of 350 horse-power. The machinery, etc., will all be placed so low as to leave the sweep of the decks clear without encumbrance. The spar-deck will form a magnificent promenade in fine weather, and in foul weather the main-deck affords ample space for recreation, perfectly lighted and ventilated, and protected from rain or spray. The total length of the main-deck is 237 feet, and the breadth 34 feet. On each side are ranged the state-rooms, leaving 16 feet clear in the centre. The height between decks is 7 feet.

"The accommodation for each class of passengers is admirable and most complete. She will carry 52 cabin, or first-class, passengers, 85 second-class, and 400 steerage emigrants. The crew, including officers, engineers, firemen, stewards, sailors etc., will probably number about 70, so that she will carry a total living cargo of upwards of 600. Two of the state-rooms for first-class passengers have four berths in each, all the others have only two. The state-rooms for second-class passengers have four and eight berths in each. The state-rooms for ladies are so capacious that they may be used as sitting-rooms, should they choose to retire from the main-cabin. The latter is an apartment of noble dimensions, and will be elegantly fitted up, and furnished with a well-assorted library. The walls will be decorated with panellings representing views of places of interest

on both sides of the Atlantic. One room is being fitted up as an apothecary's shop, from which the surgeon will dispense his medicines. Near this is the bath-room, with apparatus for pumping up the salt water from the Atlantic. In fact, nothing has been left undone which science and ingenuity can suggest to add to the comfort and convenience of the passengers. Nor has their safety been uncared for in the construction and fittings of this noble ship. By means of five water-tight bulkheads the vessel is divided into six compartments, so that she would float although several of these divisions were filled. She will be furnished with six capacious lifeboats, having copper tanks under the seats to render them buoyant. Danger from fire has been likewise carefully guarded against. The lamps which light the state-cabins can only be opened by the officers of the ship; and powerful pumps, to be worked by the engines, are supplied so as to extinguish at once any fire which might break out. In the bottom of the hold are placed iron tanks to contain 13,000 gallons of fresh water. There will be ample storage for 1,200 tons of goods.

"In addition to the screw motive power the City of Glasgow is barque-rigged, and will carry an enormous press of canvas."

The City of Glasgow and City of Manchester were built of iron, upon the Clyde, by Messrs. Tod and M'Gregor, and were 258 feet long,  $34\frac{1}{4}$  feet broad, and 25 feet deep, and of 2,125 tons, and had overhead geared engines of 350 horse-power, constructed by the same firm, with cylinders 71 inches diameter, and stroke of 5 feet, driving a two-bladed screw-propeller. Steam at 10 lbs. pressure was generated in three boilers having nine furnaces. With the advent of these vessels commenced the long-waged war of paddle versus screw ocean steamers; so that although the Great Britain had been previously in the trade, to the



g fitted  
on will  
n-room,  
rom the  
e which  
comfort  
r safety  
of this  
ads the  
at she  
re filled.  
, having  
uoyant.  
guarded  
ms can  
powerful  
ed so as  
eak out.  
s to con-  
be ample

e City of  
ormous

ere built  
Gregor,  
eet deep,  
engines  
rm, with  
t, driving  
pressure  
es. With  
ged war of  
ough the  
e, to the



CITY OF GLASGOW (1850). FIRST INMAN STEAMER.



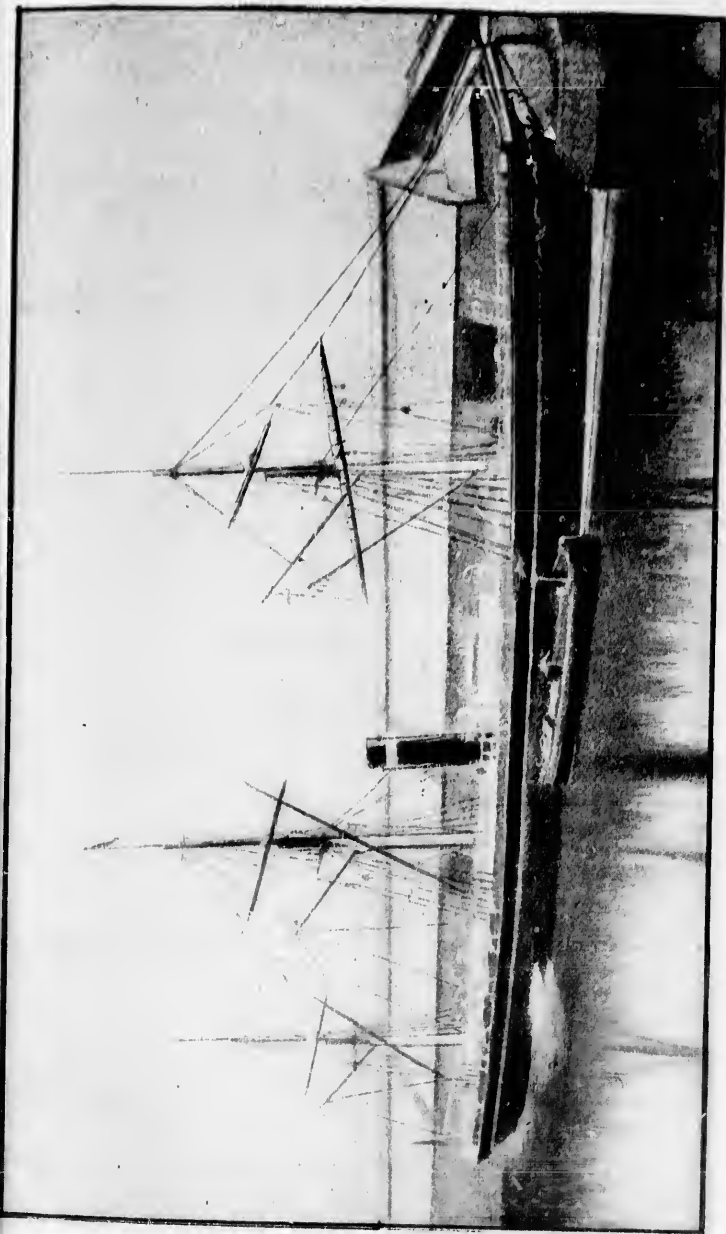
Inman Line belongs the honour of having introduced the first successful iron screw steamer, to which Company's notice it was brought by Mr. Tod, of the firm that built the vessel. The first sailing was the **City of Glasgow**, which left Liverpool on December 11th, 1830, for Philadelphia, followed soon after by the **City of Manchester**, **City of Philadelphia**, and others. In 1857 they commenced calling at New York, which proving a more suitable port, Philadelphia was given up. After this event the direct rivalry between this line and the Cunard commenced; the latter having by that time got rid of their old rival the Collins Line, now found another coming forward with a modern style of screw-steamship, to compete with them for a share of the enormous subsidies which were at that time in vogue.

This rivalry soon bore good fruit as far as the public were concerned, as each succeeding new vessel was always built to outstrip the performances of the other line's crack ship, as well as to surpass it in the elegance of the fittings.

In 1869 the Cunard Company, in the matter of speed, was eclipsed by the performances of the Inman steamer **City of Brussels**, which made a splendid run home of 7 days, 22 hours, 3 minutes; and as the first **City of Paris** had in 1867 made the fastest outward passage, their rival had to yield the palm.

The first **City of Paris** was built and engined by Tod and M'Gregor of Glasgow in 1866, and was 358½ feet long, 40½ feet broad, and 26 feet deep, and of 2,875 tons, her engines being of the horizontal trunk type, with

AP. III.  
duced  
Com-  
e firm  
City of  
, 1850,  
of Man-  
57 they  
a more  
er this  
Cunard  
rid of  
another  
amship,  
us sub-  
  
e public  
sel was  
e other  
in the  
  
of speed,  
steamer  
home of  
y of Paris  
their rival  
  
d by Tod  
358½ feet  
875 tons,  
pe, with



**INMAN CITY OF BRUSSELS (1869).**  
Last Atlantic Steamer built with wooden deckhouse and high bulwarks.

cylinders of 89 inches diameter, and 3 feet 6 inches stroke, consuming 105 tons per day, the speed being  $12\frac{1}{2}$  knots per hour. This fine vessel was afterwards lost at sea in March, 1885, under the name of the **Tonquin**.

The **City of Brussels**, built by the same firm, was launched in 1869. She was 390 feet long,  $40\frac{1}{4}$  feet broad, 27 feet deep, and of 3,747 tons. The engines were horizontal direct-acting trunk engines with surface condenser, having two cylinders each of  $91\frac{1}{2}$  inches diameter, 4 feet stroke, and steam pressure of 30 lbs., which propelled her at a speed of nearly 13 knots on a consumption of 110 tons per day.

One of those important details which are so vital in the successful working of these great vessels was first adopted on this ship, namely the steam steering gear which had recently been introduced and tested on the **Great Eastern**. This valuable auxiliary was designed and successfully worked out by Mr. MacFarlane Gray of the famous Vauxhall Foundry, Liverpool, owned by George Forrester and Co., which has since disappeared like some of the other great firms, such as Woods, Vernon, Jack, and others who have helped on the great civilizer of our day—the ocean steamship.

The career of this famous vessel, the first to reduce the passage to under eight days, in December, 1869, deserves notice, for she was the last of a type of steamship which was at this date much in vogue, having a long narrow wooden deckhouse with high bulwarks, giving but limited space to the passengers.<sup>1</sup> This was afterwards done

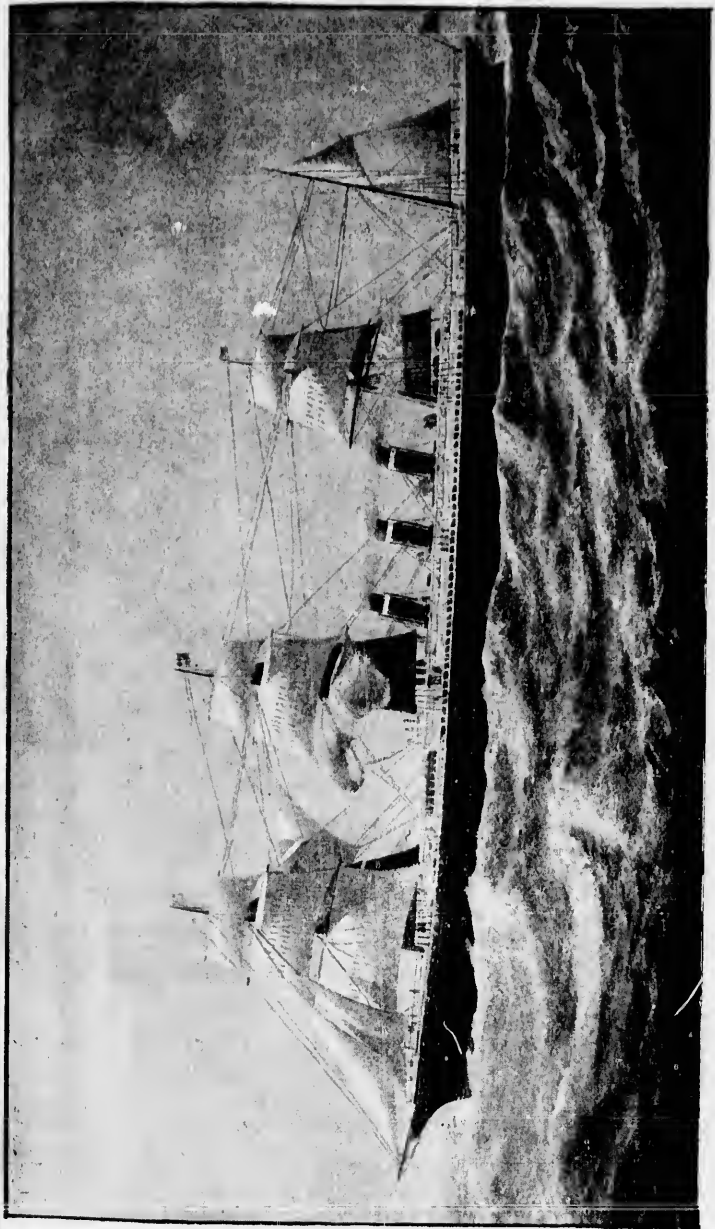
<sup>1</sup> See deck plan steamship "China" for this arrangement, p. 34.

MAP. III.

inches  
ng 12½  
lost at  
n.  
n, was  
0¼ feet  
engines  
surface  
inches  
80 lbs.,  
ots on a

vital in  
as first  
ng gear  
on the  
esigned  
ne Gray  
wned by  
ppeared  
Woods,  
he great

o reduce  
869, de-  
eamship  
g a long  
iving but  
ards done  
ent, p. 34.



THE INMAN LINE CITY OF ROME (1881), AS ORIGINALLY RIGGED.

away with in 1872, another deck being added and other extensive alterations made to enable her to compete with newer rivals which had come upon the scene. Later, in 1876, the original engines and boilers were removed and replaced by four-cylinder tandem compound engines, and in the year 1877 she was the object of attention, owing to a very long delay in arriving caused by the breakage of the shaft, as there were on board many Catholic pilgrims bound to Rome on the occasion of the jubilee of his Holiness Pius IX.

In 1883 her career was suddenly ended by a collision with a steamer named the **Kirby Hall**, which cut into and sank her in a dense fog, off the mouth of the Mersey, on January 7th, 1883.

Following the usual order of things, this famous vessel was succeeded by others to maintain the efficiency of the fleet. The **City of Richmond** and other vessels were brought forward, and in 1875 the **City of Berlin** commenced sailing. This fine vessel was built and engined by Messrs. Caird, of Greenock; she was 488½ feet long, 44¼ feet broad, 34¾ feet deep, and of 5,526 tons. The engines were of the two-cylinder compound two-crank vertical type, with cylinders of 72 and 120 inches diameter, and stroke of 5 feet 6 inches, the boiler pressure being 75 lbs., generated in twelve boilers having thirty-six furnaces. The consumption per day was about 120 tons, and her average speed about 16 knots on the passages made outward in September and homeward in October, 1875. These were the fastest ever made up to that time, and were much commented upon, the record being

wrested from  
which, com  
premier po  
in this trad  
with it in N  
engines and  
kenhead, an

After a p  
lines were  
much-prize  
the **City of**  
June 14th,  
Liverpool,  
the subject  
the great  
realized.

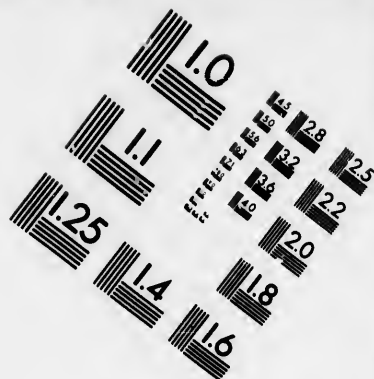
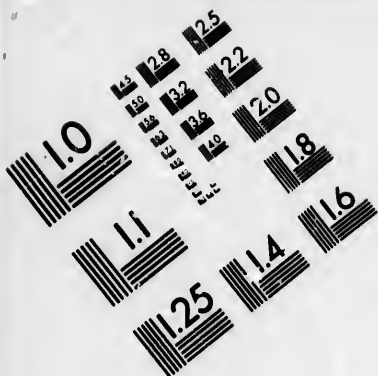
exceptional  
built of iron  
broad, and  
were for the  
spaced with  
ance in con  
outline of the  
the Barrow  
but it differ  
were six cy  
and three  
tandem fast  
was made i  
spur-wheels

wrested from the newer rival, the White Star Line, which, commencing in 1871, had till then held the premier position. The first use of the "electric light" in this trade was made in this steamer, which was fitted with it in November, 1879. In 1887 new triple expansion engines and boilers were supplied by Messrs. Laird, of Birkenhead, and forced draught on the Howden system fitted.

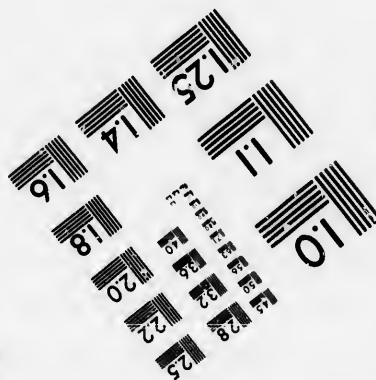
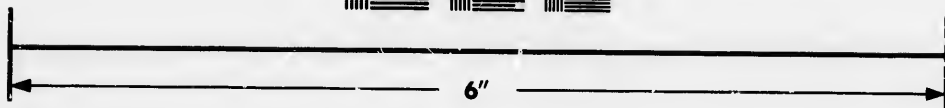
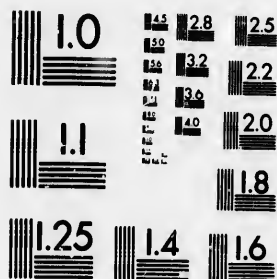
After a period of six years, during which time other lines were bringing forward noble vessels to obtain the much-prized "fastest passage," another beautiful vessel, the *City of Rome*, was launched for this line at Barrow on June 14th, 1881, and sailed on her first voyage from Liverpool, October 13th, 1881. This graceful vessel was the subject of much comment when being built, but the great expectations entertained were, however, not realized. The construction of the hull, beyond being exceptionally strong, calls for no comment. She was built of iron throughout, and was 546 feet long, 52½ feet broad, and 37 feet deep, and of 13,500 tons; three funnels were for the first time fitted, which being uniformly spaced with four masts, gave the vessel a noble appearance in conjunction with the graceful bow and general outline of the hull. For the machinery, which was also by the Barrow Company, the three-crank engine was adopted, but it differed from the other types in the fact that there were six cylinders, three high pressure, each 46 inches, and three low pressure, each 86 inches diameter, fitted tandem fashion, with a stroke of 6 feet. A great departure was made in the working of the slide-valves by means of spur-wheels, which geared the weigh-shaft (on which the







**IMAGE EVALUATION  
TEST TARGET (MT-3)**



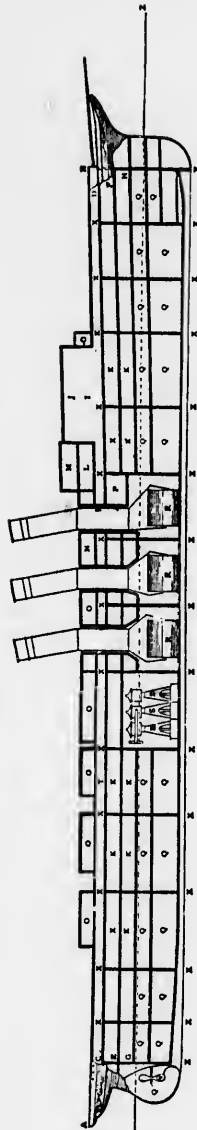
**Photographic  
Sciences  
Corporation**

23 WEST MAIN STREET  
WEBSTER, N.Y. 14580  
(716) 872-4303



0  
1  
2  
3  
4  
5  
6  
7  
8  
9  
10  
11  
12  
13  
14  
15  
16  
17  
18  
19  
20  
21  
22  
23  
24  
25  
26  
27  
28  
29  
30  
31  
32  
33  
34  
35  
36  
37  
38  
39  
40  
41  
42  
43  
44  
45  
46  
47  
48  
49  
50  
51  
52  
53  
54  
55  
56  
57  
58  
59  
60  
61  
62  
63  
64  
65  
66  
67  
68  
69  
70  
71  
72  
73  
74  
75  
76  
77  
78  
79  
80  
81  
82  
83  
84  
85  
86  
87  
88  
89  
90  
91  
92  
93  
94  
95  
96  
97  
98  
99

10  
11  
12  
13  
14  
15  
16  
17  
18  
19  
20  
21  
22  
23  
24  
25  
26  
27  
28  
29  
30  
31  
32  
33  
34  
35  
36  
37  
38  
39  
40  
41  
42  
43  
44  
45  
46  
47  
48  
49  
50  
51  
52  
53  
54  
55  
56  
57  
58  
59  
60  
61  
62  
63  
64  
65  
66  
67  
68  
69  
70  
71  
72  
73  
74  
75  
76  
77  
78  
79  
80  
81  
82  
83  
84  
85  
86  
87  
88  
89  
90  
91  
92  
93  
94  
95  
96  
97  
98  
99



AB Promenade Deck.

CD Saloon Deck.

EF Upper Deck.

GH Main Deck.

I First Cabin Dining-Saloon.

J Dome of Dining-Saloon.

K State-Rooms.

L Drawing-Room.

M Bridge.

N Library.

O Promenade Deck Suites and Cabins.

P Kitchen.

Q Cargo Compartments, Baggage, and Store-Rooms.

R Boilers.

S Engines.

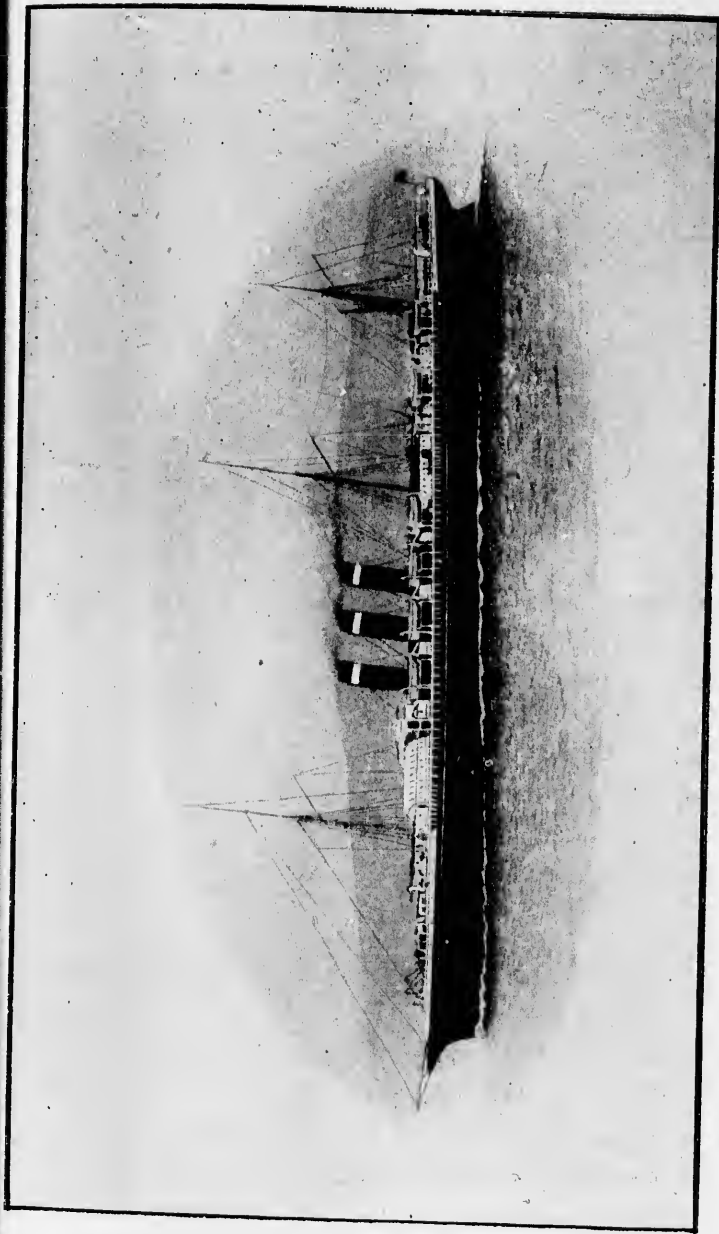
T Smoking Room.

U Rudder.

V One of the Twin Screws.

XX Watertight Bulkheads.

BULKHEADS OF THE CITY OF NEW YORK AND CITY OF PARIS.



CITY OF NEW YORK (1888) AND CITY OF PARIS (1889).  
(Inman and International Line.)  
First Twin Screw Express Atlantic Liners.

eccentrics were fitted) with the crank-shaft, and thus enabled the valves to be fitted at the back of the cylinders. Hollow shafting was also fitted throughout, except for the propeller length.

The boilers, which were of the usual type in iron, carrying 90 lbs. pressure, were eight in number, with forty-eight furnaces placed two and two in fore and aft line, which enabled a water-tight bulkhead to be fitted fore and aft on each side, so as to form the coal bunkers; this excellent arrangement was, however, altogether altered, as well as other parts of the machinery, after she was returned to the builders, with a view of attaining a speed more in accordance with the newer Atlantic vessels. After completion of these alterations, she was again put in the Express Service, under the auspices of the Anchor Line, in 1884, where she still continues.

With the exception of the **City of Chicago**, bought to replace the **City of Brussels** in 1883, no steamers were added to this line until the new *régime*. The Inman and International (noticed later) placed upon the service the now famous twin screw steel steamers **City of New York** (the third of that name, see p. 157), in March, 1888, and **City of Paris**, in April, 1889. The introduction of these splendid ships to the Express Transatlantic Service, marks one of these epochs of complete transformation in type of vessel, which, as the years roll by, the demands of the public necessitate, and the advance of engineering science renders possible. In the design and construction of hull and machinery great advances were made, steel being very extensively used,

and follow  
Thomson



STERN OF CH

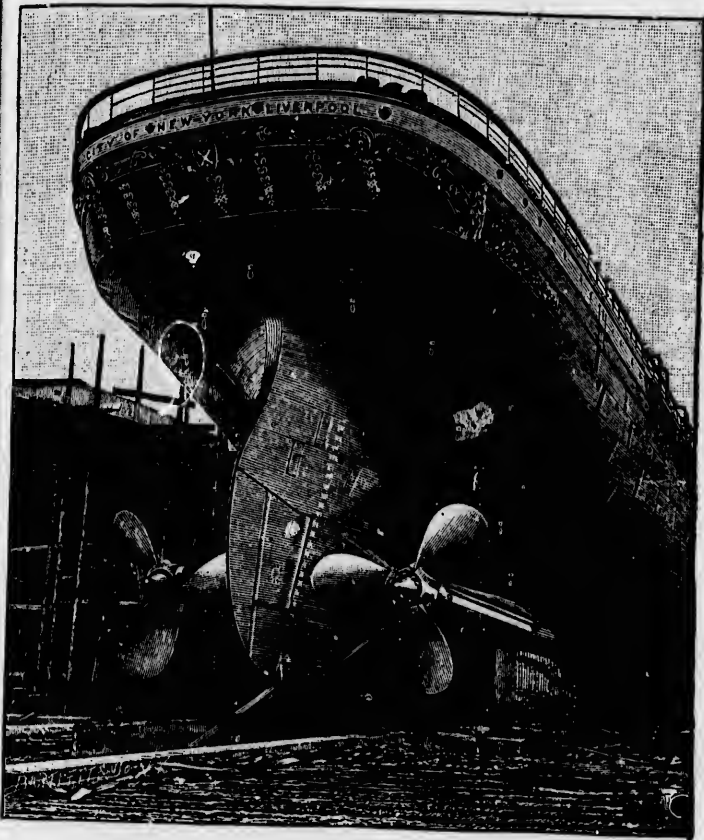
may be se  
subdivision  
numerous t

and thus  
 k of the  
 oughout,

e in iron,  
 ber, with  
 re and aft  
 o be fitted  
 bunkers;  
 altogether  
 ery, after  
 of attain-  
 r Atlantic  
 s, she was  
 uspices of  
 inues.

bought to  
 ners were  
 ne Inman  
 he service  
 ty of New  
 n March,  
 he intro-  
 ss Trans-  
 complete  
 the years  
 e, and the  
 e. In the  
 ery great  
 vely used,

and following the idea of the builders, Messrs. J. and G. Thomson, great breadth of beam was adopted; also, as



STERN OF CITY OF NEW YORK, SHOWING PATENT RUDDER AND TWIN SCREWS.

may be seen from the illustration, the most minute subdivision into water-tight compartments, effected by numerous transverse, and, for the first time, fore and aft

mid-line bulkheads. These were rendered practicable on account of the adoption, for the first time, in the Express Service, of the "twin screw" system of propulsion. Another great novelty was the adoption of the water chambers, to lessen the rolling in a sea-way.

The general outline was somewhat after the handsome appearance of the *City of Rome*, there being three funnels and three pole-masts with but little sail power, the introduction of the twin screws having evidently sounded the death-knell of all the time-honoured and romantic associations of the glistening sail and flowing sheet.

The machinery consisted of two separate (port and starboard) sets of three-crank triple engines possessing all the latest improvements; the boilers being fitted with forced draught on the closed stokehole system, and carrying 150 lbs. pressure.<sup>1</sup> One of the most marked innovations which deserves notice was the new arrangement of the rudder; this, unlike the usual type, had no part above the water-line, although the hull was so outlined or built as to look as if there were, but in this case the rudder proper only reached to a foot or two below the water-line, having the stock passing through a water-tight stuffing-box into a compartment in the run in which a powerful steering gear was placed. This, like all the other auxiliary machines on board, was worked upon Brown's hydraulic system, which was hitherto entirely unknown in this trade.

The first of these fleet argosies was the *City of New*

<sup>1</sup> Howden's system of forced draught has since been fitted on steamship "City of Paris" in 1891.

icable on  
e Express  
opulsion.  
he water

andsome  
e funnels  
r, the in-  
r sounded  
romantic  
heet.

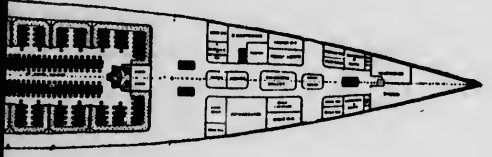
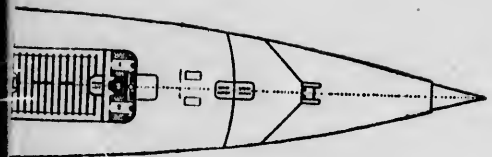
port and  
possessing  
itted with  
tem, and

t marked  
arrange-  
e, had no  
as so out

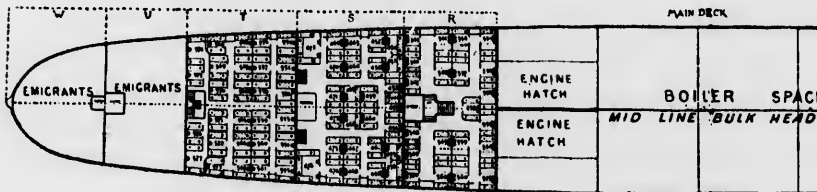
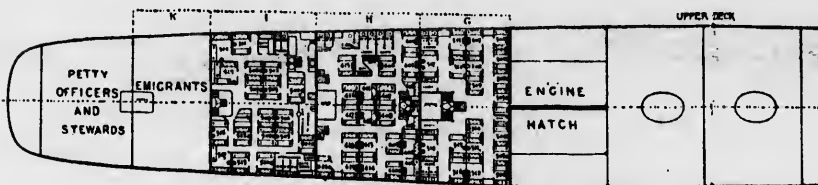
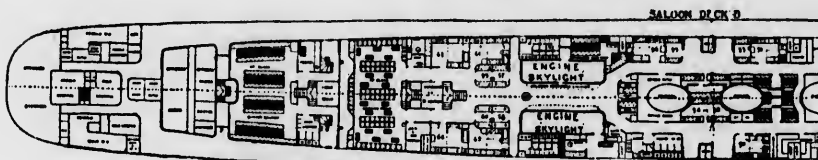
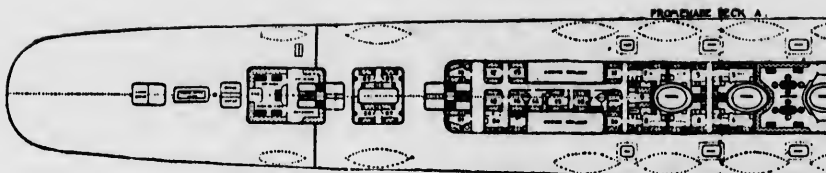
this case  
two below  
through a  
n the run

This, like  
as worked  
hithert

ty of New  
n fitted o



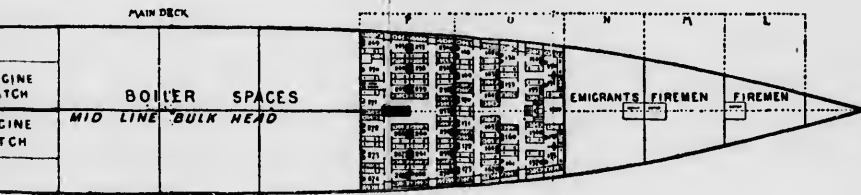
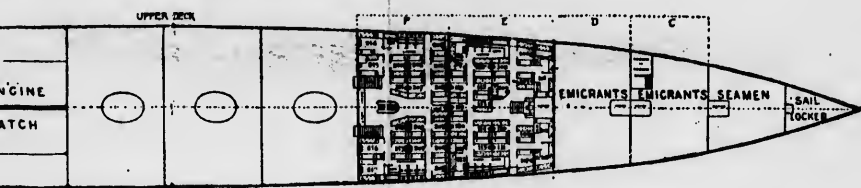
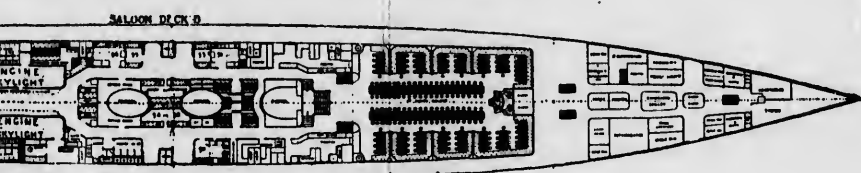
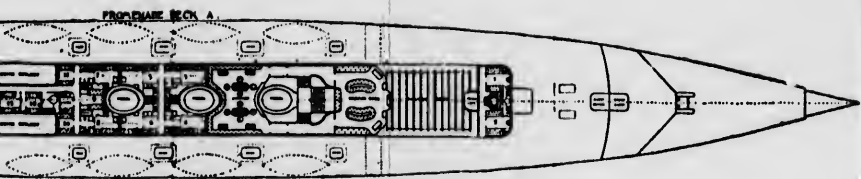
Face page 60.



DECK PLANS

DECK PLAN, CITY OF NEW





DECK PLAN, CITY OF NEW YORK.

Face page 60.

i  
l  
t  
t  
v  
i  
a  
u  
e

st

York, which  
by the City  
brought the  
honour of  
six days fel  
Public at  
in 1890, o  
nitude, whi  
25th, 1890,  
run; this, a  
plete wreck  
breakage of  
mishap it w  
and flooding  
almost impo  
other calcul  
limited fore  
Portions of  
bulkhead, al  
breakage of  
to flow free  
disabling the  
life or limb,  
foundering o  
safely until t  
a short deten  
nections and  
her own stea  
ever ought to  
ranged and ce

**York**, which came out in 1888, and was followed in 1889 by the **City of Paris**; the splendid runs of the latter soon brought them to the front rank, and in May, 1889, the honour of being the first to reduce the passage to below six days fell to the **City of Paris**.

Public attention was much turned to this vessel early in 1890, owing to an accident of exceptional magnitude, which occurred to the machinery on March, 25th, 1890, when nearing the Irish coast on a homeward run; this, as is now well known, consisted in the complete wrecking of the starboard engine, caused by the breakage of the shaft at the tube mouth. Until this mishap it was generally assumed that total disablement and flooding of both port and starboard machinery was almost impossible, and certainly most unlikely, but like other calculations of man's extensive but nevertheless limited foresight, it was found not to be infallible. Portions of the wrecked engine damaged the mid line bulkhead, allowing the water, which had, owing to the breakage of the sea connections, filled one engine-room, to flow freely into the other. Although completely disabling the ship, the breakdown caused no injury to life or limb, and at no time was there any danger of foundering or other fatal accident, for she floated quite safely until towed into Queenstown harbour, whence, after a short detention occupied in closing the wrecked sea connections and pumping out the water, she proceeded under her own steam to Liverpool; a fact which once and for ever ought to prove that bulkheads, when properly arranged and constructed, will effectually prevent sinking.

Since the advent of these two great "Cities" the Inman and International have rested on their laurels, although they also have yielded the palm of the fastest passage to their former rivals as will be recorded later.

Like that of the Cunard Company the proprietary of the Inman Line has undergone changes. It passed first from the private ownership of its energetic founder, Mr. William Inman, to a private limited company in 1875, which afterwards, in September, 1886, endeavoured unsuccessfully to raise additional capital by the public issue of debentures. The whole organization and fleet was then purchased by the International Navigation Company of the United States, better known as the Red Star Line, and the entire management altogether passed from the well-known name of Inman to that of Messrs. Richardson, Spence and Co., who now continue it under the name of the Inman and International Company, Limited.

In 1851 a line was formed in Glasgow to trade between that port and New York City; under the name of The Glasgow and New York Steam-packet Company. The first steamer, the **Glasgow**, sailed in 1851, and was followed by the **New York** and **Edinburgh**. The line was fairly successful until 1858, when the **New York** was lost, which proved the first step downwards, for soon afterwards the other steamers were sold, and the line was broken up in 1859.

The first successful line from Glasgow was that known as the Anchor Line, in 1856. This line, under the management of Messrs. Handyside and Henderson, commenced by despatching the steamer **Tempest** to New York. This trade was, however, only carried on as a secondary

one to their  
commenced  
the **Britann**  
rapidly tha  
weekly sail  
fleet rank a

One of the  
extensive lin  
air process  
the S.S. **C**  
arranged an  
The enormo  
service to ev  
ful venture,  
actual exper  
**leven** in the  
1878 by the

The next  
we must no  
the mother  
entered (in  
named Mac  
Canadian Go  
Early in 18  
Liverpool fo  
the **Ottawa**, **C**  
in 1854, whe  
war causing  
After the t

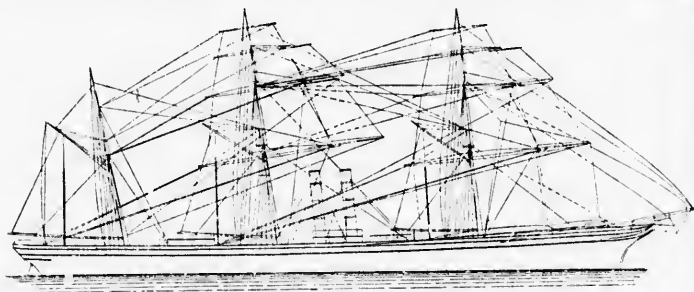
one to their Mediterranean trade until 1863, when they commenced with large steamers, the first two being named the **Britannia** and **Caledonia**. The trade increased so rapidly that it was soon found necessary to commence weekly sailings. The recent additions to the Anchor fleet rank amongst the largest of the Atlantic vessels.

One of the modern innovations introduced by this now extensive line was the carrying of dead meat by the dry air process of refrigerating. This was effected on board the S.S. **Circassia** by means of machinery specially arranged and made by Messrs. Bell, Coleman and Co. The enormous trade now carried on in this particular service to every part of the world dates from this successful venture, which was made in March, 1879; the first actual experiment was, however, that of the S.S. **Strathleven** in the Australian trade, fitted towards the end of 1878 by the same firm of Bell, Coleman and Co.

The next expansion of the Transatlantic service which we must notice was designed to connect Canada with the mother country, and to this end a contract was entered (in August, 1852) into by a firm in Liverpool, named MacKean, MacLasty and Lamont, with the Canadian Government for an annual subsidy of £24,000. Early in 1853 the first steamer, **Geneva**, sailed from Liverpool for Quebec, and was followed by others named the **Ottawa**, **Cleopatra**, etc. The service lasted until late in 1854, when it came to an end through the Crimean war causing a demand for steamers as "troopers."

After the termination of this service, another was soon

afterwards created by Sir Hugh Allan, of Canada, in conjunction with his brothers in Glasgow, and, under the name of the Allan Line, still flourishes. The first vessel was the **Canadian**, which sailed from Liverpool, on the 20th September, 1854, for Quebec and Montreal; this was an iron screw-propelled vessel built by Denny, of Dumbarton, 278 feet long, 34 feet broad, 24 feet deep, and of 1,873 tons, with inverted direct-acting screw engines by Tulloch and Denny, having cylinders 62 inches diameter, and  $1\frac{1}{2}$  feet stroke, the boiler pressure



CANADIAN (1854), FIRST STEAMSHIP OF THE ALLAN LINE.

being 12 lbs. per square inch. Owing to this vessel and her sister, the **Indian**, being chartered by the Government, no further sailings took place until April, 1856, when, under the name of the Montreal Ocean Steamship Company, an excellent service was commenced which has since been carried on regularly.

Like the other great lines the Allan has kept continuously adding to its fleet, from time to time, and such well-known vessels as the **North American**, **Anglo-Saxon**, **Circassian**, **Nova Scotian**, **Polynesian**, **Sarmatian**, have borne

the Canad  
some steel  
on the Cly  
broad, 33 f  
by Napier,  
type, the di  
each of the  
boiler press  
many stean  
Allan Line  
services spr  
express pas  
dian mail an  
1881. In 1  
Orient Line  
ment, to cor  
mean speed  
through. U  
Company ha  
a private cor  
steamship lin  
still determi  
rumours occa  
latest, in Mar  
men are pro  
under the ma

the Canadian flag from time to time down to the handsome steel **Parisian**, which was built by Messrs. R. Napier, on the Clyde, in 1880. She was 440 feet long, 46 feet broad, 33 feet deep, and of 5,365 tons. The engines, also by Napier, were compound three-cylinder three-crank type, the diameter of the high-pressure 60 inches, and of each of the low 85 inches, with a stroke of 5 feet, and boiler pressure of 80 lbs. Since the advent of this vessel many steamers of the cargo type have been added to the Allan Line to supply the demands of their extensive services spreading over the globe, but none for the express passenger trade, so that practically the Canadian mail and passenger service has not advanced since 1881. In 1888 a contract was entered into by the Orient Line, of London, with the Canadian Government, to commence a superior service with a guaranteed mean speed of 18 knots; this, however, has fallen through. Unlike the other lines the proprietary of this Company has undergone no change, but still remains a private concern, being about the only private Atlantic steamship line left. That the Canadian Government is still determined not to rest content is evident by the rumours occasionally heard of a high-speed service, the latest, in March, 1891, being, that a few influential gentlemen are promoting a high-speed service to be placed under the management of the Allan Line.

## CHAPTER IV.

### THE GALWAY, NATIONAL, AND GUION LINES.

IN 1857 a line was organized to trade between Galway (Ireland) and St. John's, Newfoundland, the shortest ocean route between this country and America; it commenced in June, 1858, with a subsidy from the Government for carrying the mails. As the steamers were not up to the standard as regards speed and power, the service was conducted with great irregularity and was eventually given up in 1861.

In August, 1863, a line was commenced from Liverpool, making Galway the final port of call, with a subsidy from Government of £75,000 per annum; it lasted, however, only a short time, being finally given up in January, 1864.

In 1863 the next line was established by some Liverpool merchants with three steamers named the *Louisiana*,<sup>1</sup> *Virginia*, and *Pennsylvania*, under the name of the National Steam Navigation Company, but it was not until the latter end of 1864—when the Company was reorganized under the name of the National Steamship Company—that this line became a paying one. Since that period it has carried on a regular trade, but its performances have not proved remarkable, for, although

<sup>1</sup> Afterwards called the *Holland* (see next page).

CHAP. IV.

the vessel  
tremely s  
rank am  
cessful, a  
passenger  
trade, ves  
York at r

To this  
duced the  
*Holland* ha  
1869, by M  
addition o  
meter, pla  
original lo  
diameter,  
60 lbs.

The mos  
upon the  
namely, the  
broad, 36 f  
and built o  
their altere  
firm, were c  
crank type,  
and each of  
5½ feet, and  
vessel was  
departure sh  
specially ref  
fictive new



the vessels are large and strongly built, they are extremely slow. Notwithstanding that their vessels do not rank among the swift class, they have been fairly successful, and have carried large numbers of steerage passengers. Besides their Liverpool and New York trade, vessels of this line also sail from London to New York at regular intervals.

To this line belongs the honour of having first introduced the compound engines to the Atlantic trade, the *Holland* having had her original engines compounded in 1869, by Messrs. J. Jack and Co., of Liverpool, by the addition of a high-pressure cylinder 46 inches diameter, placed tandem fashion on the top of each of the original low-pressure cylinders, which were 86 inches diameter, the stroke being 4 feet, and boiler pressure 60 lbs.

The most remarkable vessel of recent years placed upon the Atlantic was brought out by this Company, namely, the high-speed *America* of 432 feet long, 51½ feet broad, 36 feet deep, and 5,528 tons. She was designed and built of steel, by Messrs. J. and G. Thomson, on their altered proportions; the engines, also by the same firm, were of the usual three-cylinder compound three-crank type, the high-pressure diameter being 63 inches, and each of the low-pressure 91 inches, with a stroke of 5½ feet, and boiler pressure 95 lbs. The advent of this vessel was much commented upon, owing to the new departure she represented, as the Company had hitherto specially refrained from the Express Service. A distinctive new feature in her arrangements was a hand-

some dome over the saloon, which gives it an airy and lofty appearance. It has since been imitated in the *Inman City of New York* and *City of Paris* (see p. 165).

The *America* being driven at a very high speed on considerably less consumption, namely 190 tons per day, than the other "record breakers," soon took front rank. Her general appearance differed from the then prevailing type, there being only two masts and two very lofty elliptic funnels. Notwithstanding that she succeeded in breaking the record in June, 1884, by a passage homeward of 6 days, 14 hours, 18 minutes, she was sold in 1886 to the Italian Government, owing to an alteration having been effected in the management of the Company, which felt reluctant to enter into such an expensive and restless competition.

Just three years after the National Line commenced, the managers of one of the then noted fleet of emigrant sailing vessels known as the Black Star Line, seeing that the steamships were drawing all the passenger trade, inaugurated the now well-known Guion Line, the founders being Messrs. Williams and Guion, the former representing the line in New York, and the latter in Liverpool. They commenced in 1866, the first vessel being named the *Manhattan*, an iron screw-propelled vessel, 335 feet long, 42½ feet broad, 28 feet deep, and of 2,869 tons, having low pressure inverted direct-acting surface-condensing engines, with cylinders 60 inches diameter, and 3½ feet stroke. This vessel and her machinery were built by Messrs. Palmer, at Jarrow on the Tyne, and was followed by the *Minnesota*, Nevada,

CHAP. IV.

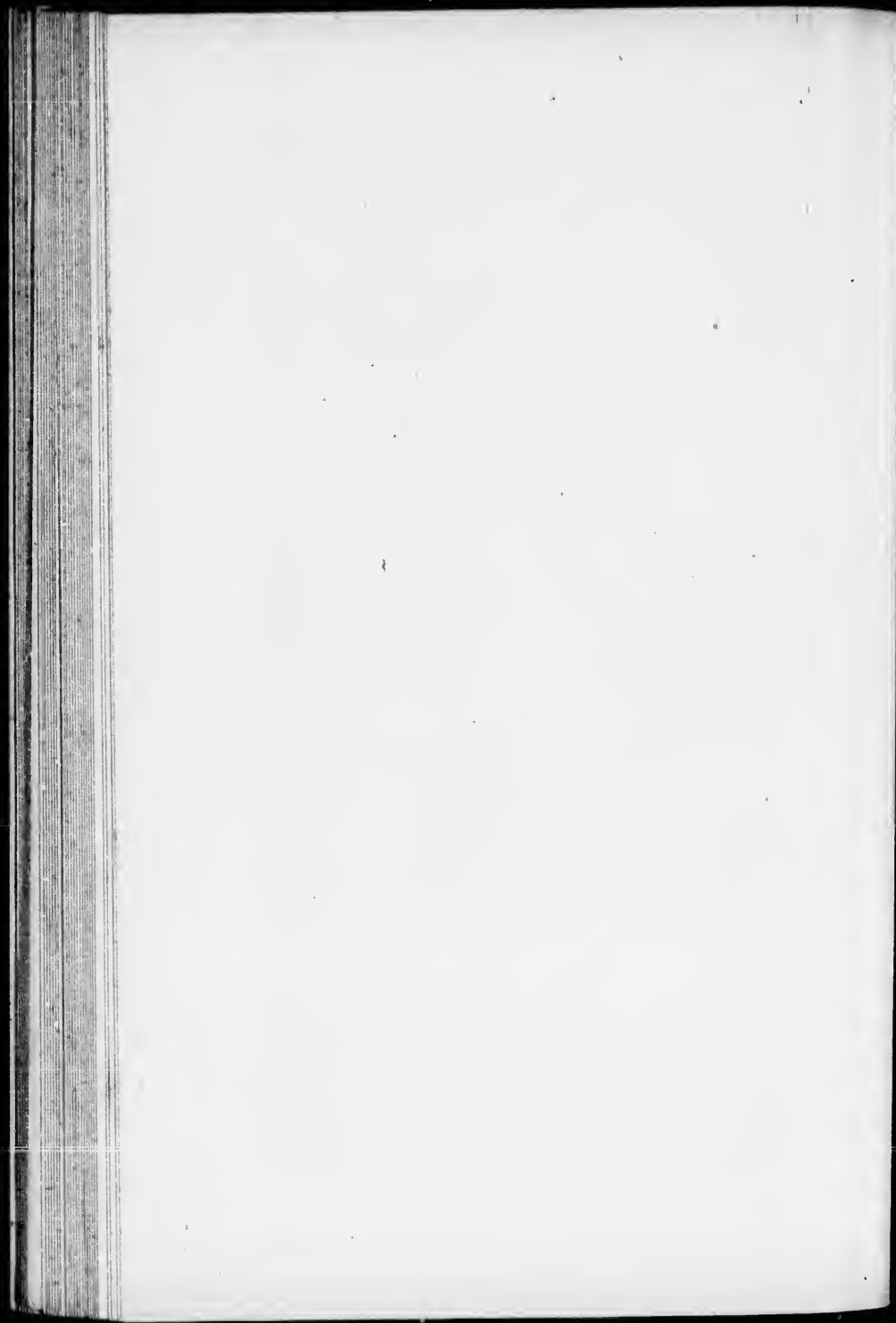
iry and  
in the  
(1865).

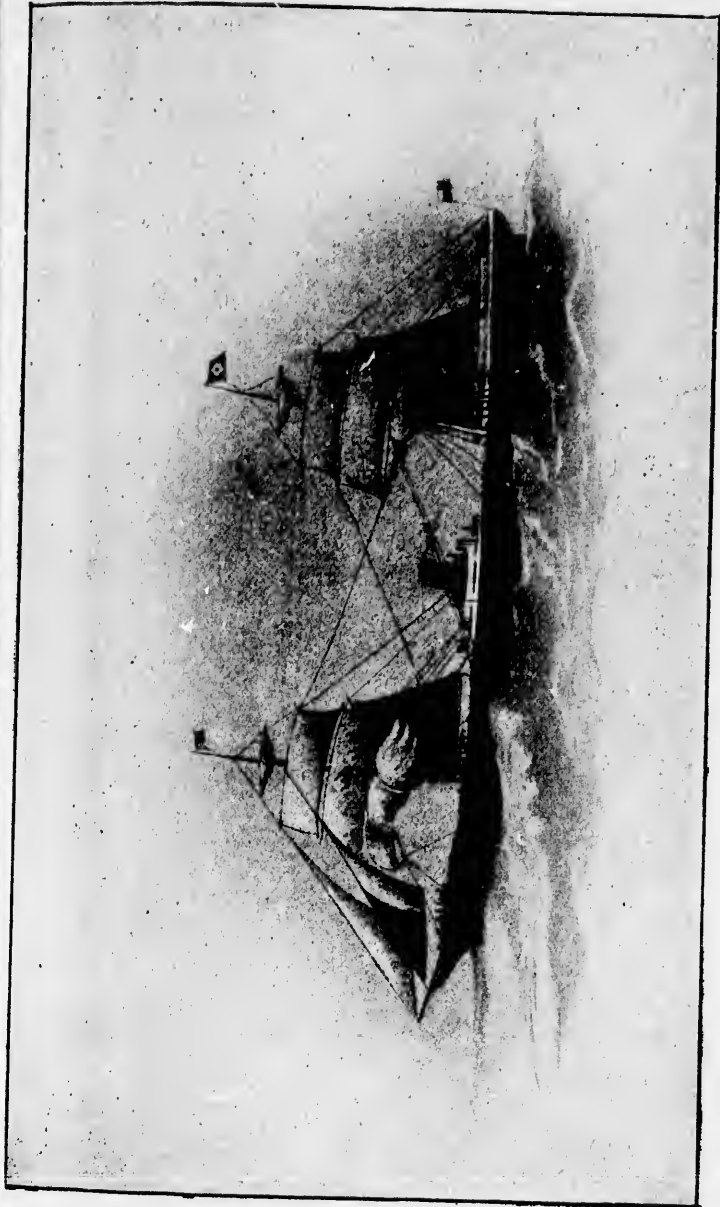
on con-  
er day,  
at rank.  
prevail-  
ry lofty  
ceeded  
e home-  
sold in  
teration  
mpany,  
ive and

menced,  
migrant  
ing that  
r trade,  
ne, the  
e former  
e latter  
st vessel  
ropelled  
eep, and  
direct-  
ders 60  
essel and  
Jarow  
Nevada,



THE AMERICA (1884). NATIONAL LINE.





MANHATTAN (1866). FIRST STEAMER, GUION LINE.

**Idaho**, and others; and later on, in 1870, by the now well-known **Wyoming** and **Wisconsin**, iron vessels built and engined by Messrs. Palmer, each being 366 feet long,  $43\frac{1}{2}$  feet broad, 34 feet deep, and of 3,238 tons. The engines were amongst the first compound type in the Atlantic trade, with one vertical high-pressure cylinder 60 inches diameter, and one double trunk horizontal low-pressure of 120 inches diameter, both working on the same crank, the stroke being  $3\frac{1}{2}$  feet, and having Corliss valves; these engines and original boilers, carrying 70 lbs. pressure, are still at work in 1892.

Some time afterwards, in 1872, two strange vessels named the **Montana** and **Dakota**, of entirely different design, both in hull and machinery, from the then existing type of Atlantic steamers, were brought out. Their dimensions were  $400\frac{1}{2}$  feet long,  $43\frac{3}{4}$  feet broad,  $40\frac{3}{4}$  feet deep; the engines were compound,<sup>1</sup> one high-pressure, working inverted, of 60 inches diameter, on a forward crank, and two low-pressure, working horizontal, on after crank, each 113 inches diameter, with a stroke of  $3\frac{1}{2}$  feet, and having Corliss valves. The first boilers (carrying 100 lbs.) of the **Montana** were constructed on the principle of a series of cross tubes, 15 inches diameter, but these failed with loss of life, and were replaced by ordinary tubular boilers, carrying 80 lbs., before she commenced sailing. Although specially built to lead the van on the Atlantic highway, neither of these vessels succeeded in "breaking the record," and were both

<sup>1</sup> See illustration in the chapter on machinery.

afterwards  
**Montana** in  
within a few  
years another  
forward by  
engined by  
measured 4  
and 5,164 t  
design to th  
shafts, each  
inches diam  
each of 90  
were seven  
thirty-nine  
125 tons, o  
vessels, Brit  
she succeeded  
ward passag  
1879.<sup>1</sup> The  
simply a co  
been all the  
various Line  
Soon after  
passages, thi  
ing a feat hi  
full speed int  
to tell the tal  
month of Nov  
resulted in h

<sup>1</sup> T

afterwards wrecked, the **Dakota** in May, 1877, and the **Montana** in March, 1880, at places on the Welsh coast within a few miles of each other. After an interval of seven years another splendid vessel, the **Arizona**, was brought forward by the Guion Line. She was of iron, built and engined by Messrs. John Elder and Co., Glasgow, and measured 450 feet long,  $45\frac{1}{3}$  feet broad,  $35\frac{3}{4}$  feet deep, and 5,164 tons. Her machinery was of completely new design to this trade, being compound with three crankshafts, each having one cylinder, the high-pressure, of 62 inches diameter, being in the centre, and the low-pressures each of 90 inches, with a stroke of  $5\frac{1}{2}$  feet. There were seven boilers carrying 90 lbs. pressure and having thirty-nine furnaces; the consumption per day averaging 125 tons, or about 25 per cent. more than the fastest vessels, **Britannic** and **Germanic**, then existing. These she succeeded in surpassing by making the fastest outward passage in May, 1880, and homeward in July, 1879.<sup>1</sup> The general design, excepting machinery, was simply a copy of these two noted vessels, as have been all the other fine vessels since brought out by the various Lines.

Soon after the **Arizona** had become noted for her rapid passages, this fine vessel became more famous by performing a feat hitherto thought impossible, namely, running full speed into a huge iceberg and then returning to port to tell the tale; this remarkable episode occurred in the month of November, 1879, on a homeward passage, and resulted in her putting into St. John's, Newfoundland,

<sup>1</sup> This has since been reversed, see p. 90.



with her bow completely smashed and crumpled up almost to the collision bulkhead, which did good service by remaining intact. Beyond the delay and the heavy cost of rebuilding a new bow, this mishap caused no injury to the vessel or the line, but, on the contrary, so proved the excellent construction of the hull that she has since continued to be well patronized.

In consequence of the success of the **Arizona**, another iron steamer, the **Alaska**, built by the same firm, of similar type, but of somewhat larger dimensions and machinery, was put into commission early in 1882, and under the pseudonym of the "Atlantic greyhound" at once became famous by making the "fastest passage," and eventually became the first to reduce the passage to less than seven days in June, 1882.

The last vessel to be added to the Guion fleet was the **Oregon** (already briefly noticed in the Cunard Line); this magnificent vessel, which first sailed under the Guion flag, was of iron, and was built and engined by Messrs. Elder on the same design as the two preceding vessels, but of increased size, her dimensions being 500 feet long, 54 feet broad, 40 feet deep, and 7,375 tons. The compound engines were magnificent specimens of marine engineering; they consisted of one high-pressure cylinder 70 inches diameter, placed in the centre, and two low-pressure, each 104 inches diameter, with 6 feet stroke, the boiler pressure being 110 lbs. and consumption about 310 tons per day. Only a brief time elapsed after the first voyage, on which she sailed, on October 7th, 1883, before she became noted for her passages, and eventually,



MAP. IV.

led up  
service  
vy cost  
injury  
proved  
s since

another  
firm, of  
ns and  
82, and  
nd" at  
assage,"  
passage

was the  
e); this  
e Guion  
Messrs.  
vessels,  
et long,  
he com-  
marine  
cylinder  
two low-  
t stroke,  
on about  
after the  
th, 1883,  
eventually,



THE OREGON (1883). GUION AND CUNARD LINES.

in August, 1884, reduced the time of crossing the Atlantic to less than 6½ days. Notwithstanding her magnificent performance with the "red capped" funnel, she was, for financial reasons, transferred to the Cunard Line in June, 1884, and, as already related, was sunk by a collision.

After many years of successful and satisfactory working under the original founders, the organization was turned into a private limited company in 1883, and after the death of Mr. S. B. Guion, which occurred in December, 1885, was changed into a public one in the November of 1886, under the name of "The Liverpool and Great Western Steamship Company, Limited."

OWING to  
formation  
Transatlant  
for extensio  
the formatio  
Limited, be  
now stands  
ship compar  
following a  
Post," Marc  
of the nam  
proposed the

"WHITE

"The new  
Oceanic, Balti

"Sailing  
at Queenstow  
"Will sail

<sup>1</sup> These names  
being substitute

Atlantic  
nificant  
e was,  
d Line  
k by a

factory  
ization  
83, and  
rred in  
in the  
iverpool  
l."

## CHAPTER V.

### WHITE STAR LINE.

OWING to the long period which elapsed after the formation of the Guion Line, it was thought that the Transatlantic trade had ceased to be a further field for extension, but in 1870 this illusion was dispelled by the formation of the Oceanic Steam Navigation Company, Limited, better known as the White Star Line, which now stands pre-eminently at the head of the great steamship companies of the globe. It was announced by the following advertisement from the "Liverpool Daily Post," March 1, 1871, in which it may be noticed some of the names formerly used by the Collins Line were proposed though they were not adopted.

"WHITE STAR LINE, OCEANIC STEAM NAVIGATION  
COMPANY, LIMITED.

"The new first-class full-powered screw steamships  
Oceanic, Baltic, Atlantic, Pacific,<sup>1</sup> Arctic,<sup>1</sup> Adriatic.

"Sailing on Thursdays from Liverpool, and calling  
at Queenstown on Fridays to embark passengers.

"Will sail as under for New York, via Queenstown.

<sup>1</sup> These names were not adopted, those of **Republic** and **Celtic** being substituted for them.

Oceanic, 4,500 tons, 3,000 horse-power, Captain Digby Murray, to sail to-morrow, Thursday, March 2nd, 1871.

"These steamships have been designed to afford the very best accommodation to all classes of passengers, and are expected to accomplish quick and regular passages between this country and America.

"The state-rooms, with saloon and smoking-rooms, are placed amidships, and cabin passengers are thus removed from the noise and motion experienced at the after part of the vessel.

"Passengers are booked to all parts of the States, Canada, and Newfoundland, Nova Scotia, India, etc., at moderate through rates. A surgeon and stewardess carried on each ship. Drafts issued at New York for sums not exceeding £10, free.

"Parcels will be received at the Company's offices until 6 P.M. of the day before sailing.

"Bills of lading to be had from Messrs. Benson and Holme, and Mawdsley and Son. Shipping notes at the Company's office. Loading berth, S.W. corner Bramley Moore Dock.

"Saloon passage, £18 18s. and £16 16s.; return ticket, 27 guineas. Steerage as low as by any other first-class line.

"Rates of freight, etc., may be obtained by applying to J. H. Sparks, at the Company's offices, 19, Broadway, New York; in Belfast, to Samuel Gowan and Co., 4, Corporation Street, or to

"ISMAI, INRIE AND Co.,  
 "7, East India Avenue, or 10, Water Street,  
 "London, E.C., Liverpool."

This Company, like some of the others on the Atlantic, was an offshoot of one of the sailing clipper lines of former years, namely the "White Star."

This sailing fleet having come under the management of Mr. T. H. Ismay in 1867, and he having already had

CHAP. V.

a Digby  
1, 1871.  
ford the  
engers,  
lar pas-

y-rooms,  
thus re-  
the after

States,  
, etc., at  
ewardess  
York for

s offices

son and  
es at the  
Bramley

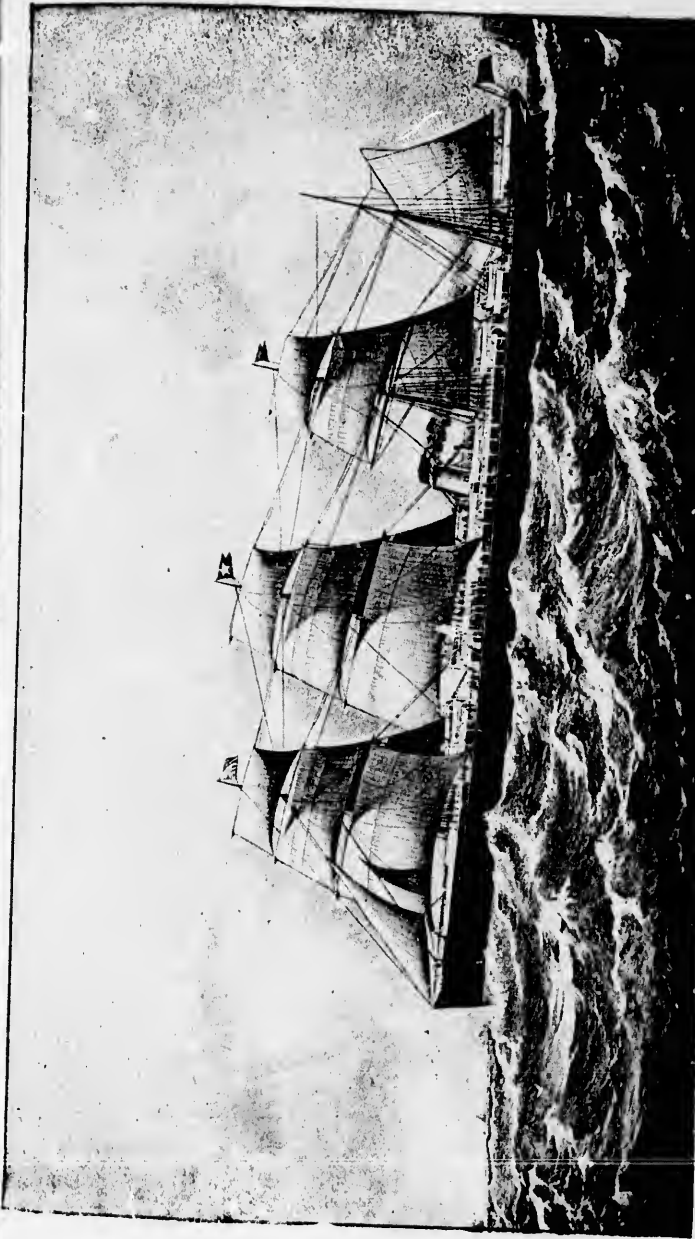
; return  
ny other

plying to  
roadway,  
and Co.,

treet,  
verpool."

Atlantic,  
lines of

agement  
ready had



THE OCEANIC (1871). FIRST STEAMER OF WHITE STAR LINE.

some experience of steamships as director of the National Line, already noticed, conceived the idea of establishing a first-class passenger line across the Atlantic with a fleet of steamers in every way superior to anything then in existence, a scheme which was by this time ripe for carrying out, owing to the radical improvements in design of hull and interior arrangements which were by this time being brought forward, mainly by Messrs. Harland and Wolff, of Belfast.

Being substantially supported by several influential shipping men, Mr. Ismay, in 1869, entered into negotiations with the Belfast firm to build steamers of the latest and most modern type, and in 1870 he was joined by Mr. William Imrie, who had been previously a fellow apprentice of his.

In February, 1871, their first steamer, the famous **Oceanic** first appeared upon the Mersey from Belfast; her dimensions being 420 feet long, 41 feet broad, 31 feet deep, and her capacity 3,601 tons.

This vessel will long be remembered as the pioneer of those improvements which, since her advent, have made travelling by ocean steamers so thoroughly comfortable and luxurious. The curiosity of every one connected with nautical matters was thoroughly aroused by the way in which the then existing theories and designs of steamships were in this new craft set aside. Instead of the usual high bulwarks and narrow wooden deck-houses, another iron deck was added, with open iron railings for bulwarks, so as to allow the water to come and go on deck; the saloon was placed amidships, and extended



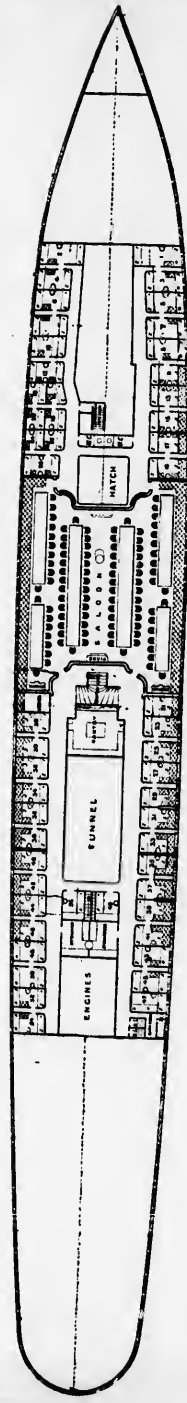
of the  
idea of  
ross the  
superior to  
by this  
improve-  
ts which  
ainly by

fluential  
negotia-  
of the  
as joined  
a fellow

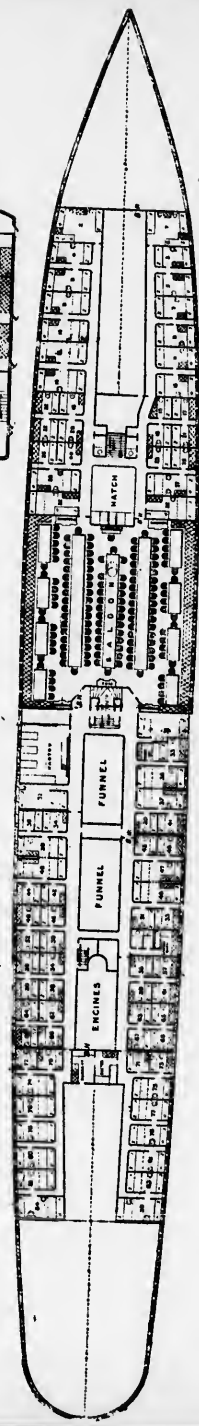
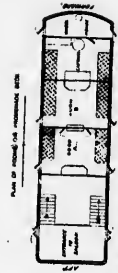
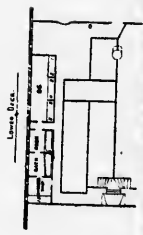
famous  
ast; her  
31 feet

pioneer  
nt, have  
hly com-  
one con-  
oused by  
d designs

Instead  
en deck-  
iron rail-  
ne and go  
extended



DECK PLAN OF SS. OCEANIC.  
(The first Atlantic Steamer with a midship saloon.)



DECK PLAN OF THE BRITANNIC AND GERMANIC.  
(Showing the saloon accommodation.)



CHAP. V.]

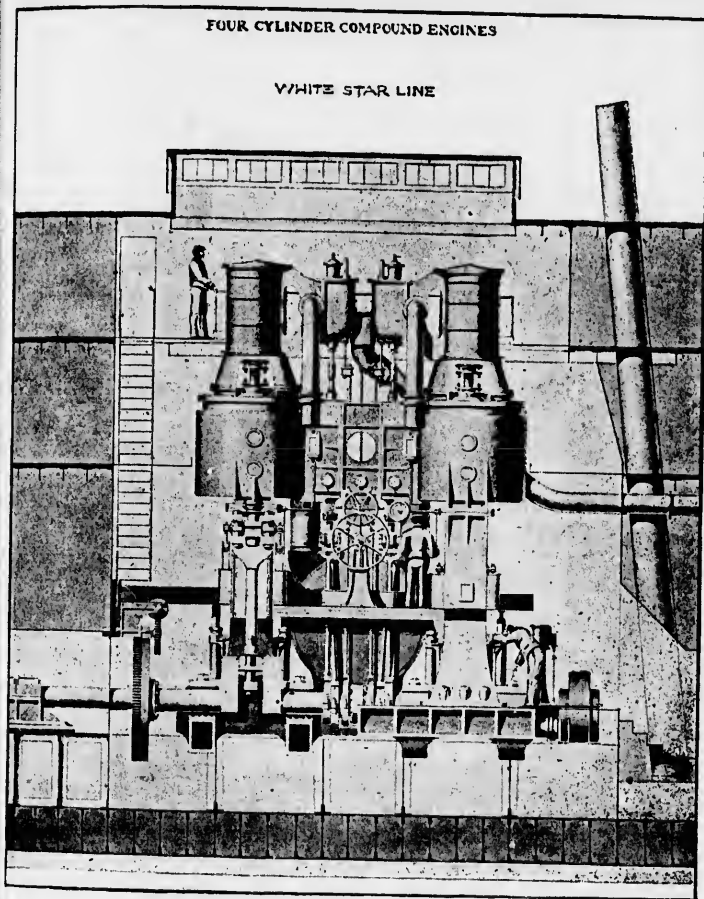
the entire  
the saloon



along both s  
twice as lar

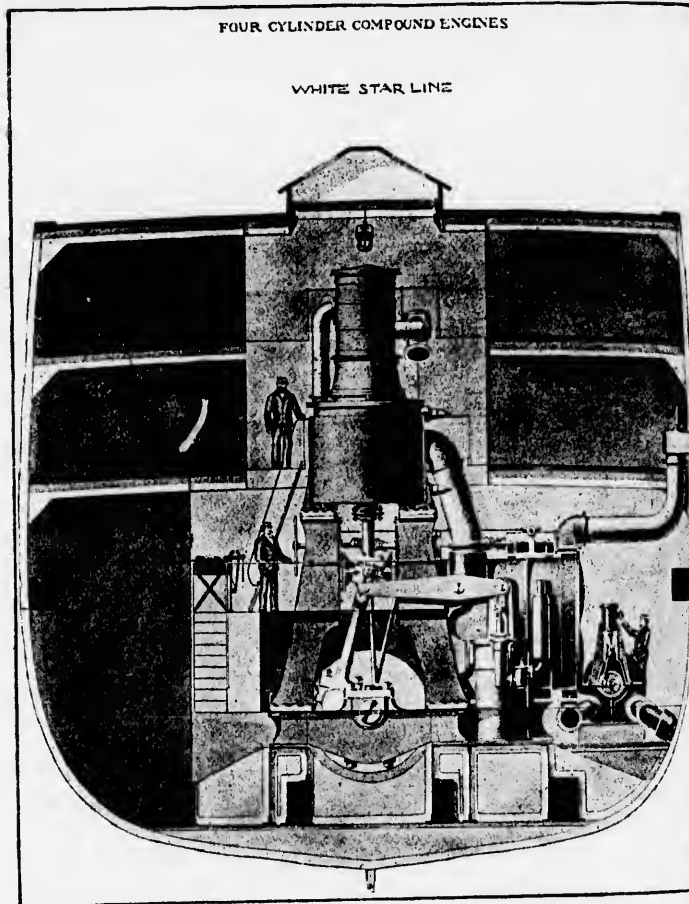


the entire width of the vessel ; both forward and aft of the saloon the numerous state-rooms were arranged



along both sides, and as all the side lights were about twice as large as any previously fitted to Atlantic

steamers, the light and airy appearance of the interior soon took the attention of Atlantic passengers. The



ENGINES OF THE OCEANIC. THWARTSHIP VIEW.

engines also were objects of much attention; they were compound four cylinders, with two high-pressure, each

41 inches inches, wo feet, so th a complete resource in sure was ge furnaces, an average spee Maudslay, S self soon s fears of th her to be un The *Oceanic* type, and a regularity a famous.

In 1872 th and homewa markably su namely, the long, 45 feet was built of engines, by M compound, ta high-pressure and the low e at 75 lbs. pre boilers, havin averaged abo over 16 knot

41 inches diameter, and two low-pressure, each 78 inches, working on two cranks with a stroke of 5 feet, so that each engine (forward and aft) formed a complete engine in itself, thus forming a double resource in case of breakdown; steam at 65 lbs. pressure was generated in twelve boilers having twenty-four furnaces, and consuming about 65 tons per day with an average speed of  $14\frac{1}{2}$  knots. These engines, which were by Maudslay, Sons, and Field, London, like the vessel herself soon satisfied the doubts of all, and allayed the fears of those old "salts" who so confidently declared her to be unfit to face the heavy weather of the Atlantic. The **Oceanic** was followed by other vessels of the same type, and as the service was conducted with great regularity and unprecedented speed they soon became famous.

In 1872 these vessels made the fastest passage outward and homeward, and in 1874 and 1875 two of the most remarkably successful steamers ever built were brought out, namely, the **Britannic** and **Germanic**; each was 455 feet long, 45 feet broad,  $33\frac{3}{4}$  feet deep, and of 5,004 tons, and was built of iron by Messrs. Harland and Wolff. The engines, by Maudslay, Sons, and Field, were two crank compound, tandem type, similar to those of the **Oceanic**, the high-pressure cylinders being each 48 inches diameter, and the low each 83 inches, with a stroke of 5 feet. Steam at 75 lbs. pressure was generated in eight double-ended boilers, having thirty-two furnaces, and the consumption averaged about 110 tons per day, with a speed slightly over 16 knots. These vessels were the first to reduce

e interior  
ers. The



w.  
they were  
sure, each

the passage to less than  $7\frac{1}{2}$  days; their splendid performances have attracted world-wide attention, and although they are now eighteen years old, they still retain their place on the Express Transatlantic Service, sailing every fourth week from each port, and having the original engines and boilers.

Many comments have from time to time been made by the scientific and shipping press upon the performances of these twin vessels, which since their advent have been the basis for the design and arrangements of all the successful passenger steamers since built for any trade.

Commenting upon their excellent doings, "The Engineer" of October 31st, 1884, one of the leading scientific papers, contains the following article, which is interesting, as showing the cost of high speed :

*"Old and New Atlantic Steamers.*—In June of last year we gave some interesting particulars of the relative performance of the **Alaska**, **Servia**, and **Britannic**, showing the results given by each steamer after crossing the Atlantic almost in company with each other.

"During the present month the **Britannic** has again been crossing about the same time with the two latest additions to the Atlantic fleets, namely, the **Oregon** and **America**, and gives us another opportunity of analysing the relative merits of the 'Old and New Atlantic Steamers.'

"The **Oregon** and **America** both left New York on Wednesday, the 8th of October, and both arrived at Queenstown on the 15th following, the **Oregon** running a distance of 2,819 knots, occupying 6 days, 12 hours, 37 minutes, which gives a speed of 18.01 knots per hour; the **America** running a distance of 2,777 knots, occupying 6 days, 17 hours, 43 minutes, a speed of 17.14 knots; the

[CHAP. V.

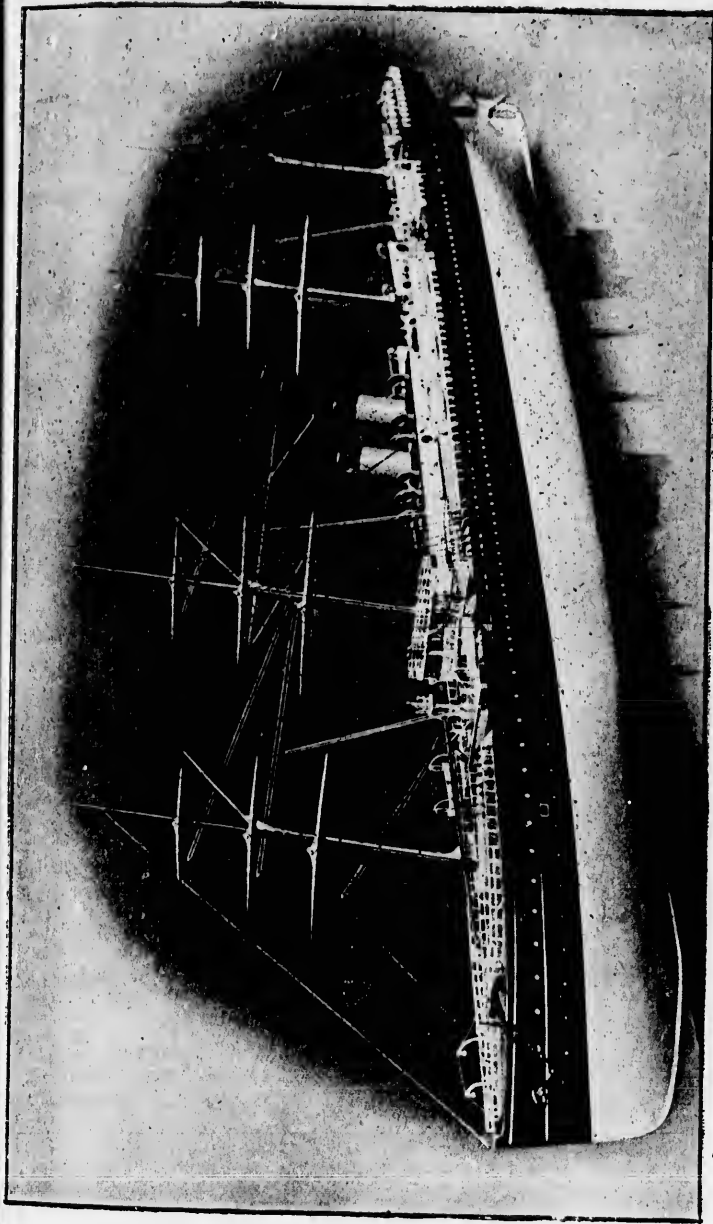
did per-  
, and al-  
will retain  
e, sailing  
e original

made by  
ormances  
have been  
f all the  
y trade.  
The Engi-  
scientific  
interesting,

F last year  
ative per-  
, showing  
ssing the

has again  
two latest  
regon and  
analysing  
y Atlantic

y York on  
arrived at  
running a  
hours, 37  
per hour;  
occupying  
knots; the



BRITANNIC (1874) AND GERMANIC (1875). FROM A MODEL.

**Britannic** left New York on October 11th, and arrived at Queenstown on October 19th, after running a distance of 2,852 knots in 7 days, 12 hours, 17 minutes, which gives a mean average speed of 15·85 knots, thus occupying, say, one day longer than the **Oregon**, and about 18½ hours longer than the **America**.

“By these figures it will be seen that in a period of ten years a gain of one day has been obtained in crossing the Atlantic; and assuming that the consumption of each ship was, respectively, 265, 185, and 100 tons per day, to gain this one day the **Oregon** burned about 1,656 tons, and the **America** about 1,174 tons on the passage home, whereas the **Britannic** burned only 750 tons.

“If we then consider that, in the case of the steamer **Oregon**, it was necessary to burn 906 tons to gain 24 hours, and in the case of the **America**, 424 tons to gain 18½ hours on the **Britannic**, it may well be asked, ‘Do the New steamers yield the same efficiency as the Old?’

“Looking at the wonderful performances of the **Britannic**, and her sister ship the **Germanic**, during the past ten years, it seems as if they yet could be made to compare with the newer rivals in speed by increasing the power of their machinery in but a moderate degree, as it is plainly evident that their superior model serves them in good stead; and, considering that the **Britannic**'s last homeward passage is (if we are not mistaken) the fastest she ever made, the strength of hull would be amply sufficient to allow of the increased power being supplied, which the extensive use of steel would permit, to suit the existing portions of the ship.

“When, then (as we stated in our former article), the boilers of these steamers require renewal, it should, in our opinion, be seriously weighed, whether or not it is advisable to replace the existing machinery (excellent though it be) with either triple expansion or ordinary compound engines of such power as to increase the speed to 18 knots.

“In ord  
much it r  
showing  
interest :

**Oregon .**  
**America .**  
**Britannic**

Again, o  
of Commer  
their doing

“ AN

“ We ha  
the singul  
Company's  
sults attain  
tory of ste  
ocean stean  
still do goo  
but it is al  
to the less  
maintain th  
age experie  
or twelve  
then usual  
them, or se  
in the ligh  
record of  
vessels is s  
without pr  
White Star  
Mersey on  
York. She



“ In order to place more clearly before our readers how much it requires to obtain so little, the following table showing the relative horse-powers, etc., will be of interest :

	Fastest passage. d. h. m.	I.H.P.	Consump- tion.	Tonnage.	Speed.
<b>Oregon</b> .	6 12 27	13,000	265 tons	7,250	18 knots.
<b>America</b> .	6 17 43	9,800	185 „	5,530	17.1 „
<b>Britannic</b>	7 12 17	4,900	100 „	5,004	15.8 „

Again, on September 6th, 1890, the “ Liverpool Journal of Commerce ” contained the following further history of their doings in an article headed :

“ AN UNPRECEDENTED RECORD—THE BRITANNIC.

“ We have on previous occasions drawn attention to the singular performances of many of the White Star Company’s vessels. We say ‘singular’ because the results attained are absolutely without parallel in the history of steam shipping. We could mention many fine ocean steamers belonging to the various companies which still do good work after some ten or fifteen years’ service, but it is always the case that such vessels are relegated to the less important routes owing to their inability to maintain the requisite speed. In fact, taking the average experience with ocean steamers, it is found that in ten or twelve years’ time they become obsolete, and it is then usually a question of re-engineering and re-boiling them, or selling them out of the fleet. Looked at, then, in the light of the average steamship capability, the record of some of the earlier White Star Company’s vessels is simply marvellous, and, as we say, altogether without precedent. We have before us the log of the White Star mail steamer **Britannic**, which arrived in the Mersey on Thursday evening, September 4th, from New York. She left New York at 9.35 p.m. (Greenwich mean

time) on Wednesday in last week, and arrived at Queens-  
town at 4.30 a.m. on Thursday, the 4th instant, thus  
completing her 318th Transatlantic passage in 7 days,  
6 hours, 55 minutes, the fastest time she has yet made.  
The following is her log:

August 28	.	.	292 knots.	
" 29	.	.	372	"
" 30	.	.	377	"
" 31	.	.	370	"
Sept. 1	.	.	376	"
" 2	.	.	377	"
" 3	.	.	387	"
—	—	.	261	" to Queenstown.

Total . 2,812 knots,

or an average speed of 16.08 knots per hour. Fine  
weather prevailed during the passage. The **Britannic's**  
previous best performance was in March, 1888, when she  
crossed from Sandy Hook to Queenstown in 7 days,  
9 hours, 30 minutes, which was regarded as sufficiently  
remarkable. But when it is remembered that this high  
speed, averaging over 16 knots per hour throughout, or  
nearly 19 statute miles, is obtained in a ship of over  
sixteen years old, with her original compound engines  
and boilers, on a small coal consumption, and with  
her large carrying capacity, it will be seen that the  
**Britannic** has been so constructed as to give results un-  
attainable with the fastest ships of the present day, and  
actually increases in speed as she grows older, reversing  
the usual experience. It is worthy of mention that  
in ten voyages performed during 1888 the **Britannic**  
averaged 7 days, 15 hours, 57 minutes, whilst her sister  
ship, the **Germanic**, during 1889 made thirteen voyages  
averaging 7 days, 15 hours, 21 minutes, showing a  
wonderful uniformity in the speed of these twin vessels.  
The **Britannic** and **Germanic** were built in 1874, by  
Messrs. Harland and Wolff, Belfast, and engined by

Messrs. M  
being a r  
question  
nificant p  
that, in o  
the shape  
in dry do  
compare t  
and comp  
not have  
extreme fi  
long and  
are featur  
most other  
boats and  
Scott-Russ  
great relat  
hull have  
the talent  
Harland, v  
economical  
on the Atl  
done, unlin  
is, howeve  
cially succ  
there is no  
its construc  
Those who  
can certain  
instance in  
been the sp  
and anothe  
owners hav  
highest sta  
this end. I  
their splen  
tains, engin  
Nothing exc



Messrs. Maudslay, Sons, and Field, London, the engines being a remarkably fine set of tandem compounds. The question may be asked to what do we attribute the magnificent performances of these vessels? We can only say that, in our opinion, a very great deal is to be credited to the shape of the hull. When any of our great liners are in dry dock we make it a point to inspect them, and compare the different lines. Anyone who has done this, and compared the **Britannic** with other crack boats, cannot have failed to notice very great differences. The extreme fineness of entrance, the absence of forefoot, the long and full midship section, and the graceful run aft are features of these boats more pronounced than in most others. Again, a glance at the proportions of these boats and the results achieved prove the soundness of Scott-Russells' theory that to obtain speed we must have great relative length. These points in the design of the hull have been so carefully and judiciously considered by the talented designer of the White Star boats, Sir E. J. Harland, with the result that they are among the most economical as regards coal consumption of any vessels on the Atlantic. Of course we can put, as is sometimes done, unlimited power into a vessel and drive her. This, is, however, not scientific, and therefore not commercially successful. In the machinery of these vessels there is nothing very special, except that at the date of its construction it represented the best marine practice. Those who believe in 'good iron' for ships and engines can certainly point to the **Germanic** and **Britannic** as an instance in point. Another very important factor has been the splendid workmanship put into these vessels, and another equally important factor is that the owners have a name for keeping their vessels in the highest state of efficiency, no expense being spared to this end. Lastly, Messrs. Ismay, Imrie, and Co., entrust their splendid vessels only to the very best men, as captains, engineers, and officers, that they can procure. Nothing except faithful service rendered, work honestly

and carefully performed, could achieve these astonishing results. The company pay the highest wages, and so obtain the best service."<sup>1</sup>

It is to the White Star Line that the public are in a great measure indebted for the rapid advance in marine architecture and engineering during the last twenty years, owing to the energetic and judicious way in which it has brought out and developed the improvements now so extensively adopted.

Amongst the most important of these the following may be mentioned, namely :

Introduction of the improved relative proportions of length, breadth, and depth.

Placing of saloon and passenger accommodation amidships.

Adoption of electric bells on board ship.

Providing separate chairs in saloon for each individual.

Self-acting water-tight doors.

Improved bulkhead division, and carrying them up to proper height.

Introduction of bridal chambers, as in this age of rapid transit a trip across the Atlantic is not too extensive for a honeymoon.

Adoption of Maury's Lane routes.

<sup>1</sup> Since this was written both these vessels have eclipsed their best performances. The **Britannic** in August, 1891, when nearly eighteen years old, having made the passage, New York to Queens-town, in 7 days, 6 hours, 52 minutes, and the **Germanic**, seventeen years old, in the same month (August, 1891), made the same passage in 7 days, 7 hours, 37 minutes.

Overla  
Better  
of the ca



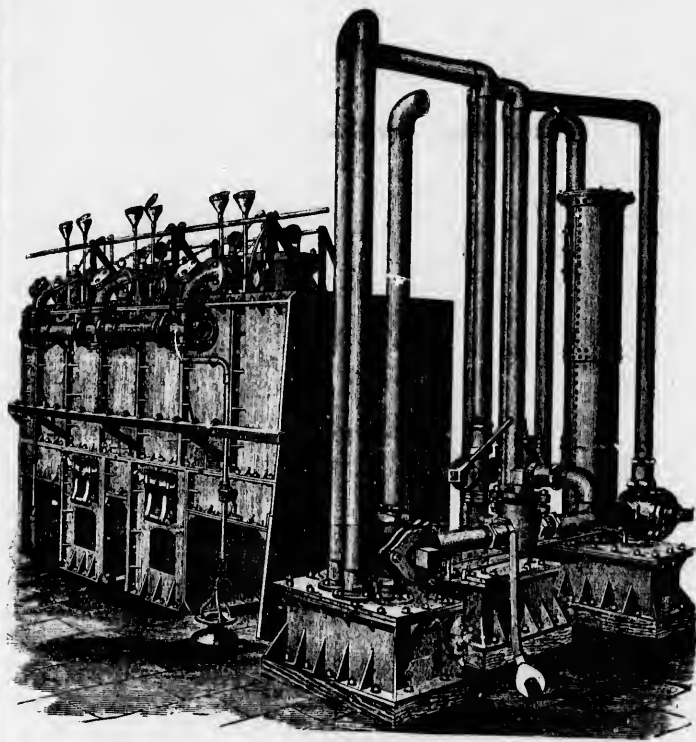
GASWO

sperm oil  
and comm

The syst  
so widely a  
the gas be

Overlapping twin screw propellers.

Better system of lighting throughout by the replacing of the candle system in 1872-3 with superior mineral



GASWORKS FITTED ON WHITE STAR LINE CELTIC, 1872.

sperm oil lamps, followed afterwards by an elaborate and commendable attempt to adopt gas lighting.

The system of gas supply was somewhat like that now so widely adopted for the lighting of railway carriages, the gas being made from vaporized oil, by an ingenious

apparatus, which was placed just off the engine room, and occupied about 1,600 cubic feet of space.

This was designed and manufactured by Messrs. Porter and Co., of Lincoln, the first steamer fitted being the **Adriatic** in 1872, followed afterwards by the **Celtic** in 1873. The general effect in the saloon, where there were thirty jets, and in the emigrant accommodation when the whole was lit up, was much admired, being a marked contrast to the candles then customary. Considerable trouble was, however, given by failure of the pipes through the working of the ship at sea, and other causes, allowing leakage, and it was eventually abandoned for the mineral oil lamps.

Another attempt to surmount the trials of the "rolling forties" was the adoption of oscillating state-rooms and berths to counteract the motion in a sea-way, but this, like the more colossal experiment afterwards made on the **Bessemer**, was abandoned, being utterly ineffectual.<sup>1</sup>

An important effort to advance further afield in marine engineering was made by the adoption on the **Britannic** of a system of raising and lowering the propeller, so that the shaft could be lowered when in deep water till it almost touched the keel, and so allow the propeller to work in more solid water, and be less liable to race when pitching in a heavy sea. To attain this object very great alterations had to be made in the arrangement of the stern, so as to allow of a hollow recess in the

<sup>1</sup> The oscillating saloon of the **Bessemer** was 70 feet long by 30 feet broad and 20 feet high. The vessel cost £20,000, but was a total failure.



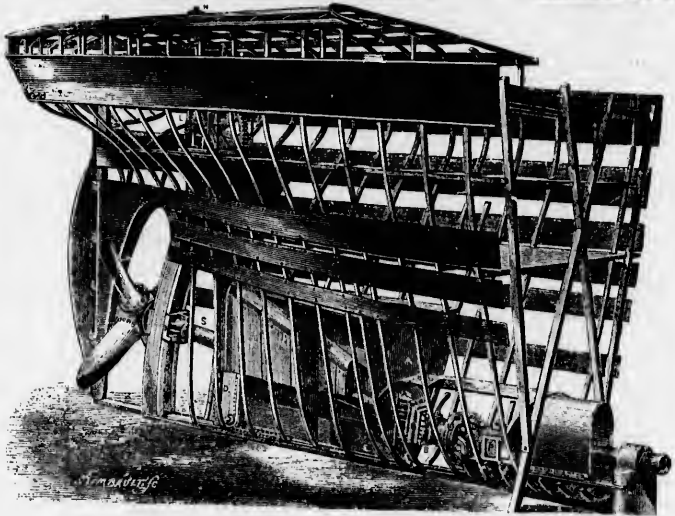
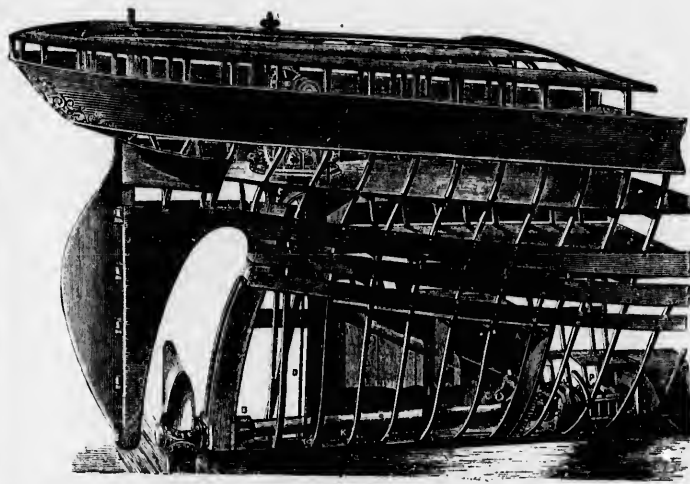
STERN OF

the room,

Messrs.  
ed being  
Celtic in  
ere were  
on when  
a marked  
siderable  
he pipes  
er causes,  
ed for the

e "rolling  
ooms and  
but this,  
made on  
fectual.'  
in marine  
Britannic  
r, so that  
ter till it  
opeller to  
race when  
ject very  
angement  
ess in the

long by 30  
, but was a



STERN OF BRITANNIC, AS ORIGINALLY FITTED WITH LOWERING PROPELLER, 1874.

hull in which the after length of the shafting could move up and down, swivelling from a universal joint, connecting with the tunnel shafting.

The machinery was so placed in the ship as to rake very much aft, in order to have the whole of the shafting in a straight line when the propeller was working in its lowered position at sea. After a trial extending over some months, the results were not found so satisfactory as had been hoped, or as the working of smaller vessels had previously indicated, so that it was done away with at considerable expense.

Like some of the other large Transatlantic lines the White Star has not confined itself to the one service, but has widened its connections to such an extent that the well-known cream-coloured funnel and graceful hull may be found floating on all waters of the "great sea." In 1875 an important service was formed on the Pacific between San Francisco and China and Japan, on which service the **Oceanic** still continues one of the clippers of the seas, in conjunction with the **Belgic** and **Gaelic**, modern vessels built to replace others of the same name, sold out of the service as being too small.

**NEW ZEALAND LINE.**—Another important extension of the ocean traffic, begun in 1883, was the direct Royal Mail Service to New Zealand, which fine vessels, such as the **Ionic**, **Doric**, and **Coptic**, carry on in conjunction with the Shaw, Saville, and Albion Line. This now important service was first inaugurated by the New Zealand Shipping Company in 1883. The pioneer steamers, which were under the author's superintendence, were the **British**



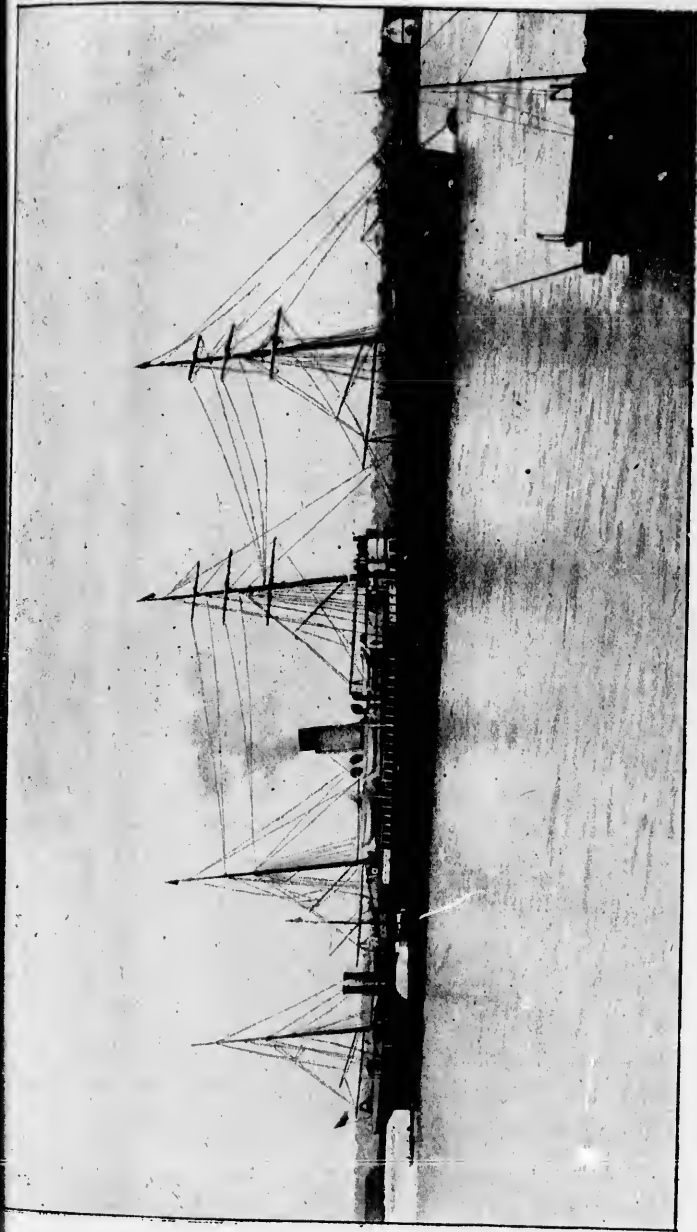
CHAP. V.

g could  
al joint,

s to rake  
shafting  
ng in its  
ing over  
isfactory  
r vessels  
way with

ines the  
service,  
tent that  
eful hull  
eat sea."  
e Pacific  
on which  
clippers  
d Gaelic,  
ne name,

ension of  
ect Royal  
, such as  
tion with  
now im-  
Zealand  
rs, which  
he British



R.M.S. BRITISH KING. 1881.  
Pioneer of the direct New Zealand Royal Mail Service, 1883.

**King** and **British Queen**, steel vessels chartered from the British Shipowners' Company, of Liverpool. These vessels, by Messrs. Harland and Wolff, were 410 $\frac{1}{4}$  feet long, 39 feet broad, 29 feet deep, and of 3,412 tons, each having four-cylinder compound tandem engines by Messrs. Jack and Co., of Liverpool, with two high-pressure cylinders, each 28 inches diameter, and two low-pressure, each 60 inches diameter, the stroke being 4 $\frac{1}{2}$  feet. Steam at 90 lbs. pressure was generated in three boilers having eighteen furnaces, the speed being 12 knots on a consumption of 38 tons per day.

After some years during which no high speed vessels were built, although several ordinary passenger and cargo boats for other trades were brought out, another important step was taken by the White Star Line which had been long premeditated, namely the building of steamers to keep pace on the Express Transatlantic Passenger Service.

Satisfactory negotiations having been concluded with the British Admiralty, who, profiting by experience, were now anxious to form a real connection between the Royal Navy and the "great fleet Messengers of the Mersey," on the basis of an arrangement put forth by Mr. Ismay, the order was placed with Messrs. Harland and Wolff to build the two famous steel vessels **Teutonic** and **Majestic**, which were 566 feet long, 57 $\frac{3}{4}$  feet broad, 39 $\frac{1}{2}$  feet deep, and of 9,800 tons. These stately ships, although of the same substantial construction and excellent arrangements as the first vessels brought out by this Company, present a different external appearance. The four masts are replaced with what may be



[CHAP. V.

from the

These

110½ feet

12 tons,

engines by

pressure

pressure,

t. Steam

ers having

consump-

ed vessels

and cargo

er impor-

which had

eamers to

er Service.

uded with

xperience,

a between

ers of the

forth by

. Harland

ls Teutonic

et broad,

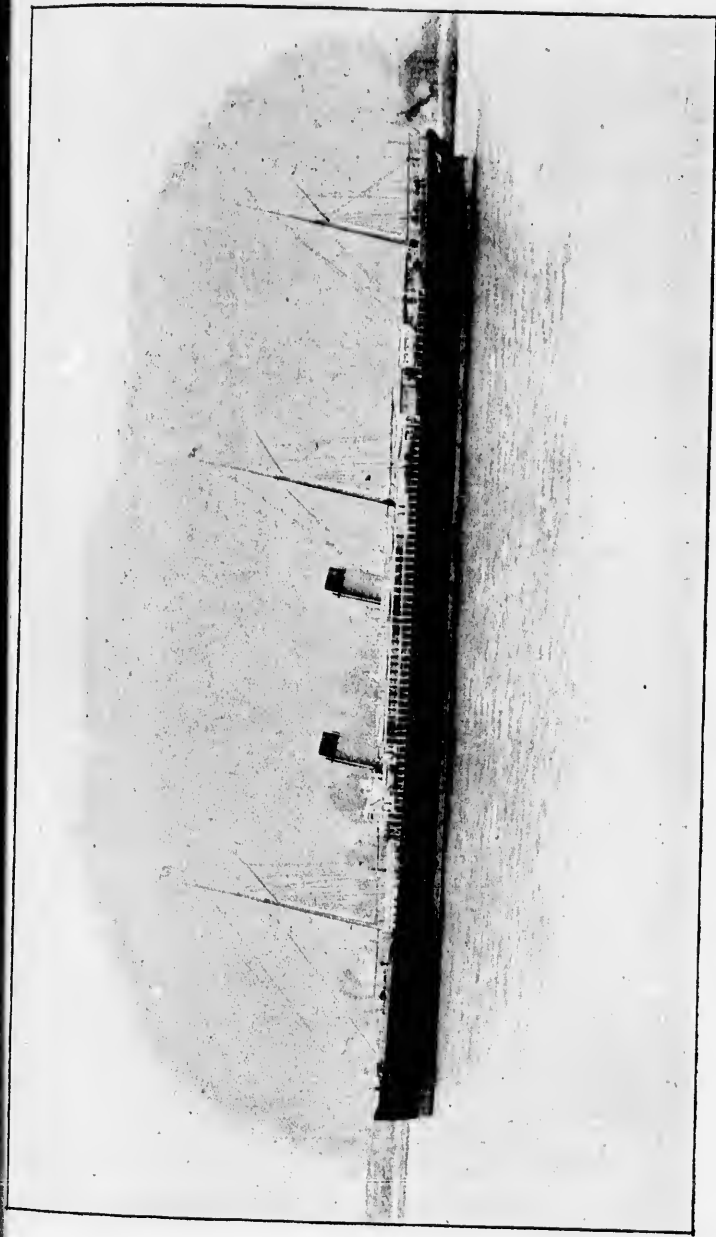
tely ships,

ction and

rought out

al appear-

at may be



R.M.T.S. TEUTONIC (1889) AND MAJESTIC (1890)—WHITE STAR LINE.

termed three flag poles, the partial abandonment of sail power initiated by the Inman and International Line being carried still further, and the two funnels are spaced so far apart as to allow the saloon being placed between them, the great length of the vessel allowing this to be done uniformly with the masts.

Beyond the fact that the hulls are divided into small compartments by both transverse and fore and aft bulkheads, and that the saloon accommodation is of the most luxurious kind, having extensive state- and retiring-rooms *en suite* and of considerable height, the interior calls for no comments, but attention may be drawn to the ingenious arrangements of the first-class accommodation, whereby each state-room is fitted with only one berth, so that, when preferred, a passenger can procure the privilege of having a room to himself.

The propelling power, although twin-screw, possesses the novelty in this trade of having the propellers overlapping a few feet instead of being a slight distance out on each side from the hull, this system, although apparently novel, has long been in use elsewhere, and has been used also by Messrs. Harland and Wolff in some cross-channel vessels.

Early in 1891 another step forward was taken by this line in increasing their fleet of cargo steamers, such as the **Cufic** and **Runic**, by the addition of the **Nomadic** and **Tauric**, improved forms of cargo vessels specially adapted for live cattle. These also have the overlapping twin screws which have proved so successful on the express boats. They will, no doubt, be the prototype of the

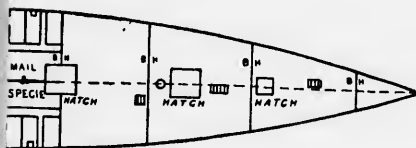
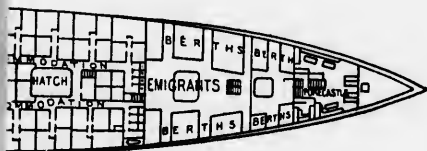
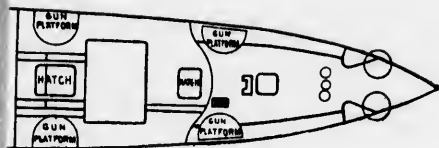
[CHAP. V.

nt of sail  
nal Line  
annels are  
ng placed  
allowing

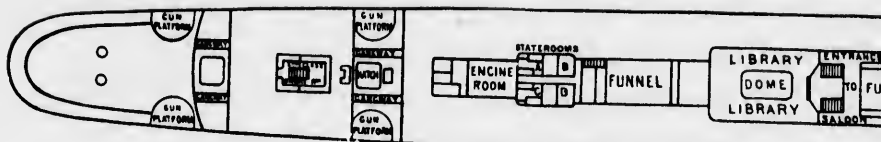
nto small  
aft bulk-  
f the most  
ng-rooms  
r calls for  
o the in-  
modation,  
one berth,  
ocure the

possesses  
llers over-  
istance out  
ugh appa-  
, and has  
f in some

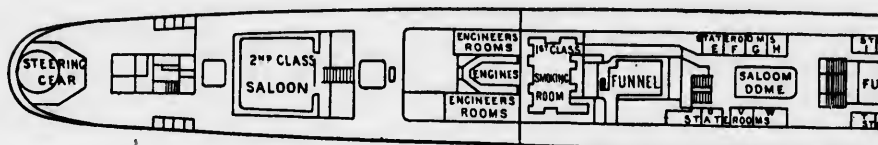
en by this  
rs, such as  
madic and  
ly adapted  
pping twin  
he express  
pe of the



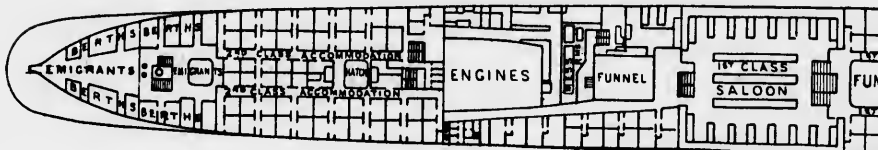
Face page 98.



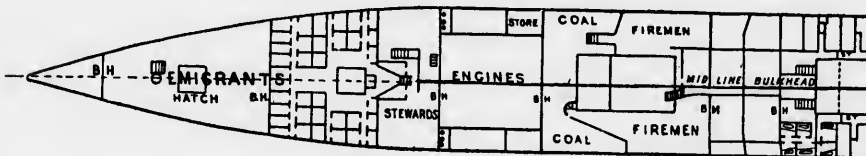
Hurricane Deck.



Upper Deck.

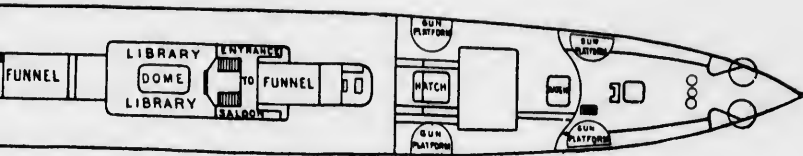


Main Deck.

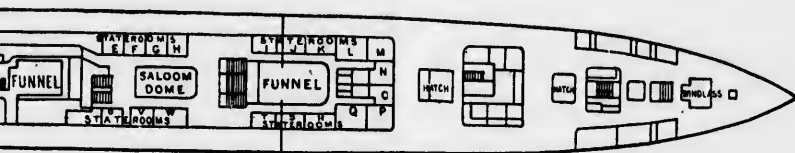


Lower Deck.

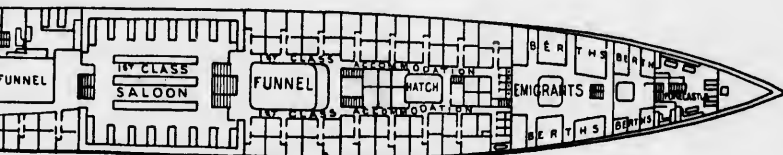
DECK PLAN OF THE TEUTONIC (WHITE STAR)



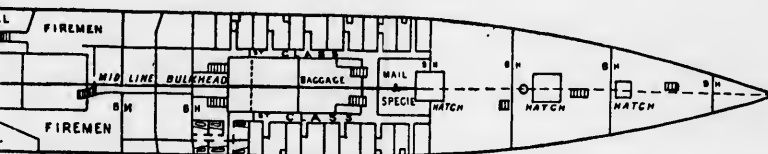
Hurricane Deck.



Upper Deck.



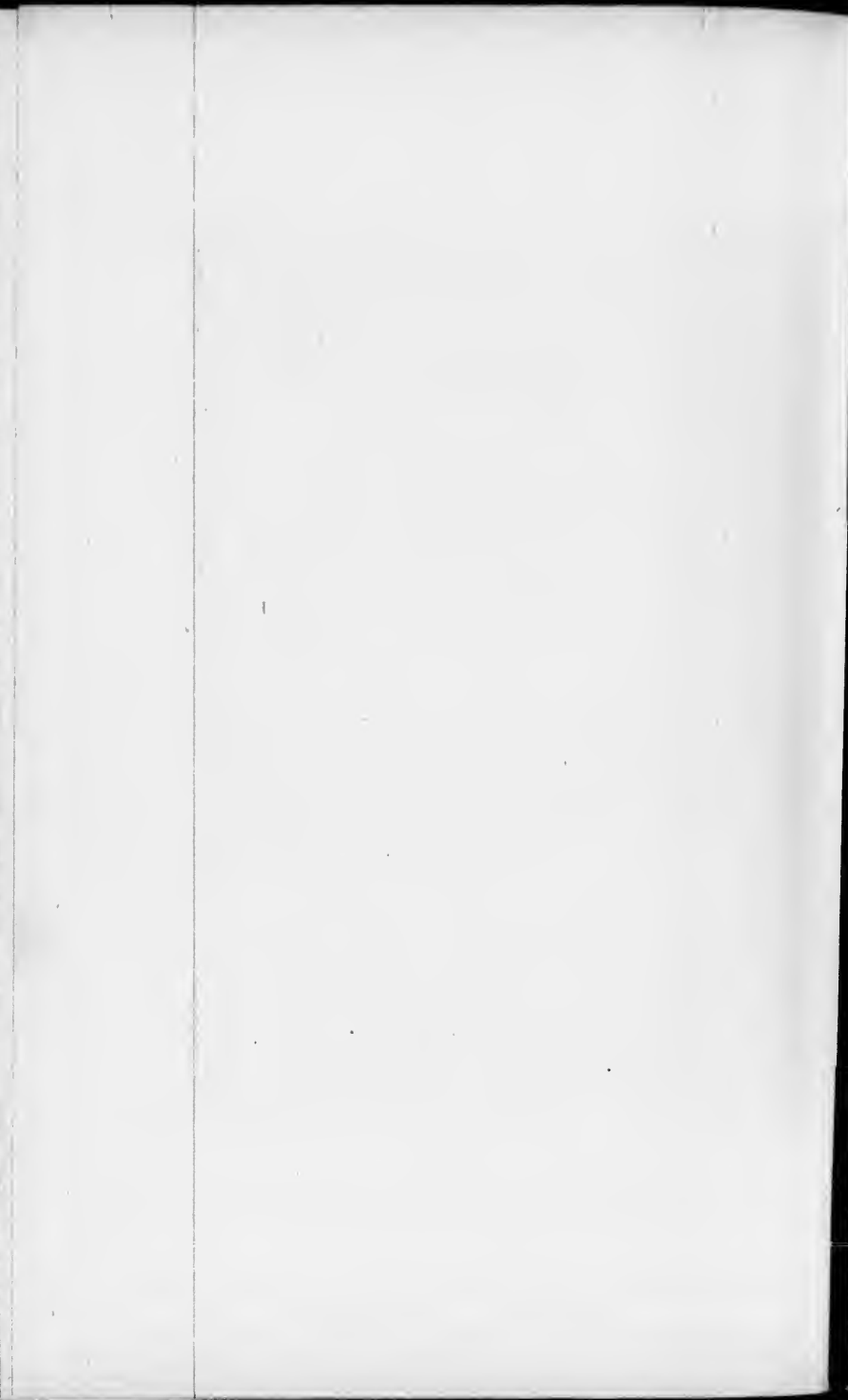
Main Deck.

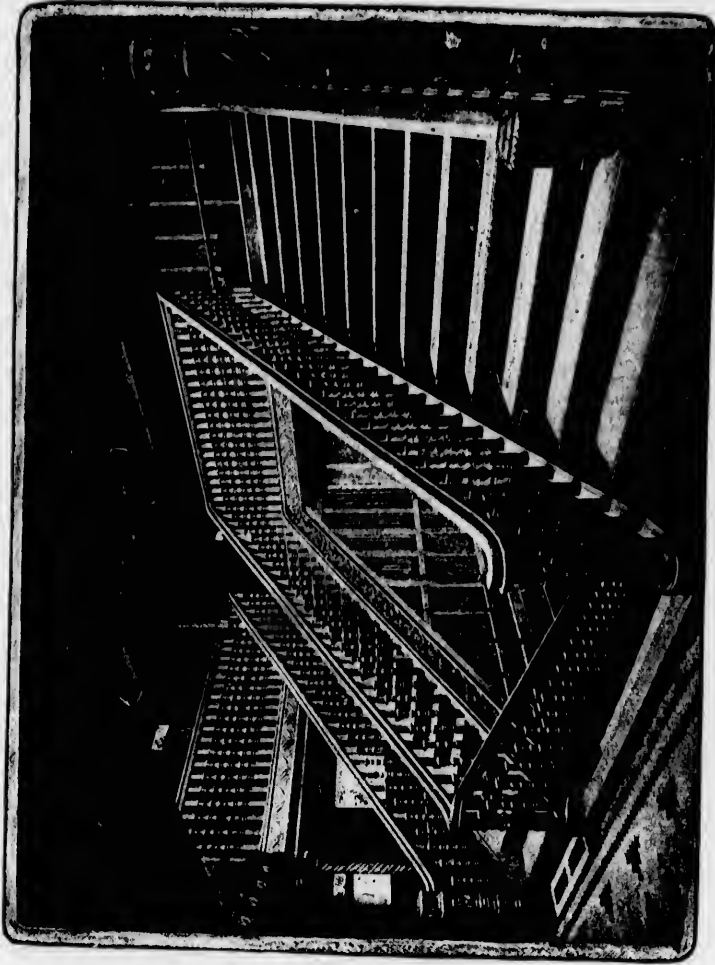


Lower Deck.

THE TEUTONIC (WHITE STAR LINE).

Face page 98.





92  
GRAND STAIRCASE TO PROMENADE DECK—TEUTONIC AND MAJESTIC.

future cattle fleets of Great Britain, as their exceptionally good ventilation and general arrangements render them admirably adapted for this class of trade.

It may be interesting to mention that the now extensive trade of carrying live cattle across the Atlantic and other oceans was commenced in July, 1874; the first steamer to bring cattle to Liverpool from the continent of North America was the SS. **European**, belonging to Messrs. H. N. Hughes and Nephew, with 373 head of cattle, out of which three were lost; the next vessel the **San Marcos** in July, 1875, with 276 head, all for the firm of George Roddick. The dead meat trade by refrigeration commenced on the Guion Line's **Wyoming** in October, 1875, a few small lots having previously been successfully carried in 1874 on the White Star liners **Celtic** and **Britannic**.

Unlike the other Transatlantic lines the proprietary of the White Star has undergone no change, the well-known and respected names of Ismay, Imrie and Co. (since joined by Mr. W. S. Graves in 1881, and the two sons of the senior partner, Mr. Ismay, in 1891) still continuing to steer its course in the same brilliant and enterprising manner as from the commencement.

The following important correspondence, reprinted from the "Liverpool Daily Post," of March 18th, 1887, explains the arrangement above referred to with H. M. Government :

#### THE GOVERNMENT AND ARMED CRUISERS.

"A Parliamentary paper just issued contains copies of correspondence respecting the subvention of merchant





HAP. V.

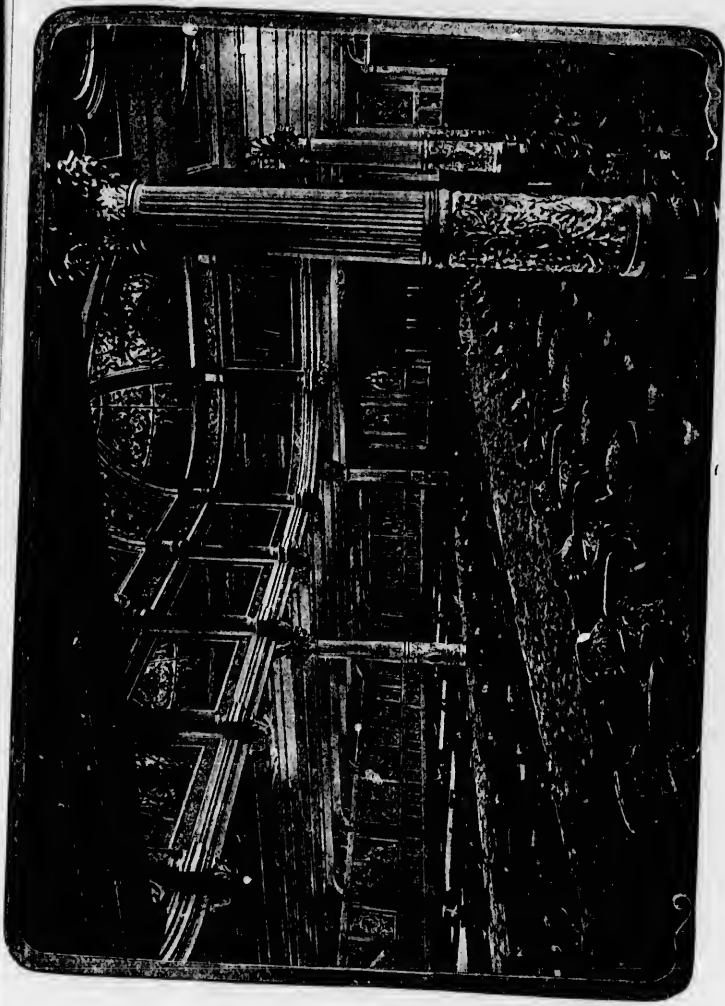
onally  
them

exten-  
ic and  
e first  
tinent  
ing to  
ead of  
sel the  
e firm  
iger-  
ctober,  
ccess-  
ic and

rietary  
e well-  
d Co.  
he two  
ll con-  
t and

rinted  
1887,  
H. M.

opies of  
rchant



GRAND SALOON—TEUTONIC AND MAJESTIC.

steamers for State purposes. The paper opens with a letter, dated the 31st January, from Mr. Ismay (of Messrs. Ismay, Imrie and Co., White Star Line), giving the terms on which they were prepared to carry out the scheme for the subvention by the Admiralty of mercantile vessels specially built for service as armed cruisers. Mr. Ismay says:—

“ The Oceanic Steamship Company

“ 1. Undertake to hold at the disposition of the Government, for purchase or hire, at the option of the Admiralty, to be exercised from time to time during the continuance of the agreement, the following vessels, viz. :—**Britannic**, £130,000 ; **Germanic**, £130,000 ; **Adriatic**, £100,000 ; and **Celtic**, £100,000.

“ 2. In the event of purchase, the foregoing prices are to be held as the values of the vessels on the 1st January, 1887, plus 10 per cent. for compulsory sale, less an abatement of 6 per cent. per annum on the depreciated annual value for the period that may elapse between the 1st January, 1887, and the date of purchase by the Government. In such case the Company shall be entitled to remove from the ship or ships the plated ware, cutlery, crystal, earthenware, blankets, counterpanes, and linens, which articles are not to be considered as part of the equipment of the ships ; such proportionate quantities, however, as may be necessary for the number of officers and warrant officers that would form part of the ship's complement, if used as an armed cruiser, to be left on board free of charge.

“ 3. In the event of charter by the Admiralty the rate of hire of the before-named vessels, all or any, to be at the rate of 20s. per gross registered ton per month, the owner providing the crew, or at the rate of 15s. per gross registered ton per month, the Admiralty finding the crew, all risks of capture and of hostilities being assumed by the Admiralty ; the Company to be allowed seven days on pay at the stipulated rate of hire on any of the vessels so chartered for taking down cabin fittings

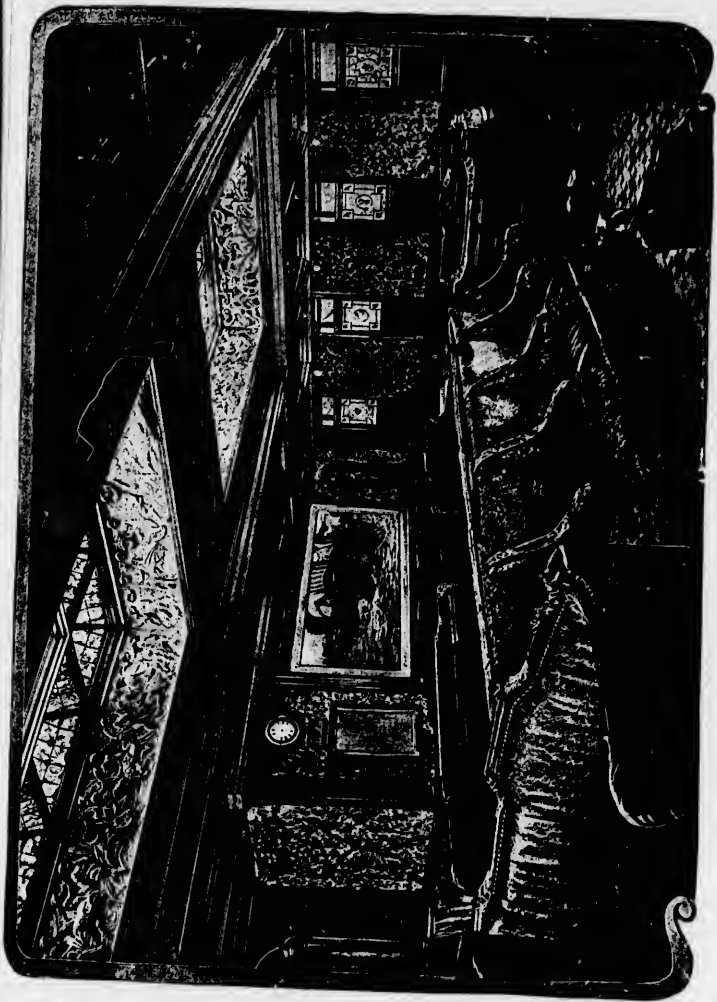


with a  
ay (of  
giving  
out the  
mercan-  
uisers.

overn-  
airalty,  
nuance  
itannic,  
O; and

ces are  
nuary,  
ess an  
eciated  
een the  
overn-  
tled to  
utlery,  
linens,  
of the  
ntities,  
officers  
e ship's  
left on

he rate  
o be at  
th, the  
5s. per  
finding  
being  
allowed  
on any  
fittings



SMOKING SALOON—TEUTONIC AND MAJESTIC.

not required by Admiralty, and ten days on the same pay at the termination of the service for replacing these fittings, the work of dismounting, dismantling, and reinstating to be performed by the Company at the expense of the Admiralty.

"4. Should the Government hire and subsequently elect to purchase any steamer under this agreement, three-eighths of the amount of hire paid during the period not exceeding six months immediately preceding the purchase to be allowed by way of rebate from the amount of purchase money provided by these presents.

"5. During the currency of this contract any vessels which may be substituted in the mail service for those before named (except the steamers hereinafter referred to) shall also be subject to the like conditions as regards purchase and hire. In the event of purchase the price shall be fixed at the cost price to the Company, with 6 per cent. additional for compulsory sale, less an abatement in the manner already provided in Clause 2.

"6. The Company have determined to build one or two vessels of high speed, and they agree to construct these vessels of such type and speed as shall render them specially suitable for service as armed cruisers, and in accordance with the plans and specifications already submitted and approved by the Admiralty. In consideration, the Admiralty agree to pay to the Company for the vessel or vessels so approved, an annual subvention, payable half-yearly, at the rate of 15s. per gross registered ton per annum, such subvention to commence from the date on which the vessels respectively start on first voyage with the mails, and to be continued yearly for a minimum period of five years, terminable at the end of five years or thereafter on twelve months' previous notice, always provided that no subvention is payable to any vessel after the 1st January, 1894, if the Admiralty shall have given the twelve months' previous notice.

"7. In the event of the Company ceasing to carry the mails under the contract now being concluded before the

Company s  
under the c  
receive for  
expired at t  
tract a subv  
ton per ann  
consideratio  
precluded f  
the vessels  
charter for  
case of a  
Admiralty p  
the Admiral  
purchase or  
any vessel r  
as regards t

"8. In the  
Admiralty, i  
the *bona fide*  
shall, in the  
otherwise th  
no effect.

"9. In the  
in excess of  
during the c  
previous spe

"10. Shou  
receiving the  
to be at the  
calendar mo  
22s. 6d. per  
crew. In th  
all risks; in  
hostilities or  
defined in Cl  
and refitting

"11. In or  
vention may

Company shall have received five annual subventions under the condition of clause 6, they shall be entitled to receive for any part of the period that may not have expired at the time of the termination of the mail contract a subvention at the rate of 20s. per gross registered ton per annum, in lieu of 15s. as already provided. In consideration of the subvention, the Company shall be precluded from entertaining in connection with any of the vessels referred to in this contract offers for sale or charter for a period exceeding five weeks, unless, in the case of a longer charter, with the approval of the Admiralty previously obtained, without first giving to the Admiralty the option of exercising the pre-emption to purchase or hire, such option to be exercised as regards any vessel receiving a subvention within seven days, and as regards the other vessels within forty-eight hours.

"8. In the event of the Company giving notice to the Admiralty, it shall be accompanied by such evidence of the *bona fide* nature of such offer for sale or charter as shall, in the opinion of the Admiralty, be satisfactory, otherwise the said notice shall be considered void and of no effect.

"9. In the event of charter by the Company for a period in excess of that named, the subvention to be suspended during the currency of such charter, unless continued by previous special arrangement with the Admiralty.

"10. Should the Admiralty elect to charter any vessel receiving the subvention, the rate of hire for such vessel to be at the rate of 20s. per gross registered ton per calendar month, the Admiralty providing the crew, or 22s. 6d. per ton if the owners are required to find the crew. In the former case the Admiralty are to assume all risks; in the latter the risk of loss or damage from hostilities only to be for their account. The terms defined in Clause 3 for time allowance for dismantling and refitting to apply also to these vessels.

"11. In order that the vessels receiving a special subvention may be ready for service as armed cruisers at

the shortest possible notice, the Company shall afford to the Admiralty every facility compatible with the use of the vessels as mercantile ships for fitting on board during the construction of the steamers such permanent fittings and arrangements for their armament, on plans to be approved, as will enable them to be prepared for service within a week of arrival and discharge of cargo at Liverpool. And as regards the guns contemplated to be placed upon the upper deck, the Admiralty are to provide the racers and other fittings and gun mountings, which the Company are to keep, if required by the Admiralty, in their storehouse at Liverpool without charge, ready for immediate placing on board the ships at the cost of the Admiralty, and to maintain the same in clean order ready for immediate use free of charge.

"12. It is understood that the crews of the vessels employed under this agreement shall consist as nearly as possible of one half of men belonging to the Royal Naval Reserve, and the Company agree to do everything in their power to give effect to this requirement at the earliest possible date after the commencement of the agreement.

"13. Should any of the foregoing ships be sold to a British shipowner approved by the Admiralty, the privileges of the agreement are to remain attached to the ship or ships under the new ownership.

"14. The price for the ships receiving the subvention is to be the cost price thereof, subject to the general conditions set out in Clause 2; but the Admiralty agree not to exercise their pre-emption as regards purchase only for two years after their completion.

"15. The subvention payable under this agreement to be suspended on the loss of any ship, or in case they are not being maintained in a seaworthy condition, with a Board of Trade certificate, and the Admiralty are at liberty annually to inspect the steamers.

"16. Any additional capital expenditure over new boilers and machinery to the vessels enumerated in

Clause 1, to event of purchase compulsory

"17. If the purchased by the Company's Admiralty to Office to release

"Writing

the proposed the date on the first voyage

Admiralty to the Treasury

the Treasury

the Treasury

the Treasury

the Treasury

the Treasury

the Treasury

the Treasury

the Treasury

the Treasury

the Treasury

the Treasury

the Treasury

the Treasury

the Treasury

the Treasury

the Treasury

the Treasury

the Treasury

the Treasury

the Treasury

the Treasury

the Treasury

the Treasury

the Treasury

the Treasury

the Treasury

the Treasury

the Treasury

<sup>1</sup> Since fu



Clause 1, to be added to the value of the vessel in the event of purchase, but without 10 per cent. bonus for compulsory purchase.

"17. If the vessels under this agreement are hired or purchased by the Admiralty, so as to interfere with the Company's obligations under the mail contract, the Admiralty to agree to obtain the concurrence of the Post Office to release them from such obligations.

"Writing on the 19th February, the Admiralty accept the proposed terms, the subvention to commence from the date on which the vessels respectively start on their first voyage with their mails. On the 2nd February the Admiralty communicated the nature of the scheme to the Treasury, explaining that the opportunity of practically developing the scheme has been offered by the negotiations in progress for the conveyance of the mails between the United Kingdom and New York. As to the standard of speed, the Admiralty consider that no vessels of less than seventeen or nineteen knots an hour would meet the object in view. And existing vessels, even with this speed, would not be so valuable for their purpose as those specially built to the Admiralty requirements. The Admiralty had formed no definite idea as to the number of vessels that should be retained, but consider that probably ten would be the maximum number at all likely to be placed at the disposition of the Admiralty within the next five years, at the maximum annual charge of £50,000. The Admiralty had been in correspondence with several large companies, but arrangements had only been concluded with the White Star and Cunard Lines. Although the vessels of the White Star Line have not the high speed that the Admiralty seek to obtain,<sup>1</sup> yet they are undoubtedly fast ocean-going vessels, and would prove efficient transports. The prices named are fair both for purchase and hire, and afford a protection to the public service against having to pay excessive rates that might be current in time of war.

<sup>1</sup> Since fully attained in the **Teutonic** and **Majestic**.

“As regards the conditions as to vessels to be built, their lordships view with much satisfaction the arrangement they have been enabled to effect in this respect. Plans of two proposed new vessels to be forthwith constructed, and completed in about eighteen months or two years, have been laid before the Director of Naval Construction. That officer has reported to their lordships that these plans would provide vessels far in advance of anything that has yet been submitted to the Admiralty for the purpose of armed cruisers. They would be of large size, of exceedingly high speed, provided with twin screws, have their engines and boilers below the water line, be divided into numerous compartments, and have a protected steering gear. In regard to capacity they would be capable of conveying fully 2,000 men, whom they could land at Bombay *via* the Suez Canal in 14 days, or *via* the Cape in 22½ days. Their coal capacity would be such that at a cruising speed they could probably keep the sea for a long period, probably not less than three months. These vessels will be completed in about eighteen months, and the subvention will be an annual charge of about £6,500 for each vessel so long as they carry the mails, or £8,500 should the mails be withdrawn from them.

“As respects the Cunard Company, that Company already possess the two fastest vessels in the British mercantile marine—namely, the *Etruria* and *Umbria*, both of which have a speed at sea of 18 knots an hour. Although these vessels do not possess the advantages that the Admiralty would obtain had they been constructed upon designs to meet their requirements, yet their lordships think they are vessels of such high speed and such a high class that their retention by the board for national purposes when required is desirable. They have, therefore, entered into negotiations to retain the *Umbria* and *Etruria*, and the *Aurania*—a steamer almost equal in speed—on similar terms to those made with the White Star Company. The annual expenditure for the

retention of  
£5,800 each

“The Tre  
approves of

“The offer

Mr. John Bu

or hire the fo

value £310,

7,269, £240,

£102,000.

“The term

to those agre

charter of th

ton register p

15s. per ton

the Company

service, they

Admiralty, w

manner best

“The Adm

proposals for



retention of these vessels will amount to an average of £5,300 each.

"The Treasury's reply is dated 10th February and approves of the proposed agreements.

"The offer of the Cunard Line is contained in a letter by Mr. John Burns, dated 8th February. He offered for sale or hire the following vessels:—**Etruria**, of 7,718 gross tons, value £310,000; **Umbria**, 7,718, £301,000; **Aurania**, 7,269, £240,000; **Servia**, 7,392, £193,000; **Gallia**, 4,809, £102,000.

"The terms of the subvention and purchase are similar to those agreed to by the White Star Line, but for the charter of the three first vessels the demand is 20s. per ton register per month without crew, and the other two 15s. per ton per month without crew. In the event of the Company determining to build new ships for the mail service, they undertake to submit the plans to the Admiralty, with a view to their being constructed in a manner best suited to the purpose of armed cruisers.

"The Admiralty, writing on the same day accepted the proposals for the **Etruria**, **Umbria**, and **Aurania**."

## CHAPTER VI.

### DOMINION, AMERICAN, STATE, WARREN, WILSON, AND BEAVER LINES.

FOLLOWING the example of the White Star Line, another of the existing lines, the Dominion, commenced in 1872 a service between Liverpool, Quebec, and Montreal; this was an offshoot of the Liverpool and Mississippi Steamship Company trading between Liverpool and New Orleans, and has continued in the service ever since, carrying the Royal Mails in conjunction with the Allan Line. Since the commencement many fine vessels have been added to the Dominion fleet, the last being the **Vancouver**, a fine iron steamer, sister to the **Inman City of Chicago**, built on the Clyde. This vessel was brought out in 1884; her dimensions are 430½ feet long, 45 feet broad, 33½ feet deep, with a gross tonnage of 4,928 tons. The engines, by J. and J. Thomson, are of the three crank compound type, having the high-pressure cylinders, 53 inches diameter, placed over the after crank, the two low-pressure cylinders being each 80 inches diameter, with a stroke of 5½ feet. Since this fine vessel came out no fast mail passenger vessels have been added to this fleet, but it is rumoured that some fine vessels emanating from the great Belfast firm will soon be afloat.<sup>1</sup>

<sup>1</sup> Since this was written the **Labrador**, built at Belfast, has been added, in 1891.

Besides the  
carries on an  
Liverpool an  
ment has be  
Messrs. Flin  
taken place s

From the  
down to the  
United State  
line, but in th  
and an order  
to build four  
feet broad, 3-4  
two-crank com  
inches diamete  
of 60 lbs.

These vesse  
**Pennsylvania**, v  
accommodatio  
steamers nam  
carried on the  
Philadelphia s  
vania early in

After carryi  
promoters for  
taken over by  
ready noted) in  
modation reme  
profitable emig  
still engaged.

Besides the passenger service the Dominion Line also carries on an extensive cargo and live cattle trade to both Liverpool and Bristol. Since its foundation the management has been in the hands of the well-known firm of Messrs. Flinn, Main, and Montgomery, no change having taken place since its inauguration.

From the failure of the Collins Line and others noted, down to the year 1871 no efforts were made by the United States to establish an American Transatlantic line, but in that year steps were taken in Philadelphia, and an order placed with Messrs. Cramp, of that city, to build four iron screw steamers, each 343 feet long, 43 feet broad, 34½ feet deep, and of 3,119 tons, with vertical two-crank compound engines, having cylinders 57 and 90 inches diameter, with a stroke of 4 feet, and boiler pressure of 60 lbs.

These vessels, named the **Ohio**, **Indiana**, **Illinois**, and **Pennsylvania**, were fitted with large first class passenger accommodation, and, in conjunction with other English steamers named **Lord Gough**, **British Prince**, etc., have carried on the American Line between Liverpool and Philadelphia since its commencement with the **Pennsylvania** early in 1873.

After carrying on this service under the original promoters for some years, these four steamers were taken over by the International or Red Star Line (already noted) in 1884, who had the large saloon accommodation removed, and employed them in the more profitable emigrant and cargo service in which they are still engaged.

It is interesting to note that it was on one of these steamers the now well-known system of Howden forced draught was introduced in the Atlantic trade, this being fitted to the steamship *Ohio* in the year 1887, when she had new triple engines fitted, and new boilers, which resulted in a great addition to her earning space. These four steamers, *Ohio*, *Indiana*, *Illinois*, and *Pennsylvania*, are the only regular liners on the Atlantic trade which fly the American flag, owing to the United States' law which prohibits any vessel to fly it unless actually constructed in the country, and it is for this reason the Inman boats *City of Paris* and *City of New York* fly the English flag although constructed with American capital.

In 1873 a venture which has since struggled to keep a place upon the Atlantic highway was formed in Glasgow to trade from that port—and occasionally Liverpool—to New York, under the name of the State Line. This continued to ply, calling at Larne (Ireland) until early in the year 1891, when it collapsed, the steamers passing into the hands of the Allan Line to swell their already enormous fleet.

In the same year also, 1873, the South Wales Atlantic Steamship Company was formed to run from Cardiff to New York, but only lasted two years, notwithstanding that they had no dock dues to pay at Cardiff and were supplied with coal gratuitously by the Marquis of Bute, who was one of the largest shareholders in the line. The two steamers were named *Glamorgan* and *Pembrok*, and were fitted up in superior style, the former having

been lighter  
like the ves

The next  
in 1874 fro  
carried it o  
the one wh  
Great West  
and cattle s

The year  
line of stea  
menced a st  
Guion Line  
they had  
then placed  
cattle servic  
have gradual  
freight and c  
flag of the W  
Steam Navig  
is interesting  
the oldest, if r

the Palestine,

In Februar  
trading fleet a  
great shippin  
trade from Hu  
trade from alr  
introduced to  
engines on th

been lighted with Allan's patent gas apparatus, which, like the vessels, was unsuccessful.

The next expansion of this great trade was made in 1874 from Bristol, the port which first created and carried it on. This was made by a company called after the one which originated the enterprise, namely the Great Western, which now carries on a moderate freight and cattle service.

The year 1875 also saw the birth of another Liverpool line of steamers named the Warren Line, which commenced a steam service to Boston by the purchase of the Guion Line pioneers, **Manhattan** and **Minnesota**. These they had fitted with new compound engines, and then placed them on the station for their freight and cattle service early in the year noted, and since then have gradually expanded and added some of the finest freight and cattle service afloat to their line. Under the flag of the Warren Line the vessels of the North Atlantic Steam Navigation Company and others also sail, and it is interesting to note that they have in their service one of the oldest, if not the oldest, vessel on the Atlantic, namely, the **Palestine**, built by Steele and Co., of Greenock, in 1858.

In February of the same year, 1875, another huge trading fleet appeared on the Atlantic, sent forth by the great shipping firm of Wilson, whose already extensive trade from Hull enabled them to command a profitable trade from almost any part of the world. In 1884 they introduced to the Atlantic trade the triple expansion engines on their steamship **Martello**,<sup>1</sup> a vessel 370 feet

<sup>1</sup> See below, p. 182.

long, 43 feet broad, 28 feet deep, and of 3,709 tons, with triple engine having cylinders 31, 50, and 82 inches diameter, and 4 feet 9 inches stroke. This service still continues, having been largely increased by a London connection which was formed, in conjunction with another line in 1886, to be noticed later.

Another of the existing regular lines, the Beaver, or, more correctly speaking, the Canada Shipping Company, Limited, also commenced in 1875 to change from their fine fleet of iron sailing clippers to the steam service, and had three fine iron steamers named the **Lake Nepigon**, **Lake Champlain**, and **Lake Megantic**, built for them on the Clyde, since when they have carried on a regular service to Canada in the summer and New York in the winter, and considerably increased their fleet.

LEYL

NOTWITHSTANDING  
another came  
the Cunard Co  
this important  
Line, commencing  
been engaged  
under the este  
the management  
service the six  
placed upon t  
prototypes of  
them by the  
cessful, and we  
pound engines  
wild Atlantic.  
Line has been  
and Venetian,  
Bostonian and  
Wolff, having  
so kept it up  
Transatlantic fir  
In the year 1  
to Baltimore wa

## CHAPTER VII.

### LEYLAND, JOHNSTON, AND LONDON LINES.

NOTWITHSTANDING the numerous lines already noted, another came upon the scene in 1876 to compete with the Cunard Company for a share of the Boston trade; this important Company, now known as the Leyland Line, commenced on this service in 1876, but had long been engaged in the Mediterranean trade from Liverpool under the esteemed firm of Bibby, which had retired from the management some years before. To carry on this service the six largest ships of the then existing fleet were placed upon the route, and as they were, so to speak, prototypes of the White Star boats, being built prior to them by the same firm of builders, they were successful, and were soon afterwards fitted with larger compound engines and generally altered to suit them for the wild Atlantic. Since its inauguration the Leyland Line has been most successful, two steamers, **Virginian** and **Venetian**, built by Messrs. Palmer, of Jarrow, the **Bostonian** and others, built by Messrs. Harland and Wolff, having been added at intervals to the fleet and so kept it up to the standard necessary for a regular Transatlantic freight line.

In the year 1880 the only regular line from Liverpool to Baltimore was commenced by the firm of Messrs. W.



Johnston and Co., who were already extensively engaged in the steamship trade to the Danube and other ports. The service is now carried on very extensively with some fine cattle and freight steamers such as the **Queensmore**, **Rossmore**, **Barrowmore**, **Sedgemore**, and others. Another service from London to Baltimore has also been carried on since early in 1890 with fine steamers of the same class.

In addition to these lines, there are now very many other occasional vessels engaged, such as the **St. Ronans** and **Borderer**, trading to and from the various ports of the United States and Canada, which countries may well be termed the great granaries of modern times owing to the enormous supplies they send to the mother country.

Although the great city on the Mersey still controls almost the whole of the passenger and by far the greater bulk of the freight service of this vast "coming and going" of modern commerce, a considerable number of other freight lines now find location on the Thames, in order to supply direct the teeming mass of humanity centring in the great emporium of the world, London. One of the principal of these is that now known as the **Wilson-Hill Line**, which, as already noticed, now carries on the service formerly known as the **Monarch Line**. This once noted line was commenced in 1881 under the official title of the **Exchange Shipping Company, Limited**, by Messrs. **Patton, Vickers and Co.**, with a view of carrying on direct from London to New York a regular saloon and emigrant passenger service combined with cargo,

and was com  
steamers bu  
in Hull, fol  
Clyde. Dur  
successful bu  
fell away, a  
steamers, aft  
were taken  
the Allan L  
then trading  
Line.

This latter  
year 1881 by  
pelled steame  
was named th  
Clyde, her di  
broad, 26½ fee  
afterwards by  
struction.

Although fit  
they were not  
as the Expres  
averaging abo

The engines  
having only on  
(port and stan  
pressure being  
inches, with a

These vesse  
London to New



and was commenced with the **Assyrian Monarch** and other steamers built by the Earle Shipbuilding Company, in Hull, followed afterwards by others built on the Clyde. During the early portion of its career a fairly successful business was carried on, but this gradually fell away, and in 1887 the line collapsed, and the steamers, after being laid up in London for some time, were taken over by the Wilson Line, of Hull, and the Allan Line, of Glasgow, represented by the line then trading from London, called the Hill or Twin Screw Line.

This latter line (Twin Screw) came into notice in the year 1881 by bringing forward the first twin screw propelled steamer in the Transatlantic trade. This vessel was named the **Notting Hill**, and was built of steel on the Clyde, her dimensions being  $420\frac{1}{2}$  feet long by 45 feet broad,  $26\frac{1}{2}$  feet deep, and of 3,902 tons, and was followed afterwards by others of similar dimensions and construction.

Although fitted with limited passenger accommodation, they were not designed for what is now generally known as the Express Transatlantic Service—their speed only averaging about 12 knots per hour.

The engines are of the compound tandem type, but having only one crank-shaft and set of cylinders for each (port and starboard) engine, the diameter of each high-pressure being  $32\frac{1}{2}$  inches, and of the low-pressure 76 inches, with a stroke of 4 feet.

These vessels now carry on a regular service from London to New York in the live cattle and freight trade,

in conjunction with the vessels of the old Monarch Line, as previously mentioned.

In addition to the Wilson-Hill, National, and Johnston Lines, already noted as trading from London, extensive services are also carried on by the Furness Line to Halifax and Boston, and the Atlantic Transport to Baltimore, Philadelphia, Boston, etc., *via* Swansea, commenced in 1886.

Another line commenced in recent years in the live cattle and freight service is the Donaldson, from Glasgow to Canadian ports, which commenced with the steamship *Colina* in May, 1887, and still continues.

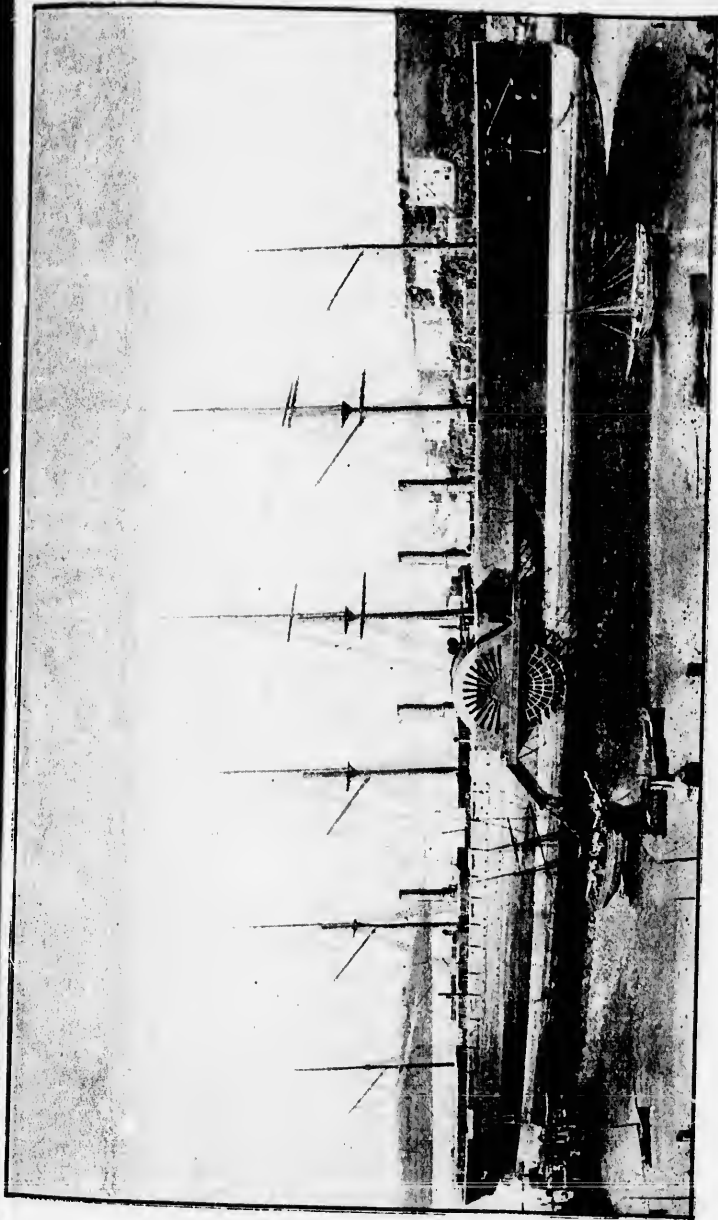
It will perhaps be of interest to give a brief final notice of the once famed **Great Eastern**. Her dimensions were 679½ feet long, 83 feet broad, 48 feet deep, and of 18,915 tons, with oscillating paddle engines, having four cylinders each 74 inches diameter, and stroke of 14½ feet, and horizontal screw engines, with four cylinders, each 84 inches diameter, and 4 feet stroke, the boiler pressure being 30 lbs. generated in ten boilers, having a hundred furnaces fired athwartships. The career of this colossal structure, commencing with her launch in 1858, was singularly unfortunate, as with the exception of the successful laying of the first Atlantic cable, and a few others, she has never once been a commercial success. As if to add still further to her misfortunes, the last years of her existence saw this once wonderful example of the "much-belauded pet of man's constructive skill" lowered to the level of an advertising medium, and then to be the bugbear of the ports of the kingdom, one port even going so far as

h Line,

ohnston  
xtensive  
Halifax  
timore,  
nced in

the live  
Glasgow  
eamship

l notice  
ns were  
18,915  
ylinders  
d hori-  
t inches  
g 30 lbs.  
es fired  
ructure,  
arly un-  
l laying  
she has  
dd still  
xistence  
elauded  
level of  
gbear of  
o far as



**GREAT EASTERN. 1858.**  
One set of boilers and one funnel, between fourth and fifth masts, were removed for cable laying purposes.

to ask Parliament to grant them powers to prevent her floating on the tranquil waters within their precincts.

After a year or two of this degraded existence, she again underwent one of the periodic sales which had occurred almost annually throughout her career, but for the last time, as she was purchased by a firm of ship-brokers for £16,000, and was eventually broken up at New Ferry, on the banks of the Mersey, almost in the same year (1890) that the **Great Britain** ended her career at the Falkland Islands, representing with the broad gauge on the railway, now also doomed, the last of the costly and bitter memories of the engineer Brunel, who, unfortunately for many, had more influence with great capitalists than other far more capable and less fanciful engineers.

TURNING NOW  
steamship co  
ever flowing t  
merce the wo  
termed the "  
great achieve  
engineering w  
Amongst th  
the well-know  
Hamburg and  
ampton. Th  
first commen  
and gradually  
being the **Bo**  
engined by M  
dimensions w  
deep, and of  
oscillating gea  
meter, and st  
started on he  
followed by a  
two steamers  
the sailing ves

ent her  
ets.

e, she  
h had

out for  
ship-

up at  
in the

career  
broad

of the  
, who,

great  
nciful

## CHAPTER VIII.

### CONTINENTAL LINES.

TURNING now to the continent of Europe, we find many steamship companies competing for shares of the traffic ever flowing to and fro on the greatest highway of commerce the world has ever known, and which may well be termed the "Nursery of the Steamship," owing to the great achievements in naval architecture and marine engineering which from time to time it has brought forth.

Amongst the largest and most important of these is the well-known Hamburg-American Line, trading from Hamburg and Cuxhaven to New York, calling at Southampton. This powerful company, like the English lines, first commenced the trade with sailing ships in 1847, and gradually developed into steam, their first steamer being the **Borussia**, an iron screw steamer, built and engineered by Messrs. Caird, of Greenock, in 1855. Her dimensions were 317 $\frac{3}{4}$  feet long, 40 feet broad, 28 feet deep, and of 2,349 tons; the engines were overhead oscillating geared, with cylinders each 67 inches diameter, and stroke of 6 feet. This vessel, the pioneer, started on her first voyage on June 1st, 1856, and was followed by a sister ship named the **Hammonia**, which two steamers kept up the service, in conjunction with the sailing vessels, until the year 1860, when the latter

were disposed of and more steamers added. Since then the line, having, in April, 1875, absorbed the opposition Hamburg company known as the Eagle Line, has developed into an extensive concern, sending its steamers east and west, and gradually expanding its Transatlantic connection, until at the present time it stands at the head of the continental lines, and possesses, besides an ordinary moderate speed passenger service to New York, an express service almost equal to the Liverpool lines, its modern twin-screw steel boats being of the finest type, with the most advanced arrangements for comfort.

Of these the **Colombia** and **Normannia** have been built on the Mersey and the Clyde respectively, and the **Augusta**, **Victoria**, and the **Fürst Bismarck** by the Vulcan Company, at Stettin. The relative sizes of the ships and engines, which are triple expansions of the latest type, are as follows :

**Colombia**, 463½ feet long, 55½ feet broad, 35½ feet deep, and of 7,363 tons. Triple engines, cylinders 41, 66, 101 inches diameter, with 5½ feet stroke.

**Augusta** and **Victoria**, 459 feet long, 55¾ feet broad, 38 feet deep, and of 7,661 tons. Triple engines, cylinders 41, 67, 106 inches diameter, with 5¼ feet stroke.

**Normannia**, 500 feet long, 57½ feet broad, 38 feet deep, and of 8,250 tons. Triple engines, having six cylinders, two of 40, two of 67, six of 106 inches, with 5½ feet stroke.

**Fürst Bismarck**, 502 feet long, 57½ feet broad, 38 feet deep, and of 8,874 tons. Triple engines, cylinders 43, 67, 106¼ inches, with 5¼ feet stroke.

AP. VIII.

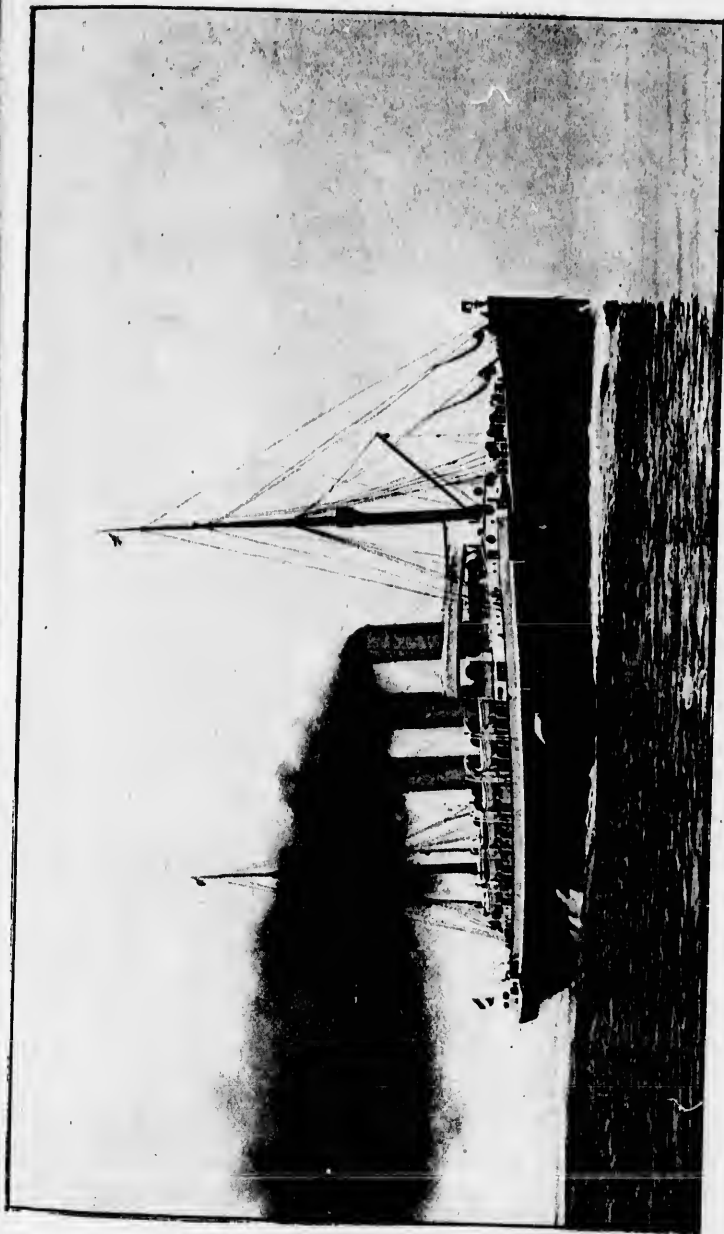
nce then  
position  
has de-  
teamers  
atlantic  
s at the  
sides an  
w York,  
bl lines,  
e finest  
omfort.  
en built  
Augusta,  
mpany,  
engines,  
are as

5½ feet  
41, 66,

broad,  
ylinders

38 feet  
ring six  
with 5½

38 feet  
43, 67,



NORMANNIA. 1890. HAMBURG-AMERICAN LINE



Like the new Inman vessels this fine quartette have adopted the three funnels, and abandoned the use of sail power, and make the passages across between Southampton and New York under seven days, taking about eight days to and from Hamburg.

The other important German line is that known as the Norddeutscher Lloyd from Bremen, which was founded in 1856 by a Bremen citizen, Herr H. H. Meier, who succeeded in amalgamating the various steamship companies, coasting and otherwise, then existing, and forming out of them this great company. It was practically constructed in February, 1857, and commenced the Trans-Atlantic service in June, 1858, with the screw steamer **Bremen**, 318 feet long, 40 feet broad, 26 feet deep, and of 2,674 tons, with inverted direct-acting engines, having cylinders 90 inches diameter, and  $3\frac{1}{2}$  feet stroke, indicating 2,500 horse-power. She was built for them by Caird and Co., of Greenock, together with three others, named the **New York**, **Hudson**, and **Weser**.

Since this event a regular trade has been carried on, and many vessels added to the Norddeutscher fleet from time to time; in 1862 and 1863 the **Hansa** and **America**, followed by the **Hermann**, **Deutschland**, and **Union**, all built by Caird and Co.

In 1868 a weekly service was commenced from Bremen to Baltimore, and since then extensive offshoots have been created to the most distant parts of the globe.

In 1881, under the spirited management of Herr Lohmann, the present managing director, new  $17\frac{1}{2}$  knots express steamers, named the **Elbe**, **Werra**, and **Fulda**, each

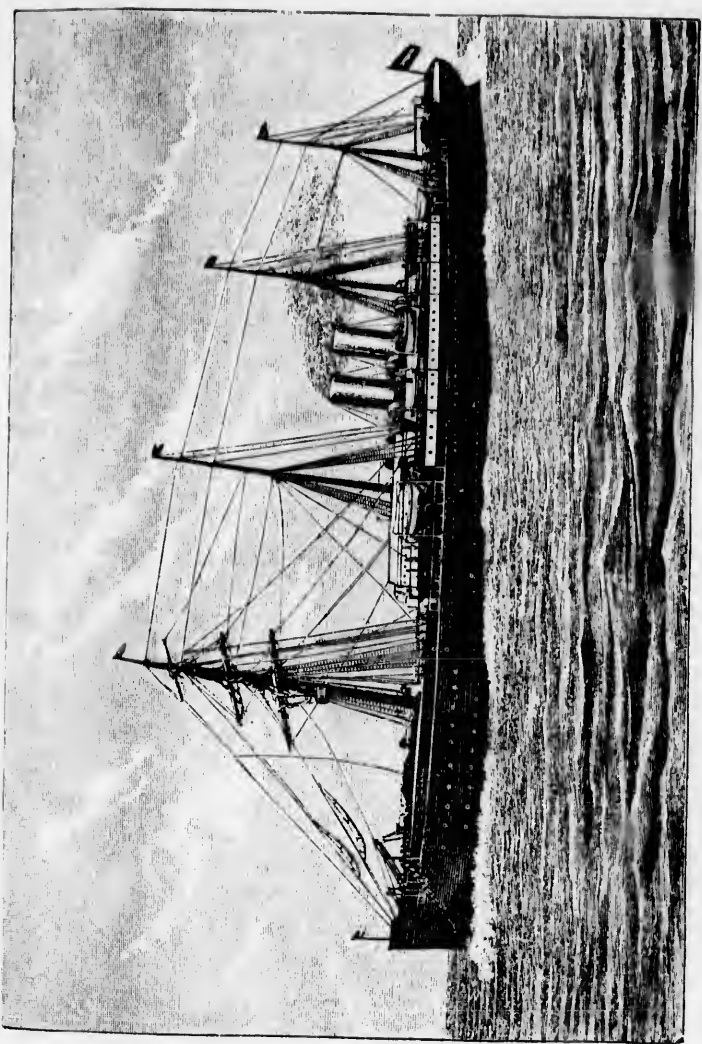


e have  
use of  
South-  
about

as the  
ounded  
er, who  
p com-  
orming  
ly con-  
Trans-  
teamer  
and of  
having  
indica-  
y Caird  
named

ied on,  
et from  
merica,  
on, all

Bremen  
s have  
e.  
f Herr  
y knots  
a, each



ALLER (1866). FIRST EXPRESS ATLANTIC STEAMER WITH TRIPLE ENGINES.

438 feet long, 48 feet broad, 36 $\frac{1}{4}$  feet deep, and of 5,381 tons, built by Messrs. Elder and Co., were placed upon the New York service, and were followed afterwards by the 18 knot **Aller**, **Trave**, and **Saale**, in 1885 and 1886, which were single screws, and had the first triple expansion engines in the Express Service (although not the first on the Atlantic, as already noted), the diameter of cylinders being 44, 70, and 108 inches respectively, with a stroke of 6 feet, and of 8,200 indicated horse-power. Since then has appeared the **Lahn**, 19 knots, of slightly larger dimensions, from the Fairfield Shipbuilding Company, having triple engines with two high-pressure cylinders, each 32 $\frac{1}{2}$  inches, one intermediate, 68 inches diameter, and two low-pressure, each 85 inches, with stroke of 6 feet, and indicating 9,500 horse-power; also in 1890 and 1891, from the Vulcan Shipyard at Stettin, the **Spree** and **Havel**, two fine vessels, 463 feet long, 52 feet broad, 34 feet deep, and of 6,963 tons, with triple engines of slightly larger power.

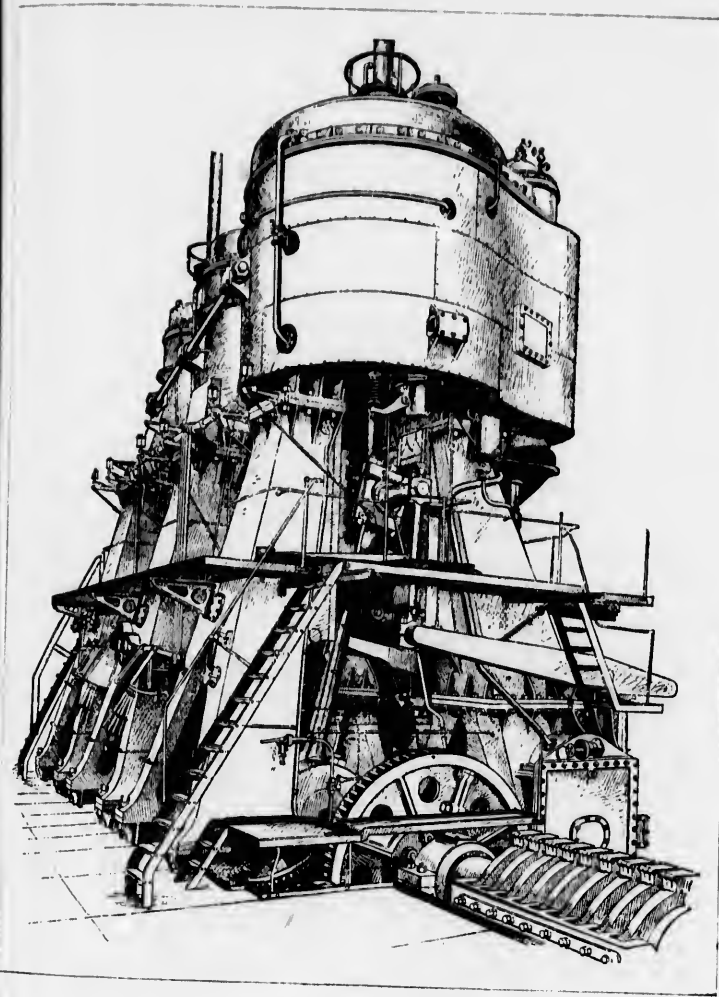
Owing to the gradual improvement of these fine vessels during the past decade, it will be noticed there is no great gap in their increasing speed, so that the service is carried out with express boats, which make the passages to and from New York in fairly equal time. The vessels of the North German Line maintain a weekly service to New York, leaving Bremen and New York every Wednesday and Saturday, and calling at Southampton; also a weekly service to Baltimore leaving Bremen and Baltimore each Wednesday. To enable them to carry on this great trade and the other branches,



AP. VIII.

f 5,381  
l upon  
s by the  
which  
pansion  
first on  
linders  
stroke  
Since  
larger  
pany,  
inders,  
meter,  
roke of  
in 1890  
e Spree  
broad,  
ines of

vessels  
e is no  
service  
ke the  
l time.  
weekly  
w York  
South-  
leaving  
enable  
anches,



ENGINES OF THE ALLER.

the Company own a fleet of about forty steamers over 1,000 tons each, besides numerous smaller craft, and also possess their own graving and other docks, together with extensive works for the overhaul and maintenance of their fleet.

One of the principal lines doing an extensive business from Europe direct is that officially termed the Société Anonyme Belge-Américaine, better known as the Red Star Line, from Antwerp. This now extensive service was commenced by the iron steamship *Vaterland*, 320½ feet long, 38½ feet broad, 31 feet deep, and of 2,748 tons, with two-crank compound engines, having cylinders 40 inches and 80 inches diameter, and stroke of 3½ feet. She sailed from Antwerp on January 19th, 1873, for Philadelphia, and was followed afterwards by the *Nederland* and *Switzerland* in 1873 and 1874.

It is interesting to note that these vessels, which were built and engined by Messrs. Palmer, of Jarrow, were the first ever built to carry petroleum in bulk, in which an extensive trade to Antwerp was then commencing. As, however, the passenger trade was also carried on by these vessels, the petroleum shortly became only secondary, and, owing to the restrictions of the supervising authorities, was finally discontinued.

Owing to the continued expansion of their trade other vessels were soon added to the Red Star fleet, the *Belgenland* in 1878, and *Rhynland* in 1879, built by the Barrow Shipbuilding Company, and later by the *Zeeland*, *Waesland*, and *Pennland*, which under the respective names of the *Java*, *Russia*, and *Algeria*, were previously known in

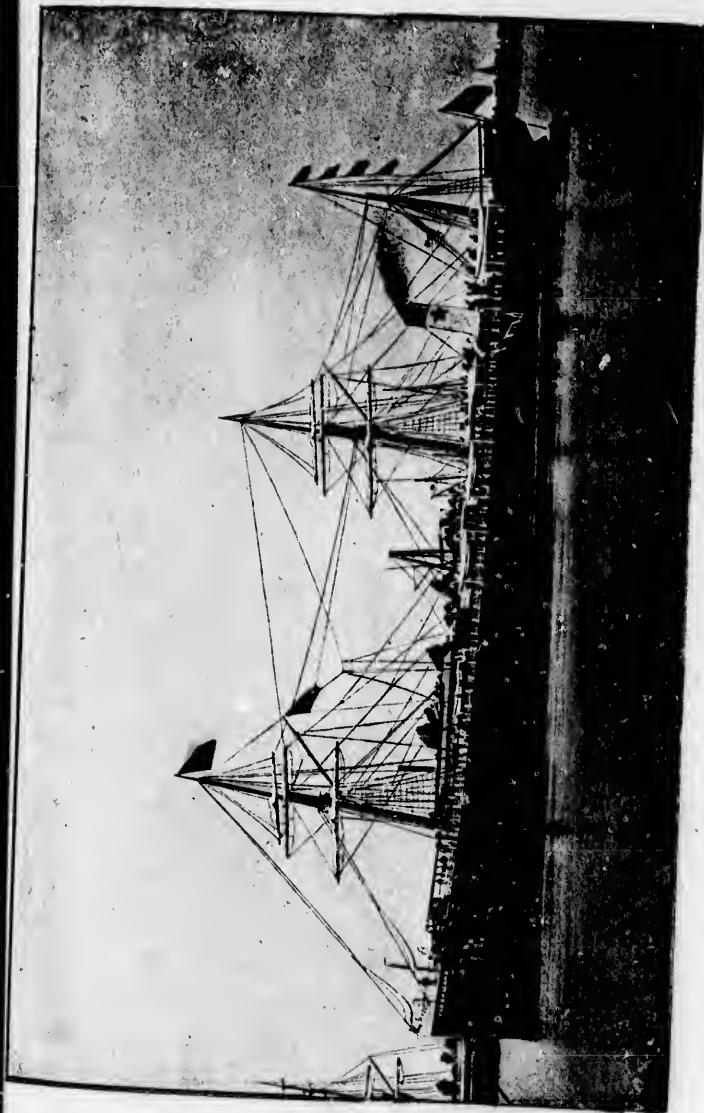
AP. VIII.

rs over  
ft, and  
together  
tenance

business  
Société  
he Red  
rice was  
20½ feet  
ns, with  
inches  
e sailed  
elphia,  
Switzer-

ch were  
y, were  
n which  
encing.  
d on by  
r secon-  
ervising

le other  
Belgen-  
Barrow  
, Waes-  
ames of  
own in



VATERLAND (1873). FIRST STEAMER OF RED STAR LINE.  
First steamer specially built for carrying petroleum in bulk.

the Cunard fleet. Following them came two fine vessels, known as the **Westernland** and **Noordland**, from the yard of Messrs. Laird Brothers, Birkenhead, in 1883.

In 1889 the last addition was made to the fleet by Messrs. J. and G. Thomson, of Glasgow, who built a fine high speed single screw steel steamer named the **Friesland**, 430 feet long, 51½ feet broad, 35 feet deep, and of 6,800 tons, with triple expansion engines, having cylinders 35½, 56, 89 inches diameter, and 4½ feet stroke, and with a working pressure of 160 lbs.

With this fine fleet a regular weekly first class passenger and emigrant service is carried on to New York, and a secondary one fortnightly to Philadelphia.

Of the Transatlantic lines trading from France the most important is the Compagnie Générale Transatlantique, which commenced to run from Havre to New York in 1862 with English built iron vessels, from the firms of Messrs. Napier and Sons, on the Clyde, and Messrs. Palmer, on the Tyne. The French company, like the other numerous lines, has gradually increased its fleet and expended its services, and now possesses a magnificent fleet of steamers, the finest of which are vessels of large size and good speed, constructed some years ago to maintain a place amongst the other express lines to New York. One of these vessels, **La Normandie**, was built of iron at Barrow, in 1882, with engines having six cylinders, corresponding to those of the **City of Rome**; she was followed by the **La Bourgogne**, **La Champagne**, and **La Bretagne**, the two latter being constructed at the Company's own works at St. Nazaire; they are each 495 feet long, 52 feet



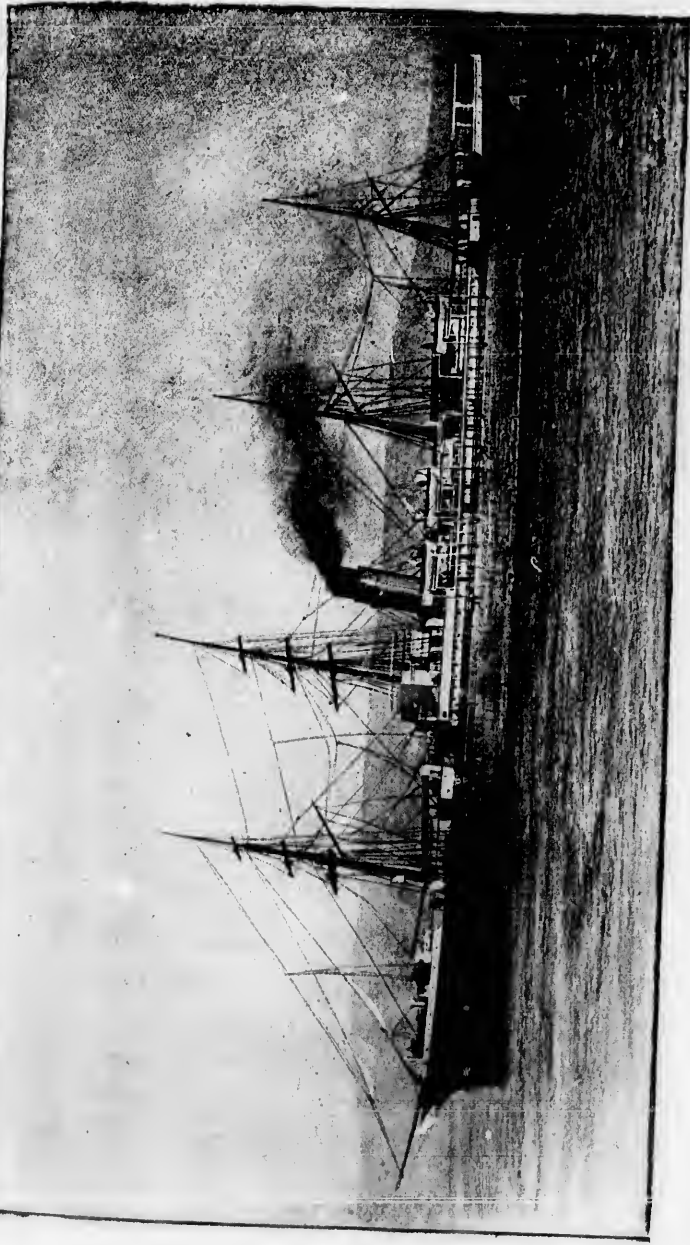
AP. VIII.

vessels,  
the yard

the fleet  
built a  
ned the  
eep, and  
having  
t stroke,

ass pas-  
ew York,

the most  
antique,  
in 1862  
Messrs.  
lmer, on  
umerous  
nded its  
fleet of  
arge size  
maintain  
ew York.  
f iron at  
rs, corre-  
followed  
agne, the  
wn works  
, 52 feet



R.M.S. FRIESLAND (1889). RED STAR LINE.

broad, 33½ feet deep, and of 6,900 tons, with six-cylinder compound three-crank engines.

With these four vessels a superior service is maintained between New York and Havre, though they are not equal in speed to the more modern vessels of the British and German lines.

Other French lines trading in the cargo service are the Chargeurs Réunis, Compagnie Commerciale, from Havre, and the Compagnie Bordelaise, from Bordeaux.

From Italy Rubattino's immense fleet keeps up a service between the Mediterranean and New York, as does also the Fabre Line; from Copenhagen the Thingvalla Line began in 1879, and carries on the only direct service from Denmark to New York. This line became noted a few years ago through the foundering in April, 1889, of one of their vessels, the ss. **Danmark**, when not a life was lost out of 734 souls on board, all having been rescued by the **Missouri**, of the Atlantic Transport Line from London.

In 1872 the Dutch line, officially styled the Nederlandsch Amerikaansche Stoomvaart Maatschappij, of Rotterdam, but known in this country as the Netherlands - American Line, commenced a regular passenger and freight service to New York. By the purchase in recent years of several of the well-known Liverpool liners as the **Baltic**, **Republic**, **British Empire**, **British Crown**, and others, they have established an excellent service between Rotterdam and New York, the steamers now being known under such names as the **Veendam**, **Maasdam**, **Rotterdam**, and **Amsterdam**.

LIKE the other  
teenth century  
ocean steam  
routine of lif  
means by w  
beautiful ves  
many and us

In consider  
that it is ne  
Steamship Li  
to guide the  
public or priv  
the directing  
sections. TH

"Outside" se  
The "Insid  
tors, or mana  
heads of the v  
the office, suc  
ward and out  
departments.

To the sam  
conducting of



## CHAPTER IX.

### THE WORKING OF ATLANTIC LINES.

LIKE the other great organizations formed in the nineteenth century for the use and convenience of man, the ocean steamship companies enter so much into the routine of life, that a brief glance into the manner and means by which the current—or circulation—of the beautiful vessels is kept up is likely to be of interest to many and useful to some.

In considering the subject, it will at once be apparent that it is necessary for the successful working of a Steamship Line that there should be one leading head to guide the entire organization, whether it be under public or private ownership. Acting under him comes the directing staff, which is practically in two separate sections. These may be termed the "Inside" and "Outside" sections.

The "Inside" section comprises the partners, directors, or managers, and, in conjunction with them, the heads of the various departments which are carried on in the office, such as the finance, accountant's, freight (inward and outward), passenger, and oftentimes insurance departments.

To the same section belongs the arrangement and conducting of the various negotiations, incidental to the

general business of the line—such as, the carriage of passengers, freight, and mails; the fixing of the sailing schedules; and the thousand and one details which must be fully worked out with the various connections, scattered throughout the portions of the world in which the line may be directly or indirectly engaged; also arranging with the feeders or carriers, consisting of the various railways and steamboat lines, running more or less in conjunction with them; and also, if they be mail steamers, advising and conferring with the postal authorities, to insure despatch and regularity in the transmission of the mails and generally the utmost efficiency and safety.

The duties of the various heads of the departments are apportioned to men of great experience in their special line, so that each may be worked to its utmost capacity. The chief of the freight has for his duties, the tracing, following up, and securing for his line the carrying of every kind of merchandise, machinery in transit, breadstuffs, dead meat, live cattle, bullion, and so forth, which it is possible to secure. In the passenger branch the same restless energy exists in spreading the great network of alluring advertisements—handsome pictures of the steamers, accounts of fast passages, details of accommodation—by the aid of active agents in every town of the various countries likely to use the watery highway on which the vessels of his line come and go.

The chief of the accountancy department, as the name indicates, has to keep straight the financial concerns of

the whole  
item of cap  
immense nu  
the home d  
branches an

The more  
building of  
the regulati  
agreements  
and such lik  
the principa  
is known of  
matured an  
step has bee  
departments  
various deta  
each in his o  
ceed to the s  
larly inspect  
the owners a  
a view of sec  
ments.

The system  
ments and sta  
of the steame  
of each ship  
to the head o  
rences of the  
departments—  
complete “in

the whole undertaking, commencing at the first great item of capital account, and going down through the immense number of departments in what may be called the home district, to the smallest transactions of all the branches and agencies in outlying foreign ports.

The more important matters of the line—such as the building of new vessels; the opening up of new services; the regulation of times of sailing; carriage of mails; agreements with government; arrangements for charter, and such like—are, of course, retained in the hands of the principal and his partners or directors, and nothing is known of them outside until their proceedings are matured and definitely settled. As soon as any new step has been decided upon, the heads of the various departments are called upon to report and point out the various details requiring development or improvement, each in his own special line, and from time to time proceed to the shipyard and engineering works, and regularly inspect the progress of the work; consulting with the owners and builders as the work advances, with a view of securing the latest and most modern arrangements.

The system by which the whole of the various departments and staffs are engaged in keeping up the working of the steamers is somewhat as follows:—On the arrival of each ship in the home port, the commander reports to the head office the more important events and occurrences of the voyage, and the heads of the three departments—deck, engine, and steward's—return a complete "indent" of the overhauling or work necessary

in their divisions to their respective Superintendents. The latter then go into the various matters, satisfying themselves that the work on the list is requisite, and orders for the work to be carried out are then given to whichever branch of the shore staff it comes under.

At the same time that this overhauling "indent" is handed in, a complete list is furnished of the stores consumed, of the quantity remaining on board, and of what is required for next voyage. This is also scrutinized by the Superintendents, and then passed on to the various officials, to have the articles supplied in good time for the next sailing date. Should there be any extensive or heavy repairs to be effected, or any important alteration to be made, the Superintendent of the department in question then brings the matter forward before the principals, and the details of the work (or, if necessary, the substitution of one vessel for another), are then arranged mutually with the other Superintendents.

In order to insure effective and perfect working, regular fixed meetings of the partners, managers, and superintendents are held, at which the commanders then in port also attend, and the various matters which from time to time require general attention are discussed and arranged, so that each department is kept thoroughly in touch with, and cognizant of the doings of the others. As it is impossible always to define the limits of where one responsibility ends and the other begins, the utility and, indeed, necessity of this system is obvious.

Turning now to the other great section, the "Outside,"

this, like the  
head or ch  
acting in co  
sailing, and  
engaged in v

The most  
partment, w  
for all of whic  
It is this dep  
is about to b  
duty of arra  
vessel. This  
with his staf  
engineers, do  
trimmers, an  
over 160 mer

A very imp  
of the whole  
engine depart  
forty different  
also the aux  
vessel, such  
others, and th  
subject to wea  
be added the  
ments, in the  
saloon or em  
overhauling o  
pantry branch  
tant requireme

this, like the "Inside" section, is conducted under the head or chief, with the other partners or managers acting in conjunction with the heads of the engineering, sailing, and victualling departments which are actually engaged in working the steamers.

The most important is naturally the engineering department, which embraces almost innumerable divisions, for all of which the Superintending Engineer is responsible. It is this department upon which, when a new steamer is about to be taken over from the builders, devolves the duty of arranging the engineering staff on board the vessel. This class ranges from the sailing chief engineer, with his staff of engineers, electricians, and refrigerating engineers, down to boiler-makers, greasers, firemen, and trimmers, and amounts nowadays to a small army of over 160 men in all.

A very important duty is the up-keep and maintenance of the whole machinery of the vessel, not only in the engine department, which alone comprises upwards of forty different engines, besides the main engines, but also the auxiliary apparatus scattered throughout the vessel, such as windlasses, winches, steering-gear, and others, and the various parts of hull and deck which are subject to wear and tear. To these requirements must be added the incessant wants of the passenger departments, in the way of rearrangement and extension of saloon or emigrant accommodation, the supplying and overhauling of the extensive fittings of the culinary and pantry branches, with the numberless minor but important requirements of a floating hotel.

To effectually fulfil these multifarious duties the Superintending Engineer has under his charge extensive repairing works, in which are located the various machines and tools required to carry on the work of the different branches of manufacture and repair. Engineering, forging, smithing, brass and lead-founding, boiler making, and general iron and steel work, plumbing, whitemith's and tinsmith's work, brass-finishing, painting, carpentering and joinery, pattern-making, boat-building, sawing, leather working, laundry work, upholstering, electrical engineering, rigging, sail-making, electro-plating, and other kindred matters, are all placed under responsible foremen, who again, in most cases, have charge of a considerable staff to carry out the work on board when the vessels are in port. In the works are extensive stores, containing all the necessary articles constantly in requirement by the different departments, so that the vessels may be completely overhauled and outfitted by the line's own establishment and staff.

The other important department of the marine or "deck," as it is more commonly called, is under the control of the Marine Superintendent. This gentleman is responsible both for the general work of the ship in port, and for the efficiency of the navigating staff at sea; the latter consisting of the commander, officers, boatswains, quartermasters, and crew. The numerous other duties connected with the docking and berthing on arrival; the manner and rate of discharging and loading of cargo; coaling, and outfit for the coming voyage, also fall to his

care. Acti  
intendents  
of the oth  
previous to

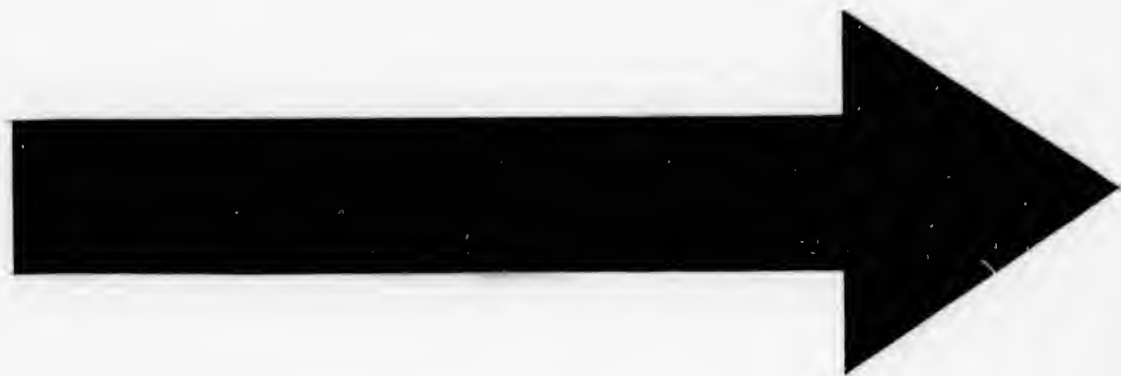
The nat  
every trip  
saloon acc  
dry docking  
ing purpos  
attention;  
tion; on an  
modation i  
either in s  
disuse), or  
sidiary requ  
and then it  
expose all t  
ances, *et hoc*  
supervising  
a certain ex  
side, for alt  
freight depa  
and stevedo  
the state of

Then com  
the cargo an  
and opening  
straight and  
receive the p  
and to pass

care. Acting with the Engineering and Victualling Superintendents, he generally, also, arranges for the work of the other departments which may require attention previous to commencing the next voyage.

The nature of this superintendence varies for almost every trip. At one time it is to extend or improve the saloon accommodation; at another, it is to arrange for dry docking, for the overhaul of machinery, or for surveying purposes. Sometimes the cargo holds may need attention; at others the meat chambers require alteration; on another voyage more extensive emigrant accommodation is needed; and, at all times, the equipment either in sails (which, however, are rapidly falling into disuse), or running-gear, or lifeboats, or such-like subsidiary requisites claim vigilant attention. Every now and then it is necessary to open-up, place in position, and expose all the various pump-gears, fire-hose, boat appliances, *et hoc genus omne*, for the annual inspection of the supervising authorities. Added to all these duties is, to a certain extent, the working of the freight at the quay side, for although this is controlled from the office by the freight department, it is necessary that the wharfingers and stevedores who manipulate it should work to suit the state of the ship.

Then comes the preparing for the voyage: seeing that the cargo and coaling is thoroughly completed; hatches and openings secured; decks washed down; and all made straight and fair, ready, with fit officers and crew, to receive the passengers and mails on the advertised date, and to pass the inspection, not only of the Government









officials, but also the critical and exacting scrutiny of the partners or managers themselves.

The third division of the "Outside" section—the victualling department—is also under the charge of a responsible Superintendent, to whom is intrusted the entire management of the stewards' department, the control of the outfit for the living-quarters both of the passengers and the leading sections of the crew, and the victualling throughout, including the supply of wines, medical requisites, and other articles necessary for the wants of so large a floating population. Besides the shore staff, the Superintendent is assisted on board by the purser, who generally takes charge of all the ship's papers and documents relating to finances, passengers, and freight; and who also, assisted by the chief and second stewards, supervises the working of the large staff required in the distribution of the saloon passengers in the berths and places assigned to them, in preparing for the daily meals, and in arrangements for cooking, baking, etc., so that the whole working may be such as to give satisfaction, insure cleanliness and secure all necessary attention to each individual, whether in the state-rooms, saloon, or smoking-room. Another of the important functions of these officials is that of keeping a check upon the supply of the immense quantities of food and drink which are in almost continual demand. Not an unimportant object of attention for the Victualling Superintendent is the rearrangement of his staff, with due regard to the perpetual fluctuation in the number of passengers, as at one time the vessel may be full, and at another have but few to

provide  
there is  
if too few  
tion com

To illu  
actual w  
only nec  
various d  
coming a  
ceived by  
Holyhead

On the  
ment divi  
is at once  
House, an  
to leave t  
take off  
passenger  
tender is s  
being info  
tender's d  
panies, an  
parations  
examinatio

With thi  
accompani  
officers wh  
port, and g  
passengers

On the a

provide for; so that, if too many hands are shipped, there is not work for them, and, on the other hand, if too few are shipped, the complaints of want of attention come in volumes from disappointed travellers.

To illustrate the elaborate system necessary for the actual working of a twin-propelled Atlantic liner, it is only necessary to describe the general routine of the various departments, beginning with the news of her coming arrival in the Mersey, which is generally received by telegraph from Queenstown, and again from Holyhead.

On the news being received in the general management division of the office, the expected hour of arrival is at once communicated to the Post Office and Custom House, and an hour appointed for the steam tender to leave the landing stage to meet the liner in order to take off first the saloon, and afterwards the other passengers, while if the mail be a heavy one, a special tender is set apart for it. The passenger department on being informed, generally communicates the hour of the tender's departure to the various hotels, railway companies, and others directly interested, and makes preparations for the landing of the passengers and the examination of their baggage by the Customs.

With this tender goes the Victualling Superintendent, accompanied by the Health and other Government officers whose duty it is to pass the ship for entrance into port, and grant permission for the disembarkment of the passengers.

On the arrival of the various papers and documents at

the office, the ship is entered at the Custom House and all the necessary formalities are gone through to allow the work of debarkation to proceed whilst the clerical department at once commences the work of sending out advices as to the supplies of coal, and the delivery of outward freight on quay for the next voyage.

The Marine Superintendent and his department, on hearing the time of arrival, make all arrangements to dock and berth the ship as soon as possible after arrival, and get ready for the discharge of cargo, and the re-coaling. After the vessel is docked, the crew are paid off in the presence of a Board of Trade officer as soon as convenient, and nowadays are at once signed on again for the next voyage. The chief officer then submits his "indent" for repairs, stores, and requirements for the next voyage, and this document guides the Marine Superintendent in his arrangements when the vessel is in dock.

As soon as the vessel is moored, work is commenced by the stevedores. The hatches are opened and the discharge of the cargo is busily proceeded with by a small army of men, some unloading and others coaling for the coming voyage. Immediately the holds are empty the reloading is commenced, so that no time is wasted, and it is no uncommon thing to discharge 4,000 tons of inward and load 3,000 of outward cargo, and also put about 2,000 tons of coal into one of these vessels in about two working days.

In the engineering department the work, although altogether out of the public sight, is much more exten-

sive. As staff is sta the boiler: pare the v

The sim the chief hands of t heavy wor shore staf gether res justment working a enormous consequent fully clean the whole makers an man, and a and second the fact t at sea.

In additi of the mac sundry rep only can be

After the disembarka his staff to articles de v trip, some l

sive. As soon as the engines are stopped, the large staff is started to wipe down the machinery, blow down the boilers, or otherwise let off steam, and generally prepare the whole for inspection and overhauling.

The simpler portion of this is done at once; and when the chief engineer's "indent" has been through the hands of the Superintending Engineer, the important or heavy work is proceeded with; both the sea-going and shore staff working conjointly, as the former are altogether responsible for the proper overhauling and adjustment of the moving parts, so as to insure good working at sea. The boilers after being cleared of the enormous quantity of ashes, soot, and rubbish, always consequent on such a large number of furnaces, are carefully cleaned out; if necessary the inside is scaled, and the whole is thoroughly overhauled by the ship's boiler-makers and the shore staff under an experienced foreman, and also under the keen supervision of the chief and second engineers, who are thoroughly alive to the fact that good work in port means less trouble at sea.

In addition to this work there is also the overhauling of the machinery in other parts of the vessel, and the sundry repairs required in the other departments, which only can be effected by skilled mechanics.

After the passenger department has finished with the disembarkation of the passengers, the chief steward turns his staff to clearing away and sorting the numerous *articles de voyage* which have been in use throughout the trip, some being put aside for next voyage, and others

sent to the company's works for repair or overhaul. Of these, by far the most extensive is the "linen," as it is generally termed, and it may be here mentioned that so extensive and complete are the laundries that the whole of the table and bed-linen for over 300 saloon passengers can be returned to the ship in the space of forty-eight hours ready for use, thoroughly pressed and aired. As soon as the clearing up has been done and the Victualling Superintendent has passed the "indent," the saloon, state-rooms, and other quarters, together with all furniture, are thoroughly overhauled and refurbished. The galley and pantry meanwhile are also being attended to by their respective staffs, aided here again by the shore staff, and the various cooking and serving utensils are replaced or sent to the works for repair. It is almost impossible for an outsider to realize the immense quantity of large and small articles which continually require repair or renewal in this department of large passenger vessels, and for the large liners an immense staff of tinsmiths is required to be continually at work, both in making new and patching up worn articles.

Another class of men kept continuously at extensive work are the carpenters and joiners, and also cabinet-makers, who, under an experienced foreman, are constantly engaged in the saloons, state-rooms, steerages, deck-houses, hatches, stores and crew's quarters. The elaborate and extensive lavatories nowadays required, also command the constant attention of experienced plumbers, owing to the labyrinth of pipe arrangements

in the ship,  
water.

Draughts  
and making  
continually  
provements

Besides al  
the ship, it  
and the wor  
time-keepers  
clerical depa  
to take char  
off. One off  
on board, an  
to act in case

In addition  
port, must be  
if there be a  
hap on the v  
Board of Tr  
senger vessels  
put in dry do  
attributed th  
existing on a  
also must be  
urged by com  
requirements,  
the safety and  
In order to  
specification which

in the ship, which supply fresh and take away the waste water.

Draughtsmen are also constantly occupied in noting and making drawings of the changes and alterations continually being effected, both to keep pace with improvements and to further economize.

Besides all these hands directly engaged in work about the ship, it is necessary to retain, both at the quay side and the works, a large staff of book-keepers, clerks, and time-keepers to attend to the extensive wants of the clerical department; and in addition, reliable watchmen to take charge during the hours when the workmen are off. One officer and engineer are also required to be on board, and certain others of the steamer's crew ready to act in case of fire or other casualty.

In addition to the overhauling for an ordinary stay in port, must be reckoned the very great extra work entailed if there be any heavy machinery to replace or any mishap on the voyage to repair, and also when the annual Board of Trade inspection required by law on all passenger vessels becomes due, as the vessel must then be put in dry dock. To this requirement must be largely attributed the excellent conditions and regulations now existing on all passenger vessels, although great credit also must be given to the enterprising owners, when urged by competition, for going even further than the requirements, in adopting all possible means to increase the safety and comfort of their passengers and crew.

In order to show the excellence of this annual inspection which is invariably carried out by the Board's



own Officials (men of tried experience), it will not be out of place to briefly describe the routine and conditions necessary to obtain the renewal of the passenger certificate. The first thing is to pay into a mercantile marine office the necessary fees, which vary in amount according to tonnage, at the same time giving notice of where the vessel is lying, and also the hour she will be ready in a graving dock for the purpose of allowing the surveyor to "sight," otherwise carefully survey the bottom, propeller, and all other fittings not visible afloat, which must be done before any painting or exterior work is effected. This is looked upon as the most vital point of the survey, the passenger certificate always dating from the day of sighting.

Other matters examined by the surveyors are the deck and other fittings and gear; the holds; and the hand and steam bilge-pumps, which must have all parts actually shipped in place, and the valves and interiors open for examination; in addition as many of the bilge strainer boxes as possible must be exposed, together with as many of the limbers,<sup>1</sup> in order to examine the state of the cement in bilges and to note any signs of working of the ship itself. The bulkhead sluices<sup>2</sup> must also be turned, the water-tight doors closed and opened, the handles and fittings for these being permanently attached or suspended in convenient position alongside. The fire-hose

<sup>1</sup> "Limbers," the spaces between the frames of the vessel in the bottom under the ceiling.

<sup>2</sup> "Bulkhead sluices" are the valves in the bilge-pipes, etc., running through the bulkheads.

must be cor  
out for insp  
connecting

The elabo  
attention;  
board the r  
and rowlock  
tiller ready  
breakers or  
each article

The capa  
boats — whi  
British but  
be up to stan  
capacities, w  
veyor; the b  
test the gear

All the sc  
cleaned and  
rockets, etc.,  
leads, must b

The anchor  
the official a  
in dry dock, t  
the bottom o  
backed out, so  
certificates of

A still more  
in the machin  
ing parts, suc

must be connected to the water service, and be stretched out for inspection with projecting nozzles attached, and connecting keys in place.

The elaborate equipment of boats has to receive careful attention; each must be uncovered and actually have on board the necessary sails, masts, yards, oars, thole-pins and rowlocks, attached with strong chains; rudder and tiller ready in place, plugs, bailers, two fresh-water breakers or casks, bread-tank, life-belts and axe, so that each article can be thoroughly inspected.

The capacities and lowering arrangements of the boats — which are strictly defined, not only by the British but also the United States authorities — must be up to standard, and a complete list of their sizes and capacities, when required, must be handed to the surveyor; the boats must also be lowered into the water to test the gear and their water-tightness.

All the scheduled signal and spare lamps must be cleaned and open for survey, the various foghorns, rockets, etc., for night signalling, and the sounding leads, must be submitted to inspection.

The anchors must also be cleaned and scraped, with the official and proof numbers distinctly visible, and, in dry dock, the whole of the cables must be run out in the bottom of the dock and have the shackle-pins all backed out, so that the numbers may be verified with the certificates of tests.

A still more extensive survey has to be gone through in the machinery departments; the whole of the working parts, such as cylinders, valves, pistons, pumps,

crank-pins, bearings, safety-valves, fresh-water condensers and other portions must be opened up for inspection, also the boilers both in the steam and on the fire sides; it is also necessary at stated intervals to take off the propellers and draw in the stern shafts for examination. This precaution is now generally taken every twelve months by most of the leading lines, a practice strongly to be commended.

In addition to these requirements all the official papers of the ship, namely, ship's register, the various certificates relating to the compasses, chains and anchors, and also those of the captain, chief and second officers, and chief and second engineers have to be presented for notification.

After all these steps have been completed, the Board's surveyor has to send to the principal office in Whitehall, London, a declaration made by him stating that the ship is complete in all requirements. On receipt of this the certificate is forwarded to the owners, which allows her to carry passengers for a stated period.

When it is remembered that, in addition to all these requirements, very extensive rules and regulations of the Board of Trade have to be complied with by the builders of the ship and machinery previous to the vessel's obtaining a certificate, it is evident that but little is left to be desired in the thoroughness of the protection afforded to the marine travelling public by the British Legislature; and when the enactments are carried out by the surveying staff with such ability, intelligence and willingness to help at all times as the author has ex-

perienced  
provide a s  
achieve a l  
fect workin  
that now r

True it i  
arise from  
some far-se  
on some ne  
proves a ne  
human life  
requirements  
even if outs

In additi  
ports, anot  
surveying s  
some ten y  
compulsory  
ports of the  
somewhat si

Returning  
as the adver  
side" section  
and all depa  
tried, and ev  
the "Inside  
work, definit  
first the stee  
saloon passen  
berth in the

perienced for over fifteen years, there is no doubt they provide a strong incentive to all concerned to aim at and achieve a higher grade of perfection in the safe and perfect working of high speed passenger vessels even than that now reached.

True it is that now and again murmurs of discontent arise from some enterprising builder or engineer, or from some far-seeing shipowner, who finds a restriction placed on some new untried advance; but if a successful trial proves a new idea to be satisfactory and safe so far as human life is concerned, which is the Board of Trade's first requirement, then ready acceptance may be obtained, even if outside the usual authorized forms.

In addition to this annual inspection in the home ports, another has nowadays to be undergone by the surveying staff of the United States Government, who, some ten years ago, enacted a law which rendered it compulsory for all vessels carrying passengers from the ports of that country to have a certificate, granted on somewhat similar conditions to the British regulations.

Returning now to the direct working of the ship: as soon as the advertised date for sailing draws near, the "Outside" section having had the work on board completed and all departments in order, steam raised and engines tried, and everything ready to receive passengers, while the "Inside" section has transacted all its portion of the work, definite dates are announced for the embarkation of first the steerage, then the second class, and finally the saloon passengers. This may take place at the loading berth in the company's dock, but more generally from

the landing stage, a notice of these hours being widely circulated. At a certain specified hour the official clearance takes place on board, which means the passing of the ship by the Health and Emigration officers, as well as by the Board of Trade, the Customs clearance having been arranged previously, so that the vessels may go out of dock into the river and await the passengers and mails.

The form of clearing a vessel is carried out by two Government officers, one being a sea-going officer of tried experience from either the Royal Navy or Mercantile Marine, and the other a fully qualified medical man; these two gentlemen upon arrival proceed to examine the steerage passenger accommodation as to sleeping, lavatories, exits, ventilation, and other necessaries; afterwards each individual steerage passenger, adult or child, has to pass the medical officer, to provide against the chance of any infectious disease on the passage. The medical outfit is subjected to examination, and the entire crew has to be mustered and pass the inspection of both officials, so as to insure their being fit and able men for their respective duties. A careful examination is also made of the lifeboats, some being lowered into the water, and often an inspection of other details, such as night signals and rockets, the supply of fresh water, freeboard, etc. The necessary papers being filled in and signed, the vessel is cleared, and ready to proceed to sea as soon as the saloon passengers and perhaps mails are on board.

The embarkation of the saloon passengers, which, as a rule, is the final scene, takes place from the dock or

g widely  
e official  
e passing  
icers, as  
clearance  
sels may  
ssengers

t by two  
r of tried  
ercantile  
cal man;  
amine the  
ng, lava-  
terwards  
d, has to  
chance of  
medical  
tire crew  
of both  
e men for  
n is also  
he water,  
as night  
reeboard,  
d signed,  
a as soon  
n board.  
hich, as a  
dock or



THE BURNING OF THE LIVERPOOL LANDING STAGE, JULY 28, 1874.



landing stage at a convenient time shortly preceding that at which the vessel gets under weigh, and is accompanied with much bustle and stir but no confusion, everything being done systematically.

The celebrated landing stage, which plays so useful a part in the coming and going of the Liverpool Transatlantic liners, is one of the most important appurtenances of the great port on the Mersey. Notwithstanding its close proximity to the surface of the water; it was completely destroyed by fire on July 28th, 1874. This disaster was occasioned by some workmen, who were working near the embayment in the stage, allowing a naked light to set fire to some of the creosoted wooden beams then existing below the deck of the stage, and owing to the inflammable nature of the material and to its inaccessibility, no effectual means could be found to extinguish it, so that the whole structure, extending nearly half a mile, was totally destroyed.

Some idea of the extent of the fire can be gathered from the illustration, which is reproduced from a photograph taken from the Birkenhead side about three hours after the fire commenced. No lives were lost, but the reconstruction of the stage occupied a considerable period, and entailed a cost of over £250,000.

Upon the a  
alongside  
attendance  
stewards  
steward, t  
berths, and  
the larger  
tender, bei  
specially s  
whole of t  
board and  
returns to  
and official  
permits, th  
supreme cl  
the naviga  
whose duty  
channels a  
There is al  
pilot, the f  
engine-room  
The chief  
port is in th

preceding  
s accom-  
onfusion,

so useful  
bl Trans-  
ppurten-  
standing  
r; it was  
4. This  
who were  
lowsing a  
d wooden  
age, and  
al and to  
found to  
xtending

gathered  
a photo-  
ree hours  
, but the  
le period,

## CHAPTER X.

### AT SEA ON AN ATLANTIC LINER.

UPON the arrival of the tender with the saloon passengers alongside the ship, the commander and officers are in attendance at the gangway to receive them, and all the stewards ranged ready, under the purser and chief steward, to direct them to their different rooms and berths, and attend to the removal of the smaller baggage; the larger baggage, which is despatched by another tender, being stowed by the deck department in quarters specially set apart for it. After a short period, the whole of the passengers and their baggage being on board and all ready for sailing, the tender leaves and returns to the stage with the owners or representatives, and officials of the company, and, if the state of tide permits, the vessel gets under weigh at once under the supreme charge of the captain, whose station is on the navigating bridge. With him is also the pilot, whose duty it is to navigate the vessel through the channels and passages for which he is duly licensed. There is also on the bridge, alongside the captain and pilot, the fourth officer, whose duty is to transmit the engine-room and steering orders.

The chief officer's position when leaving or entering port is in the bow of the ship, to attend to the working



of the anchor and other duties in that quarter; to attend to the stern, the second officer takes up his position on the poop; the third officer gives special attention to the prompt carrying out of the orders given to the quarter-master at the wheel, and so on, each officer having a proper station and duty assigned to him.

In the engine department, also, the duties of each of the staff are distinctly defined for the time of leaving and entering port, so that nothing is left undone to secure systematic working throughout.

After the vessel has got fairly under weigh and cleared the channel, the "stand-by," as it is technically termed, is dispensed with, and the duties are changed for the regular watches at sea, not to be changed again until the arrival off New York, except in event of foggy weather coming on at sea.

It is interesting to compare the recorded experiences of a passenger in one of the great Atlantic liners at different periods. In Dickens' "American Notes" we have a narrative relating to the year 1842, which notwithstanding the humorous vein in which it is written, is obviously a graphic and truthful account of an exceptionally bad passage. The book is so well known that we need not do more than refer the reader to it.

Mr. Hepworth Dixon describes life on a Transatlantic steamer in October, 1874:

How splendid are these passage boats! The "Republic" is a floating palace, with the style and comfort of a Swiss hotel.

I will not say she is better than the vessels in our track; but I have put my foot on many decks, and laid my head in





many berths, and I am perfectly content with the "Republic." After trying her for several days and nights in weather of roughest sort, even at the equinoxes, I am ready to despair of finding any vessel more completely to my mind.

A floating palace with 500 souls on board, we measure more than 400 feet in length, and have a saloon amidships, gay with gold and soft with cushions, in which the young ladies can flirt, and their elders dawdle over books and prints. The smoothness is remarkable, and the ventilating perfect, with the exception of one evening when we hold a concert; we breathe a fresh and bracing air that gives a wonderful keenness to the languid palate.

We have a host of little comforts, some of which are not to be had in a first-class Swiss hotel.

We have a good piano, and a real library of books, a smoking-room, a barber's shop, and a ladies' saloon. Each passenger has a printed list of his fellows, and a track chart of the ferry; so that he knows the persons on his right and left, and keeps a daily check on the officer who marks our log. The crew is perfect, from the captain, in whose skill and vigilance we put our deepest trust, down to his boy Tommy, a young and laughing scapegrace, who attends my own particular berth, and sees that there is plenty of iced water in my jug.

Through mist and storm we keep with singular fidelity to Commander or Lieutenant Maury's steam lane for outward-bound vessels.

Maury's lanes are now well known.

They were first laid down by order of the American Government, in order to avoid risk of collision in the fog. The outward lane lies to the north, beyond the influence of the Gulf Stream; the homeward lane to the south, in the strength of the current. They never touch each other; so that steamers keeping their course can never dash into each other's sides.

As a pi  
passenger  
the home  
as describ

The ocea  
the skies ar  
steadily plo  
ming lightl  
from the pr  
sengers hav  
good break  
are wander  
whiling awa  
decks bring  
everybody is  
up in the s  
successfully  
voyage is th  
absolute rest  
and the ligh  
the great ex  
without a s  
ship and her  
board, and t  
is an enforce  
grams vex,  
serenity of t  
lee side of th  
back at just

As a picture of the life on one of the finest of the passenger steamships of to-day, we may give a sketch of the homeward voyage on board the **City of New York**, as described by a passenger :

### I. THE OCEAN VOYAGE.

The sea ! the sea ! the open sea !  
The blue, the fresh, the ever free !

THE ocean voyage is two days old. The sea is smooth and the skies are clear. The great steamer **City of New York** steadily ploughs her way through the dark blue waters, skimming lightly over the indigo-hued waves that are thrown back from the prow with a ruffled edge of silvery foam. The passengers have become sufficiently confident to partake of a good breakfast, and in the enjoyment of contented idleness are wandering about the ship, or reclining in their chairs whiling away the time. The fresh sea air blows gently over the decks bringing its wholesome tonic. The chief thing that everybody is elaborately endeavouring to do, may be summed up in the single word—nothing. And how to do this most successfully seems the only apparent anxiety. The Transatlantic voyage is the best possible realization of the true meaning of absolute rest. The steamer has gone far away from the land, and the light blue sky and dark blue ocean meet all around, in the great expansive and almost limitless circle of the horizon, without a spot to break the line bounding the vision. The ship and her company have become all the world to those on board, and thus cut off from everything outside, the voyage is an enforced idleness. Letters cannot come, nor can telegrams vex, so that no business cares disturb the delicious serenity of the situation. Haunting a favourite spot on the lee side of the promenade deck-house, the easy chair is reclined back at just the proper angle for comfort. Looking lazily

out upon the passing ocean, seen between your toes, you fade away gradually into a semi-unconscious dreamland in blissful peace with all mankind. A book may for a moment divert attention, but the complete restfulness of the situation almost paralyzes the effort to read it, no matter how light the literature. The quick-moving machinery sings a constant lullaby, and makes the dreamland fancies come and go.

Fellow voyagers are scattered all about the spacious deck enjoying similar idleness, and as one looks out over the sea, the foam-streaked waves through which the steamer swiftly moves, rush by almost like the rapids of Niagara. The sunlight paints the waters blue, or leaden as the clouds may come to obscure it. The sharp half-hourly strokes of the ship's bell tell the passing time in the language of the sea, without regard to the accuracy of the landsman's time-piece, which is always getting behind. Then may come a spell of fog, and as the lookouts peer sharply forward, the powerful steam siren sounds its deep bass sonorous blast that goes far over the sea, to warn approaching vessels that may be enshrouded in the mist. Rapidly pushing ahead, the vast travelling hotel outstrips the clock, and daily greets the rising sun further eastward around the globe. Thus the voyage goes on, dreary in fog and storm, when everything on deck is wet and cheerless, but most pleasant on the bright days, when all hands come out to sun themselves. The sterner sort pedestrianize along the extensive promenade deck, discussing the probabilities of the voyage, and watching the heaving of the log that aids in measuring the distance sailed. And then the day wears away gradually into the night. The sun that has risen ahead of us and gone past, finally sets in its bank of cloud beyond the wake of the vessel. The full moon shines brightly over the waters, and when the pleasures of the time are ended, the cabin is sought, and the gentle motion of the ship rocks all to sleep.

At first t  
from the ru  
But after a  
there comes  
are now rel  
vessel is a v  
gossip abou  
constantly p  
to steam alo  
how distant  
bate, some h  
gulls, circlin  
waves; the  
—are subjec  
taking three  
snacks betw  
on the looko

After a lit  
nature asser  
foundland b  
the ship pro  
for a survey  
nificance of t  
where the sh  
a knife and t  
diagonally b  
under the bo  
figure-head o  
mentation is  
city, with otl  
ing promena  
forecastle co  
chains and ar  
less yet speed

At first this enforced idleness of the sea voyage—so different from the rush and hurry of business on land—is most delicious. But after a while the thoroughly rested mind is satiated, and there comes a growing anxiety for something to do. All things are now relished that give the mind employment. A passing vessel is a wonderful sight—all eyes watch her, and all tongues gossip about her. The wonder is great, that with all the ships constantly passing between the two Continents, it is yet possible to steam along for a whole day without seeing a sail no matter how distant. The banks of Newfoundland also cause much debate, some having the idea that they are a sort of dry land. The gulls, circling about the ship; the porpoises gambolling in the waves; the Mother Carey's chickens; and occasionally a whale—are subjects of interested study. And thus we go along—taking three or four meals a day to help kill time, with brief snacks between on deck—and like Columbus are constantly on the lookout for land.

After a little more time spent in idle dreaming, the vigour of nature asserts itself more and more, and as we cross the Newfoundland banks, the bright sunshine and smooth sailing of the ship prompt to exertion. Then one is ready to start out for a survey of the vessel, and to realize the extent and magnificence of the "City of New York." And first to her prow, where the sharp bows cleave the water, cutting the waves like a knife and throwing a spray-cloud on either side that runs off diagonally backward, covering a long wave of foam. From under the bowsprit there looks down upon the water the fine figure-head of a goddess of the seas, whose surrounding ornamentation is an adaptation of the coat of arms of New York city, with other appropriate designs. The gradually narrowing promenade deck extends up to the prow, its expanded fore-castle covered with great capstans and windlass, huge chains and anchors, and derricks rising above, that by noiseless yet speedy hydraulic power move the anchors and power-

ful cargo lifts. As the ship speeds along, the constant lookout seaman stands peering out over the ocean ahead to give timely notice to the officers back on the bridge, of everything coming in sight. Breakwaters cross the deck behind the anchors, to divert any flow of water that may be shipped over the bows, and abaft the forecastle is a railing marking the forward limit of the passengers' promenade.

In its extent and attractiveness, this promenade is something unparalleled in the construction of ocean passenger ships. Looking astern from the forecastle, the broad surface on each side of the deck-house stretches back for over five hundred feet. This broad surface on either hand is divided longitudinally by a centre railing. Within the spaces between the railings and the deck-house, the passengers are reclining on their easy chairs, clothed in all sorts of picturesque costumes in their rugs and wraps, and lying about in the most comfortable if not the most graceful attitudes. All colours of the rainbow and all styles of yachting and picnic fashions are displayed in this parterre of chromatic steamship luxury, bordered on one side by the white wall of the deck-house, pierced with its row of little round windows, and on the other side by the deep blue sea. Outside the railing is the wide and unobstructed promenade stretching almost from stem to stern, where scores are pacing briskly along the deck taking their morning "constitutional," while others lean over the ship's side watching the restless sea and the distant fishing vessels that are numerous on the banks. At the forward end of the deck-house rises the high rounded glass-covered dome of the grand saloon, having in front of it the ponderous foremast of the ship, with its spars and furled sails, and well aloft the foretop, a circular railed-in space, where, in time of storm and fog, and sighting land, an additional lookout is stationed. On either side of the deck, in front, are the huge cylindrical structures in which are carried at night the steamer's port and

starboard—  
shafts whi  
motors wh  
plies of fre  
the more m  
ing game  
shoved alo  
the ship ma  
leeward sid  
stands the  
the lookout  
earliest gli  
Isle.

High abo  
crosses the  
quarters"  
guiding the  
sea, while a  
controls the  
the radder.  
room, and t  
ship is sailin  
covers the f  
swift progre  
drives ahead  
and chart-ro  
course and  
nautical mat  
three huge b  
band, the esp  
out of them,  
ally away fro  
shovelled int  
on either sid



starboard—red and green side-lights—while in the ventilator shafts which rear their hooded tops above the deck, electric motors whirl the busy fans about and thus give constant supplies of fresh air in the apartments below. Here also labour the more muscular passengers at the exhilarating yet tantalizing game of "deck billiards," the flat wooden discs, when shoved along, gyrating in wayward fashion, as the motion of the ship may give them an unexpected twist down towards the leeward side. And here also, at the furthest forward point, stands the anxious voyager, who wishes to divide work with the lookout, and anticipating the end of the journey, get the earliest glimpse of the approaching shores of the Emerald Isle.

High above the promenade deck, just abaft the saloon dome, crosses the "bridge," or as it may be termed, the "head-quarters" of the ship. Upon it stand the officers on duty guiding the vessel, with constant eye upon the compass and the sea, while an obedient seaman quickly acting upon any order controls the adjacent tiller, which by hydraulic power moves the rudder. Close alongside are the signals to the engine-room, and the "tell-tale" showing by a dial the course the ship is sailing and disclosing the slightest deviation. Canvas covers the front of the bridge to keep off the wind, for the swift progress creates an almost constant gale as the vessel drives ahead. On another bridge beneath are the wheel-house and chart-room with the captain's quarters, and here the ship's course and progress are worked out by abstruse systems of nautical mathematics. Behind the bridge in succession rise the three huge black smoke stacks, each with its white encircling band, the especial mark of the Inman line. Heavy smoke pours out of them, and is carried by the wind in a long dark line diagonally away from the vessel for miles over the sea, as the coal is shovelled into the furnaces below. Rising also from the deck on either side of these great stacks are the six large air "in-



draughts" that supply these fires. Powerful fans drive the air down them into the enclosed spaces around the stoke-holes, so that the furnaces are kept constantly aglow by this abundant draught of fresh air, which can only find its vent through the fires and thence into the stacks. Behind the bridge, stretching far abaft, and carried on either side of the deck-house high above the promenade, is the long double line of the vessel's life-boats, each with its davits and tackle rigged for instant use, and having a spacious platform beneath to aid convenient working.

Extending our promenade beyond the stacks, we come to the engine hatches, and through their open port-holes in the sides, one can peer far down below and see the broad cylinders with their intricate surroundings of valves and machinery, and their quick-moving piston rods darting up and down as each revolution of the screw-shaft drives the ship along. A flush of heat and an odour of steam come up to tell of the forces moving the ponderous machinery, yet all goes smoothly and well. At intervals there are passage ways opened through the deck-house to give convenient access between the two sides of the ship; and these also contain the entrance doors to the suites of apartments that are so attractive to the traveller. Each suite has its drawing-room, boudoir and bed-chamber, a little flat in miniature, with lavatory and bath, and windows looking out upon the sea. Sofas and wardrobes abound, they are converted into beds at night, and the methods of combining comfort with luxury are unique, making them spacious and attractive to a degree unusual on shipboard.

The mainmast rises through the afterpart of the promenade deck-house, while at some distance further astern, a railing crosses the deck to divide off the second cabin space, these passengers being allotted the afterpart of the promenade. Their space is the full width of the broad deck for over one hundred feet in length extending back to the stern; and under

its protecti  
accommoda  
thing heret  
leading dow  
cabin walk  
which is ju  
from the wi  
its centre ri  
to the mast,  
sengers are  
deck gettin  
sage they e  
and sing wi  
good time v  
how to enjo  
and complet  
for use when  
as she is des  
At the very  
and from wh  
ing vessels.  
are hung life  
notice shoul  
sea boils up i  
white line to  
the displaced  
she has just  
twin screws,  
over the rail.  
clear blue wa  
under the su  
distance beh  
artillery.

As we swif

its protecting awnings these second cabin passengers have an accommodation exceeding in comfort and actual luxury anything heretofore provided for them, with a broad stairway leading down to their dining-saloon. The people from the first cabin walk back here, and envy them this wide and level deck, which is just the place for a dancing-floor, and is sheltered from the winds by the protecting deck-houses in front. From its centre rises the mizzen mast, with the spanker clewed up to the mast, ready for use if needed. A hundred or more passengers are reclining in chairs or lying about this spacious deck getting much the most comfortable Transatlantic passage they ever experienced. They nurse their babies, gossip and sing with music and games, and have generally that very good time which people in their walks of life know so well how to enjoy. Near the stern upon this deck, are compasses and complete steering gear, with starting and stopping signals, for use when the vessel is backing or is guided from the stern, as she is designed to be moved as readily backward as forward. At the very stern is the little mast bearing the ship's colours, and from which are displayed signals of recognition to passing vessels. Upon the circle of railings guarding the stern are hung life buoys ready to throw into the sea at a second's notice should any one fall overboard. Behind the ship, the sea boils up in a maelstrom of foam, which flows away in a long white line toward the western horizon, marking the wake, as the displaced waters rush in to fill the chasm through which she has just passed. Beneath us quickly revolve the great twin screws, one on each side of the rudder, and as we look over the rail, the rush of the blades can be seen through the clear blue water, making the beautiful spirals of air bubbles under the surface that gradually rise and burst out a short distance behind in white explosions like the smoke of artillery.

As we swiftly cross the banks of Newfoundland there are

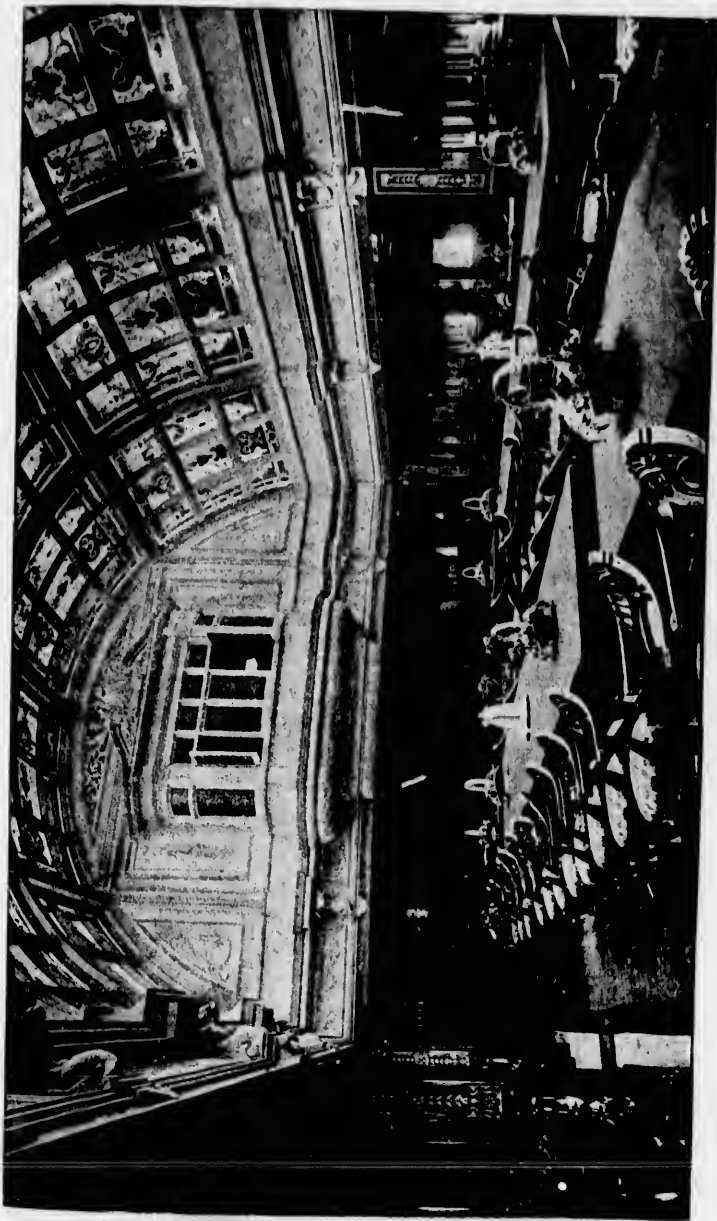
vessels all about us. Some are steamers speeding westward to America; others are merchantmen with all sails spread, plodding over the sea and displaying their signal flags, being anxious for report to owners at home. But most of them are fishermen—little schooners rocking upon the waves, with their fleet of dories trailing behind, waiting for a school of cod or mackerel to come along, and their skippers probably having decided opinions about fishery treaties and the international questions arising over the supply of bait. The sight of these fishermen upon the banks causes a sensation among the passengers, for it does not take much to stimulate us now that a full complement of restfulness has been obtained. We pass close by one or two of them, and see their trawls and ready baited hooks in the dories, and the crew give us a cheer, although we gaze upon them rather with a feeling of pity at the enforced hardships of their lives. Yet they are all happy, with little care excepting that the approaching steamer may disturb the fish and stop them biting, or, if in fog, threaten to run the dories down.

The keen and bracing air as we have roamed about the spacious promenade deck has again prompted the appetite, and the passengers are quite ready for the welcome gong summoning to lunch. The mid-day meal is the natural prelude to a brief siesta on the luxurious deck chair, where, wrapped in rugs to keep out the cold, the breeze and motion induce to sleep. After this refreshment the survey of the magnificent vessel is resumed. In the forward portion of the promenade deck-house doors open from either side into a spacious rotunda, covering the stairway leading down to the grand saloon. This makes a hall about thirty feet wide, beneath which the cabin stairway descends with strong broad balusters, and easy steps. Just behind this hall on the promenade deck, doors open into the library. We wander into this gem of an apartment, cosily located between two of the smoke stacks, around one of which



restward  
spread,  
s, being  
them are  
with their  
of cod or  
y having  
rnational  
of these  
the pas-  
ow that a  
We pass  
nd ready  
a cheer,  
of pity at  
ll happy,  
mer may  
reaten to

about the  
appetite,  
ong sum-  
prelude to  
rapped in  
induce to  
agnificent  
romenade  
s rotunda,  
oon. This  
the cabin  
asy steps.  
open into  
ent, cosily  
e of which



SALOON OF THE CITY OF NEW YORK.

the books are arranged in their bright bindings, while the other makes the back for a semi-circular ottoman. Luxurious sofas are placed all around this pretty room, and ladies sit at the tables writing letters to those at home. Upon the walls, which are finished in light coloured ornamental woods, elegantly panelled and carved, medallions bear the names of the leading authors of America and Britain. The round windows have glass screens richly engraved with poems of the sea, and an octagonal sky-light pours a flood of warm mellow light upon the writing tables below, while at night the electric lights give brilliant illumination. Here the passengers, when the air is too fresh outside, come in to rest and read, or write their letters and study maps and railway time books in preparation for the landing.

Another equally beautiful apartment is located forward of the stair-hall—the ladies' drawing-room. Pretty sky-lights here send down their mellow radiance upon the rich ottomans and carpets, and mirrors reflect the beauties of the finely decorated walls, whose elegant panels are surmounted by a gorgeous ceiling. Here gather the ladies and children, and as the piano plays they look out of the side windows at the steadily passing sea with its foaming "white caps" bubbling everywhere in the sunlight, or through the attractive little oriel that overlooks the dining-saloon below.

The grand dining-saloon is one of the chief achievements of the builders of this great steamer. It seems as if it were at least eighty feet long and fifty feet wide. The broad stair-way leads down to the entrance where one comes in through wide glass doors, having on each side the capacious side-boards over which the food is served, while behind these are the pantries with their supplies of glassware and crockery, and the hot plates. Opposite there rises a miniature Grecian temple portico above a balcony whereon is placed an organ. Between them is a broad space, over which is elevated the

great door  
glass ad  
beneath,  
with its  
All the k  
smell, or

The de  
of colour  
and its d  
trast with  
table serv  
sea air are  
the passen  
of this spl

Passing  
hall is the  
labyrinth  
with bath  
improven  
each side  
children's  
tage the s  
upon their  
the motio  
turn the l  
cealed in s  
duty shove  
steam for  
air-tight en  
downward  
freshing to  
and burn.

Abaft th  
the prome

great dome of the saloon, its high archway of richly coloured glass admitting a flood of light upon the dining-tables beneath, from which on each side stretch cosy alcoves, each with its little round windows looking out upon the waves. All the kitchens are hidden on the decks below, out of sight, smell, or hearing.

The decoration of this grand saloon, and its blending of colours are most pleasing. The white dome interior, and its delicately coloured stained glass, are in artistic contrast with the rich hues of the walls and the elegance of the table service. It is no wonder that the appetizing qualities of sea air are aided by these attractive surroundings, in making the passengers almost all the time seek the solid enjoyments of this splendid refectory.

Passing further aft, upon the saloon deck behind the stair-hall is the children's dining-room, and then one gets among a labyrinth of state-rooms and interior apartments of the ship, with bath-rooms and lavatories, all constructed with the latest improvements; and finally comes to the engine hatches, one on each side of a central hallway, used also as an auxiliary children's dining-room. Here can be seen to greater advantage the swift-moving machinery, with the engineers climbing upon their iron ladders deep down below, as they oil and watch the motions of the ponderous engines whose cranks lightly turn the heavy screw-shafts beneath. The boilers are concealed in spaces forward, where forty firemen are always on duty shovelling the coal into fifty-four furnaces creating the steam for the enormous power of the ship. Within the large air-tight enclosed spaces around the stoke-holes, the powerful downward air current always gives a cooling draught most refreshing to these perspiring firemen, as it makes the fires glow and burn.

Aft the engine hatches, another stairway leads up to the promenade deck, and beyond it is the smoking-room,



having a comfortable barber's shop as an adjunct. This smoking-room, as broad as the ship and as long as it is wide, has many comfortable seats and little tables lighted from the sky-lights above. Here usually assemble the greatest travellers and nautical luminaries of the ship. Many are the tales told in this attractive assembly-room, as the veterans spin their yarns and discuss every topic. And in the evenings, when the trials and enjoyments of the day are ending, here gather the active spirits who spend their time guessing the distance travelled; for no subject creates more interest and even excitement than the discussion of the ship's daily run. What pleasant memories cluster around this attractive smoking-room of the "City of New York," where sometimes a hundred people congregate as participants or auditors of some debate of grave import evolved from the events of the voyage.

As the night wears on, one after another leaves the group, and seeking the state-room turns into the little bed, with the gentle motion of the ship rocking all to sleep. And thus, in the ocean crossing, the day and night pass away, as with monotonous regularity the great twin screws drive the ocean monster forward, while the constant wash and swirl of the waters unite with the vibration of the machinery in singing our soothing lullaby.

## II. THE ARRIVAL.

Britannia needs no bulwarks,  
 No towers along the steep;  
 Her march is o'er the mountain waves,  
 Her home is on the deep.

IN crossing the Atlantic, one is forcibly reminded of the poet Campbell's lines above quoted. Britannia's march is certainly over the mountain waves, and her home is on the deep, if the universality of the British flag on all the vessels

we have pa  
 be otherwi  
 the comme

In the gr  
 sea voyage  
 that we ha  
 traced out  
 when they  
 dissipated,  
 Cow, and C  
 which the s  
 over the wa  
 adjacent to  
 tallest abou  
 broadest the  
 behind as th  
 being the C  
 and consequ  
 being with F  
 to the Engli

Then, in t  
 hold headlan  
 dented inter  
 beating again  
 the water fr  
 these was th  
 by the signal  
 her signal fla  
 her arrival  
 Queenstown  
 miles off sh  
 known as Fa  
 This great p  
 there to bear

we have passed be any indication. Possibly some day it may be otherwise, but now the Union Jack flies over almost all the commerce of the North Atlantic.

In the grey of an early morning the dull monotony of the sea voyage was most pleasantly broken by the announcement that we had sighted land. With gladness the passengers traced out ahead the dim outline of the Emerald Isle, and when they had rubbed their eyes and the haze was somewhat dissipated, the steamer passed the noted rocks of the Bull, Cow, and Calf, with the lighthouse on the Calf Rock towards which the steamer had been pointing in all her long journey over the waste of waters. These are three curious isolated rocks adjacent to Cape Clear, and far out from the mainland, the tallest about two hundred feet high, being the Bull, the broadest the Cow, and the little fellow modestly coming along behind as the procession travels apparently towards the shore, being the Calf. The latter is nearest the path of vessels, and consequently has the lighthouse, the Calf Rock Light being with Fastnet, famous as the beacons making the approach to the English Channel.

Then, in the early morning, the steamer passed the high, bold headlands of Ireland, which project with deeply indented intervening bays, and have a white fringe of breakers beating against the bases of the cliffs falling sharply off to the water from the table-land above. Among the first of these was the bold promontory of Brow Head, surmounted by the signal station, and as we passed the steamer displayed her signal flags which were answered from the shore, whence her arrival was quickly flashed by telegraph forward to Queenstown and England, and back to America. About six miles off shore is the remarkable pyramidal pile of rocks known as Fastnet, and we sailed between it and Brow Head. This great pile far out in the sea looks as if especially put there to bear the great revolving flashing light which thus



guards the Channel entrance. On the tops of the more prominent headlands along this rock-bound coast are other little white lighthouses, with their buildings and enclosing walls also painted white. The blue waters of the ocean have turned green as they bathe these shores, upon which not a tree is to be seen. The highly cultivated fields, divided by their green hedge-rows, extend down to the edges of the cliffs, whence one might fall hundreds of feet into the breakers below, while here and there the indented bays open up smiling valleys, with little clusters of thatched cottages scattered over the landscape. And thus as Ireland passes in review the debate among the passengers about her misfortunes is opened, and one is reminded again of the poet Campbell and his plaintive lament :

There came to the beach a poor exile of Erin.

Our steamer moves swiftly past the frowning promontory renowned in song and story, the "Old Head of Kinsale," surmounted by its tall, white lighthouse marked with encircling red rings, indicative of the bright red light it sends far over the sea. Then the vessel rounds the more modest cliffs of Robert's Head, to reach the "Cove of Cork," halting off the entrance of this pretty bay at Roche's Point, marking the end of the ocean voyage of about 2,800 miles from Sandy Hook. We gaze through the narrow passage in which we have halted, at the green hills within the harbour so dear to every Irishman's heart. Queenstown lies behind the point, and on either hand inside are the forts guarding this important haven—Rocky Island with its excavated chambers holding vast stores of gunpowder, and Haulbowline Island with its huge fresh-water tank hewn out of the solid rock. Farther in is the noted penal settlement of Spike Island. A little steam tender, dancing like a cork on the waves, comes out from the harbour and fastens alongside us, while the passengers and their

luggage for  
much amu-  
sive decks,  
that the no-  
and comica  
bags and l  
down the g  
are transfe  
off into the  
she goes in

Almost h  
resumed a  
Ballycotton  
brown field  
at intervals  
sloping from  
towards W  
takes a lon  
George's Ch  
other lighth  
the route li  
diagonally  
the little tug  
starting, in  
As we move  
sight on the  
on the left;  
and with Di

Sometimes  
be favourable  
of the lighth  
lands of Wal

luggage for Queenstown are taken off. This transfer gives much amusement to the large audience on the steamer's extensive decks, who have been so long without such entertainment that the novelty brings them all out to watch the dexterous and comical gyrations of their compatriots who with multiplied bags and bundles are trying to look dignified as they slide down the gangway-plank to the tender: Then the mail-bags are transferred, and with parting cheers she briskly paddles off into the harbour, leaving a long stretch of foam behind as she goes in among the hills.

Almost before the tender has started away, our voyage is resumed along the southern Irish coast, past the rock of Ballycotton and its lighthouse, and a panorama of green and brown fields, little white cottages, and grey towers scattered at intervals, the cloud shadows chasing each other along the sloping fronts of bays and headlands. Then the shores recede towards Waterford, and the steamer, distant from the land, takes a long stretch around the south-eastern coast to St. George's Channel. Another isolated rock—Tuskar, with another lighthouse surmounting—marks the turning point, and the route lies between Ireland and Wales, the ship moving diagonally across the channel to Holyhead. Here are seen the little tugs towing the ships down from Liverpool that are starting, in some cases, on long voyages around the world. As we move along, the rock-bound coast of Wales comes in sight on the right hand, the Irish coast having disappeared on the left; and here is got the earliest view of old Albion, and with Dibdin our English passengers exclaim:

O it's a snug little island!

A right little, tight little island!

Sometimes the distant peak of Snowdon can be seen if the day be favourable, but night has come upon us, and under guidance of the lighthouses, the steamer passes around the great headlands of Wales—Holyhead and the Great Orme's Head, pro-

trading northward not far away from the Mersey. Entering the low shores of its estuary, this famous river is ascended, and the anchor is dropped in front of Liverpool, the greatest seaport in the world. Its docks stretch for miles along the river front, protected by their massive granite walls; and are filled with shipping whose masts rise among the spacious storehouses. In the early morning a steam tender comes out and takes off the passengers and their luggage, carrying them to the landing stage, where there is a brief customs inspection and a hurried good-bye. We bid farewell to the noble ship that has so safely carried us over the sea, and the Transatlantic journey is ended:

Still they must pass! the swift tide flows,  
Though not for all the laurel grows.

Perchance in this beslandered age  
The worker, mainly, wins his wage;  
And time will sweep both friends and foes  
When Finis comes!

J. C.

ALTHOUGH  
been gener  
mentioned,  
the change  
ferent time  
type, which  
of the Arct  
pool, Presid  
their finish  
pressures, s  
them the c  
aged as mu  
horse-power  
used was th  
its purpose  
large area c  
require com  
The press  
that in the  
one occasio  
it with can  
pressure," r  
inch! So

Entering  
ascended,  
the greatest  
along the  
s; and are  
e spacious  
comes out  
ying them  
inspection  
noble ship  
unsatlantic

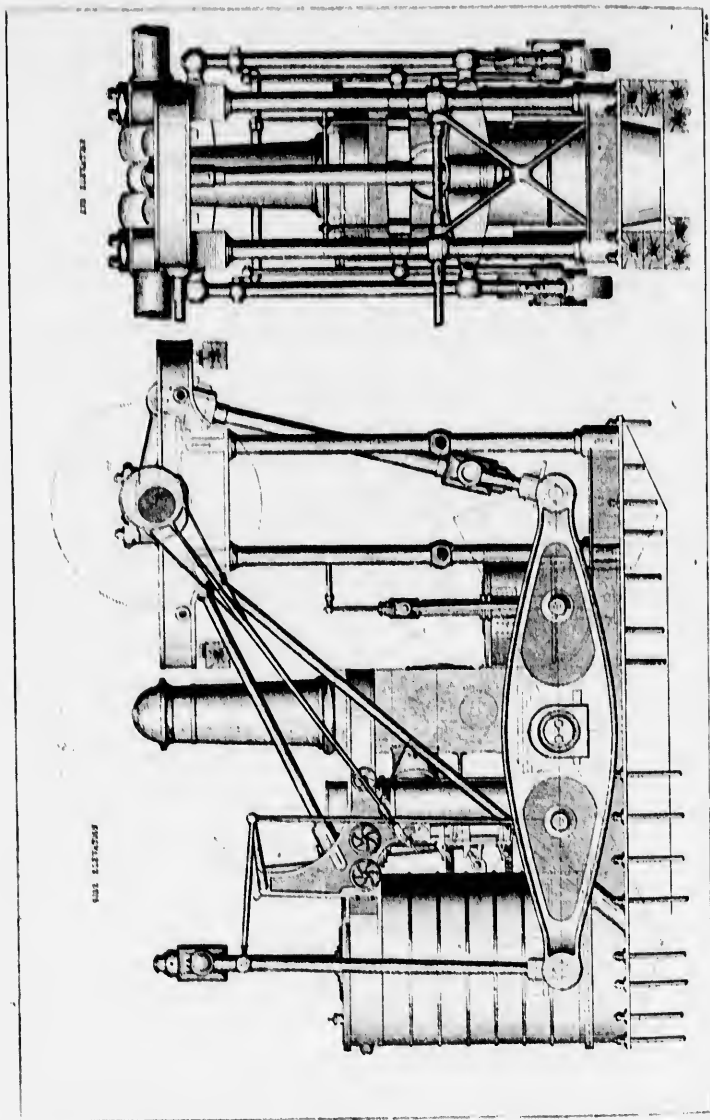
J. C.

## CHAPTER XI.

## MACHINERY OF ATLANTIC LINERS.

ALTHOUGH the type and construction of the engines have been generally defined in noting the steamers already mentioned, it may not be uninteresting to briefly review the changes in design of the machinery in use at different times. The first engines were of the side-lever type, which is illustrated by the sketch of the machinery of the *Arctic* (p. 174). The earlier engines in the *Liverpool*, *President*, and *Sirius*, were all of this type, but lacked their finish and completeness, and also carried lower pressures, such as 5 lbs. and 8 lbs. per square inch; with them the consumption per indicated horse-power averaged as much as 6 or 7 and even 8 pounds of coal per horse-power per hour. The design of boilers generally used was that known as the return-flue boiler, and served its purpose until the pressures became too high for the large area of flat surfaces exposed, which were found to require considerable staying.

The pressure carried in the earlier days was so slight, that in the log book of the *Britannia* it was recorded on one occasion: "Broke the larboard steam-pipe, lapped it with canvas and rope-yarn and proceeded with low pressure," meaning evidently 4 lbs. or 5 lbs. per square inch! So much has been noted of this old vessel, that



ENGINES OF THE U.S. MAIL STEAMER ARCTIC, 1849.

CHAP. XI.]

it is interesting to see the designs of the engineers who were employed on the Arctic. Mr. Peter B. Wainwright, third, Mr. J. M. Smith, who afterwards became a naval officer, and Mr. J. M. Smith.

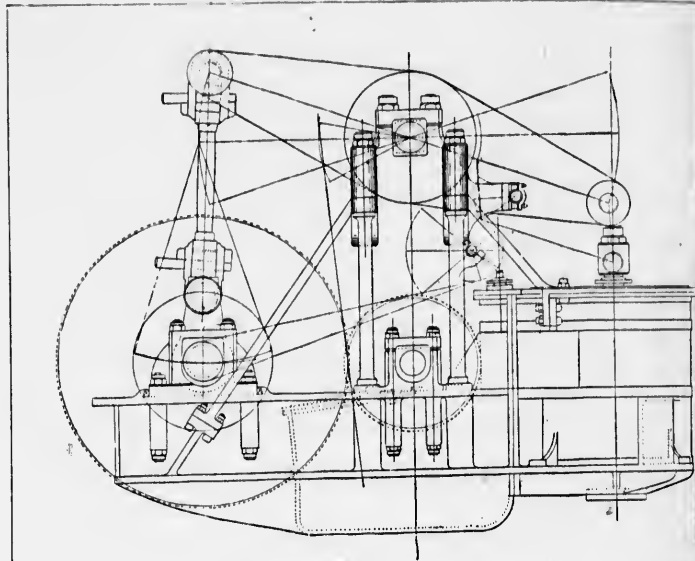
The design of the engines for the paddle steamer Scotia, the first of a favourite class of engines for screw propellers, is an arrangement of the engines on the port side, p. 176. It was on the port side of the other end of the spur-wheel, the forward engines were placed which the forward engines.

This system of engines were then kept down to the required if the crank-shaft revolutions per minute, which from 40 to 80 then considered.

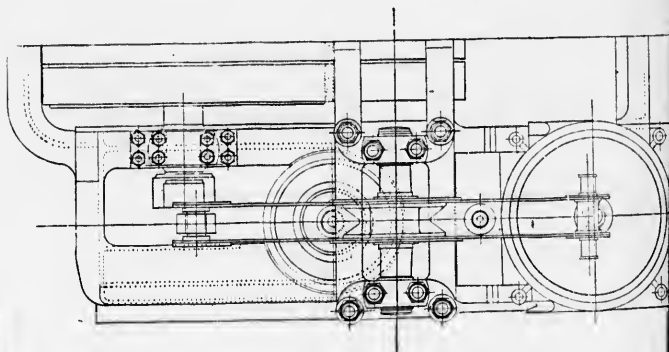
it is interesting to here give the names of the first engineers who served on board. The chief was named Mr. Peter Kenneth; the second, Mr. Thomas Brown; the third, Mr. James Bell; the fourth, Mr. Robert Waddell, who afterwards rose to be chief engineer of the *Scotia*; and Mr. James Wardrop, fifth.

The design of the side-lever engine being fairly suitable for the paddle-wheels, was generally retained down to the *Scotia*, the last of the side-lever type, and it was still such a favourite as to induce modifications of it being retained for screw propulsion in the form of a beam-engine. The arrangement of this type is illustrated by the diagram of the engines of the Cunard steamer *Etna*, built in 1855, on p. 176. It will be noticed that the two cylinders are placed on the port side to work vertically up to the beam, the other end of which is connected to the shaft on which the spur-wheel is keyed; this wheel gears into a pinion on the forward end of the propeller-shaft, and, with a view of obtaining a good disposition of the weights, the wheels were placed between the forward and after engine, of which the forward one only is shown on the sketch.

This system of gearing for screw engines of what were then considered large power, was introduced to keep down the high piston speed which would have been required if the engines had had their piston-rods and crank-shaft connected direct to the screw-shaft, the revolutions for a side wheeler ranging from 14 to 18 per minute, whilst those for the screw-shaft required to run from 40 to 80, 90 and sometimes even 150, which was then considered much too fast for ordinary wear and tear.



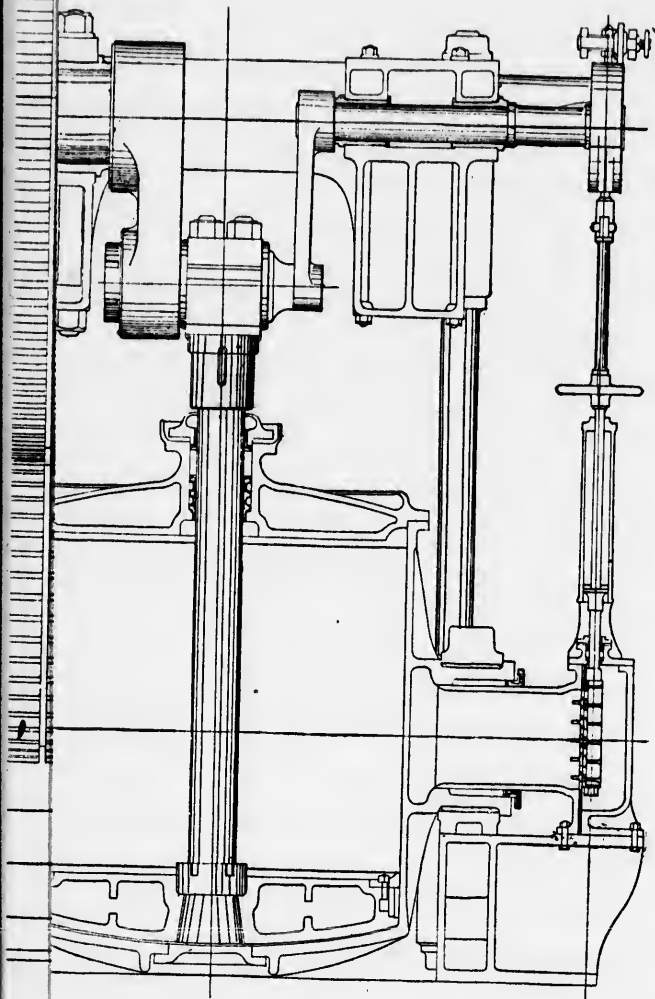
End Elevation, Looking Aft.



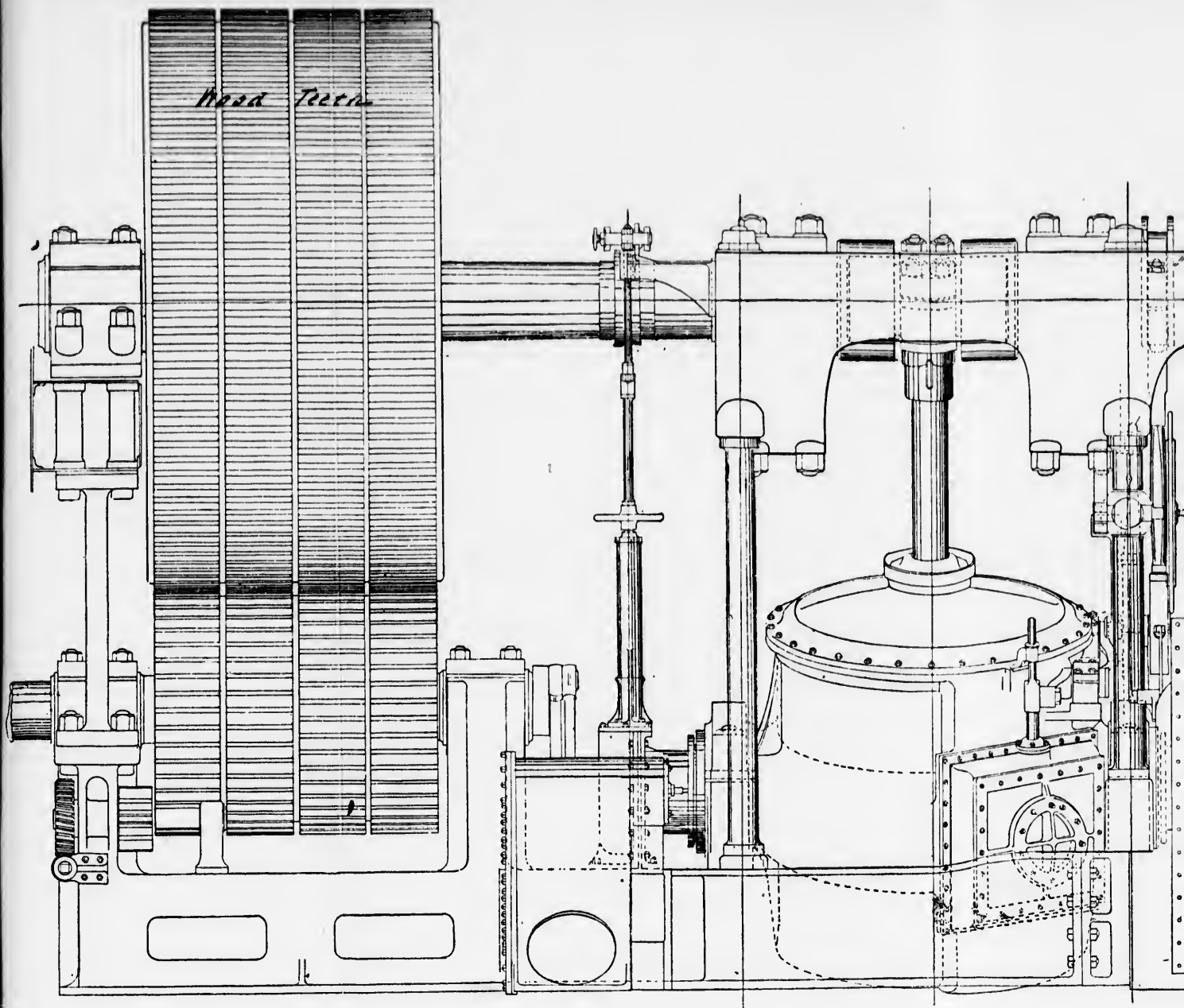
Half Plan.

ENGINES OF ETNA, 1855.

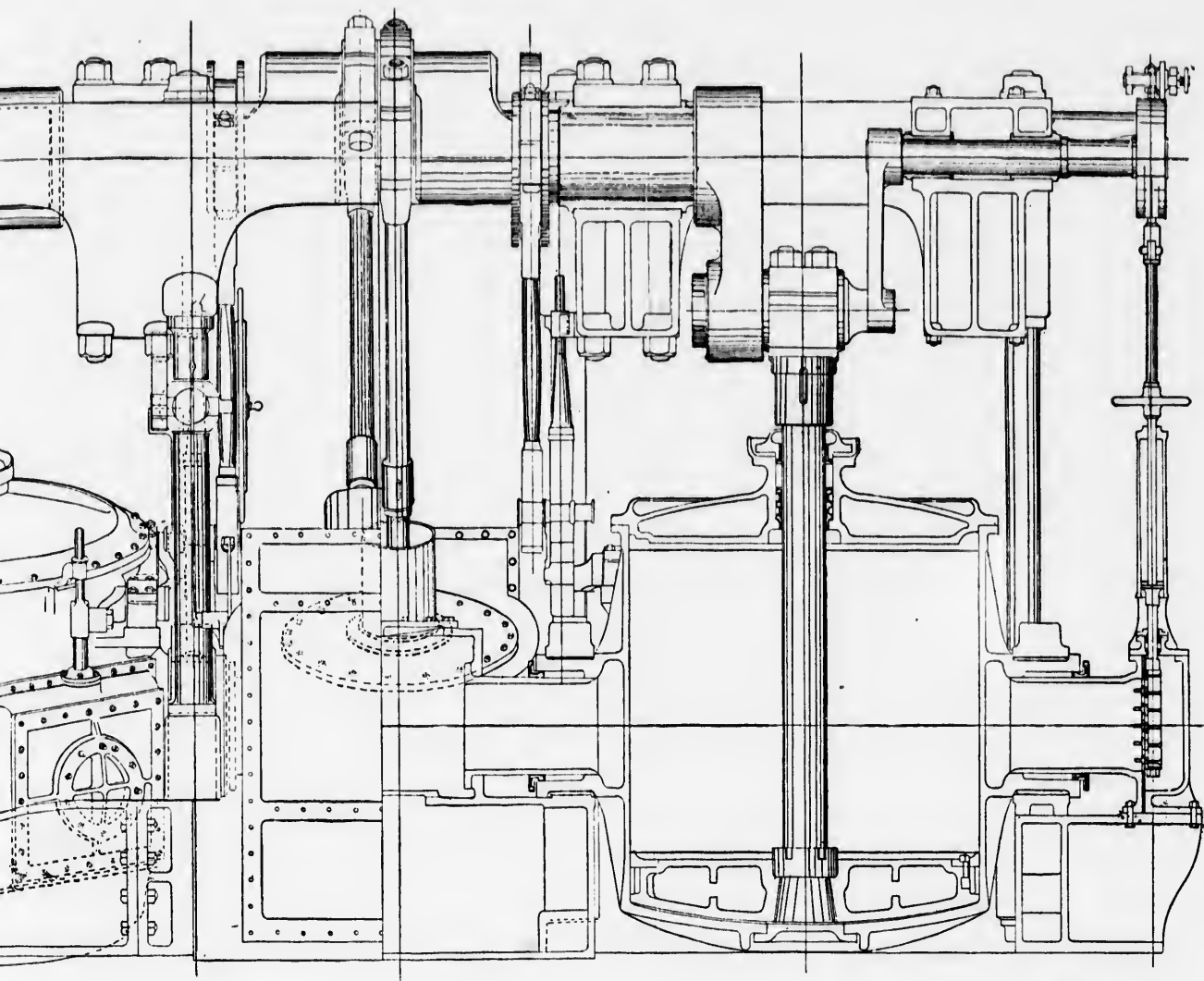








ENGINES OF THE CHINA.



S OF THE CHINA.

Face page 176.

An in  
differen  
wheel  
engines  
who ha  
the slow  
He was  
engines,  
given to  
a momen  
handling  
slow her  
“They a

answered  
else to t  
engine-ro  
not be sa

Another  
on the an  
first Tran  
cylinders  
the crank  
spur-whee  
the pinion  
great nove  
face conde  
up, owing  
tubes tigh  
brought fo

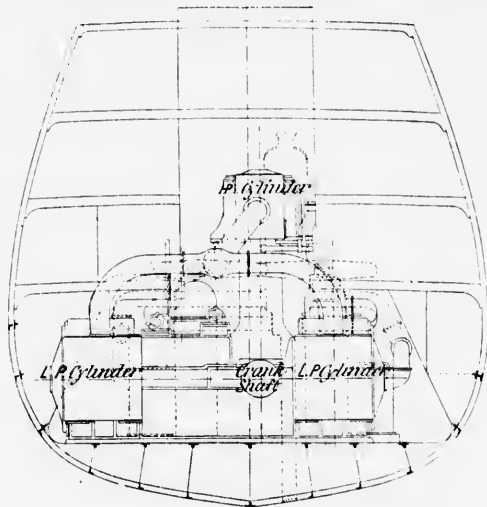
Another

An interesting anecdote, which illustrates the marked difference between the relative velocities of the paddle-wheel machinery and the direct-acting inverted screw engines, is often told of one of the older chief engineers, who had been transferred from the charge of one of the slow-moving paddles to a quick direct acting screw. He was struck by the apparent working full speed of the engines, although the order from the bridge had been given to go slow ahead; after surveying the situation for a moment, he called out to the second engineer, who was handling the engines, "The order is to go *slow*, better slow her down at once." To this the second replied, "They are going dead slow," on which the chief at once answered, "Is that so? Well, they may get some one else to take charge of this job, for I won't be in the engine-room when they are going full speed, as it would not be safe, they are sure to fly to pieces."

Another form of engine with gearing, was that shown on the annexed plate, which is after the form fitted in the first Transatlantic Cunard screw steamer the **China**. The cylinders are of the oscillating type working upward on the crank-shaft, on the after end of which is keyed a large spur-wheel fitted with wooden teeth, and gearing direct to the pinion on the screw-shaft by four sets of teeth. One great novelty about these engines was the fitting of a surface condenser, which, although tried earlier, was given up, owing to the difficulty experienced in keeping the tubes tight; by this time, however, it was again being brought forward and made serviceable.

Another form of geared engine for screw propulsion,

was the steeple type introduced in the earlier Inman steamers. Considerable trouble was experienced in all these engines with the gearing, owing to the heavy wear, which required constant renewal of the wooden teeth, and it was eventually found that they gave more trouble than the engines connected direct on to the screw-shaft.



*Section at X Y Looking Forward.*

**THREE CYLINDER COMPOUND ENGINES, MONTANA AND DAKOTA.**

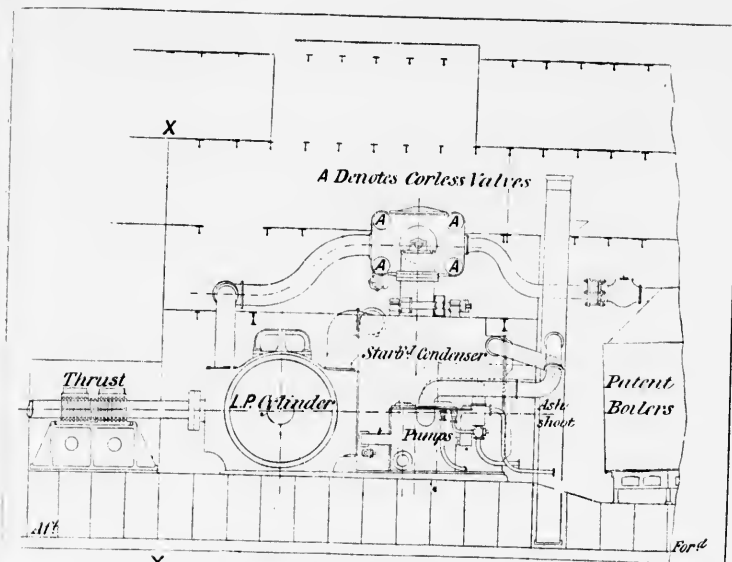
After the engines for screw machinery were arranged so as to be connected direct to the propeller-shaft, many types came into vogue, each line favouring its own form, the Inman adopting the horizontal trunk engine, the Cunard the inverted direct-acting, followed afterwards by the Guion and other lines.

The Guion Line in its first vessels adopted the

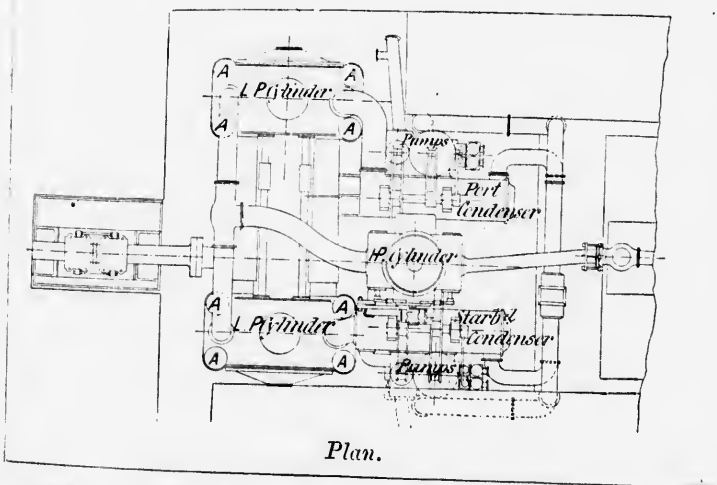


THREE CY

er Inman  
ed in all  
avy wear,  
eeth, and  
uble than  
aft.



Fore and Aft Elevation.



Plan.

THREE CYLINDER COMPOUND ENGINES, MONTANA AND DAKOTA, 1872.

DAKOTA.

e arranged  
aft, many  
g its own  
nk engine,  
afterwards

opted the

inverted direct-acting engine, but afterwards changed, in the **Wyoming** and **Wisconsin**, to the type having one vertical cylinder and one horizontal with trunk, both working on the same crank. They were followed afterwards by the type shown on pp. 178, 179, which were fitted in the **Montana**. There was one inverted high-pressure cylinder working direct on the forward crank-shaft, and two horizontal low-pressure with return connecting-rods, one on each side of the vessel. The valves of these engines, as also of the **Wyoming** and other vessels, were of the Corliss type, as may be noticed by the shape of the cylinders and the parts marked A.

Another peculiarity shown on this diagram is the vertical ash-shoot, into which the overboard discharge of the circulating water is led. The idea of this shoot, which was first introduced on the earlier White Star boats, was to avoid the annoyance caused in passenger vessels by the putting of the ashes overboard, but it was, however, only a partial success, giving rise, like many other contrivances, to greater evils than it cured, so that it was eventually done away with on all vessels.

Another feature of the two sister vessels, the **Montana** and **Dakota**, is clearly shown on the section, namely the excessive "tumble home"<sup>1</sup> of the vessels about midships, which gave them a very peculiar appearance.

<sup>1</sup> This term "tumble home" is used by nautical men to denote the manner in which the sides of the vessels gradually recede inwards from a little below the water line to the deck level; this was done to a great extent in the old three-decker line-of-battle ship.

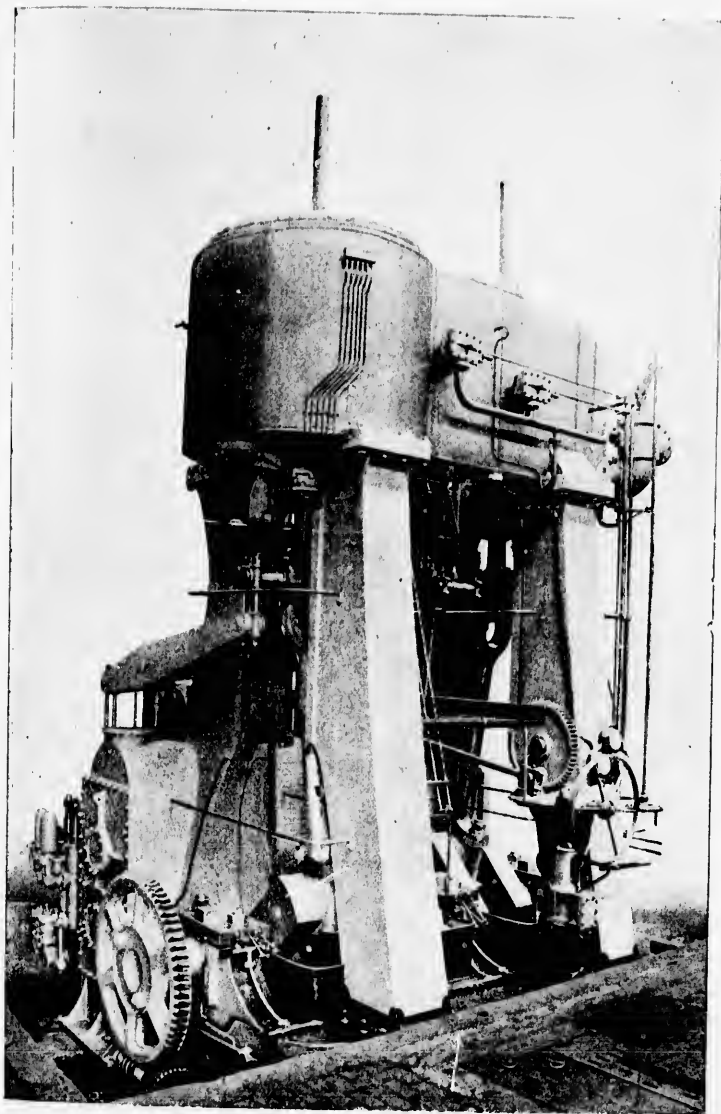


anged, in  
ing one  
nk, both  
ed after-  
ch were  
gh-pres-  
nk-shaft,  
nnecting-  
of these  
, were of  
e of the

a is the  
harge of  
ot, which  
oats, was  
essels by  
owever,  
her con-  
at it was

Montana  
mely the  
midships,

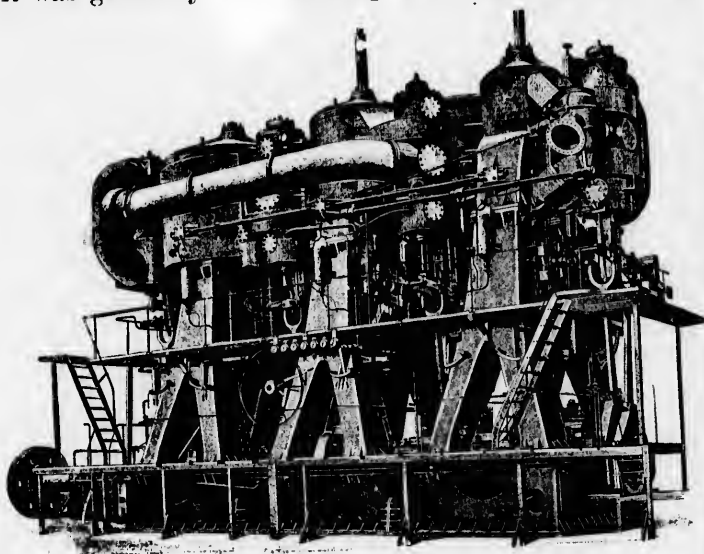
to denote  
lly recede  
level; this  
e-of-battle



TWO-CRANK COMPOUND ENGINES, 1870.



Since the general introduction of the compound engines in 1870, the inverted direct-acting type of engines with two cranks, shown on p. 181, has become almost universally adopted. Where the arrangement of one high and one low-pressure cylinder has been departed from, it was generally to get more power by placing the high-

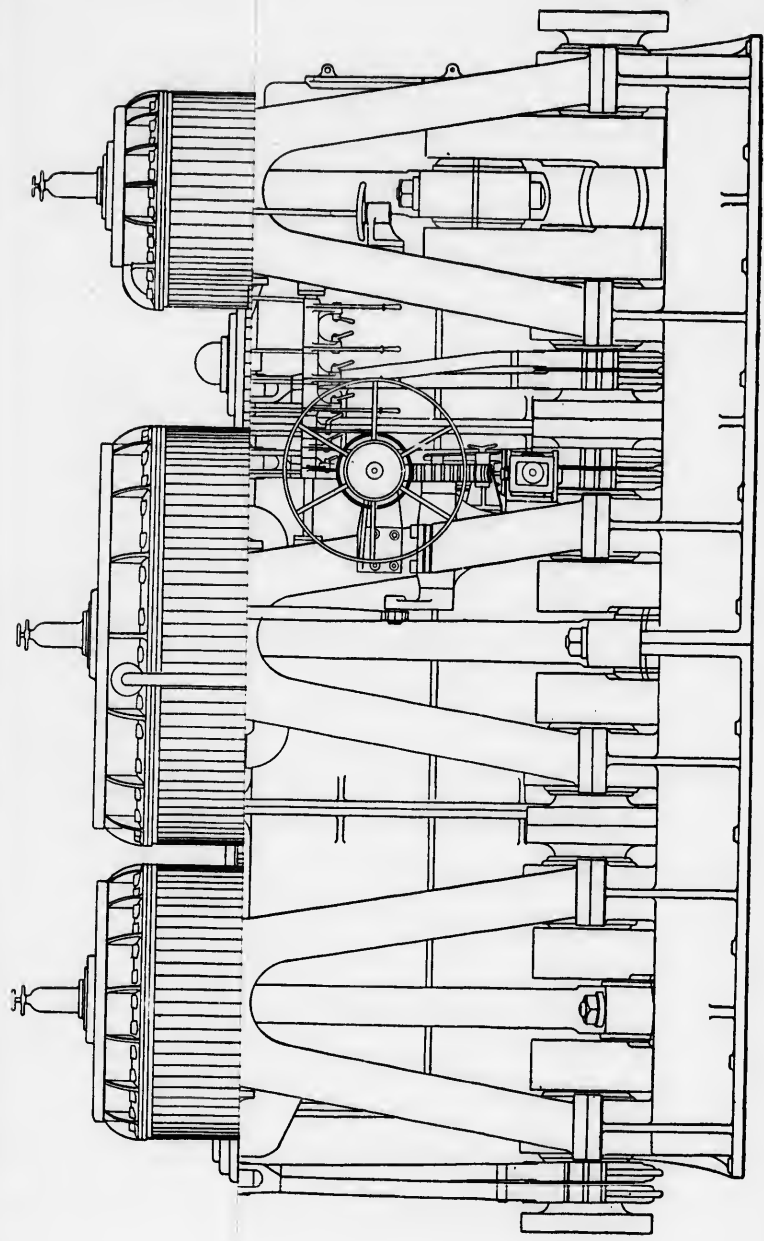


THREE CRANK TRIPLE ENGINES, 1888.

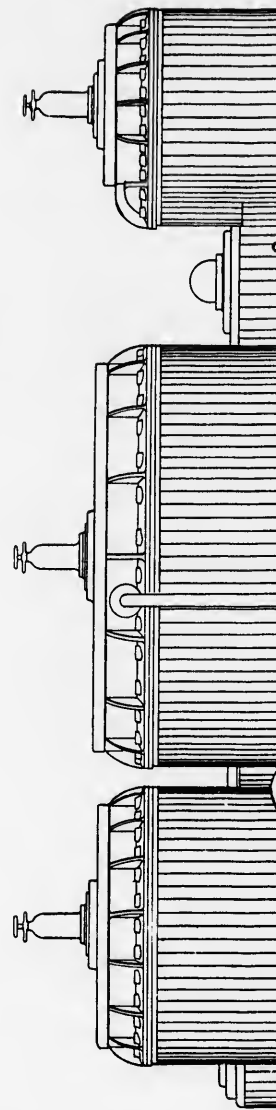
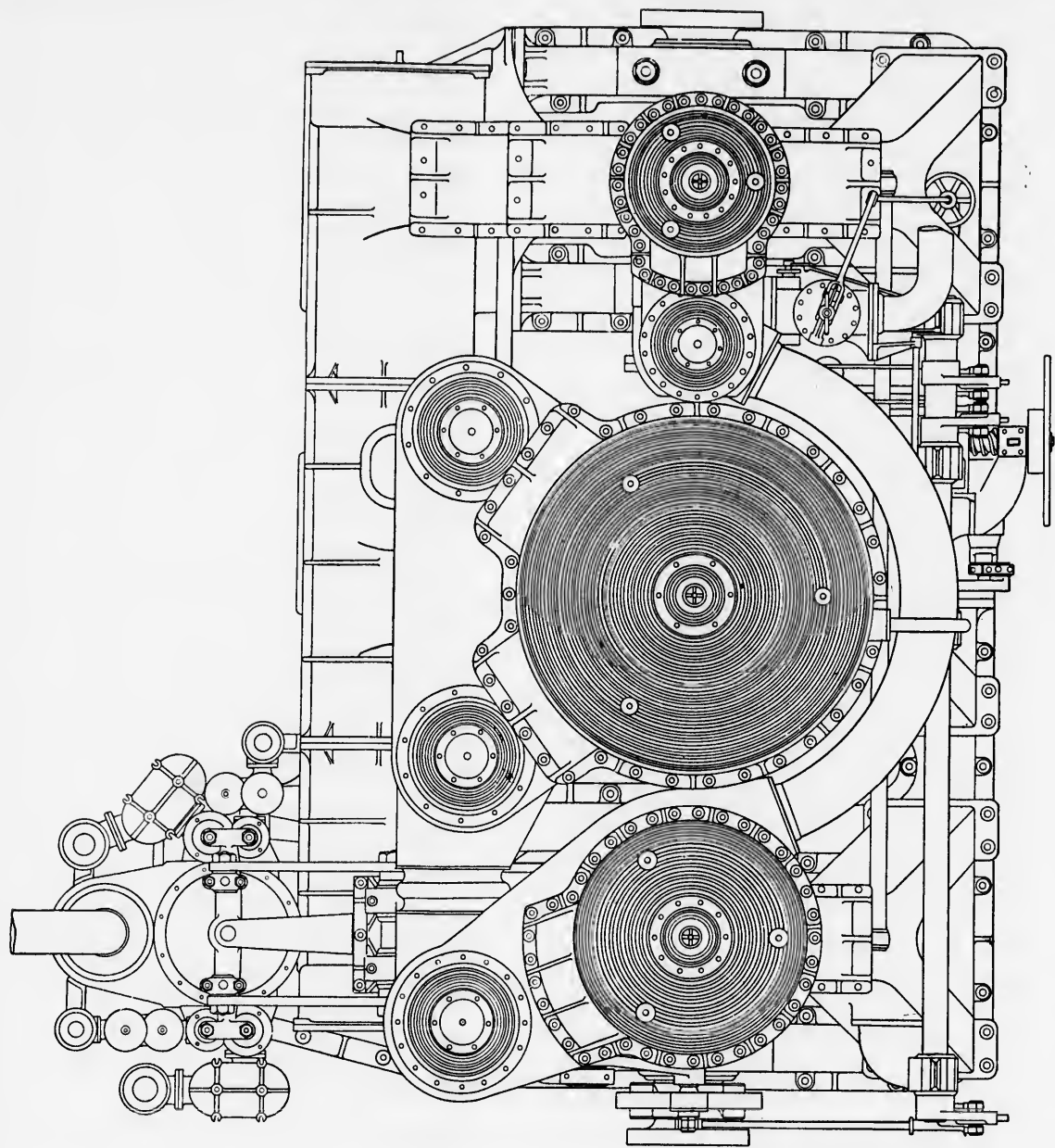
pressure cylinder above the low, tandem type, as instanced by the sketch of the first White Star boat's engines illustrated on pp. 81, 82. Sometimes the high-pressure cylinder was placed underneath the low; but all these designs have once more given place to the simple arrangement of the triple compound engine with three cranks, illustrated above, and in the annexed diagram of the

CHAP. XI.  
Compound  
engines  
almost  
the high  
d from,  
the high-

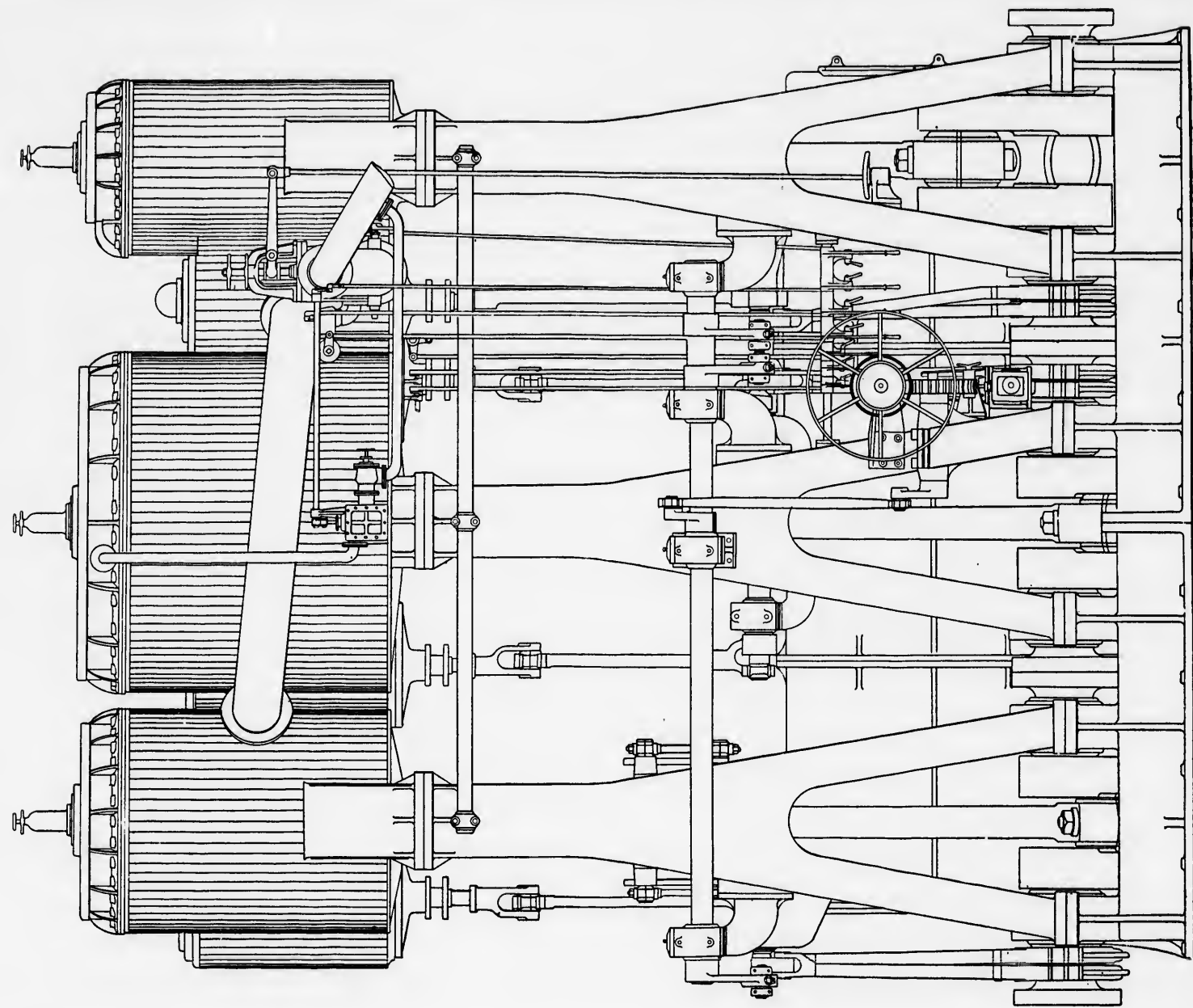
instanced  
engines  
pressure  
all these  
arrange-  
e cranks,  
n of the



ENGINES OF THE SS. MART



ENGINES OF THE SS. MARTELLI



**Martell**

for still  
seems a  
enables  
the two  
for the

It is  
the thr  
through  
been pr  
years, a  
broken  
atlantic  
single c  
owing to

One s  
**Paris'** t  
must ce  
the ordi  
altogeth  
amongst

In de  
of the e  
improver  
designs c  
cylindric  
the gener  
later by

<sup>1</sup> Since  
Cunard Li

**Martello's** engines. Owing, however, to the great demand for still higher indicated horse-power, the tandem system seems again coming into vogue with triple engines, as it enables two high-pressure cylinders to be placed above the two low-pressure, which is to be the arrangement for the new high-speed vessels of the Cunard Line.

It is also remarkable that since the introduction of the three-crank engine, the number of disablements through the breakage of crank or tunnel-shaft, have been practically reduced to nil during the last seven years, as, to the author's knowledge, only one case of a broken crank-shaft has occurred in the Express Transatlantic Service during the past eight years, and in the single case noted no serious delay was experienced, owing to the fact of the vessel being twin-screw.<sup>1</sup>

One serious case of breakage was that of the **City of Paris'** tube-shaft already noted at page 61, but this must certainly be attributed to circumstances outside the ordinary working, as the cause of breakage was altogether abnormal and not such as ought to be ranked amongst average risks incurred.

In describing the advances made in the machinery of the express liners, it is remarkable that no great improvement or radical change has taken place in the designs of the boilers, which still remain of the same cylindrical type with return tubes, the only change being the general adoption of the Fox corrugated flue, followed later by the now well known Purves ribbed flue. With

<sup>1</sup> Since this was written the breakage of a crank-shaft on the Cunard Liner **Servia** has been reported in July, 1891.

this single exception no alteration has been made in design, but very considerable advances have been made in the tools and appliances employed for boiler making, with a consequent improvement in the actual manufacture of the boilers, which has much increased their durability.

Other modifications have been effected in the general design of the machinery by the substitution of piston for slide-valves, to reduce the excessive friction due to the high steam-pressures and large surfaces; built steel crank-shafts have been altogether substituted for solid ones, and in many cases the hollow shafting has been adopted. The removal of the various feed, bilge, and circulating pumps from the main engines has also allowed of better arrangement in design.

The introduction of the electric light, forced draught, and refrigerating engines, has added many extraneous machines to the modern engine-room, and in the development of these auxiliary engines their construction has become a speciality of many firms, with the result that they are all of superior make, and do their work most satisfactorily, requiring but average care to keep them in order at sea.

One of the most radical departures of recent years is of course the twin screw, which, as may be noticed, has brought about an alteration in the design of the stern from the single screw type long in vogue, illustrated by a reprint of a photograph of a model of one of the most successful steamers, the *Britannic*.

The simplest form for the twin screw, and the one generally adopted by the different governments, is that



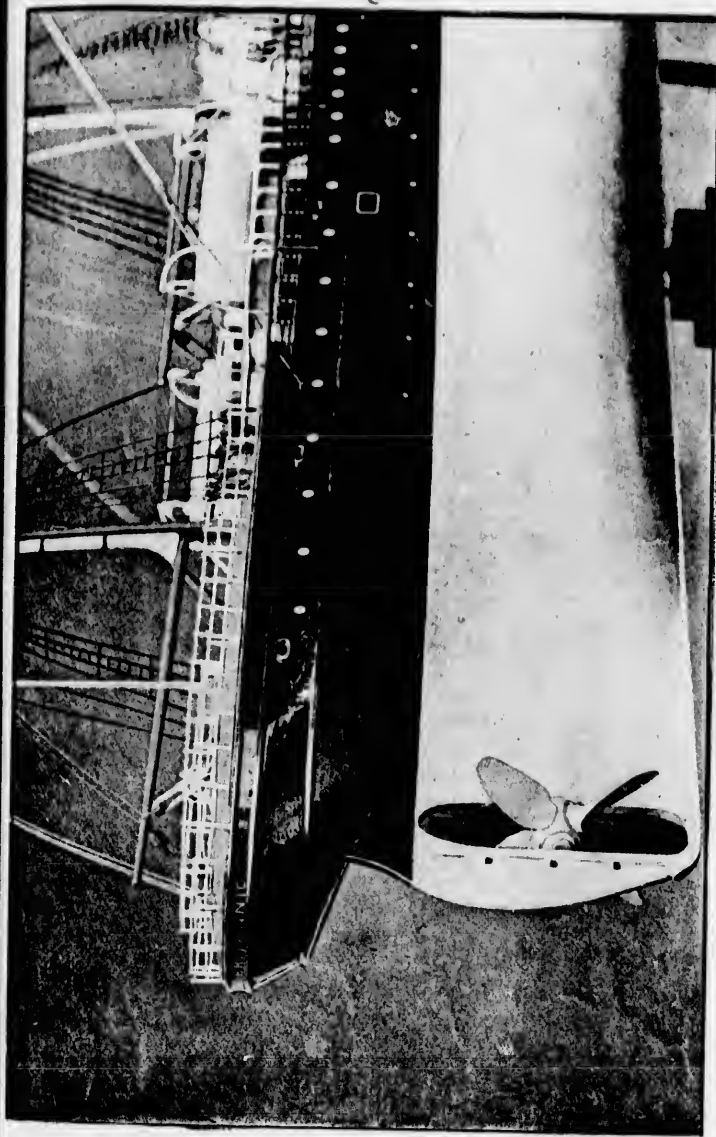


made in  
made in  
ng, with  
cture of  
bility.  
general  
ston for  
e to the  
ilt steel  
for solid  
as been  
ge, and  
as also

draught,  
raneous  
ne deve-  
struction  
e result  
eir work  
to keep

years is  
ced, has  
ne stern  
ated by  
he most

the one  
is that



STERN OF SINGLE SCREW STEAMER.



illustrated on p. 59, which serves to show the arrangement of the **City of New York** and the **City of Paris**. This, as will be seen, does away with the screw port forward of the rudder, and allows the hull to be built solid out to it, the shafts being supported at the propeller by heavy brackets, as they are termed, and covered with a protecting casing to the stern tube.

The other system which has been recently revived is that adopted by Messrs. Harland and Wolff, namely, the overlapping propellers. This necessitates a screw port, as in the single screw arrangements, but as this opening is no disadvantage, and the advantages of the design and the results obtained have been satisfactory, it is likely to be more extensively adopted. The arrangement of the after-part of the hull, as may be seen from the illustration on next page, is so designed that it is built with the frames and shell-plating projecting outwards in the wake of the shafts, which forms a convenient recess inside the ship for the shafts; it also possesses the great advantage of allowing the stern tube to be fitted exactly as in the single screw arrangements, which gives a desirable support to the shaft and propeller, besides keeping everything as far as possible secure from danger.

The designs of the propeller, like those of the boiler, have practically undergone but little change during the past fifteen years, the system of having blades bolted on to the propeller boss being now universally adopted for the express steamers, the material for the blades being manganese bronze, and for the bosses cast-steel or cast-iron. Up to the present the largest propellers yet made



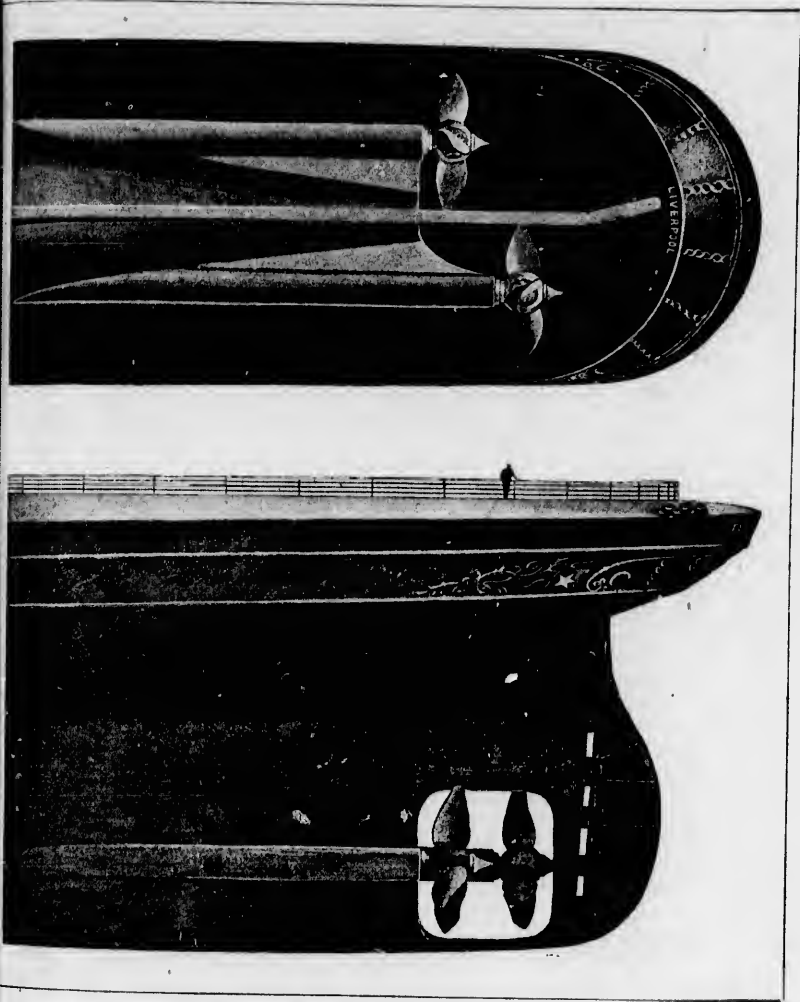
STERN OF

[CHAP. XI.

arrange-  
is. This,  
t forward  
lid out to  
by heavy  
h a pro-

revived is  
mely, the  
rew port,  
s opening  
e design  
ory, it is  
arrange-  
een from  
it is built  
twards in  
ent recess  
the great  
ed exactly  
ves a de-  
ides keep-  
anger.

he boiler,  
uring the  
bolted on  
lopted for  
des being  
el or cast-  
yet made



STERN OF TWIN SCREW STEAMERS TEUTONIC AND MAJESTIC,  
SHOWING OVERLAPPING PROPELLERS.

have been those on the **Umbria** and **Etruria**; these are 24½ feet diameter, 33½ feet pitch, 216 square feet surface, and weigh about thirty-nine tons each, each blade being about seven tons. Of late the number of blades has been reduced on the twin screw vessels from four to three, which has given a slight improvement.

When it is remembered that the cost of the manganese bronze for the propeller blades averages about £120 per ton, some idea of the costs of the machinery of the great liners may be formed, the four blades for one of these steamers costing £3,360, and the boss about another £1,000, so that the total cost of the propeller alone, fitted in place, is but little under £5,000.

One of the numerous requirements necessitated of late years in the engine-room, owing to the great advance of the steam-pressure, is the "Evaporator" as it is termed. This is required to make up the supply of fresh water for the boilers, and is generally worked by the passing of steam through coils of pipes immersed in sea-water, and so boiling it, the steam being collected and passed into the boilers with the ordinary feed water. The immense quantities of water used are clearly given in the account of the **Teutonic's** machinery (reprinted by kind permission from "The Engineer"), with some other interesting data of the various matters of fuel consumption and such like. The other feature of special note in connection with the modern machinery is the application of forced draught, which is now being extensively adopted.<sup>1</sup>

<sup>1</sup> The term forced draught is used when artificial means are adopted either by means of steam jets as on a locomotive, or by

The two s  
stokehole  
in the sto  
direct thr  
principle  
navies, b  
heavy Exp

The oth  
man (Mr.  
forward ag  
was first  
Ohio, follo  
Celtic. T  
induce the  
Star Teuto  
the City of  
stokehole s  
board after

TH

The Teu  
triple-expan  
The cylin  
60 inches.  
rooms. Th

forming a pa  
forcing air in  
fans is that of  
the steamer  
Princeton

The two systems so far tried on the Atlantic are the closed stokehole principle, where the air is raised to a pressure in the stokehole by means of fans, and allowed to flow direct through the fires, so forcing the combustion. This principle has been extensively adopted by the various navies, but has been practically found wanting in the heavy Express Transatlantic Service.

The other principle is the one named after the gentleman (Mr. Howden) who has so perseveringly pushed it forward against much opposition and prejudice, and which was first introduced to the Atlantic on the steamship *Ohio*, followed soon afterwards by the White Star Liner *Celtic*. The results on those vessels were such as to induce the fitting of it in a modified form on the White Star *Teutonic* and *Majestic*, and also more recently on the *City of Paris*, where it was fitted in lieu of the closed stokehole system, when the new machinery was fitted on board after the breakdown.

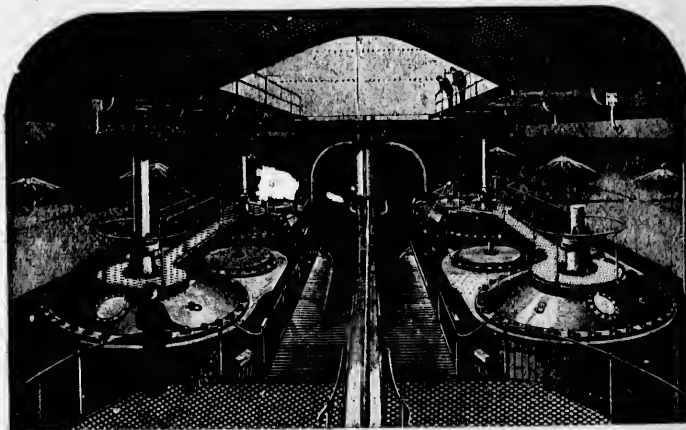
#### THE MACHINERY OF TEUTONIC AND MAJESTIC.

The *Teutonic* and *Majestic* are propelled by twin-screw triple-expansion engines, indicating about 17,000 horse-power.

The cylinders are 43 inches + 68 inches + 110 inches × 60 inches. The high-pressure cylinders stand next the boiler-rooms. The engine-rooms are over 50 feet long. All the

forming a partial vacuum in the funnel, or by fans blowing or forcing air into the fires. The first record of forced draught by fans is that of the famous engineer John Ericsson, who fitted it on the steamer *Corsair* in 1830, and later in the U.S. warship *Princeton* in 1843.

cylinders have piston valves, two each to the intermediate and low-pressure cylinders, and one to the high-pressure cylinder. The cylinders are not steam-jacketted, a very extended experience serving to convince Messrs. Harland and Wolff that nothing is to be gained from jacketting, at sea at all events, unless the steam is permitted to blow through the jackets, so as to be constantly renewed. This can only be done in a way to avoid much waste and loss with great difficulty. All the cylinders of the **Teutonic** are, however, fitted



A.—VIEW OF TOPS OF BOTH PORT AND STARBOARD ENGINES.

with liners and are air-jacketted. The intermediate and low-pressure pistons have tail rods, but the high-pressure pistons have not. All the pistons are coned to impart stiffness, and have been made as light as is consistent with strength. Each cylinder is carried on cast steel frames. In front is an A frame, and at the back a single frame, so that the cylinders are carried each on three points of support, and the "three-legged-stool" principle is called in to give stability, which it does in the fullest degree. The condenser is quite separate

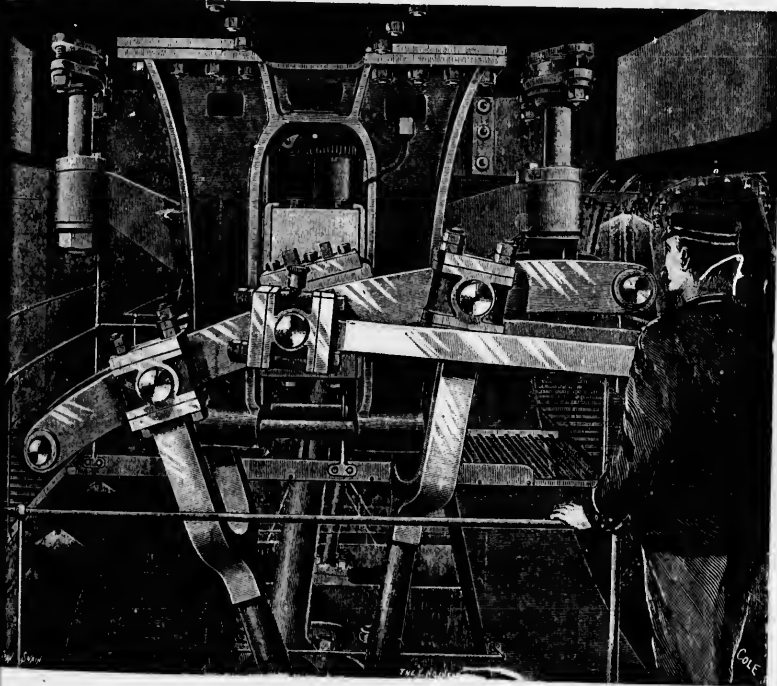
from the engine, and is 7 feet in diameter. The condenser is about twice as long as it is three times as high.



Messrs. Tanqueray & Co., each end, with two steam engines and two pumps. The condenser is by Worthington.

intermediate  
high-pressure  
a very ex-  
arland and  
g, at sea at  
through the  
an only be  
great diffi-  
ever, fitted

from the engine. It is cylindrical, of brass, some 20 feet long, and 7 feet in diameter. The tubes are of brass,  $\frac{7}{8}$  inch diameter. The aggregate length of all the condenser tubes is about twenty miles. The water passes through the tubes three times; it is supplied by vertical centrifugal pumps by



LINK MOTION, MEDIUM CYLINDER.  
B. — STARBOARD ENGINE-ROOM.

ENGINES.

ate and low-  
sure pistons  
tiffness, and  
ngth. Each  
ont is an A  
ne cylinders  
the "three-  
ty, which it  
ite separate

Messrs. Tangyes, of Birmingham. There is an air pump at each end, worked by back levers by the high and low-pressure engines. These levers also actuate the bilge and sanitary pumps. The boilers are fed by Weir's vertical pumps, but Worthington pumps are also provided. The engines are

separated by the longitudinal bulkhead, which rises a few feet above the water-line to a point about level with the cylinder covers. The whole of the upper part of the engine-room is common to both engines. As the propellers overlap, the engines can be placed much closer together than is possible when the usual system is adopted, and the arrangements of the engine-rooms are exceedingly good. Access is obtained by winding stairs of ample proportions, which are a vast improvement on ladders. The engraving on page 190, sketch A, is a view taken from the after end of the upper platform, the cylinder covers appearing on either hand—to port and starboard.

Fig. B is a view taken on the middle platform. The cylinder bottoms are seen overhead. The construction of the valve gear will be readily understood. A hand-wheel and screw on the weigh shaft is for fine adjustment for expansion.

The crank-shafts, each weighing 41 tons, are of Whitworth steel, the crank-pins being 22 inches by 22 inches. The main bearings are not of extravagant length. Indeed, they look short, but it is a noteworthy fact that they have never yet needed a drop of water on them, or heated in the slightest degree to give trouble.

Fig. E gives a view of one of the thrust blocks, which stand in a conveniently large open space abaft the engines, and under the platform on which are two powerful electric light engines by Messrs. Tangyes, driving dynamos by Messrs. Crompton, of Chelmsford, who have carried out all the electrical arrangements throughout.

We have already explained that the screw-shafts are placed so close together that the screws overlap 5 feet 6 inches, and the starboard propeller is astern of the other by 6 feet. The propellers revolve "outboard." A large opening is made in the dead wood to allow of this system of construction. There are no stern brackets, the hull being worked out round the screw-shaft, and fitted with a strong spectacle casting in steel,

which can  
the ordin  
feet and

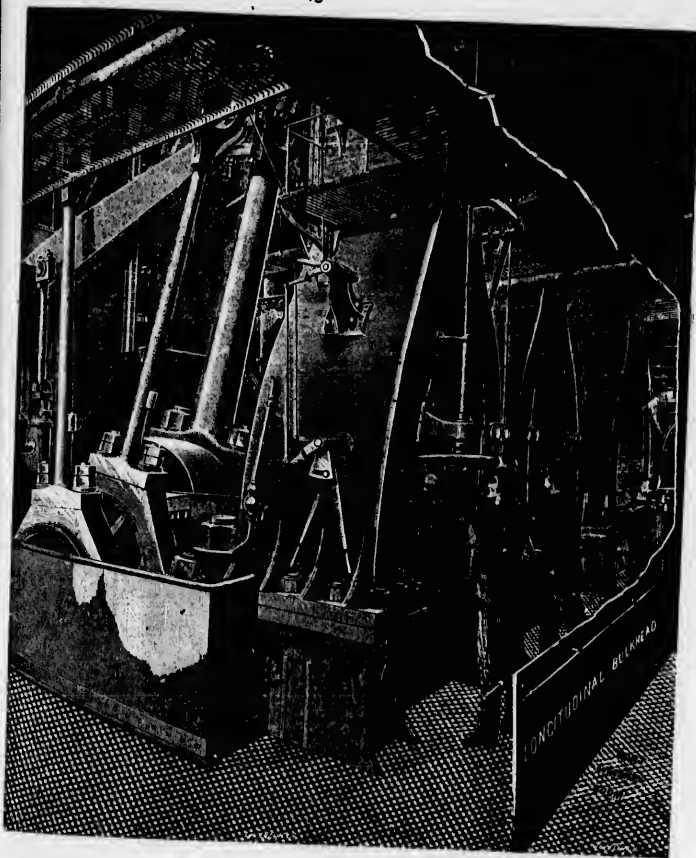


C.—STARBOARD

along a spec  
the hull. A  
At the other s



which carries the stern bearings. There is no screw alley in the ordinary sense of the word. Each screw-shaft—one 199 feet and the other 205 feet long, weighing 76 tons—runs



C.—STARBOARD ENGINE LOOKING AFT FROM STOKEHOLE DOOR.

along a species of chamber which, well aft, is really outside the hull. A view taken in this chamber, plate D, is annexed. At the other side is the longitudinal bulkhead, and in the space



between this and the shaft are placed ice making machines—ammonia—by Sulzer, of Winterthur, and the cold air storage holds are supplied with cold air by fans from this department. A description of this machinery will be found further on. Everything is duplicated, so that the machinery at both sides of the bulkhead is the same.

The screw propellers are 19 feet 6 inches diameter and 29 feet 6 inches pitch, three-bladed, modified Griffiths' true screws, with a surface of 108 square feet each. The propeller blades were cast of Parsons' manganese bronze from ingots supplied by the Manganese Bronze and Brass Co., Deptford, by Messrs. Harland and Wolff, Belfast, who have for some time past adopted this metal for the propellers of all their fast passenger steamships with satisfactory results as regards speed and economy, and in order to turn out these castings in the most perfect manner, have spared no expense in erecting suitable furnaces and providing special plant for the purpose. The engines make from seventy-nine to eighty-two revolutions when driven as fast as they can go. On an Atlantic voyage, the average for the whole run is about seventy-eight revolutions per minute.

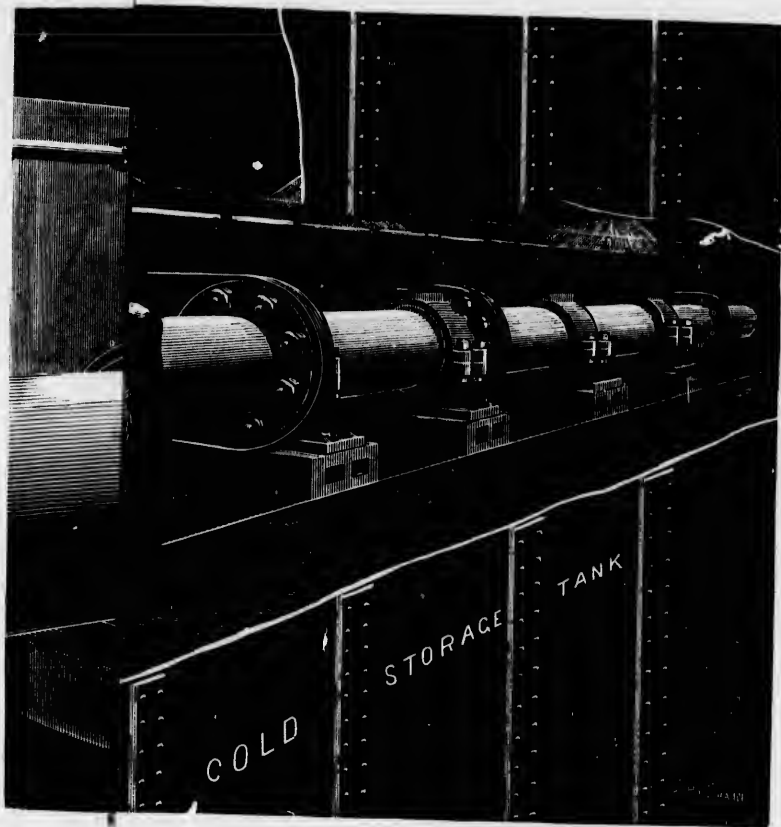
Steam is supplied by twelve double-ended and four single-ended boilers, containing seventy-six furnaces. The pressure is 180 lbs. They are worked with forced, or rather assisted, draught, on Howden's system. On the bridge decks, abaft each funnel, there are two large fans, driven by compound engines. They drive air into the stokeholds, supplementing the supply drawn through the fiddle gratings. Below these are fourteen fans, driven by Chandler engines, and constructed by Messrs. Bumpstead and Chandler, Hednesford, Staffordshire. These fans are double, and 5 feet in diameter. Each fan—of which there are fourteen in each ship—is able to pass about 16,000 cubic feet per minute at a plenum of 3 inches of water, the revolutions being

[CHAP. XI.

machines—  
air storage  
department.  
Further on.  
both sides

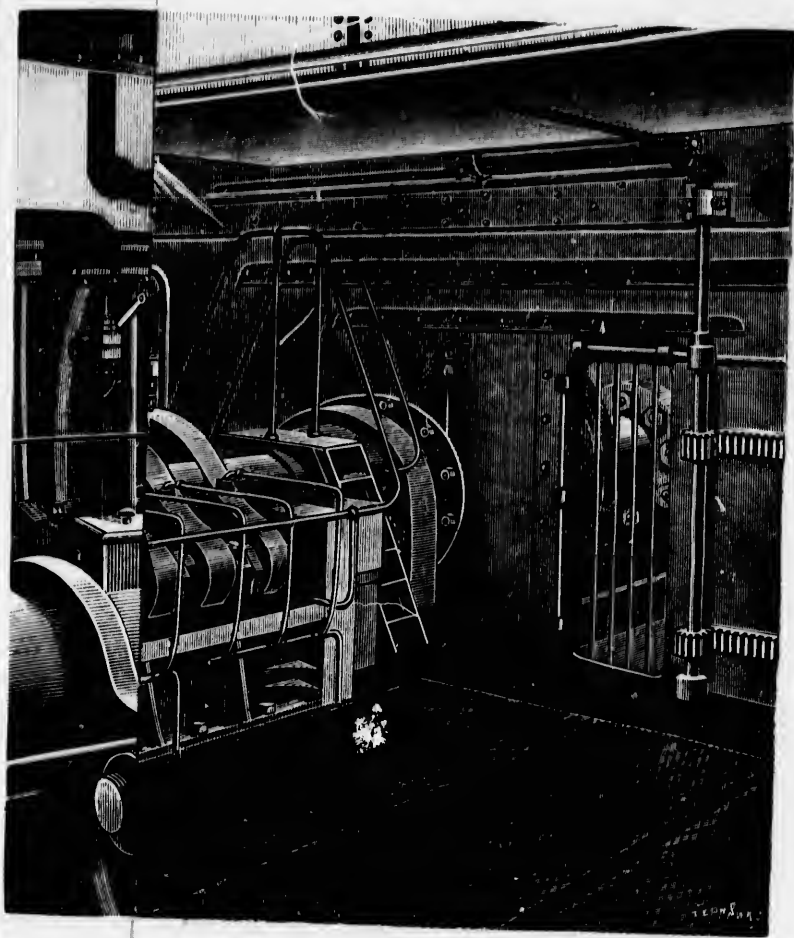
and 29 feet  
rue screws,  
eller blades  
ts supplied  
by Messrs.  
time past  
t passenger  
speed and  
n the most  
ng suitable  
pose. The  
revolutions  
ntic voyage,  
ght revolu-

four single-  
The pres-  
l, or rather  
the bridge  
ans, driven  
the stoke-  
the fiddley  
by Chand-  
pstead and  
are double,  
are fourteen  
bic feet per  
utions being

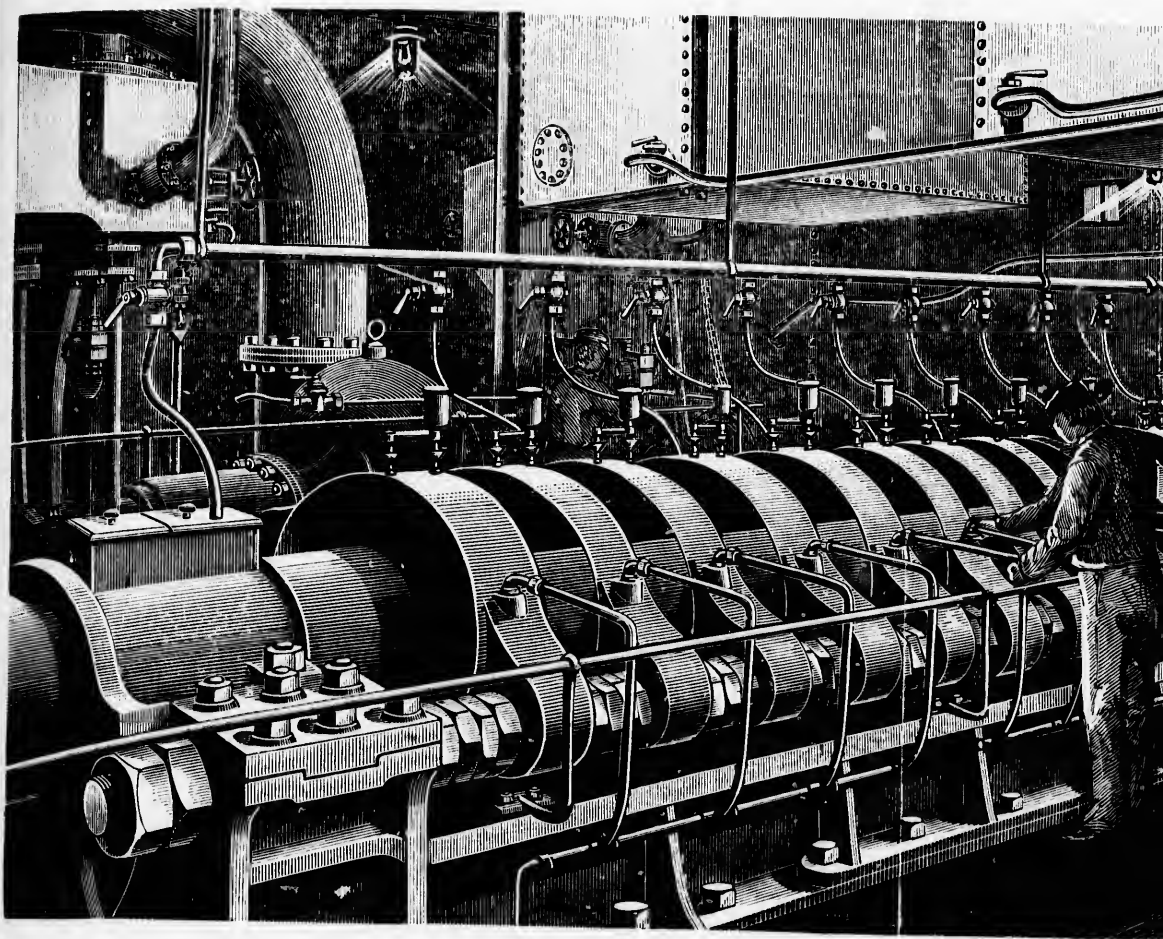


*Face page 194.*

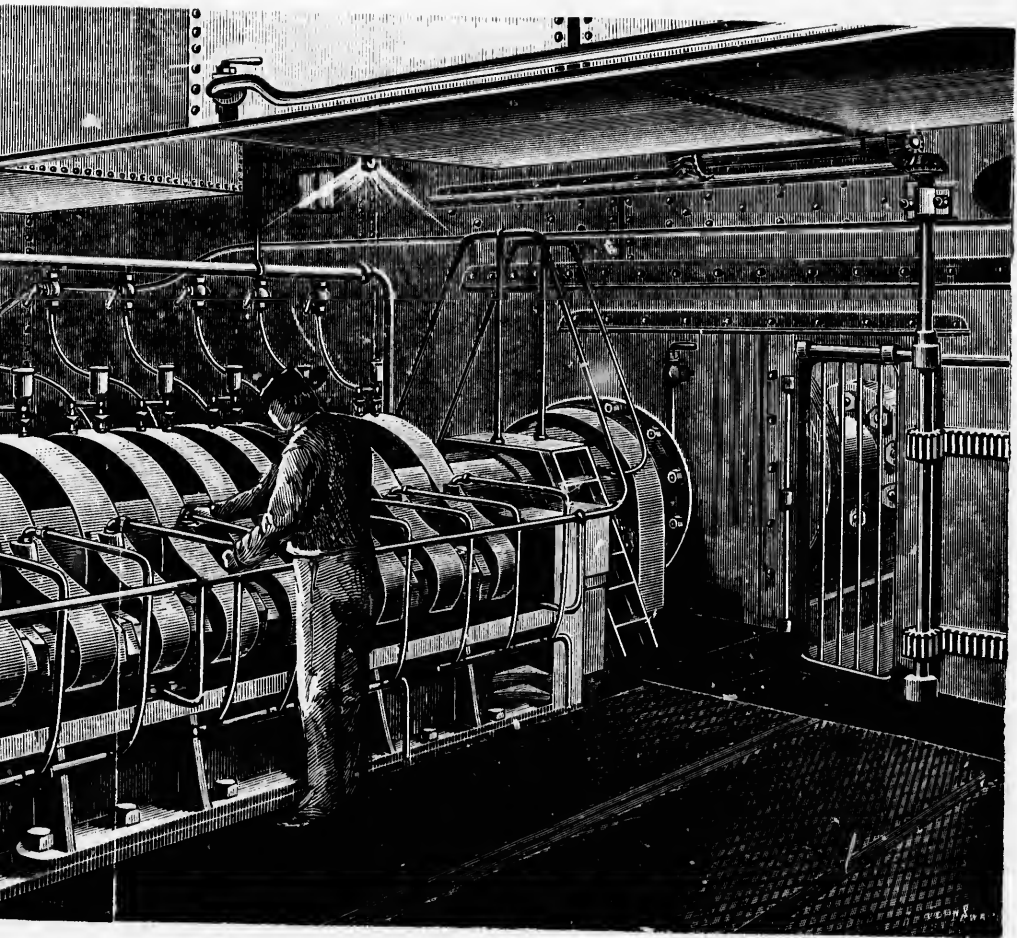




*Face page 194.*



E.—STARBOARD THRUST BLOCK, TEUTONIC.



RD THRUST BLOCK, TEUTONIC.

*Face page 194.*

350 per r  
the stoke  
the bases  
each chan  
bustion p  
them, an  
finally del  
about 250  
is admitte  
we have  
rooms cool  
fitted.

It will n  
and figure  
idea of the  
evaporation  
are carried  
difficulty w  
which can

The engi  
power, som  
more; ther  
the six cylin  
nearly 2,83  
crank-shaft  
of 17,000 ho  
ment involv  
about 120 to  
of 195 lbs., t  
inch. Of co  
water into th  
feed-water r  
nearly  $16\frac{1}{2}$  f  
ton 120 tons

350 per minute. They draw the air from the hottest places in the stokeholds and force it into chambers in the uptakes at the bases of the chimneys. There are fifty vertical tubes in each chamber, and through these tubes the products of combustion pass, while the air from the fans circulates round them, and passing down the sides of the smoke-boxes, is finally delivered into the closed ash-pits at a temperature of about 250 degrees. About one-fourth of the whole air supply is admitted over the fires. In addition to the eighteen fans we have named, three others, two for keeping the dynamo rooms cool, and one for ventilating the firemen's quarters, are fitted.

It will not be without interest if we give here a few facts and figures, which will help to convey to our readers some idea of the gigantic scale on which the processes of combustion, evaporation, and condensation, and the performance of work are carried on in the **Teutonic** and the **Majestic**. The only difficulty we have lies in selecting standards of measurement which can be readily grasped by the mind.

The engines of the **Teutonic** indicate about 17,000 horse-power, sometimes of course a little less, sometimes a little more; therefore as the power is fairly equally divided among the six cylinders, each regarded as a distinct engine indicates nearly 2,833 horse-power. The energy transmitted to each crank-shaft is 8,520 horse-power. It is far more easy to talk of 17,000 horse-power than it is to realize what its development involves. The boilers of the **Teutonic** have to produce about 120 tons of steam per hour, with an absolute pressure of 195 lbs., the safety-valve load being 180 lbs. on the square inch. Of course the feed pumps have to deliver 120 tons of water into the boilers against this pressure every hour. The feed-water required for one hour would fill a cubical tank nearly  $16\frac{1}{2}$  feet long, broad, and deep; for at 36 feet to the ton 120 tons means 4,320 cubic feet. The energy expended in



putting this great body of water into the boilers is over 57 horse-power, allowing nothing for friction in pipes or losses of any kind. The feed pumps really absorb about 120 indicated horse-power. The total feed-water for one day of twenty-four hours amounts to 103,680 cubic feet, which would fill a cubical tank 47 feet on the side. Such a tank would hold 6,500,000 gallons; this would be an ample daily supply for a town of 26,000 inhabitants, giving every person 25 gallons per day.

To convert this water into steam about 12.5 tons of coal are burned every hour, or in round numbers 300 tons a day. We do not put these figures forward as official, but they are not far from the truth. This means that on a trip to America the **Teutonic** burns all the coal that six trains of thirty-two wagons each can carry. The  $12\frac{1}{2}$  tons of coal need for their combustion not less than 250 tons of air. Assuming that this air before it enters the fans has a temperature of about 80 degrees, it will weigh, omitting fractions, 7 lbs. per 100 cubic feet. The 250 tons represent, then, 8,000,000 cubic feet, which would fill a cubical tank 200 feet on the side. To raise this air from 80 degrees to 180 degrees, as is done in the heating apparatus we have described, represents about 5,800 theoretical horse-power, and a large portion of this may be regarded as clear gain, being obtained for nothing. In other words, if the air were delivered cold to the furnaces instead of hot, some 20 tons of coal extra would be required per day.

The centrifugal circulating engines, as well as the electric lighting engines, were made by Messrs. Tangyes, of Birmingham. Small as the circulating engines appear to be in this great vessel, out of it they would be considered of fair size, big enough, for example, to deal with the pumping out of a pretty large graving dock. In the **Teutonic** the duty of these circulating engines is of the first importance. They must run constantly when the main engines are moving, they

must be s  
running d  
great cond  
immense v  
pressure cy

The weig  
be taken ro  
some idea  
has played  
gallons of v  
per square  
effect this  
passed thro  
This duty i  
and it may  
dealt with o  
is over 1,00  
long, a qua  
the water w  
city of 700,

The follow  
lating pump  
centrifugal p  
with suction  
pump two v  
cylinders 8  
one engine b  
when lifting  
The unusua  
circulating t  
revolutions p  
full speed, v  
which have  
proper worki

must be started before the main engines, and must be kept running during all temporary stoppages, in order that the great condensers may be kept cool, and ready to deal with the immense volumes of steam which are discharged from the low-pressure cylinders of the main engines.

The weight of steam to be condensed may, as we have said, be taken roughly at 120 tons per hour, a quantity which gives some idea of the important part which surface condensation has played in the progress of steam navigation. About 26,000 gallons of water are made into steam at a pressure of 180 lbs. per square inch, and reconverted into water every hour. To effect this condensation about 4,000 tons of sea water are passed through the tubes of the surface condensers every hour. This duty is effected by Messrs. Tangyes' circulating pumps, and it may be interesting to state that the amount of water dealt with on the round trip between Liverpool and New York is over 1,000,000 tons—enough to fill a reservoir about a mile long, a quarter of a mile wide, and six feet deep; and that if the water were fresh, the daily quantity would suffice for a city of 700,000 inhabitants.

The following are the principal dimensions of these circulating pumping engines as fitted on the **Teutonic**:—Two centrifugal pumps, each with discs or impellers 5 feet diameter, with suction and delivery pipes 20 inches diameter. For each pump two vertical compound engines are provided, each with cylinders 8 inches and 15 inches diameter, 14 inches stroke, one engine being amply large to perform the full duty, even when lifting water 25 feet high from the bottom of the vessel. The unusually large diameter of the disc enables the work of circulating to be done at the very moderate speed of 85 to 95 revolutions per minute when the main engines are working full speed, while the very liberal proportions and surfaces which have been adopted throughout give good security for proper working and durability. The engines are fully equipped

with continuous oiling arrangements, and all the minor fittings usually found in first-class work.

The enormous distances traversed by the pistons of marine engines is never realized; at all events, we have never seen any statement of the facts in print. It suffices to give the speed in feet per minute; but no one stops to consider what this implies. In the **Teutonic** the stroke is 5 feet, and the average revolutions 78 per minute. Each piston therefore traverses 780 feet per minute, or 46,800 feet per hour, and 1,123,200 feet per day, or in six days not less than 1,275 miles. In other words, more than one-third as many miles as the ship steams. The aggregate distance traversed by the three pistons is 7,650 miles, or about two and a half times the distance run by the ship. This is pretty well, considering that the piston rings are rubbing all the time. The length of the ring in the low-pressure pistons is 345.57 inches, or 28 feet 9½ inches, so that there is a good deal of surface to take the wear, but it is not, under the circumstances, remarkable that cylinders should wear and require re-boring. The slipper guides, too, are not spared, each slipper passing over the same distance as each piston.

The refrigerating machinery on board the **Teutonic**, as well as that on board the sister ship **Majestic**, is on the Linde system. It is used for refrigerating the insulated meat holds, and also for the passengers' provision rooms. The general arrangement of the holds and passengers' stores is shown in the plates F and G. There are two meat holds of a total net capacity of about 40,000 cubic feet, and each hold is provided with distinct refrigerating apparatus; though the arrangements are such as to permit of either refrigerator working on either hold, or, indeed, one refrigerator on both holds. The machinery is placed below the holds between the screw tunnels, the space being very narrow, so that it was necessary to adopt a somewhat special arrangement and to use two separate

r fittings

f marine

ever seen

give the

der what

, and the

therefore

our, and

an 1,275

y miles as

d by the

times the

ring that

th of the

or 28 feet

take the

able that

e slipper

the same

tonic, as

is on the

ated meat

ne general

shown in

t total net

s provided

arrange-

orking on

lds. The

w tunnels,

y to adopt

o separate

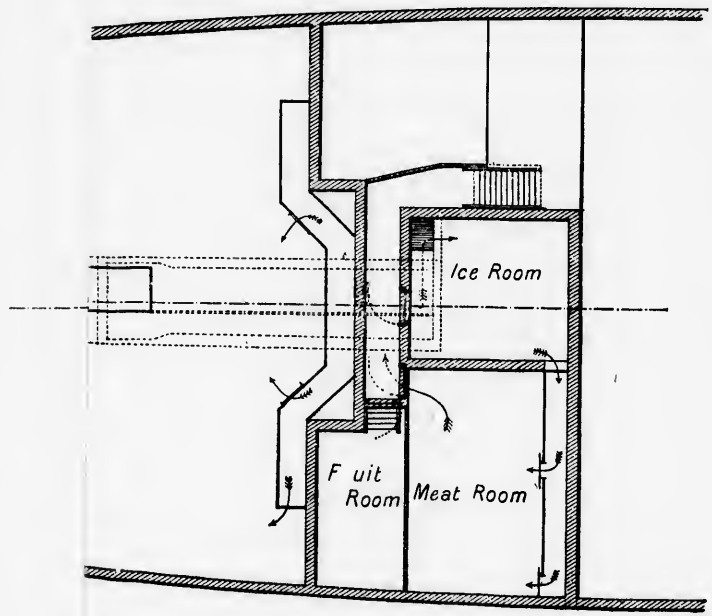
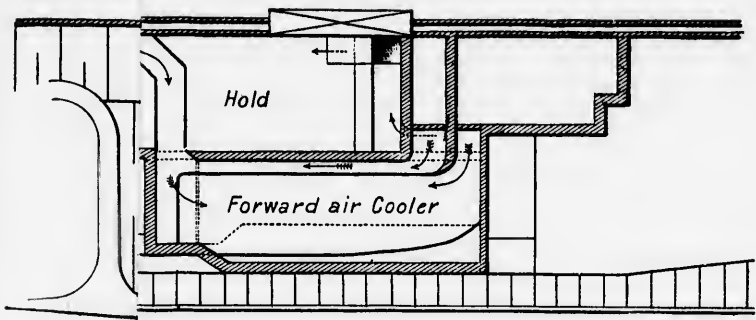
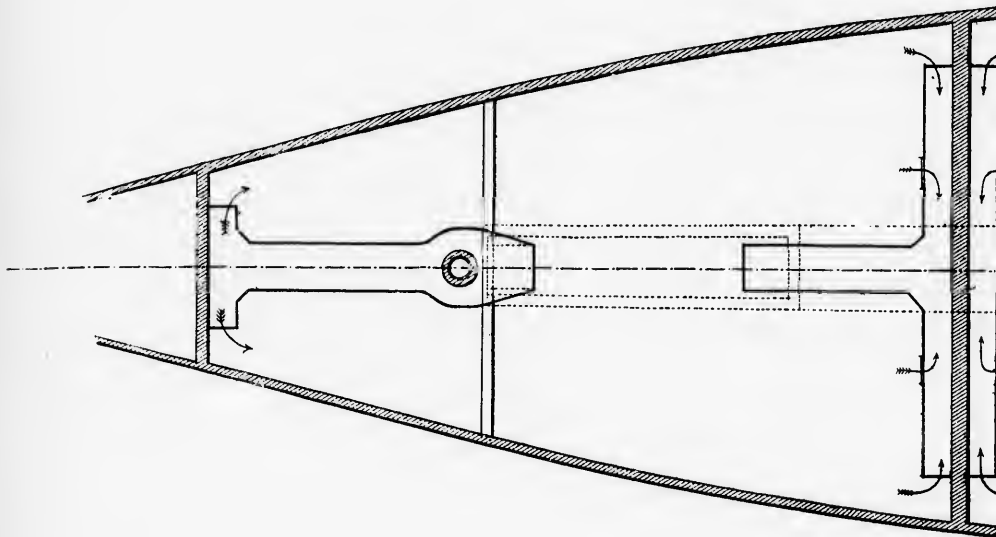
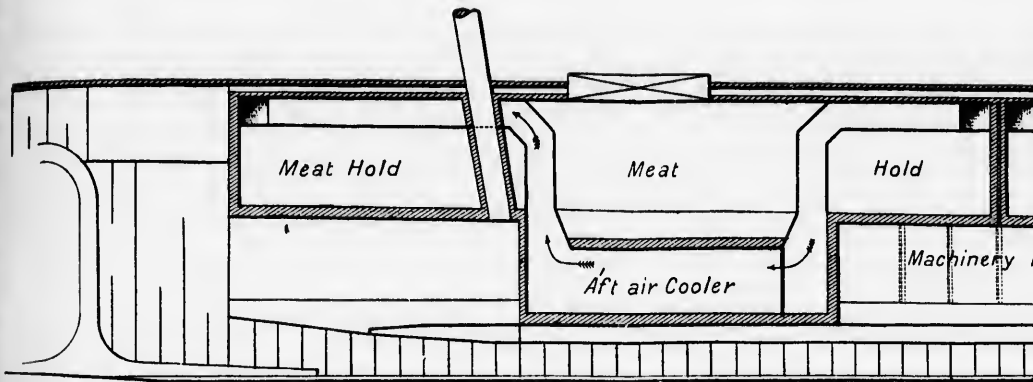
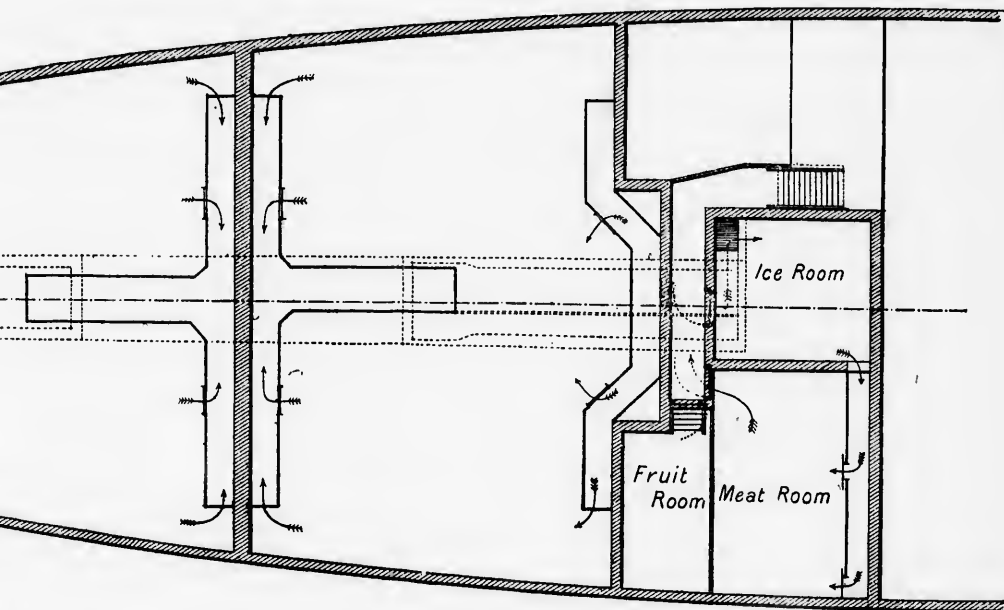
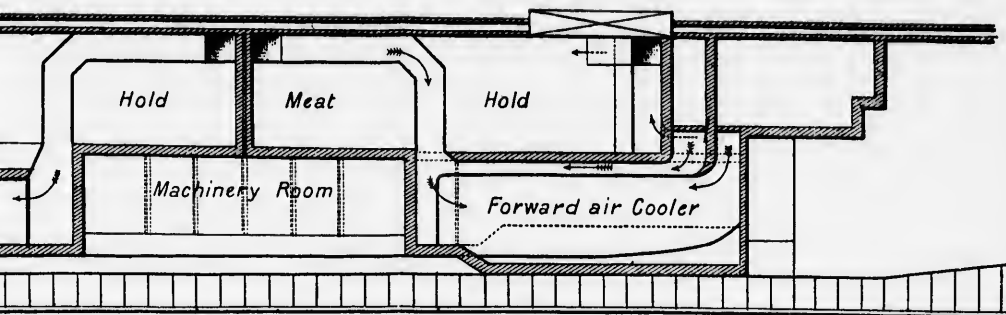
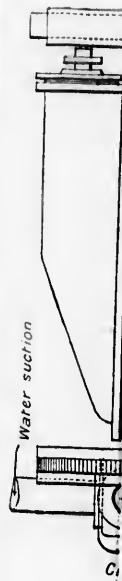


FIG.

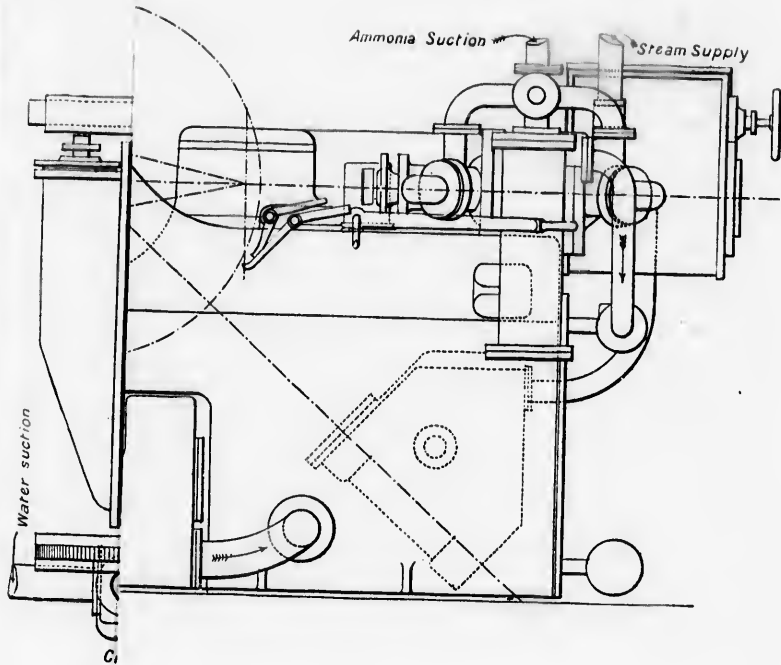


F.—REFRIGERATING CHAMBERS AND GEAR,





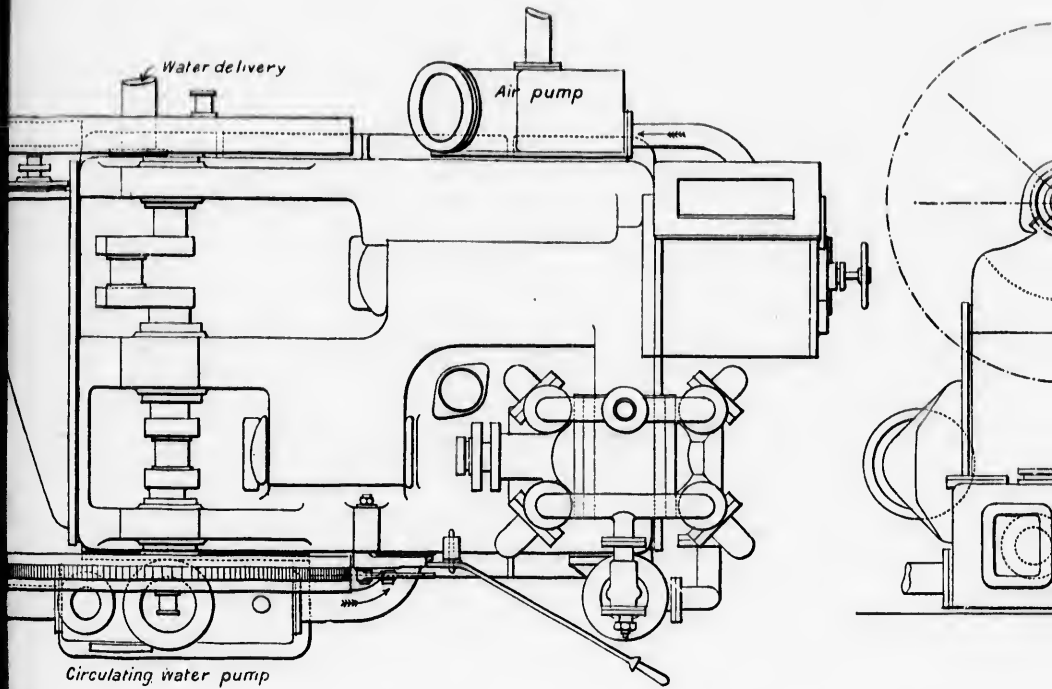
C.



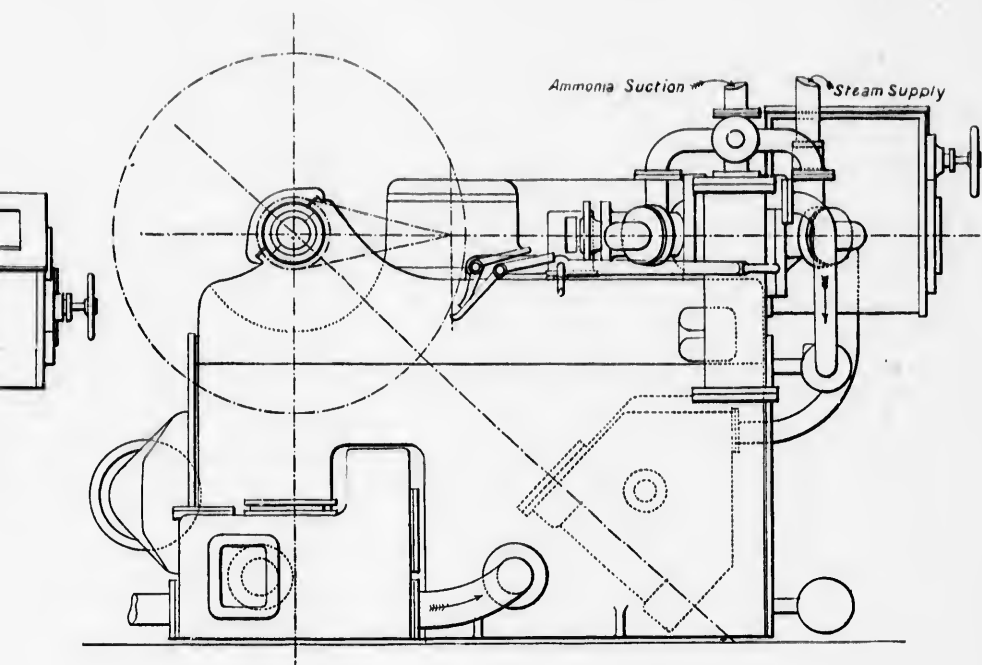
IC.

Face page 198.





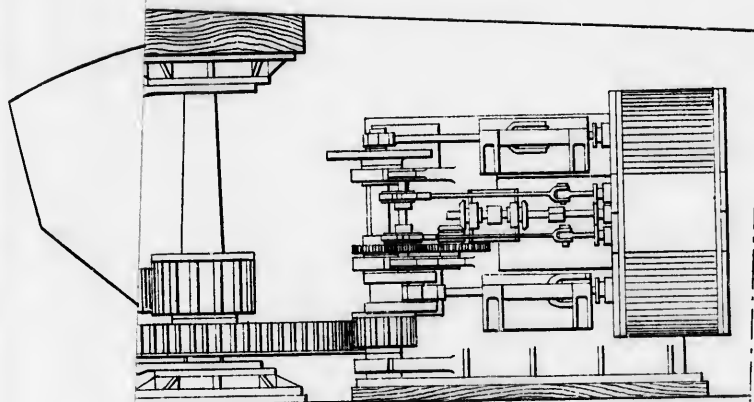
G.—REFRIGERATING CHAMBERS AND GEAR, SS. T



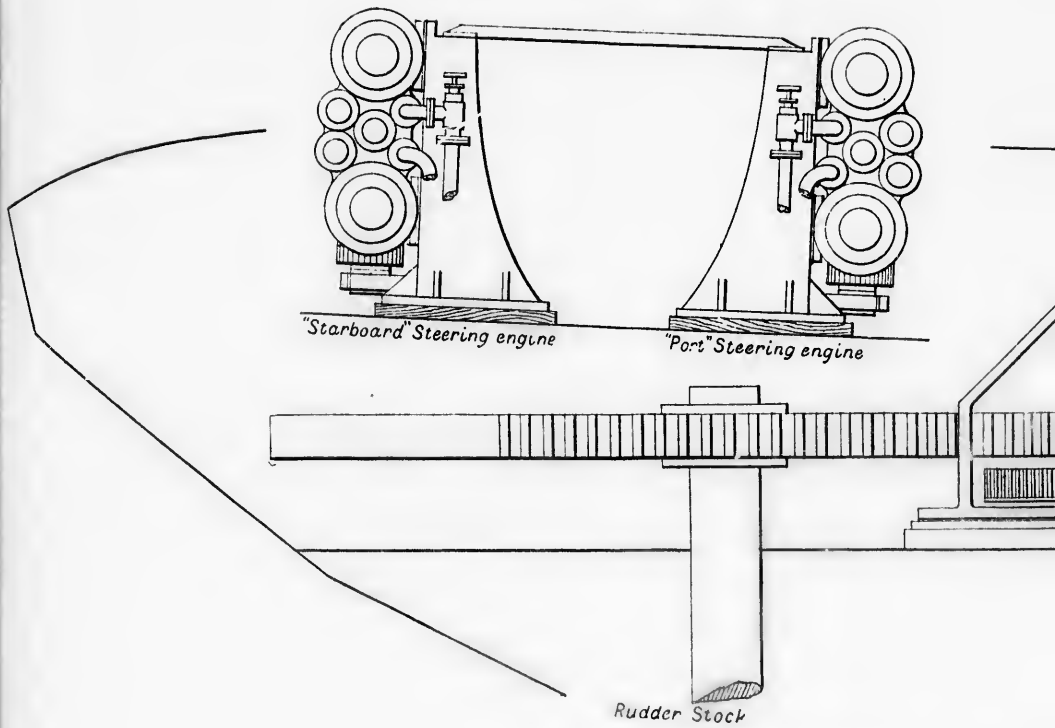
CHAMBERS AND GEAR, SS. TEUTONIC.

*Face page 198.*

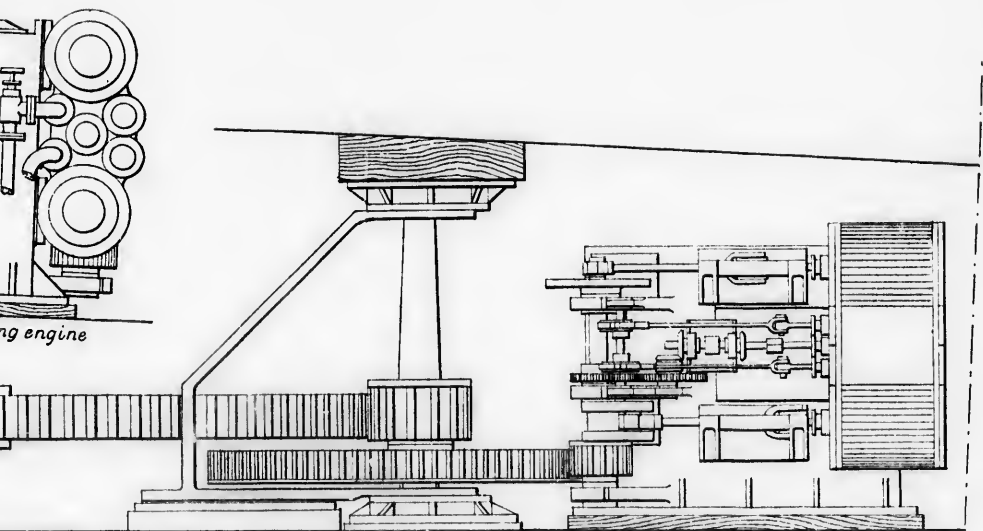




*eccentric bush bearing for throwing  
large pinion in & out of gear*



H.—DOUBLE STEAM STEERING GEAR, SS. TEU



*Eccentric bush bearing for throwing  
large pinion in & out of gear*

M STEERING GEAR, SS. TEUTONIC.

*Face page 198.*

machines preferred. evaporative drous ammonia atmosphere. The low evaporation of a small quantity produced, termed the dense ammonia evaporator.

On plate combined whole being covers at iron coils compressor with a stuffing-box not water-is the very maintained denser the vessel in stuffing-box a series of so as to avoid one of the they can removing. When the around the heat given to the liquid

machines instead of the duplex type which is now generally preferred. In the Linde system cold is produced by the evaporation under comparatively low pressure of liquid anhydrous ammonia, a liquid which possesses a boiling point at atmospheric pressure of about  $37\frac{1}{2}$  degrees below zero Fah. The low evaporating pressure is produced and maintained by a small pump, which draws off the vapour as quickly as it is produced, and then compresses and discharges it into a vessel, termed the condenser, in which the ammonia vapour is condensed and rendered fit for use again in the refrigerator or evaporator.

On plate G, is shown the pump or compressor, which is combined with a small single-cylinder steam-engine, the whole being mounted upon a box cast-iron bed-plate, with covers at each end, in which is contained the series of wrought iron coils forming the condenser. In the present instance the compressor is an ordinary double-acting pump of cast iron, with a metallic piston, steel valves and boxes, and a special stuffing-box for preventing the escape of the ammonia. It is not water-jacketted, as a special feature of the Linde system is the very low temperature—almost isothermal—that is maintained during compression. Before entering the condenser the compressed ammonia vapour is passed through a vessel in which any oil that may have entered through the stuffing-box is removed. The ammonia condenser consists of a series of wrought iron coils, each in one long length of tube, so as to avoid inaccessible joints. These coils are attached to one of the end covers of the bed frame, so that when required they can be readily drawn out for examination by merely removing the nuts of the bolts or studs fixing the cover. When the machine is in operation cold water is circulated around the coils by means of a pump, so as to carry off the heat given up by the ammonia in passing from the vaporous to the liquid state. In each machine a jet condenser with an



air pump is provided, for getting rid of the exhaust steam from the engine, but as a rule this is not used, as on the voyage the steam is exhausted into one of the surface condensers connected with the other machinery.

The refrigerators in which the liquid ammonia is evaporated consist of series of wrought iron tubes wound in such a manner as to get the largest amount of surface into the smallest amount of space. There are two sets of coils, one to each machine, but one of the sets is again divided into two in order that the refrigeration of the passengers' provision rooms can be carried on independently of the meat holds. The coils' spaces are shown in the illustration. They are below the meat holds, and are well insulated with wood and charcoal, in order to prevent the passage of heat from the machine room, which, owing to its position, becomes extremely hot in warm weather. The holds and provision rooms are cooled by means of currents of cold air produced by Blackman propellers, driven by independent steam engines. These fans draw the air from the holds and pass it over the coils in which the liquid ammonia is being evaporated. In this way the air is made to supply the heat required to evaporate the ammonia, and in so doing it becomes cooled to an extent which depends upon the quantity of air circulated. In actual practice about ten degrees is a very usual reduction. The air is circulated to and from the holds by wood trunks in the usual way.

It is of course impossible to exaggerate the importance of the steering gear in a ship like the *Teutonic*. The most elaborate precautions have been taken to secure immunity from breakdowns. The arrangement is novel in design, and covered by patents secured by Messrs. Harland and Wolff. In its main features it will be seen from the diagram, plate H, that it re-

sembles  
diameter  
is connecte  
arms, each  
The object  
and so re  
would of  
worked  
in duplic  
built up  
workman  
the ship.

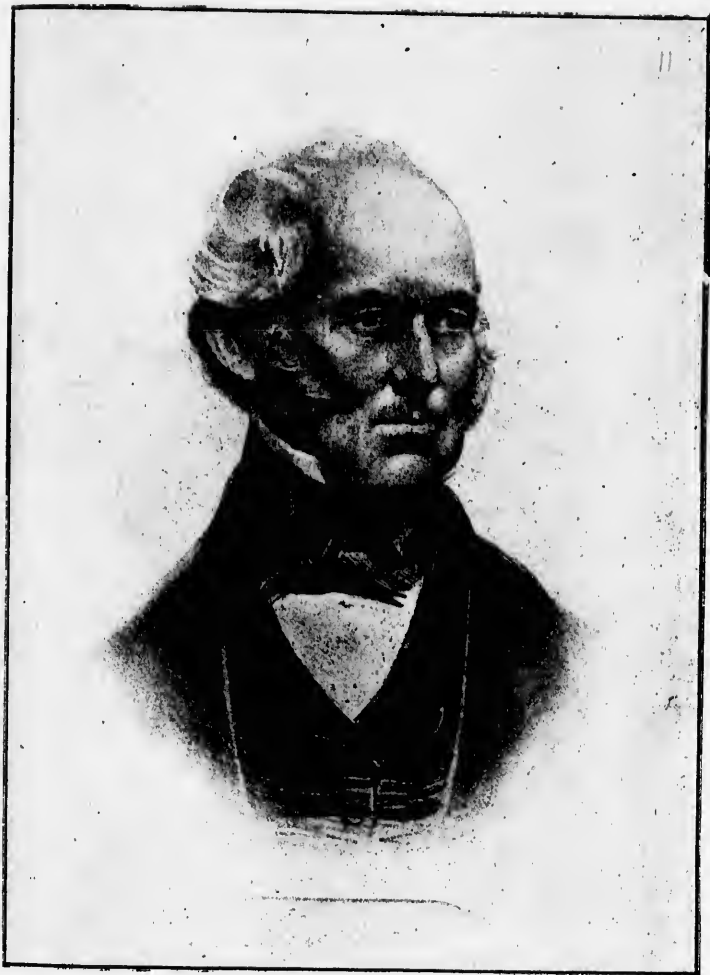
sembles a great horizontal spur wheel, 18 feet in diameter, movable round the rudder head. This wheel is connected to a tiller, keyed on the rudder head, by arms, each of which is made up of a layer of flat springs. The object of the springs is to take up the blow of a sea, and so relieve the gear of the excessive shock to which it would otherwise be subjected. The spur wheel is worked by specially designed steam steering engines, in duplicate. The tiller wheel and brake gear are all built up of cast steel, and, in regard to strength and workmanship, thoroughly in keeping with the rest of the ship.

## CHAPTER XII.

### THE MEN WHO HAVE MADE AND CONDUCT THE ATLANTIC FERRY.

TURNING now from the general doings of the great vessels and lines, it will be interesting to recall the individuals whose names have become for ever fixed in the pages of maritime history, and of whom many have now "gone down to rest." Among the first of these was SIR SAMUEL CUNARD, the founder of the great line now bearing his name, who was born in Newfoundland in November, 1787, and was there representing the great East India Company in Halifax, when he was attracted by the advertisement of the English Admiralty for the mail service across the Atlantic. Shortly afterwards (in 1838) he came to England, and having received an introduction to, he met and consulted with Mr. Robert Napier, of Glasgow, who in turn introduced him to Mr. G. Burns and Mr. David MacIver, which resulted in the line being founded and the contract signed by the three names, Samuel Cunard, George Burns, and David MacIver, and was continued by the joint firms of Cunard, Burns, and MacIver, until Sir Samuel's death in London on April 28th, 1865.

MR. GEORGE BURNS, who was associated with Mr. Cunard, was born in the neighbourhood of Glasgow in



SIR SAMUEL CUNARD, BART.

BORN 1787, DIED 1865.

ONE OF THE FOUNDERS OF THE CUNARD LINE. JOINT SIGNER OF FIRST ADMIRALTY  
MAIL CONTRACT.

E

vessels  
individuals  
the pages  
we now  
these was  
line now  
land in  
the great  
attracted  
for the  
wards (in  
an intro-  
Napier,  
G. Burns  
ne being  
e names,  
Iver, and  
urns, and  
on April

with Mr.  
Glasgow in

the year 1795, and in 1818 commenced business as a general merchant with his brother James in Glasgow. A few years afterwards he took over a fleet of sailing coasting vessels to Liverpool and elsewhere, and commenced with steamers to Belfast in the same year, 1824. Following the usual course, steam was substituted on the Liverpool line, and a fusion made with Messrs. MacIver, of Liverpool. After the founding of the Cunard Line, Mr. George Burns resided in Glasgow, looking after the interest of the line there, and also the extensive coasting trade, and eventually retired from business in 1860, from which time up to his death he resided at Wemyss Bay, on the River Clyde. In May, 1889, he was created a baronet, and died the following year on June 2nd, 1890, aged ninety-five years.

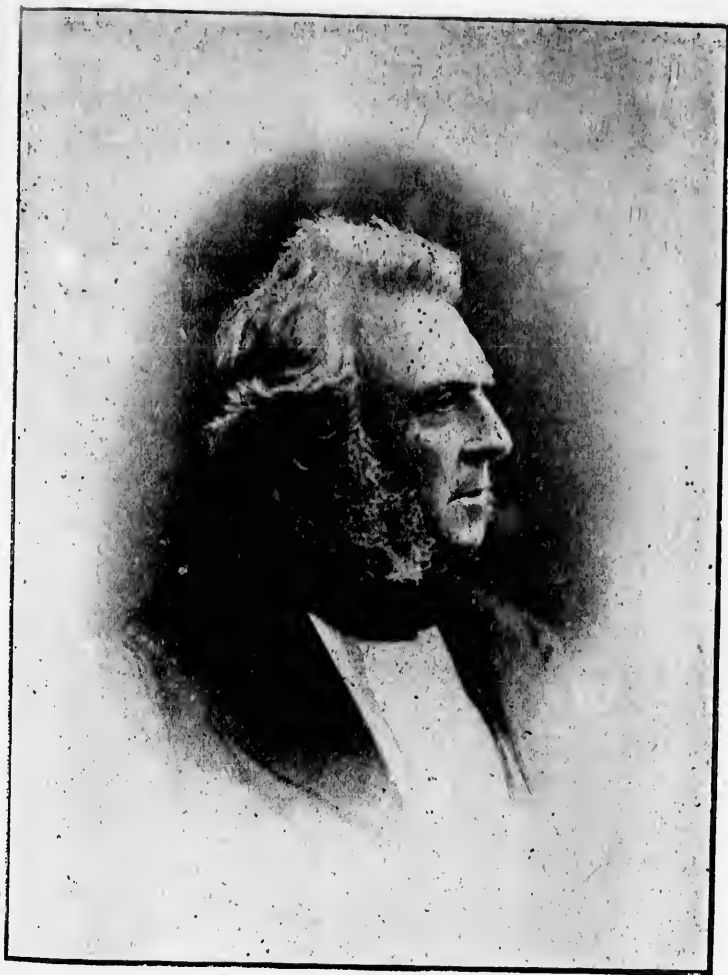
DAVID MACIVER, the other signatory to the contract with the Admiralty for carrying the mails, was born in Scotland in 1807, and was brought up in the office of the American Consul in Greenock. Together with his younger brother Charles he founded the well-known firm in Liverpool of D. and C. MacIver, which took charge of the Liverpool business of the Cunard Line, together with their other services, and was successfully carried on by them together until his death in 1845, aged only thirty-eight years.

The other great name which must be associated with this splendid enterprise was that of Mr. ROBERT NAPIER, the engineer, who practically rendered the venture a success, as his far-seeing judgment in designing and using the best-known systems of marine engineering,

S as a  
asgow.  
sailing  
l com-  
, 1824.  
ted on  
Messrs.  
Cunard  
ooking  
he ex-  
n busi-  
resided  
889, he  
ear on

ontract  
orn in  
ffice of  
ith his  
wn firm  
arge of  
er with  
l on by  
thirty-

ed with  
NAPIER,  
nture a  
ng and  
neering,

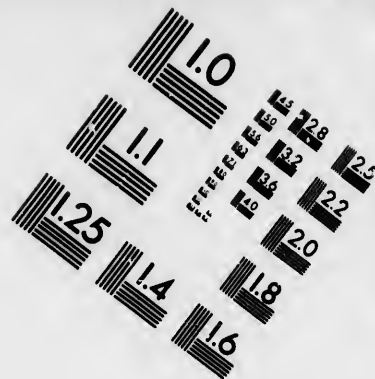
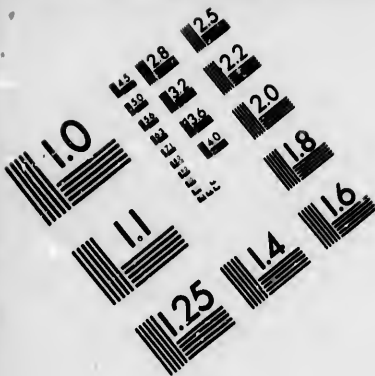


SIR GEORGE BURNS, BART.

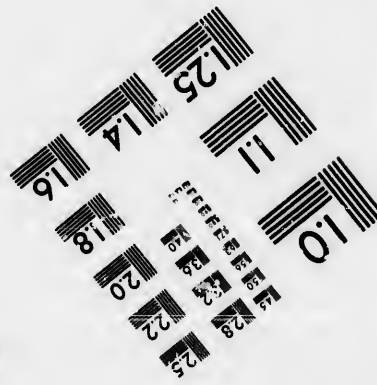
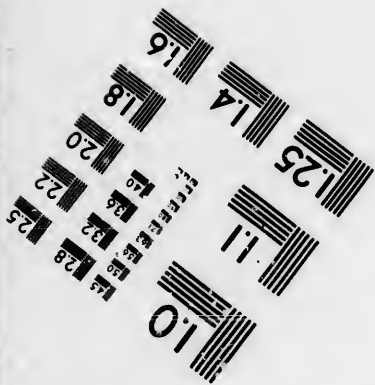
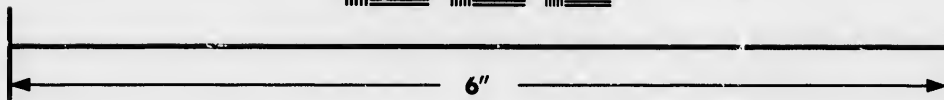
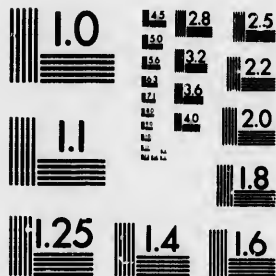
BORN 1795, DIED 1890.

ONE OF THE FOUNDERS OF THE CUNARD LINE. JOINT SIGNER OF FIRST ADMIRALTY  
MAIL CONTRACT.





**IMAGE EVALUATION  
TEST TARGET (MT-3)**



**Photographic  
Sciences  
Corporation**

23 WEST MAIN STREET  
WEBSTER, N.Y. 14580  
(716) 372-4503



18  
20  
22  
25  
28  
32  
36  
40  
45  
50  
56  
63  
72  
84  
96  
108  
125  
144  
168  
192  
225  
256  
288  
324  
360  
400  
450  
504  
576  
648  
720  
800  
900  
1000

10  
11  
12  
13  
14  
15  
16  
17  
18  
19  
20  
21  
22  
23  
24  
25  
26  
27  
28  
29  
30  
31  
32  
33  
34  
35  
36  
37  
38  
39  
40  
41  
42  
43  
44  
45  
46  
47  
48  
49  
50  
51  
52  
53  
54  
55  
56  
57  
58  
59  
60  
61  
62  
63  
64  
65  
66  
67  
68  
69  
70  
71  
72  
73  
74  
75  
76  
77  
78  
79  
80  
81  
82  
83  
84  
85  
86  
87  
88  
89  
90  
91  
92  
93  
94  
95  
96  
97  
98  
99  
100

prevented any breakdown or failures of machinery, which would have damaged the reputation and success of the line. He was born at Dumbarton on June 18th, 1791, and commenced business in May, 1815, by purchasing a small blacksmith's shop in Glasgow. Some years afterwards, in 1823, he made his first marine engine for a Clyde steamer, and continued afterwards making numerous engines for other boats down to 1839, when he made the engines for the Atlantic steamer **British Queen**, and also for the first four Cunard steamers, the connection with that firm being then formed. Amongst other noted vessels engined by him were the old three-decker **Duke of Wellington**, the last of England's wooden walls; the second of the English armour-clads, the **Black Prince**, built and engined by him, and other famous vessels. He died on June 22nd, 1876, aged eighty-five.

Amongst the names deserving a place on the roll of honour connected with the Transatlantic Service is that of Mr. E. K. COLLINS, the patriotic American who endeavoured in the earlier days of the trade to secure for his country a foremost place in the great steamship enterprises then just developing.

Mr. Collins was a native of Truro, Massachusetts, where he was born on August 5th, 1802. He commenced his business career at the age of fifteen, in New York City, and after a few years' service as junior, he was engaged by a firm of West Indian merchants, and was employed as purser—or, as it was then styled, supercargo—on board the vessels, where he had occa-

achinery,  
success  
the 18th,  
by pur-  
Some  
marine  
erwards  
to 1839,  
steamer  
eamers,  
formed.  
ere the  
ngland's  
r-clads,  
d other  
6, aged

e roll of  
is that  
o endea-  
e for his  
o enter-

husetts,  
e com-  
in New  
nior, he  
nts, and  
styled,  
d occa-



MR. DAVID MACIVER.

BORN 1807, DIED 1845.

CUNARD LINE. JOINT SIGNER OF FIRST ADMIRALTY MAIL CONTRACT.

sionally some exciting adventures with the numerous pirates then roving about those islands.

Some years afterwards, in 1822, he joined his father in the general shipping and commission business, and eventually became head of the firm, which he then commenced to develop extensively, first by putting fine full-rigged sailing ships on the West Indian and Mexican trade from New York; and later, in 1836, by establishing the splendid service of sailing packets between New



MR. ROBERT NAPIER.

INTRODUCER OF SIDE-LEVER ENGINES. BORN 1791, DIED 1876.

York and Liverpool, known as the Dramatic Line, on account of all the vessels having theatrical names, such as the **Shakespeare**, **Garrick**, etc. A noted departure in these fine vessels, besides their superior internal fittings, was the total abandonment of the fine-lined vessel having

a sharp r  
the opini  
the flat-fl



FOU

Like the  
liners, Mr. C  
ing of the e

a sharp rise of floor, and the substitution for it (against the opinions of the noted New York shipbuilders) of the flat-floored form of hull.



MR. E. K. COLLINS.

FOUNDER OF THE COLLINS LINE. BORN 1802, DIED 1878.

Like the other owners of the Transatlantic sailing liners, Mr. Collins watched with keen interest the working of the earlier British Atlantic steamers, and having

satisfied himself that they would prove rivals to the sailers, he endeavoured at an early date, but without any success, to induce the United States Government to assist in promoting a line of American-built and owned steamers, so as to be available for naval service.

His early appreciation of the utility of steamers was fully shown by a conversation he had with some friends on board one of his own sailers early in 1841, when seeing the ill-fated **President** steam past, he declared "that he would do his utmost to promote a line of steamers to cross to Liverpool in ten days." But as already noted, owing to the delay of the United States Government, it was not until 1847, when the Act was passed by Congress, that he was in a position actually to commence the formation of the steamship line bearing his name, and which two years afterwards, in 1849, commenced with the **Atlantic, Arctic, Baltic, and Pacific**.

Upon the withdrawal of the steamers early in 1858, he turned his attention to other matters, and died in New York in January, 1878.

Mr. WILLIAM INMAN, the founder of the line now bearing his name, was born at Leicester on April 6th, 1825, and was son of Mr. Charles Inman (a partner in the firm of Pickford and Co., the carriers), who having retired from that firm, came to Liverpool. Here his son William completed his education, and eventually became a partner in the firm of Richardson Brothers, in conjunction with whom he first promoted the steamship service, which he afterwards made so famous. This he successfully conducted until his death, in his fifty-sixth year,

to the  
without  
ment to  
d owned

ners was  
e friends  
1, when  
declared  
a line of  
But as  
d States  
Act was  
tually to  
e bearing  
49, com-  
ific.  
in 1858,  
d died in

line now  
April 6th,  
artner in  
o having  
e his son  
y became  
conjunc-  
p service,  
e success-  
xth year,



*William Inman*

FOUNDER OF INMAN LINE. BORN 1825, DIED 1881.

at Upton, his Cheshire residence, on July 3rd, 1881, shortly after the launch, and before the advent of, the beautiful **City of Rome**, the last vessel ordered by him.

Mr. STEPHEN BARKER GUION, the founder of the Guion Line, was of American birth, and came to Liverpool, about the year 1851, in connection with the steerage passenger trade of the Black Star Line of sailing ships, which he extensively developed. After a short connection, as agent, with the Cunard Company for the purpose of working up the steerage passenger traffic, followed by a similar connection with the National Line, he founded his own line in 1866, and successfully carried it on until shortly before his death. This took place on December 19th, 1885, in his sixty-sixth year, at Liverpool, where he was widely known and respected, having occupied several public positions with great credit and ability.

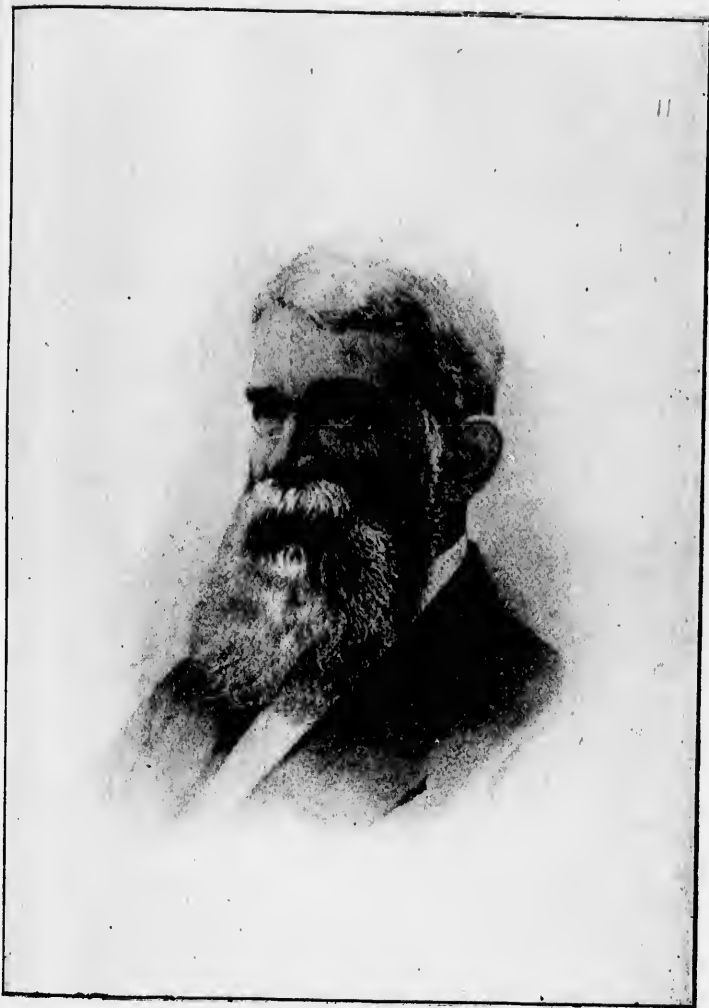
Mr. CHARLES MACIVER was born in Glasgow in the year 1811, and was early connected with his brothers in the shipping business, and on the death of his brother David he retained the sole management of the Liverpool branch of the line, which he conducted very energetically, the vessels of the Cunard Line being generally known in Liverpool as MacIver's boats. During the early days of the volunteer movement he raised a corps amongst the Cunard Line staff in Liverpool, and became colonel of it. In 1882 he retired from the line, not being in unison with his co-directors as to the future working of the concern, which was then feeling the rivalry of the other lines, and died a few years afterwards, in 1885, aged



l, 1881,  
went of,  
ered by

e Guion  
verpool,  
steerage  
g ships,  
ort con-  
for the  
traffic,  
al Line,  
y carried  
place on  
iverpool,  
occupied  
ility.

the year  
s in the  
er David  
l branch  
ally, the  
nown in  
y days of  
ngst the  
nel of it.  
n unison  
g of the  
he other  
85, aged



*J. Shuman*

FOUNDER OF GUION LINE. BORN 1819, DIED 1885.

seventy-four, at Malta, where he, for some time previously, had been in the habit of spending the winter.

SIR WILLIAM PEARCE was born at Brompton, near Chatham, on January 8th, 1833. He was trained in the Government service at Chatham, and from there he passed to the Clyde and assumed the management of Napier's Yard; but after a few years he took a position at Fairfield, where, in 1870, in conjunction with the relatives of John Elder, then deceased, he originated the firm of John Elder and Co., of which he became sole partner in 1878. It was just prior to this that he commenced the more extensive ventures of ocean navigation with which his name has become associated, since when he has built upwards of 200,000 tons of shipping, of nearly 300,000 horse-power, and over £7,000,000 sterling in value, amongst which may be mentioned the **Arizona**, built for the Guion Company, after the model and designs of the White Star boats; and also the **Alaska** and **Oregon**, vessels that for speed were only surpassed by his later achievements, the **Etruria** and **Umbria**, and later on by the new Inman and White Star liners from the yards of other noted firms.

Concurrently with this, he constructed the entire Atlantic fleet of the North German Lloyd's, which includes seven of the fastest ocean-going continental steamers afloat.

His great capacity for work, and his ceaseless energy, coupled with exceptional powers of management, and judgment in the selection of men, have resulted in the creation of a vast ship-producing organization, which accomplished the extraordinary feat of constructing an

MAP. XII.

ne pre-  
inter.

n, near  
trained  
m there  
agement  
position  
with the  
iginated  
became  
that he  
f ocean  
sociated,  
tons of  
nd over  
may be  
ompany,  
r boats;  
or speed  
e Etruria  
d White

re Atlan-  
les seven  
afloat.

s energy,  
ent, and  
ed in the  
n, which  
cting an



*John Bull*

CUNARD LINE. BORN 1811, DIED 1885

Atlantic liner of 5,000 tons in the incredibly short space of ninety-eight working days. He was elected the first member of the newly-created constituency of the Govan Division of Lanarkshire in 1885, and again in 1886, having previously contested Glasgow in the Conservative interest in 1880. He was chairman of the Guion Steamship Company and of the Scottish Oriental Steamship Company. He was created a baronet in 1887, and died in London, December 18th, 1889.

Mr. T. H. ISMAY, the founder and managing director of the White Star Line, was born at Maryport in the year 1837, and came to Liverpool, in 1852, as an apprentice to the shipping firm of Messrs. Imrie, Tomlinson and Co. On completion of his term with them, he proceeded to the west coast of South America in a sailing ship, the direct steam service then not having been established. On his return he joined, as junior partner, in 1860, the firm of P. Nelson and Co., and in 1864 became one of the directors of the National Line, then enjoying great prosperity. Afterwards, in 1866, he acquired the business of the famed White Star Line sailing fleet to Australia, having previously commenced business on his own account.

In 1869 he formed the White Star Line of steamers, and in 1870 was joined by Mr. Imrie,<sup>1</sup> one of his present partners, who was son of the senior partner of the firm in whose office he served his articles. Since then he has

<sup>1</sup> Since this was written his retirement from the firm has been announced, although still retaining his entire interest in and position of Chairman of the White Star Line.

CHAP. XII.

rt space  
the first  
e Govar  
n 1886  
ervative  
Steam  
eamshij  
nd died

director  
t in the  
appren-  
mlinson  
he pro-  
sailing  
n estab-  
tner, in  
became  
njoying  
red the  
fleet to  
s on his

eamers,  
present  
he firm  
he has

has been  
in and



*Thos. W. Inman*

FOUNDER OF WHITE STAR LINE. BORN 1837.

steadily aimed at and succeeded in making his famous line of steamers the head of the great shipping concerns of Great Britain, and has also found time to become a director of the Royal Insurance Company, and of the London and North Western Railway Company; the Chairmanship of which was recently offered to, but declined by, him. He has also served on several Royal Commissions, on which his extensive experience proved useful.

Not the least important point of his career was the propounding of the excellent arrangements in 1878 (when the general designs and arrangements of the **Teutonic** and **Majestic** were first worked out), by which the Government was enabled by a practicable and reasonable agreement, to directly connect the fastest steamers of all the great lines with the Royal Navy, for service in time of war, though they were not acted upon until some years later in 1887. Another pleasing record is the handing over of the sum of £20,000, as a nucleus for a fund for the support of aged and indigent merchant seamen, to commemorate the occurrence of his fiftieth birthday in the jubilee year of her Majesty, Queen Victoria, in 1887.

Mr. JAMES SPENCE, the senior and respected partner in the well-known firm of Richardson, Spence and Co., was born in the north of Ireland in 1829, and received his early training in Philadelphia, under his uncle, Mr. Clarke, who was one of the partners in the firm of Richardson, Watson and Co., of that city. This firm then owned an excellent line of packet ships, trading between that port and Liverpool, the agents or con-

[CHAP. XII.

is famous  
concerns  
become a  
nd of the  
the Chair-  
clined by,  
missions,  
l.

r was the  
in 1878  
ts of the  
by which  
eable and  
ne fastest  
Navy, for  
not acted  
r pleasing  
0,000, as a  
d indigent  
urrence of  
r Majesty,

ed partner  
e and Co.,  
d received  
uncle, Mr.  
e firm of  
This firm  
s, trading  
s or con-



*James Inman*

INMAN AND INTERNATIONAL LINE. BORN 1829.

signees in the latter port being Messrs. Richardson Brothers, which later on commenced the line now known as the Inman.

In 1854 Mr. Spence returned to England, and founded his now well-known house, in connection with Messrs. Thomas Richardson and Co., of New York and Philadelphia. In 1872 they became agents and managers in Europe for the American Steamship Company, better known as the American Line to Philadelphia, which still continues successfully under their able management.

In 1885 a further extension of his firm took place, in the acquisition of the business of the Inman Line, which had been absorbed by the International Company of America. This important accession was mainly carried through by his partner, Mr. Edmund Taylor, who had previously been with the old firm of Richardson Brothers, and who had been associated with Mr. Spence from the commencement as manager and partner.

Besides the extensive business of his firm, Mr. Spence also finds time to devote to the important Bank of Liverpool, of which he is one of the managing directors.

SIR EDWARD JAMES HARLAND, Bart., the head of the great shipbuilding and engineering firm at Belfast, is a native of Scarborough, where he was born in 1831. After spending a few years at college in Edinburgh, he was apprenticed in 1846 to the firm of Robert Stephenson and Co., Newcastle-on-Tyne, who were extensive builders of locomotives, and also marine and land engines. Upon the completion of his articles, he entered the drawing office of Messrs. J. and G. Thomson, Glasgow, where he



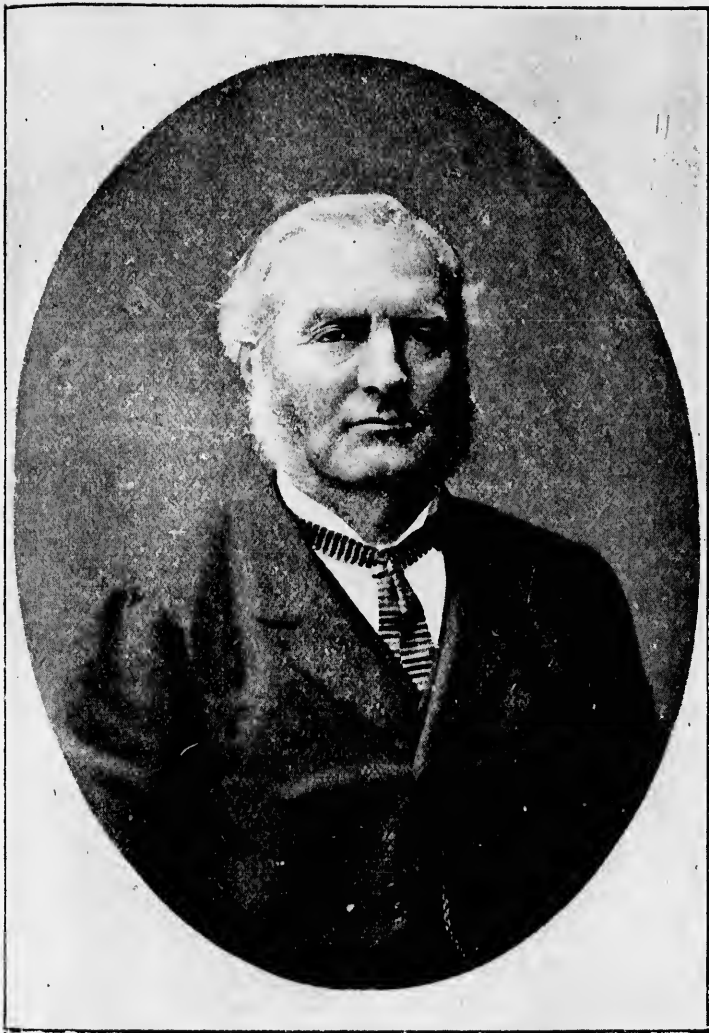
CHAP. XII.

Richardson  
now known

and founded  
Messrs.  
and Phila-  
managers in  
y, better  
a, which  
agement.  
place, in  
ne, which  
pany of  
y carried  
who had  
Brothers,  
from the

r. Spence  
of Liver-  
ors.

the great  
a native  
. After  
, he was  
ephenson  
builders  
es. Upon  
drawing  
where he



*J. A. Harland*

OF MESSRS. HARLAND AND WOLFE, BELFAST. BORN 1831.

was engaged until 1853, when he took over the management of a shipbuilding yard in Newcastle-on-Tyne, belonging to Messrs. Toward. After being there for a short time, he was offered a similar post in the Belfast shipyard, then owned by Messrs. Robert Hickson and Co., which he accepted towards the end of 1854.

In the year 1858 the owner retired, and he became proprietor of the concern himself, and built his first vessel, the steamship **Venetian** (until recently the African Steamship Company's steamship **Landana**) for Messrs. Bibby, of Liverpool, which he launched early in 1859. Soon afterwards, in 1860, he was joined by his present partner, Mr. Wolff, and since then the firm has achieved world-wide fame, and gradually grown, until it is now one of the most important and extensive in the world.

In 1885 Sir Edward Harland was elected Mayor of Belfast, and had been previously for some years Chairman of the Harbour Board, and was created a baronet of the United Kingdom in the year 1885. Some time afterwards, in 1889, he was elected Member of Parliament for one of the divisions of the city.

The extensive business of which he is the head is still ably carried on by the other partners, Messrs. Wolff, Wilson and Pirrie; the two latter of whom were amongst the first pupils trained by the firm.

Mr. JAMES R. THOMSON, the present managing director of the great Clydebank establishment, was born in Glasgow in the year 1844, and received his training in the shipyard of his father and uncle, James and George Thomson, then situated between Glasgow and Govan.

manage-  
Tyne, be-  
ere for a  
e Belfast  
kson and  
l.

e became  
his first  
e African  
r Messrs.  
in 1859.  
s present  
achieved  
s now one  
ld.

Mayor of  
rs Chair-  
a baronet  
ome time  
of Parlia-

ad is still  
s. Wolf,  
om were

g director  
born in  
aining in  
d George  
Govan.



MR. JAMES R. THOMSON.

OF MESSRS. J. AND G. THOMSON, SHIPBUILDERS, GLASGOW BORN 1844.

He joined the firm as partner in the year 1868, and has since continued to guide its course in the same satisfactory way as his predecessors, assisted by his brother, Mr. George P. Thomson.

Amongst the notable merchant vessels built by them may be mentioned the **Russia**, **Servia**, and **Aurania** for the Cunard Line; the high-speed **America** for the National Line; the **City of New York** and **City of Paris** for the Inman Line; and the **Friesland** for the Red Star Line of Antwerp.

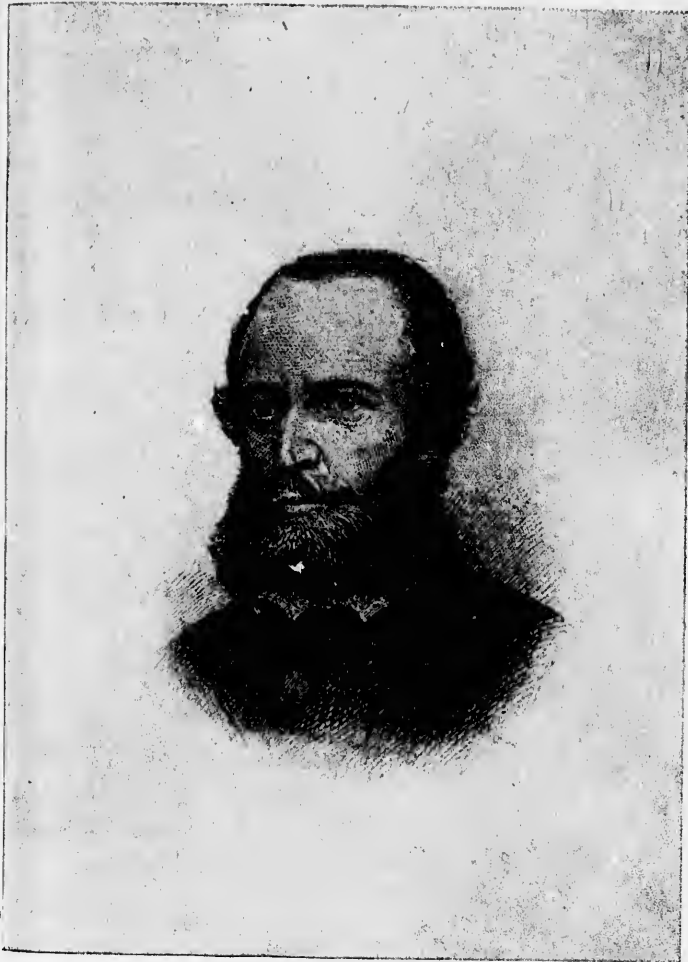
In addition to these, this extensive establishment has of late years turned out some noted warships, such as the **Reina Regente**, **El Destructor**, **Chizoda**, and others for foreign governments; and the **Ramillies**, **Terpsichore**, **Thetis**, and others for the British Government.

Another of the noted engineers, indirectly connected with the Transatlantic trade, who have left their mark, is Mr. JOHN ELDER, to whom belongs the honour of being the first to introduce successfully the compound, or double expansion engine. He was born at Glasgow on March 8th, 1824, and received his technical training in the shops of Mr. Robert Napier.

After working for a short time in some shops in England, he returned to Glasgow, and joined the firm of Randolph and Cunliffe, afterwards known as Randolph, Elder and Co., and supplied the first compound engine to a paddle steamer, named the **Brandon**, in 1854.

Some years later, in 1868, he became sole owner of the establishment, and changed the firm to John Elder and Co., under which style it has turned out some of the well-known vessels of to-day.

1868, and  
the same  
ed by his  
by them  
ia for the  
National  
he Inman  
Antwerp.  
ment has  
s, such as  
others for  
erpsichore,  
connected  
eir mark,  
onour of  
ompound,  
Glasgow  
l training  
s in Eng-  
e firm of  
Randolph,  
and engine  
54.  
owner of  
ohn Elder  
me of the



MR. JOHN ELDER.

INTRODUCER OF COMPOUND ENGINES. BORN 1824, DIED 1869.

The following year, 1869, he died in London at the early age of forty-five, leaving a large fortune to his widow, who has generously applied it to promote the science of naval architecture and engineering, to which her husband personally contributed so much.

Amongst the numerous Clyde engineers who have won for themselves a distinguished position must be mentioned Mr. ALEXANDER C. KIRK, LL.D., to whom belongs the honour of having made the now universally adopted triple expansion engine a practical success.

Mr. Kirk is a native of Forfarshire, and was born in 1830. He received his technical training at the works of Robert Napier. Afterwards he entered the service of Messrs, Young, Meldrum and Binny in their paraffin oil works, and when there, had his attention turned to the want of an effective means to maintain a low temperature throughout the summer months, which was required to extract the solid paraffin.

After careful study and experimenting, he eventually succeeded in producing the first successful refrigerating machine, afterwards developed by Bell, Coleman, and others.

In 1870 Messrs. John Elder and Co. appointed him manager of their engineering works, from which time he has been directly connected with marine engineering. In 1874 he designed and had built the first large triple expansion engines for the steamship **Propontis**, but owing to the failure of the boilers they were not successful.

Some years later, owing to the great improvements made in the manufacture of the ordinary marine boilers,

CHAP. XII.

n at the  
ne to his  
note the  
to which

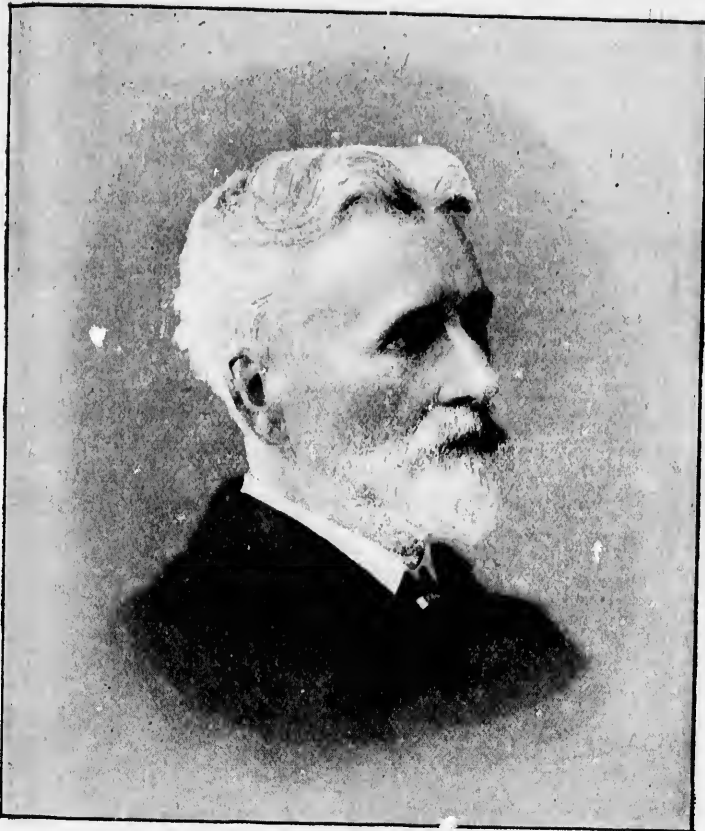
who have  
must be  
to whom  
niversally  
cess.

s born in  
the works  
service of  
r paraffin  
turned to  
low tem-  
hich was

eventually  
rigrating  
man, and

inted him  
h time he  
ngineering.  
rge triple  
but owing  
essful.

rovements  
ne boilers,



*Alexander Kirk*

INTRODUCER OF TRIPLE EXPANSION ENGINES. BORN 1830

which enabled higher pressures to be carried, he again turned his attention to the triple expansion system, and in 1881 produced the steamship **Aberdeen**, which was a complete success, and was soon followed by others; so that, although triple engines had been previously made by the Ouseburn Engine Works, and the system also used by Messrs. Perkins, it is to Dr. Kirk that the credit must be given of being the first to make them a practical success. In 1877 he joined his present firm of Messrs. R. Napier and Sons, Glasgow, as senior partner.

Of the superintending engineers who are responsible for the machinery of these great vessels, it is interesting to note that the first gentleman to occupy this important post in any of the regular lines was Mr. Robert Thomson, who was engineer to the Cunard Line under the *régime* of Messrs. D. and C. MacIver from the commencement, until his death in October, 1871. Mr. Thomson was born at Partick, Glasgow, in 1811, and served his apprenticeship with a firm of millwrights and engineers named Graham, Wellington and Co. Afterwards he commenced his sea service on one of the early steamers, named the **Commodore**, trading between Glasgow and Liverpool, from which he joined the Cunard Line. On his death, in 1871, he was succeeded by his assistant, Mr. Logan, who occupied the position until his death in 1885. Mr. Logan was succeeded by the present superintendent engineer, Mr. James Bain, who was appointed to the post from Lloyd's Registry, in which service he was engaged as engineer surveyor.

His earl  
he was  
whence  
engineer  
Star Lin  
in which  
Lloyd's i

The fir  
was Mr.  
Liverpoo  
consultin  
years, h  
1864, by  
for some  
Leven, F  
of Messr  
down to  
T. F. Irw  
After a fe  
practice  
ceeded b  
until his  
of the lin  
duties, h  
the Red  
undertak  
The we  
Line, Mr  
where he  
Caledonia



His earlier training was received at Glasgow, where he was apprenticed to Messrs. R. Napier and Co., from whence he joined the Cunard Company as sea-going engineer. Afterwards, in 1872, he joined the White Star Line, then bringing forward its new style of boats, in which he sailed as chief engineer until appointed to Lloyd's in 1875.

The first superintendent engineer of the Inman Line was Mr. Douglas Hebson, who has long been known in Liverpool, where he carried on an extensive practice as consulting engineer. After occupying the post for a few years, he resigned, and was succeeded, in the year 1864, by Mr. John Purves, who had been assisting him for some years previous. Mr. Purves was a native of Leven, Fifeshire, and received his training in the shops of Messrs. R. and W. Hawthorn. He occupied the post down to the year 1880, when he was succeeded by Mr. T. F. Irwin, and died soon after at Liverpool, in 1884. After a few years Mr. Irwin, having entered into private practice as consulting engineer in Liverpool, was succeeded by Mr. George Allibon, who retained the post until his death in 1885, when the present superintendent of the line, Mr. J. S. Doran, of New York, assumed the duties, having been for some years superintendent of the Red Star Line, which at that time took over the undertaking.

The well-known superintendent engineer of the Allan Line, Mr. William Wallace, is a native of Greenock, where he received his training in the shops of the Caledonian Railway and Messrs. Caird. On completion

of his apprenticeship he entered the shops of Messrs. Tulloch and Denny, of Dumbarton, and afterwards came to Liverpool to look after the engine department of the line some years after its commencement, and has since continued in the same position, where he has won for himself well-deserved reputation.

The other great line, the White Star, has its engineering department under the superintendence of Mr. S. Gordon Horsburgh, who has occupied the post almost since its creation. He is a native of Dundee, and was apprenticed in the engineering works of Messrs. J. and G. Thomson, of Clydebank, Glasgow, after leaving which he served as sea-going engineer in the service of Messrs. Bibby, of Liverpool, and was from that line appointed to his present position in 1871. Since joining this famous service he has been most successful in helping to sustain the splendid reputation of the line, and by so discharging his onerous duties as to deserve the confidence and esteem of everyone coming in contact with him.

On the commencement of the Guion Line, the charge of the engine department was placed under the superintendence of Mr. Jordan, who was responsible for the vessels during construction until after the building of the **Montana** and **Dakota**. He continued in the position until the year 1876, when he resigned, and was succeeded by the present superintendent, Mr. J. G. Hughes, since when the noted vessels, **Arizona**, **Alaska**, and **Oregon** have been added to the fleet.

TURNING  
teresting  
the last f  
the earlie  
time by th  
and journe

As an  
steamboat  
"Agricult  
author's p  
notice of

"An A  
Several a  
of steam  
and there  
taking by  
Mr. Symin  
success, an  
a connecti  
attended v

"By p  
position,  
has alway  
the comm  
its positio  
means of

Messrs.  
ds came  
t of the  
as since  
won for

engineer-  
Mr. S.  
almost  
and was  
J. and  
g which  
Messrs.  
ppointed  
ing this  
helping  
nd by so  
he con-  
act with

e charge  
e super-  
for the  
lding of  
position  
was suc-  
Hughes,  
d Oregon

## CHAPTER XIII.

### EARLIER EVENTS.

TURNING now to a general review of the various interesting incidents of the great Atlantic trade during the last fifty years, no better record can be obtained of the earlier events than those published from time to time by the various Liverpool and New York newspapers and journals.

As an instance of the earlier newspaper notices of steamboats, it may be well to refer to a page from the "Agricultural Magazine" for November, 1803, in the author's possession, which gives the following under its notice of "Manufactures and Useful Arts:"—

*An Account of Mr. Symington's New Steam Boat*—  
Several attempts have been made to apply the force of steam to the purpose of propelling boats in canals, and there seems to be no reason to think the undertaking by any means liable to insuperable difficulties. Mr. Symington appears already to have had considerable success, and the method that he has employed for making a connection between the piston and the water-wheel, is attended with many advantages.

"By placing the cylinder nearly in a horizontal position, he avoids the introduction of a beam, which has always been a troublesome and expensive part of the common steam engines: the piston is supported in its position by friction wheels, and communicates by means of a joint with a crank, connected with a wheel,

which gives the water-wheel, by means of its teeth, a motion somewhat slower than its own; the water-wheel serving also as a fly. The steam engine differs but little with respect to the condensation of the steam, from those of Boulton and Watt now in general use: there is an apparatus for opening and shutting the cocks at pleasure, in order to reverse the motion of the boat whenever it may be necessary. The water-wheel is situated in a cavity near the stern, and in the middle of the breadth of the boat, so that it becomes necessary to have two rudders, one on each side, connected together by rods, which are moved by a winch near the head of the boat, so that the person who attends the engine, may also steer. It has been found most advantageous to have a very small number of float boards in the water-wheel.

Another material part of the invention consists in the arrangement of stampers, at the head of the boat, for the purpose of breaking the ice on canals, an operation which is often attended with great labour and expense. These stampers are raised in succession by means of levers, of which the ends are depressed by the pins of wheels, turned by an axis communicating with the water-wheel.

Mr. Symington calculates that a boat capable of doing the work of twelve horses, may be built for eight or nine hundred pounds. An engine of the kind has been actually constructed at the expense of the proprietors of the Forth and Clyde Navigation, and under the patronage of the Governor, Lord Dundas: it was tried in December (1801), and it drew three vessels, of from 60 to 70 tons burden, at the usual rate of two miles and a half an hour. Mr. Symington is at present (July 1802) employed in attempting still further improvements, and when he has completed his invention, it may, perhaps, ultimately become productive of very extensive utility.

“October 18, 1803.

“W.”

This is  
steambos

But in  
any acci  
steamer  
tensity o  
feeling ex  
on the re  
Line stea  
that port  
which ha  
Harbour  
then exist  
for a com

“The  
safety.”  
port, on S  
and grat  
pleasure  
of the ste  
and the c  
come inte  
similar ac  
the Cuna  
disabled  
made thi  
can, the  
the expect  
created in  
guns hear  
thousands

<sup>1</sup> Liverpool  
Herald”).

This is interesting as being one of the first notices of steamboats.

But in former days the most interest was aroused when any accident occurred which delayed the arrival of the steamer at the appointed time; the nature of the intensity of this excitement may be judged from the deep feeling expressed in an article in the "New York Herald" on the reception of the news of the safety of the Collins' Line steamer **Atlantic**, which had been long overdue at that port, owing to the breakage of the paddle-shaft, which had compelled her to put back to Queenstown Harbour instead of going on, and as no telegraph cables then existed, the news was not received in New York for a considerable time afterwards.

"*The fate of the **Atlantic** (Collins' Line), account of her safety.*"<sup>1</sup>—By the arrival of the steamship **Africa** at this port, on Saturday, the 14th, we received the most welcome and gratifying intelligence that it has ever been our pleasure to place before our readers, namely, the safety of the steamship **Atlantic**. We congratulate our readers and the community at large on the receipt of this welcome intelligence. The **Atlantic**, it seems, experienced a similar accident to that which the steamship **Niagara**, of the Cunard Line, met with about a year ago, and which disabled her on her trip to New York. Now, having made this joyful announcement, let us describe, if we can, the sensation which the arrival of the **Africa**, and the expectation of her bringing intelligence of the **Atlantic**, created in New York and vicinity. No sooner were her guns heard in the city, than hundreds, and we may say thousands, of our citizens rushed to the Battery and to

<sup>1</sup> Liverpool "Albion," March 10th, 1851 (from the "New York Herald").

all the docks on the north river from the depot of the Collins' Line of steamships to Castle Garden, to ascertain whether the **Atlantic** had been heard from. They were tantalized by the reports of the **Africa's** guns, as they were fired, one after another, for upwards of an hour, and many an eye was strained in looking for the blue and red lights, the signals of the vessels of the Collins' Line. At length a steamship was seen approaching the city from Quarantine; but the signals which she bore were not those of the **Atlantic** or any vessel of the Collins' Line. 'But if this is not the **Atlantic** it must be the **Africa**, and she will, no doubt, bring some intelligence of the **Atlantic**,' argued the more intelligent of the anxious multitude. It was the **Africa**; and as she came up the bay, firing gun after gun, it was believed by the thousands on the look-out that that vessel would not expend so much powder to announce her own arrival only. 'It must be that the **Africa** brings good news of the **Atlantic**, or she would not fire so many guns,' said the multitude. 'What can it mean, what is the object of this uncommon firing?' was the inquiry on every side, and the response was, 'The **Atlantic** is safe; the **Atlantic** has been heard from.' Soon the **Africa** approached her dock; but she did not move half fast enough to satisfy the impetuosity of the thousands who felt as if every moment was an hour until her arrival. At length the **Africa** reached her wharf in Jersey City, and when she got within hailing distance one of the officers ascended the paddle-box and with his trumpet announced, 'The **Atlantic** is safe; she has put into Cork with a broken shaft.' A shout of rejoicing at once went up, which made the welkin ring, which was continued for several minutes. During all this time the crowd grew larger, while many of those who heard the glad news ran home to tell it to their families and friends.

"But what shall we say of the excitement which the account of the safety of the **Atlantic** created in New York, and especially in the lower part of the city? No sooner

were th  
on the r  
neighbo  
any info  
publicat  
extent t  
connect  
ingress  
ment wa  
is safe'  
theatres  
in those  
ensued:  
passed fr  
until ev  
gratifyin  
limits of  
woman,  
last nigh  
**Atlantic**

Notwit  
altogethe  
inaugura  
Lords of  
their adv  
comment

"Iron  
the Adm  
contract  
sacrifices  
The chan  
reluctanc  
knowledg  
right and  
which thi  
of a claus

were the guns of the **Africa** heard than every one living on the north side of the city hurried to the docks in the neighbourhood of the north river, and eagerly sought for any information concerning this favourite vessel. The publication office of this paper was crowded to such an extent that it was with great difficulty the gentlemen connected with the establishment could find a way of ingress or egress. From our establishment the excitement was carried to all parts of the city. 'The **Atlantic** is safe' was announced from the stages of the different theatres. The performances were temporarily suspended in those places of amusement by the cheering which ensued: and out of doors the welcome intelligence was passed from person to person, that 'the **Atlantic** is safe,' until every one in the city was acquainted with the gratifying intelligence. We confine ourselves within the limits of truth and fact, when we say that every man, woman, and child in our great metropolis went to bed last night with a 'thank God' on their lips that the **Atlantic** was safe."

Notwithstanding that the iron hulls for vessels were altogether adopted by the Inman Company from the inauguration of the line, it would appear that the Lords of the Admiralty had not in 1852 awakened to their advantages, as the "Times" of January, 1852, commenting on the matter, had the following:—

"*Iron v. Wood.*—A general impression prevails that the Admiralty prohibition of the use of iron for mail contract steamers, which has thus far cost so many sacrifices, is intended henceforth to be abandoned. The change, however, seems likely to be made with reluctance, and without any open and creditable acknowledgment that the public have all along been in the right and the Government in the wrong. The mode in which this acknowledgment is avoided is by the insertion of a clause, whenever notices for new tenders are issued,

which the  
New York,  
No sooner



to the effect that the vessels are to be of wood, but that the parties to the competition may state what deduction they will make upon being allowed to substitute iron. In this way, it is understood, the last two new contracts have been managed, so as to admit of a quiet and, as it were, unacknowledged departure from the old rule. There is no admission that iron is the best material, and it is made to appear, in fact, as if it were something inferior, which might be put up with on account of its cheapness. The Admiralty, however, would probably themselves be sorry to admit that mere economy has anything to do with the matter. Safety of life and cargo, and efficiency as regards speed and all the other attributes of a good vessel, are the first things to be looked to, and economy can only be a recommendation when it is superadded to them. By adopting iron on the latter ground the Admiralty, therefore, virtually show that they hold it to be superior to the former. With regard to the necessity of postal vessels being built of wood to enable them to resist shot and to be turned into war steamers, the recent contracts for Australia and the African coast indicate that this point has been abandoned. Apart from the fact that speedy communication with our colonies would be more than ever necessary during war, the Government may at length have recognized that the condition essential, above all others, with respect to vessels performing such a service is, that they should be of a material that would enable them by their speed almost to defy capture, and that would at the same time, in case such a loss should occur, prevent them from being of any use to the enemy. Hitherto the very opposite principle has been acted upon. The vessels have been rendered slow by the peculiar build and material requisite to adapt them to war purposes, while this adaptation causes them to assume a character which would constitute them valuable prizes that might be turned at once into weapons of offence against us."

At the  
the screw  
and the  
instanced  
April 26th  
City of M  
Steamers

"The  
pool and  
City of M  
Mersey, 1  
16th, wi  
cargo. A  
this voya  
the west  
she left  
Royal Ma  
in Philad  
the whol  
having b  
homewar  
days lat  
the Niag  
days afte  
wards, be  
speed; if  
The City  
and mea  
delphia;  
on her an  
ballast.  
is a padd  
1,008 to  
of Manch  
measurere



At the same time the interest in the contest between the screw and paddle steamers began to be aroused, and the doings of each came to be duly advertised, as instanced by advertisements in the Liverpool "Albion" of April 26th, 1852, under the headings "Screw Steamship, **City of Manchester**," and "Paddle-Wheel versus Screw Steamers."

"*The Screw Steamship City of Manchester.*—The Liverpool and Philadelphia Steamship Company's steamship **City of Manchester**, Captain Robert Leitch, arrived in the Mersey, from Philadelphia, at nine p.m., on Friday, the 16th, with seventy-seven passengers and a very full cargo. An opportunity for comparison has offered on this voyage between screw and paddle steamers, both to the westward and eastward. On her outward voyage, she left Liverpool exactly twelve hours before the Royal Mail steamship **Niagara**, and delivered her letters in Philadelphia on the same day, they having gone the whole distance by water, and the **Niagara's** mails having been sent from Boston by railway. On the homeward passage, the **City of Manchester** brings three days later Philadelphia newspapers and letters than the **Niagara**, and entered the Mersey exactly three days after her. The passages, both outwards and homewards, being, as nearly as possible, at the same rate of speed; if anything, in favour of the **City of Manchester**. The **City of Manchester** had 1,100 tons of cargo, weight and measurement on board on her arrival at Philadelphia; and had 1,200 tons weight of cargo on board on her arrival at Liverpool, the **Niagara** coming home in ballast. According to Government returns, the **Niagara** is a paddle steamer of 1,850 tons builder's measurement, 1,008 tons register, and 750 horse-power. The **City of Manchester** is a screw steamer of 2,125 tons builder's measurement, 1,309 tons register, and 350 horse-power.

PADDLE-WHEEL *versus* SCREW STEAMERS.

As even sailing ships, under favourable circumstances, may, once in a time, equal the speed of the best ocean steamers, so is it quite possible for any large-sized screw, of even small engine-power, to do almost as much once in the twelve months; but "an opportunity for comparison has offered on other voyages (besides the one noted above) between screw and paddle steamers, both to the eastward and westward," as the following statement of the passages of the Cunard steamers and the Liverpool and Philadelphia *screws* very plainly illustrates:—

## PASSAGES TO THE WESTWARD.

Vessel's Name.	For	Date of Sailing.	Date of Arrival.	Passage about
<i>City of Glasgow</i> . . .	Philadelphia.	1850.	1851.	D. H.
		Dec. 11	Jan. 2	22 0
Africa . . . . .	New York .	Dec. 7	1850.	14 17
			Dec. 22	
<i>City of Glasgow</i> . . .	Philadelphia.	1851.	1851.	18 18
		Feb. 12	Mar. 3	
Europa . . . . .	Boston.	Feb. 15	Feb. 28	13 0
<i>City of Glasgow</i> . . .	Philadelphia.	April 16	May 4	18 0
Asia . . . . .	New York .	April 12	April 23	10 22
<i>City of Glasgow</i> . . .	Philadelphia.	June 18	July 7	19 0
Africa . . . . .	New York .	June 21	July 2	11 3
<i>City of Manchester</i> . .	Philadelphia.	July 26	Aug. 13	18 6
Europa . . . . .	Boston.	July 26	Aug. 5	10 12
<i>City of Glasgow</i> . . .	Philadelphia.	Aug. 13	Aug. 30	17 6
Asia . . . . .	New York .	Aug. 16	Aug. 28	12 9
<i>City of Manchester</i> . .	Philadelphia.	Sept. 17	Oct. 3	16 6
Africa . . . . .	New York .	Sept. 13	Sept. 24	10 23
<i>City of Glasgow</i> . . .	Philadelphia.	Oct. 8	Oct. 28	20 3
Niagara . . . . .	New York .	Oct. 11	Oct. 25	14 0
<i>City of Manchester</i> . .	Philadelphia.	Nov. 5	Nov. 20	15 6
Africa . . . . .	New York .	Nov. 8	Nov. 19	11 8
<i>City of Pittsburgh</i> . .	Philadelphia.	1852.	1852.	43 0
		Nov. 29	Jan. 11	
Niagara . . . . .	Boston.	1851.	1851.	13 16
		Nov. 29	Dec. 13	
<i>City of Glasgow</i> . . .	Philadelphia.	Dec. 10	Jan. 1	22 0
Europa . . . . .	New York .	Dec. 6	Dec. 23	16 23
<i>City of Manchester</i> . .	Philadelphia.	1852.	1852.	40 0
		Dec. 31	Feb. 9	
Asia . . . . .	New York .	1852.	1852.	13 12
		Jan. 3	Jan. 16	
<i>City of Glasgow</i> . . .	Philadelphia.	Feb. 4	Feb. 24	20 10
Canada . . . . .	New York .	Jan. 31	Feb. 18	17 21
<i>City of Manchester</i> . .	Philadelphia.	Mar. 5	Mar. 20	15 1
Asia . . . . .	New York .	Feb. 28	Mar. 12	12 23

Vessel

*City of Glasgow*  
Niagara . . .  
*City of Glasgow*  
Europa . . .  
*City of Glasgow*  
Niagara . . .  
*City of Glasgow*  
Africa . . .  
*City of Manchester*  
Africa . . .  
*City of Glasgow*  
Asia . . . . .  
*City of Manchester*  
Africa . . . . .  
*City of Pittsburgh*  
America . . .  
*City of Glasgow*  
Niagara . . .  
*City of Manchester*  
Africa . . . . .

*City of Glasgow*  
Canada . . . . .  
*City of Manchester*  
Canada . . . . .  
*City of Glasgow*  
Cambria . . . . .  
*City of Manchester*  
Niagara . . . . .

Another  
upon the  
having m  
of the fir  
Steamship  
"Albion"  
"Immer  
meeting of

PASSAGES FROM THE WESTWARD.

Vessel's Name.	From	Date of Sailing.	Date of Arrival.	Passage about
		1851.	1851.	D. H.
<i>City of Glasgow</i> . . . .	Philadelphia.	Jan. 16	Jan. 30	13 16
Niagara . . . . .	Boston.	Jan. 15	Jan. 27	12 0
<i>City of Glasgow</i> . . . .	Philadelphia.	Mar. 15	Mar. 31	15 12
Europa . . . . .	Boston.	Mar. 12	Mar. 23	11 0
<i>City of Glasgow</i> . . . .	Philadelphia.	May 15	May 31	15 18
Niagara . . . . .	Boston.	May 14	May 25	10 12
<i>City of Glasgow</i> . . . .	Philadelphia.	July 17	Aug. 1	14 18
Africa . . . . .	New York	July 16	July 26	10 5
<i>City of Manchester</i> . . .	Philadelphia.	Aug. 28	Sept. 14	17 6
Africa . . . . .	New York	Aug. 27	Sept. 6	10 6
<i>City of Glasgow</i> . . . .	Philadelphia.	Sept. 11	Oct. 1	20 0
Asia . . . . .	New York	Sept. 10	Sept. 21	10 19
<i>City of Manchester</i> . . .	Philadelphia.	Oct. 9	Oct. 23	14 3
Africa . . . . .	New York	Oct. 8	Oct. 19	10 9
<i>City of Pittsburgh</i> . . .	Philadelphia.	Oct. 27	Nov. 16	19 12
America . . . . .	Boston.	Oct. 29	Nov. 9	11 5
<i>City of Glasgow</i> . . . .	Philadelphia.	Nov. 6	Nov. 23	17 1
Niagara . . . . .	New York	Nov. 5	Nov. 18	12 12
<i>City of Manchester</i> . . .	Philadelphia.	Dec. 4	Dec. 20	15 6
Africa . . . . .	New York	Dec. 3	Dec. 14	11 3
		1852.	1852.	
<i>City of Glasgow</i> . . . .	Philadelphia.	Jan. 8	Jan. 23	15 0
Canada . . . . .	Boston.	Jan. 7	Jan. 18	10 10
<i>City of Manchester</i> . . .	Philadelphia.	Feb. 24	Mar. 12	17 0
Canada . . . . .	New York	Feb. 25	Mar. 8	11 17
<i>City of Glasgow</i> . . . .	Philadelphia.	Mar. 4	Mar. 23	18 18
Cambria . . . . .	Boston.	Mar. 3	Mar. 16	12 17
<i>City of Manchester</i> . . .	Philadelphia.	April 1	April 16	15 6
Niagara . . . . .	Boston.	Mar. 31	April 13	13 4

Another interesting newspaper article which bears upon the Atlantic trade, owing to the vessel herself having made a few voyages in this trade, is the report of the first annual meeting of the "Great Eastern" Steamship Company, which appeared in the Liverpool "Albion" of August 8th, 1853, under the heading of:—

"Immense Ocean Steamers.—At the first half-yearly meeting of the Eastern Steam Navigation Company, held

in London, on Saturday, the Chairman (Mr. H. T. Hope) stated that their anticipated success was based upon the fact of their being able to carry goods and passengers without the numerous stoppages which a voyage to India or Australia entailed upon other vessels. Their theory, right or wrong, was, that until vessels were constructed of a magnitude sufficient to carry a quantity of coals suitable to the length of the voyage, the full advantages which steam navigation was calculated to confer would not be secured to passengers to India or Australia. Their capital was £1,200,000, with power to increase it to £2,000,000, and until one-tenth of the capital, or £120,000, was paid up, they could not enter into any binding contract for the building of vessels or execution of works. The company, therefore, were not responsible for the works that had been already undertaken; everything had been done at the risk of the contractors. On the last occasion of their meeting it had been suggested that they ought not to commence operations until 40,000 shares had been taken, representing a capital of £800,000. They were a few hundred shares short of that absolute amount, but they had upwards of 39,000 shares taken, and the others would probably be taken up when the parties who had applied for them returned to town. The report was then read. It stated that they had invited tenders from several parties, and had concluded provisional arrangements for the construction of the engines and of the hull of the first ship with Messrs. James Watt and Co., of Soho, and Messrs. Scott Russell and Co., of London. The ship will be built on the Thames, and is to be completed in eighteen months. The dimensions and power of the ships are intended to be as follows, viz. :—Length, 680 feet; breadth, 83 feet; depth, 58 feet, with screw and paddle engines; aggregate nominal horse-power, 2,600. They are to be so constructed as to take their whole amount of coals for the voyage from near the pit's mouth at a rate not exceeding, for the best quality, 12s. to 14s. per ton. On the voyage

of existin  
the const  
the cost  
taken on  
tion with  
their own  
merchan  
the high  
class pas  
will not  
than tho  
precedent  
which th  
afford. I  
directors  
of a spee  
applicabl  
the mine  
ships, bo  
tionately  
will und  
enable th  
fifteen kn  
to their t  
ten knots  
more than  
dimension  
many pre  
and secur  
to six feet  
cellular co  
affect the  
deck will  
that each  
tube of th  
into ten c  
and, as th  
ships, bei

of existing steamships to Australia or India and home, the consumption amounts to from 4,000 to 6,000 tons; the cost of which would supply 15,000 to 20,000 tons if taken on board at some port in immediate communication with the coal-field. The ships will carry, besides their own coals, upwards of 5,000 tons' measurement of merchandise, and will have 500 cabins for passengers of the highest class, with ample space for troops and lower class passengers. These, the directors consider, they will not only be able to carry at rates much smaller than those by any existing steamships, but with an unprecedented amount of room, comfort, and convenience, which the great size of the vessels will enable them to afford. In thus increasing the size of their ships, the directors believe that they are also obtaining the elements of a speed hitherto unknown; and if hereafter coals applicable to the purposes of steam can be supplied from the mines of Australia, the carrying capacity of their ships, both for cargo and passengers, will be proportionately increased. The great length of these ships will undoubtedly, according to all present experience, enable them to pass through the water at a velocity of fifteen knots an hour, with a smaller power in proportion to their tonnage than ordinary vessels require to make ten knots. The hulls of the ships will be of iron, and of more than usual strength, whilst the magnitude of their dimensions will afford peculiar facilities for introducing many precautionary measures conducive both to strength and security. The whole of the ship's bottom, and up to six feet above the water line, will be double, and of a cellular construction, so that any external injury will not affect the tightness or the safety of the ship. The upper deck will also be strengthened on the same principle, so that each ship will be a complete beam, similar to the tube of the Britannia Bridge. The vessels will be divided into ten completely separate water-tight compartments; and, as the intermediate spaces are sufficient in such ships, being each sixty feet in length, to afford a con-

venient arrangement of separate saloons and cabins, the bulkheads can be carried completely to the upper deck, giving an efficiency to the system of compartments which has not yet been attainable; and these compartments admit of further subdivision up to the lower deck, which will be from four to eight feet above water. Separate sets of engines, each with several cylinders and separate boilers, will be applied to work the screw, distinct from those working the paddle-wheels, so that in the event of temporary, or even permanent derangement of any one of the engines, or of either the paddle-wheels or of the screw, the other engines and propellers would still be available, and the only result would be a proportionate diminution of speed and consumption of fuel, thus rendering the chances of any serious delay almost infinitely remote. The ship will become, by its construction, a beam of strength sufficient to meet any strain to which it can be subjected, and will consist of so many distinct compartments that no local injury, however serious, can affect its buoyancy to any dangerous extent. The result of the directors' calculations (made on the assumption that the carrying capacity for goods outwards should be occupied at the rate of £4 10s. per ton, being considerably below present freights, and only one-half of the cabin room occupied, at rates for *first* class passengers, £65; *second* class, £35; and *third* class, £25, including provisions, giving to each of the respective classes enlarged accommodation, and assuming that only one-third of the vessel's capacity would be occupied on the homeward voyage,) is that, after making the most ample allowance for working expenses, depreciation, wear and tear, and insurance, a surplus remains equal to forty per cent. per annum upon the capital invested.

“Mr. Charles Geach, M.P., expressed a belief that the working of these vessels would be as efficient and satisfactory as the theory on which they were projected was sound and true.

“On  
was ad

As th  
clippers  
from th  
recollect  
great in  
at that  
were dra

*Arrive*  
The cele  
Seas, Ca  
evening,  
time tha  
She dep  
3 p.m.,  
day, or 1

“The  
Boston, t  
shire, Fly  
ship buil  
tonnage  
vessel bu  
that peri  
measured  
was 48 fe  
and topg  
It will t  
selected a  
tions bei

“The s  
and conce  
of any sh  
are as fo

“On the motion of Mr. Thomas Bisgood, the report was adopted.”

As the days of the old famous sailing passenger clippers have now passed away, the following extract from the same paper, of July 4th, 1853, will revive the recollection of how highly they were praised, and of the great interest taken in them, notwithstanding that even at that date the doings of the Cunard and Collins Line were drawing world-wide attention:—

*Arrival of the Clipper-Ship Sovereign of the Seas.*—The celebrated American clipper-ship **Sovereign of the Seas**, Captain M'Kay, arrived in the Mersey on Saturday evening, from New York, having made the run in a shorter time than ever previously accomplished by a sailing ship. She departed from New York, in tow of a steamer, at 3 p.m., on the 18th ult., and averaged 296 miles per day, or 12·73 knots per hour.

“The **Sovereign of the Seas** was built by Mr. M'Kay, of Boston, the builder of the celebrated clipper-ships **Staffordshire**, **Flying Cloud**, **Flying Fish**, etc., and was named after a ship built at Woolwich Dockyard, in the year 1637. Her tonnage corresponded with the year, and she was the first vessel built with ‘flushe decks,’ and the largest, up to that period, belonging to the English navy. Her keel measured 187 feet 9 inches; her main breadth of beam was 48 feet 4 inches, and she had three decks, a poop, and topgallant forecastle. She was pierced for 126 guns. It will thus be seen that Mr. M'Kay could not have selected a better name for his ship, its historical associations being full of instruction.

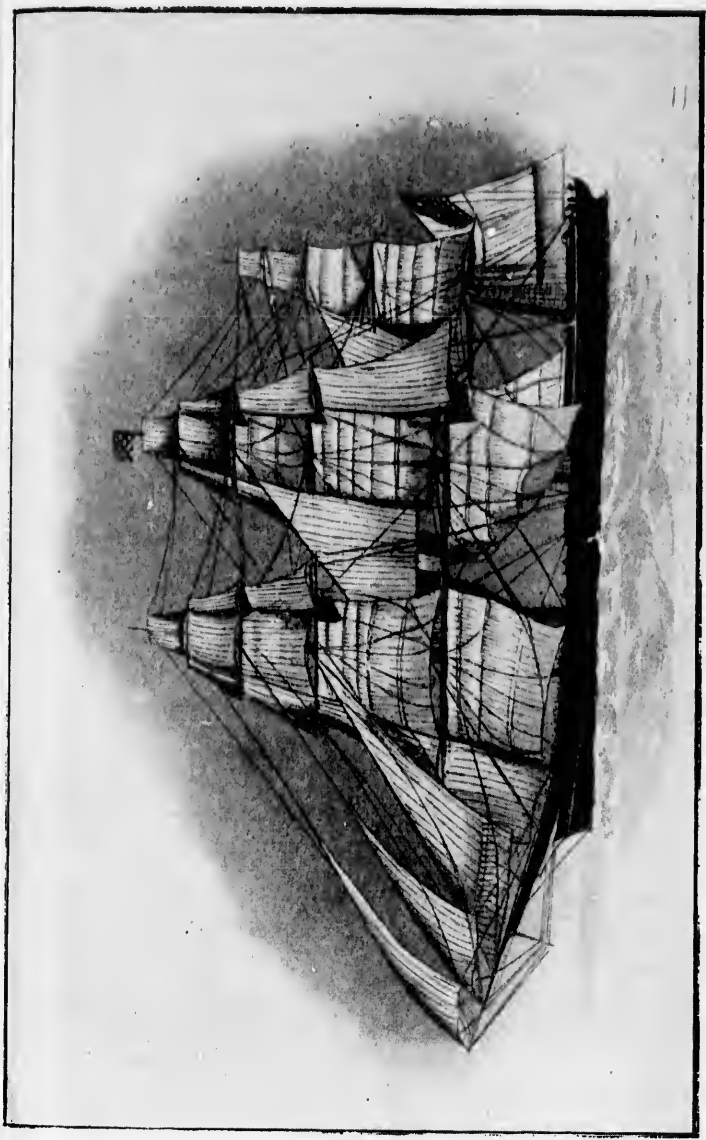
“The **Sovereign of the Seas** has a dead rise of 20 inches, and concave lines, but has the longest and sharpest bows of any ship or ocean steamer afloat. Her dimensions are as follow:—Length between perpendiculars, 258



feet; over all, from the knightheads to the taffrail, 265 feet; extreme breadth of beam, 44 feet, about 20 feet forward of the centre; breadth at the gunwale, 42 feet; depth,  $23\frac{1}{2}$  feet, including 8 feet height of between-decks; deck rise, 20 inches; sheer, nearly 4 feet; and registered tonnage, 2,421 tons. Considering the sharpness of her ends, she has large tonnage capacity for a clipper, great surface and length of floor, and is very buoyant and easy under canvas. She is sheathed with yellow metal up to  $20\frac{1}{2}$  feet forward, and to  $21\frac{1}{2}$  feet aft. Her bulwarks are 5 feet 2 inches high, surmounted by a monkey rail of 18 inches, and the space between the main and rack rails is filled in with a heavy clamp, bolted both ways. All her accommodations are on deck. She has a full topgallant forecastle, a large house amidships, and a spacious trunk cabin, in two divisions, built into a half-poop deck, with steerage-room abaft. Her construction, for solidity and strength, is of the highest order; her frame is entirely of seasoned white oak, and all her planking and ceiling, as well as her deck frames and lower deck, are of the best of hard pine, and she is copper fastened, square bolted, and trenailed through. In her hold all her knees are of oak, and all her hooks throughout; in the between-decks, the knees are all constructed of hackmatack. She is 11 feet 8 inches through the backbone, including the moulding of the floor-timbers, which is 19 inches. And all her keel and kelson fastenings are of  $1\frac{1}{2}$  copper and iron bolts, driven in the strongest style, and rivetted. Her keel is sided 16 inches; and, besides the midship kelsons, she has double sister-keelsons, one over the other, on each side, which combined side 15 inches, and mould 30. She has, moreover, the stoutest and most beautifully proportioned set of spars that ever towered above a ship's deck, which spread about 12,000 yards of canvas. All her lower masts are 'made' from the head to the step, each mast in five pieces, bolted and hooped together. Her bowsprit is also a 'made' spar, all the



taffrail,  
 about 20  
 wale, 42  
 between-  
 eet; and  
 e sharp-  
 acity for  
 and is  
 sheathed  
 l to 21½  
 gh, sur-  
 he space  
 a with a  
 mmoda-  
 recastle,  
 cabin, in  
 steerage-  
 strength,  
 seasoned  
 s well as  
 of hard  
 ted, and  
 e of oak,  
 ecks, the  
 is 11 feet  
 moulding  
 all her  
 and iron  
 ed. Her  
 kelsons,  
 , on each  
 ould 30.  
 autifully  
 above a  
 f canvas.  
 head to  
 d hooped  
 , all the



SOVEREIGN OF THE SEAS.  
 Wooden Atlantic Clipper Ship, 1853.

outside pieces being of hard pine. Her masts rake, commencing with the fore 3-8ths, 4-8ths, and 1 inch respectively to the foot. Her foremast is 41 inches in diameter, 89 $\frac{3}{4}$  feet long; topmast, 19 inches diameter, 50 feet long; topgallantmast, 14 inches diameter, 27 $\frac{1}{2}$  feet long; royal, 11 $\frac{1}{2}$  inches diameter, 18 feet long. Mainmast, 44 inches diameter, 92 $\frac{3}{4}$  feet long; topmast, 19 $\frac{1}{2}$  inches diameter, 54 feet long; topgallantmast, 14 $\frac{3}{4}$  inches diameter, 30 feet long; royal, 12 inches diameter, 20 feet long; and skysailyard, 10 inches diameter, 14 feet long. Mizzenmast, 34 inches diameter, 82 $\frac{3}{4}$  feet long; topmast, 16 inches diameter, 43 feet long; topgallantmast, 11 inches diameter, 24 feet long; and royal, 9 $\frac{1}{2}$  inches in diameter, and 17 feet long.

About the date of the foregoing account the system of carrying emigrants on these clippers was beginning to attract public attention, owing to the sufferings entailed through overcrowding, inattention and the like, and the following extract from the "New York Herald," of October 26th, 1853, on the condition of the emigrants in those days, will serve to show how serious was the mortality brought about by the then existing state of things, which compare very unfavourably with the steamship services of to-day, when a death is an event of such a rare occurrence as to be noted in the daily papers, notwithstanding that over a thousand a trip are frequently carried by the numerous steamers in the trade.

"Among the arrivals at this port of emigrant ships during the past few weeks, a very large number of deaths have been reported. In one vessel, the **Charles Sprague**, the unusually large number of forty-five persons died on the passage from Bremen; and in another, the **Win-**

**chester**, amount to the number to the p

Arrived  
1853.

Sept. 9  
" 11  
" 15  
" 21  
" 26  
" 27  
" 29  
" 29  
" 30  
" 30  
Oct. 11  
" 12  
" 14  
" 14  
" 17  
" 17  
" 19  
" 20  
" 20  
" 20  
" 21  
" 21

" Alth  
exceptio  
having d  
carried  
making  
Several,  
that ch  
named v  
thirty-th

chester, from Liverpool, the number of fatal cases amounted to no less than seventy-nine. The following is the number of cases at this port<sup>1</sup> from September 9th up to the present time:—

Arrived 1853.	Ships.	Where from.	No. of Passengers.	Deaths.
Sept. 9	Zurich ... ..	Havre	358	2
" 11	Lucy Thompson ... ..	Liverpool	800	35
" 15	Niagara ... ..	"	249	38
" 21	Charles Sprague ... ..	Bremen	280	45
" 26	Oder ... ..	Hamburg	237	14
" 27	Winchester ... ..	Liverpool	463	79
" 29	Kate Hunter ... ..	"	342	1
" 29	Rhine ... ..	Havre	566	24
" 30	Talleyrand ... ..	Hamburg	210	11
" 30	Louisiana ... ..	"	142	3
Oct. 11	Harvest Queen ... ..	Havre	367	5
" 12	Copernicus ... ..	Hamburg	152	19
" 14	Orphan ... ..	Bremen	280	4
" 14	Marmion ... ..	Liverpool	295	34
" 17	Waterloo ... ..	"	294	4
" 17	James Wright ... ..	"	430	1
" 19	Statira Morse ... ..	Glasgow	201	2
" 20	Sir Robert Peel ... ..	London	407	6
" 20	Cordelia ... ..	Bremen	339	3
" 20	London ... ..	Havre	229	2
" 21	New York ... ..	Liverpool	400	16
" 21	Benjamin Adams ... ..	"	620	15
			7,701	363

“Although the captains, in their reports, with one exception, merely mentioned the fact of such a number having died, it is pretty certain that the disease which carried them off was cholera, that fatal malady which is making such havoc among the shipping in Europe. Several, no doubt, died by the common diseases, but that cholera was raging on board many of the above-named vessels is beyond all question, from the fact that thirty-three persons who were landed at quarantine were

<sup>1</sup> New York.

suffering from that epidemic. The sickness on the **Benjamin Adams** was decidedly cholera; and, in addition, the ship **Sagadahock**, from Gottenburg, which arrived at Boston on the 24th ult., reports the loss of seventy passengers by the same disease. In reference to this matter, a committee of the American Medical Association has drawn up a memorial to Congress, urging the necessity of compelling all emigrant-vessels to carry a surgeon."

At this time when the steamships were beginning to take emigrant or steerage passengers, a very extensive trade was carried on by the famous American sailing clippers, the extent of which may be judged from the advertisements of the different lines and vessels sailing from Liverpool about that date, taken from the Liverpool "Albion," of July 17th, 1854.

Until furth  
and to N  
Until furth  
and after  
instead o  
Freight on  
PARCELS  
Packages  
purpose  
America

The BOSTO

Arabia ...  
Persia ...  
Asia ...  
Canada

Canada  
Arabia  
America  
Europa  
Niagara  
Africa

Europa  
America  
Asia ...  
Niagara  
Africa  
Canada

The Passe  
Jersey City,

the Ben-  
tion. the  
rived at  
seventy  
to this  
Associa-  
ging the  
carry a

Until further Notice, the Rate of Freight to Boston will be £4 per Ton, and to New York £6 per Ton.

Until further Notice, CARGO for the STEAMERS will be received on and after Nine o'clock, Morning, of SATURDAYS PREVIOUS TO SAILING, instead of on Mondays, as heretofore.

Freight on Parcels, 5s. each, and upwards, according to size.

PARCELS for different Consignees collected and made up in Single Packages, addressed to one Party for delivery in America, for the purpose of evading payment of Freight, will, upon examination in America by the Customs, be charged with the proper Freight.

BRITISH AND NORTH AMERICAN ROYAL MAIL STEAMSHIPS,<sup>1</sup>

APPOINTED BY THE ADMIRALTY

TO SAIL BETWEEN

LIVERPOOL AND NEW YORK (DIRECT),

AND BETWEEN

LIVERPOOL AND BOSTON,

The BOSTON Ships only CALLING at HALIFAX to land and receive Passengers and Her Majesty's Mails.

Captain.

Arabia ... ..	C. H. E. JUDKINS.	Africa ... ..	Wm. HARRISON.
Persia ... ..	ALEX. RYRIE.	America ... ..	W. J. C. LANG.
Asia ... ..	EDWD. G. LOTT.	Niagara ... ..	JOHN LEITCH.
Canada ... ..	JAMES STONE.	Europa ... ..	NEIL SHANNON.
	Cambria ... ..		Captain W. DOUGLAS.

The under-noted or other Vessels are appointed to Sail

From LIVERPOOL:

1854.

Canada ... ..	For BOSTON ... ..	Saturday, the 22nd July.
Arabia ... ..	For NEW YORK ... ..	Saturday, the 29th July.
America ... ..	For BOSTON ... ..	Saturday, the 5th Aug.
Europa ... ..	For NEW YORK ... ..	Saturday, the 12th Aug.
Niagara ... ..	For BOSTON ... ..	Saturday, the 19th Aug.
Africa ... ..	For NEW YORK ... ..	Saturday, the 26th Aug.

From AMERICA:

Europa ... ..	From NEW YORK ... ..	Wednesday, 12th July.
America ... ..	From BOSTON ... ..	Wednesday, 19th July.
Asia ... ..	From NEW YORK ... ..	Wednesday, 26th July.
Niagara ... ..	From BOSTON ... ..	Wednesday, 2nd Aug.
Africa ... ..	From NEW YORK ... ..	Wednesday, 9th Aug.
Canada ... ..	From BOSTON ... ..	Wednesday, 16th Aug.

The Passengers and Goods for New York are intended to be landed at Jersey City, within the jurisdiction of the Custom-house of New York.

<sup>1</sup> Now the Cunard Line.

eginning  
y exten-  
merican  
red from  
vessels  
from the

CHIEF-CABIN PASSAGE to HALIFAX and BOSTON, £25.

SECOND-CABIN PASSAGE, £15.

CHIEF-CABIN PASSAGE to NEW YORK, £30.

SECOND-CABIN PASSAGE, £20. *These Rates include Steward's Fee and Provisions, but without Wines or Liquors, which can be obtained on Board.*

*Dogs charged £5 each.*

These Steamships have accommodation for a limited number of Second-Cabin Passengers.

Apply, in Halifax, to SAMUEL CUNARD; in Boston, to S. S. LEWIS; in New York, to EDWARD CUNARD; in Havre and Paris, to DONALD CURRIE; in London, to J. B. FOORD, 52, Old Broad Street; in Glasgow, to G. and J. BURNS; and in Liverpool, to

D. and C. MAC IVER, 14, Water Street.

NOTE.—All LETTERS and NEWSPAPERS intended to be sent by these Vessels must pass through the POST OFFICE, and none will be received at the Agents' Offices.

The Owners of these Ships will not be accountable for Gold, Silver, Bullion, Specie, Jewellery, Precious Stones, or Metals, unless Bills of Lading are signed therefor, and the value thereof therein expressed.

Passengers will be charged Freight on their personal Luggage when it exceeds Half-a-Ton Measurement.

To prevent disappointment or difficulty, Passengers are respectfully informed that Packages of Merchandise will not be allowed to be shipped as Luggage, or with their Luggage.

Passengers are not permitted to go on Board by the Steamer that takes the Mail.

Parcels will be received at the Office of the Agents *here* until Six o'clock on the FRIDAY EVENINGS previous to Sailing.

The Canada, for HALIFAX and BOSTON, will start on SATURDAY next, the 22nd instant.<sup>1</sup> The Steam-tender Satellite will leave the Landing-Stage, opposite the Baths, George's Pier, at Eight o'clock, *morning*, of that day, with the Passengers for the Canada.

CARGO for the Alps is now being received at the Hnskisson Dock, according to priority of arrival.

STEAM TO NEW YORK AND (via JAMAICA) TO CHAGRES.

The undernoted or other first class Screw Steamships will sail

FROM LIVERPOOL FOR NEW YORK,

Once a Month until further notice, the extended service being Twice a Month, when the Ships now building are completed :

Andes ... ..	Capt. MOODIE.	Jura ... ..	Capt. DOUGLAS.
Alps ... ..	Capt. WICKMAN.	Ætna... ..	Capt. LITTLE.

<sup>1</sup> July, 1854.

Alp

Passage  
booked, £18  
or Liquors,

Freight  
Goods by A  
\$4.80 to the

Apply in  
New York  
in London  
and JAMES

As soon  
PORTLAN

The Rate o  
ment, unt

Freight m

Names of  
all Goods

exceed 20

The Rate of  
of the la

Extra Pr

These Steu  
Second C  
charged 5

UNITE

The Steam

Atlantic ...  
Pacific ...

These Ve

At

Ba

Ar

At

Ba

And every a

FOR BOSTON AND NEW YORK.

Alps ... .. WEDNESDAY next, 19th July.

Passage Money to Boston, beyond which Port Passengers cannot be booked, £18, including Provisions and Steward's Fees, but without Wines or Liquors, which can be obtained on board.

Freight on Fine Goods to America, £3 per Ton Measurement; other Goods by Agreement. Freight will be collected in America at the rate of \$4.80 to the Pound Sterling.

Apply in Halifax to SAMUEL CUNARD; in Boston to S. S. LEWIS; in New York to EDWARD CUNARD; in Havre and Paris to DONALD CURRIE; in London to J. B. FOORD, 52, Old Broad Street; in Glasgow to GEORGE and JAMES BURNS; or in Liverpool to

D. and C. MAC IVER, 14, Water Street.

As soon as Goods are going for Canada, and any quantity offer for PORTLAND, these Vessels will call there.

The Rate of Freight by these Steamers is £6 Sterling per Ton Measurement, until further notice.

Freight must be paid in advance on Goods consigned to order, unless the Names of the Consignees are given at the time of Shipment, and upon all Goods when the amount included in one Bill of Lading does not exceed £6 Sterling.

*The Rate of CHIEF CABIN PASSAGE by these Steamers is £30, reserving Four of the largest State Rooms in the Pacific for Families, for which an Extra Price will be charged.*

These Steamers have superior accommodation for a limited number of Second Cabin Passengers, at £20 each, including Provisions. All Parcels charged 5s. and upwards, according to size.

UNITED STATES MAIL STEAMERS BETWEEN

LIVERPOOL AND NEW YORK.<sup>1</sup>

The Steamships comprising this Line are the

Atlantic ... ..	Capt. WEST.	Arctic ... ..	Capt. LUCE.
Pacific ... ..	Capt. NYE.	Baltic ... ..	Capt. COMSTOCK.

These Vessels are appointed to sail as follows:

From LIVERPOOL:

Atlantic ... ..	Wednesday, 26th July.
Baltic ... ..	Wednesday, 9th Aug.
Arctic ... ..	Wednesday, 23rd Aug.
Atlantic ... ..	Wednesday, 6th Sept.
Baltic ... ..	Wednesday, 20th Sept.

And every alternate Wednesday.

<sup>1</sup> Collins Line, now extinct.

## From NEW YORK.

Atlantic	... ..	Saturday, 8th July.
Baltic	... ..	Saturday, 22nd July.
Arctic	... ..	Saturday, 5th Aug.
Atlantic	... ..	Saturday, 19th Aug.
Baltic	... ..	Saturday, 2nd Sept.

And every alternate Saturday.

N.B.—No Goods for the Atlantic can be taken after Two o'clock p.m. on Tuesday, the 25th instant, nor can Parcels be received after Six o'clock in the evening of that day.

Freight on Goods, payable at New York, is charged at the rate of Four Dollars and Eighty Cents to the Pound Sterling.

Dogs, £5 each.

An experienced Surgeon is attached to each Ship.

The Owners of these Ships will not be accountable for Gold, Silver, Bullion, Specie, Jewellery, Precious Stones, or Metals, unless Bills of Lading are signed therefor, and the value thereof therein expressed.

\* \* \* *No Berth secured until the Passage Money is paid.*

Steamships ply regularly between New York and Charleston, Savannah, Havana, Jamaica, New Orleans, and Chagres. Goods destined to any of these Ports, and addressed to E. K. COLLINS and Co., New York, by the above Steamers, will be forwarded with despatch and economy.

The Steam-tug Company's boat **Samson** will leave the Landing-Stage, George's Pierhead, at Ten o'clock, a.m., on Wednesday the 26th instant, with the Passengers for the Atlantic.

Passengers will be charged Freight on their personal Luggage when it exceeds Half-a-Ton Measurement.

For Freight or Passage apply to Messrs. E. K. COLLINS and Co., New York; JOHN MUNROE and Co., 26, Rue Notre Dame des Victoires, Paris; G. H. DRAPER, 79, Rue d'Orleans, Havre; STEPHEN KENSARD and Co., 27, Austin Friars, London; or to

BROWN, SHIPLEY AND CO., Liverpool.

## TAPSCOTT'S AMERICAN PACKET OFFICES.

GENERAL OFFICE: OLDHALL, OLDHALL STREET.

PASSENGER OFFICE: ST. GEORGE'S BUILDINGS, REGENT ROAD.

The following First-Class Packets will be despatched on their appointed days, as under:

## For NEW YORK.

	Tons.	To sail.
Manhattan, PEABODY ... ..	2500 ... ..	This day.
Centurion, COOMBS ... ..	2000 ... ..	25th July.
Chimborazo, GILCHRIST ... ..	1800 ... ..	30th July.
Constellation, ALLEN ... ..	3500 ... ..	—
Houghton, COTTER ... ..	1800 ... ..	—
E Z, HARTSHORNE ... ..	1800 ... ..	—

Fores  
Coos  
North  
A Z,  
West  
Andre  
Sham  
Prog  
Conti  
Empi  
Phila  
Heli  
Kossu  
Drea  
Adria  
Albio  
Emer  
Antar  
Edwa  
Benja  
Willia

And succee

Carna

Saran  
Wyon  
Tusca  
Tonav

The abov  
experience,  
comfort of

Private I  
at all times  
remitted, w

Surgeons  
Persons p  
actual outla  
on arrival a  
many anno

Drafts an  
any part of  
prefer this  
ticulars app

W. TAL

Ag

✂ TAPS  
remitting S



	Tons.	To sail.
Forest King, ALLEN ... ..	2000	—
Coosawattee (new), J. PAXTON ...	2000	—
Northampton, REED ... ..	2500	—
A Z, CHANDLER ... ..	1800	—
West Point, MULLINER ... ..	2000	—
Andrew Foster, HOLLERTON ...	2000	—
Shamrock (new), DOANE ... ..	3000	—
Progress, CHASE ... ..	3000	—
Continent, E. B. DRUMMOND ...	2000	—
Empire (new), ZEREGA ... ..	2000	—
Philanthropist, WILSON ... ..	1800	—
Helios, NASON ... ..	2000	—
Kossuth, DAWSON ... ..	2550	—
Dreadnought (new), SAMUELS ...	2500	—
Adriatic, JACK... ..	1500	—
Albion (new), WILLIAMS ... ..	2000	—
Emerald Isle, CORNISH ... ..	2000	—
Antarctic, STOUFER ... ..	2500	—
Edward Stanley, ROBINSON... ..	2500	—
Benjamin Adams, DRUMMOND ...	2500	—
William Tapscott (new), BELL ...	3000	—

And succeeding Packets every Five Days.

For BOSTON.

Carnatic, DEVEREAUX ... .. 1500 ... .. 18th July.

For PHILADELPHIA.

Saranak, DECAN ... .. 1000 ... .. 12th Aug.

Wyoming, DUNLEVY ... .. 1100 ... .. 12th Sept.

Tuscarora, TURLEY ... .. 1232 ... .. 12th Oct.

Tonawanda, JULIUS ... .. 1300 ... .. 12th Nov.

The above Ships are of the largest class, and commanded by men of experience, who will take every precaution to promote the health and comfort of the Passengers during the voyage.

Private Rooms for Families, or persons who wish to be more select, can at all times be had, and deposits of £1 each, to secure Berths, should be remitted, which shall have due attention.

Surgeons can have free Cabin Passages by the above Ships.

Persons proceeding to the interior of the United States can know the actual outlay, and make the necessary arrangements here, to be forwarded, on arrival at New York, without one day's delay, and thereby avoid the many annoyances Emigrants are subject to on landing at New York.

Drafts and Exchange for any amount, at sight on New York, payable in any part of the United States, can at all times be furnished to those who prefer this safer mode of taking care of their funds. For further particulars apply, post-paid, to

W. TAPSCOTT AND CO., Liverpool, and 7, Eden Quay, Dublin,

Agents for W. and J. T. TAPSCOTT and Co., New York.

↳ TAPSCOTT'S "EMIGRANT'S GUIDE," Fifth Edition, can be had by remitting Six Postage Stamps.

### "RED CROSS" LINE OF PACKETS.

SAUL, MARTINDALE and Co. dispatch a regular succession of FIRST-CLASS PACKETS to the different Ports of America.

#### For NEW YORK.

	Tons.	To sail.
J. Nesmith, CHASE ... ..	1500	20th July.
Highflyer, WATERMAN ... ..	2000	26th July.
Kate Hooper, JACKSON ... ..	3000	—
Franklin King, BORLAND ... ..	2000	—
Otseonthe, YOUNG ... ..	1800	—
Kate Hunter, BUSCHE ... ..	2000	—
Winfield Scott, M'LELLAN ... ..	3000	—
Eastern Queen, PORTER ... ..	2000	—
C. Nesmith, SALISBURY ... ..	1800	—
Premier, ROSS ... ..	3000	—
Phoenix, HOXIE ... ..	1500	—
St. Patrick, WHITEMAN ... ..	2000	—
Sea Nymph, HARDING... ..	1800	—

#### For PHILADELPHIA.

W. Sprague, CHASE ... ..	2000	20th July.
Cerro Gordo, CHANDLER ... ..	1800	20th Aug.
Nashwauk, M'INTYRE ... ..	2000	—
W. V. Kent, FLITNER... ..	1600	—

#### For BALTIMORE.

A. B. Thompson, MUSTARD ... ..	2000	20th July.
Mary Hale, ROLLINS ... ..	2000	20th Aug.
Annapolis, GRAHAM ... ..	2000	—
Susan E. Howell, RAFFLES ... ..	1500	—

#### For CHARLESTON, S.C.

Amelia, M'KENZIE... ..	2000	20th July.
Muscongus, CARTER ... ..	1200	—
Naomie, JOHNSON ... ..	1500	—
Carnatic, STALKER ... ..	1200	—
Franchise, ROBINSON ... ..	1800	—

#### For QUEBEC.

Hotspur, SMITH ... ..	1800	18th July.
Dauntless, JONES ... ..	2000	To follow.
Harmony, JAMIESON ... ..	1800	—
Crown, CAMPBELL... ..	2300	—
John Davies, JONES ... ..	2000	—
Mary Carson, MILLS ... ..	2000	—

The above Ships are of the largest class, and combine all the most recent Improvements conducive to the health and comfort of Passengers.

Berths in the First, Second, and Third Classes can be secured by remitting a Deposit of £1 for each Person to the Subscribers.

A SURGEON wanted for a Quebec Ship.

For further particulars apply to

SAUL, MARTINDALE AND CO., 36, Waterloo Road.

The very  
Ship High  
Sister-ship  
one year old  
tion, of the  
she is unusu  
For Frei  
apply to

Freight p  
Agent in

### THE

The fine  
Commander  
coppered.  
Apply to  
Goods wil

### LL

Sailing

Siddon  
Rosciu  
J. Rut  
Garric  
Sherid  
New Sh  
New Sh

Goods wi  
These Ships  
York, of the  
for Passenge  
For Freig

Freight w  
Sterling.

**"ST. GEORGE" LINE OF PACKETS FOR  
NEW YORK.**

*Sails on the 20th instant.*

The very superior first-class extraordinary fast-sailing American Clipper-Ship **Highflyer**, Captain G. B. WATERMAN (she is the same model and Sister-ship of the well-known Clipper **Dreadnought**), 1200 tons register; one year old; coppered and copper-fastened; built under particular inspection, of the choicest materials in the United States; and as a conveyance she is unsurpassed by any Ship in the World.

For Freight or Cabin Passage, having very superior Accommodation, apply to

A. TAYLOR AND CO.

Freight payable in New York at \$4.80 to the Pound Sterling.  
Agent in New York, DAVID OGDEN, Esq.

LOADING BERTH, WELLINGTON DOCK.

**THE "BLACK STAR" LINE OF PACKETS.  
LIVERPOOL TO NEW YORK.**

*Packet of the 25th July.*

The fine first-class American Packet-ship **Calhoun**, D. H. TRUEMAN, Commander; 1,749 tons register; New York built; copper-fastened and coppered.

Apply to

C. GRIMSHAW AND CO.

Goods will be received till Midnight of the 24th instant.

**LINE OF PACKETS FOR NEW YORK.**

*Sailing on the 11th of every Month from the Waterloo Dock.*

	Tons.	
Siddons, JOHN S. TAYLOR ... ..	1100	Aug 11th.
Roscius, J. W. PORTER ... ..	1200	Sept. 11th.
J. Rutledge, W. A. SANDS... ..	1250	Oct. 11th.
Garrick, R. W. FOSTER ... ..	1150	Nov. 11th.
Sheridan, S. CLARK ... ..	1100	Dec. 11th.
New Ship, — ... ..	1500	Jan. 11th.
New Ship, — ... ..	1500	Feb. 11th.

Goods will not be received after midnight of the 9th of each month. These Ships are all of the first and largest class, built in the city of New York, of the best materials, combining great speed with unusual comfort for Passengers, and they are commanded by men of experience.

For Freight or Cabin Passage apply to

RICHARD S. ELY, 35, Oldhall Street.

Freight will be collected at the rate of 4 dollars 80 cents to the Pound Sterling.

## THE LIVERPOOL AND PHILADELPHIA STEAMSHIP COMPANY'S<sup>1</sup>

### FAVOURITE IRON SCREW STEAMSHIPS.

City of Manchester ... ..	2125 tons ...	Capt. W. WYLIE.
City of Philadelphia (new) ... ..	2189 tons ...	Capt. R. LEITCH.
City of Baltimore (new) ... ..	2538 tons ...	Capt. R. LEITCH.

Are intended to sail as under:

#### From LIVERPOOL.

City of Philadelphia ... ..	Wednesday, 26th July.
City of Manchester ... ..	Wednesday, 6th Sept.

#### From PHILADELPHIA.

City of Manchester ... ..	Saturday, 22nd July.
City of Philadelphia ... ..	Saturday, 19th Aug
City of Manchester ... ..	Saturday, 30th Sept.

#### RATES OF PASSAGE FROM LIVERPOOL:

Cabin, in Two-berth State Rooms ...	21 guineas each Berth.
" " Three-berth " " ...	17 " "
" " Forward " " ...	15 " "

Including Provisions and Steward's Fee; all having the same privileges and Messing together.

A limited number of Passengers will be taken at 8 guineas, including as much Provisions as required; and these Passengers are hereby informed, that in order to satisfy the requirements of the Government Officers, the date filled into their contract ticket will be in every case the date of the day preceding the fixed day of sailing.

—

These Steamers carry "Phillips's Patent Fire Annihilators."

An experienced Surgeon is attached to each Steamer.

Dogs charged £3 each.

Freight £4 per Ton, and Unmanufactured Goods, &c., will be taken subject to agreement, payable here or in Philadelphia, at \$4 80c. per pound Sterling.

Apply in Philadelphia, to SAMUEL SMITH, 17, Walnut Street; in Belfast, to RICHARDSON BROTHERS and Co.; in Dublin, to CORNELIUS CARLETON; in London, to EDWARDS, SANFORD and Co., for Passengers, and PICKFORD and Co., for Goods; in Paris, to FRED. REDFERN, 8, Rue de la Paix; in Havre, to W. DAVIDSON; in Manchester, to GEO. STONIER; and in Liverpool, to

RICHARDSON BROTHERS AND CO.,  
12 and 13, Tower Buildings.

N.B.—When the arrangements are completed, and sufficient Goods offer, one of the above, or other Steam-vessels, will proceed to Baltimore, calling at Norfolk, Virginia, or other Ports on the Chesapeake, going or returning.

<sup>1</sup> Now Inman and International Line.

The sailing instant. applicat

## SCREW

THE CL  
Clyde, 1  
Petrel, 8  
intended t

F

Clyde ...  
Petrel...

These V

the best of

Rates o

board at

Steward's

Freight

5 per cent.

No Bills

the Comp

Street, and

for the Sh

Apply in

## THE C

Under e

COMPAN

Buildi

STEAM

The Con

Ottawa

Cleopatra

Charity

<sup>1</sup> After

board at

being of

she put i

burnt out

The sailing of the Clyde has unavoidably been postponed till the 26th instant. Intending Shippers and Passengers will please make early application for room.

**SCREW STEAMERS BETWEEN GLASGOW AND NEW YORK.**

THE CLYDE SCREW STEAM-PACKET COMPANY'S Screw Steam-Packets; Clyde, 1,200 tons, 250 horse-power, DAVID HENDERSON, Commander; Petrel, 800 tons, 200 horse-power, R. H. C. TIMS, Commander; are intended to sail as under, namely:

From GLASGOW.

From NEW YORK.

Clyde ... ..	26th July.	Clyde ... ..	15th Aug.
Petrel... ..	15th Aug.	Petrel ... ..	15th Sept.

These Vessels have been fitted up expressly for the Trade, and present the best opportunity for the conveyance of Goods and Passengers.

Rates of Passage, exclusive of Wines and Liquors, which can be had on board at moderate rates:—Cabin, 18 guineas; Steerage, 9 guineas. No Steward's Fee.

Freight, including Clyde Dues, Measurement Goods, 80s. per Ton and 5 per cent. primage. Coarse Goods according to agreement.

No Bills of Lading will be signed excepting those printed expressly for the Company, which can be had at TURNER and ROSE'S, 7, South Castle Street, and one of the number affirmed to (duly stamped) will be retained for the Ship.

Apply in Glasgow to D. A. B. MURRAY, 14, York Street; or to

HALL AND MACKINNON,  
18, South Casile Street, Liverpool.

**THE CANADIAN STEAM NAVIGATION COMPANY.**

*Under Contract with Her Majesty's Provincial Government of Canada.*

COMPANY'S OFFICES: No. 3, Royal Insurance } WILLIAM RUDD,  
Buildings, North John Street. } Secretary.

**STEAM TWICE A MONTH TO QUEBEC AND MONTREAL.**

The Company's first-class powerful Screw Steamships,

Ottawa ...	Capt. J. B. ATKINS.	Erie (new) ... ..	Capt. _____
Cleopatra ...	Capt. H. SALT.	Huron (new) ... ..	Capt. _____
Charity ...	Capt. W. PATON.	Ontario (new) ... ..	Capt. _____
Sarah Sands <sup>1</sup> (chartered) ...		Capt. W. ILSLEY.	

<sup>1</sup> Afterwards famous on account of having had a great fire on board at sea, while engaged as a troopship, when owing to her being of iron all the lives were saved. After the fire was subdued she put into the Mauritius with whole of after end completely burnt out, November, 1857.

The under-noted or other Vessels will be dispatched as follows, from (Birkenhead Dock) Liverpool, for QUEBEC and MONTREAL direct, on the 10th and 25th of each Month, from April to September inclusive; and from Quebec on the 5th and 20th of each Month from May to October inclusive.

When any of these dates fall on a Sunday, the Vessels sail on the Monday following.

Charity ... .. Tuesday ... .. 25th July, 1854. .

Rates of Passage to Quebec: First Cabin, 20 guineas; Second Cabin, 12 guineas, including Provisions, but not Wines or Liquors; Third Class, 6 guineas, including Provisions properly cooked.

Carries a Surgeon.

Freight to Quebec or Montreal: Measurement Goods, 80s. per Ton, and 5 per cent. primage. Course Goods per agreement.

Goods for these Vessels will be received at the Transit Sheds, Birkenhead Dock, and in Liverpool at the Duke's Dock, for conveyance to Birkenhead, at the Shipper's risk and expense.

For Freight or Passage, or further information, apply to

LAMONT AND MLARTY, 21, Water Street, Liverpool.

### ST. JOHN, N.B., AND LIVERPOOL LINE OF PACKETS.

Appointed to sail from *LIVERPOOL* on the 5th and 20th of every month.

Ships.	Captains.	Reg. Ton.	To sail.
John Barbour ... ..	MARSHALL ... ..	997 ...	20th July, 1854.
John Bannerman ... ..	ROBERTSON ... ..	1198 ...	5th Aug.
Joseph Tarratt ... ..	PRITCHARD ... ..	942 ...	20th Aug.
Imperial ... ..	MORAN ... ..	1297 ...	5th Sept.
Liberia ... ..	CRUICKSHANK ... ..	870 ...	20th Sept.
Eudocia ... ..	DOANE ... ..	1015 ...	5th Oct.
Middleton... ..	DELANY ... ..	996 ...	20th Oct.
David G. Fleming... ..	NICHOLS ... ..	1423 ...	5th Nov.

These fine Ships have been specially selected for this Line, are built of the choicest materials in the province, and are clussed and coppered. Their Commanders are men of experience and ability, and Shippers may rely on their being despatched on their respective dates. Bills of Lading, of which two captain's copies are required, will be signed at the Office of the Consignees for the Captain, of which Shippers will please take notice. For Freight or Passage, for which these Vessels have excellent accommodation, apply, in St. John, to Messrs. J. and R. REED; here, to the respective Captains, on Board, Brunswick Dock Basin, or to

FERNIE BROTHERS AND CO.,

Orange Court, Castle Street.

OWING to  
of the  
have fro  
past fift  
bravery,  
tion of t  
be giver  
Charles  
and alth  
vessels v  
speed a  
privation  
ever, an  
years is  
voyage o  
vessels i  
the "Ne  
story he  
"The  
day, whe  
had man  
as of shi  
forward t  
impressio

flows, from direct, on  
sive; and  
to October

Monday

oud Cabin,  
Third Class,

r Ton, and

Birkenhead  
Birkenhead,

iverpool.

E OF

ery month.

To sail.  
July, 1854.

Aug.

Sept.

Oct.

Nov.

re built of  
ed. Their  
ay rely on  
g, of which  
f the Con-  
otice. For  
modation,  
respective

CO.,  
e Street.

## CHAPTER XIV.

### EVENTFUL PASSAGES AND SCENES.

OWING to the excessively wild and tempestuous nature of the North Atlantic Ocean, many exciting passages have from time to time been experienced during the past fifty years, giving opportunity for many acts of bravery, and severely testing the design and construction of the steamers. No more vivid description could be given than the account, already referred to, by Charles Dickens, of the **Britannia's** passage in 1842, and although in those days the staunchness of these vessels was not so tested as in later years when the speed and power increased, there is no doubt the privations of the passengers were greater. That, however, anxious times are occasionally experienced of later years is evident from the following account of the first voyage of the **Republic**, one of the early White Star vessels in 1872, sent by a Philadelphia gentleman to the "New York Nautical Gazette." In the course of his story he says:

"The storm increased until nine o'clock the next day, when we were struck on the port side by a sea. I had many a time talked of being 'struck by a sea' just as of shipping a wave, but from that moment, and henceforward for the remainder of my life, I received a new impression of what this term means. Without such

experience I have thought of water as a yielding element—something that would rise and wash across the ship, but it had never entered my mind that to be struck was like having tons of solid matter hurled against the ship like the ball from a cannon. As I said, we were struck from the port side, amidships, opposite the main saloon; along this side, on the sofas, were seated about one-half the passengers then in the saloon, say eight to ten.

“The plating at this point is about seven-eighths of an inch thick, and the framing some eight inches deep, and, notwithstanding, this side was struck with such force that the passengers were knocked from their seats like cork balls. My friend Mr. Rogers, of Cincinnati, was ‘projected’ over the top of the port dining-table, and under the central one, receiving a severe contusion on his head, and a serious injury in his right leg.

“The dead-lights were forced in, and a flood of water followed the passengers across the saloon. I happened to be on the other side at the time, and seeing that the side was not actually stove in, I went to the assistance of the chief steward, a brave, determined man, and tried with him to secure the dead-lights by putting down the safety shields; we succeeded except in one, where the frame was crushed and bent. The frames are about one inch thick, and one and a half inch wide, with slotted bolt lugs two inches wide, and these lugs were bent like hooks. A strong man could not with a sledge, have struck a blow that would have had the same effect. This was being struck by a sea. As soon as the excitement in a degree abated, I went to the top of the companion-way, and could not, after a warning from the officers, resist the temptation of thrusting my head through the shattered door to see what I could of the effects on the ship. That one glance was enough; the rail was gone, boats were strewed over the deck in splinters, the davits, five inches diameter, were wrenched from their sockets, and swinging over the side. The course had been changed a little, so as to bring the weather on the star-

board s  
even so  
of a nev  
and the  
was de  
Captain  
sailors,  
and retu  
heavy t  
nately,  
Captain  
struck.  
sea wen  
the funn  
dropped  
who este  
and, awa  
minutes  
him dow

“I ha  
never sh

“It w  
explanat  
was liter  
mouth a  
and his r  
over 200  
cast a ne  
cane incr  
and elsev  
gave up  
from the  
of movin  
before it.

“Thro  
slept. T  
water ca  
stewards



board side, or else no one could have ventured to make even so hasty a reconnaissance. While up there I learned of a new horror—that the engine skylights were stove in, and the seas were breaking into the engine-room. It was determined to tarpaulin the engine hatch, and Captain Williams, with some half-a-dozen plucky sailors, went out on the deck. Fixing life-lines for safety and retreat, they made their way forward and secured a heavy tarpaulin, which was dragged back, and, fortunately, was secured over the hatch, and the men, except Captain Williams, safely housed before we were again struck. Just as he had completed his dangerous task a sea went over, catching him, and carrying him against the funnel stay, and then against the funnel itself; he dropped down apparently a lifeless mass, and the men, who esteemed him for his bravery, went to his rescue, and, awaiting their chances between seas for some ten minutes, got him into the companion-way, and carried him downstairs to the main saloon.

“I had never seen such a sight before, and hope I never shall again.

“It was another proof of the force of the sea, a further explanation of the meaning of ‘being struck;’ the man was literally crushed: the blood flowed from his ears, mouth and nostrils, his thigh was broken in two places, and his ribs crushed on one side. A powerful man weighing over 200 lbs., crushed like an insect by the sea! This cast a new gloom over the passengers, while the hurricane increased. The seamen sheltered in the fore-castle and elsewhere: strong men used to storms and dangers, gave up hope. It appeared as if everything was swept from the decks. The wind no longer conveyed an idea of moving air, but of a moving solid, that swept all before it.

“Through that dreadful night that succeeded no one slept. The sea broke over the saloon decks, and the water came down the companion-way in tons; the stewards bailed and attempted to keep it out of the

saloon, but could not. The skylights over the state-rooms were in several places stove in, and in one case a room occupied by two ladies was filled to a depth of several feet. One lady went into hysterics, and required several men to hold her. At seven o'clock in the morning we were again 'struck by a sea' on the port bow. It seemed as if the whole forward part of the ship had been torn away.

"This was the most severe shock of all, and had it, like the former one, been abreast the saloon, the effect would have been more terrible still. This was the last heavy stroke we experienced. The glass went up, and twenty-four hours later we could go on the saloon deck to see the devastation around us. It was terrific. But one boat out of ten was left, and it was stove. The fragments of the others were lodged about the deck, but none so large that a man could handle them.

"The funnel stays were parted, the combing about the funnel was parted from the deck, and nearly the whole of the railing was lost or hanging over the sides; and strangest of all, and to me the greatest evidence of the force of the sea, the mizzen boom of hard pine, twelve inches diameter, was crushed as though it were a reed. Nothing but water could have struck it, and considering the elasticity of the boom and its attachments, with its capacity of resisting transverse strain, it was hard, indeed, to conceive that it was broken by the sea; but we were no longer sceptical."

Later in the 1880 decade many exciting voyages have been experienced, the more notable being one when the forward funnel of the Cunard **Servia** was shattered by a tremendous sea, about thirty feet above the normal water-line. Some time afterwards the White Star **Germanic** was struck by a tidal wave with such violence as to wrench the steam winches from off the decks, and stove

in son  
the su  
strong  
rons.

stout v  
another  
diamo  
and in  
liner K  
build o  
founde  
the en  
house.

lifebou  
hand-r  
injury  
withsta  
procee  
by a h  
full sp

The  
event o  
United  
tract fr  
1856 ;  
mail s  
is donl  
be effe

"Th  
tions o

in some of the strong iron deck-houses, which allowed the saloon to be flooded. Other instances of the terrible strength and power of the great Atlantic waves are numerous. At one time it is the complete crushing of the stout whalebacks which protect the bow and stern; at another the snapping off of davits six and seven inches diameter; at another time the funnel is washed away; and in one remarkable instance, that of the Philadelphia liner **British Queen**, in 1881, nothing but the substantial build of the hull and upper works saved the vessel from foundering, as a tidal wave rolled on board and swept the entire decks fore and aft, clearing the bridge, wheel-house, companion, and captain's house, funnel, eight lifeboats and their davits, some of the winches, and all hand-rails, and causing loss of life to the crew, but no injury whatever to the 700 passengers on board. Notwithstanding all this damage to the upper works, she proceeded on her voyage, and was soon afterwards passed by a high-speed steamer, and reported as steaming at full speed without a funnel, all well.

The position of the Transatlantic mail steamers, in the event of war breaking out between Great Britain and the United States, was defined in 1856 by the following extract from the "Illustrated London News," of June 21st, 1856; but under the existing circumstances, by which mail steamers are armed cruisers of Great Britain, it is doubtful if such a magnanimous agreement would now be effective.

"There are now six mail steam-packet communications every month between England and the United

States. In article 20 of the United States and English Postal Convention, it states that 'in case of war between the two nations the mail packets of the two countries shall continue their navigation without impediment or molestation until six weeks after a notification shall have been made on the part of either of the two Governments, and delivered to the other, that the service is to be discontinued, in which case they shall be permitted to return freely and under special protection to their respective ports.' "

THE MAIL

TURNING

must be

who have

as Judk

Murray,

W. H. T

names in

tain the

Hains, M

Randle, a

piloting

aided by

also com

A.B.'s, a

they are

mount, a

upon to

or wildes

Except

and man

can be f

place rel

various d

English  
between  
countries  
ment or  
all have  
nments,  
to be dis-  
d to re-  
respec-

## CHAPTER XV.

## THE MANNING, EXPENSES, AND COST OF ATLANTIC LINERS.

TURNING to the navigating of an express liner, mention must be made of the commanders, officers, and seamen who have from time to time led the van in the past, such as Judkins, Nye, Lucy, Cook, McMickan, Sir Digby Murray, Kennedy, Grace, Gleadell, Hewitt, Munroe, W. H. Thomson, Hamilton Perry, and others, whose names must be placed with those who at present maintain the same traditions of energy and daring, such as Hains, McKay, Watkins, Land, Parsell, Brooks, Murray, Randle, and others, who now possess the great honour of piloting the twenty-knotters to and fro on the Atlantic, aided by faithful and intelligent officers. Assisting these also come the carpenters, boatswains, quartermasters, A.B.'s, and others, of whom it may be truly said, that they are always ready to cope with, and if possible surmount, any difficulty or ordeal which they may be called upon to meet in the densest fogs, heaviest snow-storms, or wildest weather even of the North Atlantic.

Except by one intimately acquainted with the working and manning of an express liner, only a faint idea can be formed of the great change which has taken place relatively in the number of hands required in the various departments ; the department now requiring the

fewest hands being the sailing, which in former times was of necessity the most extensive.

Nowadays this department numbers, for a twin screw liner, exclusive of the commander, only 46; made up of 5 officers, 2 carpenters, 2 boatswains, 6 lookout men, (specially examined as to colour blindness), 6 quartermasters, 1 storekeeper, 1 lamp-trimmer, 22 seamen (A.B.'s), and 1 mess steward. These are divided into two watches, port and starboard, consisting of 2 officers, 3 lookouts, 3 quartermasters, 1 boatswain, and 11 seamen.

The staff under the chief engineer numbers 160, rated as follows:—1 senior second engineer, 1 second, 2 thirds, 2 fourths, 2 assistant seconds, 2 assistant thirds, 2 assistant fourths, 2 fifths, and 2 sixths. In addition come 2 boiler makers, 2 electricians, 1 refrigerating engineer, 1 winchman, 2 store-keepers, 26 greasers, 6 leading firemen, 60 firemen, and 42 trimmers. In other words, 18 engineers, 2 electricians, 2 boilermakers, 108 stokehole staff, 26 greasers, 1 winchman, and 4 storekeepers.

This immense staff is arranged in three watches of four hours each as follows:—6 engineers, 6 greasers, 20 firemen, 14 trimmers, 1 electrician, and 2 electrician greasers, and has charge of no less than 56 different engines, large and small, inclusive of the two sets of main engines.

In the passenger and victualling departments, a staff averaging about 112 men are engaged under the purser and chief steward, and are rated as follows:—1 second steward, 30 saloon, 12 bedroom, 4 pantrymen, 4 "boots,"

12 second  
4 sculli  
steward  
unlike t  
ing mor  
to be ca

Addin  
namely,  
in the  
are req

vessels,  
for the  
£470 fo  
month.

the oth  
office ex  
works, p  
tion, it  
£16,000

profit c  
enormo  
ment of

When t  
the very  
the chin

time to  
three an  
easily b  
that the  
without

12 second cabin stewards, 18 steerage stewards, 8 cooks, 4 scullions, 5 bakers, 3 butchers, 5 boys, 1 captain's steward, 1 barber, and 4 storekeepers. This number, unlike the other departments, is, however, always varying more or less, according to the number of passengers to be carried.

Adding the totals of the three departments together, namely, 47 in the sailing, 161 in the engine, and 114 in the passenger, the large number of 322 hands, are required, as a rule, in the running of these vessels, whose wages may be taken at, say £300 for the sailing department, £960 for the engine, and £470 for the passengers, making a total of £1,730 per month. When these figures are considered, together with the other heavy expenses of up-keep or maintenance, office expenses, insurance, agency commission, shore staff, works, port charges, interest on capital, and depreciation, it may be fairly taken that, at least, the sum of £16,000 is required to be realized per trip, before any profit can be counted upon; so that some idea of the enormous sums at stake in the working and management of an express Transatlantic line can be realized. When these vast figures are considered, together with the very extensive requirements enumerated elsewhere, the chimerical nature of the schemes proposed from time to time for forming new lines, which promise three and four days' passage across the Atlantic, can easily be discerned; for they are overwhelming proof that the difficulties in the way of any company or firm, without shipping experience, who would create all at once

a service more luxurious, and having higher speed, than that now afforded by the existing lines, which will at the same time prove a financial success, are utterly unsurmountable.

As an instance of how much will be required to obtain even a little improvement, it will be interesting to follow the changes required, as shown by the following estimate, which is based upon moderate improvements in the existing forms of ships and machinery. If we take for example the **Teutonic** and **Majestic** (whose models, as in the case of the earlier **White Star** boats, notably the **Britannic** and **Germanic**, seemed to serve them in good stead), to attain their present speed of 20 knots, requires about 17,000 indicated horse-power each, which means (allowing enough for all the auxiliary engines) a consumption of, in round figures, 300 tons per day of 24 hours, or say 1.6 lbs. per indicated horse-power per hour. Assuming that the consumption may, by advancing improvements, be reduced to 1½ lbs. per hour, and that the size of the machinery be so increased as to admit of a daily consumption of 400 tons per day, which would mean engines powerful enough to indicate 25,980 horse-power, or say, two sets indicating nearly 13,000 each (which is about the average of the **Etruria's** single set at present), then, assuming this will give an average speed of 22 knots per hour, the reduction in the time occupied in making the passage will only be some twelve or thirteen hours, so that the coming vessel, to ensure a five days' passage across the Atlantic, will require to indicate over 26,000 horse-power, and consume about 400 tons of coal

per day  
engine-r

In ad  
will hav

**Teutonic**

£600,00

other ex

earning

obtained



per day, which means a considerable increase in the engine-room staff.

In addition, the more important feature of first cost will have to be considered; for, taking the cost of the *Teutonic* at, say, £460,000, it will be apparent that nearly £600,000 must be invested in one vessel, which, with the other expenses increasing proportionately, means the earning of immense sums before any return can be obtained for the enormous capital at stake.<sup>1</sup>

<sup>1</sup> See Appendix.

## CHAPTER XVI.

### ATLANTIC RECORDS AND TABLES.

WITH a view of illustrating in a brief form the records and doings of the great lines and noted vessels during the last fifty years, the author has designed and worked out the diagram, and compiled and arranged the various tables which are to be found at the end of the book. An examination of the diagram is of great interest, as the dimensions and leading particulars of typical vessels, for the various periods ranging from 1840 to 1890, are each set out to a scale of 100 feet per inch, so that the relative dimensions and performances of each can be seen at a glance and compared with each other. The lines marked T will be found by reference to the table to denote the time occupied on the passage, and by measuring off on the vertical scale on the right hand of the sheet, the number and fraction of days required for the passage of any of the vessels is at once found. With this line, T, should also be compared S, which denotes knots per hour, as it is interesting to observe that as the time, T, on passage gradually decreases from 14 days 8 hours to 5 days 17 hours, the speed per hour gradually increases from  $8\frac{1}{2}$  to 20 knots.

The next important point is the relative sizes of the ships, which are plainly set out by the offsets marked D,

CHAP. XV

denoting  
tons to  
from the  
The disp  
size of a  
the **Grea**  
although  
120 feet  
of 32,16  
vessel.

To tr  
carried i  
line P,  
12 lbs. o  
of **Bruss**  
during t  
the **City**  
commen  
pansion  
gradual i  
1883 and  
and **Teut**  
180 lbs.  
tion of th  
up to the  
press tra  
quadrupl  
how soon  
Togeth  
other im

denoting the load-line displacements to a scale of 3,000 tons to the inch, and which may be readily measured from the tenth scale plotted on the left side of the sheet. The displacement being the factor which denotes the real size of a vessel, it will be seen how vast was the size of the **Great Eastern**, designed nearly forty years ago, for although her length only exceeds that of the **Teutonic** by 120 feet, her displacement reaches the enormous total of 32,160 tons, compared with the 16,740 of the latter vessel.

To trace the gradual rising of the steam-pressure carried in the boilers, it is only necessary to note the line P, which shows the gradual advance from the 12 lbs. of the **Britannia** in 1840, to the 30 lbs. in the **City of Brussels** in 1869, which practically was the range during the period of single expansion engines. After the **City of Brussels**, a great increase to 60 lbs.—the commencing pressure for the compound or double expansion engines—is shown on the **Oceanic**, and again a gradual increase to 110 lbs. on the **Oregon** and **Etruria** in 1883 and 1885. This is succeeded on the **City of Paris** and **Teutonic**, by the still higher pressures of 150 lbs. and 180 lbs. respectively, which have followed on the adoption of the triple expansion engines now in vogue, and are, up to the present, the highest pressures carried in the express trade; but as 210 lbs. is now carried elsewhere for quadruple expansion engines, it is only a question of how soon another advance will be made.

Together with the advancing boiler-pressures, the other important items of indicated horse-power and

consumption, marked H and C, also show interesting changes and results, one of the most marked being the relatively heavy consumption required for the horse-power given out by the large paddle-wheel steamers. This is at once reduced by the screw-propeller, and again by the adoption of the compound engine, and is followed by a still further relative reduction on the introduction of the triple expansion engines.

On comparing the vessels and their performances by the offsets, the excellent results given by the high-speed **America** stand out most prominently, the S and T points being equal to any, whereas all the others are considerably lower; but at the same time it must be noted that commercially she was but an indifferent success.

From a study of this diagram it is interesting to form a brief synopsis of the leading features, as for instance:

The longest vessel now existing is the **Teutonic**.

The one having greatest displacement is the **City of Paris**.

The greatest displacement yet reached was 32,160 tons on the **Great Eastern**.

The greatest power indicated by paddle engines was 5,000 on the **Great Eastern**.

The greatest power indicated by paddle engines on regular Transatlantic lines was 4,000 on the **Scotia**.

The greatest power indicated by single screw engines was 14,000 on the **Etruria**.

The greatest power indicated by twin-screw engines was 18,500 on the **City of Paris**.

The highest consumption per day attained by paddle boat was 160 tons on the **Scotia**.

The highest consumption per day attained by screw boat was 320 tons on the **Etruria**.

The highest average speed attained by paddle-boat was 14 knots by the **Scotia**.

The highest average speed attained by screw boat was 20.35 knots by the **Teutonic**.

The lowest steam-pressure carried in boilers was 12 lbs. on the **Britannia**.

The highest steam pressure carried in boilers is 180 lbs. on the **Teutonic**.

Fastest outward passage, Queenstown to Sandy Hook (New York), 5 days, 16 hours, 31 minutes by the **Teutonic**.

Fastest homeward passage, Sandy Hook to Roche's Point (Queenstown), 5 days, 22 hours, 50 minutes by the **City of Paris**.<sup>1</sup>

In addition to the diagram, the various tables, which will be found at the end, also serve to show the great advances made, thus :

Table No. 1 gives the various dimensions of the more famous vessels, together with a brief description of the engines, and practically calls for no comment; but Tables Nos. 2 and 3, which give the rapid passages both out and home, will be found interesting, as showing the vessels' dates, and when the passages to and fro on the Atlantic were reduced respectively to nine, eight, seven, and six days. With a view of making a comparison,

<sup>1</sup> This has since been reduced by the **Teutonic** in October, 1891, to 5 days, 21 hours, 3 minutes.

the following account of the doings of the various sailing ship lines in 1840, taken from the "Liverpool Mercury" of June 26th in that year will be of interest.

*Extract from "Liverpool Mercury," June 26th, 1840.*

PASSAGES OF SAILING VESSELS.

Name of Line.	TO ENGLAND.			TO NEW YORK.		
	No. of Voyages.	Time on Passage.	Fastest Passage.	No. of Voyages.	Time on Passage.	Fastest Passage.
Old Black Ball Line	23	22½ days	18 days	23	33½ days	22 days
Dramatic Line <sup>1</sup> . .	11	20½ "	17 "	12	33½ "	23 "
Star Line . . . .	11	24 "	21 "	11	39 "	27 "
Swallow Tail Line .	11	22½ "	17 "	11	35 "	28 "

STEAMERS.

Great Western . .	13½ days	12½ days	16½ days	13 days
Liverpool <sup>2</sup> . . . .	15½ "	13½ "	17½ "	16 "

From this it will be seen the best average passages outward to New York were 33½ days by the Dramatic Line clippers, the fastest passage being 22 days, made by the old Black Ball Line.

For the homeward trip, the best average passages were those of the Dramatic Line, being 20½ days, the fastest passage being made by their vessels and also those of the Swallow Tail Line in 17 days. The time occupied by the only two regular steamers, the **Great Western** and **Liverpool**, is also of interest, as showing the speeds then attained, and which may be continued down to the pre-

<sup>1</sup> See life of E. K. Collins, p. 208.

<sup>2</sup> The **Liverpool** had eighteen hours farther steaming than the **Great Western**.

sent day by reference to the Tables Nos. 4 and 5, which show the average passages made by the various steam lines since 1850. The next table, No. 6, the author has compiled from reliable sources for the purpose of showing the average passages which may be expected to prevail in the Express Transatlantic Service before many years have passed, as there is no doubt each of the great lines will sooner or later be compelled to increase the number of their high-speed vessels from two to at least four. By the table it will be seen that the averages for the two fastest vessels of each line have been for the year 1891 as follows :

	Outward.			Homeward.		
	d.	h.	m.	d.	h.	m.
Cunard Umbria and Etruria . . .	6	11	50	6	10	20
Inman City of New York and City of Paris . . . . .	6	6	4	6	8	24
White Star Teutonic and Majestic .	6	2	30	6	3	50

which practically ensures a future regular average passage outward and homeward of a little over 6 days. Taking the distance generally travelled between Queens-town and Sandy Hook as averaging about 2,800 knots outward, and 2,840 homeward, these results indicate a mean average speed of  $18\frac{3}{4}$  knots outward, and 19 knots homeward, which is but little below the maximum speed attained.

Up to the present time the greatest distance run in one day of  $24\frac{3}{4}$  hours has been 517 knots, equal to  $595\frac{1}{4}$  miles, which was achieved by the White Star liner Teutonic in the month of August, 1891, on an outward passage. This gives a rate of 21 knots, or 24 statute

miles per hour, and as it is more than probable that this excellent result may at any time be repeated for some days in succession, it is not beyond the bounds of probability that one of the existing vessels may make the passage in about  $5\frac{1}{2}$  days; which practically means leaving Liverpool on the Saturday of one week and landing in New York about the same hour on the following Friday.<sup>1</sup>

The last table, No. 7, which remains to be commented upon, contains in brief a record of the various steamships which have succumbed to the perils of the deep, and, in some instances, left sad memories of friends and relations swallowed up by the great sea, and in others of deeds of indomitable courage and daring (such as the rescue of every life from off the **Danmark**), greater and more heroic than any which have ever earned the distinction of the Victoria Cross amid the clash of arms, because they have been effected under more thrilling circumstances, and in a higher and nobler cause.

Out of the 122 vessels lost, it will be noticed 62 caused loss of life either directly or indirectly, and it is a matter of great congratulation to notice that not a single life has up to the present been lost by any casualty to the great express liners, a fact which must be largely attributed to the effective bulkhead division now in vogue, as illustrated by the **Oregon** disaster and the **City of Paris** breakdown.

<sup>1</sup> Since this was written the **Majestic** of the White Star Line has in February, 1892, on an outward passage, maintained an average speed of 20.4 knots per hour all the way across.



Of the other vessels, it will be noticed that 24 were never heard of after leaving port, so that no definite reason can be assigned for their loss; the first to figure under this heading being the unfortunate **President** in 1841.

Of the others, 53 were wrecked, 15 foundered, 9 were burned, 5 sunk by ice, and 16 sunk by collision, which last has so far been the only one in this unfortunate category of maritime dangers to claim as a victim one of the swift ships of the great express trade.

In concluding this description and retrospect of the past fifty years of the working and management of the great North Atlantic lines of steamships, it will not be out of place to take a look into the future and see what may yet be in store for posterity, as it would be idle to deny that there is any finality in such matters; and so long as the travelling public demand and will pay for yet higher degrees of comfort and speed, new vessels will be brought forward, possessing still further improvements, as every effort which skill and science can command will be put forward, by the great shipbuilding firms, to produce something in advance of their preceding achievements. What the nature of the advances will be it is difficult to surmise, as of course every step forward reduces the field for further improvements and extension; and although it is quite possible to reduce the time now occupied by merely increasing the power of the machinery, and of necessity the present enormous daily consumption of coal, it is plainly evident that the speeds now attained by the "Fleet Messengers of the Mersey" are fast

reaching the same condition as the speeds of the express trains, which have been for many years past at a standstill, the maximum speed of to-day on the railways being but little, if any, more than that attained many years ago.

But that gradual advances will be made in the near future there is no doubt, and so long as the desire to shorten the duration of ocean voyages, and competition exists, shipowners, engineers, and builders will be prepared to advance beyond anything yet achieved, if even moderate financial success can be counted upon and the premier position maintained.

AP. XVI.

express  
stand-  
being  
7 years

e near  
sire to  
petition  
e pre-  
f even  
nd the

TABLES  
AND  
APPENDICES.

TABLE No. 1.

DIMENSIONS, ETC., OF FAMOUS ATLANTIC STEAMERS.

Name of Ship.	Owners.	Where built.	Year.	Length.		Breadth.		Depth.		Tonnage.	Displacement.	Cylinders.		Stroke.	Pressure.	Indicated power.	Speed per hour.	No. of boilers.	Funnaces.	Type of engine, how propelled.
				Over.	Under.	ft.	ft.	ft.	ft.			ft.in.	lbs.							
Britannia . . .	Cunard Line.	Greenock	1840	250	207	34.5	22.5	22.5	8 1/2	1150	2050	2 of 72 1/2	6 10	12	740	8 1/2	4	12	Side-lever, paddles.	
Great Britain . . .	G. Western "	Bristol	1843	324	275	48.2	31.5	32.7	11 1/2	3270	5780	4 of 80	6 0	25	1500	11	6	24	Geared with chain, screw.	
Asia . . . . .	Cunard "	Greenock	1850	290	208	45	24	22.7	11 1/2	2227	5020	2 of 96	10 0	15	2000	11 1/2	4	20	Side-lever, paddles.	
Arctic . . . . .	Collins "	New York	1850	360	282	45	31.5	28.60	11 1/2	2860	6200	2 of 95	10 0	17	2000	11 1/2	4	32	Do.	
Persia . . . . .	Cunard "	Glasgow	1855	398	376	45	31	33.00	12 1/2	3300	8600	2 of 100	12 0	20	3400	12 1/2	8	40	Do.	
Great Eastern	G. E. S. S. Co.	Millwall, London	1858	691	680	82.8	48.2	18.915	13	18915	32160	4 of 74	14 0	25	5000	13	4	40	Oscill. paddle.	
Scotia . . . . .	Cunard Line.	Glasgow	1862	400	379	47.8	30.5	33.71	13 1/2	3371	8755	2 of 100	12 0	25	4000	13 1/2	6	60	Direct - acting horizontal, screw.	
City of Paris . . .	Inman "	Do.	1866	369	346	40.4	26.2	26.51	14	2651	6411	2 of 89	3 6	30	2600	14	8	24	Side-lever, paddles.	
City of Brussels	Inman "	Do.	1869	415	390	40.3	27.1	30.81	14 1/2	3081	6900	2 of 90	4 6	30	3000	14 1/2	8	24	Direct - acting horizontal trunk, screw.	
Oceanic . . . . .	White Star "	Belfast	1871	432	420	40.9	31	37.07	14 1/2	3707	7240	2 of 41	5 0	65	3000	14 1/2	10	20	Do.	
Britannic . . . . .	White Star "	Do.	1874	468	455	45.2	33.7	50.04	16	5004	9600	2 of 48	5 0	75	5100	16	8	32	Compound trunk - acting, screw.	
City of Berlin . . .	Inman "	Greenock	1875	520	489	44	35	54.91	16	5491	10100	1 of 72	5 6	75	5200	16	12	36	Compound, 3-crank compound, screw.	
Arizona . . . . .	Guion "	Glasgow	1879	573	450	45.4	35.7	51.47	16 1/2	5147	9300	1 of 62	5 6	90	6300	16 1/2	7	39	Do.	
Servia . . . . .	Cunard "	Do.	1881	540	515	52	37.9	85.00	16 1/2	8500	12300	1 of 72	6 6	90	10000	16 1/2	7	39	Do.	

Name of Ship.	Owners.	Where built.	Year.	Length.	Breadth.	Depth.	Tonnage.	Displacement.	Cylinders.	Stroke.	Pressure.	Indicated power.	Speed per hour.	No. of boilers.	Funnaces.	Type of engine, how propelled.
Britannia . . .	Cunard Line.	Greenock	1840	250	207	22.5	1150	2050	2 of 72 1/2	6 10	12	740	8 1/2	4	12	Side-lever, paddles.
Great Britain . . .	G. Western "	Bristol	1843	324	275	31.5	3270	5780	4 of 80	6 0	25	1500	11 1/2	6	24	Geared with chain, screw.
Asia . . . . .	Cunard "	Greenock	1850	290	208	24	2227	5020	2 of 96	10 0	15	2000	11 1/2	4	20	Side-lever, paddles.
Arctic . . . . .	Collins "	New York	1850	360	282	31.5	2860	6200	2 of 95	10 0	17	2000	11 1/2	4	32	Do.
Persia . . . . .	Cunard "	Glasgow	1855	398	376	31	3300	8600	2 of 100	12 0	20	3400	12 1/2	8	40	Do.
Great Eastern	G. E. S. S. Co.	Millwall, London	1858	691	680	48.2	18915	32160	4 of 74	14 0	25	5000	13	4	40	Oscill. paddle.
Scotia . . . . .	Cunard Line.	Glasgow	1862	400	379	30.5	3371	8755	2 of 100	12 0	25	4000	13 1/2	6	60	Direct - acting horizontal, screw.
City of Paris . . .	Inman "	Do.	1866	369	346	40.4	2651	6411	2 of 89	3 6	30	2600	14	8	24	Side-lever, paddles.
City of Brussels	Inman "	Do.	1869	415	390	27.1	3081	6900	2 of 90	4 6	30	3000	14 1/2	8	24	Direct - acting horizontal trunk, screw.
Oceanic . . . . .	White Star "	Belfast	1871	432	420	31	3707	7240	2 of 41	5 0	65	3000	14 1/2	10	20	Do.
Britannic . . . . .	White Star "	Do.	1874	468	455	33.7	5004	9600	2 of 48	5 0	75	5100	16	8	32	Compound trunk - acting, screw.
City of Berlin . . .	Inman "	Greenock	1875	520	489	35	5491	10100	1 of 72	5 6	75	5200	16	12	36	Compound, 3-crank compound, screw.
Arizona . . . . .	Guion "	Glasgow	1879	573	450	35.7	5147	9300	1 of 62	5 6	90	6300	16 1/2	7	39	Do.
Servia . . . . .	Cunard "	Do.	1881	540	515	37.9	8500	12300	1 of 72	6 6	90	10000	16 1/2	7	39	Do.

Servia . . . Cunard  
 1872 115 430 45 4 557 514 9500  
 1881 540 515 52 379 8500 12300  
 1 of 62 5 6 90 6300 16  
 2 of 90  
 1 of 72 6 6 90 10000 16  
 2 of 100

Name of Ship.	Owners.	Where built.	Year.	Length.		Breadth.	Depth.	Tonnage.	Displacement.		Cylinders.		Stroke.	Pressure.	Indicated power.	Speed per hour.	No. of boilers.	Funnaces.	Type of engine, how propelled.
				Over B.P.	Under B.P.				tons.	%	No.	Dia.							
City of Rome.	Inman Line.	Barrow	1881	600	560	52.3	37	8000	13500	3 of 46	3 of 86	6 0	90	11500	17½	8	48	3-crank compound, tan-	
Alaska . . .	Guion	Glasgow	1881	520	500	50	38	6400	9500	1 of 68	2 of 109	6 0	100	11000	17½	9	54	3-crank compound, screw.	
Notting Hill¹.	Twin screw "	Do.	1881	435	420	45.1	26.5	3920	6210	2 of 32	2 of 76	4 0	100	2800	12	3	18	Compound tandem, twin screw.	
Aurania . . .	Cunard	Do.	1883	485	470	57.2	37.3	7269	13360	1 of 68	2 of 91	6 6	90	8500	17½	7	39	3-crank compound, screw.	
Oregon . . .	Guion	Do.	1883	520	500	54.2	40	7375	12500	1 of 70	2 of 104	6 0	110	13000	19	9	72	Do.	
America . . .	National	Do.	1884	459	432	51.3	36	5528	9550	1 of 68	2 of 91	5 6	95	9500	18½	7	39	Do.	
Etruria . . .	Cunard	Do.	1885	520	501	57.3	38	7718	13300	1 of 71	2 of 105	6 0	110	14500	19	9	72	Do.	
Aller . . .	N. German "	Do.	1886	455	438	48	34 6	5400	10400	1 of 44	1 of 70	6 0	150	7974	16½	6	36	3-crank triple, screw.	
City of Paris².	Inman and International Line.	Do.	1889	560	527	63.3	39.2	10500	17270	2 of 45	2 of 108	5 0	150	18500	20	9	54	3-crank triple, twin screw.	
Teutonic³.	White Star "	Belfast.	1889	582	566	57.8	39.4	9860	16740	2 of 113	2 of 43	5 0	180	17500	20	16	76	Do.	
Fürst Bismark⁴	Hamburg American "	Stettin	1891	520	502	57.6	38	8874	15800	2 of 110	2 of 43	5 6	160	17000	19½	9	72	Do.	
(New twin screw for)⁵.	Cunard	Glasgow	1893	630	600	65	42.7	13000	21000	2 of 67	2 of 106	160	26000	21½	14	102	3-crank tandem triple, twin screw.		

Note.—Steamers 1, 2, 3, 4, 5, being twin screws, have separate engines each with one set of cylinders.

TABLE No. 2.  
RAPID PASSAGES MADE BY ATLANTIC STEAMERS, 1840 TO 1891.  
*Outward.*

Year.	Month.	Name.	Owner.	From	To	Distance, knots.	Time occupied.		
1840	July	Britannia	Cunard Line.	Liverpool	Boston	2755	D.	H.	M.
1840	August	Acadia	Do.	Do.	Halifax	2487	11	4	0
1846	August	Europa	Do.	Do.	New York	3017	11	3	0
1852	August	Baltic	Collins	Do.	Do.	3054	9	13	0
1857	June	Persia	Cunard	Queenstown	Do.	3070	9	21	41
1864	July	Scotia	Do.	Do.	Do.	2783	8	15	45
1866	November	Do.	Do.	Do.	Do.	2851	8	4	34
1867	November	City of Paris <sup>1</sup>	Inman	Do.	Do.	2700	8	4	1
1872	May	Adriatic	White Star	Do.	Do.	2778	7	23	17
1875	September	Cable of Berlin	Inman	Do.	Do.	2829	7	18	2
1876	November	Britannic	White Star	Do.	Do.	2795	7	13	11
1877	April	Germanic	Do.	Do.	Do.	2830	7	11	37
1877	August	Britannic	Do.	Do.	Do.	2802	7	10	53
1880	May	Arizona	Guion	Do.	Do.	2761	7	10	47
1882	April	Alaska	Do.	Do.	Do.	2803	7	6	43
1884	August	Oregon	Do.	Do.	Do.	2792	6	9	42
1885	May	Etruria	Cunard	Do.	Do.	2821	6	5	31
1887	May	Umbria	Do.	Do.	Do.	2810	6	4	42
1888	May	Etruria	Do.	Do.	Do.	2855	6	1	55
1889	September	City of Paris <sup>2</sup>	Inman	Do.	Do.	2788	5	19	18
1891	August	Teutonic	White Star,	Do.	Do.	2778	5	16	31

<sup>1</sup> First City of Paris.

<sup>2</sup> Second City of Paris.

TABLE No. 3.

RAPID PASSAGES MADE BY ATLANTIC STEAMERS, FROM 1840 TO 1891.

*Homeward*

1887	May	Umbria	Do.	Do.	2810	6	4	42
1888	May	Etruria	Do.	Do.	2855	6	1	55
1889	September	City of Paris	Inman	Do.	2788	5	19	18
1891	August	Teutonic	White Star,,	Do.	2778	5	16	31

1 First City of Paris.      2 Second City of Paris.

TABLE No. 3.

RAPID PASSAGES MADE BY ATLANTIC STEAMERS, FROM 1840 TO 1891.

Homeward.

Year.	Month.	Name.	Owner.	From	To	Distance, knots.	Time occupied.		
							D.	H.	M.
1841	July	Britannia	Cunard Line.	Halifax	Liverpool	2573	10	0	0
1841	Do.	Acadia	Do.	Do.	Do.	2534	9	21	0
1851	May	Pacific	Collins	New York	Do.	3078	9	20	26
1852	February	Atlantic	Do.	Do.	Queenstown	2712	9	17	15
1856		Persia	Cunard	Do.	Do.	2732	9	1	45
1863	December	Scotia	Do.	Do.	Do.	2731	8	3	0
1869	Do.	City of Brussels	Inman	Do.	Do.	2786	7	22	3
1873	January	Baltic	White Star	Do.	Do.	2843	7	20	9
1875	October	City of Berlin	Inman	Do.	Do.	2820	7	15	28
1876	February	Germanic	White Star	Do.	Do.	2894	7	15	17
1876	December	Britannic	Do.	Do.	Do.	2882	7	12	41
1879	July	Arizona	Guion	Do.	Do.	2810	7	8	11
1882	June	Alaska	Do.	Do.	Do.	2791	6	22	0
1884	Do.	America	Do.	Do.	Do.	2815	6	14	8
1884	August	Oregon	National	Do.	Do.	2853	6	11	9
1887	March	Etruria	Guion	Do.	Do.	2890	6	4	36
1889	May	City of Paris	Cunard	Do.	Do.	2894	6	0	29
1889	August	Do.	Inman	Do.	Do.	2792	6	23	38
1889	December	Do.	Do.	Do.	Do.	2784	5	5	50
1891	October	Teutonic	White Star,,	Do.	Do.	2790	5	21	3

TABLE No. 4.  
 AVERAGE PASSAGES OF STEAMSHIPS OF ATLANTIC LINES  
 FROM 1850 TO 1890.

*Outward.*

Year.	Cunard.			Inman.			Guion.			White Star.		
	D.	H.	M.	D.	H.	M.	D.	H.	M.	D.	H.	M.
1850	13	0	0	—	—	—	—	—	—	—	—	—
1852	12	19	26	—	—	—	—	—	—	—	—	—
1855	12	12	0	—	—	—	—	—	—	—	—	—
1866	10	11	34	11	15	18	—	—	—	—	—	—
1873	10	16	40	10	22	4	12	6	38	9	19	48
1875	10	17	24	10	20	45	11	8	47	9	16	33
1876	10	13	32	10	1	44	10	23	45	8	21	14
1877	10	5	23	9	7	21	10	3	30	8	18	27
1878	9	22	27	9	4	15	9	20	1	8	15	39
1879	9	23	48	9	12	6	9	20	40	8	21	12
1880	9	22	12	9	10	45	9	16	50	8	23	12
1881	10	6	29	9	12	52	9	23	55	8	21	40
1882	9	17	39	10	0	45	9	10	41	9	0	18
1883	9	11	15	9	17	3	9	9	5	8	20	29
1884	9	11	15	9	20	3	9	9	5	8	20	29
1885	8	0	54	9	13	42	9	18	23	8	16	22
1886	7	11	10	9	11	32	9	3	27	8	16	15
1887	7	10	38	9	23	37	8	22	43	8	14	4
1888	7	8	5	9	2	44	9	1	2	8	12	45
1889	7	10	30	8	3	28	9	6	51	8	7	27
1890	7	15	23	8	16	9	9	14	34	7	17	0

AVERAG

Year.
1850
1855
1866
1873
1876
1877
1878
1879
1880
1881
1882
1883
1884
1885
1886
1887
1888
1889
1890



TABLE No. 5.

AVERAGE PASSAGES OF STEAMSHIPS OF ATLANTIC LINES  
FROM 1850 TO 1890.

*Homeward.*

White Star.

D. H. M.  
—  
—  
—  
9 19 48  
9 16 33  
8 21 14  
8 18 27  
8 15 39  
8 21 12  
8 23 12  
8 21 40  
9 0 18  
8 20 29  
8 20 29  
8 16 22  
8 16 15  
8 14 4  
8 12 45  
8 7 27  
7 17 0

Year.	Cunard.			Imman.			Guion.			White Star.		
	D.	H.	M.	D.	H.	M.	D.	H.	M.	D.	H.	M.
1850	12	16	0									
1855	11	12	0									
1866	9	4	39	10	11	40						
1873	9	7	59	10	0	2	10	20	18	8	22	39
1876	9	4	48	8	17	52	9	20	4	8	12	13
1877	9	5	59	8	21	51	9	12	54	8	11	9
1878	9	8	37	9	0	3	9	18	50	8	16	19
1879	9	3	26	8	22	33	9	9	46	8	10	32
1880	9	6	58	9	1	59	9	9	9	8	17	26
1881	9	9	29	9	2	18	9	11	14	8	13	54
1882	8	20	17	9	2	21	8	16	20	8	10	50
1883	8	20	46	9	2	55	8	13	1	8	11	6
1884	9	2	14	9	7	37	8	22	6	8	13	21
1885	7	14	36	9	2	19	9	5	34	8	6	44
1886	7	3	29	9	2	18	8	18	52	8	6	42
1887	7	5	46	9	8	6	8	15	10	8	5	9
1888	7	0	31	8	18	5	8	15	47	8	3	46
1889	7	2	40	7	23	23	8	14	1	7	22	7
1890	7	4	52	8	6	37	8	20	6	7	6	16

TABLE No. 6.  
AVERAGE PASSAGES OF THE TWO FASTEST STEAMERS OF  
EACH LINE.

*Outward.*

Year.	Cunard.			Inman.			White Star.		
	D.	H.	M.	D.	H.	M.	D.	H.	M.
1889 . . . .	6	20	33	6	11	26	6	11	29
1890 . . . .	6	18	10	6	6	4	6	5	0
1891 . . . .	6	11	50	6	6	4	6	2	30

*Homeward.*

1889 . . . .	6	18	8	6	9	56	6	11	21
1890 . . . .	6	12	22	6	9	30	6	7	30
1891 . . . .	6	10	20	6	8	24	6	3	50

FASTEST PASSAGES YET MADE BY THE FASTEST STEAMER  
OF EACH LINE.

*Outward.*

Year.	Month.	Steamer.	Line.	D.	H.	M.
1888	May	<b>Etruria</b>	Cunard	6	1	47
1889	September	<b>City of Paris</b>	Inman	5	19	18
1891	August	<b>Teutonic</b>	White Star	5	16	31

*Homeward.*

1888	November	<b>Umbria</b>	Cunard	6	3	17
1889	December	<b>City of Paris</b>	Inman	5	22	50
1891	October	<b>Teutonic</b>	White Star	5	21	3

TABLE No. 7.

LIST OF STEAMSHIPS AND NUMBER OF LIVES LOST IN ATLANTIC TRADE FROM 1840 TO 1892.

TEAMERS OF

White Star.

D.	H.	M.
6	11	29
6	5	0
6	2	30

6	11	21
6	7	30
6	3	50

ST STEAMER

D. H. M.

6	1	47
5	19	18
5	16	31

6	3	17
5	22	50
5	21	3

TABLE No. 7.

LIST OF STEAMSHIPS AND NUMBER OF LIVES LOST IN ATLANTIC TRADE FROM 1840 TO 1892.

Year.	Month.	No.	Name of vessel.	Owners.	Nationality.	No. of lives lost.	How lost.	Where.
1841	March 11	1	President	Brit. and Amer. S. N. Co.	British	136	Never heard of	
1844	July 1	2	Columbia	Cunard Line	Do.	None	Wrecked in fog	
1850	Nov.	3	Helen Sloman			9	Burned	Halifax
1852	Dec. 24	4	St. George			51	Wrecked	
1853	Dec. 5	5	Humboldt	New York and Havre S. N. Co.	American	1		
1854	July 17	6	Franklin	Do.	Do.	None		Long Island Cape Race At sea
1854	Sept. 9	7	City of Philadelphia	Inman Line	British	322	Do.	
1854	Sept. 27	8	Arctic	Collins Line	American	46	Collision	
1856	June 20	9	St. Denis					
1856	Sept. 23	10	Pacific	Collins Line	French	240	Never heard of	
1856	Nov. 2	11	Le Lyonnais			120	Collision	
1857	Feb. 26	12	Tempest	Anchor Line	British	150	Never heard of	Nantucket
1857	June 1	13	Canadian	Allan Line	Do.	None	Wrecked	
1858	June 13	14	New York	Glas. and New York S. Co.	Do.	470	Burned	Mull of Kintyre At sea
1858	Sept. 13	15	Austria	Hamburg, American	German	470	Wrecked	Newfoundland
1859	June 28	16	Argo	Galway Line	British	None		Nova Scotia
1859	Nov. 21	17	Indian	Allan Line	Do.	27	Do.	Sable Island
1860	Feb. 20	18	Hungarian	Do.	Do.	237	Do.	Massachusetts
1860	Oct. 7	19	Connaught	Galway Line	Do.	None	Burned	Straits of Belleisle
1861	June 4	20	Canadian	Allan Line	Do.	35	Coll. with iceberg	Paraquet Island
1861	Nov. 5	21	North Briton	Do.	Do.	None	Wrecked	Cape Race
1863	April 27	22	Anglo-Saxon	Do.	Do.	237	Do.	
1863	June 14	23	Norwegian	Do.	Do.	None	Do.	St. Paul Island

TABLE No. 7—continued.

Year.	Month.	No.	Name of vessel.	Owners.	Nationality.	No. of lives lost.	How lost.	Where.
1863	Aug. 4	24	Georgia	National Line	British	None	Wrecked	Sable Island
1864	Feb. 22	25	Bohemian	Allan Line	Do.	20	Do.	Cape Elizabeth
1864	March 29	26	City of New York	Imman Line	Do.	None	Do.	Danants-Rick, Quistown
1864	Nov. 3	27	Jura	Chartered by Allan Line	Do.	None	Do.	Near Liverpool
1864	Dec. 10	28	Iowa	London Line	Do.	Do.	Do.	Cherbourg
1865	July 31	29	Glasgow	Imman Line	Do.	Do.	Burned	Nantucket
1866	Dec. 1	30	Scotland	National Line	Do.	Do.	Collision	At sea
1868	January	31	Chicago	Gulion Line	British	Do.	Wrecked	Danants-Rick, Quistown
1868	April 17	32	United Kingdom	Anchor Line	Do.	80	Never heard of	
1868	Nov. 25	33	Hibernia	Do.	Do.	66	Foundered	
1869	Aug. 7	34	Germania	Hamburgh American	Do.	None	Wrecked	Cape Race
1869	Aug. 8	35	Cleopat a	Imman Line	German	Do.	Wrecked	Newfoundland
1870	Jan. 28	36	City of Boston	Anchor Line	Do.	177	Lost in fog	N. W. coast of Ireland
1870	Oct. 19	37	Cambria	Allan Line	Do.	190	Never heard of	Halifax
1872	April 7	38	Dacian	Imman Line	Do.	None	Do.	
1872	Oct. 8	39	Scandaria	Anglo-Egyptian Line	Do.	38	Never heard of	
1872	Dec. 3	40	Germany	Allan Line	Do.	30	Wrecked	Near Bordeaux
1873	Jan. 27	41	Britannia	Anchor Line	Do.	None	Do.	Arran Island
1873	April 1	42	Atlantic	Oceanic S. N. Co.	Do.	585	Do.	Near Halifax
1873	May 17	43	Tripoli	Imman Line	Do.	None	Do.	Tuskar Rock
1873	July 7	44	City of Washington	Anchor Line	Do.	None	Do.	Nova Scotia
1873	Sept. 27	45	Ismaïlia	Imman Line	Do.	52	Never heard of	
1873	Oct. 1	46	Missouri	Dominion Line	Do.	None	Wrecked	Bahamas
1873	Nov. 22	47	Ville du Havre	Transatlantique Line	Do.	226	Collision	At sea
1873	Dec.	48	Colorado	Gulion Line	French	6	Do.	River Mersey
1874	April 3	49	Europe	Transatlantique Line	French	None	Foundered	At sea
1875	May 7	50	Schiller	Eagle Line	German	312	Wrecked	Scilly Islands
1875	June 2	51	Vicksburg	Dominion Line	British	47	Coll. with iceberg	Off Newfoundland

TABLE No. 7—continued.

Year.	Month.	No.	Name of vessel.	Owners.	Nationality.	No. of lives.	How lost.	Where.
1873	Oct. 1	46	Missouri	Dominion Line	Do.	32	Never heard of	Bahamas
1873	Nov. 22	47	Ville du Havre	Transatlantique Line	French	None	Wrecked	At sea
1873	Dec.	48	Colorado	Union Line	British	236	Collision	River Mersey
1874	April 3	49	Europe	Transatlantique Line	French	None	Foundered	At sea
1875	May 7	50	Schiller	Eagle Line	German	312	Wrecked	Scilly Islands
1875	June 2	51	Vicksburg	Dominion Line	British	47	Coll. with iceberg	Off Newfoundland

TABLE No. 7—continued.

Year.	Month.	No.	Name of vessel.	Owners.	Nationality.	No. of lives.	How lost.	Where.
1875	July 19	52	Abbotsford	Chartered by Amer. Line	British	None	Wrecked	Anglesea
1876	Dec. 6	53	Deutschland	Norddeutscher Line	German	52	Do.	Goodwin Sands
1877	Jan.	54	Colombo	Wilson Line	British	44	Never heard of	At sea
1877	Feb. 6	55	Bavaria	Dominion Line	Do.	None	Burned	Long Island
1877	March 17	56	Rusland	Red Star Line	Belgian	Do.	Wrecked	North Wales
1877	May	57	Dakota	Union Line	British	Do.	Do.	Coast of Wexford
1878	June 1	58	Iaoko	Do.	Do.	Do.	Do.	Anticosta
1878	July 30	59	Lake Megantic	Beaver Line	Do.	Do.	Do.	At sea
1878	Sept. 28	60	Herman Ludwig	Do.	German	50	Never heard of	At sea
1878	Sept.	61	Yoxford	Do.	British	None	Foundered	Off Dover
1878	Nov. 26	62	Pomerania	Hamburgh-Americau	German	50	Collision	At sea
1878	Dec. 4	63	Bayard	Do.	British	None	Foundered	At sea
1878	Dec. 17	64	Homer	Do.	Do.	43	Never heard of	
1879	Jan. 11	65	Zanzibar	Do.	Do.	48	Do.	
1879	Feb. 18	66	Surbiton	Do.	Do.	33	Do.	
1879	March 19	67	Bernicia	Do.	Do.	45	Do.	
1879	July 15	68	State of Virginia	State Line	Do.	9	Stranded	Sable Island
1879	Dec. 2	69	Bonussia	Dominion Line	Do.	165	Foundered	At sea
1880	Feb. 10	70	Hindoo	Wilson Line	Do.	6	Do.	Do.
1880	March 14	71	Montana	Union Line	Do.	None	Wrecked	Anglesea
1880	Sept. 10	72	Anglia	Anchor Line	Do.	Do.	Collision	At sea
1880	Dec. 31	73	Brazilian	Chart. by Warren Line	Do.	Do.	Wrecked	Near Liverpool
1881	Jan. 8	74	City of Limerick	Do.	Do.	43	Never heard of	
1881	Jan. 22	75	Titania	Leyland Line	Do.	27	Do.	
1881	Feb. 7	76	Bohemian	Do.	Do.	33	Wrecked	Near Crookhaven
1881	March 3	77	Drumduff	Do.	Do.	1	Foundered	At sea
1881	April 16	78	Beleize	Do.	Do.	None	Do.	Do.
1881	May 29	79	Macedonia	Anchor Line	Do.	Do.	Stranded	Mull of Cantyre

TABLE No. 7—continued.

Year.	Month.	No.	Name of vessel.	Owners.	Nationality.	No. of lives lost.	How lost.	Where.
1881	Nov. 13	80	City of London		British	41	Never heard of	At sea
1881	Dec. 1	81	Hurworth	Furness Line	Do.	None	Foundered	Do.
1881	Dec. 3	82	Bath City	Allan Line	Do.	11	Do.	
1881	Dec. 30	83	Moravian	Hamburg-American Line	Do.	None	Wrecked	Nova Scotia
1882	October	84	Herder		British	27	Do.	Newfoundland
1883	Jan. 3	85	Straits of Dover		German	27	Never heard of	
1883	Jan. 7	86	City of Brussels	Imman Line	Do.	10	Collision	Mouth of the Mersey
1883	Jan. 19	87	Cimbria	Hamburg-American Line	German	389	Do.	North Sea
1883	Feb. 5	88	Notting Hill	Twin Screw Line	British	None	Coll. with iceberg	
1883	Feb. 15	89	Glamorgan		Do.	7	Foundered	At sea
1883	Feb. 23	90	Gloucester City	Furness Line	Do.	None	Coll. with iceberg	
1884	April 3	91	Daniel Steinman	Red Cross Line	Belgian	116	Wrecked	Halifax
1884	April 18	92	State of Florida	State Line	British	108	Collision	At sea
1884	May 3	93	Romano	Wilson Line	Do.	None	Collision	Do.
1884	May 15	94	Ulryan	Leyland Line	Do.	Do.	Stranded	S. coast of Ireland
1884	May 21	95	Coniston		Do.	27	Never heard of	
1884	Dec. 24	96	Ferriwood		Do.	25	Do.	
1885	Jan. 20	97	Preston		Do.	29	Do.	
1885	Jan. 24	98	Clandon		Do.	27	Do.	
1885	Jan. 25	99	Benwell Tower		Do.	2	Foundered	At sea
1885	Feb. 15	100	Humber	Beaver Line	Do.	56	Never heard of	Miquelan Island
1885	June 14	101	Lake Manitoba	Allan Line	Do.	Do.	Stranded	Newfoundland
1885	Sept. 2	102	Hanoverian	Leyland Line	Do.	Do.	Wrecked	
1885	Nov. 21	103	Iberian	Warren Line	Do.	Do.	Stranded	
1886	March 1	104	Missouri	Cunard Line	Do.	Do.	Do.	Welsh coast
1886	March 11	105	Oregon	Beaver Line	Do.	Do.	Collision	Fire Island
1886	June 30	106	Lake Champlain	Hooper, Murrell, and Williams	Do.	Do.	Stranded	Co. Antrim
1886	Sept. 28	107	Suffolk		Do.	Do.	Do.	Near Lizard
1887	Jan. 14	108	Celtic Monarch	Monarch Line	Do.	Do.	Foundered	Off coast of Ireland

TABLE No. 7—continued.

Year.	Month.	No.	Name of vessel.	Owners.	Nationality.	No. of lives.	How lost.	Where.
1886	March 11	105	Oregon	Cunard Line	Do.	Do.	Collision	Fire Island
1886	June 30	106	Lake Champlain	Baver Line	Do.	Do.	Stranded	Co. Antrim
1886	Sept. 28	107	Suffolk	Hooper, Murrell, and Williams	Do.	Do.	Do.	Near Lizard
1887	Jan. 14	108	Celtic Monarch	Morarch Line	Do.	Do.	Foundered	Off coast of Ireland

TABLE No. 7—continued.

1887	Aug. 12	109	City of Montreal	Inman Line	British	None	Burned	At sea
1887	Nov. 19	110	W. A. Scholten	Dutch Line	Dutch	130	Collision	English Channel
1887	Dec. 23	111	Newcastle City	Furness Line	British	None	Foundered	At sea
1888	Aug. 14	112	Geiser	Thingvalia Line	Danish	119	Collision	Off Sable Island
1889	April 6	113	Danmark	Do.	Do.	None	Foundered	At sea
1889	May 22	114	Cynthia	Donaldson Line	British	8	Collision	River St. Lawrence
1889	Oct. 27	115	Queensmore	Johnston Line	Do.	None	Burned	At sea
1889	Dec. 31	116	Erin	National Line	Do.	72	Never heard of	At sea
1890	July 19	117	Egypt	Do.	Do.	None	Burned	At sea
1890	Nov. 26	118	T. Hanemore	Johnston Line	Do.	43	Never heard of	At sea
1891	Feb. 22	119	Iowa	Warren Line	Do.	None	Coll. with iceberg	Gibraltar Bay
1891	March 17	120	Utopia	Anchor Line	Do.	563	Collision	At sea
1891	December	121	Alyssinia	Guion Line	Do.	None	Burned	At sea
1892	Jan. 31	122	Eiderl	Norddeutscher	German	None	Stranded	Isle of Wight

Total number of lives lost through steamship disasters . . . . . 6,369  
 Estimated loss through various causes . . . . . 600  
 Total number of lives lost . . . . . 6,969 from 1840 to 1892.

<sup>1</sup> Since refloated.  
 NOTE.—Dates given for vessels never heard of are dates of sailing from ports.

## FUNNELS, FLAGS, AND NIGHT SIGNALS OF THE TRANSATLANTIC LINES.

LINE.	FUNNELS.	FLAGS.	NIGHT SIGNALS.
American . . . . .	Red, white keystone, with red star, black top.	Red, swallow-tail, white keystone in centre, with red star.	Red light, Roman candle throwing six red balls, red light.
Anchor . . . . .	Black.	White swallow-tail, red anchor in centre.	Red and white lights alternately (lanterns).
Allan . . . . .	Red, with white band under black top.	Red, white and blue, with pennant . . . . .	Three blue lights displayed in form of triangle.
Beaver . . . . .	Black, two white bands, black top.	Beaver on white ground, blue border and pennant.	Three green lights simultaneously, one at each end of bridge and one at stern of vessel.
Bordeaux . . . . .	White, with black top . . . . .	White, red border, three red crescents in centre, blue letters C.B.N.V.	Blue, red and white Coston light.
Bristol . . . . .	Black, red band, blue and white circle, black top.	Red, blue and white, ball in centre . . . . .	A Coston pyrotechnic signal showing red and green alternately.
Cunard . . . . .	Red, with black top . . . . .	Red, with yellow lion holding world . . . . .	Blue light and two Roman candles, each throwing six blue balls.
Dominion . . . . .	Red, white band; red, black top . . . . .	Red white diamond, and blue ball in centre . . . . .	Roman candle throwing six red stars.
Fabre . . . . .	Black.	White, with blue cross . . . . .	A Coston pyrotechnic signal showing alternately red, white and blue in order named.
Great Western . . . . .	Black, red band, blue and white ball.	Red, blue and white ball in centre . . . . .	Blue lights forward, aft and on bridge simultaneously.
Gunion . . . . .	Black, red band and black top . . . . .	Blue, white diamond, black star in centre . . . . .	Three Roman candles at stern of vessel each showing seven stars as follows—white, red, blue, white, red, blue, white.
Hamburg . . . . .	Black . . . . .	White and blue, anchor, shield, and letters H.A.P.A.G.	Blue light forward and aft, red light on bridge, and rocket.
Inman . . . . .	Black, white band and black top . . . . .	White swallow-tail, I. & I. in centre in red . . . . .	Three red lights in succession.
Leyland . . . . .	Buff, and black top . . . . .	Red flag, square . . . . .	Blue light forward and aft, and red light on bridge.
National . . . . .	White, with black top . . . . .	Red Union Jack, ground white, cross in centre.	Red, green, white, red Coston light.
Nav. Gen. Italiana . . . . .	Black, white and black . . . . .	Red and white ground, lion and red cross . . . . .	Green, white and green lights.
Netherlands . . . . .	Black, white band, green border . . . . .	Green, white and green, N.A.S.M. in centre.	Two blue and red Coston lights changing together.
North German Lloyd . . . . .	Cream . . . . .	White, blue key and anchor crossed, oak-leaf wreath.	Three red lights forward, bridge and aft.
Red Star . . . . .	Cream, black top and red star . . . . .	White, with red star . . . . .	Blue light forward, white light amidships, red light aft.
Transatlantic . . . . .	Red, with black top . . . . .	White, red ball in corner, and name C.G.T.A.	White, red, red white Coston light.
Thingvalle . . . . .	Yellow, white band, blue stars . . . . .	White, with seven pointed blue stars . . . . .	Two green lights simultaneously.
White Star . . . . .	Cream, black top . . . . .	Red swallow-tail, with white star . . . . .	Green, white, green Coston light.
White Cross . . . . .	Yellow, black top . . . . .	Red, with white cross . . . . .	Two red lights.
Wilson . . . . .	Red, with black top . . . . .	White pennant, with red ball . . . . .	
Warren . . . . .	Black . . . . .	Red flag, square, white diamond in centre . . . . .	

SINCE  
once  
the A  
buildi  
be bui  
the W  
(Febr  
these  
are to  
deep,  
gross,  
about  
thing  
less th  
It i  
horse-  
Paris  
The  
with t  
two l  
pressu  
and o  
sure c  
Ste  
huge  
furnac  
system  
the co  
giving



red light aft.  
 White, red, red white (oston light.  
 Two green lights simultaneously.  
 Green, white, green (oston light.  
 Two red lights.  
 C.C.T.A.  
 White, with seven pointed blue stars  
 Red, swallow-tail, with white star  
 Red, with white cross.  
 White pennant, with red ball  
 Red flag, square, white diamond in centre  
 Yellow, white band, blue stars  
 Cream, black top  
 Yellow, black top  
 Red, with black top  
 Black  
 Thingwall  
 White Star  
 White Cross  
 Wilson  
 Warren

## APPENDICES.

### NEW CUNARD LINERS.

1892.

SINCE the foregoing was written the Cunard Line, in order to once more attain the honour of having the fastest vessels on the Atlantic, have placed an order with the Fairfield Ship-building Company, of Glasgow, for two immense steamers to be built of steel, having twin screws fitted after the style of the White Star boats, but not overlapping. Up to the present (February, 1892) the various particulars and dimensions of these vessels have not been officially announced, but they are to be 600 feet long, B.P. 65 feet broad, and 42·7 feet deep, and over 21,000 tons displacement and 13,000 tons gross, and have a speed on trial of 22 knots per hour, and about 21 at sea, which speed would mean a passage of something over 5¼ days across the Atlantic, or about half a day less than the **Teutonic** and **Majestic**.

It is stated the machinery is to indicate 25,000 to 26,000 horse-power, or about 50 per cent. more than the **City of Paris**.

The two sets of main engines are to be triple expansion with three cranks, but five cylinders to each engine, namely, two high-pressure, placed tandem on top of the two low-pressure cylinders, and placed one on the forward crank-shaft, and one on the after crank-shaft, the one intermediate-pressure cylinder being on the middle crank-shaft.

Steam at 160 lbs. pressure will be generated in twelve huge double-ended boilers and one single boiler, having 100 furnaces in each ship. As it is no doubt likely that some system of forced draught (probably Howden's) will be fitted, the consumption of coal will range about 400 tons per day, giving about 1½ lbs. per indicated horse-power.

The cabin arrangements are designed to have the saloon between the funnels, as in the White Star steamers; it will be over 85 feet long by 63 feet wide, and seat 400 passengers, and the utmost efforts will be made to secure the highest degree of elegance and comfort. To construct and work these immense vessels an enormous capital will be required, as taking the cost of hull finished at £30 per ton (a moderate figure) on the 13,000 tons, and the machinery at £10 per indicated horsepower, the figures will be £390,000 and £260,000 respectively, making a total cost of £650,000 for each steamer, or £1,300,000 invested in two vessels.

#### VICTUALLING REQUIREMENTS AND STORES OF AN ATLANTIC LINER.

The following interesting particulars, for the year 1886, of the victuals put on board a Cunard liner for the round voyage, and also of the staff employed by the Company, are given in the "Life of Sir George Burns," by Edwin Hodder, 1890; these figures must now be considerably increased owing to the continued expansion of the traffic:—

"For a single passage to America the *Etruria*, with 547 cabin passengers and a crew of 287 persons on board, carries the following quantities of provisions:—12,550 lbs. fresh beef, 760 lbs. corned beef, 5,320 lbs. mutton, 850 lbs. lamb, 350 lbs. veal, 350 lbs. pork, 2,000 lbs. fresh fish, 600 fowls, 300 chickens, 100 ducks, 50 geese, 80 turkeys, 200 brace grouse, 15 tons potatoes, 30 hampers of vegetables, 220 quarts ice cream, 1,000 quarts of milk, and 11,500 eggs (or at the rate of one egg per minute from the time the ship sails from Liverpool until her arrival in New York).

"The quantities of wines, spirits, beer, etc., put on board for consumption on the round voyage, comprise 1,100 bottles champagne, 850 bottles claret, 6,000 bottles ale, 2,500 bottles porter, 4,500 bottles mineral waters, 650 bottles various spirits.

"Crockery is broken very extensively, being at the rate of 900 plates, 280 cups, 438 saucers, 1,213 tumblers, 200 wine-glasses, 27 decanters, and 63 water-bottles in a single voyage.

"As regards the consumption on board the whole Cunard

fleet  
sheep  
flock  
a pas  
4,230  
tons  
"  
of a  
one t  
8,000  
jars  
and  
34 to  
48,900  
"  
follo  
chan  
bottl  
bottl  
tobac  
"  
pany  
nearl  
"  
one f  
Hous  
"  
Cuna  
engin  
men,  
upho  
or ab  
a dis  
moon

fleet for one year, the figures seem almost fabulous:—4,656 sheep, 1,800 lambs, 2,474 oxen are consumed—an array of flocks and herds surpassing in extent the possessions of many a pastoral patriarch of ancient times—besides 24,075 fowls, 4,230 ducks, 2,200 turkeys, 2,200 geese, 53 tons of ham, 20 tons bacon, 15 tons cheese, and 831,603 eggs.

“Other articles are in extensive demand, and in the course of a year there is consumed:—one ton and a half of mustard, one ton and three quarters of pepper, 7,216 bottles pickles, 8,000 tins sardines, 33 tons salt cod and ling, 4,192 four-lb. jars of jam, 15 tons marmalade, 22 tons raisins, currants, and figs, 18 tons split peas, 15 tons pearl barley, 17 tons rice, 34 tons oatmeal, 460 tons flour, 23 tons biscuits, 33 tons salt, 48,902 loaves of bread 8 lbs. each.

“The Cunard passengers annually drink and smoke to the following extent:—8,030 bottles and 17,613 half-bottles champagne, 13,941 bottles and 7,310 half-bottles claret, 9,200 bottles other wines, 489,344 bottles ale and porter, 174,921 bottles mineral waters, 344,000 bottles spirits; 34,360 lbs. tobacco, 63,340 cigars, and 56,875 cigarettes.

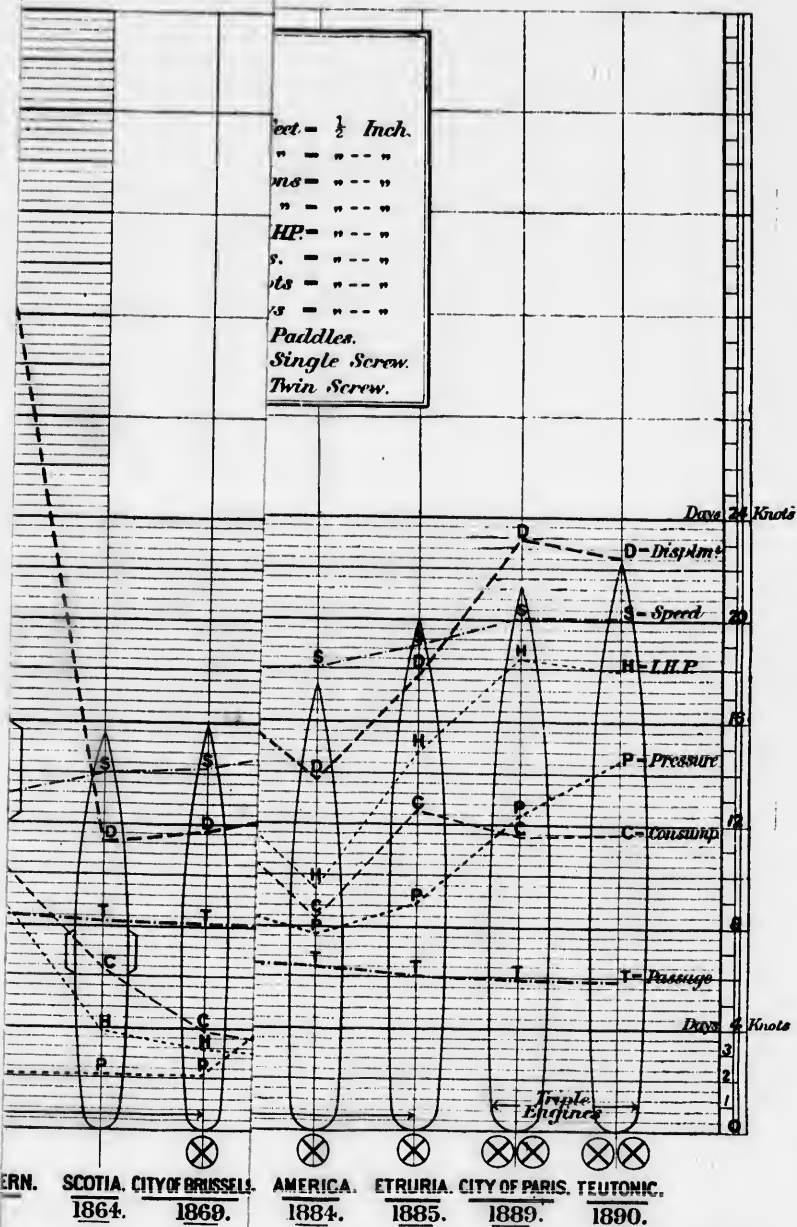
“The heaviest item in the annual consumption of the Company is of course coal, of which 356,764 tons are burnt—nearly equal to 1,000 tons for every day in the year.

“This quantity of coal, if built as a wall four feet high and one foot thick, would reach from Land’s End to John o’ Groats’ House.

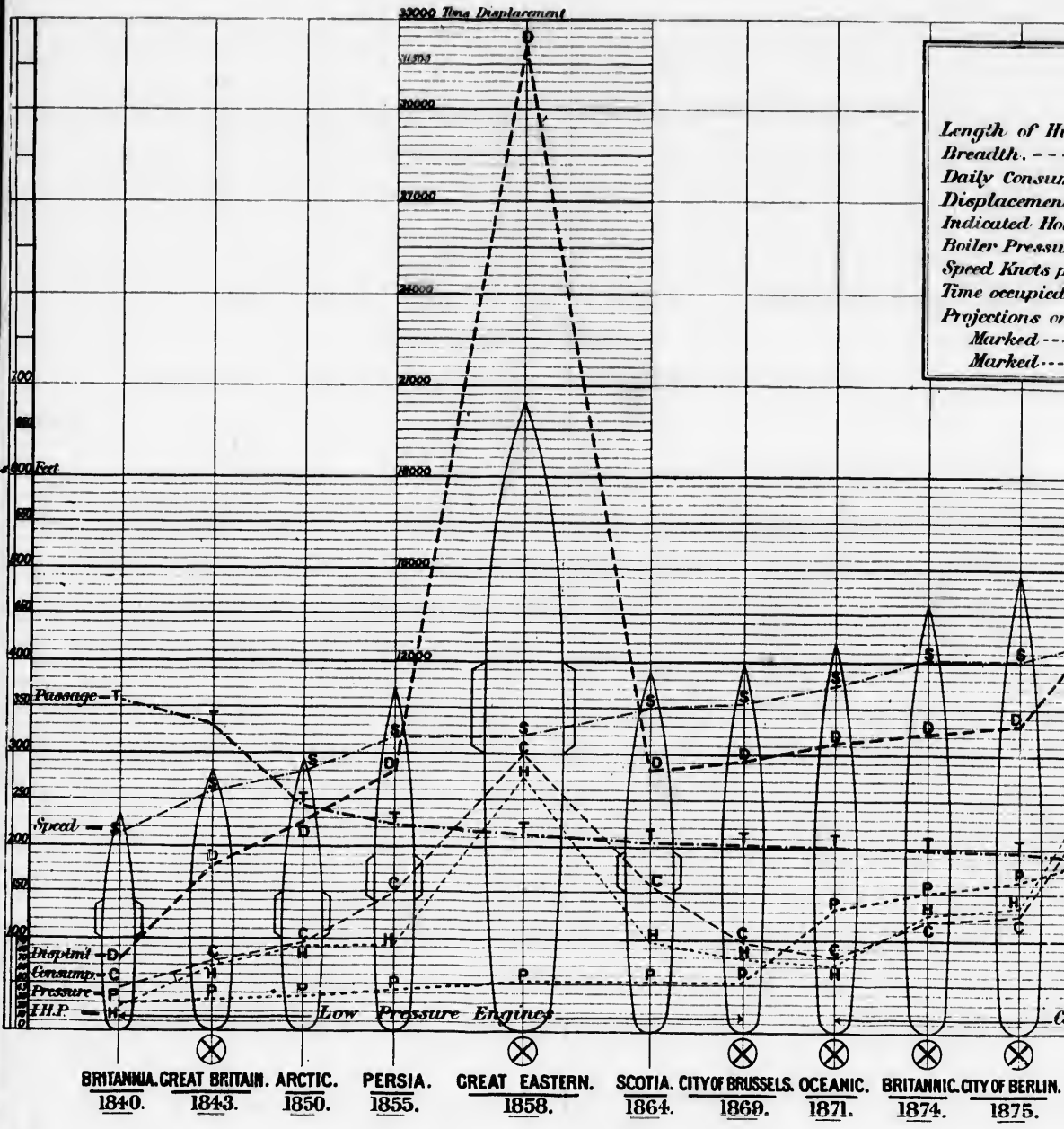
“With regard to the aggregate employment of labour by the Cunard Company, it includes 34 captains, 146 officers, 628 engineers, boilermakers, and carpenters, 665 seamen, 916 firemen, 900 stewards, 62 stewardesses, 42 women to keep the upholstery and linen in order, with 1,100 men of a shore gang, or about 4,506 people to run the ships, which traverse yearly a distance equal to five times that between the earth and the moon!”



# ATING THE DEV 1840-1890.



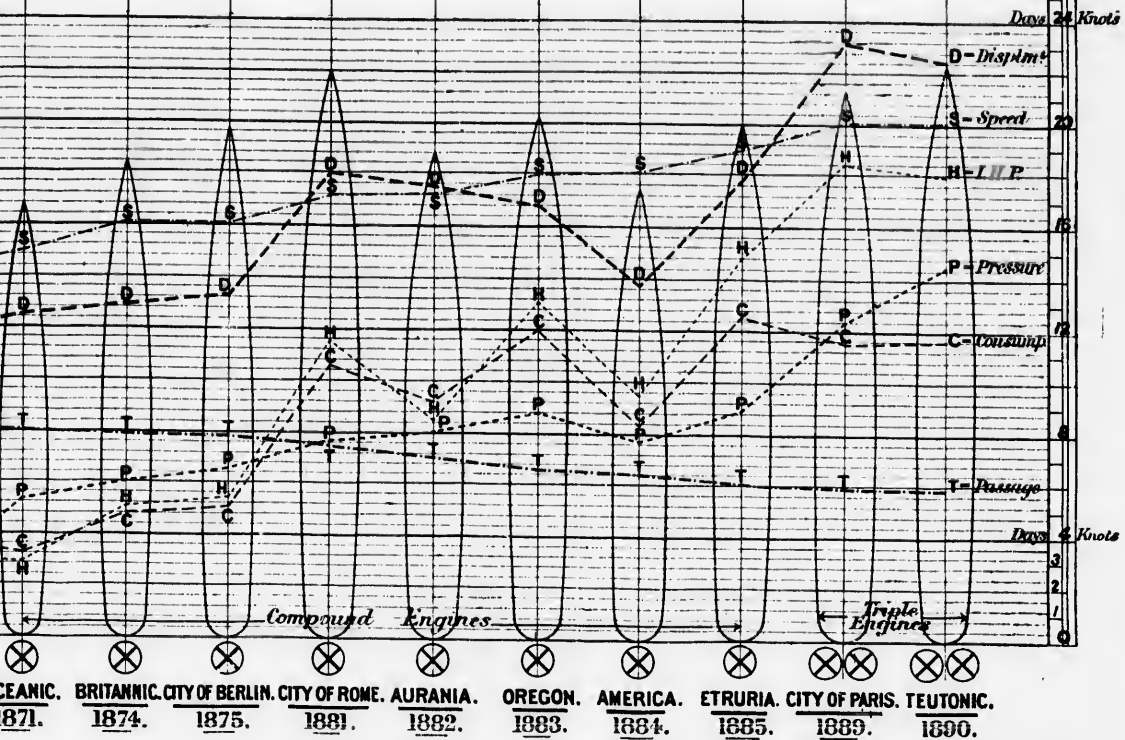
# DIAGRAM ILLUSTRATING THE DEVELOPMENT OF A

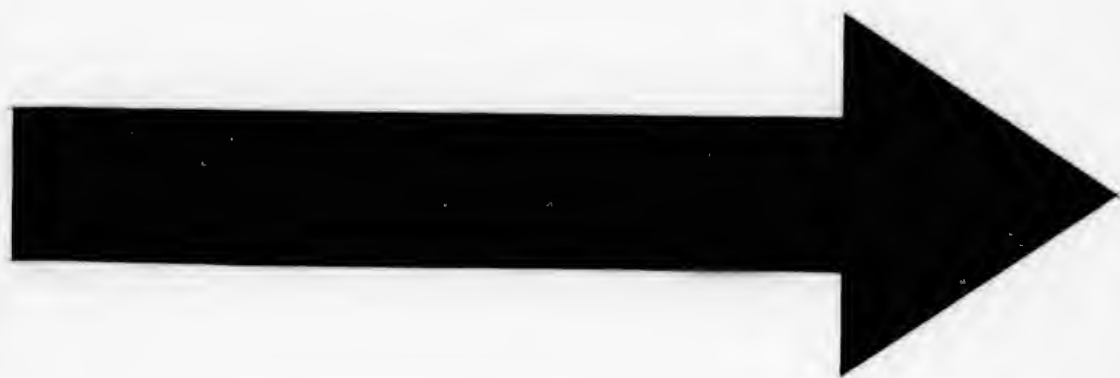


# DEVELOPMENT OF ATLANTIC STEAMERS, 1840—1890.

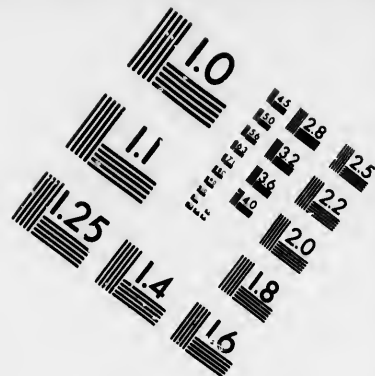
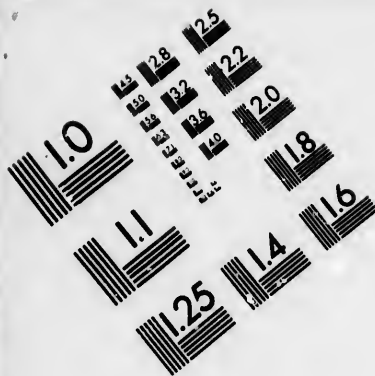
## REFERENCE.

Length of Hull B.P. ----- Scale 100 Feet =  $\frac{1}{2}$  Inch.  
 Breadth. ----- " " 100 " " " "  
 Daily Consumption marked C " " 100 Tons " " "  
 Displacement ----- " " D " " 3000 " " " "  
 Indicated Horse Power " " H " " 4000 IHP " " "  
 Boiler Pressure ----- " " P " " 50 lbs. " " "  
 Speed Knots per Hour " " S " " 4 Knots " " "  
 Time occupied on Passage " " T " " 4 Days " " "  
 Projections on Sides-Denotes Propelled by Paddles.  
 Marked ----- (X) " " " " Single Screw.  
 Marked ----- (X)(X) " " " " Twin Screw.

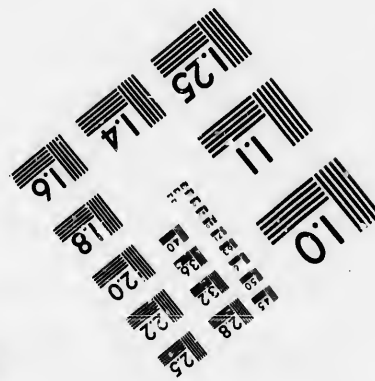
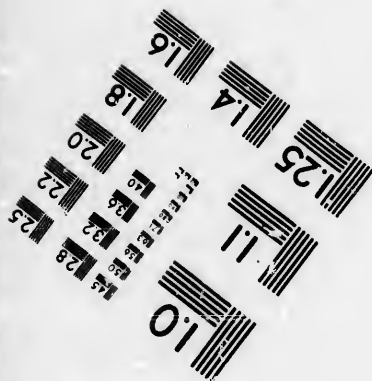
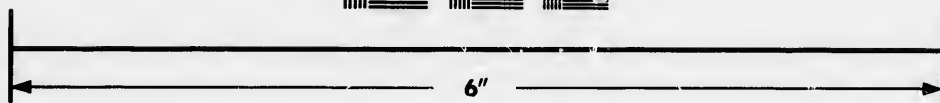
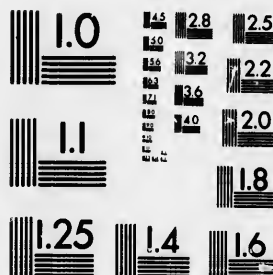








**IMAGE EVALUATION  
TEST TARGET (MT-3)**



**Photographic  
Sciences  
Corporation**

23 WEST MAIN STREET  
WEBSTER, N.Y. 14530  
(716) 672-4503

18 20 22 25  
E8 E6 E4 E3 E2 E1

10  
E1 E2 E3 E4 E5 E6 E7 E8

Abyss  
Acadia  
Accide

Accou  
Admir

Adriat  
W  
Advert

Cu  
In  
W

Africa,  
Alaska  
"Albic

Algeria  
Allan  
Aller s

en,  
Allibor  
Americ

Na  
Americ  
Lin

Ammon  
Anchor  
Anchor

Annual  
Append  
Archim

Arctic,

## INDEX.

- Abyssinia, Cunard Line, 35.  
 Acadia, Cunard Line, 21.  
 Accident to City of Paris' engines,  
     60.  
 Accountancy department, 134.  
 Admiralty, hire of Atlantic  
     steamers, 102.  
 Adriatic, Collins Line, 43.  
     White Star Line, 92.  
 Advertisements, Transatlantic  
     Steamship Company, 7.  
     Cunard, 23.  
     Inman, 45.  
     White Star, 77.  
 Africa, Cunard Line, 30.  
 Alaska, 74.  
 "Albion, Liverpool," 24, 26, 30,  
     237, 248.  
 Algeria, Cunard Line, 35.  
 Allan Line, 64.  
 Aller ss., 126.  
     engines of, 127.  
 Allibon, G., 229.  
 America, Cunard Line, 30.  
     National Line, 68, 87.  
 American Liners, 44.  
     Line, The, 111.  
 Ammonia ice machines, 193, 198.  
 Anchor Line, 62.  
 Anchors, 147.  
 Annual inspection, 145.  
 Appendix, 293.  
 Archimedes, first screw, 34.  
 Arctic, Collins Line, 41.  
     Arctic, engines of, 41.  
         loss of, 42.  
 Arizona, ss., 72.  
     collides with iceberg, 73.  
 Armed cruisers, 100, 218.  
 Arrival of steamers, 135.  
 Asia, Cunard Line, 30, 86, 87.  
 Atlantic steamer, Collins Line, 41.  
     ,, "Greyhounds," 74.  
     ,, lines, working of, 133.  
     ,, records and tables, 270.  
     ,, steamers, old and new, 84.  
     ,, Transport Line, 118.  
 Augusta Victoria, ss., 122.  
 Aurania, ss., 36.  
 Australian steamships, estimate  
     for, 241.  
 Average passages, table of, 284,  
     285.  
 Bain, James, sup.-engineer Cu-  
     nard Line, 228.  
 Baltic, Collins Line, 41.  
     White Star Line, 77.  
 Beaver Line, 114.  
 Bessemer, with oscillating saloon,  
     92.  
 Black Star Line of Packets, 255.  
 Black Ball Line, fastest passage,  
     274.  
 Board of Trade surveys, 146.  
 Boats, capacities and arrange-  
     ments of, 147.  
 Boiler pressures, 273.

- Borussia, ss., 121.  
 Bothnia, ss., 35.  
 Bremen, ss., 124.  
 Britannia, Anchor Line, 63.  
     Cunard Line, 21, 22.  
     engineers of, 175.  
     in the ice, 24.  
     plan of, 7.  
     steam-pipe bursts, 174.  
 Britannic, ss., 83.  
     deck plan of, 80.  
     lowering propeller, 92.  
     stern of, 185.  
     unprecedented record of, 87.  
 British and North American Royal  
     Mail Company, 23, 30, 249.  
 British King, ss., 94.  
 British Queen, early steamer, 16.  
     accident to, 263.  
 Buenos Ayrean, ss., 36.  
 Bulkheads save life, 37.  
     mid-line, 59.  
 Bulk, petroleum first carried in,  
     128.  
 Burning of landing stage, 152.  
 Burning of Sarah Sands, 257.  
 Burns, Sir George, 21.  
 Burns, Sir George, life of, 202.  
 Burns, Sir John, 41.  
  
 Cabin plan of Britannia, 22.  
     Britannic, 80.  
     China, 34.  
     City of Paris, 60.  
     Etruria, 38.  
     Oceanic, 80.  
     Teutonic, 98.  
 Caledonia, Cunard Line, 23.  
 Canada, Cunard Line, 30.  
 Canada Shipping Company, 114.  
 Canadian, Allan Line, 64.  
     Steam Navigation Company,  
         257.  
  
 Cattle first carried alive, 100.  
 Cattle steamers, 98.  
 Celtic's gas works, 91.  
 Chargeurs Réunis, 132.  
 Chart track of Atlantic routes,  
     155.  
 China, ss., Cunard, 34.  
     cabin plans, 34.  
     engines of, 176.  
 Circassia, Anchor Line, first dead  
     meat, 63.  
 Circulating engines, 196.  
 City of Berlin, ss., 54.  
 City of Brussels, description of, 52.  
     loss of, 54.  
     rapid passage of, 50.  
 City of Glasgow, 45, 46.  
 City of Manchester, 48, 237.  
 City of New York, saloon of, 165.  
 City of Paris, first, 50.  
     second, 58.  
     ,, accident to, 60.  
     ,, bulkheads of, 56.  
     ,, engines of, 182.  
     ,, passage of, 225.  
     ,, saloon, 165.  
 Clearing a vessel, 150.  
 Clermont, early steamer, 3.  
 Clyde Screw Steam-Packet Com-  
     pany, 257.  
 Collins, E. K., life of, 206.  
 Collins Line, 41, 251.  
 Columbia, ss., Cunard Line, 22.  
     Hamburg American Line, 122.  
 Combustion, 195.  
 Commanders of Atlantic liners,  
     265.  
 Compagnie Bordelaise, 132.  
     ,, Commerciale, 132.  
     ,, Générale Transatlan-  
         tique, 130.  
 Compound engines first used, 68.  
 Condensation, 197.

Const  
 A  
 A  
 A  
 B  
 B  
 B  
 C  
 C  
 C  
 C  
 E  
 G  
 G  
 O  
 O  
 S  
 su  
 T  
  
 Cost o  
 pu  
 Crews  
 Cunard  
 re  
 Cunard  
  
 Dakot  
 Danm  
 Dead  
  
 Death  
 Deck c  
 Deck p  
 B  
 C  
 C  
 Ci  
 Et  
 Oc  
 Te  
 U  
  
 Descrip  
 Diagram  
 Dimen

- Consumption of America, 68, 87.  
 Arctic, 41.  
 Arizona, 73.  
 Asia, 76.  
 Britannia, 23.  
 Britannic, 83, 86, 87.  
 British King, 96.  
 City of Berlin, 54.  
 City of Brussels, 52.  
 City of Paris, first, 52.  
 Etruria, 38.  
 Great Eastern, 241.  
 Great Western, 15.  
 of new Cunards, 293.  
 Oregon, 74, 87.  
 Scotia, 32.  
 sundry vessels, 273.  
 Teutonic, 196.
- Cost of Atlantic liners, 267.  
 propellers, 188.
- Crews of Atlantic liners, 265.
- Cunard Line, 21, 249, 293.  
 reconstituted, 40.
- Cunard, Sir Samuel, life of, 202.
- Dakota, Guion Line, 72.
- Danmark, loss of, 132.
- Dead meat trade commenced,  
 100.
- Deaths on emigrant ships, 247.
- Deck department, 135, 138.
- Deck plan of Britannia, 22.  
 Britannic, 80.  
 China, 34.  
 City of Paris, 60.  
 Etruria, 38.  
 Oceanic, 80.  
 Teutonic, 98.  
 Umbria, 38.
- Description of diagram, 270.
- Diagram of Atlantic liners, *end*.
- Dimensions of Atlantic steamers,  
 table of, 280.
- Displacement of City of Paris,  
 greatest, 272.
- Divisions of City of Paris, 56.
- Doctors to be carried, 248.
- Dominion Line, 110.
- Donaldson Line, 118.
- Doran, J. S., supt. of Inman Line,  
 229.
- Dramatic Line, fastest passage,  
 269.
- Dreadnought, sailing ship, 1, 2.
- Duties of heads of departments,  
 134.
- Eagle Line, 122.
- Early Atlantic steamers, 1.  
 Events, 231.
- Eastern Steam Navigation Com-  
 pany, 239.
- Elder, John, life of, 224.
- Electric light introduced, 55.
- Embarkation, 150.
- Emigrants first carried, 50.  
 on sailing ships, 246.
- End of Arctic's career, 43.  
 City of Brussels's career, 54.  
 Great Britain's career, 120.  
 Great Eastern's career, 120.  
 Great Western's career, 15.  
 Great Liverpool's career, 13.  
 Oregon's career, 37.  
 President's career, 16.
- Engineering department, 137
- Engine-room staff, 137.
- Engines of Aller, 127.  
 Arctic, 174.  
 China, 34.  
 City of Paris, 182.  
 Etna, 176.  
 Martello, 113.  
 Montana, 178, 180.  
 Oceanic, 81, 82.  
 Teutonic, 189.

- Engines, two-crank compound, 181.
- Etruria, ss., Cunard Line, 38.
- Eventful passages and scenes, 259.
- Expenses of Atlantic liners, 265.
- Experiences on board Atlantic liners, 154, 157.
- Fabre Line, 132.
- Fastest average passages, table of, 286.
- Fastest passages, table of, 286.
- Feed water, quantity used, 195.
- First steamer, 2.
  - Atlantic steamer, 3.
  - Clyde steamer, 3.
  - Atlantic steamer from Liverpool, 5.
  - water-tight bulkheads, 5.
  - English Atlantic steamer, 13.
  - steamer missing, 16.
  - iron steamer, 16, 49.
  - screw-propelled, 16, 49.
  - Cunard liner, 23.
  - Atlantic screw Cunard steamer, 34.
  - steel Atlantic steamer, 36.
  - American liner, 41.
  - Inman liner, 46.
  - steam steering-gear, 52.
  - National liner, 67.
  - Guion liner, 70.
  - compound engines, 70.
  - saloon amidships, 80.
  - White Star liner, 80.
  - New Zealand liner, 94.
  - Atlantic triple engines, 113.
  - Atlantic twin screw, 117.
  - Hamburg American liner, 121.
  - North German liner, 124.
  - Atlantic Express triple engines, 126.
  - cost of Atlantic liners, 269, 280.
- Fitch, John, 3.
- Five days' Atlantic passage, 268.
- Flags of Atlantic lines, 292.
- Fleet messengers of the Mersey, 277.
- Forced draught, 112, 188, 194.
- Form of clearing a vessel, 150.
- Freight department, duty of, 134.
- Friesland, ss., 130.
- Frozen meat carried, 63.
- Fulton's steamer, 3.
- Funnels of Atlantic Lines, 292.
- Furness Line, 118.
- First Bismarck, ss., 122.
- Future advances, 268, 278.
- Galway line, 66.
- Gas lighting used, 91.
- General dimensions of Atlantic liners, table of, 280.
- Germanic, ss., 83.
- Glasgow and New York screw steamers, 257.
- Great Britain, ss., 16, 120.
  - „ Eastern, 118, 120, 239.
  - „ Liverpool, 13.
  - „ Western, 15, 274.
  - „ Western Line, 113.
- Greatest average speed per hour,
  - paddles, 273.
  - average speed per hour, single screw, 273.
  - average speed per hour, twin screw, 273.
  - daily consumption, paddle, 273.
  - daily consumption, single screw, 273.
  - displacement afloat, 272.
  - distance run in one day, 275.
  - indicated horse-power, paddles, 118.

Great

in

Guion

Guion

Halif

Haml

Harla

Hebsc

High

av

av

co

co

st

Hollan

Hollo

Horsb

Horse-

Howd

Hughe

Hydra

Ice at

Immen

Improv

Inurie,

Inman

Inman

Inside

Inspect

- Greatest indicated horse-power, single screw, 38.  
indicated horse-power, twin screw, 273.
- Guion Line, 70.  
Guion, S. B., life of, 212.
- Halifax steam squadron, 26.  
Hamburg American Line, 121.  
Harland, Sir E. J., life of, 220.  
Hebson, D., supt. Inman line, 229.  
Highest average speed per hour, paddles, 273.  
average speed per hour, screw, 273.  
average speed per hour, twin screw, 273.  
consumption per day, paddles, 273.  
consumption per day, screw, 273.  
steam pressure, 273.
- Holland ss., 70.  
Hollow shafting adopted, 58.  
Horsburgh, S. G., supt. White Star Line, 230.  
Horse-power, 195, 272.  
Howden's forced draught, 112, 189, 194.  
Hughes, J., memoir of, 230.  
Hydraulic system first adopted in the Atlantic trade, 60.
- Ice at Boston, 24.  
Immense ocean steamers, 239.  
Improvements by White Star Line, 90.  
Imrie, W., becomes partner with Mr. Ismay, 216.  
Inman Line, 45, 256.  
Inman, William, life of, 210.  
Inside department, 133.  
Inspection, Board of Trade, 145.
- International Navigation Company, 62.  
Invention of screw-propeller, 32.  
Iron hulls, 235.  
Iron steamers, first, 16, 50.  
v. wood, 235.  
Irwin, Thomas F., supt. Inman Line, 229.  
Ismay, Imrie and Co., 78, 100.  
Ismay, T. H., life of, 216.
- Johnstone Line, 116.  
Jordan, supt. Guion Line, 230.  
Journal of Commerce, 87.
- Kirk, A. C., life of, 226.
- La Normandie, ss., 130.  
Lardner, Dr., saying of, 20.  
Largest steamer afloat, 96.  
steamer ever built, 118.  
steamer proposed, new Cunard, 279.
- Last iron paddle-steamer, 32.  
paddle-wheel built, 32.  
wooden paddle-steamer, 43.
- Leyland Line, 115.  
Life of Sir George Burns, 202.  
of E. K. Collins, 206.  
of Sir Samuel Cunard, 202.  
of John Elder, 224.  
of S. B. Guion, 212.  
of Sir E. J. Harland, 220.  
of W. Inman, 210.  
of Thos. H. Ismay, 216.  
of A. C. Kirk, 226.  
of C. MacIver, 212.  
of D. MacIver, 204.  
of R. Napier, 204.  
of Sir W. Pearce, 214.  
of J. Spence, 218.  
of J. R. Thomson, 222.  
on Atlantic steamers, 153.



- Limbers, 146.  
 Link motion of engines, 191.  
 Live cattle first carried, 100.  
 "Liverpool Albion," 24, 26, 30, 237, 248.  
 "Liverpool Daily Post," 77, 100.  
 "Liverpool Mercury," 6, 23, 45, 269, 274.  
 Liverpool and Philadelphia Steamship Company, 258.  
 Liverpool, first Atlantic steamer from, 5.  
   landing stage, 151.  
   steamship, 6, 7.  
   steamship, sailing of, 11.  
 Liverpool and St. John's Packets, 258.  
 Logan, —, supt. Cunard Line, 228.  
 London lines, 116.  
 Loss of Arctic, 43.  
   of City of Brussels, 54.  
   of City of Paris, first, 52.  
   of Dakota, 72.  
   of Montana, 72.  
   of Oregon, 37.  
   of Pacific, 43.  
   of President, 16.  
 Losses, table of, 287.  
 Louisiana, ss., 67.  
 Lowering propeller, 92.  
 Lowest steam pressure, 273.  
 Machinery of Atlantic liners, 173.  
 MacIver, Charles, 212.  
 MacIver, David, 204.  
 MacIver, withdrawal of Messrs., 40.  
 Mail steamers at war time, 263.  
 Majestic, ss., 96, 187, 189, 275.  
 Manchester, City of, ss., 46.  
 Manganese bronze propellers, 186.  
 Manhattan, ss., first Guion, 70, 113.  
 Manning of Atlantic liners, 265.  
 Manning when in Admiralty service, 106.  
 Martello, ss., 113.  
 Matters examined by surveyors, 146.  
 Maury's Lanes, 155.  
 Meat trade, 63.  
 Men of the Atlantic Ferry, 202.  
 "Mercury, Liverpool," 6, 23, 45, 269, 274.  
 Monarch Line, 116.  
 Montana, ss., 72, 178.  
 Names of Commanders, 265.  
 Napier, Robert, builds Persia, 32.  
 Napier, Robert, life of, 204.  
 National Line, 67.  
 Netherland American Line, 132.  
 New Cunard vessels, 1892, 279.  
 New York and Havre Steam Navigation Company, 44.  
 New York, City of, ss., 58, 165.  
 New Zealand Line, 94.  
 Night signals of Atlantic lines, 292.  
 Nomadic, ss., 98.  
 Normannia, ss., 122.  
 North German Line, 124.  
 Notting Hill, ss., 117.  
 Oceanic, ss., 80.  
   cabin plans of, 80.  
 Oceanic Steam Navigation Company, 77.  
 Ocean Steam Navigation Company, 44.  
 Ocean voyage, the, 157.  
 Officers' positions, leaving port, 153.  
 Ohio, ss., 112.  
 Old and new Atlantic steamers, 84.  
 Oldest Atlantic steamer existing, 113.

560  
 Ore  
 Osc  
 Out  
 Ove  
 Ove  
 Pac  
 Pac  
 Pad  
 Pad  
 Pad  
 Pale  
 Pas  
 Pass  
 Pass  
 Pear  
 Pers  
 Petr  
 Pilot  
 Pirri  
 Pres  
 Prop  
 i  
 f  
 Purv  
 Purv  
 Rapi  
 Rate  
 Red  
 Red  
 Refri

- Oregon, ss., 37, 74, 87.
- Oscillating saloon, 92.
- Outside section, duties of, 130.
- Overlapping propellers, 186.
- Overhauling in port, 135.
  
- Pacific, loss of, 43.
- Packets for New York, 252.
- Paddles, average speed of, 273.
  - greatest horse-power, 272.
  - v. screw, 238.
- Paddle-steamers, highest average speed, 273.
  - highest consumption of, 273.
- Paddle-wheels, first, 2.
- Palestine, oldest steamer, 113.
- Passages of sailing ships, 1, 2, 274.
- Passages, table of, 27, 28, 29, 238, 239, 274, 282, 284, 285.
- Passenger certificate, 146.
  - department, 143.
- Pearce, Sir William, life of, 214.
- Persia, ss., Cunard, 30, 32.
- Petroleum in bulk, 128.
- Pilot, 152.
- Pirrie, W. J., partner in Harland and Wolff's, 222.
- President, steamer, 16.
- Propeller, 194.
  - invention of, 32.
  - first, 16.
- Purves' boiler flues, 183.
- Purves, J., supt. Inman Line, 229.
  
- Rapid passages of Atlantic liners, table of, 282.
- Rates for hire by Admiralty, 102, 109.
- Red Cross Line of Packets, 254.
- Red Star Line, 128.
- Refrigerating machinery adopted, 63, 226, 193, 198.
  
- Release of Britannia from ice, 25.
- Republic, stormy passage of, 259.
- Rescue from Danmark, 132.
- Review of tables, 275.
- Royal William, steamer, 5.
- Russia, Cunard, ss., 34.
  
- Safety of Atlantic, Collins Line, 233.
- Sailing of a Liner, 149.
- Sailing ships, 1, 2, 243, 252, 274.
- Sail-power, disuse of, 60.
- Sale of America, National Line, 70.
- Sarah Sands, ss., 257.
- Savannah, steamer, 3.
- Scotia, Cunard Line, 32.
- Screw v. paddles, 237.
- Screw engines with gearing, 175.
  - direct-acting, 178.
- Servia, ss., Cunard Line, 35.
  - damage to, 262.
- Single screw steamers, average speed of, 273.
  - greatest consumption, 273.
  - greatest horse-power, 273.
- Sirius, steamer, 13.
- Société Anonyme Belge-Américaine, 128.
- South Wales Atlantic Steamship Company, 112.
- Spence, James, life of, 218.
- Staff at Works, 138.
  - on board at sea, 266.
  - on board in port, 145.
- State Line, 112.
- Steamers lost, table of, 287.
- Steam-pipe, Britannia, Cunard Line, bursts, 173.
- Steamships for Australia, estimate for, 241.
- Steam steering gears first used, 52.

- Stern of single screw steamer, 185.  
   of City of New York, 59.  
   of Teutonic, 186.  
   with lowering propeller, 92.  
 Steward's department, 135.  
 St. George Line of Packets, 255.  
 St. John's and Liverpool Packets,  
   258.  
 Stores for Atlantic steamers, 294.  
 Struck by a sea, 259.  
 Subsidy, Cunard Line, 21.  
   Admiralty, 108.  
 Superintending engineers, 228.  
 Surface condensers, 13, 34.  
 Surgeons to be carried, 248.  
 Swallow Tail Line, fastest pas-  
   sage, 269.  
 Symington's new boat, 231.  
 Synopsis of Atlantic Records, ix.  
  
 Tables, Review of, 273.  
 Tapscott's Packets, 252.  
 Teutonic, 96, 187, 189, 275.  
   stern of, 186.  
 Thingvalla Line, 132.  
 Thomson, J. R., life of, 222.  
 Thomson, Robert, supt. engineer  
   Cunard Line, 228.  
 Three-crank engines adopted, 73.  
 Track chart, Atlantic Ocean, 155.  
 Transatlantique Line, 130.  
 Triple expansion engines of—  
   Aller, 126.  
   Martello, 113.  
   City of Paris, 182.  
   Teutonic, 189.  
  
 Twin screws adopted, 117.  
   screw, City of New York, 59.  
   screw, greatest horse-power,  
     273.  
   screw, highest speed of, 273.  
   Screw Line, 117.  
   screw, Teutonic, 187.  
  
 Umbria, ss., 38, 273, 275.  
   deck plan of, 38.  
 United States authorities, 149.  
   Mail steamers, 251.  
 Unprecedented record, 87.  
  
 Value of Atlantic steamers, 102,  
   109, 267, 294.  
 Vaterland, ss., 128.  
 Vesta sinks Arctic, 43.  
 Victualling department, 140.  
 Victualling for an Atlantic round  
   trip, 294.  
  
 Wallace, William, supt. engineer  
   Allan Line, 229.  
 Warren Line, 113.  
 Water required for boilers, Atlan-  
   tic trip, 195.  
 Water-tight bulkheads, first, 5.  
 White Star Line, 77.  
 Wilson Line, 113.  
 Wilson, W. H., partner of Har-  
   land and Wolff, 222.  
 Wolff, G. W., shipbuilder, 222.  
 Working of Atlantic liners, 113.  
 Wyoming, ss., 70.

17.  
York, 59.  
se-power,  
l of, 273.

7.  
5.  
es, 149.

7.  
ners, 102,

140.  
tic round

engineer

s, Atlan-  
first, 5.

of Har-  
2.  
r, 222.  
rs, 113.

