

PAGES

MISSING

The Canadian Engineer

A weekly paper for Canadian civil engineers and contractors

DOMINION LAND SURVEY MONUMENTS

SUMMARY OF A SCHEDULE SHOWING THE VARIOUS CHANGES THAT HAVE OCCURRED SINCE 1871 IN CHARACTER OF MONUMENTS USED IN DOMINION LANDS SURVEYS.

By H. L. SEYMOUR, B.A.Sc., D.L.S.,
Topographical Surveys Branch, Dept. of Interior, Ottawa.

SOME time ago the writer had the opportunity of preparing a schedule showing the various changes that have occurred since the year 1871 in the character of monuments used for marking township, section and quarter section corners in the Dominion Lands System of Survey.

In general, official survey monuments have consisted of one, or a combination of several, of the following: (1) Wooden post, (2) iron post, (3) earth mound, (4) stone mound, (5) pits (or trench in the case of most witness monuments).

As each new edition of the Manual of Instructions for the Survey of Dominion Lands was issued by the surveyor-general, various changes, more or less important, relative to each component part, or to the character of the monument as a whole, were called for. As an example, the case of witness mounds might be cited. Bearing trees alone or an ordinary mound and pits not necessarily on a surveyed line were at one time permitted. Subsequently wooden, and then iron, posts in connection with witness mounds have occupied positions in the centre and at the edge of the mound and in the trench of varying width surrounding the mound.

But of general importance is the relation of the post, which generally marked the corner, to the mound and pits which frequently referenced it. In such a monument the relative importance of the component parts are probably post, pits, mound. But experience has shown that the post and then the mound (or vice versa) frequently disappear leaving only, after some years, traces of pits to

original survey and further knowing what instructions were issued to govern the erection of monuments at that date.

On the official plans of townships now issued sufficient information is given to show at what date a monument was erected or renewed. The very condensed general statement to follow, it is hoped, will be of use not

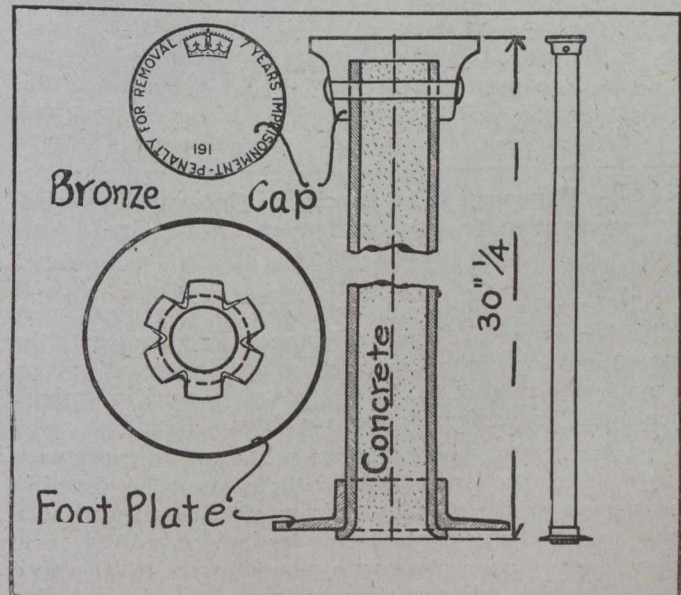

Fig. 2.—Standard Survey Post, 1916.

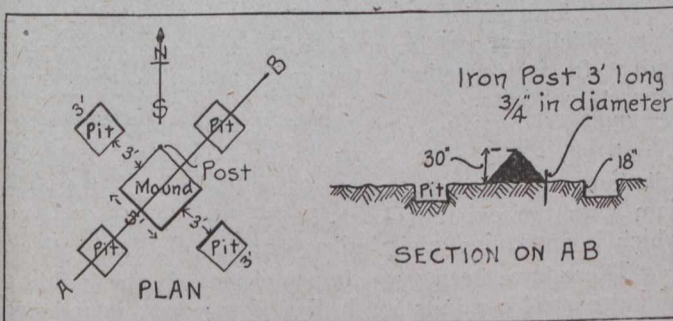

Fig. 1.—Monument at Ordinary Section Corner in Wooded Country, 1908-1915.

reference the corner. Unfortunately, the mound and pits did not in the past always occupy a constant relation to the post and when traces of pits or any other part of an obliterated monument (except the post) are found, doubt of the true position of the corner (within several feet) can in some cases only be dispelled by finding the date of the

only to surveyors for whom information on a more elaborate and detailed scale has been or is being prepared, but to engineers who occasionally have more interest in land boundaries or land ties than the actual fence lines. The information is abstracted from the schedule previously referred to, which in turn was compiled from information contained in the annual reports of the surveyor-general for the years 1882, 1886 and 1908 and from the different editions of the Manual of Survey published in the years 1871, 1881, 1883, 1890 (preliminary 4th edition), 1892, 1903, 1905, 1910 and 1913. There can, of course, be no guarantee that the surveyor has always closely followed his instructions. In some cases the surveyor's field book shows that he did not. Further, monuments on the ground were sometimes not as shown in his notes.

According to instructions issued to surveyors, iron posts at township corners (since 1881 instructions have called for iron posts at all township corners) were, when mounds were erected, never to be placed in the centres of the mounds (except in the case of stone mounds erected

since 1913 and where posts could not be driven) but at the northerly angle thereof, except on correction lines, the lines between different systems of survey, the outer limits of the roads around Indian reserves, and generally all lines the posts on which marked the boundaries of lands on one side only of the line, in which cases the post was to be placed in the centre of one side of the base of the mound. Up to 1915, in which year some posts were still placed as above described, no change was made in the instructions in this regard.

Iron posts with tins on which were marked the numbers of the sections were placed in the centres of the mounds at section corners on the prairie from 1882 to 1889. Instructions issued for the season of 1887 were to the effect that no more earth mounds, but pits only, were to be erected on the prairie; the practice of erecting earth mounds was not, however, entirely discontinued for some time. The manual issued in 1890 called for iron posts and pits only at section corners on the prairie.

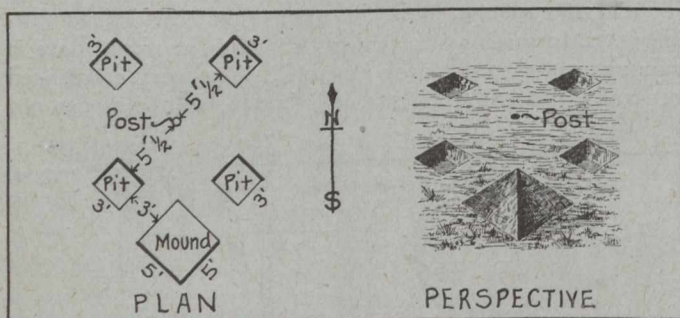

Fig. 3.—Monument to be Erected at Ordinary Township, Section or Quarter Section Corners in Wooded Country, 1916.

In wooded country no mounds or iron posts were called for by instructions until 1890. After that date the instructions for the positions of iron posts at section corners with respect to the mounds were similar to those mentioned above for township corners. (See Fig. 1.)

Up to 1881, where wooden posts and mounds were used, the instructions called for the posts to be placed in the centres of the mounds. From 1882 to 1889 wooden posts were to be used at quarter section corners only, and where used in connection with mounds were to be placed in the centres. From 1890 to 1900 inclusive wooden posts were still used at quarter section corners only, but were to be placed in the same relation to the mounds when erected, as in the case of iron posts at township or section corners. Since 1908 no wooden posts have been used except in muskegs, sloughs or shallow lakes.

The directions now given surveyors for the establishment of monuments of original surveys have been in force since about the middle of the season of 1915. Prior to that date it was the practice to have a mound, when erected, occupy a position midway between the four pits, in which case a post planted at the northerly angle of the mound was *not* in the desirable position of midway between the pits, formerly the most permanent part of the monument.

A boundary monument now generally consists of a standard survey post placed with its bronze cap flush with the ground. It is planted midway between four pits or in the centre of a circular trench with or without a mound. (See Figs. 2 and 3.)

The standard survey post, weighing seven pounds, consists of a piece of one-inch butt-welded iron pipe, 30 inches in length, filled with concrete. A malleable iron

foot plate $3\frac{1}{2}$ inches in diameter, and a bronze cap $2\frac{1}{2}$ inches in diameter, are fastened to the bottom and top of the post respectively. By such an arrangement and due to the fact that the cap is flush with the ground the chance of the post being removed or displaced is very small, indeed.

A pit is still to be made three feet square and eighteen inches deep, and as in the past, when pits only were dug, the nearest edge of the pit is to be $5\frac{1}{2}$ feet from the post.

When, however, a mound is now erected it generally occupies a position such that its centre is about ten feet due south from the post marking the corner. For any corner the mound is to be made five feet square, as has been the case in the past for section and quarter section monuments, but mounds at township corners were formerly made six feet square.

There is now, for the first time in the history of D.L.S. monuments, no difference whatever in the character of monuments marking township, section or quarter section corner. Legally it is understood no distinction is made between a quarter section corner or a township corner; each is equally important. It is fitting, therefore, that monuments marking different corners should differ only as to the markings on the posts and not as to their general character.

STEEL PIPE CONDUIT AT LOCH RAVEN, MD.*

By Ezra B. Whitman, C.E.
Consulting Engineer, Baltimore, Md.

THE city of Baltimore, Md., has been making extensive improvements in its water supply during the past three years. The old supply was inadequate in quantity and its quality was of such nature that it was a menace to the health of the city. In order to increase the available water supply it was decided to build an impounding reservoir on the Gunpowder River, the stream from which the supply was taken before the improvements were begun. It was further decided in order to improve the quality of this water to install a filtration plant. The new dam has been completed and the filtration plant is now in operation.

In addition to these two main propositions, there were a number of supplementary works which were of considerable magnitude, including the building of five miles of road, one bridge 600 ft. long, another bridge 1,000 ft. long and the construction of a number of conduits which were 48-in. and 60-in. cast iron pipe, 7-ft. and 10-ft. steel conduits, and 7-ft. and 9-ft. reinforced concrete conduits.

The 7-ft. and the 10-ft. steel conduits have just been completed. The 10-ft. steel conduit is about one-half mile long and connects the waters of the new Loch Raven dam with the existing Loch Raven-Montebello Tunnel, which is approximately 7 miles long and 12 ft. in diam.

There have been great improvements in the building of large steel conduits in the last few years, introduced in the building of the aqueduct leading the water from the Catskill Mountains to New York City.

In steel pipe lines protected with various paints, asphalts and enamels, trouble has been experienced with corrosion, tuberculation and pin-hole leakage. In order to overcome these difficulties the engineers of the New York Board of Water Supply after a number of experi-

(Continued on page 441.)

*Abstract of article in The Cornell Civil Engineer.

THE ENGINEER IN CANADA

SPEECH DELIVERED LAST THURSDAY AT A LUNCHEON OF THE OTTAWA BRANCH, CANADIAN SOCIETY OF CIVIL ENGINEERS — CANADIAN ENGINEERS HAVE ESTABLISHED REPUTATION FOR HONOR AND ABILITY.

By SIR WILFRID LAURIER, P.C., G.C.M.G.,

Formerly Prime Minister of Canada.

I THANK you that it is to-day my privilege to sit with you at this hospitable board, and I hasten to offer to you, sir, and to the members of the Canadian Society of Civil Engineers, a sincere expression of my gratitude for the honor of the invitation with which you have favored me. I appreciate it all the more that I am here with none of the trammels and trappings of office! I come to you, as you are yourselves, a humble citizen of Canada, and the only bond of union which I know at this time between you and me is that whilst you have the pride of the profession which you embraced in your younger days, I, for my part, have the pride of the achievements of the engineers of Canada.

Sir, you have just told me that I am 75 years young which, I am bound to say, is a flattery which I cannot accept. I am 75 years old. That is the fact. I cannot help it and therefore why should I disguise it? I am 75 years old, but I have this to say: that I ought to be thankful to Providence that my eye is still clear and, if you will permit me to refer to a subject to which I shall not further allude, I think I have yet a few kicks in my body!

In the course of a long career which has been devoted to the public service as I have understood it, it was my proud fortune to come in contact, and sometimes in very close contact, with some of the engineers of the past, all able men, all men of the greatest eminence, all men held in the highest respect, not only within the sphere of their own immediate calling but within the broader circle of Canadian citizenship. I refer to the dead alone; I refer to such men as Frank Shanly, Thomas C. Keefer, John Page and Toussaint Trudeau; and if I were privileged to speak of the living, I could not help mentioning the name of my very old and dear friend, Sir Collingwood Schreiber, whom I am so glad to see at this board to-day.

All these men were connected in their day with all the great works on the St. Lawrence and the Great Lakes.—bridges, canals, wharves and other works which uplifted Canada from a position not very far removed from that of primitive savagery, to the proud position which it now occupies in the eyes of the civilized world. The labors of these men showed that even in those early days in our country, Canadian engineers were the peers of the engineers in any part of the world. They do not claim to be the superiors, but they do claim to be the equals, and it is with much reason that they make that claim. They do not fear rivalry from any quarter from which it may come. In our own day we have had evidence that when engineers are brought in from other lands the work is not done better but that, on the contrary, it is not done as well as if it had been undertaken by our own engineers.

May I recall a fact with which I am, unfortunately, but too well acquainted? When the Quebec Bridge Co. undertook to construct the bridge across the St. Lawrence, it was seen to be a work of such magnitude that many believed that the resources of engineering science in our own country would not be adequate, and the board of

management of the company entrusted the building of the bridge to an American firm. The plans of the bridge were designed by an American engineer, an engineer of great eminence, undoubtedly, an engineer of great renown, who had had a large career in bridge engineering and who was supposed to be the highest authority in that branch of engineering science. His plans were accepted—I will show you why by-and-by—and you know the result. The story is always present to our minds; at all events it is always present to mine. Before the first span of the bridge had been completed it dropped into the St. Lawrence under its own weight, conclusively showing that the plans were defective, a fact which was not disputed by even the engineer who was the author of those plans. For my part, as a Canadian, I may say in all sincerity, and I do not seek in any way to disguise it, the only consolation I have with regard to this accident is that the plan was not the work of a Canadian but of an American engineer.

But, sir, the poet has said that to err is human, to forgive divine. We forgave—that was the only thing to do—but we determined to try our luck anew and to try it under other auspices and circumstances. We determined to go on with the work at that time, but to transfer the enterprise from the hands of the company to the hands of the government of that day; that was in 1908. We determined this time to entrust the work to Canadian engineers and Canadian builders. Unfortunately, as you know, at the last moment an accident occurred; but the accident showed, and showed conclusively,—and this is a fact of which we all as Canadians must be proud,—that it was not due to any fault in the design of the bridge, because the bridge structure remained as solid as the rocks on the shore under the terrible strain which was put upon it by the sudden drop of the central span. We have the most conclusive evidence, and it is a fact which was not only evident to those who were present on that fatal day, but which has been proved by actual examination, that no fault is to be attributed to the engineers. The accident was due to a flaw in the metal. From all this I think there is to-day a lesson to be drawn, and that lesson is that it is folly to go abroad to seek what we can find at home. We can make a mistake once—that is pardonable—but it is unpardonable to make the same mistake a second time.

I do not belong to your profession, but I honor it not only because it is the profession of engineering but because the engineers are fellow-countrymen of my own and we are Canadians all. Canadian engineers do not pretend, do not claim, any superiority over the engineers of any other country; neither will they admit inferiority to the engineers of any other country. They claim that they are equal to the highest development of engineering science to this day; or, if they are too modest to claim it, I claim it for them. That is my view and I express it as I feel it, not only in your presence but I would be glad to do so wherever my voice can be heard in any part

of Canada. I make this claim for the engineers of Canada: that they are the equals of American, of British, of French or German engineers.

There is something more which I claim for the engineers of Canada. I claim for the engineers of Canada not only ability but character, and by character I understand honesty and honor. I was for fifteen years the prime minister of this country, and in connection with public works under the charge of the government over which I presided, I had a great deal to do with Canadian engineers, and it is my proud testimony to say that I always found that the Canadian engineer could be depended upon for honor and honesty.

Honor and honesty were characteristics of those engineers whose names I selected from a great number and whose names I have just given to you. Their honor and honesty were such that, when I had the responsibility of office, if I saw the signature of Mr. Collingwood Schreiber or any other Canadian engineer upon a report or plan, I knew that it meant that there was the truth and that the work might be proceeded with. Honor and honesty are required in every branch, in every part, of our life but honor and honesty are perhaps more required in the engineering profession than in any other calling.

It is characteristic of the work of your profession that the work of the engineer cannot be intelligently criticized or approved by the layman who commands the work. The plans, the calculations of the engineer, when they are brought before the unpracticed eye of the layman who has to do with the work—I speak at all events for myself as a humble layman—present nothing to him but what he regards as a jumble of lines and figures. He can look but he cannot pronounce upon them; he cannot undertake to say that the lines are too long or too short, that the angles are too sharp or too obtuse or that the calculations are right or wrong. It is not so in many other lines or in many other arts and sciences.

Take the case of architecture. If I employ an architect to put up a building for me, he brings me his plans, I look at them and I can see whether or not they please me. I can sit down and discuss and argue with him. I can say to him, "I do not like this curve." And he can answer me and say, "You are wrong; you do not know the accepted canons in that respect; if I were to do the work as you suggest, I would make a bad job of it." Even if I could not convince him, I could at all events give him my views. But, if I employ an engineer to prepare for me a plan of a conduit or a canal, and he brings to me his designs, his lines and profiles, I will be a very presumptuous man if I undertake to say that his calculations and lines are wrong. We have to depend upon the ability and character of the engineer to do this work for us, and whenever I had to depend upon a plan put before me by a Canadian engineer, I proceeded on that plan which was put before me and which represented the sum total of engineering science backed by a firm and rugged honesty. I asked no more and never was deceived. Ability and character are, not only to my knowledge, but in my experience, the double attributes of Canadian engineering. Canadian engineers have always lived up to that double standard according to my observation and experience. They have always held these characteristics up as the standards by which they desired to be judged, not only for themselves but also, may I say, for the fair name and fame of Canada, our country whose name and fame must always remain dear to all the sons of Canada.

Now, Mr. Chairman, you have been kind enough in your introductory remarks to speak of my age. I shall

not refer to that; but you have been kind enough also to mention the name of my wife, and for that I cannot be sufficiently grateful to you. You all know—I suppose most of you do—the blessing of a good wife. I have had that blessing during a very long life. Now, I have to cut my remarks short because, pleasant as this occasion has been and thankful as I am for the opportunity of being with you, I am going to something even better than a banquet with the engineers—I am going to a wedding.

(See page 439 for report of Ottawa Branch meeting.)

ST. LAWRENCE RIVER IMPROVEMENTS.

An interesting anonymous letter signed "Engineer" appeared last week in the Daily Mail of Montreal, discussing the proposed improvements to the lower St. Lawrence River. While anonymous letters are entirely wrong in principle and should be treated with suspicion, there is information in this particular letter which makes it of interest to Canadian engineers and contractors. The text of the letter is as follows:—

"In 1913, the Federal Government, urged by the shipping men of Montreal, appointed a commission composed of Messrs. E. E. Haskell, of Cornell University, W. S. Stewart, chief hydrographer, and V. F. W. Forneret, engineer in charge of the ship channel, to investigate the water levels of the St. Lawrence River below Montreal. Early in 1915, these gentlemen reported that the general level of the river had subsided with a consequent loss of depth in the ship channel. To restore the level they recommended the construction of one partial dam at Repentigny, one partial dam at the foot of Lake St. Peter and the blocking of five of the channels between the Sorel Islands:

"In the fall of the same year Mr. Arthur Surveyer, consulting engineer of Montreal, when called upon to appreciate the commissioners' recommendations, declared that the remedial works suggested would not solve the problem and that the loss of level in the river had been too great to be successfully restored and maintained by partial dams. He advised that the best solution would be the building of dams and locks, concentrating the falls at the locks and creating slackwater navigation above the point of damming.

"Later, Mr. Walter Francis, consulting engineer of Montreal, and also Professor C. H. McLeod, of McGill University, were asked to pass judgment on the remedial works recommended by Messrs. Haskell, Stewart and Forneret. Early in 1916, these two gentlemen submitted separate reports in which they thoroughly condemned the commissioners' project and declared that locking and damming was the only logical solution of the problem.

"The shipping interests have always viewed with apprehension the proposition to partially block the St. Lawrence River and are inclined to favor the blocking of the river from shore to shore with the construction of the necessary locks. The government is in a quandary; they have the unanimous report of Messrs. Haskell, Stewart and Forneret recommending the construction of this partial damming of the river and they have also three independent reports, prepared by engineers of standing, condemning the project in no uncertain terms and recommending that locking and damming be adopted. The shipping men are naturally anxious to have the question settled and they feel that the appointment of another commission of engineers is the only way out of the dilemma."

THE RELATION OF PURE SCIENCE TO INDUSTRIAL RESEARCH.*

By J. J. Carty,

Chief Engineer, American Telephone and Telegraph Co.

THE writer traces the growing appreciation of the importance of industrial scientific research primarily to the events in Europe, and the recognition of the unpreparedness of the United States to defend itself against attack. Industrial research conducted in accordance with the principles of science is no new thing in America. The engineering department of the American Telephone and Telegraph Company, under the charge of the speaker, was founded nearly forty years ago to develop, with the aid of scientific men, the telephone art, and has grown from small beginnings to a great institution employing hundreds of scientists and engineers. It is generally acknowledged that to industrial research thus conducted we are largely indebted for the telephone achievements in America being so greatly above those of other countries.

The same applies to the development of electric light, electric power and electric traction. Vast sums are being spent annually upon industrial research by some of the larger electrical manufacturing concerns, but the speaker says with authority that these laboratories return to the industries each year improvements in the art which, taken altogether, have a value many times greater than the total cost of their production. Money expended in properly directed industrial research conducted on scientific principles is sure to bring to the industries a most generous return.

Industrial scientific research departments can reach their highest development in those concerns doing the largest amount of business, and small concerns without co-operation among themselves cannot have the full benefit of industrial research, for no one among them is sufficiently strong to maintain the necessary staff and laboratories. But once the vital importance of this subject is appreciated by the small manufacturers, many solutions of the problem will promptly appear. One of these is for the manufacturer to take his problem to one of the industrial research laboratories already established for the purpose of serving those who cannot afford a laboratory of their own. There are now under consideration many plans for the establishment of industrial laboratories to serve concerns which cannot afford laboratories of their own, and in some cases the possible relation of these laboratories to our technical and engineering schools is being earnestly studied.

But until the manufacturers themselves are aroused to the necessity of action in the matter of industrial research, no plan can be devised that will result in the general establishment of research laboratories for the industries.

In the present state of the world's development there is nothing which can do more to advance American industries than the adoption by our manufacturers generally of industrial research conducted on scientific principles. In the minds of many there is confusion between industrial scientific research and purely scientific research, particularly as the industrial research involves the use of advanced scientific methods and calls for the highest degree of scientific attainment. The distinction lies not in the subject-matter of the research but in the motive. In-

*Presidential address delivered before the American Institute of Electrical Engineers.

dustrial research is always conducted with the purpose of accomplishing some utilitarian end. Pure scientific research is conducted with a philosophical purpose for the discovery of truth and for the advancement of the boundaries of human knowledge. At the same time, while a single discovery in pure science, when considered with reference to any particular branch of industry may not appear to be of appreciable benefit, yet when interpreted by the industrial scientist, with whom may be classed the engineer and the industrial chemist, and when adapted to practical uses by them, the contributions of pure science as a whole become of incalculable value to all the industries.

But who is to support the researches of the pure scientist, to furnish the laboratories and the funds for apparatus, travelling and foreign study? It has been suggested that perhaps the theatre of scientific research might be shifted from the university to the great industrial laboratories which have already grown up, or to the even greater ones which the future is bound to bring forth. The speaker does not agree with this. Organizations and institutions of all kinds engaged in pure scientific research should receive every encouragement, but the natural home of pure science and of pure scientific research is to be found in the universities, from which it cannot pass. Instead of abdicating in their favor, our universities, stimulated by the wonderful achievements of these industrial laboratories, should find a way to advance the conduct of their own pure scientific research.

The universities, however, are not money-making institutions. Well, there is much that can be done without money. The most important and most fundamental factor in scientific research is the mind of a man suitably endowed by nature, and responsible university authorities should apply their judgment so that when the man with the required mental attributes does appear he may be appreciated as early in his career as possible.

While, however, there are many things and most important things which the universities can do to aid pure science without the employment of large sums of money, there are, nevertheless, a great many things required in the conduct of pure scientific research which can be done only with the aid of money, and the first of these is to provide a master scientist, when he does appear, with all the resources and facilities and assistance, so as to afford a full freedom of development to the range of his genius.

Workers in pure science should be located not only in our great universities, but also at our technical schools, where the influence of a discoverer in science would serve as a balance to the practical curriculum and familiarize the student with the high ideals of the pure scientist and with his rigorous methods of investigation.

The engineering student should be taught to appreciate the ultimate great practical importance of the results of pure scientific investigation and to realize that pure science furnishes to engineering the raw material, so to speak, which must be worked into useful forms. A better understanding is required of the relation between the pure scientist and the applied scientist, and this understanding would be greatly helped by a closer association between the pure scientist and the student in the technical schools.

In last week's issue reference was made to a producer gas plant built by the Nordberg Mfg. Co. for the Canadian Mining & Finance Co. at Gillies Lake, Ont. The item should have referred to this plant as a compressor plant instead of a producer gas plant. It contains two Nordberg compressors and one Fraser & Chalmers compressor, all three machines direct connected to electric motors.

EFFICIENCY IN CIVIC UNDERTAKINGS

A FIXED POLICY OF KEEPING ABREAST WITH ALL MODERN IMPROVEMENTS AND SECURING THE MAXIMUM POSSIBLE EFFICIENCY WILL YIELD HANDSOME RETURNS TO ANY MUNICIPALITY.

By ROBERT OWEN WYNNE-ROBERTS, M.Can.Soc.C.E., M.Am.Soc.C.E., M.Inst.C.E.,
Consulting Engineer, Toronto.

IT is remarkable how the European war has been instrumental in promoting efficiency in almost every sphere of human activity. Every belligerent nation is compelled by force of circumstances to pay attention to all details and to increase the efficiency of its military and civil organizations, for it is only in this way that the acknowledged power of the enemies can be combated. But every progressive nation also perceives that to maintain its position in the commercial struggle that will follow the declaration of peace, its efficiency from every standpoint must be not only maintained, but increased. A nation, after all, is only what her people make it. It is the aggregation of individual effort, aspiration and efficiency, and the direction of her power or weakness will be governed by the intelligence, loftiness and energy of the people.

Efficiency is by no means a new element in national life. The Romans and the Greeks were gripped by its attractiveness, according their national conceptions of its value. But the war has emphasized its immense importance not only to those engaged in the conflict, but also to the countries which are neutral and yet are shaken to the very foundations of commerce, finance and idealism. Efficiency demands the maximum results by the application of the best knowledge and experience that is available, and all who have observed will recognize what enormous strides have been made during the last two years in this connection.

Efficiency in civic undertakings is equally important. Health, comfort, convenience and prosperity depend upon the standard of civic administration. Democracy, however, has not been productive of efficient civic government to the extent that it might be expected. It would be natural to anticipate that the people would insist upon getting the maximum service of every dollar paid in taxes, that they would always elect representatives who were qualified by experience and knowledge to administer the affairs of the city, that efficiency would be the *sin qua non* of every voter, that all undertakings which help to build up a desirable city should be provided and efficiently maintained; in short, that everything necessary for the amenity, health progress, and beautifying of the city should be organized and arranged in the same manner as would be done by its most successful citizens.

This is perhaps too Utopian an idea to be realized under any democratic system of government, but nevertheless it is one which should be aimed at. The paradox is that whilst it is everybody's duty to secure the most efficient service, unfortunately functions of this category are generally neglected by most people because they are not always qualified to judge. The majority of the people are too busy with their own daily work to pay close attention to municipal affairs. They leave that duty for others to perform, and herein lies the weakness of our civic government as a general rule.

Our American friends endeavor to remedy this defect by a change in the form of government, more or less adapting the German system to meet American needs. The principal of referring matters and appointments to

the electorate, while truly democratic, does not lead to the goal of efficiency. We need some incentive for the people to elect their representatives strictly on their merits, and leave the business of technical, financial and other administrations in their hands to carry out to the best advantage of the city. The representatives should be encouraged to continue serving the city, because then their experience ripens, their knowledge expands, and their abilities become established.

Efficiency in executive management is to be attained when the officials are given a free hand to control the affairs of their department and given to understand that successful administration will merit reward. Economy does not mean parsimony; efficiency does not entail autocratic control. It is, of course, necessary to prescribe the policy and limitations of officials, but to circumscribe their operations by any unreasonable directions or desires of representatives who are not fully acquainted with the onerous and important duties devolving upon officials, oftentimes means inefficiency. The misfortune in such cases is that the officials are blamed for what is not their fault.

It is highly important that the health of the community should be conserved. This does not imply that the work devolves solely upon the medical officer of health, for the construction and maintenance of waterworks, sewers, sewage disposal plants, roads and other work are closely associated with the preservation of health. Pure water, clean surroundings, good housing, disposal of waste products of all kinds, etc., have a patent influence upon the standard of public health.

It is just as important to maintain the works efficiently as to build them efficiently, yet how often is it recorded that the operations are inefficient? Efficiency of design and construction means that the works are built in the best possible manner for the purpose intended, but all this may be wasted almost completely if efficiency does not take place in their maintenance and operation.

It is, however, a strange fact that maintenance does not appeal so strongly as construction. We all participate in the pleasure of building, and we desire to have beautiful homes. But we neglect to repair a small leak in the roof which may cause serious damage to our property. In the same manner neglect to maintain water filters in a constant state of efficiency has caused outbursts of sickness and loss of life for which money cannot compensate. Sewage works built on approved lines, if allowed to become inadequate or mismanaged, may be a source of annoyance and loss to the community. Roads, even when constructed in a most excellent manner, require efficient maintenance, so that the people may derive the full benefit from them.

It must not be implied by the foregoing observations that inefficiency prevails, for that is not the point the writer desires to impress. The term efficiency is a relative one. It is not possible to standardize efficiency, because with the advance of scientific knowledge what was good yesterday may be made better to-morrow. The point which may be pressed forward is that efficiency entails the utilization of the best knowledge and experience

of the present day. What may have sufficed yesterday does not always conform to the requirements of to-day. The health department, for example, insists on a much more rigorous standard of public health to-day than it did ten years ago, and to be efficient it must ever move with the inexorable demands of the period. Discoveries and development in the science and art of bacteriology have placed a new interpretation upon the term efficiency in waterworks. Water which may have been considered first-class a decade ago is in another category to-day.

The treatment of sewage has always been a difficult problem because the quantity fluctuates from moment to moment and its composition varies also. The process of evolution has been slow and expensive. Hand irrigation, filters, chemical precipitations, septic tanks, Travis tank, Emscher tanks and activation of sludge roughly represent the stages of development, each one of which has been evolved under efficient and scientific oversight of specialists. The effluent obtained by each process under ordinary working conditions was considered good until a better process was secured; thus from stage to stage an improvement was effected so that to-day efficiency in sewage treatment has practically a new meaning.

The civic authority must, perforce, adopt the best known process; and, moreover, keep on improving and adapting the works to utilize any better one which may later be developed. No civic authority can afford to be a laggard in the progress of city administration. The municipality must, so far as its means will permit, make use of new processes, materials, machinery and ideas. Industrial concerns often can earn extra dividends by scrapping existing good machinery and installing more up-to-date and efficient plant, and it is evident that cities must be prepared to do likewise.

A fixed policy of maximum efficiency will bear handsome returns. It does not mean that a city must be a spendthrift in securing the desirable acquisitions, but it does mean that its representatives must be endowed with sufficient perspicacity to discern how and when to embark on new works. Efficiency entails a discerning eye to watch for defects and to know how to remedy them; how to make use of new ideas so as to reduce expenditure; how to adjust expenditure on new works so as to minimize the cost of maintenance. It is to be feared that the advocacy and practice of "efficiency" in certain works has given such a policy a disagreeable flavor. Efficiency does not mean investing in men and women; it means utilizing their effort, talents and time in a reasonable manner for the benefit of the employers and of themselves.

There are many other points which could be dealt with in this connection, such as the inordinate consumption of water and the burden it imposes upon the taxpayer, the width of construction and the maintenance of streets where the traffic is relatively small, the basis of charges for water and for electricity, etc., but probably sufficient has been expressed to indicate the objects that municipalities must keep in view in order to secure efficiency in civic undertakings.

Announcement was made in last week's issue that R. J. Durley had taken over the unfinished Canadian work previously handled by the Montreal office of the firm of MacMullen, Riley & Durley, "which was recently dissolved and reorganized as MacMullen, Riley & Angus." The latter phrase perhaps conveys a wrong impression, as it was only the Toronto office of MacMullen, Riley & Durley which was reorganized as MacMullen, Riley & Angus, the Montreal office of MacMullen, Riley & Durley having been taken over by Mr. Durley.

CANADIAN SOCIETY OF CIVIL ENGINEERS, OTTAWA BRANCH MEETING.

The Can. Soc. C.E. Ottawa Branch held the second luncheon for the season last Thursday at the Chateau Laurier. The chairman of the branch, Mr. John Murphy, presided, and among the guests present were Sir Wilfrid Laurier, who was the speaker of the occasion, Sir Collingwood Schreiber, Sir Henry Drayton, Hon. C. A. Magrath, Mr. Sanford Evans, Dr. Adam Shortt, Prof. C. H. McLeod, R. A. Ross, W. J. Francis, W. F. Tye and Geo. A. Mountain.

The accommodation of the dining room of the Chateau Laurier was taxed, as there was a large representative attendance of engineers in private practice and in Dominion Government service.

Chairman Murphy introduced Sir Wilfrid Laurier, referring to the fact that Sir Wilfrid is 75 years young, and extending to him a message for Lady Laurier, wishing both of them many happy returns.

Sir Wilfrid Laurier's speech is reported in full on page 436 of this issue. Mr. Arthur St. Laurent, immediate past chairman of the Ottawa Branch, expressed the thanks of the meeting to Sir Wilfrid, asserting that Sir Wilfrid Laurier should be a member of the society. "You all know," said Mr. Laurent, "that as an engineer he was on active service for a number of years and you know how successful he was in conserving our resources. The lofty ideas and principles which he has placed before us, and his words of advice, should not only be printed as a matter of record but also should be engraved in our minds and hearts in such a manner that they will never be forgotten."

TORONTO POWER CO.'S TRANSMISSION LINE TOWER FOUNDATIONS.*

By F. C. Connery.

Formerly Supt. of Transmission Lines, Toronto Power Co.

THE following data apply to the tower foundations of the two 60,000-volt transmission lines of the Toronto Power Co., extending from Niagara Falls to Toronto.

Types in Use.—The types of foundation in different soils used for the standard 40-ft. tower are shown in Fig. 1. About 100 sets of these footings have been dug up after having been in use for seven years. In no case has the galvanizing on the members deteriorated, and, with a few exceptions, the 3 x 6 x 24-in. impregnated wooden blocks were in a fair state of preservation. The type of foundation shown in Fig. 1 (b) has no wood base, and was designed for use in hard pan; that shown in Fig. 1 (c) has a wood base, with filling and galvanized pipe as noted, this type being used in marsh land; while the type shown, in Fig. 1 (d), has a wood base, and was designed for loose soil.

In another type of tower the foundations contained no impregnated blocks, nor were any precautions taken to prevent corrosion of the steel, except the hot galvanizing. Six of these towers were erected in low, marshy black-muck, in which there was no resistance to borings driven to a depth of 40 ft. In this type 2-in. plank sheeting was driven around the site of each tower leg; the muck was then dug out, and a floating foundation built 6 ft. below the ground surface. This founda-

*Abstract of paper before convention of American Institute of Electrical Engineers.

tion consisted of impregnated 2-in. planking, the footings being set in concrete. About 1 cu. yd. of concrete was placed around and under each stub, the excavation being 30 x 30 ins. x 6 ft. deep. These towers have been erected for one year, and they have neither settled nor deviated from alignment.

Great care was taken in locating these towers to avoid, wherever possible, soft, marshy soil, and also to equalize the grade. It has been found that tower footings in gravel, or in a mixture of sand and loam, packed tightly, offer great resistance against an upward pull.

A number of towers of the second type were founded on a thinly stratified rock, which could easily be excavated to a depth of 3 ft. The stubs were cut to 3 ft.

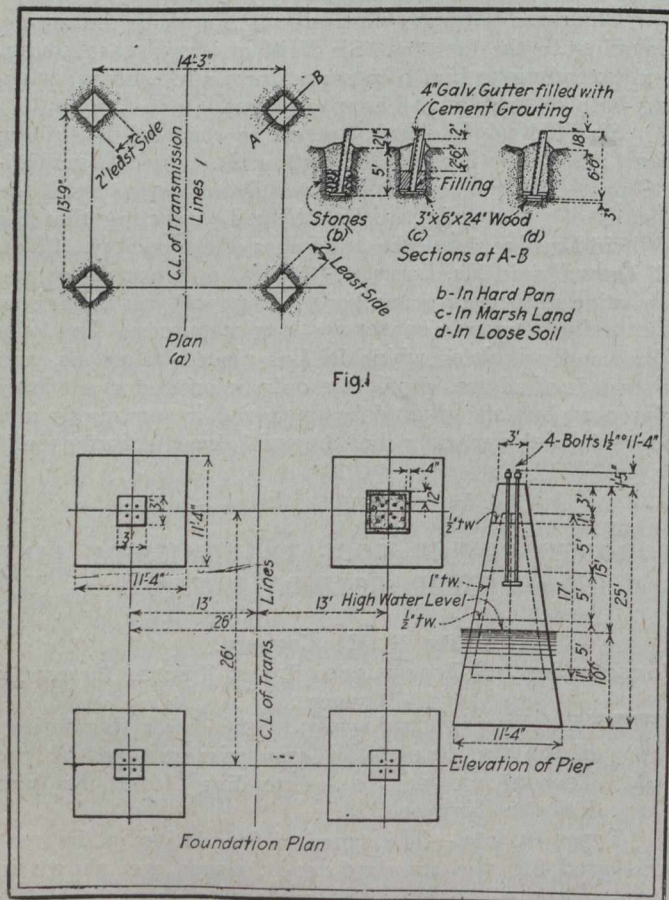

Details of Tower Foundations.

6 ins., and were set in a 1:2:4 concrete mixture. This construction has proved satisfactory.

Foundations for Narrow-Base Towers.—For a type of narrow-base latticed tower the foundations were built in two ways, as follows:—

(a) A foundation of 1:3:5 concrete, 6 x 6 x 6 ft., was constructed and provided with twelve 1 1/4-in. anchor bolts 5 ft. 6 ins. long.

(b) Foundations, 6x6 ft. and with variable depths, were constructed, these foundations being built in the following manner: The site was first excavated; a copper grounding-ribbon was then placed and finally 12 in. of 1:3:5 concrete were placed and tamped. No anchor bolts were used, but the tower was erected on this 12-in. base, and the excavation then filled with 1:3:5 concrete. This method was used on account of the variation in the dimension of the tower bases, the minimum depth of which was 6 ft.

Eleven footings were constructed in the waters of Lake Ontario, at Burlington Beach, Ont., the mean depth of water being 3 ft. A double cofferdam was first built of 2 x 8-in. tongue-and-groove spruce, driven to a depth of 10 ft. below the lake bottom by a small steam hammer. The water was then pumped out, and the sand and gravel excavated to a depth of 6 ft. below the lake bottom, where very coarse gravel was encountered. The foundation was then constructed according to the plan shown in Fig. 2, the spruce sheeting being left in place to prevent scour. After a foundation was completed a wall of 10-in. stones, each piece weighing from 500 to 1,500 lbs., was built around the two outer footings of each foundation to afford extra protection, the location of these towers being near the shore, where storms from the east are prevalent.

In setting the stubs a template was used with success. This template, which was carried by the setting gang, was lined up on the centre line stakes, then levelled by the foreman, by means of a carpenter's level, and finally blocked up and checked. The stubs were bolted to the template and the filling in of holes then proceeded with, one man placing the backfilling while two men tamped the material. Where water was available it was used to settle the backfilling.

Erection of Towers.—The towers were assembled at the locations where they were to be erected. From eight to twelve towers were erected in one day by eight men and one team. The sheer-leg method was found to be the most efficient, except where cramped for room, when the gin-pole was used to best advantage. This decision was reached after the use of sheer-legs, derricks and gin-poles.

The sheer-legs used on this work were constructed in the following manner: Two pieces of 6 x 8-in. clear Georgia pine, 34 ft. long, were bolted together 14 in. from the top with a 1-in. bolt 14 in. long. This sheer-leg, equipped with a set of 12-in. triple blocks, hand lines, anchor pins, etc., made a cheap and serviceable erecting outfit. It was used in the erection of a line of 928 towers, averaging 2 1/4 tons each, with only one accident, this being due to negligence on the part of the foreman in connection with the erection of the first tower.

Use of Guy Anchors.—Patents for guying should not be used except for light construction. In light soil the old-fashioned slug, or deadman, gives the best results. All guys should be tested periodically and tightened up. Where there are more than one guy on a pole, galvanized turnbuckles should be used to obtain the best results. From observations extending over 10 years the writer states that fully 40 per cent. of the guys in use are inefficient, this condition being due to lack of inspection. The anchor should be placed at a distance from the base equal to one-third of the height.

In using rock bolts for anchoring, care should be taken, if the rock is covered with a layer of earth, to place the anchor so that the ring is just above the rock surface, and then to fasten a long link to the ring, guying to this. This method gives much better results than if the ring had been left above the ground surface and the guy attached to it, as the anchor rod will bend in the latter case. The rock bolts should be grouted in with hot brimstone.

The company is designing tower footings which include the following features:—

(1) A modification of an ordinary screw-type guy anchor, similar to the "Matthews" or "Stombaugh" anchor, with the top of the anchor rod shaped to take the tower leg; this for towers of light windmill type.

(2) For heavy anchor, long-span towers, etc., a large foot plate supported on a shallow concrete footing sufficient to give a good bearing, and an anchor similar to those mentioned above, with the exception that the end of the bolt will be threaded to take a nut and locknut.

(3) For extra heavy, or four-circuit towers, a large section screw pile with top plate to which the tower foot-plate can be bolted.

The question of threading an ordinary wooden pile is also offered for consideration. There are locations on almost every line where marshy land is encountered, and it is usually a very expensive operation to use a pile-driving outfit in these locations. In connection with this method it has been found that it is not necessary to drive a pile to refusal to obtain a good footing for a standard tower, as there is sufficient skin friction developed by the pile in the upper layers of the ground to give satisfactory results. Twenty-five-foot piles have been found satisfactory in very swampy ground, where borings had been taken to a depth of 40 feet without striking firm soil.

CANADIAN SOCIETY OF CIVIL ENGINEERS.

Nomination of Officers.

The Nominating Committee of the Canadian Society of Civil Engineers has submitted to the membership the following list of nominations for officers for the year 1917:

For President—J. S. Dennis, assistant to the second vice-president, Canadian Pacific Railway, Calgary, Alta.

For Vice-Presidents—G. R. G. Conway, bondholders' representative, Mexican Light & Power Co., Mexico City; J. M. R. Fairbairn, assistant chief engineer, Canadian Pacific Railway, Montreal; J. G. Legrand, bridge engineer, G.T.P. Railway, Winnipeg; C. N. Monsarrat, chairman, Quebec Bridge Commission, Montreal. Two vice-presidents are to be elected and one of them must be resident in District No. 1.

For Councillors, District No. 1—J. Duchastel, city engineer, Outremont; F. H. Pitcher, chief engineer, Montreal Water & Power Co., Montreal; R. A. Ross, consulting engineer, Montreal; Julian C. Smith, chief engineer, Shawinigan Water & Power Co., Montreal.

For Councillor, District No. 2—Horace Longley, of Norton-Griffith & Co., St. John; C. M. Odell, resident engineer, Dominion Coal Co., Glace Bay, N.S.

For Councillor, District No. 3—A. R. Decary, superintending engineer of the Province of Quebec, Public Works of Canada, Quebec; S. S. Oliver, consulting engineer, Quebec.

For Councillor, District No. 4—John Murphy, electrical engineer, Department of Railways & Canals, Ottawa; James White, assistant to chairman, Commission of Conservation, Ottawa.

For Councillor, District No. 5—G. A. McCarthy, railway and bridge engineer, Works Department, Toronto; E. W. Oliver, assistant to chief engineer, Canadian Northern Railway, Toronto.

For Councillor, District No. 6—A. T. Fraser, district engineer, Canadian Northern Railway, Edmonton; Wm. Pearce, assistant to executive, Department of Natural Resources, Canadian Pacific Railway, Calgary.

For Councillor, District No. 7—R. F. Hayward, chief engineer, Western Canada Power Co., Vancouver; J. H. Kennedy, assistant chief engineer, V.V. & E. Railway, Vancouver.

Two members of council are to be elected for District No. 1 and one member for each of the other districts.

STEEL PIPE CONDUIT AT LOCH RAVEN, MD.

(Continued from page 434.)

ments demonstrating the efficiency of cement mortar in protecting iron from corrosion, developed a method of placing a mortar lining inside the steel conduit and surrounding the pipe on the outside with concrete. The mortar lining also makes it possible to obtain a smooth interior irrespective of projecting rivet heads and the edges of plates, so that in addition to promising longer life for steel conduit, the cement mortar lining will give a much larger water-carrying capacity than the riveted lapped joint pipe which is certain to have its interior surface materially roughened by tuberculation in the course of a few years. Engineers experienced in the water-carrying capacity of steel and concrete pipes have estimated that a pipe 7 ft. in diam., smoothly lined with cement will, after some years' use, carry as much water as a steel pipe 8 ft. in diam. made in the ordinary way.

The Baltimore steel pipe is constructed of alternate inside and outside cylindrical courses with 10 ft. as the inside diam. of the inside courses. The pipe was made at the shops in sections 15 ft. long with one longitudinal double riveted lap joint and the circumferential joints were single riveted lap joints. Changes in line or grade were obtained by cutting and bevelling the ends of a sufficient number of courses to produce the desired total deflection or curvature.

Although the pressure on the pipe line would require a thickness of steel of less than one-fourth inch, yet for structural reasons the thickness was made seven-sixteenths of an inch. In places where thin pipe has been used, great difficulty was experienced in making it keep its shape during construction. A further reason for an increase over the theoretical thickness is that the thicker pipe will last much longer should there be a break at any point in the protective mortar lining. The plates were not painted, but after being inspected at the shop the inside of the pipes were given a coat of white-wash before shipping. No paint was put on the pipes as it was desired to get the best possible contact of concrete and steel.

After the pipe had been riveted together in the trench it was filled with water delivered from a tank built on the hillside at such an elevation as would give the same pressure in the pipe line as would be obtained by the water back of the high dam. If any leaks developed under this pressure they were caulked until tight. Then, with the pipe line still full of water under this pressure the concrete casing was placed around the conduit, the purpose being to hold the pipe in the shape that it will finally assume, so that when the mortar lining is placed no change in shape will occur after the water from the high dam is admitted. It was found that the pipes flattened a good deal under their own and the water load when the pipes were full but with no pressure on them. When the pipes were put under pressure they tended to return to a circular shape although never quite reaching it.

After the outer casing of concrete was placed the water was drawn from the conduit and the inside mortar coating was placed by means of the Cement-Gun (manufactured by the Cement-Gun Co., Inc., of Allentown, Pa.), the cement and sand being mixed dry and delivered in that condition by compressed air through a hose or pipe to a specially constructed nozzle where the mixing water was added under pressure and the mixture blown by means of compressed air against the surface to be covered until the thickness of $1\frac{1}{2}$ inches was secured. This mortar lining is reinforced with steel wire netting placed to prevent shrinkage and settlement cracks.

BANK STREET, OTTAWA, SUBWAY PAVEMENT.

By L. McLaren Hunter, C.E.,
City Engineer's Department, Ottawa.

THE repaving of Bank Street subway, which was completed this year, presented some unusual experiments in street design, in the writer's opinion, especially in regard to the sub-drainage. The old pavement, which was constructed of a light concrete base

observed that the main sewer had to be cut in half, practically, before the roadway could be constructed.

Fig. No. 3 shows a plan of the drainage provided for the new pavement. The location of the main sewer, gully and track grates are also shown. All the subsoil was drained into a chamber containing an automatic cellar drainer; that is, a water pressure ejector of high capacity, automatically operated by a float, controlled by a quick opening-and-closing valve. This drainer has been in use for several months and has been found to be efficient. The one installed at the subway will elevate 1,230 gallons per hour at a 60 lbs. pressure. In Fig. No. 1 the location and outline of the ejector is shown.

To keep the concrete base of the pavement clear of the soil underneath, a layer of broken stone eighteen inches deep was first laid. This was tried as an experiment, as the old concrete had been badly cracked by the damp nature of the subsoil. On top of the stone was laid the reinforcing, which consisted of 3/4-inch square iron bars under heavy expanded metal, as shown in Fig. No. 1.

The concrete foundation was laid, eight inches deep, on this reinforcing. A 1:3:6 mixture was used. The creosoted wood blocks were then set on a 1-inch mortar cushion, rolled with a light roller and the joints thoroughly filled with a mixture of asphalt and pitch. On the grade, a 3/16-inch creosoted wood strip was laid between the blocks to provide a space for the cauks of horses' hoofs, thereby minimizing the chance of their slipping when pulling heavy loads.

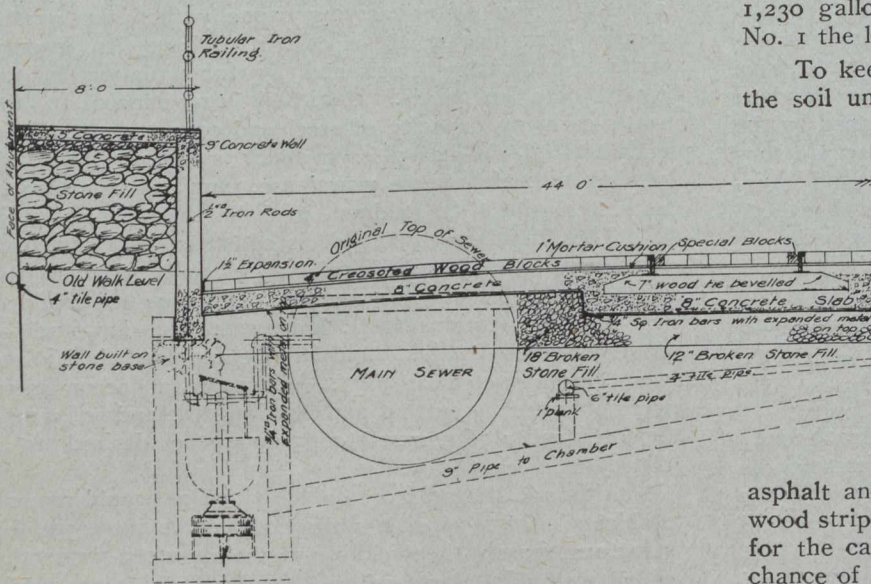

Fig. No. 1.—Half Section Through Subway.

with stone blocks on a sand cushion, had never given much satisfaction. This was due to the nature of the subsoil, want of proper drainage, and the light concrete base.

The subsoil is mostly of blue clay and no drainage had been provided, owing no doubt to the level of the sewer, which is shown in Fig. No. 1. With the extreme frost in the winter, the old pavement heaved in places, and the concrete was cracked and broken. It will be

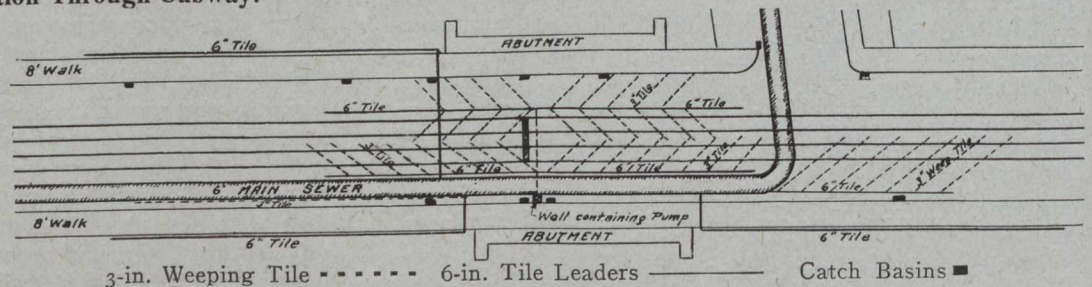

Fig. No. 3.—Plan of Drainage.

Simultaneously with the repaving of the subway, the sidewalks were raised about five feet, as shown in Fig. No. 1. A 9-inch reinforced wall was first constructed, then spalls (or large stones) were used to fill it to grade. The railing is an ordinary tubular railing with cast iron standards.

The work was carried out by O'Leary's, Limited, under the direct supervision of Andrew F. Macallum, commissioner of works

BRITISH-AMERICAN NICKEL COMPANY.

The British-American Nickel Company's selection of site will, it is stated, be probably in the Welland district, Ontario. The company has secured as general manager, Mr. E. P. Matheson, who will also occupy a position on the board, and who has resigned from the managership of the Washoe Reduction Works of the Anaconda Copper Mining Company, at Anaconda, which produces 10 per cent. of the world's supply of copper. Mr. Matheson is one of the best known metallurgists in America. Work is proceeding on a power plant in the Sudbury locality and in the mines. An arrangement by which the British government would take the output of the new smelter and refinery and in return would guarantee the interest on its bonds, was announced some time ago.

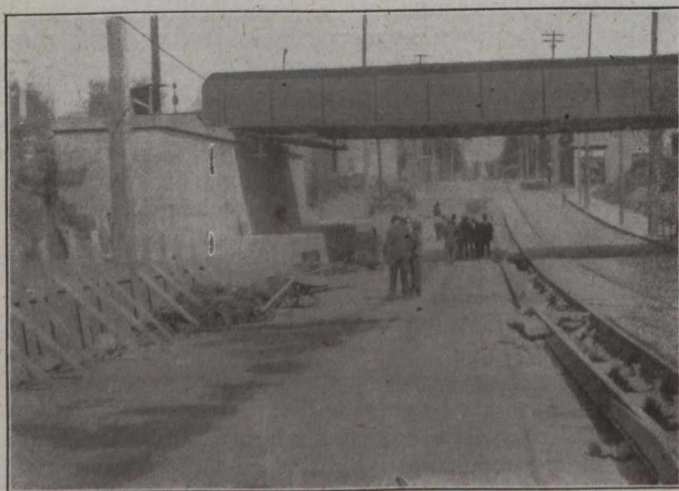

Fig. No. 2.—Laying Blocks and Constructing Sidewalk, Bank Street Subway, Ottawa.

REPORT ON FILTRATION FOR CALGARY.

GEORGE W. CRAIG, city engineer of Calgary, Alta., has made a report to the pure water committee of the Calgary city council upon the question of an improved and larger water supply. He has dealt with the subject under two heads: First, a report on a proposed gravity extension, with sedimentation reservoir; second, a report embracing the proposed extension with the addition of a filtration plant, but omitting the sedimentation reservoir.

These two schemes may be said to be rival projects, and, while Mr. Craig favors the first one, he says that it is only because of the present civic financial conditions which do not appear to warrant the more elaborate and comprehensive filtration scheme just now. Even if the first scheme is adopted for the present, it is most likely that the filter plant will have to follow at a later date.

In the November 16th issue of *The Canadian Engineer* a summary was given of the present water conditions in Calgary, and in last week's issue appeared an abstract of Mr. Craig's report upon the proposed gravity extension with sedimentation reservoir.

Following is an abstract of his report upon the alternative scheme, which includes filtration:—

The bulk of the report on the gravity extension scheme holds good for this report, the only considerable difference being that the present report includes a filtration plant and excludes the sedimentation plant, division wall and regulating chamber covered in the original scheme.

Whichever scheme be adopted, the consumption of the Bow River water and the use of the west end pumping station (except as a stand-by) would be entirely abandoned, which are things much to be desired. The report of the city chemist leaves no room for doubt on this point. The result of every test over a period of three years by chemical analysis shows clearly that the Bow River is contaminated, and is likely to become more so as time goes on, and that while the water from the Elbow is not perfect, it is at least infinitely preferable to that of the Bow.

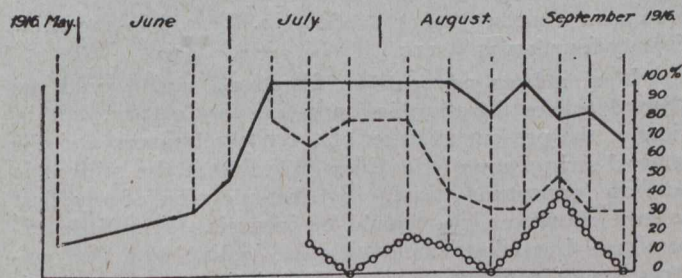

Pollution Curve—Calgary Water Supply, 1916.
Percentage of Positive Tests for B. Coli. Communi.
 o-o-o-o-o-o-o-o Represents 1/10 c.c. Tests.
 - - - - - Represents 1 c.c. Tests.
 ————— Represents 10 c.c. Tests.

While the majority of people seem mainly interested in dispensing with the period of turbidity, there is no question that the supply could be improved in quality by all-the-year-round filtration. The main difficulty, however, is the cost.

In order to provide an adequate filtration plant, care should be taken to make it comprehensive and effective in every direction, not alone to produce an effluent free from turbidity, but one which is palatable, sparkling, free from odor and chemically and bacteriologically pure.

There are several filtration companies, both British and American, who have good reputations for such plants and who would no doubt be willing to furnish estimates and tenders.

From a general point of view the most desirable position for a filtration plant would no doubt be at the new intake, but that can only be done by sacrificing some of the head, which would not be advisable from a discharge standpoint. The only other possible location is immediately west of the present reservoir, where a break in the hydraulic grade occurs.

There is much in common with all the filtration companies' processes and plants, and a brief general and approximate description would be as follows:—

Process.—The water is delivered from the supply main to the receiving chamber in the head house; here the coagulant is added to the raw water, which flows from the receiving chamber to the coagulating basins, where it undergoes a period of coagulation and sedimentation.

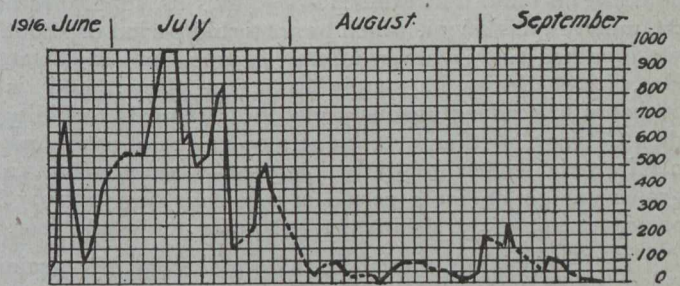

Relative Turbidity of Calgary Water Supply.
 (No determinations made where curve is dotted.)

tation of about two hours or longer. As tests show that about 64% of the solids in suspension under the worst conditions of Calgary's water become precipitated in this period, only such solids would remain as the filter could fully negotiate. The water is then delivered to the filter and is passed through the filtering medium. It then flows out through the effluent rate controllers and is delivered through a short length of main into the city's reservoir. Periodically the filters have to be cleaned by reversing the flow under pressure; the dirty water is by-passed into a drain which will connect to the city sewers.

Plant.—There will be two covered reservoirs or basins for coagulation and sedimentation. The filters, twelve in number, each of a capacity of one million gallons per 24 hours, can be worked as units or in series. They can be cut out for cleaning in units or in series as required, and further units can be added to the system should this become necessary. The filters can on occasion bear an overload of 10% or more.

There would be a storage basin containing the filtered water, some of which is also used for washing out the filters. Motors for providing water under pressure should be installed in duplicate.

An important feature which I believe is common to nearly all mechanical filters, is that of an operating table, from which are worked all valves controlling the various units, and to which samples from every individual filter are collected at will.

Suitable gauges would be fixed with recording dials indicating the state of each filter.

There will be two meters for recording the flow of filtered water, one on the short main to the reservoir, and the other on the old gravity main north of the reservoir.

The buildings would probably be of reinforced concrete of ample size and of a design suitable for the purpose, allowing for future extensions. As far as possible they would be of fireproof and indestructible materials, so as to reduce fire risks to a minimum, and insure long life to the plant.

Coagulant.—The amount of coagulant used governs in an overwhelming proportion the operation cost of a mechanical filtration plant, and varies with the local conditions. The larger the sedimentation tank the smaller the amount of coagulant required to effect precipitation, and of course the degree of turbidity also enters largely into the matter. From tests of water taken from the city mains during the floods of 1915 and 1916, the city chemist found that about 57% of total solids were precipitated after one hour's sedimentation, without the active agency of a coagulant.

In the large Minneapolis filters there were used in 1913 an average of 3.89 grains of coagulant per Imperial gallon; in 1914 an average of 3.36 grains; and it should be borne in mind that Minneapolis draws its supply from the muddy Mississippi, which has a turbid period of about six months, and is never at any time clean. Medicine Hat, which draws its supply from the Bow, and is probably less advantageously placed as regards turbidity than Calgary, used an average of 1.09 grains of coagulant per Imperial gallon for the whole year of 1914, and 1.42 grains per gallon for a period of 145 days only in 1915, or an average of .56 grains per gallon for the whole year.

I am of opinion, therefore, that an average of 1 grain per gallon all the year round would prove sufficient to give the required precipitation here, particularly as for a greater part of the year one-quarter grain per gallon, or even less, would be used. In my estimate, therefore, I have allowed 1 grain per gallon.

I estimate the cost of a mechanical rapid sand filtration plant, such as would deal with the required amount of water in a thoroughly satisfactory manner, at \$300,000 or \$25,000 per million gallons.

I have allowed 4c. per pound for coagulant in my estimate. Under present conditions the best price obtainable appears to be about 5c. Probably by annual contracts we could arrange a price of 4c. per pound, and after the war is over we could possibly get a still better figure.

Cost.—Following is a summary of the estimated costs:—

Elbow River weir	\$100,065.59
Right-of-way	5,000.00
Pipe line	78,660.40
River crossing	13,543.77
Connecting chamber	1,107.67
Alteration to present outlet	1,793.38
Lining present reservoir	14,646.00
	<u>\$214,816.81</u>
Filtration plant	300,000.00
	<u>\$514,816.81</u>
Add for engineering and contingencies 15% on \$214,816.81	32,222.52
Total for gravity extension—filtration plant scheme	<u>\$547,039.33</u>
To this must be added for new mains, and alterations to existing mains between reser- voir and city	57,000.00
	<u>\$604,039.33</u>

Annual Charges.—Following is a summary of the estimated annual charges:—

*Depreciation	\$ 10,657.35
Sinking fund—	
30 years on \$548,000 @ 4% ...	\$ 9,770.89
Interest on debentures @ 5% ..	27,400.00
	<u>37,170.89</u>
	<u>\$ 47,828.24</u>
Coagulant, 1 grain per gal., 12,000,000 gals. per day, 625,714 lbs. @ 4c.	25,028.56
Filter attendance, two men	3,000.00
Wash water (electric power)	460.00
Total annual charge for construction and operation of gravity system and filtration plant	<u>76,316.80</u>
To this should be added depreciation at 2½% on \$57,000	\$1,425.00
Sinking fund—	
30 years @ 4% on \$57,000	1,016.31
Interest on debentures, 5% on \$57,000	2,850.00
	<u>5,291.31</u>
Total	<u>\$81,608.11</u>

Turbidity Tests.—The following are the results of turbidity tests made on city water by F. C. Field, city chemist:—

Sedimentation tests made on 1,000 c.c. water in tall, graduated cylinder, drawing one inch depth for each test. Original turbidity reading of sample, 550. This water was drawn during the maximum of turbidity, in July, 1916.

Hour.	Centi- metres	Tur- bidity.	Time.	Reduction in minutes.
1:00 p.m.	4.1	550		
1:05 p.m.	5.5	400	5 min.	150 in 5 min.
1:10 p.m.	5.7	385	10 min.	165 in 10 min.
1:30 p.m.	8.1	270	30 min.	280 in 30 min.
2:00 p.m.	9.2	238	60 min.	312 in 60 min.
2:30 p.m.	9.8	222	90 min.	328 in 90 min.
3:00 p.m.	10.9	200	120 min.	350 in 120 min.
3:30 p.m.	11.6	187	150 min.	363 in 150 min.
4:00 p.m.	12.5	174	180 min.	376 in 180 min.
Twenty-four hours		110		440

I am a keen advocate of filtration, and would be pleased to see filtration in operation in Calgary, but in view of the present position of the city's finances and the general stringency of the times, I feel that the present is not an opportune time. By the adoption of my first scheme, however, we should be incurring very little expenditure but what would be quite in line with the construction of a filtration plant should this be deemed advisable at a future date, except perhaps a slight increase in storage, which is a favorable point.

*At 2% on all items excepting pipe line 2½%, river crossing 2½%, right-of-way nil.

Norway has put an embargo on the export of raw copper, but releases for shipment to England, as great an amount of copper as it receives from the United States.

The longest water conduit in the world is the famous Coolgardie line, in West Australia, built in 1902. Water is pumped from a river in the humid coast region, and is carried through 351 miles of 30-inch steel pipe to Kalgoorlie, in the West Australian gold field, in a district where rain seldom falls. The pumping engines which force the water through the main not only have to overcome the friction head, but to raise the water a total height of 1,447 feet.

HIGH-TENSION TRANSMISSION LINES AND STEEL TOWERS.

By **Lesslie R. Thomson, B.A.Sc.**,
Dominion Bridge Co., Montreal.

(Continued from last week's issue.)

Depreciation.—The depreciation in the towers depends on the type of protection afforded, severity of climate, presence of chemicals in either the air or ground and on the amount of original "stability" provided. By the term "stability" is meant that excess thickness demanded by the structural engineer for sake of rigidity. For example, it may be often found that when a $2\frac{1}{2} \times 2\frac{1}{2} \times \frac{1}{8}$ angle might perhaps figure, the engineer will insist on $2\frac{1}{2} \times 2\frac{1}{2} \times \frac{1}{4}$ because of his distrust of thin legs, or because of specification requirements on minimum thickness.

The protection usually given to towers and foundations is either galvanizing or paint. If it be desired to paint over the galvanizing, though this is usually regarded as quite unnecessary, a special paint must be secured. In spite of any protective coating, however, the stub angle foundations will deteriorate very rapidly where they emerge from the earth.

In soil alternately very wet and very dry no mild steel, in thin sections, either painted or galvanized, will last for more than 4 or 5 years, unless it be encased in concrete for its whole length. Under these circumstances, however, it may be considered as permanent. A paint-protected tower, well-designed and repainted thoroughly whenever necessary, should last at least 75 years. Galvanized towers are more uncertain in their life owing to the fact that deterioration may be very rapid with no visible evidence of it,—the oxidation spreading rapidly beneath the galvanized skin.

Operating Costs.—Operating costs are capable of being fairly closely estimated before the line is built, but the discussion of them lies outside the scope of this paper. It will be remembered, however, that they must be estimated when "satisfactory operation" is being furnished. As mentioned above, this is difficult to define but some idea may, however, be formed of its financial equivalent.

Most engineers agree that a large amount of power is entitled to more insurance than a small amount, whether this insurance be paid directly in the form of premiums or whether it be paid in the form of increased interest charges on a larger capital investment. Again, certain services from the very nature of the case *must* be continuous. For example, a city engineer, whose low tension bus bars supply power for lighting, street railway, and general office service, would probably consider one shut-down a year, of even 10 minutes duration, as very unsatisfactory, for there would be investigations without number inquiring why citizens were stalled in the streets, caught in elevators between floors, etc., etc.

On the other hand, power delivered to electric pumping stations in a small locality would be satisfactory if they had power for 75 per cent. of the day. Hence, satisfactory operation had better be reduced to some form as the following:—

"Operation will be considered as satisfactory if shut-downs do not average more than per month (or per year) of a total duration of not more than minutes per month, (or minutes per year)."

Having reduced the question of "satisfactory operation" for different types of service to a definite basis, the engineer should use his own judgment as to the amount

of insurance the service needs and thus the financial equivalents for various types of service may be approximated. It is interesting to note in this connection, that many engineers feel that it is impossible to provide absolutely continuous service over one circuit. Apropos of this, D. B. Rushmore, of the G. E. Co., said in 1913, "It may be taken as an axiom that under present conditions continuous service cannot be supplied over a single circuit power line." If two circuits are provided, they may be either on the same tower or on separate towers, with the same or independent rights of way. It is on questions of these kinds that the judgment of the engineer must be exercised to obtain the most economical solution.

The foregoing are in brief the main factors which should be weighed carefully before selecting the span length. The problem is, of course, incapable of a solution that is applicable to all cases arising, but the above-mentioned general characteristics should be carefully considered; and emphasis may again be laid on the necessity of full co-operation between the structural and electrical designers, to obtain a truly economical line.

Loads.—The loads on a transmission line tower are of three classes, each system at right angles to the other two. They may be described as the (a) dead, (b) transverse, (c) longitudinal, and will be discussed in order:—

(a) The total dead load is obtained by taking the sum of (i) tower itself; (ii) weight of all wires supported by the structure; (iii) the weight of the snow or ice coating. It is on this point that climate enters into the question. In the south, $\frac{1}{4}$ in. or $\frac{1}{2}$ in. of ice coating is sufficient; but in northern countries like Canada more allowance must be made. The Montreal Light, Heat & Power Company assumes $\frac{3}{4}$ in. on each side, making the diameter of the cable $1\frac{1}{2}$ ins. plus its own thickness.

(b) The transverse loads arise from the action of the wind on the towers and cables. It is usual to neglect the wind pressures on cross-arms and insulators. The most frequently assumed wind pressures in England and the United States are 56 lbs. and 30 lbs. per square foot of exposed normal surface. A cylindrical surface is usually considered to present 0.6 of its projected area as an effective normal surface. In America it is readily recognized that wind pressures up to 50 lbs. per sq. ft. are quite possible but only over small areas. For any considerable surface 30 lbs. is felt to be a liberal estimate. It is a matter of observation that wind pressures decrease as one approaches the ground. For the foregoing reasons, it seems adequate to take the following pressures (and they are recommended):—

(i) On structure itself (on two series of faces) 30 lbs. per sq. ft.; (ii) on bare wires, 15 lbs. per sq. ft.; (iii) on projected area of ice-covered wires, up to $\frac{1}{2}$ in. of ice, 10 lbs. per sq. ft.; (iv) on projected area of ice-covered wires, with more than $\frac{1}{2}$ in. ice, 8 lbs. per sq. ft.

The only question about which any doubt may be raised in the foregoing is the allowance of heavy wind on coated cables. Many engineers feel that these never occur simultaneously, and some are dubious as to whether sleet ever forms in a conductor carrying an appreciable amount of electrical power. But the majority will admit that ice and wind do occur together and hence the necessity of providing for it.*

*Joseph Mayer, M.Am.Soc.C.E., says, "Such lines should therefore be built strong enough to resist not only the commonly occurring but also the exceptionally violent local storms. It is interesting to note that the United States Weather Bureau records a wind of 100 miles per hour on ice-coated wires."

(c) The longitudinal loads are obtained by assuming one or more conductors to break and thus place on the cross-arms an unbalanced load—tending to produce torsional effects in the towers. Certain specifications insist that provision shall be made for all wires on one side of the longitudinal centre line of tower breaking together with the ground wire; while others only require one conductor and ground wire per circuit. Mr. R. Fleming recommends that for towers having one circuit and ground wire, allowance be made for any one wire breaking; while for towers having two circuits and ground wire, allowance be made for any two wires breaking. If all wires break on one side of transverse centre line of tower, the load is heavy but there are no torsional stresses set up in the tower.

The writer feels that Mr. Fleming's recommendation touching the assumed number of broken conductors is very reasonable and he would concur in it. Mr. Fleming gives the following figures for the loads that are thrown onto the tower by the breaking of the respective wires:—

No. 4 hard drawn copper or smaller, actual ultimate strength; No. 00 hard drawn copper or smaller, 2,500 lbs.; No. 0000 hard drawn copper or smaller, 4,000 lbs.

The following table by Mr. Fleming gives breaking load of each wire in percent. of its ultimate strength:—

No. 4 and smaller.....	actual ultimate strength		
No. 3	90%	No. 2	80%
No. 1	70%	No. 0	60%
No. 00 (and all larger sizes)			50%

This decrease of applied loads by the larger wires is due to the fact that before breaking there must be a marked reduction of cross-sectional area, which is not the case for the smaller wires.

The towers should be designed for the maximum stress resulting from any combination of loads (a), (b) and (c).

Angles.—When turning longitudinal angles the usual practice is to put in standard line towers unless this angle exceeds 10° . In the latter event, either a standard tower with wire guys, or a special tower designed to carry the actual loads is placed in position—bisecting the angle of the line. The use of a special tower is the better practice, as the transverse guys introduce more or less indeterminate stresses.

Tests.—During the last decade or so, purchasers have been insisting on actual mechanical tests of a certain number of towers before acceptance for delivery of any of them. The test-loads usually specified for each type of loading are double the actual values (calculated). It is customary for the specifications in use to read, "The tower shall not fail," and this is usually interpreted to mean that no member or part shall fail by buckling or parting. In a well-known international transmission line, the tests were of two sorts, (A) and (B). For tests (A) the towers were set on rigid foundations, in the manufacturer's plant, and all calculated loads were doubled and applied. In tests (B) the towers were set up on special field foundations and 90 per cent. of loads used in tests (A) were applied.

This specification is indicative of a growing conviction among engineers that the effect on the towers themselves of non-rigid foundations may no longer be neglected. It is evident that if the foundations of a four-legged tower are somewhat elastic with irregular settlement there will be an entirely new stress distribution within the structure. This point will be touched upon more fully under the head of "Foundations."

It is well to realize that these test factors bear a close relation to the unit stresses specified; and they will be discussed later under "Unit Stresses."

AUTHOR'S NOTE.—The following is by no means a complete bibliography of the subject, but gives a few of the books and articles that have appeared from time to time on the subject of transmission lines and towers:—

Transmission Tower Design, *Electric World*, March 22nd, 1913.

Structural Steel Poles and Towers, *Engineering Record*, December 28th, 1912.

Structural Steel Poles and Towers, *Engineering News*, November 28th, 1912.

Steel Towers for Overhead Transmission Lines, *The Canadian Engineer*, October 10th, 1912.

Steel Transmission Towers, *The Canadian Engineer*, September 22nd, 1910.

The Structural Design of Towers for Electric Power Transmission Lines, *Engineering News*, January 4th, 1906.

A series of articles by Mr. R. D. Combs, appearing in *Electrical World*, May 30th, 1914; August 1st, 1914; September 19th, 1914; October 24th, 1914.

Bulletin 54, of the University of Illinois Engineering Experiment Station, entitled, Mechanical Stresses in Transmission Lines.

Mechanical Loads on Electrical Lines, R. D. Combs, *Electrical World*, November 14th, 1914.

Sag in Overhead Conductors, *Electrical World*, February 6th, 1915.

Transmission Towers, *Engineering Record*, May 29th, 1915.

Transmission Line Construction, Lundquist, McGraw-Hill Book Company.

Comparative Data in Some Hydro-Electric Transmission Systems, *General Electric Review*, June, 1913.

Hand Book of Transmission Line Construction.

(Continued in the next issue.)

RUSSIAN ENGINEERS VISIT CANADA.

Two distinguished members of the Russian engineering profession, Profs. Boris Bakhmeteff and Alexander Astroff, members of the Imperial Russian Committee in America, recently spent ten days in Canada examining the water power situation in the vicinity of Montreal, Ottawa and Toronto. While in Canada they were the guests of the Dominion government, and were accompanied throughout by engineers of the water power branch.

The developments of the Cedars Rapids Power Co., the Shawinigan Water and Power Co., and the Laurentide Pulp and Paper Co. were visited. A day was spent at Ottawa where Prof. Bakhmeteff addressed the branch of the Canadian Society of Civil Engineers at a luncheon at Chateau Laurier. His subject was "The Russian Engineer and the War." A day was spent at Toronto in the offices of the Ontario Hydro-Electric Power Commission, after which the developments at Niagara Falls were visited.

Surprise was expressed at the progress made in the development of Canadian water powers. It was understood that these engineers would make a return visit during the coming summer, to study the canal systems.

Prof. Bakhmeteff is a member of the faculty of the Emperor Peter the Great Polytechnic Institute and member of the Russian Electrotechnical Committee of the International Electrotechnical Commission. He is vice-president of the Department for Land Ameliorations, Imperial Russian Technical Society.

Prof. Astroff is a member of the faculty of the Imperial Technical Institute at Moscow and of the Agricultural Institute at Moscow. He is a member of the United General Committee for Army Supply of the All-Russian Unions of Zemstvo and of Citys.

PROPOSED ONTARIO TRAFFIC REGULATIONS.

OWING to a sudden increase in the number of fatal traffic accidents in Toronto, a meeting of citizens was called for July 11th, 1916, and was held on that date in the city hall.

Twenty-four representatives of the leading organizations in Toronto attended the meeting and elected a committee of seven to make suggestions for the improvement of traffic conditions.

The committee consisted of W. A. McLean, Esq., Deputy Minister of Highways; Arthur Hewitt, President Toronto Board of Trade; W. C. Coulter, of the Canadian Manufacturers' Association; Dr. P. E. Doolittle, and T. N. Phelan, representing Ontario Motor League; J. H. Forrest, representing Toronto Railway Company; and R. B. Morley, of the Ontario Safety League.

The first meeting of this committee was held on August 9th, and W. A. McLean was elected as chairman, and R. B. Morley as secretary.

The report of the committee has now been forwarded to the Ontario Legislature. It is as follows:—

The committee took as a fundamental fact that all traffic should move with equal freedom. We have upon the highways four classes of traffic: (1) Street cars, (2) motor vehicles, (3) horse-drawn vehicles, and (4) pedestrians. The last-named is in the vast majority, and a class to which all belong at some period of the day.

It is needful for the comfort, convenience and well-being of the community that highways be used for vehicular as well as pedestrian traffic, and it is necessary and advisable that all classes of traffic be subject to certain clearly defined rules and regulations. Each class should have consideration for all other classes. If proper courtesy were used by all in their comings and goings there would be little or no difficulty. As conditions now stand, teamsters are anathema to street car men; pedestrians declaim against motorists, while motorists and other drivers of vehicles are frequently irritated by thoughtless pedestrians. Proper conditions and regulations would do away with this. Unnecessary obstruction to any class of traffic should not be permitted, as such obstruction is a failure to respect the proper rights of others, and may be the cause of serious accidents.

Motor traffic, which is comparatively new, has increased rapidly, and until it has found its level in traffic conditions, is bound to be regarded by some with antagonism. While this misunderstanding prevails, many pedestrians are unconsciously and unnecessarily causing drivers of automobiles much anxiety in the operation of their machines. Contrary to common belief in certain classes of the community, the majority of motorists, in the opinion of the committee, is conscientiously anxious to avoid any interference with the rights of others on the public highways.

On the other hand, the committee urges upon all motor drivers the need for courtesy in the use of the streets. Some motorists fail in this, particularly at street intersections when pedestrians are using the cross walks. Pedestrians have equal rights with vehicular traffic at intersections, and motorists should not consider that pedestrians are obliged to clear the road when the horn is sounded.

The committee is of the opinion that laws in respect to speeding should be adequately enforced. High speed is commonly the attribute of careless driving, which is one of the most fruitful causes of accidents, and an interference with others in the proper use of the public highways.

After considerable deliberation the committee submits the following recommendations:—

No. 1. "That every driver of any motor vehicle should have a permit to drive. Permits might be issued at a nominal fee, say twenty-five cents, without examination, upon written application for such permit; the penalty of cancellation or suspension of permit to be inflicted only upon repeated conviction of minor offences or for the committing of a serious offence under the criminal code."

(a) This would give added protection to pedestrians and to motorists.

(b) Carelessness rather than ignorance or incompetence is the cause of the majority of accidents.

(c) Compulsory examination would be cumbersome, expensive, and without proportionate benefit.

(d) The advantage of the permit is the penalty of cancellation, which would be a greater deterrent to carelessness than any reasonable schedule of fines.

(e) The committee feels that driving in an intoxicated condition should be considered a serious offence.

No. 2. "That headlights on motor vehicles should be so arranged that they will not constitute a menace to the public safety, and to be such that no portion of the beam of reflected light, when measured 75 feet or more ahead of the lamps, shall rise above 42 inches from the level on which the vehicle stands."

This would give much-needed protection, not only to pedestrians but to drivers of vehicles as well. This is a standard regulation in such of the United States as have a headlight law.

No. 3. "That all vehicles should keep to the right and as near the curb as circumstances and weather conditions will permit."

This is a Toronto by-law, and the committee urges that it be adopted by all cities and towns of the province, and more rigidly enforced.

No. 4. "That all vehicles should carry a light at night."

The committee suggests that the word "vehicle" include bicycles, tricycles, motorcycles, motor tricycles, motor dray wagons, and all motor vehicles, however propelled, and any other vehicle drawn by horses or other animals.

Traffic conditions have been radically altered by the advent of the motor car. Collisions on the highways between an automobile and a horse-drawn vehicle are apt to be more disastrous to the driver of the horse than to the motorist. Motorists at present are tempted to use strong and glaring headlights in order to avoid collisions with unlighted vehicles. The advantages of strong headlights would be largely discounted if all vehicles carried lights so as to be readily discernible. Were all vehicles to carry suitable lights, one of the most serious elements of danger in driving on the public highway would be overcome and to the great advantage of horse-drawn traffic.

No. 5. "That bicycles should be equipped with a warning signal."

The present common practice of cyclists whistling and shouting at pedestrians is objectionable and unnecessary. The price of a suitable bell is small, and is no hardship to the owner of a wheel.

No. 6. "That bicyclists should be prohibited from attaching themselves to other vehicles in motion."

The practice constitutes a danger to the cyclist, as he may be thrown violently to the ground or under another vehicle.

Bicyclists attach themselves more especially to motors and street cars, and thereby unfairly expose the driver of an overtaking vehicle to the risk of injuring the cyclist.

No. 7. "That pushmobiles, children's hand or express carts and roller skates should not be used on the roadways."

Under modern conditions such regulation is necessary for the safety of the children. Playgrounds provide varied and excellent means of amusement, and should be provided as much as possible not only for the benefits of supervised play but because the children would thereby be kept off the roadways. The committee suggests making as great an increase of playgrounds as possible.

No. 8. "That pedestrians should be considered as a part of traffic on our streets and be subject to regulation."

Similar legislation is in force in all important cities, and would make for increased safety of pedestrians.

At busy street intersections pedestrians should move only with vehicular traffic, under the direction of the traffic officer. This would avoid much confusion and annoyance now caused to pedestrians, and would permit them and all other traffic to move with greater average speed, convenience and safety.

No. 9. "That the Legislature be asked to consider the advisability of placing the responsibility for an accident upon the person injured if the accident occurs while

the pedestrian is crossing a roadway (in cities), between street intersections, or other recognized crossings."

A considerable proportion of accidents to pedestrians is caused by the pedestrian stepping carelessly from the curb, directly in front of a moving vehicle, giving the operator of such vehicle little or no chance to avoid a collision. There is no thought on the part of the committee of relieving the driver of any vehicle from extreme care in avoiding such accidents, but this class of accident is more readily preventable by care on the part of the pedestrian than by equal care on the part of the driver of the vehicle.

The committee submits that this legislation would incline pedestrians to "LOOK" before stepping from the curb.

No. 10. "That intending passengers for street cars should be prohibited from standing on the roadway for an unreasonable time before the street car arrives at the stopping point.

The practice of standing in the roadway to wait for an approaching car is unnecessary, is a menace to public safety, and frequently blocks traffic to an objectionable degree.

The Engineer's Library

Any book reviewed in these columns may be obtained through the Book Department of
The Canadian Engineer, 62 Church Street, Toronto.

CONTENTS.

Book Reviews:

Municipal Engineering Practice. Folwell	448
Laboratory Manual of Bituminous Materials. Hubbard	449
Centrifugal Pumps and Suction Dredges. Sargeant	449
Handbook for Highway Engineers. Harger and Bonney	450
Contracts, Specifications and Engineering Relations. Mead.	450
Engineering Applications of Higher Mathematics—Part IV., Mechanics of Materials. Karapetoff..	450
The Stability of Arches. Sprague	451
Canadian Iron and Steel Industry. Donald	451
Electrical Tables and Engineering Data. Horstmann and Tousley	451
Electric Motors, Direct and Alternating. Moreton	452

Publications Received	452
Catalogues Received	452

BOOK REVIEWS.

Municipal Engineering Practice. By A. Prescott Folwell. Published by John Wiley & Sons, Inc., New York; Canadian selling agents, Renouf Publishing Co., Montreal. First edition, 1916. 422 pages, 113 illustrations, 6 x 9¼ ins., cloth. Price, \$3.50 net. (Reviewed by A. F. Macallum, commissioner of works, Ottawa.)

The author of this book is already well known through his previous works on water supply and on sewers. In "Municipal Engineering Practice" he has wisely left out the subjects of water supply, sewers and street pavements as these are already thoroughly treated in several well-known text books, and confines himself to the discussion

of the other branches of municipal engineering. There are chapters on fundamental data, city planning, street surface details, bridges and waterways, city surveying, street lights, signs and numbers, street cleaning and sprinkling, disposing of city wastes, markets, comfort stations and baths, parks, cemeteries and shade trees.

The book is profusely illustrated and contains many excellent tables, although some of them are too limited in their application to be generally useful.

The chapter on fundamental data deals principally with population density and forecasts for residential and business districts.

City planning takes up in a very concise manner skeleton outlines for proposed developments with diagonal streets and the intersections of streets at acute angles and also at different elevations. It touches also upon sidewalks at different elevations from pavements and has several tables on traction and grades.

Street surface details, such as curbs, gutters and sidewalks, are fully discussed in the next chapter and the specification of the National Association of Cement Users is given for cement sidewalks. Other street details, such as crossings, isles of safety, telephone poles, fountains and cabstands, are given, besides typical track construction methods of several cities.

The chapter on bridges and waterways touches very lightly on these subjects. Types of bridges are recommended for different spans and the loading considered necessary. In waterways, methods are shown for preventing the erosion of banks.

"City Surveying" chapter gives methods of precise levelling and general instrument work. It takes up also the underground surveys and plans necessary for the location of all subsurface structures, such as sewers, gas mains, etc.

The chapter on street lights, signs and numbers is important as discussing matters not often found in text books. The amount of lumination, kind of lamps, location, height and distribution, with a contract and specification, are given.

Different methods for house numbering, which is very essential, judging by house numbering in most cities. Street signs are indicated more by illustrations given, but different methods and locations are discussed fully.

In the chapter on street cleaning and sprinkling, hand and machine sweeping, with unit costs, are given for several cities. The use of water and oil, with unit costs, is also discussed.

The disposal of city wastes is gone into very carefully for a book of this nature. This is a subject upon which there is comparatively little literature and the collection and disposal by means of reduction, incineration and other methods is treated in a very concise manner.

Markets, comfort stations and baths and also parks, cemeteries and shade trees are outlined in short chapters, but in a thorough manner.

This book is a very valuable contribution to municipal literature and is especially valuable to the municipal engineer who has a report to make upon any of the subjects outlined above. Most of the "padding" usually found in so many text books has been practically eliminated and the subject matters condensed almost to hand-book form.

Laboratory Manual of Bituminous Materials. By Prevost Hubbard, Chemical Engineer, Chief, Division of Road Material Tests and Research, Office of Public Roads and Rural Engineering, U.S. Department of Agriculture. Published by John Wiley & Sons, Inc., New York; Canadian selling agents, Renouf Publishing Co., Montreal. First edition, 1916. 153 pages, 38 illustrations, 7 tables, 35 additional pages for notes, 6 x 9 $\frac{1}{4}$ ins., cloth. Price, \$1.50 net. (Reviewed by E. D. Gray, Imperial Oil Co., Limited, Toronto.)

The author's idea is that the book as published "should serve as a laboratory guide for the student of highway engineering." As such, it is an excellent work. Moreover, it embodies sufficient fundamental and developed detail to merit a place in the library of every highway engineer. It does not contain a great deal of new material: rather it is a selection and compilation of the various tests used on bituminous materials. Many of these have never heretofore appeared in print save in pamphlet form.

Part I. is a general treatise on the scope and use of the Manual. It furnishes, as a working basis, a series of the most recent, standardized and authoritative definitions, a knowledge of which is essential to intelligently pursue the outlined experimental work. The initial tests recorded and minutely explained are those required to identify and differentiate the following bituminous materials: (1) Fluid petroleum products and emulsions; (2) semi-solid and solid petroleum and asphalt products; (3) refined tars and tar pitches; (4) creosoting oils; (5) bituminous aggregates.

The subsequent tests are those constantly used to determine the value of individual materials for their respective road uses. Many of these are essential in drawing up specifications for the intelligent purchasing of these bituminous materials.

A most important feature of the work is the interpretation or explanation of the value of each test. These individual discussions, while necessarily brief, are wholly unbiased and to the point. It has been extremely unfortunate that in the past so many fallacious theories,

propounded by chemists in the pay of vendors of various bituminous materials, have received wide credence. They have attained their commercial desire in securing many "closed" specifications. To the engineer or public official who desires to purchase bituminous materials under a specification sufficiently rigid to exclude inferior materials, yet elastic enough to permit those of unquestioned quality to compete, the book cannot be recommended too highly.

Centrifugal Pumps and Suction Dredges. By E. W. Sargeant. Published by Chas. Griffin & Co., Limited, London. 188 pages, 160 illustrations, 14 folding plates, 6 x 9 ins., cloth. Price, \$2.75. (Reviewed by R. N. Austin, general manager, Turbine Equipment Co., Limited, Toronto.)

The author of this book is a well-known authority on centrifugal pumps in England. He has had an extensive experience in designing low-lift pumps for dredging, dry-dock, irrigation and sewage purposes, and his present book deals mostly with pumps for low head conditions.

Outstanding features which will appeal strongly to the reader are the simple methods employed in explaining the principles involved in the design and operation of centrifugal pumps, and several chapters serve to emphasize Mr. Sargeant's thorough practical knowledge of this type of pumping machinery.

Chapter 1, which is historical, is happily brief.

Chapter 2 shows clearly the path of the water in the impeller as it flows from the eye to the periphery, and also graphical methods of setting out the different velocities.

In Chapters 3 to 6 the author assumes certain conditions of capacity, head and speed, and designs pumps to meet them, showing clearly his figures used in arriving at the correct areas for the different parts of the volute from tongue to the throat. The impeller, eye, periphery, vane angles, etc., are similarly dealt with, examples being taken of both single and double suction impellers, and of both the open and closed type.

In Chapter 7 some good practical information is given respecting pattern-making, moulding and machine-shop work, and a good type of balancing device for balancing pump impellers is illustrated and described.

Multi-stage pumps are dealt with in Chapters 9 and 10, and bi-rotor and tri-rotor types in Chapter 11.

Chapters 13 and 14, relating to priming, are decidedly useful, and Chapter 16, describing and illustrating various piping and valve arrangements, contains many valuable suggestions and again demonstrates the author's practical knowledge of this extremely important branch. A great number of centrifugal pump troubles can be traced to poor arrangement of piping and valves, especially the suction.

The remainder of the book, with the exception of three chapters, is devoted to pumps for irrigation, dock and dredging work, and here is where the author excels. In the majority of recent books on centrifugal pumps these classes of work have been almost entirely ignored. Mr. Sargeant, however, deals with them in great detail, and as an expert, and the reader will obtain information found in no other treatise on the subject of centrifugal pumps.

Chapter 21 deals briefly with fire pumps and Chapter 23 with rotary air pumps. Chapter 22, relating to steam turbine-driven pumps, is rather disappointing, and apparently the author is not familiar with the most modern practice in this respect, the double helical geared form of drive between turbine and pump being entirely omitted from his remarks.

Everyone interested in this branch of engineering would be well advised to add Mr. Sargeant's book to his library.

Handbook for Highway Engineers. By Wilson G. Harger, C.E., and Edmund A. Bonney. Published by the McGraw-Hill Book Co., Inc., New York. Second edition, 1916. 609 pages, illustrated, flexible leather. Price, \$3.00 net. (Reviewed by W. A. Morris, engineer, The Asphalt and Supply Co., Limited, Montreal.)

This book contains a great deal of information that is both useful to the engineer who is not particularly identified with road construction, to the municipal officer and to the contractor who has in many cases to work out his own specifications when dealing with unusual problems as they may occur under work done for small municipalities.

It also gives considerable cost data of the various classes of pavement that may be useful to the estimator on the various items that will invariably crop up in the construction of both suburban and rural township roads.

Useful information is given on grades, and how to construct the work thereto. Also particular care is paid to the various designs of pavements to meet the different classes of traffic and location.

There are typical specifications of the various kinds of pavements and the many classes of material that are usually required along and under the line of work. While it is not advisable to take these specifications as definite to meet all conditions and locations, they will form an excellent base for the designer to work upon. There is a number of useful tables together with extracts from the traffic regulations as adopted by the State of New York.

The work is comprehensive, and is published in such a size that it may be used both in the office and on the work without inconvenience.

Contracts, Specifications and Engineering Relations. By Daniel W. Mead, Professor of Hydraulic and Sanitary Engineering, University of Wisconsin. Published by McGraw-Hill Book Co., New York. 535 pages, 37 figures, 6 x 9 ins., cloth. Price, \$3.00 net.

The author has discussed some of the important relations of the engineer and architect to practical life with which it seems essential that the technical man should become familiar before entering professional service. Legal and contractual relations are but briefly discussed, while the principles of personal and ethical relations are reviewed in greater detail. Preparation of specifications is given considerable space.

The book adopts a very high and inspiring tone throughout. The author practically summarizes his text in the preface, when he says that "if a young man has given no thought to moral and ethical principles, he is apt to assume that such principles are cant and that unethical methods and actions are common to all those in business and professional life and are therefore essential to his personal success. He should be advised and assured of the facts in the case: that the best and most successful men in every business and profession are those men of high ideals whose honesty and integrity are unquestioned and whose character and reputation are regarded as the greatest and most valuable of their possessions."

Under the heading of "Success in the Engineering Profession," the factors of success that must be recognized are discussed in detail, such as opinions of the engineering profession, judgment, self knowledge, personal

bias, bias of special knowledge, bias of personal experience, bias of local experience, bias of personal interest, bias of association, personality, personal appearance, collaboration, literature, etc.

There are many statements in the book with which some engineers will disagree, but which are interesting nevertheless, and which may be true in many cases. For instance, Mr. Mead states that it has been established by common experience that all men are to a greater or less degree biased in their judgment of themselves and of others, and of all problems and conditions with which they come in contact. "That this bias is possessed by others," he says, "and injuriously affects their judgment is easily recognized. It is more difficult for the individual to recognize such bias in himself. It is however most important for the engineer to recognize his own bias and to provide for it by elimination so far as possible, and by the same factors of safety which he applies to other uncertainties. To acquire this knowledge is perhaps the most difficult in the practical education of the engineer."

Considerably less than half of the book is taken up by the consideration of ethical, professional and personal relations, but it is probably the most valuable portion of the book, in so far as ideas for the reader are concerned.

The portion of the book which deals with these personal problems takes it out of the ordinary run of text books, and marks it as a peculiarly significant addition to any engineer's library.

There is much of concrete value in the book, such as sample contracts and specifications, illustrations of drawings for specifications, ambiguous specifications, instructions to bidders, securing low bids, force account, cost plus percentage, appropriation of public utilities, enforcement of law, bibliography of specifications, etc.

Unfortunately for Canadian readers, however, the value of some parts of the latter portions of the book are considerably restricted by the difference between the United States and Canadian laws, as undoubtedly much that would apply in the United States would not apply under Canadian statutes.

The bibliography appears to take little or no account of Canadian research or studies, and in some minor ways such as these the book is not international in character; but despite that fact, most engineers in Canada will find this book well worth while for psychological reasons alone, even disregarding its considerable quantity of other useful information.

Engineering Applications of Higher Mathematics—Part IV., Mechanics of Materials. By V. Karapetoff, Professor of Electrical Engineering in Cornell University, Ithaca, N.Y. Published by John Wiley & Sons, Inc., New York; Canadian selling agents, Renouf Publishing Co., Montreal. First edition, 1916. V+81 pages, 5¼ x 8 ins., cloth. Price, 75c. (Reviewed by John McGowan, B.A., Professor of Applied Mechanics, University of Toronto.)

The author in his preface says this book is for "a student or an engineer who wishes to review calculus or analytics, or to acquire facility in application of higher mathematics to engineering problems." At the foot of page 6 he says in a note: "The student will find proof of this fundamental formula in any standard work on mechanics of materials." A similar statement occurs concerning the theory of flexure on page 33.

The topics include: 1, beams; 2, fatigue of materials; 3, columns; 4, strength of thick cylinders and spheres.

The object of the book and its position among other books is thus explained. It presupposes a training in calculus and in mechanics of materials.

The small amount of theory is handled briefly and clearly. The mathematics are simple in appearance and do not give rise to lengthy expressions in development or on final results. The author has advanced ideas about the requirements in mathematics for engineering students. In this volume, however, he has not gone too far in the use of mathematics or in the kind of mathematics used.

An important feature of the book is that each chapter contains a set of examples, or problems, of varying degrees of difficulty. Some of these examples have hints for their solution and some have complete solutions. The examples serve to develop the theory further in special directions.

The study of this volume would help the student very greatly in obtaining a grasp of his theory, and a power over it, in each of the important topics in mechanics of materials. Its brevity and clearness should commend it to any student or engineer interested in continuing his studies beyond the elementary work taken in the early years of the college course.

The Stability of Arches. By Ernest H. Sprague, A.M. Inst.C.E. Published by Scott, Greenwood & Son, London. 141 pages, $7\frac{1}{2} \times 4\frac{3}{4}$ ins., 5 folding plates, 58 diagrams, cloth. (Reviewed by H. Feldbet, designing engineer, Curry & Sparling, architects, Toronto.)

A brief analysis of the three main types of arches. The main ground covered by the author includes:—

(1) An analysis of the three-hinged arch showing the determination of the line of pressure, and the relation of the line of pressure to Eddy's theorem for determining the bending moment at any point in the arch ring. An example of the method of solution of this type of arch by (a) graphics, (b) the use of influence plans.

(2) A short and clear derivation of the fundamental formulas for distortion of the arch ring to bending, axial thrust and temperature changes.

(3) The derivation of a general formula which makes possible the fixing of the position of the true line of pressure in a two-hinged arch.

(4) The derivation of general equations for bending moment at any section of a symmetrical hingeless arch under vertical loading. This derivation is particularly clear. The author combines the results of Eddy's Theorem with the general formulas for distortion of the arch ring and then simplifies the resulting expression by the proper location of the co-ordinate axes and the proper subdivision of the arch ring so as to make $ds \div I$ a constant. An example of the application of the formulas derived to a typical arch problem.

(5) General notes on the arch such as (a) the critical line of pressure, (b) the rule of the middle third, (c) the principle of "least work," and so forth.

(6) An interesting mathematical analysis of the form of arch ring by Tolkmitt. Some of the common and empirical formulas used in the preliminary design of arches.

(7) Notes on loads and stresses in the arch ring.

Canadian Iron and Steel Industry. By W. J. A. Donald, Ph.D. Published by McClelland, Goodchild & Stewart, Limited, Toronto. Price, \$2.00.

"General Canadian industrial development has built up an increasing market for iron and steel. It has called for the building of railways which has always resulted in

an increase in the Canadian iron and steel industry. It has resulted in the discovery of ores of considerable importance and it has found the labor supply and the capital necessary for large industrial undertakings. These minor phases of Canadian development are themselves interrelated. The whole process of Canadian economic organization goes far to explain the recent development of the iron and steel industry. Meanwhile the fact that the industry is so intimately connected with every phase of Canadian economic life suggests the condition of success, and demands that a wise commercial policy in respect to iron and steel shall not retard any phase of that Canadian future which seems so promising."

In these words Dr. Donald concludes his instructive book on "The Canadian Iron and Steel Industry." It is a comprehensive study of the economic history and problems of a leading Canadian industry and makes a substantial contribution to the comparatively few studies of its kind.

The volume is divided into four parts: I. The Economic Background; II. Natural Resources; III. Iron and Steel Industry, 1879-1897; IV. Iron and Steel Industry, 1897-1914. There are several appendices and a bibliography.

Electrical Tables and Engineering Data. By Henry C. Horstmann and Victor H. Tousley. Published by Frederick J. Drake & Co., Chicago. 331 pages, illustrated, $4\frac{1}{2} \times 6\frac{1}{2}$ ins. Price, cloth \$1.00; leather \$1.50. (Reviewed by Alfred S. L. Barnes, Ontario Hydro-Electric Power Commission, Toronto.)

The dimensions of this book are $4\frac{1}{2} \times 6\frac{1}{2} \times \frac{5}{8}$ ins., thus it is of a handy pocket size.

The preface sets forth that it is an attempt to furnish electricians, and others interested in electrical work, with a reference and table book. It is also stated that the tables provided assist in the calculation of almost every conceivable problem with which construction men would have to deal. The word "construction" must be interpreted as applying to electrical construction.

The book contains an immense amount of information and the authors must have been at some pains to collect and arrange it as they have done. Their claim that "the tables assist in the calculation of almost every conceivable problem," does not seem to be exaggerated. Each subject dealt with is, of course, referred to briefly, yet all the notes are of a practical nature, and such as will be helpful to those interested.

A great mass of information is contained in the numerous tables, some of which deal with subjects which are not usually found in small publications of this character. One table shows the maximum amount of capital which may be economically invested to substitute a larger conductor for the smallest one permissible for a given length of run, and there are very complete tables showing, for single, two and three-phase motors, the proper size of wire to be used for given voltages and horse-powers. Details of aluminum, copper-clad, steel, German silver and galvanized wires are also given.

A good deal of space is devoted to the subject of illumination, and besides a considerable number of useful practical notes there is a great deal of matter given in tabular form.

Brief notes are given on installation work for a large number of different classes of premises. The information given throughout the book is arranged in alphabetical order and with a little familiarity it should be quite easy to find.

Electric Motors, Direct and Alternating. By David Penn Moreton, B.S., E.E. Published by Frederick J. Drake & Co., Chicago. 24 pages, illustrated, $4\frac{1}{4} \times 6\frac{3}{4}$ ins. Price, \$1.00 cloth binding; \$1.50 leather.

In this book the author deals with the subject in such a way that it will be of the greatest assistance to the practical electrician.

The first few chapters of the book deal with the first principles of electrical and magnetic circuits; Chapter 4 treats of the common methods of measuring current pressure resistance and power; Chapters 5 and 9 are given over to the treatment of armature windings for direct and alternating current motors; Chapters 6, 7 and 8 are devoted to descriptions of the various types of current motors, their construction and operation. In Chapters 10, 11 and 12 are given descriptions of the various types of alternating-current motors, as well as methods of starting and operating and the general care of such motors.

PUBLICATIONS RECEIVED.

Ontario Railway and Municipal Board.—Tenth annual report to December 31st, 1915.

Regulations Respecting Township Road Superintendents, 1916.—Appendix to the annual report of the Ontario Department of Public Highways.

Queen Victoria Niagara Falls Park.—Thirtieth annual report, 1915, of the commissioners for the Queen Victoria Niagara Falls Park, Niagara Falls, Ont.

Geology of the Nanaimo Map-Area.—Memoir 51, being No. 43 of the Geological Series, Geological Survey, Department of Mines, Ottawa, by Charles H. Clapp.

Melting Aluminum Chips.—Bulletin 108, Mineral Technology 14, of the Department of the Interior, Washington, D.C., by H. W. Gillett and G. M. James.

Road Construction.—For township road superintendents and overseers. Appendix to the annual report of the Department of Public Highways of Ontario, 1916.

Late Pleistocene Oscillations of Sea-level in the Ottawa Valley.—By W. A. Johnston. Museum Bulletin No. 24. Geological Series No. 33, Department of Mines, Canada.

Progress Reports of Experiments in Dust Prevention and Road Preservation, 1915.—Bulletin No. 407 of the United States Department of Agriculture, Washington, D.C.

Sewage Disposal.—Report of the highway and sewerage committee of the city of Sheffield, England, for the year ended March 25th, 1916. Manager, John Haworth, F.C.S.

Map of Manitoba, Saskatchewan and Alberta, prepared in the Railway Lands Branch, Department of the Interior, Ottawa, under the direction of F. C. C. Lynch, superintendent.

Seventh Annual Report of the Board of Supervising Engineers, Chicago Traction, covering the fiscal year ended January 31st, 1914. Published by the Board, Chicago, Ill., 1916.

The Pleistocene and Recent Deposits of the Island of Montreal.—Memoir 73, being No. 58 of the Geological Series, Geological Survey, Department of Mines, Ottawa, by J. Stansfield.

Economic Surveys of County Highway Improvement.—Bulletin No. 393 of the United States Department of Agriculture, Washington, D.C., by J. E. Pennybacker and M. O. Eldridge.

Chemical and Biological Survey of the Waters of Illinois.—Report for year ended December 31st, 1914, issued by the University of Illinois, Urbana, Ill. Edward Bartow, Director.

Metal Mines and Smelters in Canada.—List of metal mine and smelter operators in Canada. Issued by the Mines Branch, Department of Mines, Ottawa. Eugene Haanel, Ph.D., Director.

Weathering of Coal.—Extra volume supplementing Report No. 83 on the Coals of Canada. By J. B. Porter, E.M., Ph.D., D.Sc. Published by the Mines Branch, Department of Mines, Ottawa.

Conservation of Fish, Birds and Game.—Report of the proceedings of the committee, Commission of Conservation, Ottawa, on fisheries, game and fur-bearing animals, at their meeting on November 1st and 2nd, 1915.

Modules and Uniform Discharge Devices for Irrigation and Waterworks.—Reprint from proceedings of the Institute of Mechanical Engineers of Great Britain. Paper presented by Hugh Munroe, member of the Institution.

The Trent Valley Outlet of Lake Algonquin and the Deformation of the Algonquin Water-Plane in Lake Simcoe District, Ontario.—By W. A. Johnston. Museum Bulletin No. 23, Geological Series No. 32, Department of Mines, Canada.

The Concrete Road.—A paper prepared by Edward N. Hines, chairman of the Board of County Road Commissioners, Wayne County (Mich.), and read before the meeting of the Portland Cement Association, in Detroit, September 13, 1916. Published by the Portland Cement Association, 111 West Washington Street, Chicago, Ill.

Structural Steel Specifications.—Reprint of the standard specifications for structural steel for bridges and buildings, as recommended by the Canadian Society of Civil Engineers and adopted by the Dominion Bridge Co., Limited, Montreal. The latter firm have printed the specifications in very neat form for gratuitous distribution to engineers. They are bound in flexible leather and are presented in very handy reference form, with index, memorandum pages, etc.

CATALOGUES RECEIVED.

Cold Saw Cutting-off Machines.—Catalogue No. 51 of the Newton Machine Tool Works, Inc., Philadelphia, Pa. Contains 51 pages and is well illustrated.

Safety Code for the use and care of abrasive wheels and the parts of grinding machines related thereto. A 13-page leaflet issued by the Star Corundum Wheel Co., Detroit, Mich.

Pedlar's Saino All-Metal Fire Door.—A 36-page illustrated booklet issued by The Pedlar People, Limited, Oshawa, Ont., giving complete technical information regarding this well-known fireproofing product.

Star Grinding Wheels.—Catalogue No. 9 of the Star Corundum Wheel Co., Detroit, Mich., describing the making of Star grinding wheels by three distinct processes, *viz.*, vitrified, silicate and elastic. Contains 99 well-illustrated pages.

London Concrete Mixers.—Illustrated booklet issued by The London Concrete Machinery Co., Limited, London, Ont., describing their different types of mixers. The booklet also contains a number of testimonials from firms who have purchased mixers.

Building Construction.—Second edition of a booklet issued by the Stone and Webster Engineering Corporation, Boston, Mass., describing and illustrating industrial plants, office and educational buildings, power stations and warehouses constructed by the company.

Editorial

THE MONTREAL AQUEDUCT REPORT.

"The present project should never have been started, and we are firmly of the opinion that all thought of completing it, along the present lines, should be abandoned." This sentence from the ratepaying engineers' report upon the Montreal aqueduct should sound the death-knell of the scheme in its present form. It is the well-considered opinion of thirty of Canada's leading engineers. They claim that by abandoning or greatly modifying the project, a capital expenditure of about five million dollars could be saved. Does the Board of Control of Montreal intend to go ahead with the present plans in view of this expert report? If so, some public-spirited taxpayer should secure an injunction to prevent the controllers from wasting the city's money.

GET READY FOR PEACE!

In an address delivered a couple weeks ago before the Empire Club at Toronto, Sir George Foster pointed out that the moment the war ends, the wheels of munition industries would cease to turn. Then the manufacturer would have to hustle for the customers who had not known him very well for two or three years past.

"Is it best to wait until that time comes," asked the Minister of Trade and Commerce, "and in the maze of dislocated activities try and work out what we should do for the future? Or shall we prepare for it as best we can?"

"Let me say in all kindness, but with all truth," continued Sir George, "there is not a great country that I know of which is so sound asleep in that regard as Canada."

The Minister's warning could be taken to heart with advantage by most Canadian manufacturers. The first and most profitable step in renewing acquaintances with the trade in your "regular lines" is to restore your advertising appropriations to normal in the trade and technical papers which reach the buyers of your material. The public memory is short. Why be among the unknown when the war is over, while some more persistent and progressive advertiser walks away with your share of the trade?

THE BLACKLIST.

At the Paris economic conference, where Canada was represented by its trade minister, Sir George Foster, one of the unanimous decisions reached was that for the period of the war at least, citizens of the allied countries should not trade with the enemy. That point was emphasized by Sir George Foster in speaking of the Conference to the Toronto Canadian Club not long ago.

The countries allied with Canada in the present war and in the decisions of the Paris conference must surely be astonished at the way in which this Dominion has forgotten its subscription to the promise not to trade with the enemy during the war at least. On July 18th, 1916, the British government established what is known as a blacklist of firms in the United States with which citizens of the United Kingdom are forbidden to trade. A similar

blacklist was established by Australia shortly afterwards. The Canadian government, after four months for consideration, has not yet seen fit to follow the example of the Imperial and Australian governments. The blacklist of United States firms does not yet apply in Canada.

In other words, while it is illegal for citizens of the United Kingdom and of Australia to trade with these enemy firms, classed as such by the British government after careful investigation, it is legal for Canadians to trade with such enemy firms. Business has been done by Canadians with some of these firms.

What weighty considerations are preventing the authorities at Ottawa from taking the proper action?

LETTER TO THE EDITOR.

Occupation for Wounded Soldiers.

Sir,—The soldier owes much to electricity. Success in battle is largely due to knowledge of the enemy's position and movements, often gained by wireless signalling from aeroplanes, and to the rapid transmission of that knowledge, and the consequent orders, by telephone and telegraph.

Our command of the sea is perfected and maintained largely by wireless electric communications between our ships and between ship and shore.

Mr. George Iles, a Canadian writer, who has devoted much attention to this subject, writes to the Military Hospitals Commission, suggesting that electricity may also furnish a congenial and profitable occupation for many of these soldiers when they leave hospital.

Electric smoothing irons, toasters, heaters, lamps, motors, sweepers and tools are very popular where they have been introduced. Their popularity is bound to go on increasing as they become better known, and a large increase of output will bring about a decrease in price when normal times return. The price of electric current has been reduced already, thanks to the partial development of our magnificent water-powers.

A blind officer, Lieut. Edwin Baker, one of the few Canadian soldiers who has lost the sight of both eyes, has just been appointed to a position on the engineering staff of the Ontario Hydro-Electric Power Commission. Mr. Iles suggests that many other Canadian veterans, unfitted for hard, muscular work, might well be employed as canvassers and demonstrators in popularizing electrical appliances throughout the country.

The battle of the Somme, where Canadians have played so conspicuous and heroic a part, is sending home hundreds of men unable to rejoin the fighting ranks, and thousands of our disabled men had returned even before that great battle had begun.

Every suggestion of useful and profitable employment for injured soldiers, therefore, is to be warmly welcomed. The brains as well as the sympathies of the nation must be actively engaged in promoting the success of this national enterprise.

H. A. KENNEDY,
Military Hospitals Commission.

22 Vittoria St., Ottawa, Nov. 14, 1916.

PERSONAL.

NEIL G. BEGGS, architect, Toronto, has accepted a commission in the Canadian Engineers.

H. R. McMILLAN, chief forester of British Columbia, has resigned his position to enter the lumber business.

H. J. STANDER, of Brunswick, Ga., will superintend experimental flotation work for the Mond Nickel Co. at Coniston, Ont.

BRUCE RITCHIE, formerly on the engineering staff of the Consolidated Mining and Smelting Co., Trail, B.C., has won the D.S.O. at the front.

J. H. McMILLAN, of Cumberland, B.C., has been appointed inspector of mines in Northern British Columbia with headquarters at Prince Rupert.

BION J. ARNOLD, M.Am.Soc.C.E., of Chicago, tramways expert, has been appointed by the board of control of Montreal to investigate and report upon the tramways question.

J. G. SULLIVAN, chief engineer of C.P.R. western lines, with headquarters at Winnipeg, has been elected first vice-president of the American Railway Engineering Association.

GEORGE W. CRAIG, city engineer of Calgary, Alta., will go to Moose Jaw, at the request of the city commissioners, to give engineering testimony on matters pertaining to sewer construction.

W. K. GWYER, formerly on the engineering staff of the C.N.R., has succeeded G. P. NAPIER as assistant engineer of the public works department at Victoria, B.C., Mr. Napier having enlisted for active service.

Dr. HORACE L. BRITAIN, director of the Bureau of Municipal Research, Toronto, will address the members of the Engineer's Club of Toronto this evening on "Participation of the Citizens in Government."

F. W. TEELE, formerly vice-president and general manager of the Porto Rico Railways Co., has been elected vice-president of the Southern Canada Power Co., Montreal, and J. B. WOODYATT has been appointed manager.

E. H. HAMILTON has been appointed manager of the spelter plant of the Consolidated Mining and Smelting Co., Limited, Trail, B.C., succeeding F. W. GUERNSEY, who has joined the staff of W. H. Aldridge at San Francisco, Cal.

C. H. NEEDS, A.M.Can.Soc.C.E., formerly of Toronto and now of Galt, Ont., is leaving for England this week, having enlisted in the Canadian Aviation Corps. Prior to the war, Mr. Needs was resident engineer of the Canadian Northern Railway. Since the outbreak of war he has been an inspector of munition plants with the Canadian Inspection Co., principally of plants at Galt. This position he has just resigned in order to enlist.

OBITUARY.

ARTHUR H. CHADWICK, director and manager of the Canadian Chadwick Metal Co., of Hamilton, Ont., died on November 8th, aged 50.

JOHN BANNERMAN, a well-known resident of Ottawa, passed away recently, following an operation. He was born in Scotland 66 years ago and came to Canada at an early age, settling in Ottawa. Formerly he was a member of the firm of Powers & Bannerman, and constructed the first main for the Ottawa waterworks system.

DAVID McNICOLL, of Montreal, formerly vice-president and general manager of the Canadian Pacific Railway Co., died on November 26th at Guelph, Ont., after a protracted period of ill-health. Mr. McNicoll was born in Arbroath, Scotland, 66 years ago, and came to Canada in 1874. He retired from the C.P.R. two years ago.

Sir HIRAM MAXIM, inventor of the automatic system of firearms, died at his home in London, England, on November 24th. Born in Sangerville, Maine, on February 5, 1840, he was a descendant of English Puritans. After a meagre schooling he went to work in a machine shop. At 28 he was a draftsman in a large steamship building concern in New York City, where he invented a new locomotive headlight, which was very successful. He also did much to perfect automatic gas machines for lighting private houses. In 1877 he took up the study of electricity, and was among the first to make dynamo electric machines and electric lamps in the United States. In 1881 he was made a Chevalier of the French Legion of Honor. The Maxim automatic gun was invented in 1884 in London, and was immediately adopted by the British government, which used it in the war with the Matabele in Africa. The gun fired 600 rounds a minute. Some years later Sir Hiram, created a baronet by Queen Victoria after having become naturalized as an Englishman, invented the first smokeless powder. In 1894 he invented a heavier than air flying machine which raised itself from the ground carrying a driver and passenger. This was nine years before the first practicable aeroplane was created by the Wright brothers. Sir Hiram's machine was a ponderous affair, and broke down in its early trial. In 1915 the inventor was appointed a member of the Inventions Board created by the British government to meet the needs of the war.

DECEMBER MEETINGS.

PAVING BRICK INSTITUTE. Meeting in Cleveland at Statler, December 5-6. Assistant Secretary, H. M. Macdonald, 830 Brotherhood of Loc. Engrs. Bldg., Cleveland, Ohio.

AMERICAN ASSOCIATION OF STATE HIGHWAY OFFICIALS. Annual meeting, St. Louis, Mo., December 5-7. Secretary, Dr. Joseph Hyde Pratt, Chapel Hill, N.C.

AMERICAN SOCIETY OF MECHANICAL ENGINEERS. Annual meeting, New York, N.Y., December 5-8. Secretary, Calvin W. Rice, 239 West 39th Street, New York.

NORTHWESTERN ROAD CONGRESS. Third annual meeting at Hotel Sherman, Chicago, December 7-8, 1916.

PORTLAND CEMENT ASSOCIATION. Annual meeting, New York, N.Y., December 11-13. Assistant to General Manager, A. H. Ogle, Chicago, Ill.

SOCIETY OF AMERICAN BACTERIOLOGISTS. Annual meeting, New Haven, Conn., December 26-28. Secretary, Dr. A. Parker Hitchens, Glenolden, Pa.

OKLAHOMA SOCIETY OF ENGINEERS. Annual meeting in Tulsa, December 27-28. Secretary, H. G. Hinckley, Oklahoma City.

AMERICAN STATISTICAL ASSOCIATION. Annual meeting, Columbus, O., December 27-30. Secretary, Carroll W. Doten, 491 Boylston Street, Boston, Mass.