

**CIHM
Microfiche
Series
(Monographs)**

**ICMH
Collection de
microfiches
(monographies)**



Canadian Institute for Historical Microreproductions / Institut canadien de microreproductions historiques

© 1997

Technical and Bibliographic Notes / Notes techniques et bibliographiques

The Institute has attempted to obtain the best original copy available for filming. Features of this copy which may be bibliographically unique, which may alter any of the images in the reproduction, or which may significantly change the usual method of filming are checked below.

- Coloured covers / Couverture de couleur
- Covers damaged / Couverture endommagée
- Covers restored and/or laminated / Couverture restaurée et/ou pelliculée
- Cover title missing / Le titre de couverture manque
- Coloured maps / Cartes géographiques en couleur
- Coloured ink (i.e. other than blue or black) / Encre de couleur (i.e. autre que bleue ou noire)
- Coloured plates and/or illustrations / Planches et/ou illustrations en couleur
- Bound with other material / Relié avec d'autres documents
- Only edition available / Seule édition disponible
- Tight binding may cause shadows or distortion along interior margin / La reliure serrée peut causer de l'ombre ou de la distorsion le long de la marge intérieure.
- Blank leaves added during restorations may appear within the text. Whenever possible, these have been omitted from filming / Il se peut que certaines pages blanches ajoutées lors d'une restauration apparaissent dans le texte, mais, lorsque cela était possible, ces pages n'ont pas été filmées.
- Additional comments / Commentaires supplémentaires: Various pagings.

L'Institut a microfilmé le meilleur exemplaire qu'il lui a été possible de se procurer. Les détails de cet exemplaire qui sont peut-être uniques du point de vue bibliographique, qui peuvent modifier une image reproduite, ou qui peuvent exiger une modification dans la méthode normale de filmage sont indiqués ci-dessous.

- Coloured pages / Pages de couleur
- Pages damaged / Pages endommagées
- Pages restored and/or laminated / Pages restaurées et/ou pelliculées
- Pages discoloured, stained or foxed / Pages décolorées, tachetées ou piquées
- Pages detached / Pages détachées
- Showthrough / Transparence
- Quality of print varies / Qualité inégale de l'impression
- Includes supplementary material / Comprend du matériel supplémentaire
- Pages wholly or partially obscured by errata slips, tissues, etc., have been refilmed to ensure the best possible image / Les pages totalement ou partiellement obscurcies par un feuillet d'errata, une pelure, etc., ont été filmées à nouveau de façon à obtenir la meilleure image possible.
- Opposing pages with varying colouration or discolorations are filmed twice to ensure the best possible image / Les pages s'opposant ayant des colorations variables ou des décolorations sont filmées deux fois afin d'obtenir la meilleure image possible.

This item is filmed at the reduction ratio checked below /
Ce document est filmé au taux de réduction indiqué ci-dessous.

10x																				
	12x		16x		20x		24x		26x		28x		30x		32x					

The copy filmed here has been reproduced thanks to the generosity of:

National Library of Canada

The images appearing here are the best quality possible considering the condition and legibility of the original copy and in keeping with the filming contract specifications.

Original copies in printed paper covers are filmed beginning with the front cover and ending on the last page with a printed or illustrated impression, or the back cover when appropriate. All other original copies are filmed beginning on the first page with a printed or illustrated impression, and ending on the last page with a printed or illustrated impression.

The last recorded frame on each microfiche shall contain the symbol \rightarrow (meaning "CONTINUED"), or the symbol ∇ (meaning "END"), whichever applies.

Maps, plates, charts, etc., may be filmed at different reduction ratios. Those too large to be entirely included in one exposure are filmed beginning in the upper left hand corner, left to right and top to bottom, as many frames as required. The following diagrams illustrate the method:

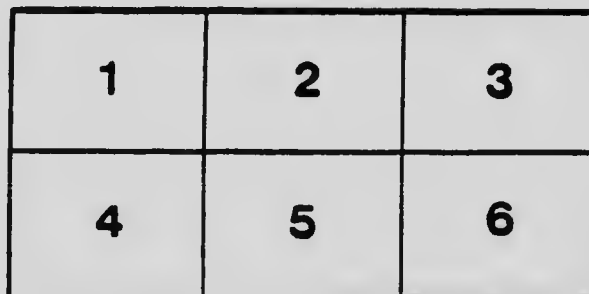

L'exemplaire filmé fut reproduit grâce à la générosité de:

Bibliothèque nationale du Canada

Les images suivantes ont été reproduites avec le plus grand soin, compte tenu de la condition et de la netteté de l'exemplaire filmé, et en conformité avec les conditions du contrat de filmage.

Les exemplaires originaux dont la couverture en papier est imprimée sont filmés en commençant par le premier plat et en terminant soit par la dernière page qui comporte une empreinte d'impression ou d'illustration, soit par le second plat, selon le cas. Tous les autres exemplaires originaux sont filmés en commençant par la première page qui comporte une empreinte d'impression ou d'illustration et en terminant par la dernière page qui comporte une telle empreinte.

Un des symboles suivants apparaîtra sur la dernière image de chaque microfiche, selon le cas: le symbole \rightarrow signifie "A SUIVRE", le symbole ∇ signifie "FIN".

Les cartes, planches, tableaux, etc., peuvent être filmés à des taux de réduction différents. Lorsque le document est trop grand pour être reproduit en un seul cliché, il est filmé à partir de l'angle supérieur gauche, de gauche à droite, et de haut en bas, en prenant le nombre d'images nécessaire. Les diagrammes suivants illustrent la méthode.

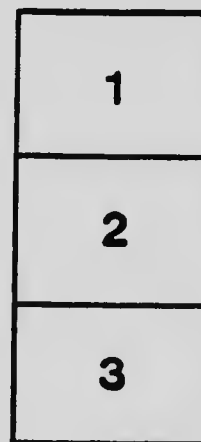

MICROCOPY RESOLUTION TEST CHART

(ANSI and ISO TEST CHART No. 2)

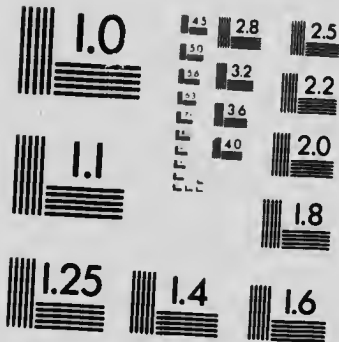

APPLIED IMAGE Inc

1653 East Main Street
Rochester, New York 14609 USA
(716) 482 - 0300 - Phone
(716) 288 - 5989 - Fax

A M 314

CANADA
DEPARTMENT OF MINES
HON. LOUIS CODERRE, MINISTER; R. W. BROCK, DEPUTY MINISTER.

MINES BRANCH
EUGENE HAANEL, PH.D., DIRECTOR.

RESEARCHES ON COBALT AND COBALT ALLOYS, CONDUCTED
AT QUEENS UNIVERSITY, KINGSTON, ONTARIO, FOR THE
MINES BRANCH OF THE DEPARTMENT OF MINES

PART II

THE PHYSICAL PROPERTIES

OF

THE METAL COBALT

BY

H. T. Kalmus, B.Sc., Ph.D.

AND

C. Harper, B.A.



OTTAWA
GOVERNMENT PRINTING BUREAU
1914

No. 309

DDN 8599129







CANADA
DEPARTMENT OF MINES
HON. LOUIS CORDERE, MINISTER, R. W. BROCK, DEPUTY MINISTER.

MINES BRANCH
EUGENE HAVASEL, Ph.D., DIRECTOR.

RESEARCHES ON COBALT AND COBALT ALLOYS, CONDUCTED
AT QUEENS UNIVERSITY KINGSTON, ONTARIO, FOR THE
MINES BRANCH OF THE DEPARTMENT OF MINES

PART II

THE PHYSICAL PROPERTIES
OF
THE METAL COBALT

BY

H. T. Kalmus, B.Sc., Ph.D.

AND

C. Harper, B.A.



OTTAWA
GOVERNMENT PRINTING BUREAU
1914

No. 309

DR. EUGENE HAASEL,
DIRECTOR OF MINES BRANCH,
DEPARTMENT OF MINES,
OTTAWA.

Sir,

I beg herewith to submit a report entitled, "The Physical Properties of the Metal Cobalt", the same being the second completed part of the series of investigations on cobalt and cobalt alloys, for the purpose of increasing their economic importance, which have been the subject of the special researches conducted under my direction at Queens University, Kingston, Ontario, for the Mines Branch of the Department of Mines, Ottawa.

I have the honour to be, Sir,
Your obedient servant,

Herbert T. Kalmus.

KINGSTON, May 12, 1914.



CONTENTS

	PAGE
Introductory	1
Preparation of metallic cobalt for the study of its properties	1
Preparation of "commercial" metallic cobalt	2
Reduction with carbon	3
Metallic cobalt of extreme purity	3
Purification of commercial cobalt oxide	3
Method A	3
Silica	4
Iron and arsenic	4
Nickel	4
Sulphur	4
Method B	4
a, b	4
c, d	4
Reduction of Co_2O_3 with hydrogen and carbon monoxide gas	5
Colour	5
Density—specific gravity	5
Density of "commercial cobalt"	6
Cast and unannealed	6
Density of pure cobalt	6
Cast and unannealed	6
Cast and annealed	6
Rolled	7
Density of cobalt: table	7
Hardness	7
Hardness testing machine	7
Discussion of Brinell method of hardness measurement	8
Reference table of Brinell hardness	9
Cobalt for Brinell hardness measurements	9
Brinell hardness measurement	9
Measurement of Brinell hardness of "commercial cobalt"	10
Measurement of Brinell hardness of pure cobalt	11
Hardness of cobalt as observed by other investigators	12
Comparative hardness of nickel and cobalt	12
Conclusions	12
Melting temperature of cobalt	12
The melting furnace	12
Temperature measurements	13
Melting and freezing curves	14
Melting point determination—cobalt	15
Cooling curve data (Fig. 2)	15
Cooling curve data (Fig. 3)	15
Summary of results of melting point determinations	15
The melting point of cobalt as determined by other investigators	16
Conclusions	17
Tensile strength measurements	17
Tensile strength testing machine: description of	17
Test bars	17
Method of measurement	17
Tensile strength measurements of "commercial cobalt"	18
Cast and unannealed	18
Cast and annealed	19
Tensile strength measurements of pure cobalt	21
Cast and unannealed	21
Cast and annealed	22
Tensile strength of cobalt wires	22
Conclusions	23
Pure cobalt	23
"Commercial cobalt"	24

	PAGE
Compressive strength measurements.....	25
Test bars.....	25
Method of measurement.....	25
"Commercial cobalt".....	25
Cast and unannealed.....	25
Cast and annealed.....	26
Pure cobalt.....	27
Cast and unannealed.....	27
Cast and annealed.....	27
Conclusions.....	28
Pure cobalt.....	28
"Commercial cobalt".....	28
Machining, rolling and swaging of metallic cobalt.....	29
Turning properties.....	29
Swaging of cobalt.....	29
Swaging machines: description of.....	29
Conclusions.....	30
Measurement of electrical resistance.....	31
Description of apparatus.....	31
Method of computation.....	33
Annealing of wires.....	33
"Commercial cobalt".....	34
Unannealed.....	34
Annealed.....	36
Pure cobalt.....	38
Unannealed.....	38
Annealed.....	39
Specific electrical resistance of cobalt.....	41
Specific electrical resistance of nickel.....	41
Conclusions:—	
Pure cobalt.....	41
"Commercial cobalt".....	42
Magnetic permeability.....	42
Specific heat measurements.....	42
Method and apparatus.....	42
Material.....	43
Microphotographs.....	44
Pure cobalt H 212: Analysis of.....	44
Commercial cobalt H 213: " ".....	45
Cobalt H 214: " ".....	45
Commercial cobalt H 130: " ".....	45
" " H 214c (Plate VIII): Analysis of.....	46
" " H 214c (" IX): " ".....	46
" " H 87c (" X): " ".....	46
" " H 87c (" XI): " ".....	47
" " H 109: Analysis of.....	47
" " H 211 " ".....	47
Pure Nickel.....	48
Acknowledgments.....	48

ILLUSTRATIONS

Photographs.

Plate		PAGE
I	Brinell hardness testing machine	6
II	Riehle Universal Standard Vertical Screw-power Testing Machine, 100,000 pounds capacity	18
III	Swaging machine.	30
IV	Pure cobalt (II 212); microphotograph.	44
V	Commercial cobalt (II 213)	44
VI	Pure cobalt (II 214)	44
VII	Commercial cobalt (II 130)	44
VIII	" " (II 214c)	44
IX	" " (II 214e)	44
X	" " (II 87 c)	44
XI	" " (II 87 c)	44
XII	" " (II 109)	44
XIII	" " (II 211)	44
XIV	Pure nickel	48

Drawings.

Fig. 1	Brinell hardness testing machine: detail of	8
" 2	Cooling curve—melting point—cobalt	14
" 3	Cooling curve—melting point—cobalt	16
" 4	Tensile strength "proportional bar"	17
" 5	Typical tensile stress-strain diagram.	18
" 6	Typical compressive stress-strain diagram.	24
" 7	Arrangement of circuits for electrical resistance measurements	32
" 8	Annealing furnace: longitudinal section, taken vertically, through centre	32

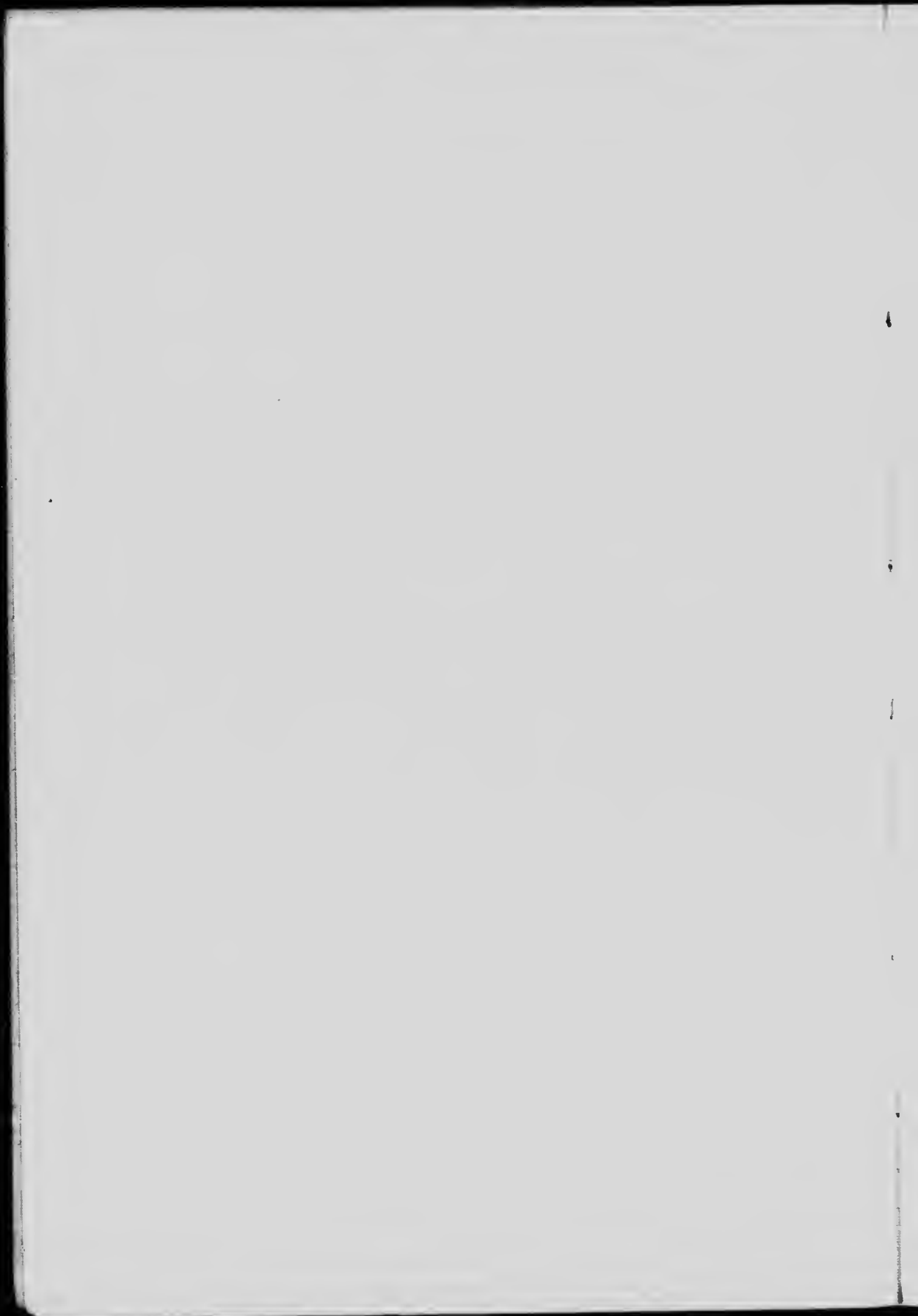

RESEARCHES ON COBALT AND COBALT ALLOYS, CONDUCTED
AT QUEENS UNIVERSITY, KINGSTON, ONT., FOR THE MINES
BRANCH OF THE DEPARTMENT OF MINES

PART II.

**THE PHYSICAL PROPERTIES OF
THE METAL COBALT**

BY

Herbert T. Kalmus, B.Sc., Ph.D.

and

C. Harper, B.A.



PART II.

THE PHYSICAL PROPERTIES OF THE METAL COBALT

INTRODUCTORY.

An extended investigation of the metal cobalt, and its alloys, for the purpose of increasing its industrial and economic importance, has been, and is being conducted at the School of Mining, Queens University, Kingston, Ont., for the Mines Branch of the Department of Mines, Ottawa. The following are the principal subdivisions of the work:

- I. THE PREPARATION OF METALLIC COBALT BY REDUCTION OF THE OXIDE.
- II. A STUDY OF THE PHYSICAL PROPERTIES OF THE METAL COBALT.
- III. ELECTRO-PLATING WITH COBALT AND ITS ALLOYS.
- IV. COBALT ALLOYS OF EXTREME HARDNESS.
- V. COBALT ALLOYS WITH NON-CORROSIVE PROPERTIES.
- VI. SPECIAL COBALT ALLOYS.

This paper is Part II of the above, and is a report on a large number of measurements made at the University laboratories, of some of the important physical and mechanical properties of metallic cobalt. The properties which have been particularly studied are: -

- (a) Density.
- (b) Hardness.
- (c) Melting point.
- (d) Tensile breaking strength.
- (e) Tensile yield point.
- (f) Compressive breaking strength.
- (g) Compressive yield point.
- (h) Rolling and turning properties.
- (i) Electrical resistance.
- (j) Magnetic permeability.
- (k) Specific heat.

In connexion with these, a number of microphotographs have been taken.

As far as possible existing data, as found in the literature on the subject, will be reported under the above headings; but throughout, references will be cited for all facts and figures taken from the literature, so that there will be no ambiguity as to what is old and what is new.

PREPARATION OF METALLIC COBALT FOR THE STUDY OF ITS PHYSICAL PROPERTIES.

It is true of cobalt as of most metals, that its physical properties are often greatly influenced by the presence of small percentages of impurities. It is well known, for example that less than 0.01 per cent of arsenic in copper is sufficient to account for a drop in its electrical conduct-

ivity of 3.3 per cent.¹ Similarly, for cobalt we find that a few tenths of one per cent of impurities often doubles or trebles its electrical resistance².

The cobalt for these investigations has been prepared by reduction of cobalt oxide, Co_3O_4 . Commercial oxide was obtained from the smelters, and after a crude purification, has been reduced to form what we shall call "commercial cobalt"; again this commercial oxide has been purified to a high degree of purity, from which has been prepared what we style "pure cobalt". These two names are used in this paper largely for brevity and convenience; the analysis of each sample is given with the data of its properties. The properties of each of these have been measured, and will be discussed separately.

Preparation of "Commercial" Metallic Cobalt.

Black cobalt oxide, Co_3O_4 , as obtained from the smelters, was given a crude purification, and then reduced with carbon to metallic cobalt.

This purification was carried out in accordance with the procedure given below, under "Purification of Commercial Cobalt Oxide"; except that no particular care was taken that the separations should be complete. That is to say, the purification was such as could be effected commercially at comparatively low cost, and is such as is at present attained in the manufacture of the best commercial cobalt oxide.

Three samples of cobalt oxide from which this commercial cobalt was made, analysed as follows:—

June, 1912.	%
Co.....	71.99
Fe.....	0.11
Ni.....	0.040
S.....	0.020
Ca.....	0.021
Si.....	0.090

November, 1912.	%
Co.....	71.52
Fe.....	0.27
Ni.....	0.020
Si.....	0.090
S.....	trace
Ca.....	trace

April, 1913.	%
Co.....	70.4
Fe.....	0.102
Ni.....	trace
Ca.....	0.15
S.....	0.21
Si.....	0.11

Analyses of the "commercial" metal produced from this oxide will be given in connexion with the measurements of its physical and mechanical properties.

¹ J. H. Dellinger, "The Temperature Coefficient of Resistance of Copper", Bulletin of the U. S. Bureau of Standards, Vol. 7, 1911, page 79.

² This paper, pp. 30-40.

REDUCTION WITH CARBON.

Finely divided cobalt oxide was intimately mixed with powdered charcoal, the amount of charcoal being about 10 per cent in excess of that required by the equation,

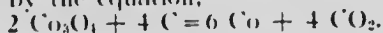

This charge, usually 5 lbs. of oxide, was reduced in a graphite crucible, either with a Steele-Harvey oil fired furnace, or in a modified Hoskins electric resistor furnace. The charge was frequently stirred during the reduction and the temperature was controlled at about 1,000°C, making temperature observations with a suitable pyrometer.¹

When the reduction was complete, or nearly so, the temperature of the furnace was raised to about 1,550°C, sufficient to melt the cobalt. Bars of cobalt were not cast at this temperature—1,550°C; for in that event the castings would be found to be permeated with blow holes. In order to obviate this, the common practice of "soaking" was adopted. In the case of cobalt this consisted in lowering the temperature of the melt from approximately 1,550°C to approximately 1,493°C, maintaining it at that temperature for about one-half hour, and then casting from this reduced temperature, which was but slightly above the melting point of the metal. The casting was into sand, or iron moulds, in forms suitable to be swaged into wires, rolled into sheets, machined into test bars, or to be used for whatever experiments were required.

The "commercial cobalt" obtained in this way, invariably contained in the neighbourhood of 0.20 per cent carbon, together with such small percentages of iron, nickel, sulphur, calcium, and silicon, as were contained in the original oxide, and not slagged off.

The metal produced in this way varied in quality from time to time, and its analysis will be given for each of the tests to be described in this paper.

METALLIC COBALT OF EXTREME PURITY.

Part of these experiments were designed to obtain measurements of the physical properties of cobalt of much more extreme purity than would ordinarily be found in industrial practice. For this purpose metal was obtained from a specially purified cobalt oxide, either by reduction of the oxide with hydrogen gas, or with carbon monoxide gas.

Purification of Commercial Cobalt Oxide.

Cobalt oxide as obtained from the smelters, and as sold on the market, usually contains small percentages of the following impurities, Ca, S, As, Si, Fe and Ni.

This commercial oxide was purified by either one of the following methods²:—

METHOD A.

Starting with a crude cobalt oxide, the impurities may be reduced, as far as is desired, by the following procedure.

¹ For a full description of experiments on the preparation of metallic cobalt by reduction of the oxide with carbon, see "Preparation of Metallic Cobalt by Reduction of the Oxide", Herbert T. Kalmus, Bulletin No. 259, Mines Branch, Canada Department of Mines, page 4, 1913.

² For details of the application of this method, see "Preparation of Metallic Cobalt by Reduction of the Oxide" Herbert T. Kalmus, Bulletin No. 259, Mines Branch, Canada Department of Mines, page 3, 1913.

Silica. Dissolve the crude oxide in hydrochloric acid, according to the reaction,



This may best be done by heating and agitating with steam. If silica is present, it will not dissolve, and may be removed by filtration or decantation. The same is true of silicates which are not decomposed by this treatment. Decomposable silicates would send a certain amount of silica into solution, which would be thrown out again during the next step, and be filtered off with the arsenic and iron.

Iron and Arsenic. To the cobalt chloride solution formed by dissolving the oxide in hydrochloric acid as above, gradually add finely divided CaCO_3 or pure marble, until no further precipitate is formed. This calcium carbonate addition will precipitate a heavy brown mud, which contains the iron and arsenic content of the original oxide.

Nickel. For most purposes it will not be necessary to separate the small amount of nickel from the cobalt, but if this is desirable it may be done as follows. The cobalt chloride solution, containing a certain amount of nickel chloride, is of an intense red or claret colour. Add a solution of bleach to this mixed chloride solution until it has almost completely lost its colour. The bleach solution differentially precipitates hydrates of nickel and cobalt, so that the nickel is not appreciably brought down until the cobalt has been almost entirely precipitated.

The bleach will precipitate a black hydrated oxide of cobalt, and the diminishing redness of the solution will indicate the end point. If all of the steps above outlined have been applied to the original oxide, this final black precipitate may be calcined at about 750°C , to yield black Co_2O_3 .

Sulphur. Any sulphur which was present in the original oxide, and which has been carried through to the final product, or which may have been introduced with the bleach, may readily be removed by boiling the final dried oxide with sodium carbonate and dilute hydrochloric acid, as follows. The Na_2CO_3 reacts with the sulphur, which is in the form of sulphate after the calcination, according to the reaction,

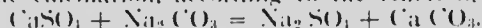

The soluble sodium sulphate formed is washed out with water. A further washing is given with dilute hydrochloric acid, which decomposes the calcium carbonate into soluble calcium chloride and CO_2 gas. The CaCl_2 is washed out with water. This method is, of course, only applicable for the removal of small percentages of Ca and S, as they are found in the oxides in question.

METHOD B

(a) Dissolve commercial Co_2O_3 in hydrochloric acid, and filter or decant off insoluble silica and silicates.

(b) Add finely divided CaCO_3 , precipitating a heavy brown mud which contains the iron and arsenic content of the original oxide.

(c) Add barium chloride, before filtering, to precipitate sulphates as barium sulphate, and then decant and filter complete precipitate from (b) and (c).

(d) There will now remain a solution of mixed CoCl_2 and NiCl_2 . To this solution add a filtered bleach solution, which will differentially precipitate the nickel and cobalt as hydrates. That is, the bleach will precipitate a black hydrated oxide of cobalt, and the diminishing redness

* This bleach solution should be free from sulphates; if not, it should be rendered so by adding BaCl_2 and filtering.

of the solution will indicate the end point at which nickel hydrate will begin to precipitate.

This final black precipitate was dried and calcined at about 760°C yielding black Co_3O_4 . By this method oxide containing only traces of impurities was obtained.

Cobalt of extreme purity, for our tests, was made from such oxide as this, by reduction with hydrogen gas or with carbon monoxide gas.

The analyses of this pure metal will be given with the various tests of its properties, the following being a typical example:

Co	99.9
Ni	none
Fe	0.10
S...	0.019
Ca	none
Si...	0.040
C...	none

REDUCTION OF Co_3O_4 WITH HYDROGEN AND CARBON MONOXIDE GAS.

The finely divided cobalt oxide was placed within an electric resistor furnace, in an aluminum or silica muffle, through which a stream of hydrogen or carbon monoxide gas was passed. The temperature was controlled at about 950°C, by suitable pyrometer observation, and the excess of gas was burned at the discharging end of the furnace.¹

The metal formed by reduction in this way, was in the form of a finely divided grey powder, if the reduction was made in the neighbourhood of 900°C, and in the form of a more or less sintered grey powder, if the reduction was made in the neighbourhood of 1000°C. It was placed in a silica lined crucible, within an electric resistor furnace, melted, and cast in the desired form to be rolled, swaged, or turned.

The cobalt of extreme purity, prepared in this way, varied slightly in quality, and chemical analyses will be given throughout this paper accompanying the report of each of the tests.

COLOUR.

Pure metallic cobalt very much resembles nickel in colour, although when plated and polished under proper conditions, while beautifully white, it possesses a slightly bluish cast. Sometimes it deposits as a black matte. Metallic cobalt which has been reduced from the oxide at a sufficiently low temperature is a grey powder.

DENSITY SPECIFIC GRAVITY.

The density of both cast and rolled cobalt was determined in this laboratory by the Archimedes method. A sphere or cylinder of the material was weighed, using a delicate balance, both in air and under water. The weighings were corrected in the computations for the buoyancy of the air, and the measurements reduced so as to be expressed in terms of water at its maximum density, that is, at 4°C. Following are the results:

¹ For a description of the method of purification of the gas, of the details of apparatus, and of the method of conducting reduction runs, see "Purification of Metallic Cobalt by Reduction of the Oxide", Herbert T. Kalmus, Bulletin No. 259, Mines Branch, Canada Department of Mines, pp. 11-31, 1913.

Density of "Commercial Cobalt."

<i>Cast and Unannealed.</i>					
Sample number	Date	Form of sample	Heat and mechanical treatment	Analysis	Density, value at °C.
H 109	Dec. 8, 1914	Cylindrical bar	Cast from just above melting point in iron mould, allowed to cool, and turned in lathe.	Co 96.8 Ni 0.56 Fe 2.46 S 0.022 C 0.063 P 0.017	8.799, 18.5°C. See microphotograph, Plate VII.
H 140	Feb. 1914 Average of five determinations.	Thin cylindrical bar.	Cast from just above melting point in iron mould, allowed to cool in iron mould, and turned in lathe.	Co 96.5 Ni 2.11 Fe 1.47 C 0.105 S 0.054 P 0.015	8.7690, 17°C. See microphotograph, Plate VIII.
H 187 c	Feb. 1914. Average of four determinations	Cylindrical bar.	Cast from just above melting point in iron mould, allowed to cool in iron mould, and turned in lathe.	Co 97.8 Ni 0.50 Fe 1.46 S 0.020 Ca 0.18 Si trace. P trace.	8.6658, 17°C. See microphotograph, Plate XI.

Density of Pure Cobalt.

<i>Cast and Unannealed.</i>					
Sample number.	Date.	Form of sample.	Heat and mechanical treatment	Analysis.	Density, value at °C.
H 212	Jan.-Feb. 1914. Average of six determinations.	Cylindrical bar.	Cast from just above melting point, allowed to cool in iron mould, and turned in lathe.	Co 99.9 Ni 0.20 Fe none C none S 0.017 Ca none Si none	8.7562, 17°C. See microphotograph, Plate IV.
H 214	Apr. 3, 1914.	Swaged wire of diameter 0.0901 cms.	Cast from just above melting point, allowed to cool in iron mould, and given special heat and mechanical treatment, according to page 30, after which it was swaged to wire.	Co 98.71 Ni none Fe 1.15 Si 0.14 Ca none S 0.012 C 0.039 P 0.010	8.8490, 15°C. See microphotograph, Plate VI.
H 190	Nov. 15, 1913	Cylindrical bar.	Cast from just above melting point, allowed to cool in iron mould, and turned in lathe.	Co 99.1 Ni none Fe 0.80 S 0.021 Ca trace	8.7889, 20°C.
H 213	Jan.-Feb. 1914. Average of three determinations.	Cylindrical bar.	Cast from just above melting point, allowed to cool in iron mould, and turned in lathe.	Co 99.73 Ni 0.14 Fe 0.019 S none C none Si 0.020	8.7732, 16°C. See microphotograph, Plate V.
<i>Cast and Annealed</i>					
H 212	Jan. 12, 1914.	Thin cylindrical bar.	Cast from just above melting point, allowed to cool in iron mould, and turned in lathe. Annealed from 700°C.	Co 99.9 Ni 0.20 Fe none C none S 0.017 Ca none Si none	8.8105, 14.5°C.

PLATE I

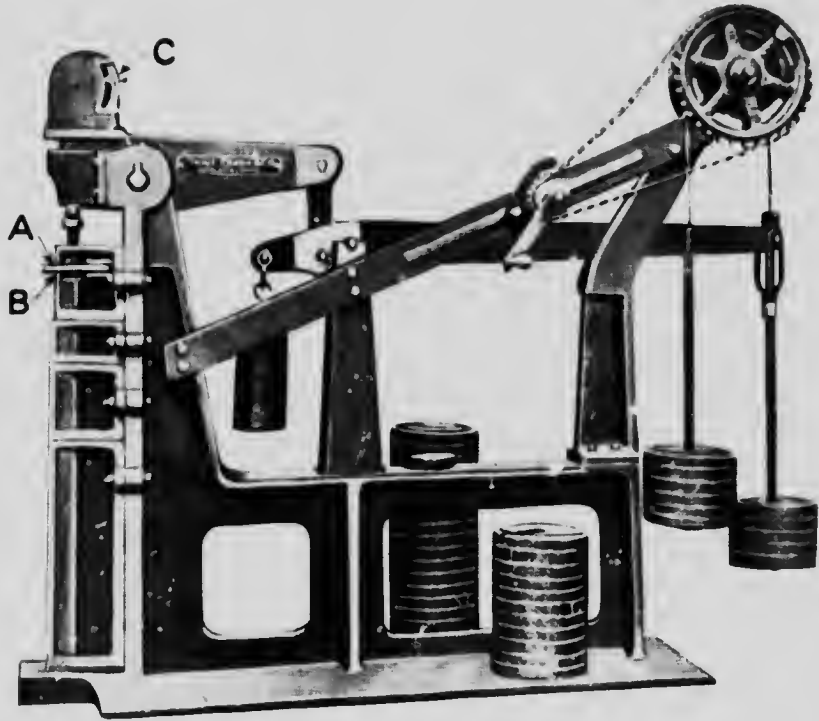

Brinell Hardness Testing Machine.



Rolls.

Sample number.	Date.	Form of sample.	Heat and mechanical treatment.	Analysis.	Density value at °C.
H 213	Jan. 19, 1914.	Thin cylindrical bar.	Cast from just above melting point, cooled in iron mould, and Fe swaged down to thin cylindrical bar.	Co 99.73 C 0.14 Ni none S none Si 0.020	8.9278 11°C.
H 212	Jan. 23, 1914.	Wire, 0.0810 cms diameter.	Cast from just above melting point, cooled in iron mould, and Fe swaged down to thin cylindrical bar.	Co 99.9 C 0.20 Ni none S none Ca 0.017 Si none	8.9227 19°C.

A number of density determinations of metallic cobalt, as made by other investigators, are recorded in the literature, most of which, however, were made at an early date, and very little is said of the nature of the metal. The following table of values is taken from the more recent and probably more accurate of them.

Density of Cobalt.

Tilden ¹ ,	8.718	21°C
G. Neumann and F. Streintz ²	8.6	—
Copaux ³ ,	8.8	15°C
Winkler ⁴ ,	7.9678	—
Kalmus and Harper, unannealed,	8.7918	17.0°C
Kalmus and Harper, annealed,	8.8105	14.5°C
Kalmus and Harper, swaged,	8.9253	16.5°C.

The values from the literature are generally lower than those measured by us, no doubt because of impurities in the metal, or because of the difficulties of casting without occluding a certain amount of gas.

HARDNESS.**Hardness Testing Machine.**

Hardness measurements were made in this laboratory on a standard Olsen hardness testing machine of 100,000 lbs. capacity, (Tinius Olsen Co., Philadelphia, Pa.), as shown in Plate I. The machine consists of a framework on which is mounted a lever system. To one end of this lever system a penetrating ball (**A**) is attached, while at the other, weights are attached, which, when applied, cause motion of the lever system and penetration of the ball into the metal (**B**) to be tested. An instrument (**C**) is mounted on the main lever which measures automatically the actual penetration of the steel ball to 0.0001 of an inch.

Figure 1 shows the details of the essential parts of the machine. The test piece is placed on the head (**R**), which is brought into contact with the penetrating sphere by means of a screw (**S**). The sphere is one centimeter

¹ Chemical News, Vol. 78, p. 16, 1899.

² Monatshefte für Chemie, Vienna, Vol. 12, 1891, p. 642.

³ Annalen de Chemie et de Physique, (8), Vol. 6, 1905, p. 508.

⁴ Berg und hüttenmännische Zeitung, Vol. 39, 1880, p. 87.

in diameter. A small initial pressure is applied to the piston (P). The zero reading is then taken. The desired pressure is then applied and released to the point of initial pressure before the final reading is taken. These readings are made to 0.0001 of an inch. The difference between the initial and final readings is equal to the depth of indentation of the sphere.

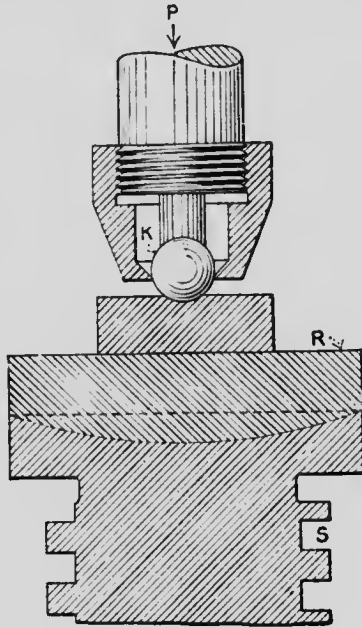

Fig. 1. Detail of Brinell hardness testing machine.

Discussion of Brinell Method of Hardness Measurement.

After the Brinell method was introduced it was shown by Benedicks,¹ Le Chatelier², Leon³, Malmstrom,⁴ Meyers⁵ and others, that the Brinell hardness numeral is dependent upon the size of the sphere used to make the indentation, and upon the pressure to which it is subjected. Consequently these must be specified with each measurement.

All hardness measurements of the metal cobalt, made by us, have been computed by the Brinell system, and have been made with a sphere of one centimeter diameter, and with a load of 3500 pounds, unless stated otherwise.

We have measured the Brinell hardness of a series of common substances under the identical conditions that we have used for cobalt, and a table of these values is given below for comparison. In each instance the value is the mean of a number of observations, and they are reproducible, on the same sample, to within a few per cent. Different samples of most of this material give values differing considerably among themselves. This table is given merely to serve as a rough basis of comparison.

¹ Recherches Physiques sur l'acier au carbone. Upsala, 1904.

² Revue de Metallurgie, 1906, No. 2.

³ Die Brinellsche Hartprobe und ihre praktische Verwendung. Proceedings, International Association for Testing Materials, 1906.

⁴ Stahl und Eisen, 1907, No. 50.

⁵ Untersuchungen über Hartprüfung und Harte, Zeitschrift des Vereins Deutscher Ingenieure, 1907.

Reference Table of Brinell Hardness.

Material.	Date.	Load.	Brinell hardness.
Copper, rolled sheet, unannealed.	Jan. 1913	1000 lbs.	67.6
Copper, rolled sheet, unannealed.	Jan. 1914	1000 lbs.	67.1
Copper, rolled sheet, unannealed.	Jan. 1914	3500 lbs.	75.0
Copper, rolled sheet, unannealed.	Jan. 1914	3500 lbs.	81.9
Swedish iron.	Jan. 1913	3500 lbs.	90.7
Swedish iron.	Jan. 1914	1000 lbs.	68.6
Swedish iron.	Jan. 1914	3500 lbs.	75.2
Wrought iron.	Jan. 1913	3500 lbs.	92.0
Wrought iron.	Jan. 1914	1000 lbs.	83.1
Wrought iron.	Jan. 1914	3500 lbs.	100.2
Cast iron.	Jan. 1913	3500 lbs.	97.8
Cast iron.	Jan. 1914	1000 lbs.	84.4
Cast iron.	Jan. 1914	3500 lbs.	104.5
Mild steel.	Jan. 1913	3500 lbs.	109.9
Mild steel, cold rolled shafting	Jan. 1914	3500 lbs.	126.2
Tool steel, "Crescent".	Jan. 1913	3500 lbs.	153.8
Tool steel, "Crescent".	Jan. 1914	3500 lbs.	130.9
Spring steel.	Jan. 1913	3500 lbs.	160.3
Spring steel.	Jan. 1914	3500 lbs.	178.0
Tool steel, self-hardening.	Jan. 1913	3500 lbs.	180.0
Tool steel, self-hardening, "Rex" (before hardening)	Jan. 1914	3500 lbs.	162.1
Tool steel, self-hardening, "Rex" (after hardening)	Jan. 1914	3500 lbs.	240.0
Tool steel, self-hardening, from workshop (School of Mining)	Jan. 1914	3500 lbs.	259.0

Cobalt for Brinell Hardness Measurements.

The hardness of cobalt, like that of most other metals, is determined to a greater extent by its physical and mechanical treatment than by slight variations in its chemical composition, if we except perhaps the presence of carbon. Even our "commercial cobalt" contains but small percentages of total impurities, of which the greater part is iron and nickel, and which in the small amounts present would not greatly effect the hardness. In the samples under "commercial cobalt" the percentage of carbon is given throughout, and the percentage of other impurities is between the following limits:

S	$\frac{C}{100}$	to	$\frac{C}{100}$
Ca	trace	to	0.015
Si	trace	to	0.20
Fe	0.10	to	1.0
Ni	trace	to	0.50
C	0.10	to	0.60

The total impurities in any one sample of this "commercial cobalt" rarely exceeded 1.5 per cent.

Brinell Hardness Measurement.

A single measurement of the Brinell hardness is given in full to show the concordance of observations among themselves, and the details of computation. This may be taken as typical of the large number of measurements which were made.

Sample H 193, Dec. 9, 1913. Load 3500 lbs.

Initial Reading.	Reading under load.	Indentation in inches.
0.0344	0.0489	0.0145
0.0333	0.0480	0.0147
0.0309	0.0465	0.0156
0.0321	0.0468	0.0147
Average indentation		0.0149 inches 0.379 millimeters.

Brinell Hardness by definition = $\frac{\text{total pressure in kilograms}}{\text{area of depression in square millimeters}} =$

$$\frac{P}{2 \pi r h} \text{ where}$$

P = load in kilograms

r = radius of indenting ball in millimeters

h = depth of depression in millimeters.

$$\text{Therefore, B.H.} = \frac{3500}{2.2} \times \frac{1}{2} \times \pi \times \frac{5}{8} \times 0.379 = 133.4$$

Measurement of Brinell Hardness of "Commercial Cobalt."

Load 3500 lbs., unless stated to the contrary.

Sample number.	Date.	Heat and mechanical treatment.	Carbon, sulphur and phosphorus content.	Brinell hardness.	Remarks.
H 109	Dec. 9, 1913.	Cast from just above melting point, allowed to cool in iron mould, and turned in lathe.	C 0.062 S 0.022 P 0.017	111.4	See microphotograph, Plate XII.
H 109	Jan. 14, 1914.	Cast from just above melting point, allowed to cool in iron mould, and turned in lathe.	C 0.062 S 0.022 P 0.017	100.9	See microphotograph, Plate XII.
H 109	Dec. 11, 1913.	Cast from just above melting point, allowed to cool in iron mould, and turned in lathe.	C 0.062 S 0.022 P 0.017	104.4	See microphotograph, Plate XII.
H 109	Dec. 22, 1913.	Cast from just above melting point, allowed to cool in iron mould, and turned in lathe.	C 0.062 S 0.022 P 0.017	111.7	Metal soft, tough and turns with medium long curling chip. See microphotograph, Plate XII.
H 109	Sept. 15, 1914.	Cast from just above melting point, allowed to cool in iron mould, and turned in lathe.	C 0.062 S 0.022 P 0.017	100.2	Metal soft, tough and turns with medium long curling chip. See microphotograph, Plate XII.
H 211	Jan. 14, 1914.	Cast from just above melting point, allowed to cool in iron mould, and turned in lathe.	C 0.18 S 0.080 P 0.031	128.2	Metal soft and medium tough. Machines with medium long curling chip. See microphotograph, Plate XIII.
H 211	Sept. 15, 1914.	Cast from just above melting point, allowed to cool in iron mould, and turned in lathe.	C 0.18 S 0.080 P 0.031	130.7	Metal soft and medium tough. Machines with medium long curling chip. See microphotograph, Plate XIII.
H 87c	Jan. 16, 1914.	Cast from just above melting point, allowed to cool in iron mould, and turned in lathe.	C 0.18 S 0.022 P 0.012	131	Metal medium hard and tough. Machines with curling chip. See microphotograph, Plate XI.
H 214c	Sept. 15, 1914.	Cast from just above melting point, allowed to cool in iron mould and turned in lathe, and annealed from 1000°.	C 0.067 S 0.012 P 0.010	136.9	See microphotograph, Plate IX.
H 214.	Sept. 15, 1914.	Cast from just above melting point, allowed to cool in iron mould and turned in lathe, and annealed from 850.	C 0.067 S 0.012 P 0.010	138.6	See microphotograph, Plate VIII.

Sample number.	Date.	Heat and mechanical treatment.	Carbon, sulphur, and phosphorus content.	Brinell hardness.	Remarks.
H 214	Sept. 15, 1913.	Cast from just above melting point, allowed to cool in iron mould, and turned in lathe, unannealed.	C 0.067 S 0.012 P 0.010	123.9	
H 87 a and c	Dec. 22, 1913.	Cast from just above melting point, allowed to cool in iron mould, and turned in lathe.	C 0.22 S 0.030 P none	119.2	
H 87 a and e	Sept. 15, 1914.	Cast from just above melting point, allowed to cool in iron mould, and turned in lathe.	C 0.22 S 0.030 P none	132.9	
H 130	Dec. 11, 1913.	Cast from just above melting point, allowed to cool in iron mould, and turned in lathe.	C 0.305 S 0.054 P 0.015	115	Metal soft grained, brittle, and turns with short chip.
H 130	Sept. 15, 1914.	Cast from just above melting point, allowed to cool in iron mould, and turned in lathe.	C 0.305 S 0.054 P 0.015	113.8	
H 130	Jan. 11, 1914.	Cast from just above melting point, allowed to cool in iron mould, and turned in lathe.	C 0.305 S 0.054 P 0.015	116.6	Metal soft and tough. Machines with cutting chip. See microphotograph, Plate VII.
H 87 d and b	Feb. 1, 1913.	Cast from just above melting point, allowed to cool in iron mould, and turned in lathe.	C 0.36 S 0.016 P none	112	Very tough to turn in lathe.
H 87 b and d	Feb. 1, 1913.	Cast from just above melting point, allowed to cool in iron mould, and turned in lathe.	C 0.37 S 0.015 P none	117	Very tough to turn in lathe.

Measurement of Brinell Hardness of Pure Cobalt.

Load 3500 lbs., unless stated to the contrary.

Sample number.	Date.	Heat and mechanical treatment.	Analysis.	Brinell hardness.	Remarks.
H 193	Nov. 15, 1913.	Cast from just above melting point, allowed to cool in iron mould, and turned in lathe.	Co 99.40 Ni none Fe 0.80 S 0.020 C none Ca trace	129.7	Load 2,500 lbs. Metal soft and brittle. Machines with short chip.
H 193	Dec. 9, 1913.	Same	Same	133.4	
H 193	Nov. 15, 1913.	Same	Same	131.2	
H 212	Jan. 9, 1914.	Same	Co 99.9 Ni none Fe 0.20 S 0.017 C none	105.5	Load 2,500 lbs.
H 212	Jan. 14, 1914.	Same	Same	128.7	Metal soft and brittle. Machines with short chip. See microphotograph, Plate IV.
H 212	Jan. 14, 1914.	Cast from just above melting point, allowed to cool in iron mould, turned in lathe, and annealed from 700° C.	Co 99.9 Ni none Fe 0.30 S 0.017 C none	130.8	Load 2,500 lbs.
H 213	Jan. 14, 1914.	Same	Co 99.73 Ni none Fe 0.14 S 0.019 C none	121	Metal soft and brittle. Machines with short chip. See microphotograph, Plate V.
H 217	Sept. 15, 1914.	Annealed two hours at 600° C., allowed to cool slowly, and again machined.	Co 99.55	125.9	
H 217	Sept. 15, 1914.	Cast from just above melting point, allowed to cool in iron mould, and machined.	Same	109.5	

Hardness of Cobalt as Observed by Other Investigators.

There is very little in the literature on the hardness of cobalt, except a few more or less qualitative observations. However, a careful measurement seems to have been made by R. Reur and K. Kaneko¹, from which they compute the Brinell hardness of cobalt to be 132.

Comparative Hardness of Nickel and Cobalt.

For comparison we have measured the hardness of both cast and sheet nickel under the same conditions that we have used for cobalt, load 3500 lbs., and found them to be respectively 83.1 and 85.1 Brinell, the latter for a $\frac{1}{4}$ inch sheet. An independent check test on the hardness of cast nickel, gave as a result 76.4.

From these measurements it is therefore apparent that the hardness of cobalt is considerably greater than that of either iron or nickel, under corresponding conditions.

Conclusions.

(1). The above tables show the Brinell hardness of cobalt cast from just above the melting point, and allowed to cool in an iron mould, to be in the neighbourhood of 124.0 (load 3500 lbs.). This is the mean of nine observations with an average deviation from the mean, of 7.9.

(2). The hardness of cobalt, cast from just above its melting point, is considerably higher than that of cast iron or cast nickel under corresponding conditions.

(3). The effect of the addition of 0.060 to 0.37 per cent of carbon on the hardness of "commercial" cobalt is not sufficient to offset the effect of slight variations in heat treatment. The measurements are not sufficiently concordant to warrant drawing general conclusions.

MELTING TEMPERATURE OF COBALT.

A considerable number of melting point determinations of the metal cobalt were made in an Arsem electric vacuum furnace, (General Electric Company, Schenectady, N. Y.). These determinations were made by the usual cooling or melting curve method, using pure alumina crucibles, and alundum lined graphite crucibles.

Cobalt has a very sharp melting point, differing in this respect from iron, which becomes plastic as it approaches its melting point. With iron, the actual temperature of melting is not sharply defined, there being a considerable transition region; whereas with cobalt quite the reverse is true. Therefore, the melting point of cobalt may be determined with accuracy by the cooling and melting curve method.

The Melting Furnace.

The essential feature of the furnace is the heating element, which is a spiral of graphite, through which an appropriate electric current is passed. The crucible is placed within the carbon spiral, and both are situated within a vacuum chamber. The iron casing forming the shell of the furnace, and serving as the vacuum chamber, is in constant connexion with a suitable vacuum pump. This pump was in operation during the entire melting point determination.

By this means there was no oxidizing atmosphere to shorten the life of

¹ Ferrum, Vol. 10, p. 257.
Chemical Abstracts, 1913, p. 3591.

the carbon spiral, nor any gas to carry away, by conduction, the heat developed in the spiral. A further carbon radiation shield surrounded the heating spiral, so that the temperature of this furnace may be maintained as high as 3000°C.

The melting point determinations were, therefore, made substantially in vacuum, and free from oxidizing atmospheric conditions.

Temperature Measurements.

Temperature observations were made with a Wanner optical pyrometer, which was checked before and after each set of runs against an amylnacetate lamp standard, in accordance with a calibration certificate from the Physicalisch-Technische Reichsanstalt, at Charlottenburg. This pyrometer was also used to measure the melting points of copper and nickel during the period of its use for the determinations on cobalt, which measurements agreed with the calibration curve used, to within a few degrees. For this work the melting point of nickel was considered to be 1444°C, and of copper to be 1084°C.

The melting point of nickel, considering our calibration curve from the Reichsanstalt to be correct, was determined six times as follows:—

	Deviation from the mean.
1438°C	6
1437°C	7
1445°C	1
1446°C	2
1448°C	4
1450°C	6
1444°C mean	4.3°C average deviation of single observation from the mean.

The nickel used for these melting point measurements analysed as follows:—

Ni.....	99.29	
Fe.....	0.48	
S.....	0.025	See microphotograph, Plate XIV.
Si.....	0.042	
Ca.....	none	
C.....	none	
Co.....	none	
Total.....	99.84	

The cobalt used for these melting point determinations analysed as follows:—

Co.....	99.9	
Ni.....	none	Sample No. 212.
Fe.....	0.20	See microphotograph, Plate IV.
S.....	0.017	
Ca.....	none	
Si.....	none	
C.....	none	
Total.....	100.12	

Melting and Freezing Curves.

A cooling curve was obtained by regulating the current through the furnace, so that the charge was brought to a temperature about 100° above its melting temperature, and then lowering the current to some predetermined magnitude, that gradual cooling took place to about 100° below the melting temperature. During the cooling, temperature readings were made at 10, 15, or 20 second intervals.

It is obvious that a substance, if allowed to cool more or less uniformly from above its melting point, under fixed external conditions, will cease to drop uniformly in temperature when the melting point is reached, due to the latent heat of fusion which is developed within the substance upon solidifying. If we plot time as abscissae, and the temperature of the cooling mass as ordinates, in general we may get one or the other of three types of curve, corresponding with the three following typical kinds of transformation:—

(a) The substance remains at a constant temperature throughout the transformation of melting or freezing.

(b) The substance cools at a reduced rate, more or less constant during the transformation of melting or freezing.

(c) The substance undergoes an increase in temperature during the first part of the transformation.

Methods of computing the true, corrected, melting temperature from each of the above forms of curve, have been set forth in the literature by several authors discussing thermal analyses.

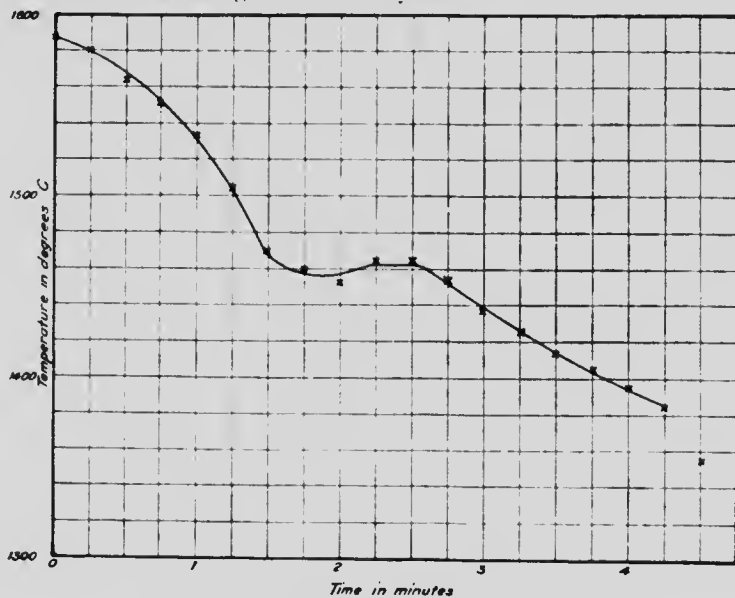

Fig. 2. Cooling curve—melting point—cobalt.

The first of the three cases indicated is by far the simplest, and may be used with accuracy for cobalt. Two sets of data, with the corresponding plot or cooling curves, taken from some fifteen of them, and which are typical of them all, are given below, to show how nearly to case (a) our melting and freezing curves correspond.

Melting Point Determination - Cobalt.

January 19, 1914.		Readings every 15 seconds.	Temperature, degrees C.
Time elapsed in minutes since beginning of run.		Wanner optical pyrometer readings.	
Run I	0	78.2	1587
See Fig. 2	1 ₁	77.0	1580
	1 ₂	77.3	1565
	2 ₁	76.8	1553
	2 ₂	75.0	1533
	3 ₁	74.6	1505
	3 ₂	72.8	1470
	4 ₁	72.0	1460
	4 ₂	71.6	1453
	5 ₁	72.2	1463
	5 ₂	72.2	1463
	6 ₁	71.8	1455
	6 ₂	70.6	1448
	7 ₁	69.8	1425
	7 ₂	69.0	1415
	8 ₁	68.5	1405
	8 ₂	67.6	1395
	9 ₁	66.8	1385
9 ₂	64.2	1355	
Run II	0	78.9	1607
See Fig. 3	1 ₁	77.4	1567
	1 ₂	76.2	1540
	2 ₁	75.8	1530
	2 ₂	74.0	1512
	3 ₁	71.3	1500
	3 ₂	73.6	1486
	4 ₁	72.8	1470
	4 ₂	72.0	1460
	5 ₁	72.0	1462
	5 ₂	72.1	1460
	6 ₁	72.0	1460
	6 ₂	71.8	1455
	7 ₁	71.6	1453
	7 ₂	69.8	1425
	8 ₁	67.4	1392
	8 ₂	65.0	1364
	9 ₁	63.2	1333
9 ₂	62.0	1332	

Without giving the details, except for the two runs above, the following is a table of the melting point determinations of cobalt analysing 99.9 per cent pure, as shown on page 13. It was sample No. 212. See Micrograph, Plate IV.

Summary of Results of Melting Point Determinations.

Date of run	Determined melting point of Cobalt. Deviation of single observation from the mean
Sept. 27, 1912	1474 C 7
Sept. 30, 1912	1472 5
Sept. 30, 1912	1472 5
Oct. 1, 1912	1470 3
Oct. 1, 1912	1472 5
Jan. 13, 1914	1467 0
Jan. 13, 1914	1467 0
Jan. 14, 1914	1460 7
Jan. 15, 1914	1453 14
Jan. 15, 1914	1468 1
Jan. 15, 1914	1468 1
Jan. 19, 1914	1462 5
Jan. 19, 1914	1460 7
Jan. 19, 1914	1470 3
Jan. 19, 1914	1462 5
Jan. 19, 1914	1470 3
	Mean 1467°C
	Mean 4.4°C
Mean melting temperature 1467°C. Average deviation of single observation from the mean 4.4°C.	

Therefore, from these observations the melting point of pure cobalt would appear to be $1,467^{\circ}\text{C} \pm 1.1^{\circ}\text{C}$. Note, however, conclusions below.

The Melting Point of Cobalt as Determined by other Investigators.

The following values of the melting point of cobalt are taken from the literature:

Investigator.	Melting temperature.	Purity per cent.	Method of measurement	Reference.
Burgess and Waltenberg	1477 C	99.95	Micropyrometer	Bulletin, Bureau of Standards, Vol. 9, pp. 475. Vol. 10, pp. 13, 1913.
Burgess and Waltenberg	1478 C	99.95	Candle melts in electric furnace	Bulletin, Bureau of Standards, Vol. 9, pp. 475. Vol. 10, pp. 13, 1913.
G. K. Burgess	1464 C	very pure	Micropyrometer	Bulletin, Bureau of Standards, Vol. 3, pp. 350.
H. Copaux	1530	not given	Interpolation between gold and platinum point	Annales de Chimie et de Physique (8), Vol. 6, 1905, pp. 508.
Guertler and Tamman	1528	98.3 rest largely Ni and Fe.	Cooling curve	Zeitschrift für Anorganische Chemie, Vol. 12, p. 353, 1904.
Guertler and Tamman	1468	98.3	Cooling curve	Their value above, (1528 C), corrected for melting point of nickel = 1451 instead of 1484 as taken by them.
Guertler and Tamman	1505	98.3	Cooling curve	Zeitschrift für Anorganische Chemie, Vol. 15, 1905, p. 224.
Guertler and Tamman	1455	98.3	Cooling curve	Their value above, (1505 C), corrected for melting point of nickel = 1451 instead of 1484 as taken by them.
R. Ruer and K. Kaneko	1491			Ferrum, Vol. 11, 1913, pp. 33-39.

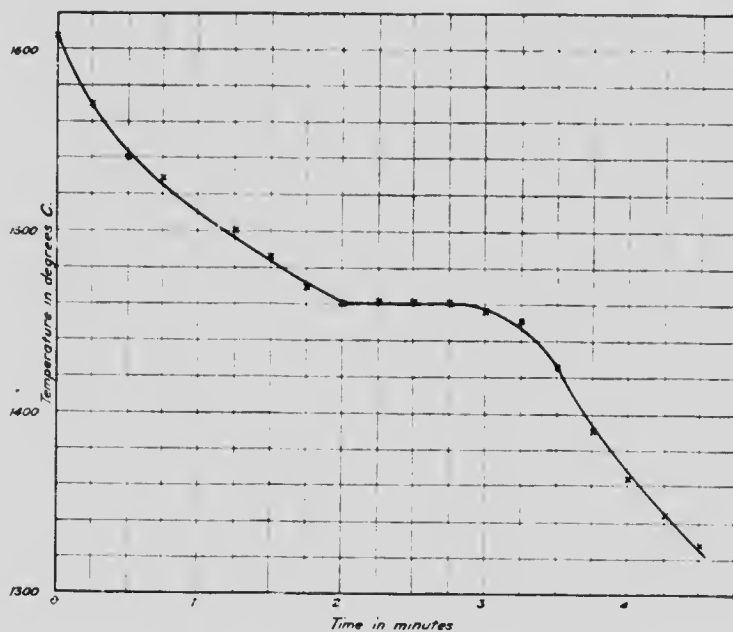

Fig. 3. Cooling curve—melting point—cobalt.

It should be noted that Burgess and Waltenberg¹ use the value 1,452°C as the melting temperature of nickel. If we adopt this value instead of 1,444°C (see page 13) our value for the melting temperature of cobalt would be practically identical with theirs, namely, 1,478°C.

Conclusions.

The melting temperature of cobalt, as determined by us, is 1,467-1,478°C. This is for metal 99.9 per cent pure, and is the mean of sixteen determinations by the cooling and heating curve method.

This value of the melting temperature is based upon pyrometer calibration curves, considering the value of the melting temperature of nickel to be 1,444°C. If we adopt the more probable value of 1,452°C, for the melting temperature of nickel, **our melting temperature for cobalt is 1,478°C ± 1.1°C.**

TENSILE STRENGTH MEASUREMENTS.

Tensile Strength Testing Machine.

The tensile strength tests were made on a Richlé Universal Standard Vertical Screw Power Testing Machine, (Richlé Testing Machine Co., Philadelphia, Pa.), of 100,000 lbs. capacity, operated by direct connexion to an electric motor. This machine is in the testing laboratory of the Department of Civil Engineering, School of Mining, Queen's University, Kingston, Ontario. The writers wish to express their thanks to Professor A. Macphail, in charge of that department, for many valuable suggestions in connexion with the use of this machine.

Test Bars.

All bars for tensile strength measurements have been "Proportional Bars," as recommended and adopted by the International Association for Testing Materials. Fig. 4 shows the shape and dimensions of these bars.

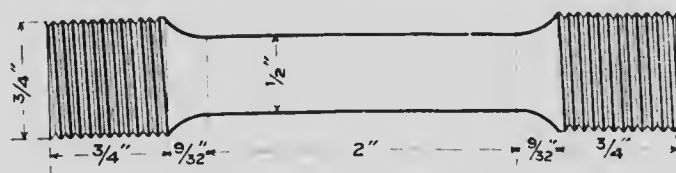

Fig. 4. Tensile strength proportional bar.

Method of Measurement.

Plate II is a picture of the testing machine used for the measurements. It was operated in the standard manner, with a chart in place, as shown at **A**, to get an autographic stress-strain diagram for each specimen.

The form of these tensile stress-strain diagrams obtained on all of our samples is shown in Fig. 5. The point **Y**, however, is often less marked than in the figure shown, and **P** and **Y** are usually very close together.

¹ Bulletin, United States Bureau of Standards, Vol. 10, page 6, 1913.

From the point **O** to the point **P** the elongation or strain of the material was very slight, and was proportional to the stress or load applied. **P** is the proportional limit, and **Y** is the yield point. **M** is the maximum stress, and **R** is the rupture stress or tensile breaking load, which values are given in our tables.

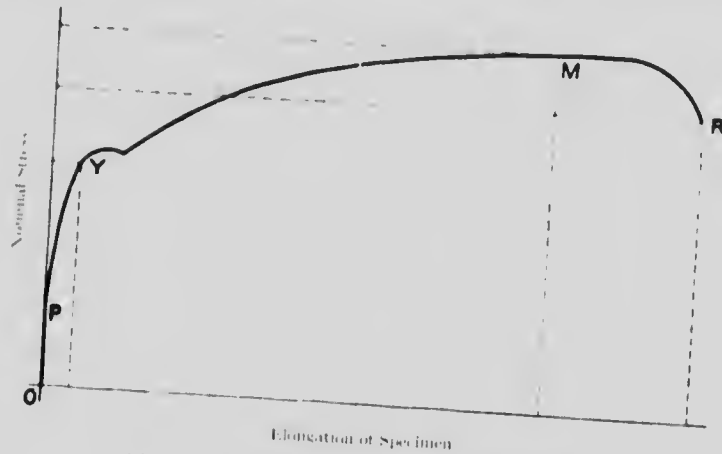

Fig. 5. Typical tensile stress-strain diagram.

P = Proportional limit
Y = Yield point
M = Maximum stress
R = Tensile breaking load.

Below are tables of the data for these measurements as obtained by us on "commercial" cobalt and on pure cobalt.

Tensile Strength Measurements of "Commercial Cobalt."

Sample number	Date	Heat and mechanical treatment.	Cast and Unannealed.					Remarks.
			Analysis.	Tensile breaking load in pounds per sq. inch.	Yield point in pounds per sq. inch.	Percentage reduction in area.	Percentage elongation in 2 inches.	
H 109	Dec. 9, 1913.	Cast from just above Co melting point, allowed to cool in iron-Fe mould, and turned S in lathe.	Co 96.8 Ni 0.56 Fe 2.36 S 0.022 C 0.062 P 0.017	48700	33800	7.7	5.5	Early fine granular fracture.
H 109	Dec. 9, 1913.	Cast from just above Co melting point, allowed to cool in iron-Fe mould, and turned S in lathe.	Co 96.8 Ni 0.56 Fe 2.36 S 0.01 C 0.062 P 0.017	52800	33800	8.7	7.0	
H 109	Dec. 16, 1913.	Cast from just above Co melting point, allowed to cool in iron-Fe mould, and turned S in lathe.	Co 96.8 Ni 0.56 Fe 2.36 S 0.022 C 0.062 P 0.017	57200	18300	24.5	21.9	Tough and difficult to machine in lathe. Long curling chips.
H 109	Dec. 22, 1913.	Cast from just above Co melting point, allowed to cool in iron-Fe mould, and turned S in lathe.	Co 96.8 Ni 0.56 Fe 2.36 S 0.022 C 0.062 P 0.017	64100	9360	25.4	27.0	Fracture coarsely granular, and not uniform in appearance.

PLATE 1.

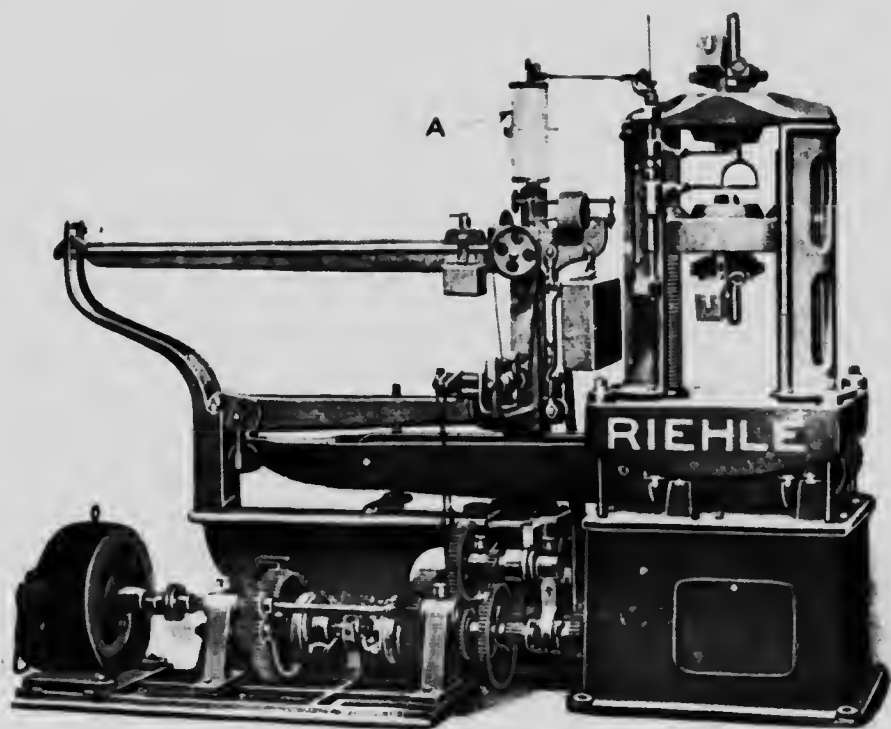

Riehle, Universal, Standard, Vertical, Screw-Power Testing Machine, 100,000 lbs. capacity.



Cast and Unannealed (continued).

Sample number.	Date.	Heat and mechanical treatment.	Analysis.	Tensile breaking load in pounds per square inch.	Yield point in pounds per square inch.	Per-centage re-duction in area.	Per cent- age elong-ation in 2 inches.	Remarks
H 15	Feb. 15, 1913.	Cast from just above melting point, allowed to cool in iron mould, and turned in lathe.	Co 98.5 Fe 1.0 Ni 0.30 S 0.020 C 0.18 Si 0.020 Ca none P none	76700	33800	7.7	6.5	
H 87c	Jan. 23, 1911.	Cast from just above melting point, allowed to cool in iron mould, and turned in lathe.	Co 97.8 Fe 1.46 Ni 0.50 S 0.18 C 0.030 Si 0.020 Ca none P 0.012	56100	30600	5.3	5.0	Metal medium hard and tough. Machines with medium long curling chip. See microphotograph. Plate XI.
H 87f	Apr. 5, 1913.	Cast from just above melting point, allowed to cool in iron mould, and turned in lathe.	Co 98.7 Fe 0.80 Ni 0.20 C 0.22 S 0.039 Si 0.020 Ca none P none	75000	33700	25.4	29.7	Very tough to machine in lathe.
H 87b	Feb. 10, 1913.	Cast from just above melting point, allowed to cool in iron mould, and turned in lathe.	Co 98.5 Fe 0.80 Ni 0.30 C 0.37 S 0.016 Si 0.020 Ca none P none	63200	33100	21.1	24.0	
H 87d	Feb. 10, 1913.	Cast from just above melting point, allowed to cool in iron mould, and turned in lathe.	Co 98.5 Fe 0.80 Ni 0.20 C 0.37 S 0.016 Si 0.020 Ca none P none	77700	33900	23.8	24.0	
H 211	Dec. 22, 1913.	Cast from just above melting point, allowed to cool in iron mould, and turned in lathe.	C 0.18 S 0.080 P 0.031	31000	31000	none	none	Low value due to segregation of impurities. See microphotograph. Plate XIII.
<i>Cast and Annealed.</i>								
H 109	Jan. 9, 1914.	Cast from just above melting point, allowed to cool in iron mould, and turned in lathe. Annealed from 700°C.	Co 96.8 Ni 0.56 Fe 2.36 S 0.022 C 0.062 Ca none Si none P 0.017	56100	29300	13.4	14.0	Metal soft and tough. Machines with medium long curling chip.
H 109	Jan. 14, 1914.	Cast from just above melting point, allowed to cool in iron mould, and turned in lathe. Annealed from 700°C.	Co 96.8 Ni 0.56 Fe 2.36 S 0.022 C 0.062 Ca none Si none P 0.017	52600	31600	13.3	13.5	See microphotograph. Plate XII.
H 87c	Apr. 22, 1914.	Cast from just above melting point, allowed to cool in iron mould, and turned in lathe. Annealed at 850°C.	Co 97.8 Fe 1.46 Ni 0.50 C 0.18 S 0.020 Si 0.020 Ca none P 0.012	60200	40800	5	1.5	Very fine grain, uniform. See microphotograph. Plate X.

Cast and Anneal—(continued).

Sample number.	Date.	Heat and mechanical treatment.	Analysis.	Tensile breaking load in pounds per square inch.	Yield point in pounds per square inch.	Percentage reduction in area.	Percentage elongation in 2 inches.	Remarks.
H 87c	May 19, 1914.	Cast from just above melting point, allowed to cool in iron mould, and turned in lathe. Annealed at 850°C.	Co 97.8 Fe 1.46 Ni 0.50 C 0.18 S 0.020 Si 0.020 Ca none P 0.012	55700			2.0	
H 214C	Apr. 22, 1914.	Cast from just above melting point, allowed to cool in iron mould, and turned in lathe. Annealed at 850°C.	Co 97.09 Ni none Fe 1.45 C 0.067 S 0.012 Mn 2.04 Si 0.011 Ca none P 0.010	70500	37100	5.1	8.0	Very fine grain uniform. See microphotograph, Plate VIII.
H 214C	Apr. 22, 1914.	Cast from just above melting point, allowed to cool in iron mould, and turned in lathe. Annealed at 1000°C.	Co 97.09 Ni none Fe 1.45 C 0.067 S 0.012 Mn 2.04 Si 0.011 Ca none P 0.010	75200	25500	6.1	10.0	Very fine grain, uniform. See microphotograph, Plate IX.
H 87c	June 2, 1914.	Cast from just above the melting point, allowed to cool in iron mould, and turned in lathe. Annealed at 850°C.	Co 97.8 Fe 1.46 Ni 0.50 C 0.18 S 0.020 Si 0.020 Ca none P 0.012	64,800	61,300	0.61	0.5	Very fine grain,
H 87c	June 2, 1914.	Cast from just above the melting point, allowed to cool in iron mould, and turned in lathe. Annealed at 850°C.	Co 97.8 Fe 1.46 Ni 0.50 C 0.18 S 0.020 Si 0.020 Ca none P 0.012	58,000	56,100	1.5	0.3	Very fine grain.
H 87c	June 10, 1914.	Cast from just above the melting point, allowed to cool in iron mould, and turned in lathe. Annealed at 950°C.	Co 97.8 Fe 1.46 Ni 0.50 C 0.18 S 0.020 Si 0.020 Ca none P 0.012	57,000	18,000	2.57	2.0	Fracture fine grained, but not uniform in appearance.
H 87c	June 10, 1914.	Cast from just above the melting point, allowed to cool in iron mould, and turned in lathe. Annealed at 950°C.	Co 97.8 Fe 1.46 Ni 0.50 C 0.18 S 0.020 Si 0.020 Ca none P 0.012	58,500	20,400	3.4	2.0	Fracture fine grained, but not uniform in appearance.
H 87c	June 15, 1914.	Cast from just above the melting point, allowed to cool in iron mould, and turned in lathe. Annealed at 1000°C.	Co 97.8 Fe 1.46 Ni 0.50 C 0.18 S 0.020 Si 0.020 Ca none P 0.012	65,000	55,000	3.1	1.9	Fine grained fracture.
H 87c	June 15, 1914.	Cast from just above the melting point, allowed to cool in iron mould, and turned in lathe. Annealed at 1000°C.	Co 97.8 Fe 1.46 Ni 0.50 C 0.18 S 0.020 Si 0.020 Ca none P 0.012	62,300	40,800	3.1	1.9	Fine grained fracture.

Cast and Unannealed—(continue D.)

Sample number.	Date.	Heat and mechanical treatment.	Analysis.	Tensile breaking load in pounds per sq. inch.	Yield point in pounds per sq. inch.	Per-centage reduction in area.	Per-centage elongation in 2 inches.	Remarks.
II 87c	June 17, 1914.	Cast from just above the melting point, allowed to cool in iron mould, and turned in lathe. Annealed at 1000 C.	Co 97.8 Ni 1.46 Fe 0.50 C 0.18 S 0.020 Si 0.020 Ca none P 0.012	42,600	10,800	0.61	0.5	Fine grained fracture.
II 87c	June 18, 1914.	Cast from just above the melting point, allowed to cool in iron mould, and turned in lathe. Annealed at 1000 C.	Co 97.8 Ni 1.46 Fe 0.50 C 0.18 S 0.020 Si 0.020 Ca none P 0.012	56,000	16,000	1.3	1.0	Fine grained fracture.

Tensile Strength Measurements of Pure Cobalt.

Cast and Unannealed.

Sample number.	Date.	Heat and mechanical treatment.	Analysis.	Tensile breaking load in pounds per square inch.	Yield point in pounds per square inch.	Per-centage reduction in area.	Per-centage elongation in 2 inches.	Remarks.
II 212	Jan. 9, 1914.	Cast from just above melting point, allowed to cool in iron mould, and turned in lathe.	Co 99.9 Ni none Fe 0.20 S 0.017 C none	29,600	10,200	1.5	2.0	Fracture coarse grained and crystalline.
II 212	Jan. 16, 1914.	Cast from just above melting point, allowed to cool in iron mould, and turned in lathe.	Co 99.9 Ni none Fe 0.20 S 0.017 C none	35,400	31,100	0.5	4.0	Metal soft and brittle. Machines with short chip.
II 212	Jan. 23, 1914.	Cast from just above melting point, allowed to cool in iron mould, and turned in lathe.	Co 99.9 Ni none Fe 0.20 S 0.017 C none	44,400	43,100	none	none	Fracture coarse grained and crystalline.
II 212	Jan. 23, 1914.	Cast from just above melting point, allowed to cool in iron mould, and turned in lathe.	Co 99.9 Ni none Fe 0.20 S 0.017 C none	45,800	25,500	1.5	0.5	Fracture coarse with radially crystalline structure.
II 212	Jan. 26, 1914.	Cast from just above melting point, allowed to cool in iron mould, and turned in lathe.	Co 99.9 Ni none Fe 0.20 S 0.017 C none	23,000	23,000	none	none	Fracture coarse with radially crystalline structure. Metal soft and brittle. Machines with short chip.
II 212	Feb. 3, 1914.	Cast from just above melting point, allowed to cool in iron mould, and turned in lathe.	Co 99.9 Ni none Fe 0.20 S 0.017 C none	37,900	37,900	none	none	Fracture good with fine grain. See microphotograph. Plate IV.
II 213	Jan. 23, 1914.	Cast from just above melting point, allowed to cool in iron mould, and turned in lathe.	Co 99.73 Ni 0.14 Fe 0.019 C none	30,600	30,600	none	none	Fracture coarse grained, crystalline. Metal soft and brittle. Machines with short chip.
II 213	Jan. 23, 1914.	Cast from just above melting point, allowed to cool in iron mould, and turned in lathe.	Co 99.73 Ni none Fe 0.14 S 0.019 C none	30100	30100	none	none	Fracture coarse grained with radially crystalline structure.

Cast and Unannealed—(continued).

Sample number.	Date.	Heat and mechanical treatment.	Analysis.	Tensile breaking load in pounds per square inch.	Yield point in pounds per square inch.	Percentage reduction in area.	Percentage elongation in 2 inches.	Remarks.
H 213	Jan. 23, 1914.	Cast from just above melting point, allowed to cool in iron mould, and turned in lathe.	Co 99.73 Ni none Fe 0.14 S 0.019 C none	23000	23000	none	none	Fracture coarse grained with radially crystalline structure. Metal soft and brittle. Machines with short chip.
H 213	Feb. 3, 1914.	Cast from just above melting point, allowed to cool in iron mould, and turned in lathe.	Co 99.75 Ni none Fe 0.14 S 0.019 C none	45300	23000	3.0	3.6	Fracture good, fine grained. See microphotograph, Plate V.

Cast and Annealed.

H 212	June 14, 1914.	Cast from just above melting point, allowed to cool in iron mould, and turned in lathe. Annealed from 700 C.	Co 99.9 Ni none Fe 0.20 S 0.017 C none Si none Ca none	41200	41200	none	none	Fracture coarse grained, crystalline.
H 212	June 27, 1914.	Cast from just above melting point, allowed to cool in iron mould, and turned in lathe. Annealed from 700 C.	Co 99.9 Ni none Fe 0.20 S 0.017 C none Si none Ca none	28100	28100	none	none	Fracture fairly fine structure. See microphotograph, Plate IV.
H 217	June 16, 1914.	Cast from just above melting point, allowed to cool in iron mould, and turned in lathe. Annealed at 950 C.	Co 99.20 Ni none Fe 0.730 S 0.016 Ca none Si 0.091 P 0.0077 C 0.036 Al 0.021	34800	26600	0.30	0.25	Fracture fine grained and uniform.
H 217	June 17, 1914.	Cast from just above melting point, allowed to cool in iron mould, and turned in lathe. Annealed at 950 C.	Co 99.20 Ni none Fe 0.730 S 0.016 Ca none Si 0.091 P 0.0077 C 0.036 Al 0.021	13600	30600	1.3	1.0	Fracture fine grained and uniform.

Tensile Strength of Cobalt Wires.

Sample number.	Date.	Heat and mechanical treatment.	Analysis.	Tensile breaking load in pounds per square inch.	Yield point in pounds per square inch.	Percentage reduction in area.	Percentage elongation in 2 inches.	Remarks.
H 213	Jan. 29, 1914.	This sample swaged down to fine wire after special heat and mechanical treatment, which is described under "Swaging of Cobalt into Wires," pp. 29, 30.	Co 99.73 Ni none Fe 0.14 S 0.019 C none	101800		5.0	8.2	Diameter of wire 0.117 inches.
H 213	Feb. 11, 1914.	This sample swaged down to fine wire after special heat and mechanical treatment, which is described under "Swaging of Cobalt into Wires," pp. 29, 30.	Co 99.73 Ni none Fe 0.014 S 0.019 C none	77000		1.0	2.0	Diameter of wire 0.124 inches.
H 213	Feb. 21, 1914.	This sample swaged down to fine wire after special heat and mechanical treatment, which is described under "Swaging of Cobalt into Wires," pp. 29, 30.	Co 99.73 Ni none Fe 0.014 S 0.019 C none	90500		8.3		Diameter of wire 0.076 inches. Fine grained fracture.

The literature on the tensile strength of cobalt is very meagre, although Copaux¹ gives the following values for cobalt and nickel: cobalt 69,000 lbs. per square inch; nickel 58,000 lbs. per square inch.

We measured the tensile strength of pure iron and pure nickel at this laboratory, under conditions similar to those for our cobalt tensile strength measurements. The iron used for these measurements analysed:

Fe.....	99.9
S.....	0.023
P.....	0.004
C.....	0.010
Mn.....	0.031
Cu.....	0.028
Si.....	trace.
Ni.....	none.
Co.....	none.

The nickel used for the tensile strength tests analysed:

Ni.....	99.29
Fe.....	0.48
S.....	0.025
Si.....	0.042
Ca.....	none.
C.....	none.

A large series of measurements on nickel and iron would be required to fix the value of the tensile strength with any definiteness; our measurements show it to be approximately as follows:—

Cast nickel, tensile breaking load 18,000 lbs. per square inch.

Cast iron, tensile breaking load 23,000 lbs. per square inch.

The rate of cooling of cast metals from the fluid to the solid state, such an important factor in determining the mechanical properties of the metal, that it is just as necessary to know the dimensions of the test bars as it is to know the chemical composition. The above values for iron, nickel and cobalt, all of which have been made under exactly the same conditions, with a test bar as shown in Fig. 4, are strictly comparable, although they should not be compared with values obtained by other observers on bars of different sizes.

Conclusions.

Pure Cobalt.

I. The tensile strength of pure cobalt, cast and unannealed, is in the neighbourhood of 34,400 lbs. per square inch. This is the average of ten measurements on cobalt cast from just above its melting point, allowed to cool in iron mould, and machined in lathe to test bars.

II. The effect on the tensile strength of annealing cast cobalt, is to increase its value slightly, although this effect is not marked. The average value of our determinations was 36,980 lbs. per square inch for the annealed samples, as compared with 34,400 lbs. per square inch for the unannealed samples.

¹ Annalen de Chemie et de Physique, (8), Vol. 6, 1905, p. 508

III. The percentage reduction in area and elongation are small for cast pure cobalt, as would be expected for the pure metal.

IV. The tensile yield point for pure cobalt is, in general, very close to the tensile breaking load.

V. The tensile strength of pure cobalt increases very rapidly as the metal is rolled, as is common for most metals. It may easily reach over 100,000 lbs. per square inch, by being swaged down to a wire.

VI. The tensile breaking load of pure cobalt, cast from just above the melting temperature, allowed to cool in iron mould and turned in lathe to test bar, is greater than either that of iron or nickel prepared and tested under the same conditions.

"Commercial Cobalt."

VII. The effect of the addition of carbon is to increase the tensile breaking strength of cobalt very markedly, the value rising from 34,400 lbs. per square inch for the pure cast and unannealed metal, to in the neighbourhood of 61,000 lbs. per square inch for cobalt carrying from 0.060 to 0.30 per cent carbon. More exactly, the average of eight measurements, with a carbon content of approximately 0.062 per cent, is 59,700 lbs. per square inch. Similarly, the average of fifteen measurements, with a carbon content varying in the neighbourhood of 0.25 per cent is 61,900 lbs. per square inch.

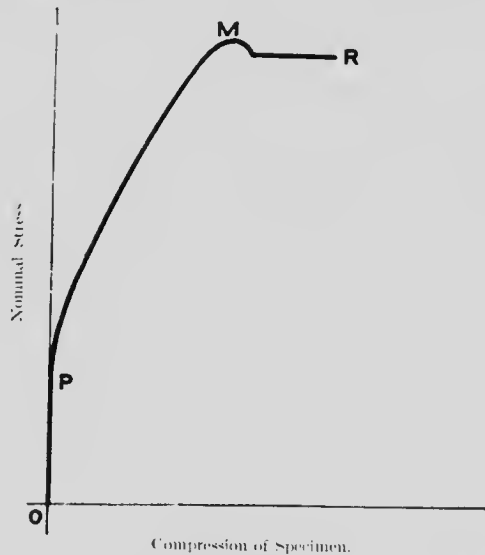

Fig. 6. Typical compressive stress-strain diagram.

P = Proportional limit.
M = Maximum stress.
R = Compressive breaking load.

The average deviation, however, of these individual measurements among themselves is such that, no more specific conclusion can be attached thereto. These values refer to cobalt cast from just above the melting point, allowed to cool in iron mould, machined in a lathe, and tested unannealed. The increased tensile strength may not be entirely due to the presence of carbon, for these tests were made on "commercial cobalt".

VIII. The effect of carbon and other impurities in the "commercial cobalt" is, to greatly increase the percentage reduction and elongation, which rises, in most cases, well above 20 per cent.

COMPRESSIVE STRENGTH MEASUREMENTS.

The measurements of the compressive strength of cobalt were made in the same Richlé universal standard vertical screw power testing machine, of 100,000 lbs. capacity, that was used for the tensile strength measurements, and which is described on page 17, and shown in Plate II.

Test Bars.

All bars for compressive strength measurements were $1\frac{1}{2}$ inches long and $\frac{3}{4}$ inches diameter.

Method of Measurement.

The measurement was made using the testing machine in the standard manner, with a chart in place as shown in Plate II, to get an autographic stress-strain diagram for each sample.

The form of these stress-strain diagrams, obtained on all of our compression samples, is shown in Fig. 6.

From point **O** to point **P**, the compression or strain of the material was very slight, and was proportional to the stress or load applied. The yield point is not very clearly differentiated from the proportional limit on these diagrams, and has been taken to be at point **P**. **M** is the maximum stress, and **R** the rupture stress, or compression breaking load, which values are given in our tables. Below are tables of the data for these measurements, as obtained by us on "commercial cobalt", and on pure cobalt.

Compressive Strength Measurements of "Commercial Cobalt."

Cast and Unannealed.

Sample number.	Date.	Heat and mechanical treatment.	Analysis.	Compressive breaking load in lbs. per square inch.	Yield point in pounds per square inch.	Remarks.
H 87 b	Feb. 10, 1913	Cast from just above melting point, allowed to cool in iron mould, and turned in lathe.	Co 98.5 Fe 0.80 Ni 0.20 C 0.37 S 0.014 Si 0.020 Ca none P none	172000	29000	
H 87 c	Jan. 16, 1914	Cast from just above melting point, allowed to cool in iron mould, and turned in lathe.	Co 97.8 Fe 1.46 Ni 0.50 C 0.18 S 0.020 Si 0.020 Ca none P 0.012	178000	52100	Metal medium hard and tough. Machines with medium long curling chip.
H 87 a and c	Dec. 22, 1913	Cast from just above melting point, allowed to cool in iron mould, and turned in lathe.	Co 98.7 Fe 0.80 Ni 0.20 C 0.23 S 0.030 Si 0.020 Ca none P trace	181000	17600	

Cast and Unannealed (continued).

Sample number	Date	Heat and mechanical treatment.	Analysis.	Compressive breaking load in lbs. per square inch.	Yield point in lbs. per square inch.	Remarks.
H 87 d	Feb. 10, 1913	Cast from just above melting point, allowed to cool in iron mould, and turned in lathe.	Co 98.5 Fe 0.80 Ni 0.20 C 0.37 S 0.016 Si 0.030 Ca none P none	181000	31200	
H 109	Dec. 22, 1913	Cast from just above melting point, allowed to cool in iron mould, and turned in lathe.	Co 96.8 Ni 0.56 Fe 2.36 S 0.022 C 0.062 P 0.017	197500	35000	
H 211	Dec. 22, 1913	Cast from just above melting point, allowed to cool in iron mould, and turned in lathe.	S 0.080 C 0.17 P 0.031	92000	11000	Low value due to segregation of impurities. See microphotograph, Plate XIII.
H 130	Dec. 22, 1913	Cast from just above melting point, allowed to cool in iron mould, and turned in lathe.	Co 96.52 Fe 1.27 Ni 2.00 S 0.053 C 0.405 P 0.015	91000	36000	Metal short grained and brittle. Machines with a short chip.

Cast and Annealed.

H 211	Jan. 10, 1913	Cast from just above melting point, allowed to cool in iron mould, and turned in lathe. Annealed from 700° C.	S 0.080 C 0.17 P 0.031	98200	54300	Low value due to segregation of impurities. See microphotograph, Plate XIII.
H 214	Apr. 21, 1911	Cast from just above melting point, allowed to cool in iron mould, and turned in lathe. Annealed at 850° C.	Co 98.71 Fe 1.45 Ni none S 0.012 Mn 2.01 Ca none Si 0.011 P 0.010 C 0.067	111000	40700	Fine grained and uniform.
H 87c	May, 19, 1914	Cast from just above melting point, allowed to cool in iron mould, and turned in lathe. Annealed at 850° C.	Co 97.8 Fe 1.46 Ni 0.50 C 0.18 S 0.020 Si 0.020 Ca none P 0.012	121000	56500	
H 87c	June 17, 1914	Cast from just above melting point, allowed to cool in iron mould, and turned in lathe. Annealed at 950° C.	Co 97.8 Fe 1.46 Ni 0.50 C 0.18 S 0.020 Si 0.020 Ca none P 0.012	118000	61000	

Compressive Strength Measurements of Pure Cobalt.

Cast and Unannealed.

Sample number.	Date.	Heat and mechanical treatment.	Analyses.	Compressive breaking load in lbs. per square inch.	Yield point in lbs. per square inch.	Remarks.
H 212	Jan. 10, 1913	Cast from just above melting point, allowed to cool in iron mould, and turned in lathe.	Co 99.9 Ni none Fe 0.20 S 0.017 C none Si none Ca none	89000	40700	Metal soft and brittle. Turned with a very short chip.
H 212	Jan. 24, 1911	Cast from just above melting point, allowed to cool in iron mould, and turned in lathe.	Co 99.9 Ni none Fe 0.20 S 0.017 C none Si none Ca none	101800	40700	
H 213	Jan. 24, 1911	Cast from just above melting point, allowed to cool in iron mould, and turned in lathe.	Co 99.73 Ni none Fe 0.14 S 0.019 C none	151000	56200	
H 193a	Dec. 9, 1913	Cast from just above melting point, allowed to cool in iron mould, and turned in lathe.	Co 99.6 Fe 0.14 S 0.025 C none Ni trace P trace Ca none Si none	135800	49200	
H 193	Jan. 10, 1913	Cast from just above melting point, allowed to cool in iron mould, and turned in lathe.	Co 99.6 Fe 0.14 S 0.025 C none Ni trace P trace Ca none Si none	123900	54200	

Cast and Annealed.

H 212	Jan. 16, 1914	Cast from just above melting point, allowed to cool in iron mould, and turned in lathe. Annealed from 700° C.	Co 99.9 Ni none Fe 0.20 S 0.017 C none Si none Ca none	129100	64100	
H 213	Jan. 16, 1914	Cast from just above melting point, allowed to cool in iron mould, and turned in lathe. Annealed from 700° C.	Co 99.73 Ni none Fe 0.14 S 0.019 C none	114300	65600	Metal soft and brittle. Machines with a short chip.
H 217	May 19, 1914	Cast from just above melting point, allowed to cool in iron mould, and turned in lathe. Annealed at 850° C.	Co 99.20 Ni none Fe 0.740 S 0.016 C none Si 0.091 P 0.0077 C 0.036 Al 0.021	102000	45200	

Sample number.	Date.	Heat and mechanical treatment	Analysis.	Compressive breaking load in lbs. per square inch.	Yield point in lbs. per square inch.	Remarks.
H 217	May 20, 1911	Cast from just above melting point, allowed to cool in iron mould, and turned in lathe. Annealed at 850 C.	Co 99.20 Ni none Fe 0.530 S 0.016 Ca none Si 0.091 P 0.0077 C 0.036 Al 0.021	106000	65600	
H 217	June 17, 1911	Cast from just above melting point, allowed to cool in iron mould, and turned in lathe. Annealed at 950 C.	Co 99.20 Ni none Fe 0.730 S 0.016 Ca none Si 0.091 P 0.0077 C 0.036 Al 0.021	131800	10700	

There is, practically, no literature on the compressive strength of cobalt.

We measured the compressive yield point of pure nickel under conditions identical with the above measurements for cobalt, and found it to be 20,000 pounds per square inch. This was for a sample cast from just above the melt¹ temperature, allowed to cool in iron mould, and tested unannealed. The nickel analysed as follows:

Ni	99.29
Fe	0.48
Co	none
S	0.025
Si	0.042
Ca	none
C	none

Conclusions.

Pure Cobalt.

I. The compressive strength of pure cobalt cast and unannealed is in the neighborhood of 122,000 pounds per square inch. This is the average of five measurements on cobalt cast from just above its melting point, allowed to cool in iron mould, and machined in lathe to test bars.

II. The effect of annealing on the compressive strength of cast pure cobalt is not very marked—the average of five measurements of the compressive strength of annealed cast cobalt is 117,200 pounds per square inch. There seems to be a tendency to lower the compressive strength by annealing.

III. The compressive yield point of pure cobalt is 56,100 pounds per square inch, for the annealed samples, compared with 42,200 pounds per square inch for the unannealed samples. Thus the yield point seems to be slightly raised by annealing.

IV. The compressive yield point of pure cobalt, cast from just above the melting temperature, allowed to cool in iron mould and machined in lathe to test bar, is considerably greater than either that of pure iron or nickel prepared and tested under the same conditions.

"Commercial Cobalt."

V. The effect of the addition of carbon is to increase the compressive breaking strength of cobalt, the value rising well above 175,000 pounds per

square inch by the addition of from 0.060 to 0.30 per cent carbon. These values refer to cobalt cast from just above the melting point, allowed to cool in iron mould, machined in lathe, and tested unannealed. The increased compressive strength may not be entirely due to the presence of carbon, for these tests were made on "commercial cobalt".

VI. The effect of carbon and other impurities in the "commercial cobalt" does not seem greatly to affect the yield point through the range of our observation, although on the average from 0.060 to 0.30 per cent of carbon with the other impurities shown, tends to lower it from 5 to 10 per cent, both annealed and unannealed.

VII. The effect of annealing "commercial cobalt" is to lower its compressive strength, our values averaging 140,000 pounds per square inch for the annealed samples, as compared with 183,000 pounds per square inch for the unannealed samples.

VIII. The compressive yield point of "commercial cobalt" is, similar to that for the pure metal, slightly raised by annealing; our values averaging 39,000 pounds per square inch for unannealed samples, as compared with 53,000 pounds per square inch for the annealed samples.

MACHINING, ROLLING, AND SWAGING OF METALLIC COBALT.

Turning Properties.

Pure metallic cobalt may be readily machined in the lathe, although it is somewhat brittle, and yields a short chip. The addition of small amounts of carbon renders cobalt less brittle, and yields a longer curling chip upon turning.

Swaging of Cobalt.

Cast cobalt of extreme purity, which has been cast either in iron or in sand moulds, whether cooled slowly or rapidly, cannot be directly swaged down to a fine wire without special mechanical-heat treatment.

On the other hand, "commercial cobalt" containing small percentages of carbon as described in this paper, may readily be swaged down from cast bars to wires of any desired diameter.

Swaging Machines.

For our experiments on the swaging of cobalt, we used a No. 3 Dayton swaging machine, manufactured by the Excelsior Needle Company of Torrington, Conn. This is shown in Plate III.

With this machine the metal is not drawn out, as is the case with wire-drawing machines, but is rather hammered down by being placed within a pair of dies, carried in a slot in the face of a revolving mandrel, and outside of which is an annular rack containing a number of hardened steel rollers. The dies thus revolve rapidly around the work, which is hammered by them as they pass between opposite pairs of rolls on either side of it.

With this machine it is comparatively easy to swage hard steel into fine wires. The steel will pass through the dies either hot or cold. When, however, a bar of pure cobalt, which has been turned in a lathe to give it a smooth uniform surface, was placed in the swaging machine cold, it cracked along its entire length, and broke off at many places. This was repeated several times with different bars of the metal, each time with the same result, showing that the metal could not be swaged cold.

It became evident that pure cobalt must be given some heat treatment before it could be swaged at all. Hence a 1" bar was first annealed from a temperature of 700°C, by heating it slowly to this temperature in a gas muffle furnace, holding it there for a short time, and then allowing it to cool with the furnace, during several hours. It was then heated to different temperatures before being placed in the swaging machine, with the following results.

At 900°C the metal crumbled in the machine as though it were extremely hot short, although the sulphur content was as low as 0.018 and 0.020 per cent.

At 700°C to 800°C it still cracked, and broke very badly in the machine.

At 500°C to 600°C, however, the bar could be passed through one or two dies without any apparent cracking. It would not go farther than this, although the bar was reannealed after each pass, and reductions in diameter of only 0.002 to 0.003 inches, on a 3/8" bar, were made at each pass. At lower temperatures than this the metal would crack still more, and hence it is obvious that the metal must be given some special treatment to render it more ductile before it can be swaged down to a wire.

Cobalt, like iron and certain other metals, will absorb considerable quantities of gases when it is in the molten state; and as the gases in the metal will in all probability have a bad effect on its swaging properties an attempt was made to remove any of these gases that may have been dissolved in the metal and which still remained in the solid bar. With this in view, a bar which had been cast in an iron mould was heated slowly in a good vacuum to a temperature of about 700°C, where it was held for several hours, at the end of which time the bar was allowed to cool slowly in the furnace. This treatment is claimed to have rendered tungsten more ductile; but on attempting to swage a cobalt bar which had been treated thus, very little, if any, improvement was observed in its swaging properties.

The method which finally succeeded, consisted in slowly cooling the bar from a high temperature, 1100°C to 1150°C, under a high pressure. This was accomplished in the following way. The bar was placed within an iron mould, squeezed tightly by means of clamps, and the whole heated slowly to the above temperature. The mould, with bar, was then removed from the furnace, and the outer portion of the mould chilled while the inner portion still remained hot. The consequent contraction through cooling of the outer portion exerted a considerable pressure on the inner hot bar of metal. The cooling under this pressure continued for three or four hours, after which the metal swaged at a dull red heat with very little difficulty.

The process of swaging consisted in passing the metal, heated to a dull red heat, through successive dies, which hammered it down until a wire of the required diameter was obtained. However, the temperature at which the bar was passed through the dies had to be carefully regulated, as the metal apparently would not swage at all when cold, and when hot only between 500° and 600°C. By thus controlling the temperature, and feeding in the bar very slowly, good, smooth, uniform wires were obtained.

Conclusions.

(1). Pure cobalt may be machined in a lathe as readily as pure nickel or pure iron, although it is somewhat brittle and yields a short chip.

(2). "Commercial cobalt", containing small percentages of carbon, machines very readily after the manner of mild steel.



Swaging Machine.



(3). Cast cobalt of extreme purity cannot be rolled or swaged without developing cracks, unless given a special mechanical heat treatment.

(4). Cast cobalt of extreme purity may be rolled or swaged to any extent by cooling the casting under extreme pressures, followed by passing through rolls or dies at temperatures between 500 to 600°C, and so as to reduce the bar by small percentages at each pass.

(5). "Commercial cobalt" containing small percentages of carbon, may be rolled or swaged from cast bars to any extent, provided that the metal be worked at a red heat.

MEASUREMENT OF ELECTRICAL RESISTANCE.

The potentiometer method of electrical measurement, which is in reality a measurement of the drop in potential along a known length of wire when a definite current is flowing through it, was employed for our measurements on pure and "commercial" cobalt.

The samples of metal which were used were all cast from just above their melting points, allowed to cool slowly in an iron mould, and thereafter swaged down to wires of given diameters according to the method described under "Swaging of Pure Cobalt", page 29.

Analyses of the samples will be given in each instance with the tabulated results of the measurements.

Description of Apparatus.

Fig. 7 is a diagrammatic sketch of the electrical circuits as they were used in the potentiometer method of measuring the electrical resistance of cobalt.

W is a storage battery, two volts, which sends a current through the circuit **WRDAMCBW**, which flows in the direction from **R** to **B**. This circuit is known as the potentiometer circuit. **AC** is a series of fifteen 5 ohm resistance coils, and **CB** is a 5 ohm slide-wire, consisting of several turns of constantine wire mounted on a marble cylinder. **Std** is a cadmium standard cell, electromotive force 1.0189 volts, which bears the certificate of the United States Bureau of Standards. The standard cell is connected from a point **X** in the coils **AC** to the switch **T**, which is set at a point in the resistance **DTA**, such that the electromotive force between **T** and **X**, due to the battery **W**, is exactly equal to that of the standard cell.

This balanced condition is determined by the galvanometer **G**, which is connected in the circuit of the standard cell by throwing the switch **U** into the dotted position. The resistance **R** is adjusted until there is no deflection of the galvanometer, which signifies the balanced condition above mentioned.

The resistance coils from **A** to **C** are a set of fifteen 5 ohm coils, and the point **X** is such that ten of them are included between **A** and **X**. **ATD** is a standard resistance such that there is included between **A** and **T** exactly 0.945 ohms. When the balance was made there flowed, therefore, through the potentiometer circuit, a current $I = \frac{1.0189}{50.945} = \frac{1}{50}$ amperes.

This adjustment is made so that, for this current in the potentiometer circuit, the drop in potential across two adjacent coils along **AC** is exactly 1/10 of a volt.

The switch used is now thrown to connect an unknown electromotive force (**E.M.F.** in the diagram) through the galvanometer, and in such a way that the current from the new source flows in the same direction as that

from the standard cell. The sliding contact M^1 is brought to the zero end of the slide wire, and the moving contact M is shifted from C towards A step by step, until the galvanometer deflection is reversed in direction. M is left at the last point for which a galvanometer deflection is in the same direction as when M was at C . Then the contact M^1 is moved along the slide wire until the galvanometer deflection is zero.

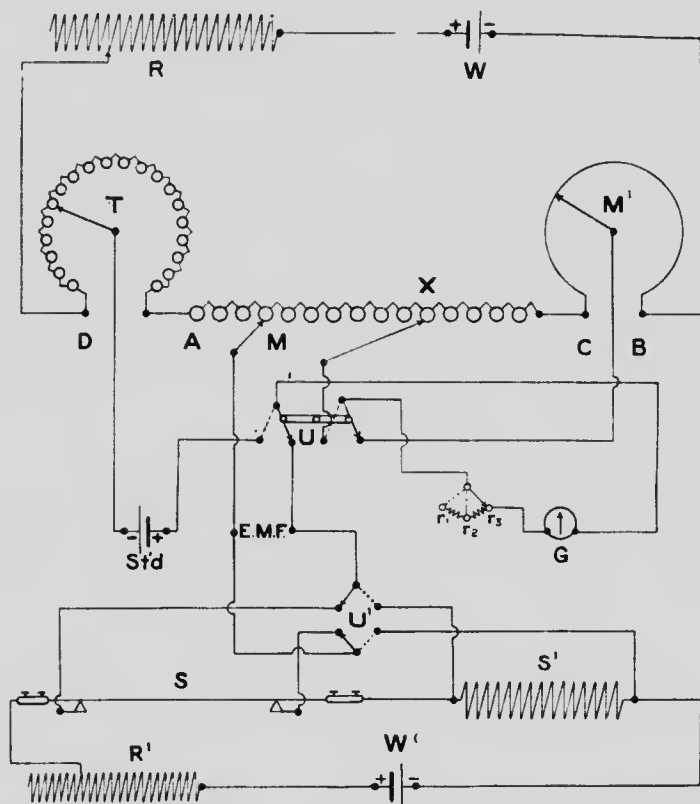
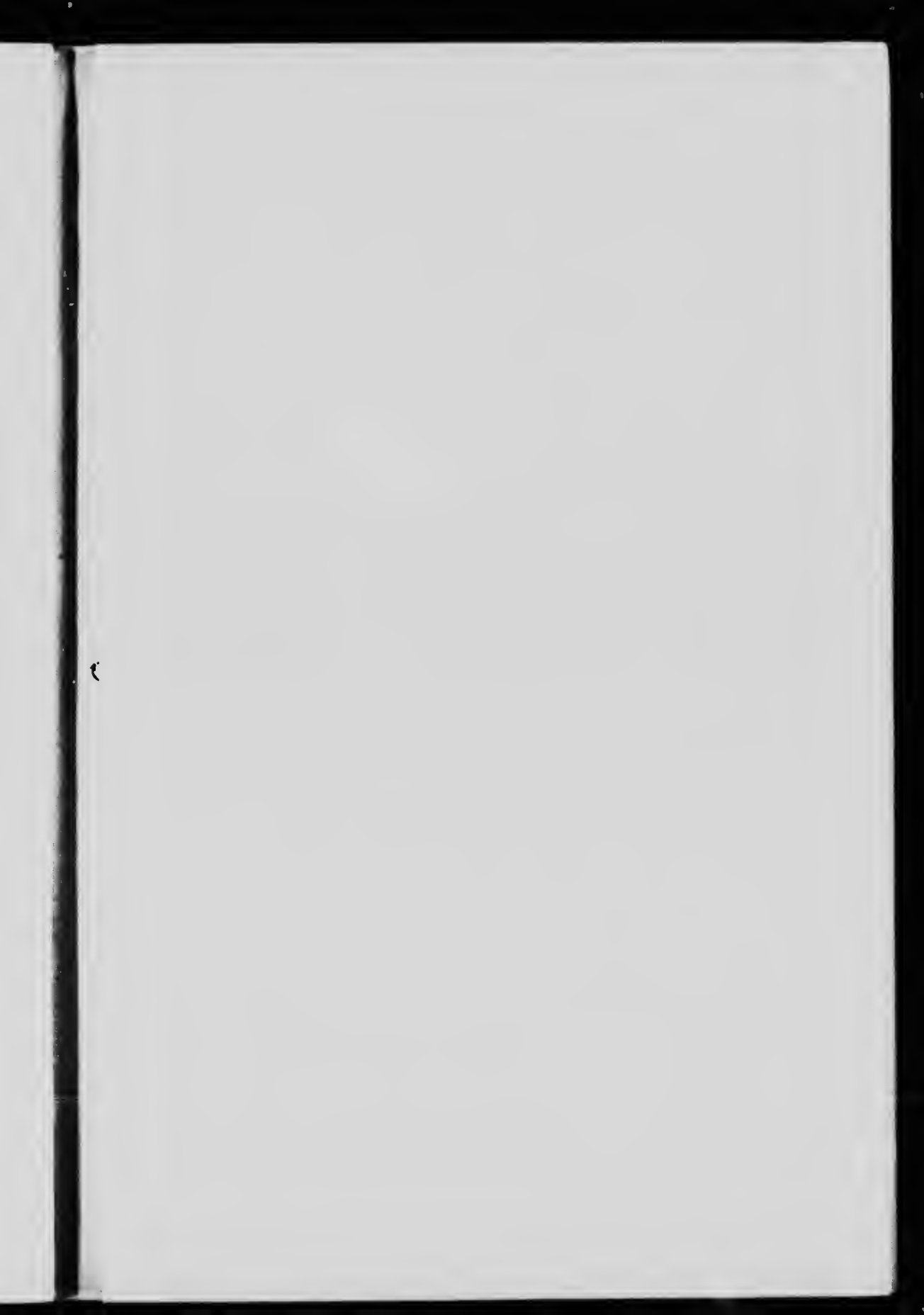

Fig. 7. Arrangement of circuits for electrical resistance measurements.

- W and W^1 = 2 volt and 4 volt storage batteries respectively.
 R and R^1 = Adjustable rheostats.
 U and U^1 = Double-throw switches.
 G = Galvanometer.
 r_1 and r_2 = Small resistances for protection of galvanometer in making adjustments.
 $Std.$ = Standard cell, e.m.f. = 1.0189 volts.
 S = Wire tested.
 S^1 = Standard resistance of 0.1 ohms correct to $\frac{1}{100}$ of one per cent, and with no temperature coefficient.

The reading of the contact point M gives the value of the electromotive force in tenths of a volt, and that of M^1 from hundredths to hundred-thousandths of a volt. Thus a very accurate measurement of the unknown electromotive force is obtained in terms of the known standard.

The unknown electromotive force in these experiments is not a cell, but is the drop in potential along S . S is a given length of the cobalt wire, whose resistance is to be measured, through which a small current



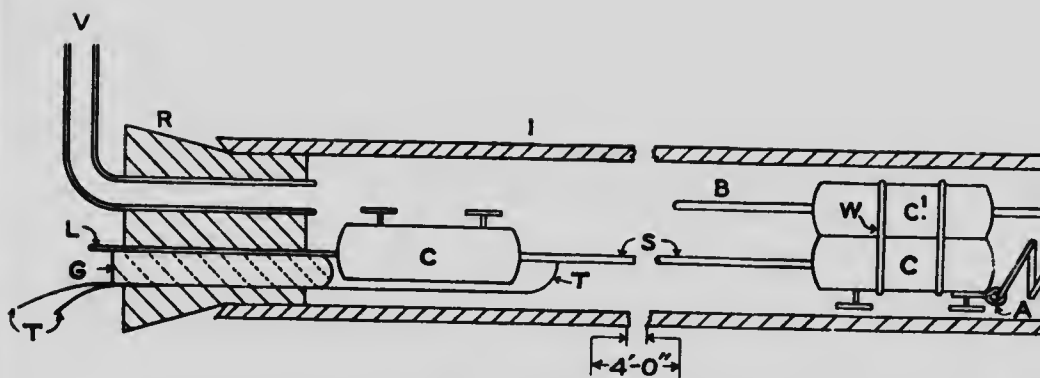
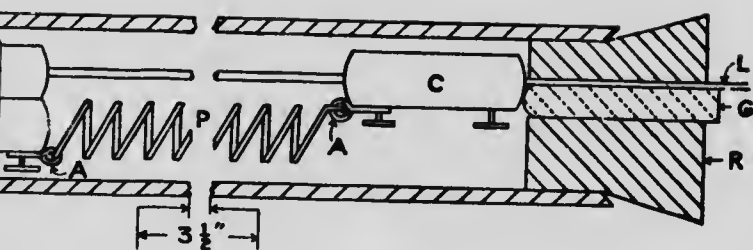

Fig. 8. Annealing furnace (full size): longitudinal section, taken



- A = Asbestos insulating rings.
- B = Contact bar.
- C = Double connectors.
- C' = " connector with set screws removed.
- G = Glass plugs.
- I = Iron tube.
- L = Electric power connections.
- P = Steel coil spring.
- R = Rubber stopper.
- S = Sample to be annealed.
- T = Thermo-couple.
- V = Connection to vacuum pump.
- W = Iron wire.

ion, taken vertically, through centre.

is passing from battery W^1 connected as shown in the diagram. In this latter circuit W^1S there is also connected a standard resistance S^1 of 0.1 ohms. By throwing the switch U^1 into the dotted position the drop in potential along S^1 was measured. Knowing the drop in potential along S and also along S^1 , when the same current is passing through each, the resistances are known from the following equation

$$\frac{\text{unknown resistance } S}{\text{known resistance } S^1} = \frac{\text{drop in potential along } S}{\text{drop in potential along } S^1}$$

Method of Computation.

The length S between two knife edges, which formed the contact points between which the electromotive force was determined, was carefully measured to tenths of a millimeter. The average diameter of the wire was measured to thousandths of a millimeter, and from these data the specific resistance of the wire in ohms per cubic centimeter was calculated to be

$$R = \mu \frac{l}{A} \quad \text{or} \quad \mu = \frac{R A}{l}$$

where R = total resistance of S in ohms,
 l = length of S in centimeters,
 A = average cross section of S in square centimeters,
 μ = specific resistance in ohms per centimeter cube.

After this measurement the wire was cut to the exact length S , carefully weighed to the nearest milligram, and the density of the wire determined by the Archimedes principle. From these data the resistance of the wire in ohms per meter gram was calculated as follows:—

$$R = \mu \frac{l}{A} \quad \text{or} \quad \mu = \frac{R A}{l}$$

$$D = \frac{M}{V} = \frac{M}{lA} \quad \text{or} \quad A = \frac{M}{lD}$$

from which we have—

$$R = D\mu \frac{l^2}{M} = \frac{k l^2}{M}, \quad \text{or} \quad k = \frac{Rm}{l^2}, \quad \text{where,}$$

R = resistance of S in ohms,
 M = mass of S in grams,
 D = density of S ,
 k = specific resistance of S in ohms per meter gram,
 V = volume of S in cubic centimeters.

For a comparison of k and μ it should be noted that k is equal to μ multiplied by the density of the wire times 10^3 .

Below is a table of the values obtained by this type of measurement both in ohms per centimeter cube, and in ohms per meter gram, together with analyses of the specimens. In each of the values for k , the computations were made directly from the length of the wire in meters and the mass of the wire in grams.

Annealing of Wires.

The effect of annealing on the conductivity of both pure and "commercial" cobalt was studied. In this connexion the annealing was accomplished by two methods:

- (1). Passing a suitable electric current through the wire in vacuo.
- (2). Heating within an electric furnace in a CO₂ atmosphere.

The annealing furnace used for heating in vacuo consisted of a cylindrical glass tube about 4 feet in length and 2 inches in diameter, and sealed off at the end with rubber stoppers. Through the ends protruded copper leads and a connexion to a vacuum pump. The slack in the cobalt wire, developed upon heating, was taken up by a coiled spring, as shown in Fig. 8. The approximate temperature was measured by a thermocouple placed against the annealing wire.

The furnace used for annealing in a carbon dioxide atmosphere consisted of an iron tube about 4 feet long, and 2 inches diameter, wound with suitable insulated nichrome wire. The ends, which were sealed off with rubber stoppers, were water cooled, and contained a suitable gas inlet and outlet.

In the tables following, showing the results of these resistance measurements, in the column under "Remarks", will be indicated by which of the above methods, "Vacuum Furnace" or "Carbon Dioxide Atmosphere", the annealing was accomplished.

Electrical Resistance of "Commercial Cobalt."

All of the samples of the following table of measurements were cast from just above the melting point, allowed to cool in an iron mould, and turned in a lathe to a bar of about one centimeter in diameter. They were then passed through the swaging machine, after special heat and mechanical treatment, as described on page 29, and drawn down to wires of the desired diameter. They were not annealed or given further heat treatment after drawing.

Unannealed.

Sample number.	Date.	Temperature of wire in degrees centigrade.	Length of wire in cms.	Average cross-sectional area of wire in sq. cms.	Weight of wire in grams.	Analysis.	Resistance in ohms per centimeter cube.	Resistance in ohms per meter gram.
H 192	Nov. 7 1913.	21.2	83.25	0.005568	3.9881	Co 99.63 Ni none Fe 0.60 S 0.023 C 0.090 Si trace Ca trace	229.6×10^{-7}	1.977
H 192	Nov. 7 1913.	21.0	50.20	0.005568	2.4051	Co 99.63 Ni none Fe 0.60 S 0.023 C 0.090 Si trace Ca trace	231.2×10^{-7}	1.992
H 192	Nov. 7 1913.	21.8	50.20	0.005568	2.4051	Co 99.63 Ni none Fe 0.60 S 0.023 C 0.090 Si trace Ca trace	231.5×10^{-7}	1.993
H 193	Nov. 8 1913.	21.9	75.07	0.01885	12.3871	Co 92.36 Ni 2.73 Fe 1.49 S 0.018 C none	144.4×10^{-7}	1.271
H 193	Nov. 8 1913.	22.0	51.67	0.01885	8.526	Co 92.36 Ni 2.73 Fe 1.49 S 0.018 C none	141.5×10^{-7}	1.271

Unannealed—(continued).

Sample Number.	Date.	Temperature of wire in degrees centigrade.	Length of wire in cms.	Average cross-sectional area of wire in sq. cms.	Weight of wire in grams.	Analysis.	Resistance in ohms per centimeter cube.	Resistance in ohms per meter gram.
H 214	Apr. 3 1914.	22.5	74.95	0.006374	4.304	Co 98.74 Ni none Fe 1.15 Si 0.14 Ca none Mn 0.012 C 0.039 P 0.010	105.8×10^{-7}	0.9540
H 214	Apr. 3 1914.	22.5	74.95	0.006374	4.304	Co 98.71 Ni none Fe 1.15 Si 0.14 Ca none Mn 0.012 C 0.039 P 0.010	105.8×10^{-7}	0.9530
H 214	Apr. 3 1914.	22.0	52.64	0.006319	3.023	Co 98.71 Ni none Fe 1.15 Si 0.11 Ca none Mn 0.012 C 0.039 P 0.010	105.1×10^{-7}	0.9515
H 214	Apr. 3 1914.	22.0	52.64	0.006319	3.023	Co 98.71 Ni none Fe 1.15 Si 0.14 Ca none Mn 0.012 C 0.039 P 0.010	104.8×10^{-7}	0.9521
H 214	Apr. 6 1914.	16.0	82.56	0.006319	4.723	Co 98.71 Ni none Fe 1.15 Si 0.11 Ca none Mn 0.012 C 0.039 P 0.010	104.2×10^{-7}	0.9131
H 211	Apr. 6 1914.	15.5	82.56	0.006319	4.723	Co 98.71 Ni none Fe 1.15 Si 0.14 Ca none Mn 0.012 C 0.039 P 0.010	103.8×10^{-7}	0.9403
H 214	Apr. 7 1914.	18.0	59.95	0.006305	3.429	Co 98.71 Ni none Fe 1.15 Si 0.14 Ca none Mn 0.012 C 0.039 P 0.010	104.7×10^{-7}	0.9502
H 214	Apr. 7 1914.	18.0	59.95	0.006305	3.429	Co 98.71 Ni none Fe 1.15 Si 0.14 Ca none Mn 0.012 C 0.039 P 0.010	104.7×10^{-7}	0.9502

Annealed.

All the samples of the following table were annealed at the temperatures given in the last column.

Sample number.	Date.	Temperature of wire in degrees centigrade.	Length of wire in ohms.	Average cross section of wire in sq. cms.	Weight of wire in grams.	Analysis.	Resistance in ohms per centimeter cube.	Resistance in ohms per meter gram.	Remarks.
H 214	Apl. 11 1914	13.0	74.65	0.006333	1.260	Co 98.71 Ni none Fe 1.15 Si 0.14 Ca none S 0.012 C 0.039 P 0.010	91.76×10^{-7}	0.8286	Annealed at 350°C for about 5 hours by passing current through wire. Vacuum furnace.
H 214	Apl. 11 1914.	13.0	47.50	0.006376	2.713	Co 98.71 Ni none Fe 1.15 Si 0.14 Ca none S 0.012 C 0.039 P 0.010	91.49×10^{-7}	0.8205	Annealed at 350°C for approximately 5 hours, by passing current thro' wire. Vacuum furnace.
H 214*	Apl. 21 1914.	21.5	83.69	0.006461	4.845	Co 98.71 Ni none Fe 1.15 Si 0.14 Ca none S 0.012 C 0.039 P 0.010	104.1×10^{-7}	0.9327	Annealed at 200°C for approximately 5 hours in furnace, CO ₂ atmosphere.
H 214*	Apl. 21, 1914.	21.5	49.97	0.006461	2.888	Co 98.71 Ni none Fe 1.15 Si 0.14 Ca none S 0.012 C 0.039 P 0.010	103.7×10^{-7}	0.9264	Annealed at 200°C for approximately 5 hours in furnace, CO ₂ atmosphere.
H 214*	Apl. 22, 1914.	19.2	82.80	0.006447	4.709	Co 98.71 Ni none Fe 0.15 Si 0.14 Ca none S 0.012 C 0.039 P 0.010	102.6×10^{-7}	0.9225	Annealed at 400°C for 2 hours in furnace, CO ₂ atmosphere.
H 214*	Apl. 22, 1914	19.2	45.86	0.006447	2.657	Co 98.71 Ni none Fe 0.15 Si 0.11 Ca none S 0.012 C 0.039 P 0.010	102.9×10^{-7}	0.9249	Annealed at 300°C for 2 hours in furnace, CO ₂ atmosphere.
H 214*	Apl. 23, 1914.	19.0	82.40	0.006390		Co 98.71 Ni none Fe 1.15 Si 0.14 Ca none S 0.012 C 0.039 P 0.010	100.7×10^{-7}	0.9090	Annealed at 400°C for 2 hours in furnace, CO ₂ atmosphere.
H 214*	Apl. 23, 1914.	19.0	51.91	0.006101		Co 98.71 Ni none Fe 1.15 Si 0.14 Ca none S 0.012 C 0.039 P 0.010	100.2×10^{-7}	0.9019	Annealed at 400°C for 2 hours in furnace, CO ₂ atmosphere.

*Samples H 214 series, Apl. 20-23, are all the same wire, annealed and unannealed.

Annals—continued.

Sample number.	Date.	Temperature of wire, degrees centigrade.	Length of wire in ohms.	Average cross-sectional area of wire in sq. cms.	Weight of wire in grams.	Analysis	Resistance in ohms per centimeter cube.	Resistance in ohms per meter gram.	Remarks.
H 214	Apr. 24, 1914	18.5	78.11	0.006291	4.478	Co 98.71 Ni none Fe 1.15 Mn 0.14 Ca none S 0.012 C 0.039 P 0.010	8.42×10^{-7}	0.8969	Annealed at 500°C for 2 hours in furnace, CO ₂ atmosphere.
H 214	Apr. 24, 1914	18.5	56.35	0.006291	3.240	Co 98.71 Ni none Fe 1.15 Mn 0.14 Ca none S 0.012 C 0.039 P 0.010	98.14×10^{-7}	0.8941	Annealed at 500°C for 2 hours in furnace, CO ₂ atmosphere.
H 214(a)	Apr. 25, 1914	19.3	81.65	0.006319	4.664	Co 98.71 Ni none Fe 1.15 Mn 0.14 Ca none S 0.012 C 0.039 P 0.010	93.34×10^{-7}	0.8447	Annealed at 600°C for 1 hour in furnace, CO ₂ atmosphere.
H 214	Apr. 25, 1914	19.3	57.50	0.006319	3.285	Co 98.71 Ni none Fe 1.15 Mn 0.14 Ca none S 0.012 C 0.039 P 0.010	93.63×10^{-7}	0.8466	Annealed at 600°C for 1 hour in furnace, CO ₂ atmosphere.
H 214	Apr. 27, 1914	15.6	66.67	0.006291	3.801	Co 98.71 Ni none Fe 1.15 Mn 0.14 Ca none S 0.012 C 0.039 P 0.010	91.14×10^{-7}	0.8285	Annealed at 700°C for 1 hour in furnace, CO ₂ atmosphere.
H 214	Apr. 27, 1914	15.8	51.01	0.006291	2.907	Co 98.71 Ni none Fe 1.15 Mn 0.14 Ca none S 0.012 C 0.039 P 0.010	90.90×10^{-7}	0.8232	Annealed at 700°C for 1 hour in furnace, CO ₂ atmosphere.
H 214	Apr. 28, 1914	18.4	53.55	0.006263	3.016	Co 98.71 Ni none Fe 1.15 Mn 0.14 Ca none S 0.012 C 0.039 P 0.010	90.35×10^{-7}	0.8204	Annealed at 800°C for 1 hour in furnace, CO ₂ atmosphere.

(a) Note drop in resistance between 500°C and 600°C.

Electrical Resistance of Pure Cobalt

All of the samples of the following table of specimens were cast from first above the melting point, allowed to cool in an iron mould, and turned in a lathe to a bar of about one centimeter in diameter. They were then passed through the swaging machine, after which they were annealed at heat and mechanical treatment, as described on page 29, and drawn down to wires of the desired diameter. They were not annealed or given further heat treatment after drawing.

Sample number.	Date	Temperature in degrees centigrade.	Length of wire.	Average cross-section area in sq. cms.	Weight in grams.	Analysis.	Resistance in ohms per centimeter cube.	Resistance in ohms per meter gram.
H 211	Jan. 22, 1914.	17°C.	92.81	0.00580	2.631	Co 99.9 Ni none Fe 0.20 S 0.017 C none Si none Ca none	87.27x10 ⁻⁷	0.7769
H 212	Jan. 22, 1914.	17	92.81	0.00580	2.631	Co 99.9 Ni none Fe 0.20 S 0.017 C none Si none Ca none	88.04x10 ⁻⁷	0.7834
H 213	Jan. 22, 1914.	17	50.23	0.00580	2.631	Co 99.9 Ni none Fe 0.20 S 0.017 C none Si none Ca none	88.08x10 ⁻⁷	0.7847
H ₂ 212	Jan. 22, 1914.	17	50.23	0.00580	2.631	Co 99.9 Ni none Fe 0.20 S 0.017 C none Si none Ca none	88.22x10 ⁻⁷	0.7840
H 212b	Jan. 22, 1914.	14	79.41	0.005822	4.113	Co 99.9 Ni none Fe 0.20 S 0.017 C none Si none Ca none	86.66x10 ⁻⁷	0.7713
H 212b	Jan. 22, 1914.	14	79.41	0.005822	4.113	Co 99.9 Ni none Fe 0.20 S 0.017 C none Si none Ca none	86.80x10 ⁻⁷	0.7727
H ₂ 212b	Jan. 22, 1914.	14	48.98	0.005822	2.538	Co 99.9 Ni none Fe 0.20 S 0.017 C none Si none Ca none	85.80x10 ⁻⁷	0.7637
H 212b	Jan. 22, 1914.	14	48.98	0.005822	2.538	Co 99.9 Ni none Fe 0.20 S 0.017 C none Si none Ca none	85.55x10 ⁻⁷	0.7616
H ₂ 215	Apr. 2, 1914.	22	95.38	0.006547	5.432	Co 99.6 Ni none Fe 0.19 S 0.012 C none Si 0.084 Ca none P 0.0066	89.17x10 ⁻⁷	0.7756

Unannealed—(continued).

Sample number.	Date.	Temperature in degrees centigrade.	Length of wire.	Average cross-sectional area in sq. cms.	Weight in grams.	Analysis.	Resistance in ohms per centimeter cube.	Resistance in ohms per meter gram.
H 215	Apr. 4, 1914.	22	95.48	0.006547	5.442	Co 99.6 Ni none Fe 0.19 S 0.012 C none Si 0.084 Ca none P 0.0066	89.98x10 ⁻⁷	0.896
H 215	Apr. 4, 1914	23.0	95.48	0.006547	5.440	Co 99.6 Ni none Fe 0.19 S 0.012 C none Si 0.084 Ca none P 0.0066	89.98x10 ⁻⁷	0.896
H 215	Apr. 4, 1914.	23.0	95.48	0.006547	5.442	Co 99.6 Ni none Fe 0.19 S 0.012 C none Si 0.084 Ca none P 0.0066	90.26x10 ⁻⁷	0.7852

Annealed.

The following bars were annealed at the temperature given in the last column.

Sample number.	Date.	Temperature in degrees centigrade.	Length of wire.	Average cross-sectional area in sq. cms.	Weight in grams.	Analysis.	Resistance in ohms per centimeter cube.	Resistance in ohms per meter gram.	Remarks.
H 215	Apr. 13, 1914.	17.7	85.21	0.006475	4.831	Co 99.6 Ni none Fe 0.19 S 0.012 C none Si 0.084 Ca none P 0.0066	85.03x10 ⁻⁷	0.7119	Annealed at 350°C for approximately five hours by passing current through the wire in vacuum.
H 215	Apr. 13, 1914	17.7	85.21	0.006475	4.840	Co 99.6 Ni none Fe 0.19 S 0.012 C none Si 0.084 Ca none P 0.0066	85.18x10 ⁻⁷	0.7163	Annealed at 350°C for approximately five hours by passing current through the wire in vacuum.
H 215	Apr. 13, 1914.	17.7	50.2	0.006475	2.848	Co 99.6 Ni none Fe 0.19 S 0.012 C none Si 0.084 Ca none P 0.0066	84.92x10 ⁻⁷	0.7424	Annealed at 350°C for approximately five hours by passing current through the wire in vacuum.
H 215	Apr. 13, 1914.	17.7	50.2	0.006475	2.848	Co 99.6 Ni none Fe 0.19 S 0.012 C none Si 0.084 Ca none P 0.0066	85.04x10 ⁻⁷	0.7346	Annealed at 350°C for approximately five hours by passing current through the wire in vacuum.
H 215	Apr. 21, 1914	19.0	74.44	0.006151	4.224	Co 99.6 Ni none Fe 0.19 S 0.012 C none Si 0.084 Ca none P 0.0066	97.42x10 ⁻⁷	0.8988	Annealed at 100°C for 2 hours in furnace, CO ₂ atmosphere.

Tinned—(continued).

Sample number.	Date.	Temperature of wire in degrees centigrade.	Length of wire in ohms.	Average cross-sectional area of wire in sq. cms.	Weight of wire in grams.	Analyses.	Resistance in ohms per centimeter cube.	Resistance in ohms per meter gram.	Remarks.
H 215	Apr. 21 1914	18.8	39.89	0.006221	2.264	Co 99.6 Ni none Fe 0.19 S 0.012 C none Si 0.084 Ca none P 0.0066	97.94x10 ⁻⁷	0.8938	Annealed at 400°C for 2 hours in furnace, CO ₂ atmosphere.
H 215	Apr. 22 1914	21.2	73.99	0.006249	1.162	Co 99.6 Ni none Fe 0.19 S 0.012 C none Si 0.084 Ca none P 0.0066	101.0x10 ⁻⁷	0.9108	Annealed at 500°C for 1½ hours in furnace, CO ₂ atmosphere.
H 215	Apr. 22 1914	21.2	49.41	0.006249	2.779	Co 99.6 Ni none Fe 0.19 S 0.012 C none Si 0.084 Ca none P 0.0066	101.1x10 ⁻⁷	0.9176	Annealed at 500°C for 1½ hours in furnace, CO ₂ atmosphere.
H 215(a)	Apr. 23 1914	15.4	72.75	0.006249	1.080	Co 99.6 Ni none Fe 0.19 S 0.012 C none Si 0.084 Ca none P 0.0066	93.54x10 ⁻⁷	0.8395	Annealed at 600°C for 1 hour in furnace, CO ₂ atmosphere.
H 215	Apr. 23 1914	15.4	52.23	0.006221	2.930	Co 99.6 Ni none Fe 0.19 S 0.012 C none Si 0.084 Ca none P 0.0066	93.85x10 ⁻⁷	0.8460	Annealed at 600°C for 1 hour in furnace, CO ₂ atmosphere.
H 215	Apr. 24 1914	19.0	51.37	0.006235	2.875	Co 99.6 Ni none Fe 0.19 S 0.012 C none Si 0.084 Ca none P 0.0066	94.06x10 ⁻⁷	0.8412	Annealed at 700°C for 1 hour in furnace, CO ₂ atmosphere.
H 215	Apr. 24 1914	19.0	71.05	0.006291	1.115	Co 99.6 Ni none Fe 0.19 S 0.012 C none Si 0.084 Ca none P 0.0066	93.34x10 ⁻⁷	0.8360	Annealed at 700°C for 1 hour in furnace, CO ₂ atmosphere.
H 215	Apr. 28 1914	16.5	73.11	0.006207	1.080	Co 99.6 Ni none Fe 0.19 S 0.012 C none Si 0.084 Ca none P 0.0066	91.36x10 ⁻⁷	0.8203	Annealed at 800°C for ½ hour in furnace, CO ₂ atmosphere.
H 215	Apr. 28 1914	16.5	51.15	0.006207	3.032	Co 99.6 Ni none Fe 0.19 S 0.012 C none Si 0.084 Ca none P 0.0066	91.65x10 ⁻⁷	0.8240	Annealed at 800°C for ½ hour in furnace, CO ₂ atmosphere.

(a) Note drop in resistance between 500°C and 600°C, as before.

The following values of the specific resistance of cobalt are taken from the literature:—

Specific Electrical Resistance of Cobalt.

	Temperature	Specific resistance in ohms per centimeter cube.
Cupaux ¹ .	Room	55×10^{-7}
Reuer and Kauko ² .	Room	61×10^{-7}
Hofman ³ .	Room	97×10^{-7}
Knott, C. G. ⁴	100°C	121×10^{-7}
Knott, C. G. ⁴	200°C	159×10^{-7}
Reichardt ⁵ 99.8% Co.	20°C	97×10^{-7}

In addition to these, the following values of the specific resistance of nickel are taken from the literature:—

Specific Electrical Resistance of Nickel.

	Temperature	Specific resistance in ohms per centimeter cube.
Cupaux ¹ .	Room	61×10^{-7}
Reuer and Kauko ² .	Room	77.2×10^{-7}
Hofman ³ .	Room	70×10^{-7}
Fleming ⁴	0°C	69×10^{-7}
Niccolai ⁵	0°C	119×10^{-7}
Harrison, E. P. ⁶	0°C	103×10^{-7}

¹ *Annales de Chimie et de Physique* (8), Vol. 6, 1905, p. 508.

² *Ferrame*, Vol. 10, p. 257. *Chemical Abstracts*, 113, p. 3591.

³ *General Metallurgy*, 1913, p. 29.

⁴ *Proceedings of the Royal Society of Edinburgh*, 18, 303, 1891.

⁵ *Annales de Physic.* (4) 6, 832, 1901.

⁶ *Proceedings of the Royal Society*, Vol. 66, p. 50, 1900.

⁷ *Lincei Rend.*, 16, (1), p. 757, 1906.

⁸ *Lincei Rend.*, 16, (2), p. 185, 1907.

⁹ *Proceedings of the Physical Society*, Vol. 18, p. 57, 1902.

¹⁰ *Philosophical Magazine*, (6) Vol. 3, p. 177, 1902.

Conclusions.

Pure Cobalt.

(1). The specific electrical resistance of cobalt wires of extreme purity is 89.64×10^{-7} ohms per centimeter cube, or 0.7769 ohms per meter gram, at 18°C. This is the average of twelve observations agreeing well among themselves, and is for wires unannealed after swaging. This is approximately five times that of pure copper.

(2). The effect of annealing cobalt wire of extreme purity in vacuo, at about 350°C for several hours, by passing an electric current through the wire is to diminish its electrical resistance by about 5 per cent. This is not as much as is true of some metals, as for example, aluminium, which diminishes its resistance about 10 per cent by annealing for 2 hours at 250°C.¹

¹ H. Gwercke, *Electrician*, Vol. 72, p. 450. *Chemical Abstracts*, 1914, p. 1019.

(3). The effect of annealing cobalt wires of extreme purity in an atmosphere of carbon dioxide gas by heating from an external source is at first to increase the resistance, but with continued annealing at increasingly higher temperatures up to 800°C, the specific resistance drops again. It is particularly noticeable that there is a drop of about 7 per cent in the specific electrical resistance of cobalt wire of extreme purity, annealed in a carbon dioxide atmosphere at 600°C compared with one similarly annealed at 500°C. This drop was from 101×10^{-7} ohms per centimeter cube to 93.5×10^{-7} ohms per centimeter cube.

(4). The fact that annealing in vacuo diminishes the electrical resistance of pure cobalt, whereas annealing in an inert gas at low temperatures increases its electrical resistance, which is again lowered by heating at higher temperatures, tends to show that the specific electrical resistance of cobalt is largely influenced by the presence of occluded or absorbed gases.

"Commercial Cobalt."

(5). The specific electrical resistance of cobalt, similar to copper and most other metals, increases tremendously by the addition of small percentages of impurities. Less than 0.5 per cent of impurities may treble the electrical resistance.

(6). The specific electrical resistance of "commercial cobalt" varies between 231×10^{-7} and 103×10^{-7} ohms per centimeter cube, for the cases we have studied, depending upon the nature of the small percentages of impurities present. These figures are for wires unannealed after swaging.

(7). The effect of annealing "commercial cobalt" by passing an electric current through the wire in vacuo, is to greatly reduce its specific electrical resistance. Annealing in this way at 350°C for 5 hours reduced the specific resistance by approximately 14 per cent.

(8). The effect of annealing "commercial cobalt" in an atmosphere of carbon dioxide gas by heating from an external source is in general to decrease its resistance. Similar to the case of pure cobalt, there is a sharp decrease in resistance in the sample annealed in an atmosphere of CO₂ gas at 600°C compared with that similarly annealed at 500°C.

These conclusions all refer to measurements on wires made from bars cast from just above the melting temperature, allowed to cool in an iron mould, and then swaged to wires of approximately 0.03" diameter, in the manner described on pages 29-30.

Magnetic Permeability.

Cobalt is magnetic at all temperatures up to about 1100°C. The magnetic permeability and hysteresis of pure and "commercial" cobalt have been and are being studied at this laboratory, and will be reported in detail in connexion with the publication concerning certain magnetic alloys of cobalt.

Specific Heat Measurements.

Method and Apparatus.

The specific heat of cobalt was determined by the method of mixtures, and the result is probably accurate to within 0.5 per cent.

The method employed consisted in heating a weighed amount of metallic cobalt in the form of short pieces of wire to 100°C, by bringing them into temperature equilibrium with steam at normal temperature and pressure, at the same time having them enclosed so that they were perfectly dry. This was accomplished by a simple boiler device.

When the metal was thus brought to 100°C —which temperature was read on a suitable thermometer, and after constant temperature readings on this thermometer had been obtained for a period of minutes—it was dropped directly from the heater into a suitable calorimeter. Prior to dropping the cobalt at 100°C into the calorimeter, preliminary temperature readings of the water in the calorimeter were made over a period of minutes. These readings were continued with uniform stirring of the calorimeter liquid, after the introduction of the cobalt, until the final equilibrium calorimeter temperature had been reached.

The thermometer was read to one hundredth of a degree centigrade, and readings were taken every twenty seconds. This method obviously gives us the mean specific heat between 100°C and room temperature, approximately 15°C .

As this is a more or less standard calorimeter observation, it is not seen fit to give the minor details of the apparatus and method of procedure.

Material.

The cobalt used for the specific heat measurements analysed as follows:

H 213. Co.....	99.73
Ni.....	none
Fe.....	0.14
S.....	0.019
C.....	none
Si.....	0.040
Ca.....	none
P.....	none

The mean of a series of specific heat measurements, made as indicated above, gives us as the

$$\text{mean specific heat of cobalt between } 15 - 100^{\circ}\text{C} = 0.1053,$$

with an average deviation of single observations from the mean of about 0.5 per cent.

The writers wish to acknowledge their indebtedness to Professor W. J. Drisko of the Department of Physics, Massachusetts Institute of Technology, Boston, who was good enough to have several specific heat measurements of the same material made under his direction at the Massachusetts Institute of Technology. These measurements were made on the same material as above (H 213), which was sent from this laboratory for the purpose. Following are the measurements:—

H 213, March 18, 1914.

Specific heat of Cobalt.		Deviation of a single observation from the mean.	
	0.1070		0.0014
	0.1037		0.0019
	0.1058		0.0002
	0.1060		0.0004
Mean	0.1056	Average	0.0010

Mean specific heat of cobalt between $15 - 100^{\circ}\text{C} = 0.1056 \pm 0.0005$.

The following values of the specific heat of cobalt are taken from the literature.

Name of observer	Temperature range	Specific heat
Tilden 1, . . .	152 to 150	0.0822
	78 " 15	0.0949
	15 " 100	0.1030
	15 " 185	0.1047
	15 " 350	0.1087
	15 " 435	0.1147
	15 " 550	0.1209
Tilden 2, . . .	15 " 630	0.1234
	20 " 200.0	0.101
Copaux 1, . . .	500°C	0.1451
	800	0.1416
	1000	0.104
Copaux 2, . . .	90 " 100.0	0.101
Kalmus and Harper Drisko ⁵	15 " 100.0	0.1053
	15 " 100.0	0.1056

¹ Proceedings of Royal Society, Vol. 66, 1900, p. 244.

² Proceedings of Royal Society, Vol. 71, 1903, p. 220.

³ Comptes Rendus, Vol. 140, 1905, p. 657.

⁴ Annales de Chimie et de Physique (8), Vol. 6, 1905, p. 508.

⁵ The Physical Properties of the Metal Cobalt, 1911. (This Report).

From these figures the true specific heat at any temperature may be computed from 0°C to 890°C.

$$\text{Specific heat} = 0.1058 + 0.0000457t + 0.00000066t^2.$$

MICROPHOTOGRAPHS

Following are a series of microphotographs taken in connexion with the metals discussed in the preceding pages. No attempt has been made to make a minute or complete microphotographic study or analysis of cobalt with the small percentages of impurities with which we have to do in this paper. Such a study would be decidedly interesting, but unfortunately, is not possible in the time at our disposal.

The microphotographs shown are rather characteristic, and require no further explanation than the legend accompanying them and reference to the text to which they belong.

Pure Cobalt H 212

Tensile strength bar.

Cast from just above the melting point, allowed to cool in iron mould, and turned in lathe.

Date of microphotograph—May 8, 1914.

Density—8.7562 at 17°C

Analysis

Co.....	99.9
Fe.....	0.20
Ni.....	none
C.....	none
S.....	0.017
Ca.....	none
Si.....	none

Brinell hardness—128.7.

Tensile breaking load—37,900 pounds per square inch.

Melting point—1,478°C, + 1.1°C.

Etching—strong iodine for 3 minutes.

Magnification—130 diameters.

Exposure—1 second.

PLATE IV



Pure Cobalt (H 212).

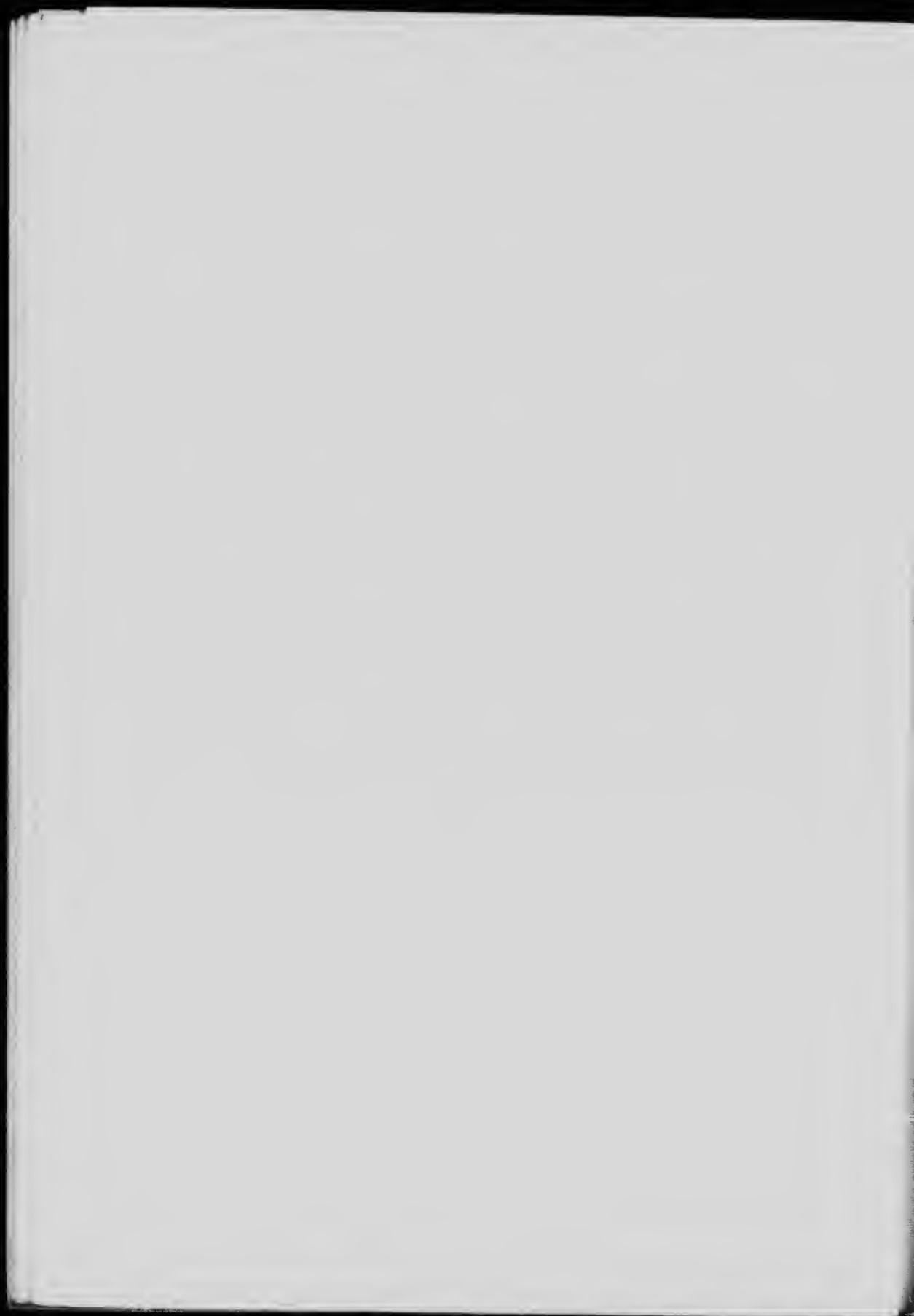

PLATE V.



Commercial Cobalt (H 213).

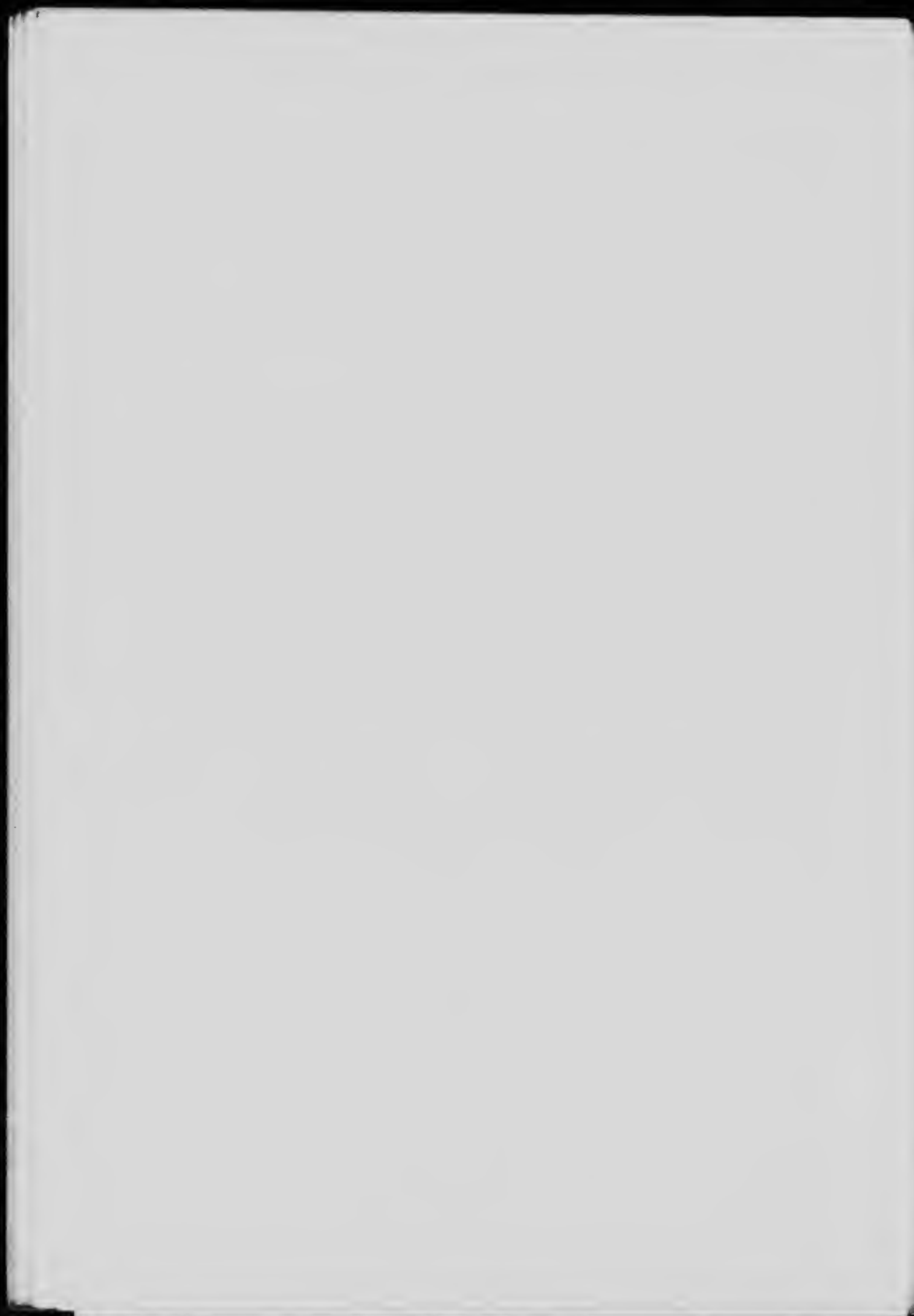
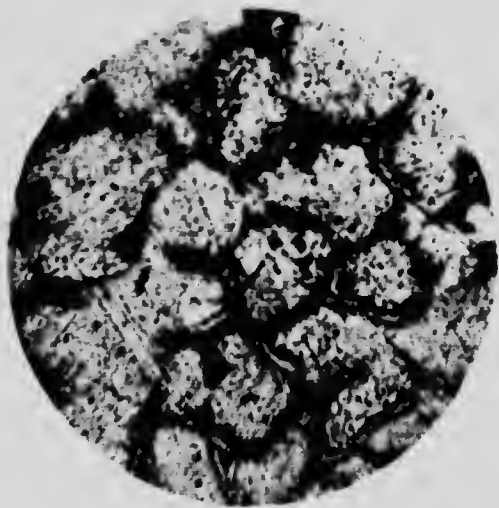

PLATE VI



Pure Cobalt (H 214).



PLATE VII.



Commercial Cobalt (H 130).



PLATE VIII

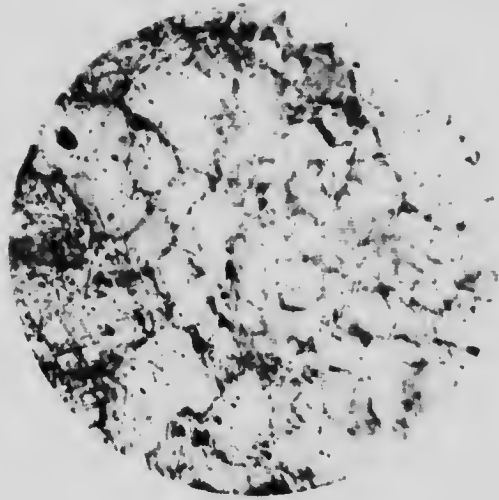

Commercial Cobalt H 214c



PLATE IX.



Commercial Cobalt (H 244c)

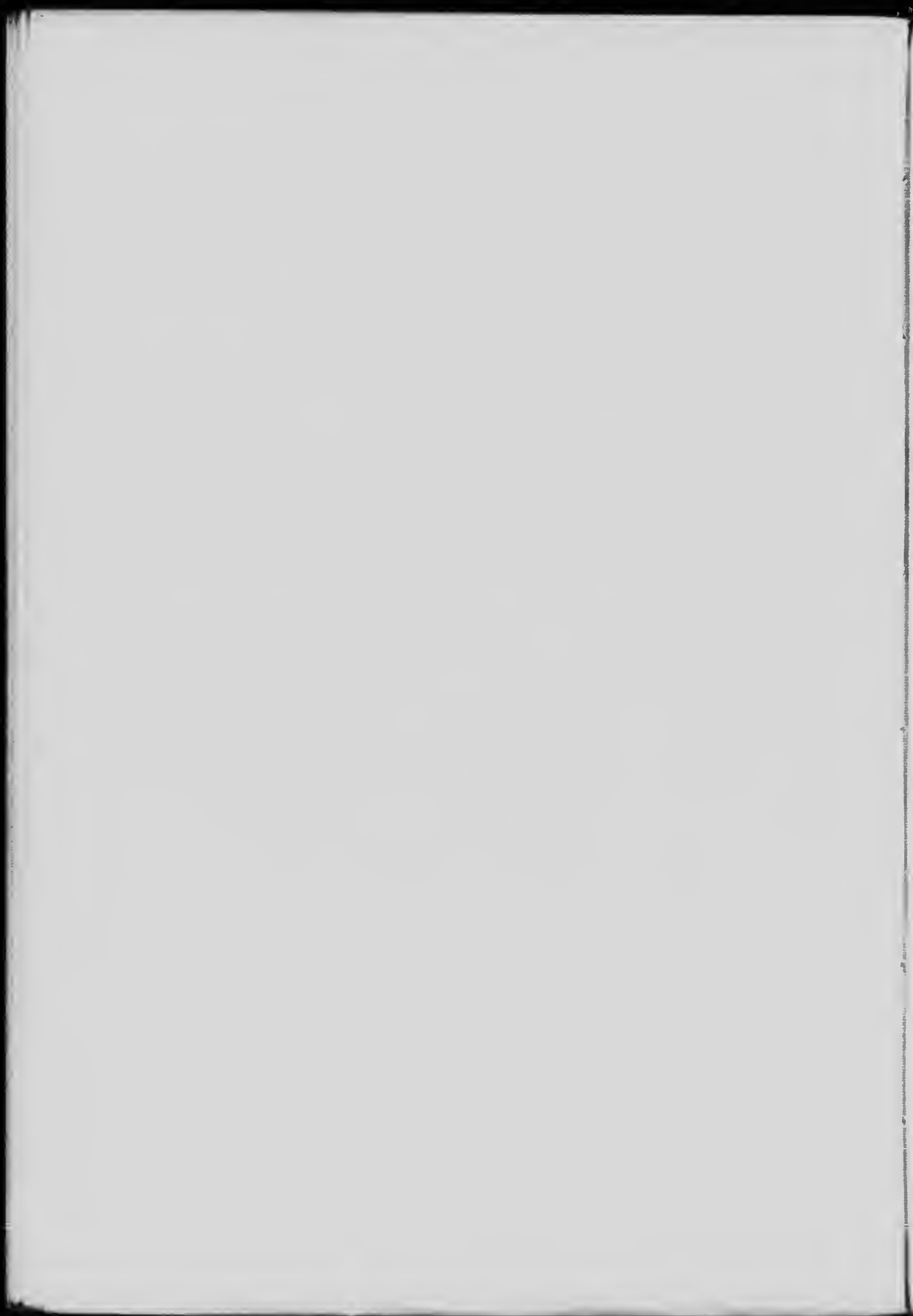
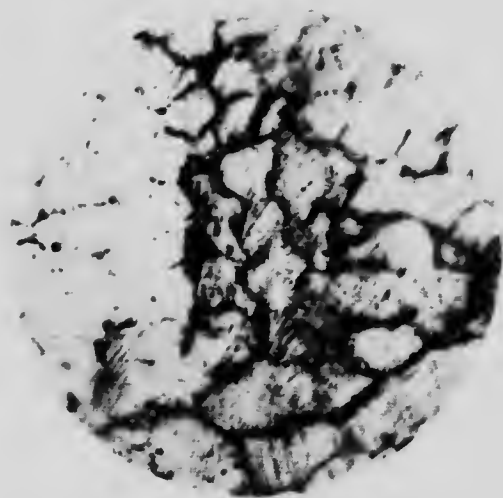

PLATE X.



Commercial Cobalt II 87c



PLATE XI.

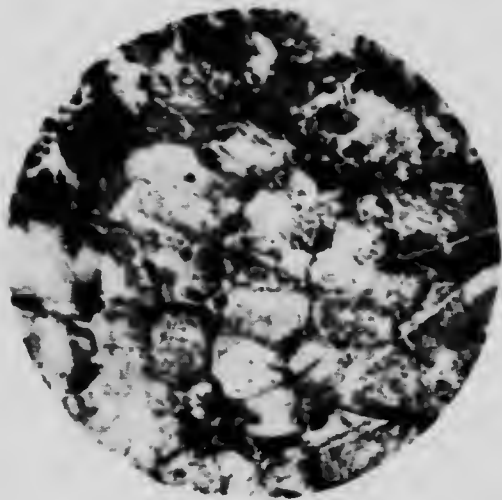

Commercial Cobalt (H 87c).



PLATE XII.



Commercial Cobalt (H 109)



PLATE XIII.

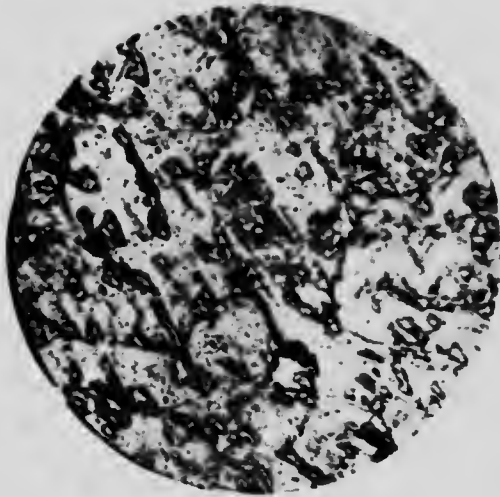

Commercial Cobalt (H 211).

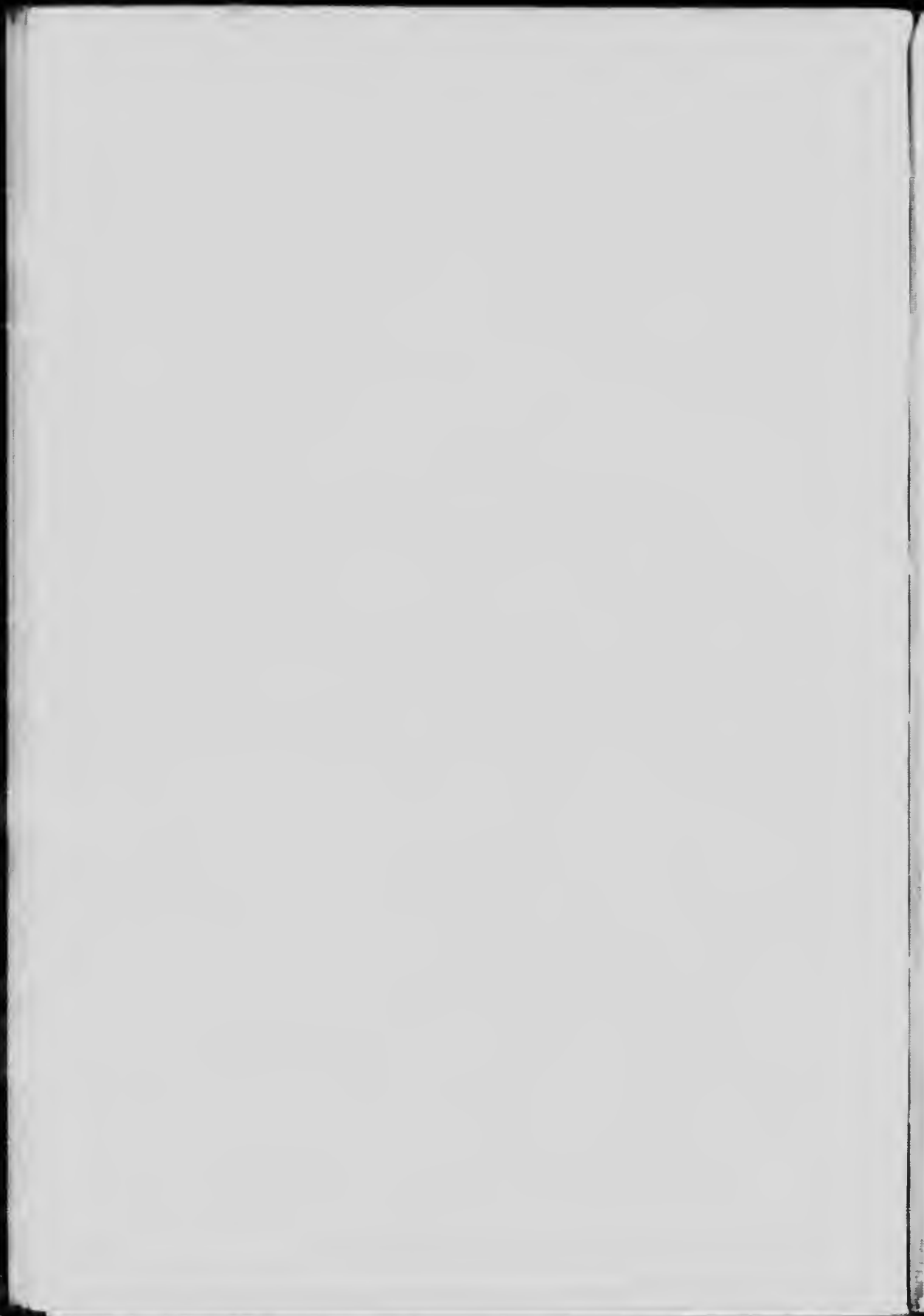

"Commercial Cobalt" H 213

Date of microphotograph—May 9, 1914.

Density—8.7732 at 16°C.

Analysis—

	%
Co	99.73
Ni	none
Fe	0.14
S	0.019
C	none
Si	0.020

Brinell hardness—121.0.

Tensile breaking load—45,300 pounds per square inch.

Etching—strong iodine for 5 seconds.

Magnification—130 diameters.

Exposure—1 second.

Cobalt H 214

Tensile strength bar.

Cast from just above melting point, allowed to cool in iron mould and turned in lathe.

Date of microphotograph—May 1, 1914.

Density—8.3490 at 15°C.

Analysis—

	%
Co	98.7
Ni	none
Fe	1.15
Si	0.14
Ca	none
S	0.012
C	none
P	0.011

Etching—strong iodine—14 minutes.

Magnification—130 diameters.

Exposure—2 seconds.

This sample shows polyhedral crystalline structure, with impurities rejected to the boundaries of the crystalline grains.

"Commercial Cobalt" H 130

Tensile strength bar.

Cast from just above the melting point, allowed to cool in iron mould, and turned in lathe.

Date of microphotograph—May 1, 1914.

Density—8.7690 at 17°C.

Analysis—

	%
Co	96.5
Ni	2.0
Fe	1.27
C	0.305
S	0.054
P	0.015

Brinell hardness—116.6.

Etching—strong iodine—7 minutes.

Magnification—130 diameters.

Exposure—2 seconds.



MICROCOPY RESOLUTION TEST CHART

(ANSI and ISO TEST CHART No. 2)

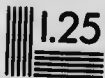

APPLIED IMAGE Inc

1653 East Main Street
Rochester, New York 14609 USA
(716) 482 - 0300 - Phone
(716) 288 - 5989 - Fax

"Commercial Cobalt" H 214c

Tensile strength bar.

Cast from just above the melting point, allowed to cool in iron mould, and turned in lathe. Annealed at 850°C.

Date of microphotograph—May 6, 1914.

Analysis—	%
Co.....	97.09
Ni.....	none
Fe.....	1.45
C.....	0.067
S.....	0.012
Mn.....	2.04
Si.....	0.011
Cu.....	none
P.....	0.010

Tensile breaking load—70,500 pounds per square inch.

Etching—strong iodine—5 minutes.

Magnification—130 diameters.

Exposure—1 second.

"Commercial Cobalt" H 214c

Tensile strength bar.

Cast from just above the melting point, allowed to cool in iron mould, and turned in lathe. Annealed at 1,000°C.

Date of microphotograph—May 2, 1914.

Analysis—	%
Co.....	97.09
Ni.....	none
Fe.....	1.45
C.....	0.067
S.....	0.012
Mn.....	2.04
Si.....	0.011
Ca.....	none
P.....	0.010

Tensile breaking load—75,200 lbs. per square inch.

Etching—strong iodine—9 minutes.

Magnification—130 diameters.

Exposure—2 seconds.

"Commercial Cobalt" H 87c

Tensile strength bar.

Cast from just above the melting point, allowed to cool in iron mould, and turned in lathe. Annealed at 850°C.

Date of microphotograph—May 6, 1914,

Density—8.6658 at 17°C.

Analysis—	%
Co.....	97.8
Ni.....	0.50
Fe.....	1.46
S.....	0.020
C.....	0.18
Ca.....	trace
Si.....	0.020
P.....	trace

Tensile breaking load—60,200 pounds per square inch.
 Etching—Strong iodine—10 minutes.
 Magnification—130 diameters.
 Exposure—1 second.

“Commercial Cobalt” H 87c

Tensile strength bar.
 Cast from just above the melting point, allowed to cool in iron mould, and turned in lathe.

Date of microphotograph—May 6, 1914.

Analysis—	%
Co.....	97.8
Fe.....	1.46
Ni.....	0.50
C.....	0.18
S.....	0.020
Si.....	0.020
Ca.....	none
P.....	0.012

Tensile breaking load—56,100 pounds per square inch.
 Etching—strong iodine—1 minute.
 Magnification—130 diameters.
 Exposure—2 seconds.

“Commercial Cobalt” H 109

Tensile strength bar.
 Cast from just above the melting point, allowed to cool in iron mould, and turned in lathe.

Date of microphotograph—May 6, 1914.

Density—8.7997 at 18.5°C.

Analysis—	%
Co.....	96.8
Ni.....	0.56
Fe.....	2.36
S.....	0.022
C.....	0.063
P.....	0.017

Brinell hardness—107.
 Tensile breaking load—52,600 pounds per square inch.
 Etching—strong iodine— $\frac{1}{2}$ minute.
 Magnification—130 diameters.
 Exposure— $\frac{1}{2}$ second.

“Commercial Cobalt” H 211

Tensile strength bar.
 Cast from just above the melting point, allowed to cool in iron mould, and machined in lathe.

Date of microphotograph—May 6, 1914.

Analysis—	%
C.....	0.18
S.....	0.080
P.....	0.031

Brinell hardness—128·2.

Tensile breaking load—31,000 pounds per square inch.

Etching—strong iodine—1 minute.

Magnification—130 diameters.

Exposure—1 second.

This sample shows "ghosts" or "ghost lines" because it is suffering from segregation of its impurities, C, S, and P. Metals of this kind are usually brittle, weak and hard, which are the characteristics of this particular sample as shown under the tables of measurements preceding.

Pure Nickel

Tensile strength bar.

Cast from just above the melting point, allowed to cool in iron mould, and turned in lathe.

Date of microphotograph—May 7, 1914.

Analysis—	%
Ni.....	99·29
Fe.....	0·48
Co.....	none
S.....	0·025
Si.....	0·042
Ca.....	none
C.....	none

Brinell hardness—83·1.

Tensile breaking load—18,000 pounds per square inch.

Melting point—1,452°C.

Etching—nitric acid,—specific gravity 1·42—4 seconds.

Magnification—130 diameters.

Exposure—2 seconds.

This nickel shows polyhedral crystalline structure of the pure metal.

ACKNOWLEDGMENTS.

The analyses throughout the paper were made by Mr. R. C. Wilcox, part-time assistant in the Research Laboratory of Applied Electro-chemistry and Metallurgy, Queen's University; and valuable assistance was rendered by Messrs. W. L. Savell, B.Sc., and K. B. Blake, S.B., both part-time research associates—in conducting certain of the experiments. The authors wish to acknowledge their indebtedness to these gentlemen.

PLATE XIV.



Pure Nickel.

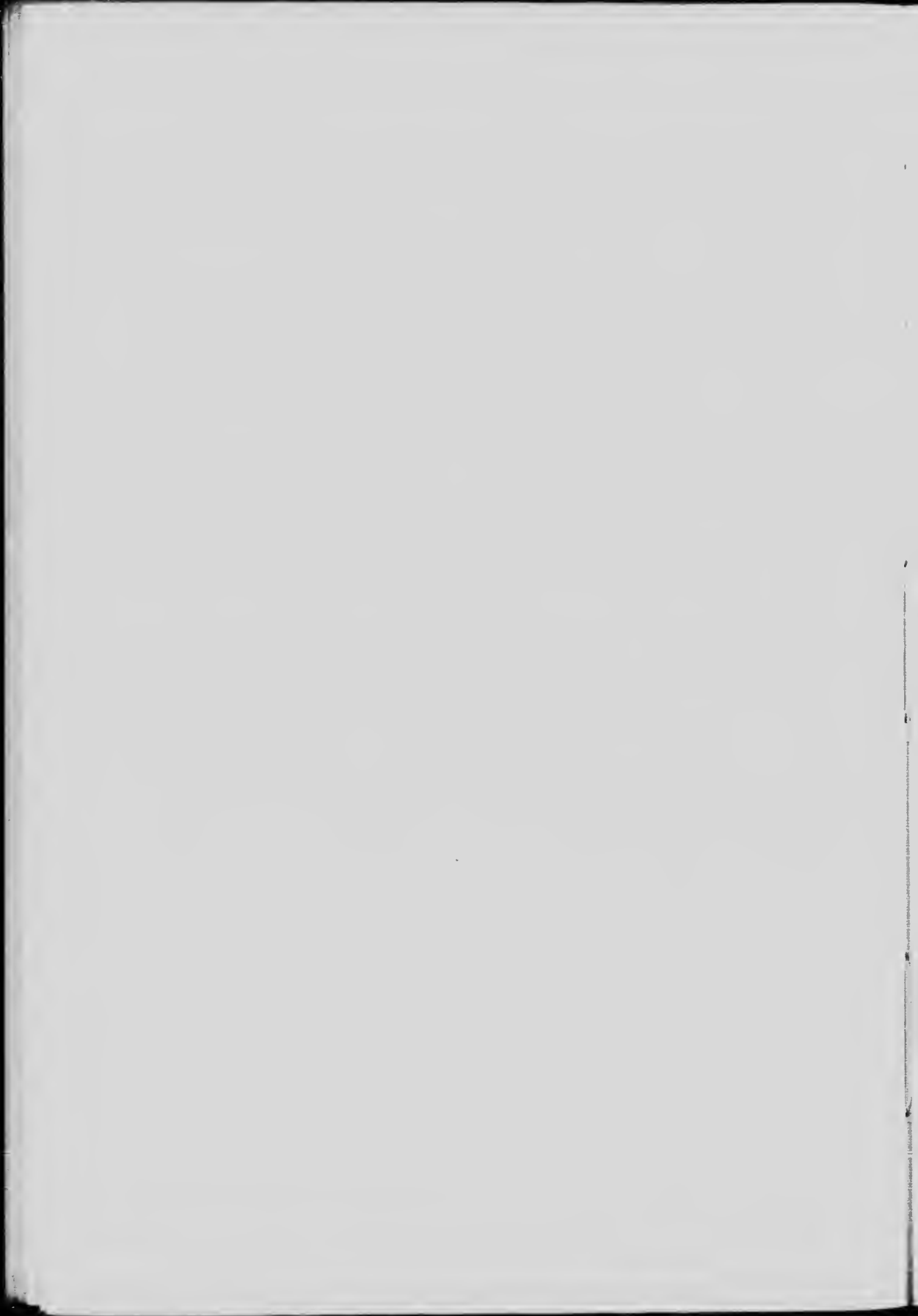

CANADA
DEPARTMENT OF MINES
 HON. LOUIS CODERRE, MINISTER; K. W. BROCK, DEPUTY MINISTER.

MINES BRANCH
 EUGÈNE HAANEL, PH. D., DIRECTOR.

REPORTS AND MAPS

PUBLISHED BY THE
MINES BRANCH

REPORTS.

1. Mining Conditions in the Klondike, Yukon. Report on—by Eugène Haanel, Ph. D., 1902.
- †2. Great Landslide at Frank, Alta. Report on—by R. G. McConuell, B.A., and R. W. Brock, M.A., 1903.
- †3. Investigation of the different electro-thermic processes for the smelting of iron ores, and the making of steel, in operation in Europe. Report of Special Commission—by Eugene Haanel, Ph.D., 1904.
- †4. Rapport de la Commission nommée pour étudier les divers procédés électro-thermiques pour la réduction des minerais de fer et la fabrication de l'acier employés en Europe—by Eugene Haanel, Ph.D. (French Edition), 1905.
5. On the location and examination of magnetic ore deposits by magneto-metric measurements—by Eugene Haanel, Ph.D., 1904.
- †7. Limestones and the Lime Industry of Manitoba. Preliminary Report on—by J. W. Wells, M.A., 1905.
- †8. Clays and Shales of Manitoba: Their Industrial Value. Preliminary Report on—by J. W. Wells, M.A., 1905.
- †9. Hydraulic Cements (Raw Materials) in Manitoba: Manufacture and Uses of. Preliminary Report on—by J. W. Wells, M.A., 1905.

†Publications marked thus † are out of print.

- †10. Mica: Its Occurrence, Exploitation, and Uses—by Fritz Cirkel, M.E., 1905. (See No. 118.)
- †11. Asbestos: Its Occurrence, Exploitation, and Uses—by Fritz Cirkel, M.E., 1905. (See No. 69.)
- †12. Zinc Resources of British Columbia, and the Conditions affecting their Exploitation. Report of the Commission appointed to investigate—by W. R. Ingalls, M.E., 1905.
- †16. *Experiments made at Sault Ste. Marie, under Government auspices, in the smelting of Canadian iron ores by the electro-thermic process. Final Report on—by Eugene Haanel, Ph.D., 1907.
- †17. Mines of the Silver-Cobalt Ores of the Cobalt district: Their Present and Prospective Output. Report on—by Eugene Haanel, Ph.D., 1907.
- †18. Graphite: Its Properties, Occurrence, Refining, and Uses—by Fritz Cirkel, M.E., 1907.
- †19. Peat and Lignite: Their Manufacture and Uses in Europe—by Erik Nystrom, M.E., 1908.
- †20. Iron Ore Deposits of Nova Scotia. Report on (Part 1)—by J. E. Woodman, D.Sc.
- †21. Summary Report of Mines Branch, 1907-8.
22. Iron Ore Deposits of Thunder Bay and Rainy River districts. Report on—by F. Hille, M.E.
- †23. Iron Ore Deposits along the Ottawa (Ottawa, Ojibwa, and Gatineau rivers). Report on—by Fritz Cirkel, M.E.
24. General Report on the Mining and Metallurgical Industries of Canada, 1907-8.
25. The Tungsten Ores of Canada. Report on—by T. L. Walker, Ph.D.
26. The Mineral Production of Canada, 1906. Annual Report on—by John McLeish, B.A.
- 26a. French Translation: The Mineral Production of Canada, 1906. Annual Report on—by John McLeish, B.A.

*A few copies of the Preliminary Report 1906, are still available.
 †Publications marked thus † are out of print.

27. The Mineral Production of Canada, 1907. Preliminary Report on—by John McLeish, B.A.
- †27a. The Mineral Production of Canada, 1908. Preliminary Report on—by John McLeish, B.A.
- †28. Summary Report of Mines Branch, 1908.
- †28a. French translation: Summary Report of Mines Branch, 1908.
29. Chrome Iron Ore Deposits of the Eastern Townships. Monograph on—by Fritz Cirkel, M.E. (Supplementary Section: Experiments with Chromite at McGill University—by J. B. Porter, E.M., D.Sc.
30. Investigation of the Peat Bogs and Peat Fuel Industry of Canada, 1908. Bulletin No. 1—by Erik Nystrom, M.E., and A. Anrep, Peat Expert.
32. Investigation of Electric Shaft Furnace, Sweden. Report on—by Eugene Haanel, Ph.D.
47. Iron Ore Deposits of Vancouver and Texada Islands. Report on—by Einar Lindeman, M.E.
- †55. Report on the Bituminous, or Oil-shales of New Brunswick and Nova Scotia; also on the Oil-shale industry of Scotland—by R. W. Ells, LL.D.
56. French translation: Bituminous or Oil-shales of New Brunswick and Nova Scotia; also on the Oil-shale Industry of Scotland. Report on—by R. W. Ells, LL.D.
58. The Mineral Production of Canada, 1907 and 1908. Annual Report on—by John McLeish, B.A.

NOTE.—The following parts were separately printed and issued in advance of the Annual Report for 1907-8:—

- †31. Production of Cement in Canada, 1908.
42. Production of Iron and Steel in Canada during the Calendar Years 1907 and 1908.
43. Production of Chromite in Canada during the Calendar Years 1907 and 1908.

†Publications marked thus † are out of print.

44. Production of Asbestos in Canada during the Calendar Years 1907 and 1908.
- †45. Production of Coal, Coke, and Peat in Canada during the Calendar Years 1907 and 1908.
46. Production of Natural Gas and Petroleum in Canada during the Calendar Years 1907 and 1908.
59. Chemical Analyses of Special Economic Importance made in the Laboratories of the Department of Mines, 1906-7-8. Report on—by F. G. Wait, M.A., F.C.S. (With Appendix on the Commercial Methods and Apparatus for the Analyses of Oil Shales—by H. A. Leverin, Ch. E.)
Schedule of Charges for Chemical Analyses and Assays.
- †62. Mineral Production of Canada, 1909. Preliminary Report on—by John McLeish, B.A.
63. Summary Report of Mines Branch, 1909.
67. Iron Ore Deposits at the Bristol Mine, Pontiac county, Quebec. Bulletin No. 2—by Edgar Lindeman, M.E., and Geo. C. Mackenzie, B.Sc.
- †68. Recent Advance in the Construction of Electric Furnaces for the Production of Pig Iron, Steel, and Zinc. Bulletin No. 3—by Eugene Haanel, Ph.D.
69. Chrysotile-Asbestos: Its Occurrence, Exploitation, Milling, and Uses. Reports on—by Fritz Cirkel, M.E. (Second Edition, enlarged.)
- †71. Investigation of the Peat Bogs and Peat Industry of Canada, 1909-10; to which is appended Mr. Alf. Larson's Paper on Dr. M. Ekenberg's Wet-Carbonizing Process; from *Teknisk Tidskrift*, No. 12, December 26, 1908—translation by Mr. A. v. Anrep, Jr.; also a translation of Lieut. Ekelund's Pamphlet entitled 'A Solution of the Peat Problem', 1909, describing the Ekelund Process for the Manufacture of Peat Powder, by Harold A. Leverin, Ch. E. Bulletin No. 4—by A. v. Anrep (Second Edition, enlarged.)
81. French Translation: Chrysotile-Asbestos: Its Occurrence, Exploitation, Milling, and Uses. Report on—by Fritz Cirkel, M.E.
82. Magnetic Concentration Experiments. Bulletin No. 5—by Geo. C. Mackenzie, B.Sc.

†Publications marked thus † are out of print.

83. An investigation of the Coals of Canada with reference to their Economic Qualities as conducted at McGill University under the authority of the Dominion Government. Report on—by J. B. Porter, E. M., Ph.D., R. J. Durley, M.A., and others—
 Vol. I—Coal Washing and Coking Tests.
 Vol. II—Boiler and Gas Producer Tests.
 Vol. III—
 Appendix I
 Coal Washing Tests and Diagrams.
 Vol. IV—
 Appendix II
 Boiler Tests and Diagrams.
 Vol. V—
 Appendix III
 Producer Tests and Diagrams.
 Vol. VI—
 Appendix IV
 Coking Tests.
 Appendix V
 Chemical Tests.
- †84. Gypsum Deposits of the Maritime Provinces of Canada—including the Magdalen Islands. Report on—by W. F. Jemison, M.E. (See No. 245.)
88. The Mineral Production of Canada, 1909. Annual Report on—by John McLeish, B.A.

NOTE.—The following parts were separately printed and issued in advance of the Annual Report for 1909.

- †79. Production of Iron and Steel in Canada during the Calendar Year, 1909.
- †80. Production of Coal and Coke in Canada during the Calendar Year, 1909.
85. Production of Cement, Lime, Clay Products, Stone, and other Structural Materials during the Calendar Year, 1909.
89. Reprint of Presidential address delivered before the American Product Society at Ottawa, July 25, 1910. By Eng. [Name], Ph.D.
90. Proceedings of Conference on Explosives.
92. Investigation of the Explosives Industry in the [Name] of Canada, 1910. Report on—by Capt. Arthur Desborough (second Edition.)

†Publications marked thus † are out of print.

93. Molybdenum Ore of Canada. Report on—by Professor T. L. Walker, Ph. D.
100. The Building and Ornamental Stones of Canada. Report on—by Professor W. A. Parks, Ph. D.
- 100a. French Translation: The Building and Ornamental Stones of Canada. Report on—by W. A. Parks.
102. Mineral Production of Canada, 1910. Preliminary Report on—by John McLeish, B.A.
- †103. Summary Report of Mines Branch, 1910.
104. Catalogue of Publications of Mines Branch, from 1902 to 1911; containing Tables of Contents and list of Maps, etc.
105. Austin Brook Iron-bearing district, Report on—by E. Lindeman, M.E.
110. Western Port on of Torbrook Iron Ore Deposits, Annapolis county, N.S. Bulletin No. 7—by Howells Fréchette, M.Sc.
111. Diamond Drilling at Point Mamainse, Ont. Bulletin No. 6—by A. C. Lane, Ph.D., with Introductory by A. W. G. Wilson, Ph.D.
118. Mica: Its Occurrence, Exploitation, and Uses. Report on—by Hugh S. de Schmid, M.E.
142. Summary Report of Mines Branch, 1911.
143. The Mineral Production of Canada, 1910. Annual Report on—by John McLeish, B.A.

NOTE.—The following parts were separately printed and issued in advance of the Annual Report for 1910.

- †114. Production of Cement, Lime, Clay Products, Stone and other Structural Materials in Canada, 1910.
- †115. Production of Iron and Steel in Canada during the Calendar Year 1910.
- †116. Production of Coal and Coke in Canada during the Calendar Year 1910.

†Publications marked thus † are out of print.

- †117. General Summary of the Mineral Production of Canada during the Calendar Year 1910.
145. Magnetic Iron Sands of Natashkwan, Saguenay county, Que. Report on—by Geo. C. Mackenzie, B.Sc.
149. French translation: Magnetic Iron Sands of Natashkwan, Saguenay county, Que. Report on—by Geo. C. Mackenzie, B.Sc.
- †150. The Mineral Production of Canada, 1911. Preliminary Report on—by J. J. McCreish, B.A.
151. Investigation of the Peat Bogs and Peat Industry of Canada, 1910-1911. Bulletin No. 8—by A. v. Anrep, Peat Expert.
154. The Utilization of Peat Fuel for the Production of Power, being a record of experiments conducted at the Fuel Testing Station, Ottawa, 1910-11. Report on—by B. E. Haanel, B.Sc.
155. French translation: The Utilization of Peat Fuel for the Production of Power, being a record of experiments conducted at the Fuel Testing Station, Ottawa, 1910-11. Report on—by B. E. Haanel, B.Sc.
156. French translation: The Tungsten Ores of Canada. Report on—by T. L. Walker, Ph.D.
167. Pyrites in Canada: Its Occurrence, Exploitation, Dressing, and Uses. Report on—by A. W. G. Wilson, Ph.D.
169. French translation: Pyrites in Canada: Its Occurrence, Exploitation, Dressing, and Uses. Report on—by A. W. G. Wilson, Ph.D.
170. The Nickel Industry: with Special Reference to the Sudbury region, Ont. Report on—by Professor A. P. Coleman, Ph.D.
180. French translation: Investigation of the Peat Bogs, and Peat Industry of Canada, 1910-11. Bulletin No. 8—by A. v. Anrep, Peat Expert.
184. Magnetite Occurrences along the Central Ontario Railway. Report on—by E. Lindeman.
195. French translation: Magnetite Occurrences along the Central Ontario Railway. Report on—by E. Lindeman, M.E.

†Publications marked thus † are out of print.

196. French translation: Investigation of the Peat Bogs and Peat Industry of Canada, 1909-10; to which is appended Mr. Alf. Larson's paper on Dr. Ekenburg's Wet Carbonizing Process: from *Teknisk Tidskrift*, No. 12, December 26, 1908—translation by Mr. A. v. Anrep; also translation of Lieut. Ekelund's Pamphlet entitled "A solution of the Peat Problem," 1909, describing the Ekelund Process for the Manufacture of Peat Powder, by Harold A. Leverin, Ch.E. Bulletin No. 4—by A. v. Anrep, Peat Expert. (Second Edition, enlarged.)
197. French translation: Molybdenum Ores of Canada. Report on—by Professor T. L. Walker, Ph.D.
198. French translation: Peat and Lignite: Their Manufacture and Uses in Europe—by Erik Nystrom, M.E., 1908.
201. The Mineral Production of Canada during the Calendar Year 1911. Annual Report on—by John McLeish, B.A.

NOTE.—The following parts were separately printed and issued in advance of the Annual Report for 1911.

181. Production of Cement, Lime, Clay Products, Stone, and other Structural Materials in Canada during the Calendar Year 1911. Bulletin on—by John McLeish, B.A.
- †182. Production of Iron and Steel in Canada during the Calendar Year 1911. Bulletin on—by John McLeish, B.A.
183. General Summary of the Mineral Production in Canada during the Calendar Year 1911. Bulletin on—by John McLeish, B.A.
- †199. Production of Copper, Gold, Lead, Nickel, Silver, Zinc, and other Metals of Canada, during the Calendar Year 1911. Bulletin on—by C. T. Cartwright, B.Sc.
- †200. The Production of Coal and Coke in Canada during the Calendar Year 1911. Bulletin on—by John McLeish, B.A.
202. French translation: Graphite: Its Properties, Occurrence, Refining, and Uses—by Fritz Cirkel, M.E., 1907.
203. Building Stones of Canada—Vol. II: Building and Ornamental Stones of the Maritime Provinces. Report on—by Professor W. A. Parks, Ph.D.
205. The Copper Smelting Industry of Canada. Report on—by A. W. G. Wilson, Ph.D.

†Publications marked thus † are out of print.

216. Mineral Production of Canada, 1912. Preliminary Report on—by John McLeish, B.A.
219. French translation: Austin Brook Iron-bearing district. Report on—by E. Lindeman, M.E.
222. Lode Mining in Yukon: An investigation of the Quartz Deposits of the Klondike Division. Report on—by T. A. MacLean, B.Sc.
224. Summary Report of the Mines Branch, 1912.
226. French translation: Chrome Iron Ore Deposits of the Eastern Townships. Monograph on—by Fritz Cirkel, M.E. (Supplementary Section: Experiments with Chromite at McGill University—by Professor J. B. Porter, E.M., D.Sc.)
227. Sections of the Sydney Coal Field—by J. G. S. Hudson.
- †229. Summary Report of the Petroleum and Natural Gas Resources of Canada, 1912—by F. G. Clapp, A.M. (See No. 224.)
230. Economic Minerals and the Mining Industries of Canada.
231. French translation: Economic Minerals and the Mining Industries of Canada.
233. French translation: Gypsum Deposits of the Maritime Provinces of Canada—including the Magdalen Islands. Report on—by W. F. Jennison, M.E.
245. Gypsum in Canada: Its Occurrence, Exploitation, and Technology. Report on—by L. H. Cole, B.Sc.
254. Calabogie Iron-Bearing District. Report on—by E. Lindeman, M.E.
259. Preparation of Metallic Cobalt by Reduction of the Oxide. Report on—by Professor H. T. Kalmus, B.Sc., Ph.D.
262. The Mineral Production of Canada during the Calendar Year 1912. Annual Report on—by John McLeish, B.A.

NOTE.—The following parts were separately printed and issued in advance of the Annual Report for 1912.

238. General Summary of the Mineral Production of Canada, during the Calendar Year 1912. Bulletin on—by John McLeish, B.A.

†247. Production of Iron and Steel in Canada during the Calendar Year 1912. Bulletin on—by John McLeish, B.A.

†Publications marked thus † are out of print.

- †256. Production of Copper, Gold, Lead, Nickel, Silver, Zinc, and other Metals of Canada, during the Calendar Year 1912—by C. T. Cartwright, B.Sc.
257. Production of Cement, Clay Products, stone, and other Structural Materials during the Calendar Year 1912. Report on—by John McLeish, B.A.
- †258. Production of Coal and Coke in Canada, during the Calendar Year 1912. Bulletin on—by John McLeish, B.A.
264. French translation: Mica: Its Occurrence, Exploitation, and Uses. Report on—by Hugh S. de Schmid, M.E.
265. French translation: Annual Mineral Production of Canada, 1911. Report on—by John McLeish, B.A.
283. Mineral Production of Canada, 1913. Preliminary report on—by J. McLeish, B.A.
288. French translation: Production of Coal and Coke in Canada during the Calendar Year 1912. Bulletin on—by John McLeish, B.A.
290. French translation: Production of Copper, Gold, Lead, Nickel, Silver, Zinc, and Other Metals of Canada, during the Calendar Year 1912. Bulletin on—by C. T. Cartwright, B.Sc.
299. Peat, Lignite, and Coal: Their Value as Fuels for the Production of Gas and Power in the By-product Recovery Producer. Report on—by B. F. Haanel, B.Sc.
303. Moose Mountain Iron-Bearing District. Report on—by E. Lindeman, M.E.
309. The Physical Properties of the Metal Cobalt, Part II. Report on—by H. T. Kalmus, B.Sc., Ph.D.
316. The Production of Coal and Coke during the Calendar Year 1913. Bulletin on—by John McLeish, B.A.

NOTE.—The Division of Mineral Resources and Statistics has prepared the following lists of mine, smelter, and quarry operators: Metal mines and smelters, Coal mines, Stone quarry operators, Manufacturers of clay products and Manufacturers of lime; copies of the lists may be obtained on application.

IN THE PRESS.

179. French translation: The Nickel Industry: with Special Reference to the Sudbury region. Report on—by Prof. A. P. Coleman, Ph.D.

†Publications marked thus † are out of print.

204. French translation: Building Stones of Canada—Vol. II: Building and Ornamental Stones of the Maritime Provinces. Report on—by W. A. Parks, Ph.D.
263. French translation: Recent Advances in the Construction of Electric Furnaces for the Production of Pig Iron, Steel, and Zinc. Bulletin No. 3—by Eugene Haanel, Ph.D.
266. Investigation of the Peat Bogs and Peat Industry of Canada, 1911 and 1912. Bulletin No. 9—by A. v. Anrep, Peat Expert.
279. Building and Ornamental Stones of Canada—Vol. III. Report on—by Professor W. A. Parks, Ph.D.
281. The Bituminous Sands of Northern Alberta. Report on—by S. C. Ellis, M.E.
285. Summary Report of Mines Branch, 1913.
287. French translation: Production of Iron and Steel in Canada during the Calendar Year 1912. Bulletin on—by John McLeish, B.A.
289. French translation: Production of Cement, Lime, Clay Products, Stone, and Other Structural Materials during the Calendar Year 1912. Bulletin on—by John McLeish, B.A.
291. Petroleum and Natural Gas Resources of Canada. Report on—by F. G. Clapp, A.M., and others.
305. Non-metallic minerals used in the Canadian Manufacturing Industries. Report on—by H. Frechette, M.Sc.
308. French translation: An investigation of the Coals of Canada with reference to their Economic Qualities; as conducted at McGill University under the authority of the Dominion Government. Report on—by J. B. Porter, E.M., D.Sc., R. J. Durley, M.A.E., and others:
 Vol. I—Coal Washing and Coking Tests.
 Vol. II—Boiler and Gas Producer Tests.
 Vol. III—
 Appendix I
 Coal Washing Tests and Diagrams.
 Vol. IV—
 Appendix II
 Boiler Tests and Diagrams.
314. French translation: Iron Ore Deposits, Bristol Mine, Pontiac county, Quebec. Report on—by E. Lindeman, M.E.

315. The Production of Iron and Steel during the Calendar Year 1913. Bulletin on—by John McLeish, B.A.
317. The Production of Copper, Gold, Lead, Nickel, Silver, Zinc, and other Metals, during the Calendar Year 1913. Bulletin on—by C. T. Cartwright, B.Sc.
318. The Production of Cement, Lime, Clay Products, Stone, and other Structural Materials in Canada, during the Calendar Year, 1913. By J. McLeish, B.A.
319. A General Summary of the Mineral Production in Canada during the Calendar Year 1913. Bulletin on—by J. McLeish, B.A.
320. The Mineral Production of Canada, 1913. Annual Report on—by John McLeish, B.A.
322. Economic Minerals and Mining Industries of Canada. (Revised Edition, for Panama-Pacific Exposition.)

MAPS.

- ‡6. Magnetometric Survey, Vertical Intensity: Calabogie Mine, Bagot township, Renfrew county, Ontario—by E. Nystrom, 1904. Scale 60 feet to 1 inch. Summary report, 1905. (See Map No. 249.)
- ‡13. Magnetometric Survey of the Belmont Iron Mines, Belmont township, Peterborough county, Ontario—by B. F. Haanel, 1905. Scale 60 feet to 1 inch. Summary report, 1905. (See Map. No. 186).
- ‡14. Magnetometric Survey of the Wilbur Mine, Lavant township, Lanark county, Ontario—by B. F. Haanel, 1905. Scale 60 feet to 1 inch. Summary report, 1905.
- ‡33. Magnetometric Survey, Vertical Intensity: Lot 1, Concession VI, Mayo township, Hastings county, Ontario—by Howells Fréchette, 1909. Scale 60 feet to 1 inch.
- ‡34. Magnetometric Survey, Vertical Intensity: Lots 2 and 3, Concession VI, Mayo township, Hastings county, Ontario—by Howells Fréchette, 1909. Scale 60 feet to 1 inch.

NOTE.—1. Maps marked thus * are to be found only in reports.

2. Maps marked thus † have been printed independently of reports, hence can be procured separately by applicants.

- †35. Magnetometric Survey Vertical Intensity: Lots 10, 11, and 12, Concession IX, and Lots 11 and 12, Concession VIII, Mayo township, Hastings county, Ontario—by Howells Fréchette, 1909. Scale 60 feet to 1 inch.
- *36. Survey of Mer Bleue Peat Bog, Gloucester township, Carleton county, and Cumberland township, Russell county, Ontario—by Erik Nystrom, and A. v. Anrep. (Accompanying report No. 30.)
- *37. Survey of Alfred Peat Bog, Alfred and Caledonia townships, Prescott county, Ontario—by Erik Nystrom, and A. v. Anrep. (Accompanying report No. 30.)
- *38. Survey of Welland Peat Bog, Wainfleet and Humberstone townships, Welland county, Ontario—by Erik Nystrom and A. v. Anrep. (Accompanying report No. 30.)
- *39. Survey of Newington Peat Bog, Osnabruck, Roxborough, and Cornwall townships, Stormont county, Ontario—by Erik Nystrom and A. v. Anrep. (Accompanying report No. 30.)
- *40. Survey of Perth Peat Bog, Drummond township, Lanark county, Ontario—by Erik Nystrom and A. v. Anrep. (Accompanying report No. 30.)
- *41. Survey of Victoria Road Peat Bog, Bexley and Carden townships, Victoria county, Ontario—by Erik Nystrom and A. v. Anrep. (Accompanying report No. 30.)
- *48. Magnetometric Survey of Iron Crown claim at Nimpkish (Klanich) river, Vancouver island, B.C.—by E. Lindeman. Scale 60 feet to 1 inch. (Accompanying report No. 47.)
- *49. Magnetometric Survey of Western Steel Iron claim, at Sechart, Vancouver Island, B.C.—by E. Lindeman. Scale 60 feet to 1 inch. (Accompanying report No. 47.)
- *53. Iron Ore Occurrences, Ottawa and Pontiac counties, Quebec, 1908—by J. White and Fritz Cirkel. (Accompanying report No. 23.)
- *54. Iron Ore Occurrences, Argenteuil county, Quebec, 1908—by Fritz Cirkel. (Accompanying report No. 23.) Out of print.
- *57. The Inductive Chrome Iron Ore District of Quebec—by Fritz Cirkel. (Accompanying report No. 29.)

NOTE.—1. Maps marked thus * are to be found only in reports.

2. Maps marked thus † have been printed independently of reports, hence can be procured separately by applicants.

- †60. Magnetometric Survey of the Bristol Mine, Pontiac county, Quebec—by E. Lindeman. Scale 200 feet to 1 inch. (Accompanying report No. 67.)
- †61. Topographical Map of Bristol Mine, Pontiac county, Quebec—by E. Lindeman. Scale 200 feet to 1 inch. (Accompanying report No. 67.)
- †64. Index Map of Nova Scotia: Gypsum—by W. F. Jennison. } (Accompanying report No. 84)
- †65. Index Map of New Brunswick: Gypsum—by W. F. Jennison } (Accompanying report No. 84)
- †66. Map of Magdalen Islands: Gypsum—by W. F. Jennison. }
- †70. Magnetometric Survey of Northeast Arm Iron Range, Lake Timagami, Nipissing district, Ontario—by E. Lindeman. Scale 200 feet = 1 inch. (Accompanying report No. 63.)
- †72. Brunner Peat Bog, Ontario—by A. v. Anrep.
- †73. Komoka Peat Bog, Ontario—by A. v. Anrep. (Accompanying report No 71)
- †74. Brockville Peat Bog, Ontario—by A. v. Anrep. (Out of print.)
- †75. Rondeau Peat Bog, Ontario—by A. v. Anrep. (Out of print.)
- †76. Alfred Peat Bog, Ontario—by A. v. Anrep.
- †77. Alfred Peat Bog, Ontario: Main Ditch profile—by A. v. Anrep.
- †78. Map of Asbestos Region, Province of Quebec, 1910—by Fritz Cirkel. Scale 1 mile to 1 inch. (Accompanying report No. 69.)
- †94. Map showing Cobalt, Gowganda, Shiningtree, and Porcupine districts—by L. H. Cole. (Accompanying Summary report, 1910.)
- †95. General Map of Canada, showing Coal Fields. (Accompanying report No. 83—by Dr. J. B. Porter.)
- †96. General Map of Coal Fields of Nova Scotia and New Brunswick. (Accompanying report No. 83—by Dr. J. B. Porter.)
- †97. General Map showing Coal Fields in Alberta, Saskatchewan, and Manitoba. (Accompanying report No. 83—by Dr. J. B. Porter.)

NOTE.—1. Maps marked thus * are to be found only in reports.

2. Maps marked thus † have been printed independently of reports, hence can be procured separately by applicants.

- †98. General Map of Coal Fields in British Columbia. (Accompanying report No. 83—by Dr. J. B. Porter.)
- †99. General Map of Coal Field in Yukon Territory. (Accompanying report No. 83—by Dr. J. B. Porter.)
- †106. Geological Map of Austin Brook Iron Bearing district, Bathurst township, Gloucester county, N.B. —by E. Lindeman. Scale 400 feet to 1 inch. (Accompanying report No. 105.)
- †107. Magnetometric Survey, Vertical Intensity: Austin Brook Iron Bearing District—by E. Lindeman. Scale 400 feet to 1 inch. (Accompanying report No. 105.)
- †108. Index Map showing Iron Bearing Area at Austin Brook—by E. Lindeman. (Accompanying report No. 105.)
- *112. Sketch plan showing Geology of Point Mainaise, Que. —by Professor A. C. Laue. Scale, 4,000 feet to 1 inch. (Accompanying report No. 111.)
- †113. Holland Peat Bog, Ontario—by A. v. Aurep. (Accompanying report No. 151.)
- *119-137. Mica: Township maps, Ontario and Quebec—by Hugh S. de Schmid. (Accompanying report No. 118.)
- †138. Mica: Showing Location of Principal Mines and Occurrences in the Quebec Mica Area—by Hugh S. de Schmid. Scale 3.95 miles to 1 inch. (Accompanying report No. 118.)
- †139. Mica: Showing Location of Principal Mines and Occurrences in the Ontario Mica Area—by Hugh S. de Schmid. Scale 3.95 miles to 1 inch. (Accompanying report No. 118.)
- †140. Mica: Showing Distribution of the Principal Mica Occurrences in the Dominion of Canada—by Hugh S. de Schmid. Scale 3.95 miles to 1 inch. (Accompanying report No. 118.)
- †141. Carbrook Iron Bearing District, Annapolis county, N.S. —by Howells Fréchette. Scale 400 feet to 1 inch. (Accompanying report No. 110.)
- †146. Distribution of Iron Ore Sands of the Iron Ore Deposits on the North Shore of the River and Gulf of St. Lawrence, Canada—by Geo. C. Mackenzie. Scale 100 miles to 1 inch. (Accompanying report No. 145.)

NOTE.—1. Maps marked thus * are to be found only in reports.
 2. Maps marked thus † have been printed independently of reports, hence can be procured separately by applicants.

- †147. Magnetic Iron Sand Deposits in relation to Natashkwan harbour and Great Natashkwan river, Que. (Index Map)—by Geo. C. Mackenzie. Scale 40 chains to 1 inch. (Accompanying report No. 145.)
- †148. Natashkwan Magnetic Iron Sand Deposits, Saguenay county, Que.—by Geo. C. Mackenzie. Scale 1,000 feet to 1 inch. (Accompanying report No. 145.)
- †152. Map showing the Location of Peat Bogs investigated in Ontario—by A. v. Anrep.
- †153. Map Showing the Location of Peat Bogs investigated in Manitoba—by A. v. Anrep.
- †157. Lac du Bonnet Peat Bog, Manitoba—by A. v. Anrep.
- †158. Transmission Peat Bog, Manitoba—by A. v. Anrep.
- †159. Corduroy Peat Bog, Manitoba—by A. v. Anrep.
- †160. Bogy Creek Peat Bog, Manitoba—by A. v. Anrep.
- †161. Rice Lake Peat Bog, Manitoba—by A. v. Anrep.
- †162. Mud Lake Peat Bog, Manitoba—by A. v. Anrep.
- †163. Litter Peat Bog, Manitoba—by A. v. Anrep.
- †164. Julius Peat Litter Bog, Manitoba—by A. v. Anrep.
- †165. Fort Francis Peat Bog, Ontario—by A. v. Anrep.
- *166. Magnetometric Map of Mine No. 3, Lot 7, Concessions V and VI, McKim township, Sudbury district, Ont.—by E. Lindeman. (Accompanying Summary Report, 1911.)
- †168. Map showing Pyrites Mines and Prospects in Eastern Canada, and their relation to the United States Market—by A. W. G. Wilson. Scale 125 miles to 1 in. (Accompanying report No. 167.)
- †171. Geological Map of Sudbury Nickel region, Ont.—by Prof. A. P. Coleman. Scale 1 mile to 1 inch. (Accompanying report No. 170.)

(Accompanying report No. 151)

(Accompanying report No. 151.)

NOTE.—1. Maps marked thus * are to be found only in reports.
2. Maps marked thus † have been printed independently of reports, hence can be procured separately by applicants.

- †172. Geological Map of Victoria mine—by Prof. A. P. Coleman.
- †173. Geological Map of Crean Hill mine—by Prof. A. P. Coleman. } (Accompanying report No. 170.)
- †174. Geological Map of Creighton mine—by Prof. A. P. Coleman. }
- †175. Geological Map showing contact of Norite and Laurentian in vicinity of Creighton mine—by Prof. A. P. Coleman. (Accompanying report No. 170.)
- †176. " " of Copper Cliff offset—by Prof. A. P. Coleman. (Accompanying report No. 170.)
- †177. " " No. 3 Mine—by Prof. A. P. Coleman. (Accompanying report No. 170.)
- †178. " " showing vicinity of Stobie and No. 3 mines—by Prof. A. P. Coleman. (Accompanying report No. 170.)
- †185. Magnetometric Survey, Vertical Intensity: Blairton iron mine, Belmont township, Peterborough county, Ontario—by E. Lindeman, 1911. Scale 200 feet to 1 inch. (Accompanying report No. 184.)
- †185a. Geological Map, Blairton iron mine, Belmont township, Peterborough county, Ontario—by E. Lindeman, 1911. Scale 200 feet to 1 inch. (Accompanying report No. 184.)
- †186. Magnetometric Survey, Belmont iron mine, Belmont township, Peterborough county, Ont.—by E. Lindeman, 1911. Scale 200 feet to 1 inch. (Accompanying report No. 184.)
- †186a. Geological Map, Belmont iron mine, Belmont township, Peterborough county, Ontario—by E. Lindeman, 1911. Scale 200 feet to 1 inch. (Accompanying report No. 184.)
- †187. Magnetometric Survey, Vertical Intensity: St. Charles mine, Tudor township, Hastings county, Ontario—by E. Lindeman, 1911. Scale 200 feet to 1 inch. (Accompanying report No. 184.)
- †187a. Geological Map, St. Charles mine, Tudor township, Hastings county, Ontario—by E. Lindeman, 1911. Scale 200 feet to 1 inch. (Accompanying report No. 184.)

NOTE.—1. Maps marked thus * are to be found only in reports.

2. Maps marked thus † have been printed independently of reports, hence can be procured separately by applicants.

- †188. Magnetometric Survey, Vertical Intensity: Baker mine, Tudor township, Hastings county, Ontario—by E. Lindeman, 1911. Scale 200 feet to 1 inch. (Accompanying report No. 184.)
- †188a. Geological Map, Baker mine, Tudor township, Hastings county, Ontario—by E. Lindeman, 1911. Scale 200 feet to 1 inch. (Accompanying report No. 184.)
- †189. Magnetometric Survey, Vertical Intensity: Ridge iron ore deposits, Wollaston township, Hastings county, Ontario—by E. Lindeman, 1911. Scale 200 feet to 1 inch. (Accompanying report No. 184.)
- †190. Magnetometric Survey, Vertical Intensity: Coehill and Jenkins mines, Wollaston township, Hastings county, Ontario—by E. Lindeman, 1911. Scale 200 feet to 1 inch. (Accompanying report No. 184.)
- †190a. Geological Map, Coehill and Jenkins mines, Wollaston township, Hastings county, Ontario—by E. Lindeman, 1911. Scale 200 feet to 1 inch. (Accompanying report No. 184.)
- †191. Magnetometric Survey, Vertical Intensity: Bessemer iron ore deposits, Mayo township, Hastings county, Ontario—by E. Lindeman, 1911. Scale 200 feet to 1 inch. (Accompanying report No. 184.)
- †191a. Geological Map, Bessemer iron ore deposits, Mayo township, Hastings county, Ontario—by E. Lindeman, 1911. Scale 200 feet to 1 inch. (Accompanying report No. 184.)
- †192. Magnetometric Survey, Vertical Intensity: Rankin, Childs, and Stevens mines, Mayo township, Hastings county, Ontario—by E. Lindeman, 1911. Scale 200 feet to 1 inch. (Accompanying report No. 184.)
- †192a. Geological Map, Rankin, Childs, and Stevens mines, Mayo township, Hastings county, Ontario—by E. Lindeman, 1911. Scale 200 feet to 1 inch. (Accompanying report No. 184.)
- †193. Magnetometric Survey, Vertical Intensity: Kennedy property, Carlow township, Hastings county, Ontario—by E. Lindeman, 1911. Scale 200 feet to 1 inch. (Accompanying report No. 184.)
- †193a. Geological Map, Kennedy property, Carlow township, Hastings county, Ontario—by E. Lindeman, 1911. Scale 200 feet to 1 inch. (Accompanying report No. 184.)

NOTE.—1. Maps marked thus * are to be found only in reports.

2. Maps marked thus † have been printed independently of reports, hence can be procured separately by applicants.

- †194. Magnetometric Survey, Vertical Intensity: Bow Lake iron-ore occurrences, Faraday township, Hastings county, Ontario.—by E. Lindeman, 1911. Scale 200 feet to 1 inch. (Accompanying report No. 184.)
- †204. Index Map, Magnetic occurrences along the Central Ontario Railway.—by E. Lindeman, 1911. (Accompanying report No. 184.)
- †205. Magnetometric Map, Moose Mountain iron-bearing district, Sudbury district, Ontario: Deposits Nos. 1, 2, 3, 4, 5, 6, and 7.—by E. Lindeman, 1911. (Accompanying report No. 303.)
- †205a. Geological Map, Moose Mountain iron-bearing district, Sudbury district, Ontario: Deposits Nos. 1, 2, 3, 4, 5, 6, and 7.—by E. Lindeman. (Accompanying report No. 303.)
- †206. Magnetometric Survey of Moose Mountain iron-bearing district, Sudbury district, Ontario: Northern part of Deposit No. 2.—by E. Lindeman, 1912. Scale 200 feet to 1 inch. (Accompanying report No. 303.)
- †207. Magnetometric Survey of Moose Mountain iron-bearing district, Sudbury district, Ontario: Deposits Nos. 8, 9, and 9A.—by E. Lindeman, 1912. Scale 200 feet to 1 inch. (Accompanying report No. 303.)
- †208. Magnetometric Survey of Moose Mountain iron-bearing district, Sudbury district, Ontario: Deposit No. 10.—by E. Lindeman, 1912. Scale 200 feet to 1 inch. (Accompanying report No. 303.)
- †208a. Magnetometric Survey, Moose Mountain iron-bearing district, Sudbury district, Ontario: Eastern portion of Deposit No. 11.—by E. Lindeman, 1912. Scale 200 feet to 1 inch. (Accompanying report No. 303.)
- †208b. Magnetometric Survey, Moose Mountain iron-bearing district, Sudbury district, Ontario: Western portion of Deposit No. 11.—by E. Lindeman, 1912. Scale 200 feet to 1 inch. (Accompanying report No. 303.)
- †208c. General Geological Map, Moose Mountain iron-bearing district, Sudbury district, Ontario.—by E. Lindeman, 1912. Scale, 800 feet to 1 inch. (Accompanying report No. 303.)
- †210. Location of Copper Smelters in Canada.—by A. W. G. Wilson. Scale 197.3 miles to 1 inch. (Accompanying report No. 209.)

NOTE.—1. Maps marked thus * are to be found only in reports.
 2. Maps marked thus † have been printed independently of reports, hence can be procured separately by applicants.

- †215. Province of Alberta: showing properties from which samples of coal were taken for gas producer tests, Fuel Testing Division, Ottawa. (Accompanying Summary Report 1912.)
- †220. Mining Districts, Yukon. Scale 35 miles to 1 inch—by T. A. MacLean. (Accompanying report No. 222.)
- †221. Dawson Mining District, Yukon. Scale 2 miles to 1 inch—by T. A. MacLean. (Accompanying report No. 222.)
- *228. Index Map of the Sydney Coal Field, Cape Breton, N.S. (Accompanying report No. 227.)
- †232. Mineral Map of Canada. Scale 100 miles to 1 inch. (Accompanying report No. 230.)
- †239. Index Map of Canada, showing gypsum occurrences. (Accompanying report No. 245.)
- †240. Map showing Lower Carboniferous formation in which gypsum occurs. Scale 100 miles to 1 inch. (Accompanying report No. 245.)
- †241. Map showing relation of gypsum deposits in Northern Ontario to railway lines. Scale 100 miles to 1 inch. (Accompanying report No. 245.)
- †242. Map, Grand River gypsum deposits, Ontario. Scale 4 miles to 1 inch. (Accompanying report No. 245.)
- †243. Plan of Manitoba Gypsum Co.'s properties. (Accompanying report No. 245.)
- †244. Map showing relation of gypsum deposits in British Columbia to railway lines and market. Scales 35 miles to 1 inch. (Accompanying report No. 245.)
- †249. Magnetometric Survey, Caldwell and Campbell mines, Calabogie district, Renfrew county, Ontario—by E. Lindeman, 1911. Scale 200 feet to 1 inch. (Accompanying report No. 254.)
- †250. Magnetometric Survey, Black Bay or Williams mine, Calabogie district, Renfrew county, Ontario—by E. Lindeman, 1911. Scale 200 feet to 1 inch. (Accompanying report No. 254.)

NOTE.—1. Maps marked thus * are to be found only in reports.

2. Maps marked thus † have been printed independently of reports, hence can be procured separately by applicants.

- †251. Magnetometric Survey, Bluff Point iron mine, Carleton place district, Renfrew county, Ontario—by E. Lindeman, 1911. Scale 200 feet to 1 inch. (Accompanying report No. 254.)
- †252. Magnetometric Survey, Culhane mine, Carleton place district, Renfrew county, Ontario—by E. Lindeman, 1911. Scale 200 feet to 1 inch. (Accompanying report No. 254.)
- †253. Magnetometric Survey, Martel or Wilson iron mine, Carleton place district, Renfrew county, Ontario—by E. Lindeman, 1911. Scale 200 feet to 1 inch. (Accompanying report No. 254.)
- †261. Magnetometric Survey, Northeast Arm iron range, Lot 339 E. T. W. Lake Timagami, Nipissing district, Ontario—by E. Nystrom, 1903. Scale 200 feet to 1 inch.
- †268. Map of Peat Bogs Investigated in Quebec—by A. v. Anrep, 1912.
- †269. Large Tea Field Peat Bog, Quebec " "
- †270. Small Tea Field Peat Bog, Quebec " "
- †271. Lanorie Peat Bog, Quebec " "
- †272. St. Hyacinthe Peat Bog, Quebec " "
- †273. Rivière du Loup Peat Bog " "
- †274. Cacouna Peat Bog " "
- †275. Le Parc Peat Bog, Quebec " "
- †276. St. Denis Peat Bog, Quebec " "
- †277. Rivière Ouelle Peat Bog, Quebec " "
- †278. Moose Mountain Peat Bog, Quebec " "
- †284. Map of northern portion of Alberta, showing position of outcrops of bituminous sand. Scale 12½ miles to 1 inch. (Accompanying report No. 281.)
- †293. Map of Dominion of Canada, showing the occurrences of oil, gas, and tar sands. Scale 197 miles to 1 inch. (Accompanying report No. 291.)

NOTE.—1. Maps marked thus * are to be found only in reports.

2. Maps marked thus † have been printed independently of reports, hence can be procured separately by applicants.

- †294. Reconnaissance Map of part of Albert and Westmorland counties, New Brunswick. Scale 1 mile to 1 inch. (Accompanying report No. 291.)
- †295. Sketch plan of Gaspé oil fields, Quebec, showing location of wells. Scale 2 miles to 1 inch. (Accompanying report No. 291.)
- †296. Map showing gas and oil fields and pipe-lines in Southwestern Ontario. Scale 4 miles to 1 inch. (Accompanying report No. 291.)
- †297. Geological Map of Alberta, Saskatchewan and Manitoba. Scale 35 miles to 1 inch. (Accompanying report No. 291.)
- †298. Map, Geology of the forty-ninth parallel, 0.9864 miles to 1 inch. (Accompanying report No. 291.)
- †302. Map showing location of main gas line, Bow Island-Calgary. Scale 12½ miles to 1 inch. (Accompanying report No. 291.)
- †311. Magnetometric Map, McPherson mine, Barachois, Cape Breton county, Nova Scotia. Scale 200 feet to 1 inch.
- †312. Magnetometric Map, iron ore deposits at Upper Glencoe, Inverness county, Nova Scotia. Scale 200 feet to 1 inch.
- †313. Magnetometric Map, iron ore deposits at Grand Mira, Cape Breton county, Nova Scotia. Scale 200 feet to 1 inch.

Address all communications to—

DIRECTOR MINES BRANCH,
DEPARTMENT OF MINES,
SUSSEX STREET, OTTAWA.

- NOTE.—1. Maps marked thus * are to be found only in reports.
2. Maps marked thus † have been printed independently of reports, hence can be procured separately by applicants.



