

Please read and send in as full a  
discussion as possible at earliest date.

## The Canadian Society of Civil Engineers.

INCORPORATED 1887.

**ADVANCE PROOF**—(*Subject to revision.*)

N.B.—This Society, as a body, does not hold itself responsible for the statements and opinions advanced in any of its publications.

THE LACHINE RAPIDS POWER HOUSE

OF THE

LACHINE RAPIDS HYDRAULIC & LAND COMPANY,  
LIMITED, MONTREAL.

The Original and Present Arrangement of Generators,  
Exciters and Switch-boards, Etc.

By R. S. KELSCH, M. Can. Soc. C.E.

The Power House is not only unique, but is a wonderful plant. This is said advisedly, for to the best of the writer's knowledge nothing like it exists to-day on this Continent. By this is meant a power plant of such low head and large capacity for generating electric power for central station distribution.

When the power house was projected, plans and designs gotten out for the generators, switch-boards, etc., there existed very little data regarding the operating of such a plant. Furthermore, the three phase system in this country was not very far advanced, and there was more or less uncertainty as to how the output of this plant would be disposed of.

Under these conditions considerable temporary work was done and the plant was operated under difficulties. However, after operating some time, it was self-evident that a widely different plan for

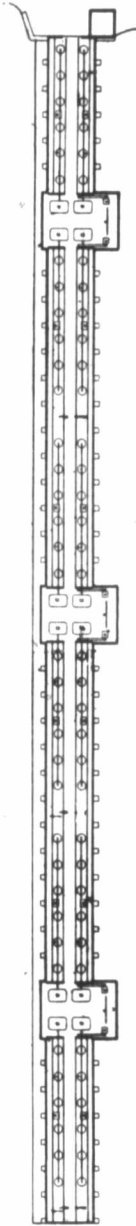

Fig. 1.

G—Generators.  
 E—Exciters.  
 R—Turbine Governors.  
 S—Switchboards.  
 T—Turbines.

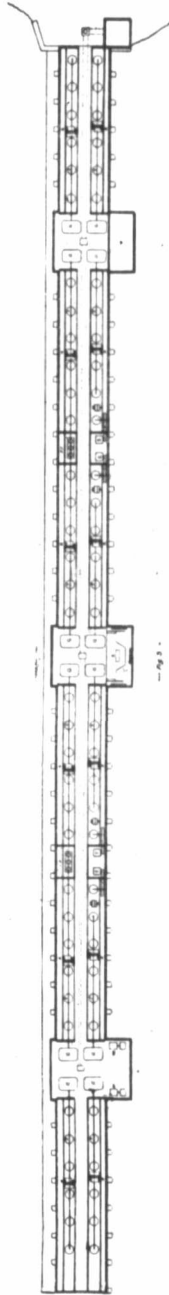

Fig. 3.

G—Generators.  
 E—Exciters.  
 R—Turbine Governors.  
 S—Switchboards.  
 T—Turbines.  
 M—Machine Shop.  
 FP—Fire Pump.  
 MG—Motor Generator

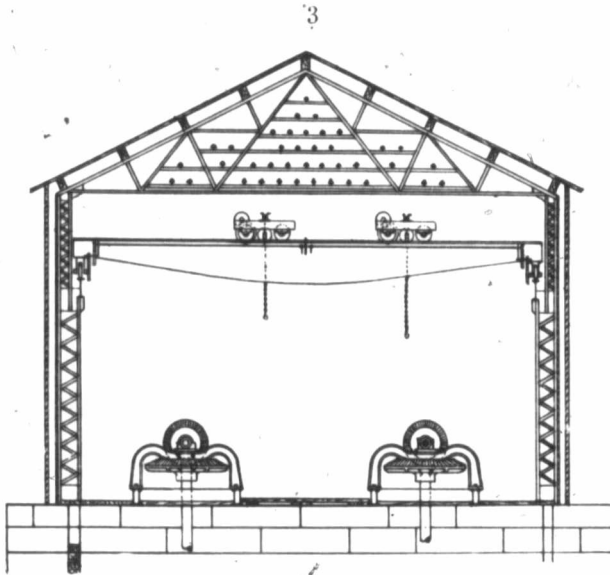

Fig. 2.

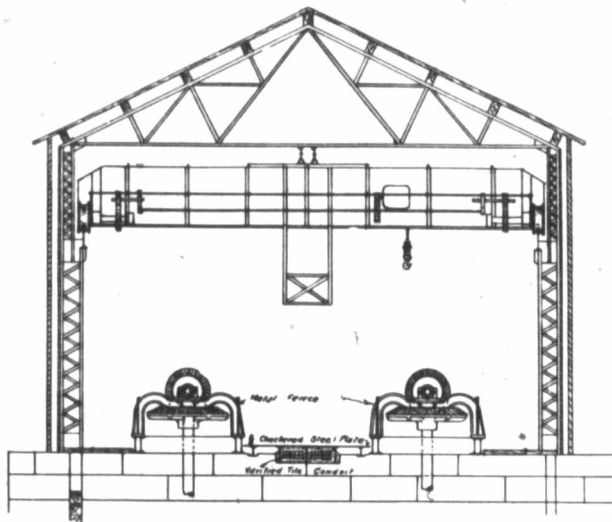

Fig. 4.

controlling the machinery and electrical apparatus must be worked out.

The original arrangement of the generators, water-wheels, switch-board, exciters, etc., is shown in Fig. 1, which is a plan representing the original arrangement of generators, water-wheels, switch-boards, etc., from which it will be seen that exciters are belted direct to the main shafts, and a switch-board for each of the four generators, located near the generators and a distance of 350 feet apart. The transmission lines enter the tower and from this point the lines connected with the generator switch-boards by passing overhead on ordinary glass insulators, supported by cross-arms fastened to the roof truss.

The disadvantages of this general lay-out were the poor regulation obtained, because of the exciters being driven direct from the main shaft, the speed of the exciters changing with changes in load, which multiplied the voltage regulation, and made it impossible to obtain good regulation.

The switch-board arrangement, consisting of a separate switch-board located with each of the four generators and marked "S" on the plan Fig. 1, could be operated only at a great disadvantage, especially during an emergency, and at a large operating expense for switch-board attendants, at all times. This plan called for three men on each shift, and three shifts would require nine switch-board attendants. It can be seen at a glance that in case of an emergency it would be impossible for the switch-board attendants to know what was best to do, as the distance between the three switch-boards was such that the three men could not communicate with each other, and a great loss of time would be experienced in the event of an emergency before the switch-board men could communicate with each other.

The position of the switch-board was such that the operator could not see the water wheel attendants, who, in starting and stopping the generators, would be stationed at water wheel governor represented by the letter "R" on the plan Fig. 1.

Owing to the considerable noise made by the gears, etc., it was found necessary to establish a means of signalling the water wheel attendants, so that the water wheels could be regulated and this frequently required a lapse of time, amounting to twenty minutes. In connection with Fig. 1, we will refer to a section view of the power house, Fig. 2, as originally laid out, showing the wires connecting the generators with the transmission line, to be located up in the roof trusses, a wooden floor throughout the entire power house, and a twelve ton hand crane for handling the machinery. Considerable difficulty was experienced in operating the plant so as

to  
cha  
3, v  
diff  
mal  
sim  
scri  
?  
swit  
loca  
beir  
cha:  
exci  
(  
lon  
a w  
com  
geth  
of f  
nun  
hose  
pick  
I  
floor  
han  
elec  
by  
loca  
the  
perr  
the  
clos  
hou  
any  
grea  
?  
twec  
I  
one  
as s  
gall  
ing  
I  
pow  
nois



to give good service with the above arrangement and several changes were made which will be described, and by referring to Fig. 3, we see that water wheel regulator "R" has been changed and a different type installed,—the new governors are of the Lombard make. These governors are controlled from the switch-board by a simple device, which will be described later on in the details describing the main switch-board.

The exciters marked "E" and located alongside of the original switch-boards in the dynamo rooms, Fig. 1, have been removed and located midway between the three generator rooms, each exciter being driven by an independent water wheel, so that any speed change of the main shaft due to change of load, does not affect the exciter regulation.

Opposite the exciters, there have been installed, two 1,000,000 gallon fire pumps marked F. P. Fig. 3. These pumps are connected to a water main system with hydrants located 200 feet apart, and a complete equipment, consisting of fire axes, saws and hooks, together with 1000 feet of standard 2½" fire hose for use in the event of fire. Owing to the great length of the building and the small number of attendants on duty at a time, the various stretches of hose are laid out straight on shelves so that it is only necessary to pick up the nozzle and turn on the water.

By referring to the section view, Fig. 4, we see that the wooden floor has been removed, likewise the overhead wires and the old hand crane. The crane has been replaced by a modern three motor electric travelling crane and the overhead wires have been replaced by lead covered cables placed in vitrified tile conduits, which are located below the new steel plate floor. The floor directly under the main shafts has been removed, leaving the flumes open, which permits ready inspection, facilitates making of repairs, and removes the possibility of the floor catching fire from hot bearings, etc. A closed iron fence has been built the entire length of the power house, as shown, which serves the double purpose of preventing any one from falling into the open flumes and also prevents oil and grease from being thrown from the crown gears out on to the floor.

The conduit system is composed of vitrified clay pipe, laid in between the beams which support the 3-8" checkered steel plate floor.

Instead of the three separate switch-boards as shown on Fig. 1, one main switch-board has been built in the centre dynamo room, as shown on Fig. 3, and from the operator's position on the top gallery, a good view is obtained of the entire power house, including the generators, water wheel governors, exciters, etc.

It is almost impossible to describe the difficulty in operating the power house 1000 feet long, and only 50 feet wide. The rumbling noise made by the gears and pinions was such that it was impos-

sible to telephone from one station to another and impossible for the employees to talk to each other, unless they were standing side by side or by using a megaphone. This made it necessary for a system of signals and a flag was used in the day time, and a lantern at night. With the new switch-board, however, this crude method has disappeared entirely, as the switchboard attendant has complete control over everything, and the water wheel attendants merely look after the oiling of the bearings, cleaning, etc. Some idea may be gained of the difficulty experienced in operating such a plant when the number of bearings with each unit is considered. Each complete generator unit, exclusive of the water wheel governor and exciter, has 40 bearings, or a total of 508 bearings for the twelve units, including the exciters and not including the water wheel governors.

#### ELECTRICAL EQUIPMENT.

##### GENERATORS AND EXCITERS.

We have seen from the above, that the Power House consists of turbine sheds and generator rooms. The Power House is 1000 feet long and 50 feet wide. The generator rooms are about 300 feet apart and in each of the generator rooms there are four generators. They are the well-known type of revolving field machine, made by the General Electric Company, and are of 750 k.w. capacity each, having 40 poles and a speed of 180 r.p.m., the frequency being 60 cycles and the voltage 5000 v. In each of the exciter rooms there are two compound-wound 75 k. w. exciters, furnished by the General Electric Co. They are 4-pole and run at 660 r.p.m. These exciters are built to operate between 90 and 175 v. The voltage varies considerably, depending not only on the load, but also on the head of water, which changes with the different seasons of the year. It was found necessary to use several small exciters instead of two of larger capacities, on account of the low head during winter months, and the capacity of each wheel being limited.

The generators are constructed so that the fields are about three quarters saturated under normal conditions, so that in the event of low water in the winter time, the full voltage of the generators could be maintained when the head of water is reduced so that the speed of the generators is 10% below normal. In addition to these four exciters, there will be installed in the south dynamo room in the space originally occupied by the first temporary switch-board, two 75 k.w. direct current generators, direct connected to three phase motors which will supply the current for the electric traveling crane, electric heaters, and the station lighting. The method of operating, together with the details of the switch-board, diagrams,

etc.  
into  
boa  
atic  
in  
feet  
of  
gov  
boa  
the  
f  
f  
twe  
to  
feed  
tica  
pos  
bus  
ope  
I  
it w  
set  
of g  
bars  
swit  
E  
boar  
arra  
as o  
I  
be q  
arra  
days  
thro  
nece  
O  
tran  
twel  
tran

etc., present on account of their novelty, many points of unusual interest to every Engineer interested in Central Station work.

The main objects aimed and arrived at in the design of this board were, first, highest degree of safety and best results of operation.

Second, flexibility combined with the greatest simplicity possible in a plant spread out over a distance of 1000 feet in length by 50 feet in width.

Third, the impossibility of any but a wilful mistake on the part of the operator.

Fourth, the control of the entire system, including the turbine governors, to be such as to require only one operator on the switch-board.

Fifth, dividing the switch-board into symmetrical sections and the highest grade of work.

Sixth, fireproofing and insulating of all conductors, etc.

Sixteen feeder circuits are provided for and as has been shown, twelve generators. It was considered advisable and an advantage to separate them into four sections, each set of three generators feeding four feeders. The arrangement is such that there are practically four different power houses, each set or power house being possible of entirely separate operation. Or to work in multiple, the bus bars being tied together or separated by means of electrically operated tying oil switches.

Referring to the general diagram of connections, Figs. 5 and 5A, it will be noticed that for each set of three generators and for each set of four feeders, there is a separate set of bus bars. Each set of generator bus bars is tied to the corresponding set of feeder bus bars, by means of cables, forming one complete section, the tying switches being tapped off these cables and not off the bus bars.

Both the generator and feeder bus bars form separate switch-board and are entirely independent and away from each other. This arrangement permits the entire system to be tied together and run as one system, or it may be run as separate systems.

In the event of an accident to any portion of the system, it can be quickly separated from the rest until repairs are completed. The arrangement is such that during light load on Sundays and holidays, nights, etc., any portion of the plant can be made dead throughout, permitting any repairs, cleaning, etc., that may be necessary, without the slightest chance of injuring an employee.

Of the four feeder switches on each section only three are for transmission lines to the substations in the city, there being thus twelve lines altogether. The fourth switches are for reserve and for transmission of power to the surrounding neighborhood, etc.



FIG. 5.

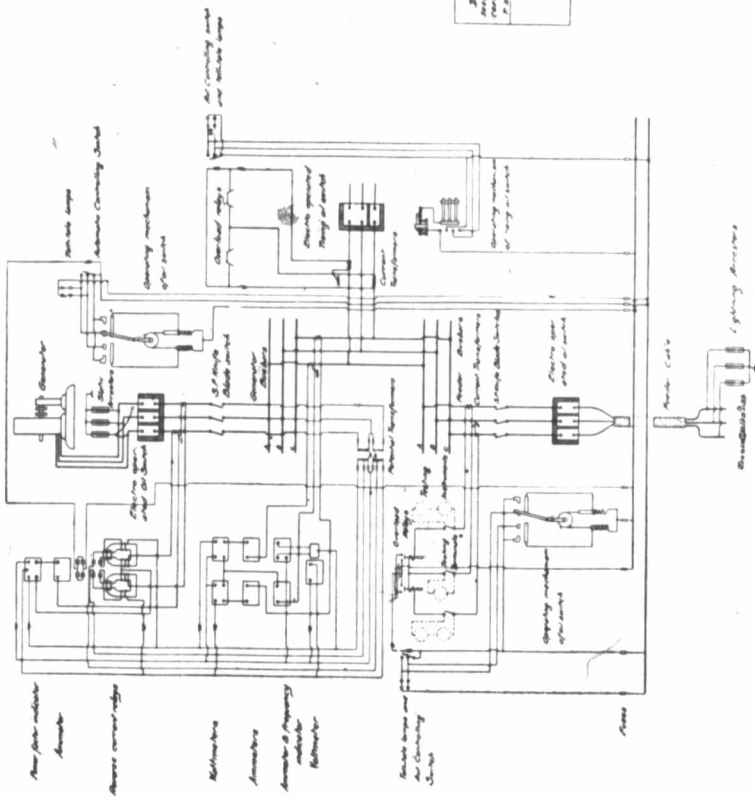

DESIGN IN CONNECTION WITH  
 THE PATENT OF THE UNITED STATES  
 OFFICE OF THE PATENT OFFICE  
 WASHINGTON, D. C. 20540  
 B  
 111

FIG. 5a.

At first it might be thought that if the feeder and generator bus bars were identical and the feeders tapped off at the point where the generators tap into the bus bars, a good deal of copper and material might be saved. Also if there were two sets of bus bars on the same panel a great deal of space might be saved. The first has the disadvantage that it is impossible to connect in the total output, instruments which for obvious reasons are absolutely essential for a plant of this size. The second, as well as the first, evidently puts an entire section out of operation and in case of anything happening to that panel which would disable it.

In the plan as laid out, if there should be a compulsory shut down of one of the feeder bus bar panels, by disconnecting the cables from the latter, the generators on that section can still be utilized. On the other hand, if a generator bus bar panel be put out of service, the feeders on that section can be fed from the other generators. In the circuits of the tying switches, are current transformers which operate overload relays. The latter are adjusted to operate only in case of an unusual and very heavy current such as can be obtained only by a dead short circuit on the bus bars. In such a case, the tying switches will automatically cut off the faulty section from the rest and prevent a complete shut down of the plant. It is to be noted, however, that this is intended as an additional safeguard in connecting the cables and bus bars, the cables and bus bars having been designed so that a short circuit on them is almost impossible.

Another matter which received consideration, was its flexibility. The advantage of the plan adopted to the other plan of having, as is usually done, two sets of bus bars with D. T. switches for each generator and feeder. It was found, however, that the latter method, while having greater flexibility, added a great deal of complications, especially so with the type of switches adopted and on account of the limited space at the disposal of the Company in which to construct this switch-board, and made mistakes on the part of the operator possible.

The plan adopted has sufficient flexibility with almost all the inherent properties of two sets of bus bars and its great simplicity makes it very easy for the switch-board attendant to successfully operate the plant.

For the four exciters, there are two sets of bus bars, each exciter has a D. T. four pole switch, besides the other switching apparatus on the exciter panels, as will be described later. It may happen that one of the exciters will become disabled, and in such case one of the motor driven D. C. Generators installed in the south dynamo room, will take its place, utilizing the same exciter panel. This is clearly

shown in the general diagram of connections. The D. C. Generator No. 5 can take the place of either No. 1 or No. 2 exciter and the other D. C. Generator No. 6, that of No. 3 or No. 4 exciter. The diagram shows the two four pole D. T. switches to throw the D. C. Generator on to either exciter panel. These two switches are close together and designed such that it is impossible to throw the generator on both exciter panels simultaneously. The fields of the A. C. Generators are also provided with D. T. switches to throw the field on either side of bus bars.

Considerable difficulty was experienced in reaching a decision on the plans for a central switchboard, owing to the space being limited to that which was intended for the original small switch-board to control four generators as was shown in Fig. 1.

Switch-board, switches, etc., are distributed on four floors in the middle dynamo room and consist of the basement floor, main floor and two specially constructed switch-board galleries. The main floor is composed of 12" I beams and terra cotta tiles, on which is laid 1" Tennessee marble in pieces 12 x 12" square. The first gallery consists of 10 I beams, placed three feet ten inches apart with expanded metal and concrete floor having a smooth cement finish. The same construction is employed for the basement floor. The second gallery is supported by 8" I beams placed 18" apart, upon which is a 1½" Vermont slate floor, the slabs being 18" x 36".

To each floor, two circular stair cases are provided, one for ascending and one for descending. The hand rails are made and supported by heavy cast iron posts; 2" wrought iron pipe is used for hand rails, and ¾" square wrought iron twisted bars for the balusters.

#### THE CABLE SUBWAY.

As has been stated, the power house is 1,000 feet long and to provide means of conducting the cables through the power house to connect with the transmission line, a fire-proof subway is run through the entire length of the power house with manholes in each of the dynamo rooms, and one outside of the power house entrance, where the subway enters the tower, as shown in Fig. 6. This subway consists of vitrified conduits laid in concrete, and the whole resting on ¾" steel plates, supported on the bottom flanges of the 16" and 18" I beams, placed 2 feet 4 inches apart. These I beams span the stone piers which are 21' 6" centres, and on top of these beams a ¾" checkered steel plate floor is laid, which is fastened down with ½" flat head machine screws and these form a steel plate floor clear through the centre of the power house, the width of the passage way being 10' 6".

In order to preclude any possibility of moisture entering the

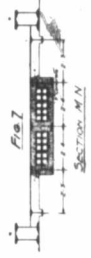
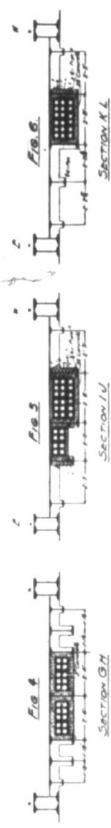
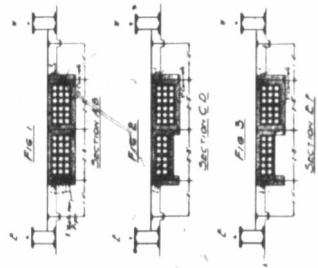
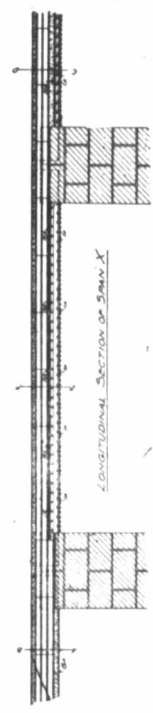
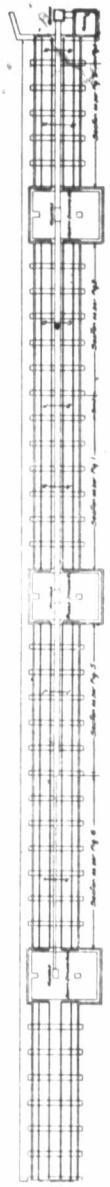

1917. The ship shown in this drawing is the *USS Albatross*, U.S.N. No. 101.  
 The hull is of steel, and the deck is of teak.  
 The hull is shown in the position of being under way.  
 The hull is shown in the position of being under way.  
 The hull is shown in the position of being under way.

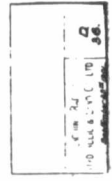

Fig. 6.



ducts from below, which are exposed to the spray of the water, the interior of the beams and plates was given a heavy coating of plastic asphalt on which was laid a heavy lining of burlap saturated with plastic asphalt, then another coating of the latter. The conduit system is partly in the water sixty days during the year, but so far no moisture has entered the ducts.

The total weight of the I beams and plates used for this subway and floor is 180 tons.

#### THE MAIN CABLES.

The generator and feeder high tension cables are constructed for 10,000 volt working pressure. They are three conductor No. O. B. & S. cable, each conductor has 7-32" paper insulation, so that there is 7-16" insulation between the conductors, and the whole covered with a lead sheeting  $\frac{1}{8}$ " thick. These cables run through the conduits to the middle dynamo room manhole, then along the basement corridor walls to the cable head cells. The cable rests here on Keystone cable hangers, supported by 3" channels placed two feet six inches apart. Wherever the cables are exposed outside of the conduits, they are covered with three layers of asbestos tape, each layer being 3-16" thick, and the whole fastened on with brass straps. The cable heads are all mounted in brick cells and consist of brass bushings soldered to the cable and the flared or bell shaped cast brass cable heads are then screwed on to the bushings and the whole filled with No. 66 Edison compound. The feeder cables which run into the tower, have at the latter place, a similar cable head and brick cell construction.

The exciter generator field and signal cables also run to the middle dynamo room through the conduit system thence along the ceiling below the basement and then up the walls to the second switch-board gallery on to the main switch-board. It will be seen that by putting all of the high tension cables in the basement and the D.C. cables in the sub-basement, they are entirely separated from each other. The exciter cables are 600,000 c.m. single conductor. The cables for the generator field are two conductor No. O. B. & S. and the signal cables are multiple conductor No. 14 B. & S. They are all paper insulated and lead covered, made to successfully withstand a break down test pressure of 1500 volts a.c. for one minute.

#### THE GENERAL ARRANGEMENT OF THE SWITCH-BOARD, SWITCHES, ETC.

The basement is used principally for the cable heads, static arresters and the potential transformers. These are all placed in buff brick cells with soapstone and brick barriers as shown on the

section view Figs. 7 and 7A. From the generator cable heads, single lead covered conductors run up to the oil switches on the main floor; from these switches, lead covered leads run up to the bus bars on the first gallery, passing through the current transformers on the back of the bus bar panels.

The tying cables which pass through the totality instruments current transformers connect the generator bus bars to the feeder bus bars on the same floor.

The feeder cables connect to the bus bar panels in the same way. There are on the main floor, twenty-eight electrically operated oil switches grouped together in threes for the generator and in fours for the feeders, (Fig. 8) placed back to back corresponding with the groups and sections as shown on the general diagram of connections.

The cable heads in the basement and the bus bar panels on the first gallery, are similarly grouped. This method of grouping has been extended even to the switch-board panels. It will be seen later that there is one panel for each set of three generators on the main switch-board and on the operating table. There is also one panel for each set of four feeders on the bench boards. This method of division not only makes the whole symmetrical but obviously is also a great help to the attendant, for each panel represents a set of bus bars in the same way as the panels are placed.

Going back to the switches on the main floor, it will be seen on the plan view Fig. 8, that each block of three switches for the generators has two corner cells in each of which is placed a 500 watt potential transformer with its primary and secondary fuses. These transformers are for operating the instruments of that section and are connected to the 5000 volt bus bars.

On the first gallery, as shown on Fig. 9, are located the bus bar panels and also the electrically operated tying switches for the bus bars. These will be described in detail later on. On the second gallery is concentrated the control of the entire power house. On this floor (Fig. 9) is located the instrument panels and the operating table. Also on the right and left hand are the two feeder bench-boards and adjoining these are D. C. distributing switch-boards for supplying power to all of the auxiliaries.

It will be seen from the plan view, that the switch-board panels are laid out so that the instruments on same are all an equal distance from the operating table.

On this gallery where the operator is stationed, there will be absolutely no high tension wiring or apparatus of any description.



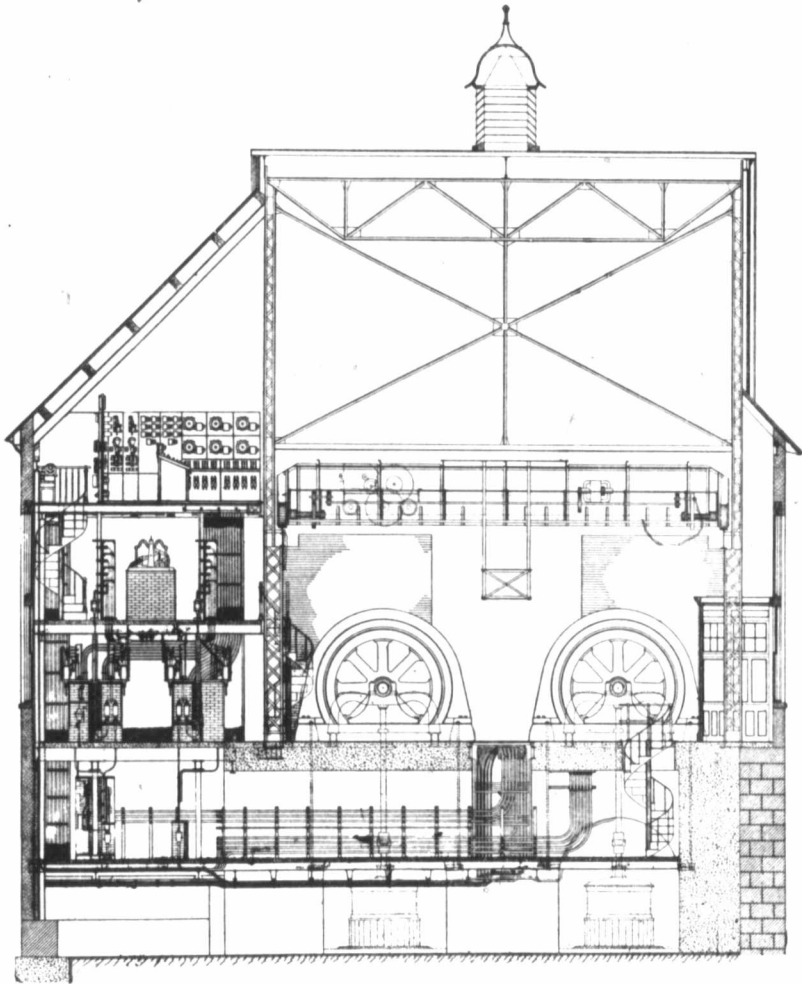
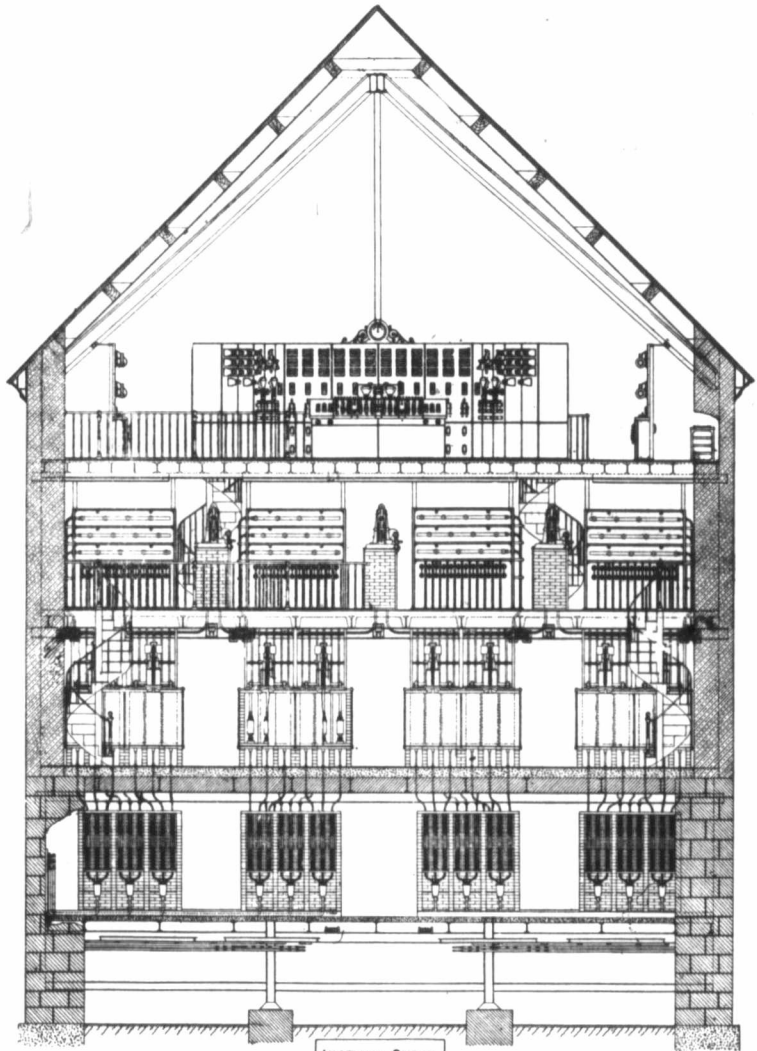

Fig. 7.



LONGITUDINAL SECTION  
GENERAL ASSEMBLY  
From West Direction

AS Kild	E
	4

Fig. 7a.

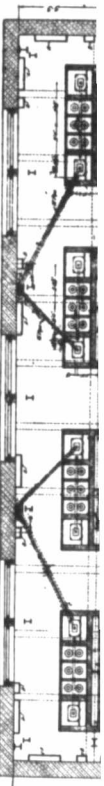

Made by the Bureau of Architecture and  
 Plans of the U.S. Army and Navy  
 CIVIL ENGINEER, U.S. ARMY  
 FOR ARCHITECTS AND ENGINEERS  
 OFFICE, WASHINGTON, D. C.

Fig 8

Main Floor Sheet No.	
D	44

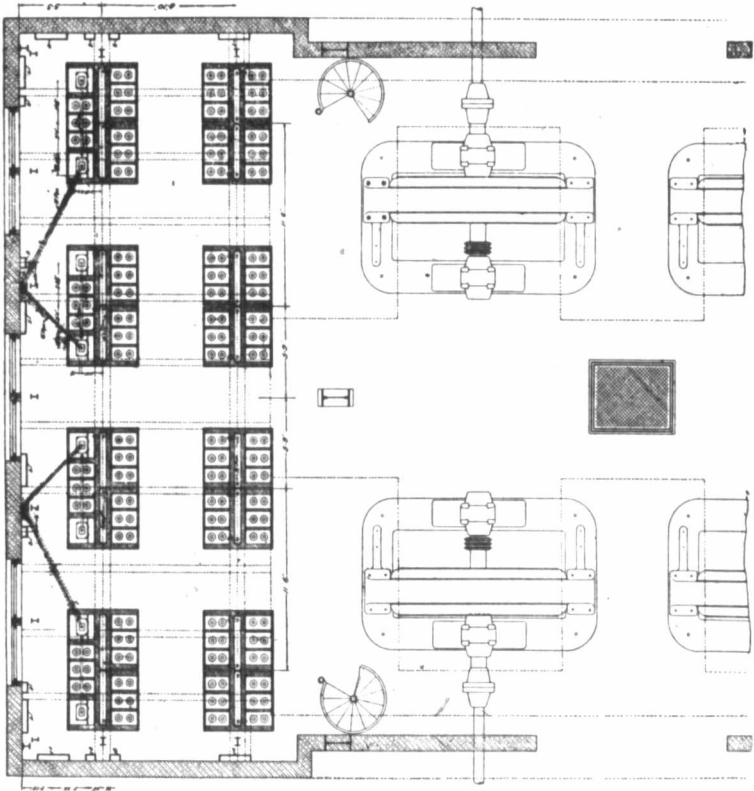
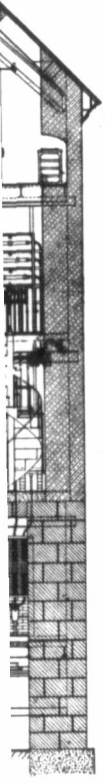

Fig. 8.



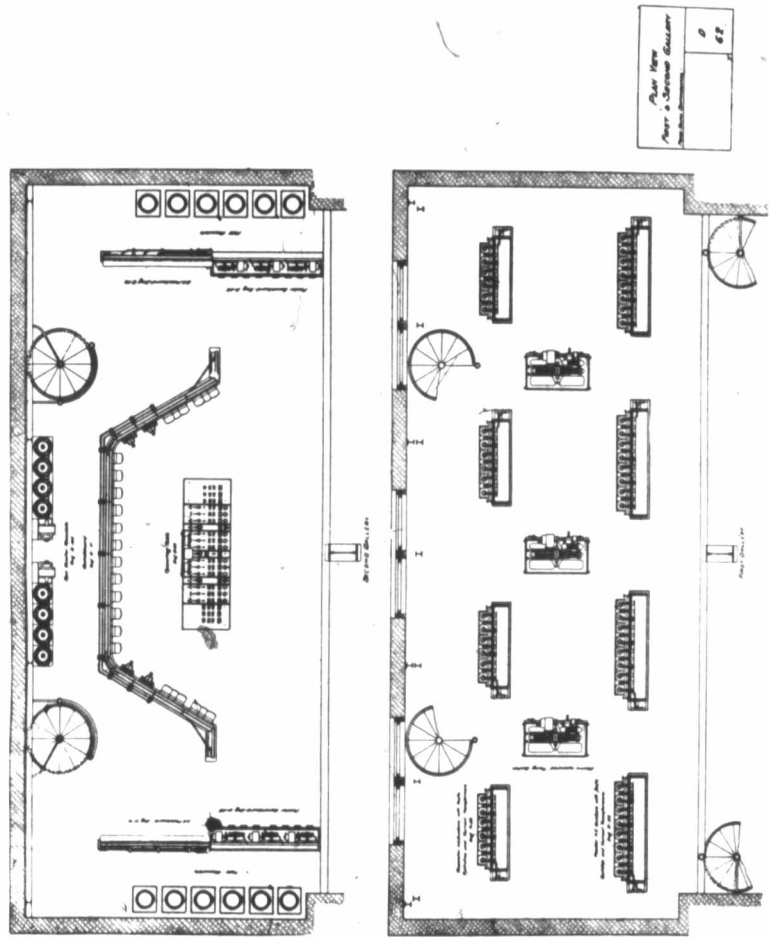

Fig. 9.

2"  
incl  
con  
fou  
the  
C  
mou  
The  
con  
l  
sepa  
gene  
indi  
curi  
and  
devi  
it is  
rath  
I  
the  
gene  
and  
T  
fault  
erato  
indic  
will  
reve  
O  
fuses  
oper  
necte  
O  
a cir  
annu  
T  
emer  
water  
choki  
fail t  
autor

## DETAILS OF SWITCH-BOARD, SWITCHES, ETC.

## MAIN SWITCH-BOARD.

The main switch-board (Fig. 10 and Fig. 10A) is constructed of 2" blue Vermont marble panels, having a total height of 7 feet 6 inches. The panels are bolted to 3" channels. This switch-board consists of four generator panels in the centre, two spacing panels, four exciter panels and four total output panels and at each end of the board is a panel for the recording instruments.

On the back of this board are two sets of exciter bus bars mounted on fibre block insulators, supported by cast iron brackets. These bus bars are  $\frac{1}{2}$ " x 2" copper and they, as well as all the connecting strips, are insulated with oil linen and tape.

It is possible to disconnect the exciter bus bars into three separate sections for repairs, etc. Each panel provides for three generators and each generator has on this board a power factor indicator, one A. C. ammeter, one D. C. field ammeter, two reverse current relays and D. P. D. T. field switch with discharge resistance and an annunciator or signaling device. No overload automatic devices or fuses are provided for the generators, it being held that it is preferable to let the generators hang on in case of an overload, rather than interrupt the service.

In case of any short circuit in the generator cable or in case of the field current falling short circuit of the collector rings, the other generators would of course pump back into this disabled machine and thus reverse the current.

The reverse current relays will then automatically cut off the faulty cable or generator from the bus bars. In case that the generators when in parallel fail to work together, then the power factor indicator will indicate the trouble, and the reverse current relays will again operate. These relays can be adjusted to operate at 10% reverse current.

On the back of this board are fuses for the field cables, and these fuses are set for three times normal full load, so that they can only operate in case of a dead short circuit on the field or cables connected thereto.

On each exciter panel there are a triple pole double throw switch, a circuit breaker, a Thompson astatic ammeter and the illuminated annunciator.

The circuit breakers are employed principally to take care of the emergencies, such as would be caused by the failure of one of the water wheels driving the exciter, as in the event of the water wheel choking up or governor lowering speed, so that this exciter would fail to generate and possibly become a motor, the circuit breaker automatically opens on 10% reverse current.

FIG. 9.

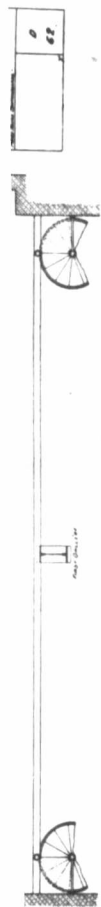

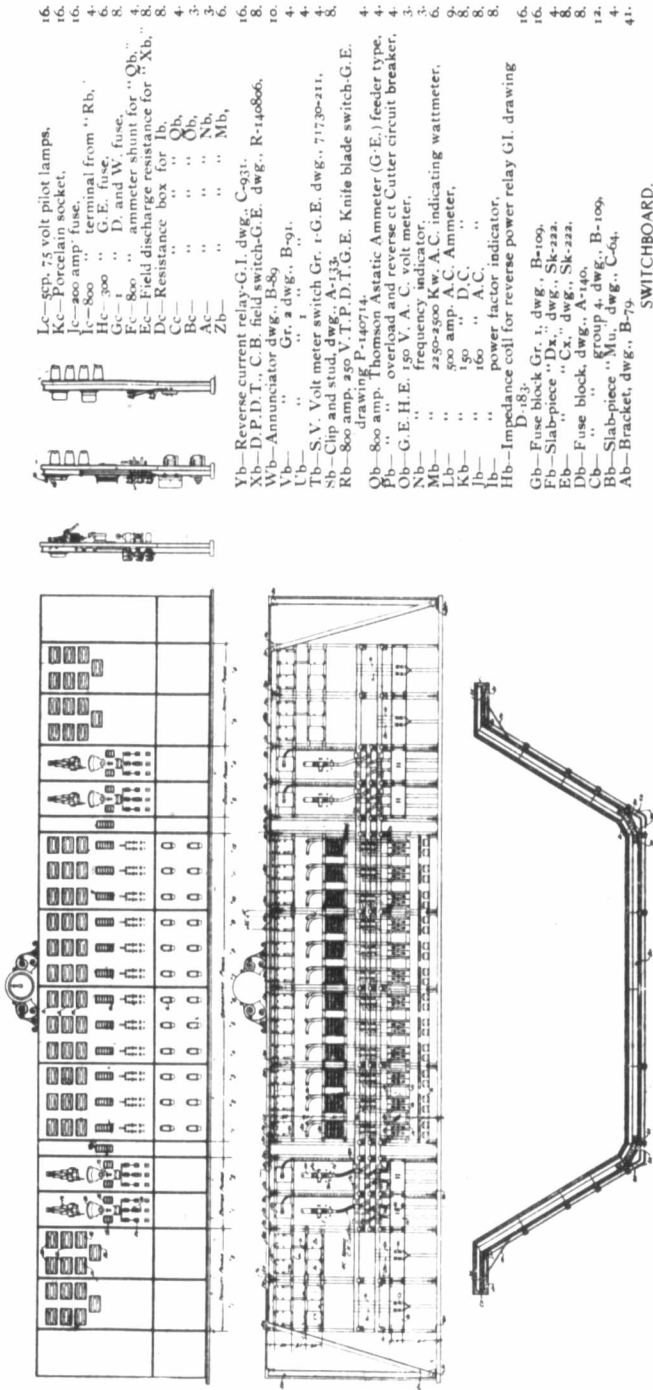

- 16. Lc—500-75 volt pilot lamps,
- 16. Kc—3p. relay socket,
- 16. Ic—300 amp fuse,
- 4. Hc—800 amp terminal from "Rb,"
- 6. Gc—300 " D, and W, fuse,
- 8. Gc—1 " D, and W, fuse,
- 4. Fc—800 amp ammeter shunt for "Qb,"
- 4. Ec—Field discharge resistance for "Xb,"
- 8. Dc—Resistance box for "Qb,"
- 4. Cc— " " " " " Qb,
- 4. Bc— " " " " " Nb,
- 3. Ac— " " " " " Mb,
- 6. Zb— " " " " " Mb,
- 16. Yb—Reverse current relay-G.I. dwg., C-931.
- 8. Xb—D.P.D.T., C.B. field switch-G.E. dwg., R-146866.
- 10. Wb—Annunciator dwg., B-89.
- 4. Vb— " " " " " B-91.
- 4. Ub—S.V. Volt meter switch Gr. 1-G.E. dwg., 71739-211,
- 8. Sb—Clip and stud, dwg., A-133.
- 8. Rb—800 amp. 250 V.T.P.D.T.G.E. Knife blade switch-G.E. drawing P-140714.
- 4. Qb—800 amp. Thomson Asiatic Ammeter (G.E.) feeder type.
- 4. Pb— " " " " " Cutler circuit breaker.
- 4. Ob—G.E.H.E. 150 V.A.C. voltmeter.
- 3. Nb— " " " " " frequency indicator.
- 6. Mb— " " " " " 2200-2500 Kw. A.C. indicating wattmeter.
- 9. Lb— " " " " " 900 amp. A.C. Ammeter,
- 8. Kb— " " " " " 150 " D.C. " "
- 8. Jb— " " " " " 160 " A.C. " "
- 8. Ib— " " " " " power factor indicator,
- 8. Hb—Impedance coil for reverse power relay G.I. drawing D-183.
- 16. Gb—Fuse block Gr. 1, dwg., B-109.
- 16. Fb—Slab-piece "Dx," dwg., Sk-222.
- 4. Eb— " " " " " "Cx," dwg., Sk-222.
- 8. Dc—Fuse block, dwg., A-140.
- 12. Cc— " " " " " "Group 4, dwg., B-109.
- 4. Bb—Slab-piece "K" dwg., C-64.
- 4. Ab—Bracket, dwg., B-79.

**SWITCHBOARD.**  
POWER HOUSE.

**Lachine Rapids Hydraulic and Land Company,**  
Limited.

Montreal, February 8th, 1902.  
Approved by R. S. Kelsch.

**D**  
**41.**

NOTE.—Instruments, etc., for No. 1 of totality panels and No. 1, 2, 3 and 4 of generator panels are not counted in this table.

Fig. 10.



Limited.  
Montreal, February 8th, 1902.  
Approved by R. S. Kelsch.

NOTE.—Instruments, etc., for No. 1 of totality panels and No. 1, 2, 3 and 4 of generator panels are not counted in this table.

Fig. 10.

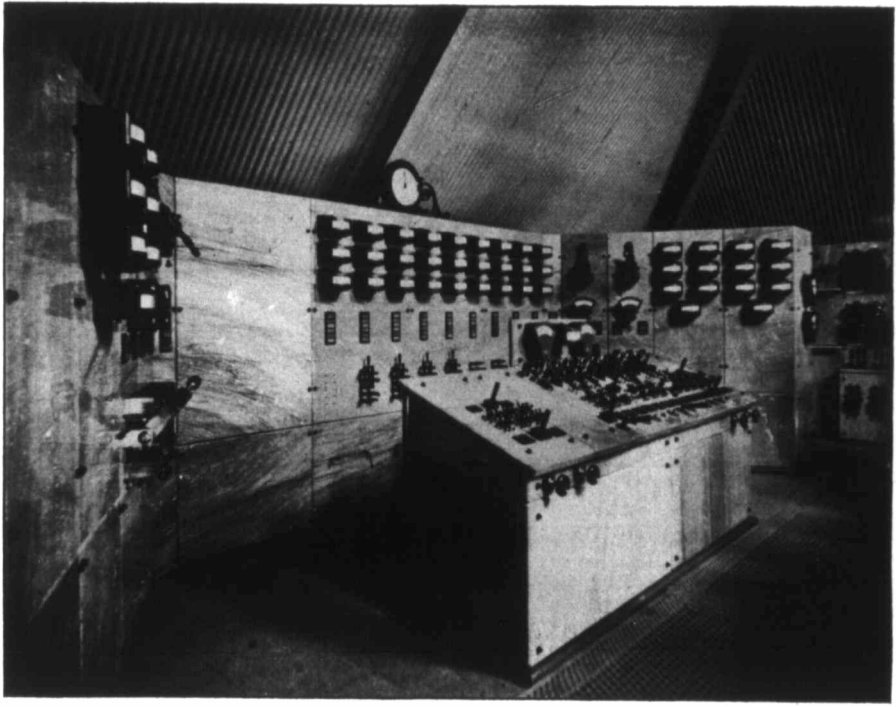

Fig. 10a.

an

an

6"

To

int

fou

for

rep

sin

sw

it

arr

tha

exc

for

cor

ope

cor

A.

exc

sin

cov

as

rhe

the

as

imp

fee

con

sec

ove

gre

see

Thi

On each totality panel are mounted two watt meters, three ammeters, a frequency indicator and the bus bar volt meter.

#### OPERATING TABLE.

The operating table (Fig. 11 and Fig. 11A) is constructed of  $1\frac{1}{2}$ " and 2" blue Vermont marble. On the back of the table, which is 9' 6" long, and three feet wide, are three double marble doors. The top of the table slants at an angle of 20 degrees. The top is divided into sections corresponding with the rest of the system. There are four panels for the generators, between each two of which is a panel for the control of the bus bars tying switch. As each generator panel represents a set of bus bars and the tying switch between them, a simple inspection as to whether the controlling switch of the tying switch is closed or not, which is indicated by colored pilot lamps, it is an easy matter to see how the bus bars are connected. This arrangement makes the existing conditions as clear, if not clearer, than any device of dummy bus bars or the like, could produce.

On the two extreme ends of the table are the panels for the exciters. The operating table contains all the necessary apparatus for the automatic and hand control of the oil switches, for the control of the motor operated field rheostat switches, of the motor operated main rheostats for the exciters, of the turbine governor control, the signal system and a synchronizing device. Also the A. C. volt meter for the generators and the D. C. volt meters for the exciters, together with the necessary plugs for same.

The amount of wiring necessary inside the operating table is simplified by the use of multiple conductor paper insulated lead covered cables, but nothing which is likely to cause an arc, such as fuses or switches, or to heat up the inside of the table, such as rheostats or lamps, are put inside. The leads are all protected by the fuses, but these latter are mounted on a separate panel, known as the D. C. distributing switch-board for the auxiliaries.

#### THE FEEDER BENCH BOARDS.

The two feeder bench boards, (Fig. 12 and Fig. 12A) as the name implies, contain all the apparatus necessary for the control of the feeder oil switches and are each 7' 6" high and 7' long. They are constructed of 2" and  $1\frac{1}{2}$ " blue Vermont marble, divided into two sections, each section for four feeders. On these are mounted the overload relays, the automatic controlling switches and the red and green pilot lamps, for the same.

According to whether the red or green lamp is lighted, can be seen whether the oil switch on the main floor is open or closed. This is the same as on the operating table for the generator and

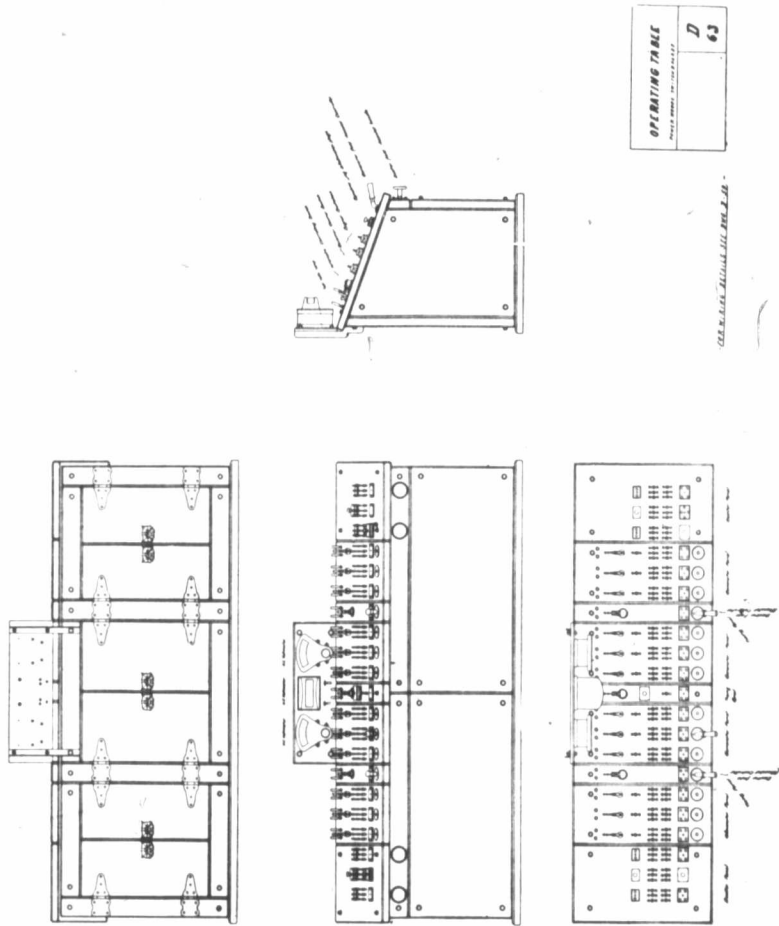

Fig. 11.



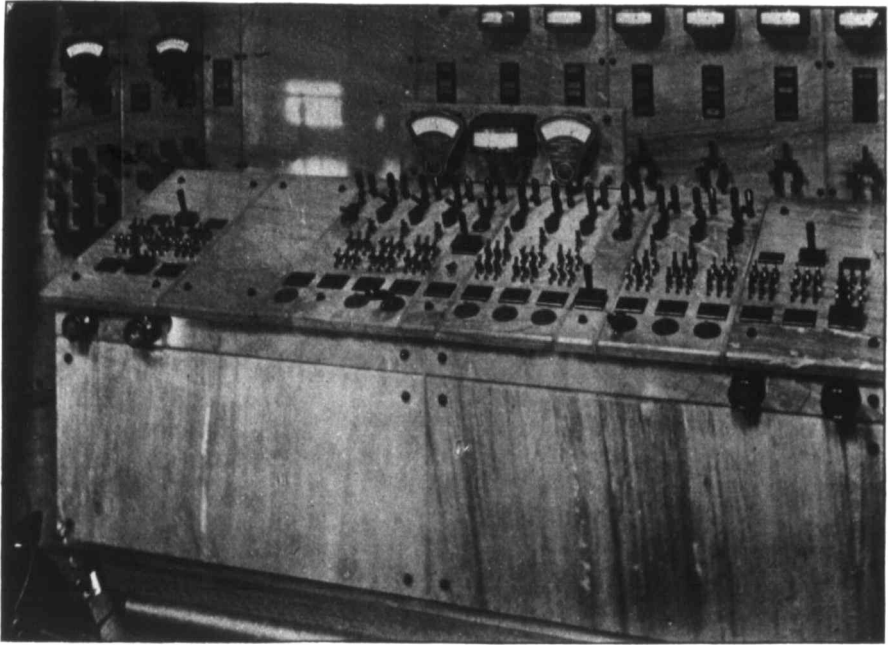

Fig. 11a.

Fig. 11.



tyl  
fee  
(  
whi  
any  
terr  
the  
and  
f  
line  
line  
spa  
accu  
desl  
(  
inal  
cont  
swit

T  
side  
cons  
fuse  
auxi  
excit  
is us

T  
main  
for e  
oper  
hors  
B  
the c  
one  
rheos  
moun

tying switches. No instruments whatever are provided for the feeders; as most of the feeders run to one distributing point.

On the top of the table will be seen the terminal board, by which means it is possible to put ammeters, watt meters, etc., in on any feeder and on any phase, by connecting the ammeter to the terminal and taking out the connecting bar. The instrument is then connected on the secondary side of the current transformers and in series with the overload relay.

This provides very simple means of checking the load on the line, without having to interfere with, or handle the high tension lines, and does away with the necessity of a costly instrument board, space for which was not available.

The relay coils are so designed, that they do not affect the accuracy of the testing instrument, which is mounted on a portable desk.

On the tops of the slabs containing the above mentioned terminals, are mounted the motor operated field rheostat switches controlled from the operating table. These are in plain view of switch-board attendant when in front of the operating table.

#### THE D. C. DISTRIBUTING SWITCH-BOARD FOR THE AUXILIARIES.

(Fig. 13.)

These switch-boards, of which there are two, are mounted alongside of the feeder bench boards. They are 7' 6" high and 7' long and constructed of blue Vermont marble. On them are mounted the fuses for all the supply leads of the direct current controlling or auxiliary devices, the source of energy being from either set of the exciter bus bars. The enclosed type of fuses, with indicating device, is used throughout on the board.

#### THE MOTOR OPERATED MAIN RHEOSTATS FOR THE EXCITERS.

(Fig. 14.)

These rheostats are mounted on the floor in the rear of the main instrument switch-board. There are two sets of these, one for each set of exciter bus bars. Each set contains four rheostats operated simultaneously by means of a worm shaft driven by half horse power d. c. motor.

By means of special clips, the triple pole double throw switch on the exciter panel, depending on its position, throws a rheostat of one of the two sets in series with the hand operated shunt field rheostat of the corresponding exciter. The latter rheostat is mounted underneath the ceiling floor of the second gallery, and is

Ie—Porcelain Socket.  
 Sk—Brass Socket and Fixture, dwg., 234.  
 Ge—5cp. 75 Volt Pilot Lamp.  
 Fe—D.P. Overload Relay G.I. dwg., B-269.  
 De—Automatic Controlling Switch G. I. dwg., B-723.  
 Ce—Ammeter Testing Terminal, dwg., A-129.  
 Be—Motor operated field rheostat G.E. dwg., R-129357.  
 Ae—25A. Fuse block, Gr. 1-dwg., B-109.

**ASSEMBLY FEEDER BENCHBOARD.**  
 Power House Switchboard.  
**Lachine Rapids**

Hydraulic and Land Co., Limited. **D 46.**  
 Montreal, June 17th, 1902.  
 Approved by R. S. Kelsch.

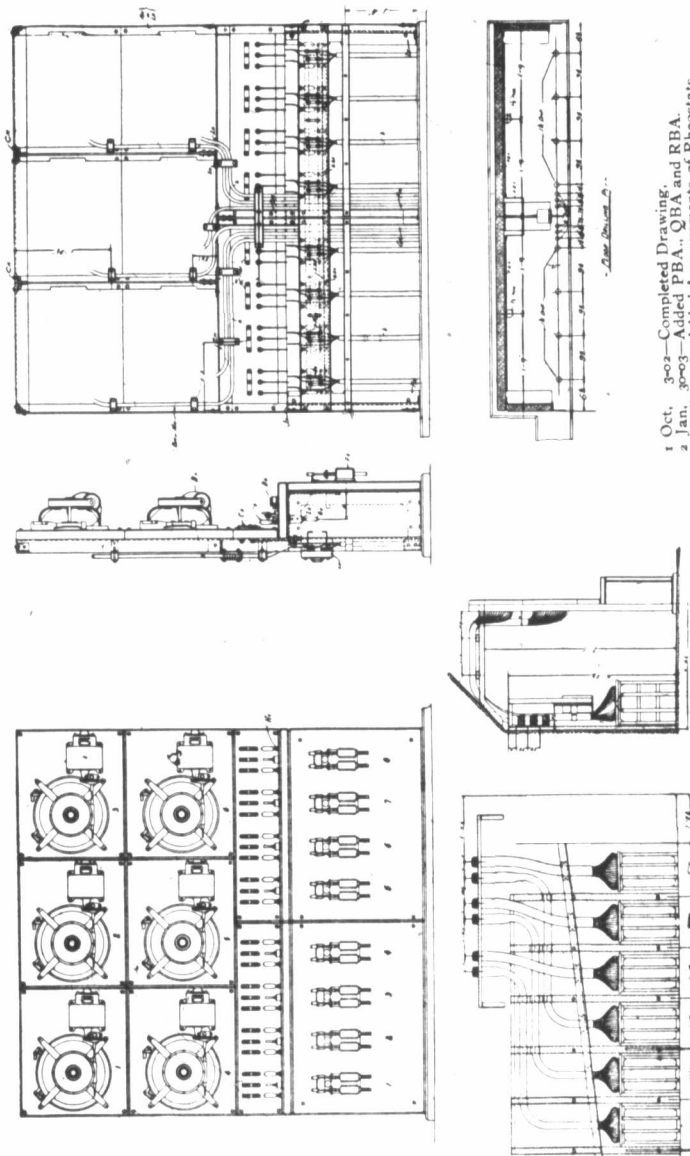

1 Oct. 30-02—Completed Drawing.  
 2 Jan. 30-03—Added P.B.A., Q.B.A. and R.B.A.  
 3 April 27-03—Added Arrangements of Rheostats.

**LIST OF CABLES.**  
 a—5 Conductor No. 14 B. & S. paper insulated lead sheathed cable.  
 b—4 Conductor No. 10 B. & S. paper insulated lead sheathed cable.

NOTE—For Iron details see dwg., D-40.  
 .. Marble and Slate details see dwgs., C-53 and C-64.  
 .. Copper details see dwg., C-71.

Fig. 12.





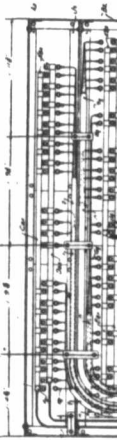

(Fig. 2)

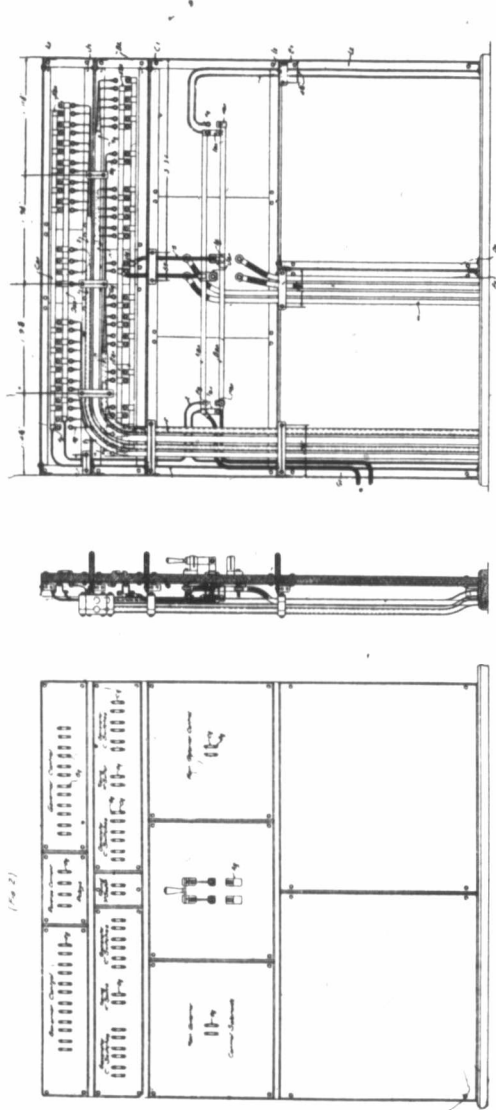

(No 2)

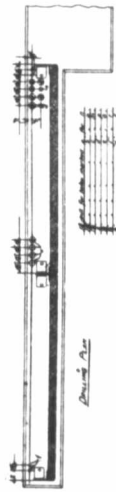

Relais de D. pour l'envoi des Signaux C. 15  
 Relais de R. pour l'envoi des Signaux C. 16  
 Les contacts C. 17 et C. 18 sont reliés à l'éclairage de la lampe  
 de la Station Reçueuse.  
 Les contacts C. 19 et C. 20 sont reliés à l'éclairage de la lampe  
 de la Station Émettrice.  
 Les contacts C. 21 et C. 22 sont reliés à l'éclairage de la lampe  
 de la Station Reçueuse.  
 Les contacts C. 23 et C. 24 sont reliés à l'éclairage de la lampe  
 de la Station Émettrice.

LISTE DE MATIÈRES

1	Le Circuit de D. pour l'envoi des Signaux
2	Le Circuit de R. pour l'envoi des Signaux
3	Le Circuit de D. pour l'éclairage des Lampes
4	Le Circuit de R. pour l'éclairage des Lampes
5	Le Circuit de D. pour l'éclairage des Lampes
6	Le Circuit de R. pour l'éclairage des Lampes
7	Le Circuit de D. pour l'éclairage des Lampes
8	Le Circuit de R. pour l'éclairage des Lampes

BREVET N° 1	
D. C. Des Intendants des Postes et des Télégraphes	
pour le Circuit de D. et de R. pour l'envoi des Signaux	
à l'usage des Stations Reçueuses et des Stations Émettrices	
à Paris le 20 Mars 1878	
M. DUBREUIL, Commissionnaire de l'Administration des Postes et des Télégraphes	
	C
	73

FIG. 12

Fig. 13.

- Ia—Coupling.
- Ha—Discharge Resistance for Aa.
- Ga—Slab piece B, Dwg., SK 237.
- Fa— " " A, " " " "
- Ea— " " C, " " " "
- Da—Cut-off device for Ba dwg., C82.
- Ca—Base for Aa dwg., B126,
- Ba—Carpenter Rheostat,
- Aa—G. E. Type CA, 3/4 H P.-115 V. 1200 R.P.M.D.C. Motor.

MAIN EXCITER RHEOSTAT ASSEMBLY  
Electrically Controlled.

P. H. Switchboards.

Lachine Rapids Hydraulic and Land Company, Limited.

B

Montreal, November 4th, 1902.

125.

Approved by R. S. Kelsch.

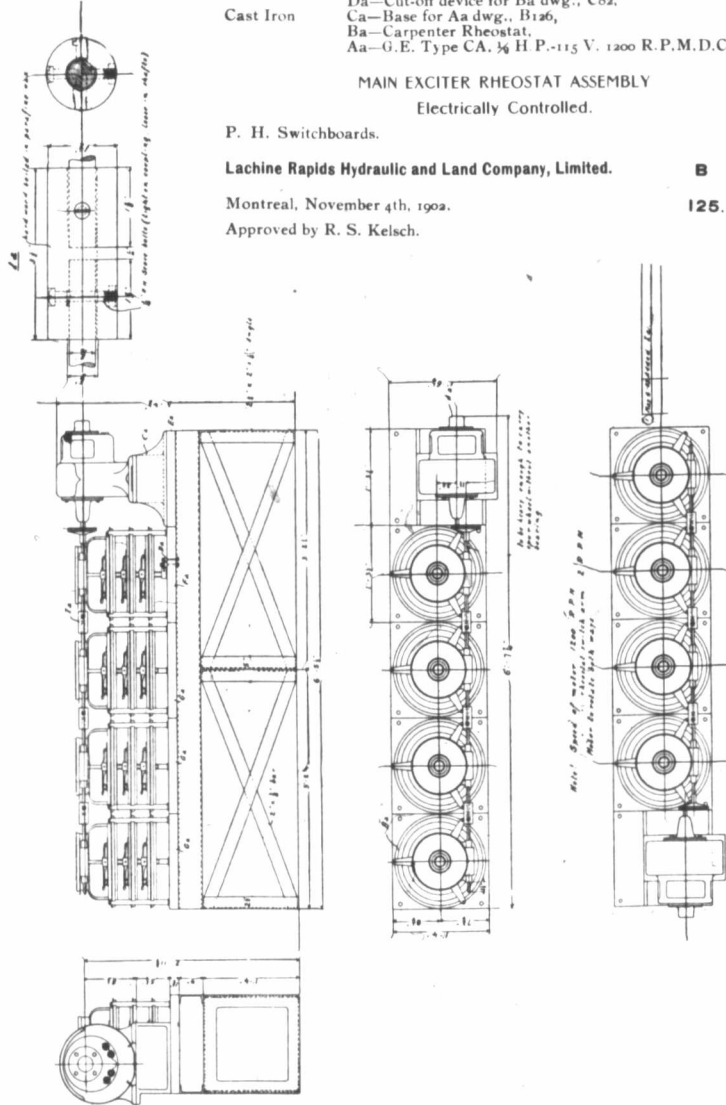

For 4-75 K.W. Exciters.

Fig. 14.

Scale 1/16000 - 1/1000

contr  
table.  
rheos  
eously  
the of  
TH  
norm  
one v  
Re  
order  
works  
It  
that t  
conne  
the sv

The  
mount  
soapst  
drawn  
rubber  
the of  
switch  
The K  
back  
insula  
carry  
thickn  
wound  
which

The  
On the  
twenty  
Gener  
switch  
barrier  
partme  
connec

controlled by means of sprocket chain gearing from the operating table. On the operating table are mounted the controllers for these rheostats. The object is to raise or lower the voltage simultaneously on all exciters which are in multiple, and thus to simplify the operation.

This plant is regulated entirely by the exciter voltage under normal conditions, as one volt increase on the exciter bus bar is one volt increased pressure on the 110 volt A. C. distributing system.

Reference must be had to the general diagram of connections in order to clearly understand the principle on which this arrangement works.

It remains to be said, that the special clips are especially long so that the switch blade on the main exciter switch closes on this field connection and the exciter can be adjusted for the voltage before the switch is finally closed on to the bus bars.

#### A. C. BUS BARS.

(Figs. 15, 15a and 15b.)

The high tension bus bars situated on the first gallery, are mounted on soapstone panels, two inches thick, with  $1\frac{1}{4}$ " and  $1\frac{1}{2}$ " soapstone barriers. Each bus bar is composed of 2" by  $\frac{3}{8}$ " hard drawn copper bar supported on studs which pass through hard rubber bushings. It will be seen that the current is carried from the oil switches through the current transformers to the knife blade switches and thence to the bus bar studs by means of copper bars. The knife blade switches serve the purpose of making the oil switches entirely dead for cleaning and for repair purposes. On the back of the panels the connecting strips and terminals are so well insulated as to make it impossible to touch any bare or current carrying part of the bus bars, etc. The insulation being three thicknesses of oil linen, asbestos pressed board, over which is wound, completely covering the same, a hard braided cord, after which it receives one coat of so-called fire proof paint.

#### OIL SWITCHES.

There are two types of electrically controlled oil switches in use. On the main floor for the generator and feeder switches, there are twenty-eight compartment type oil switches furnished by The General Incandescent Arc Light Company of New York. These switches are mounted in a buff brick chamber, divided by soapstone barriers into three compartments, one for each phase. In each compartment there are two oil wells containing switch clips, which are connected by an inverted copper "U" connector. The latter is

3.  
1.  
3.  
3.  
1.  
1.  
1.  
1.  
1.  
1.  
1.  
4.  
1.  
1.  
C. Motor.  
5.  
For 475 K W. Exciters.

Scale 1/16" = 1 foot

Fig. 14.

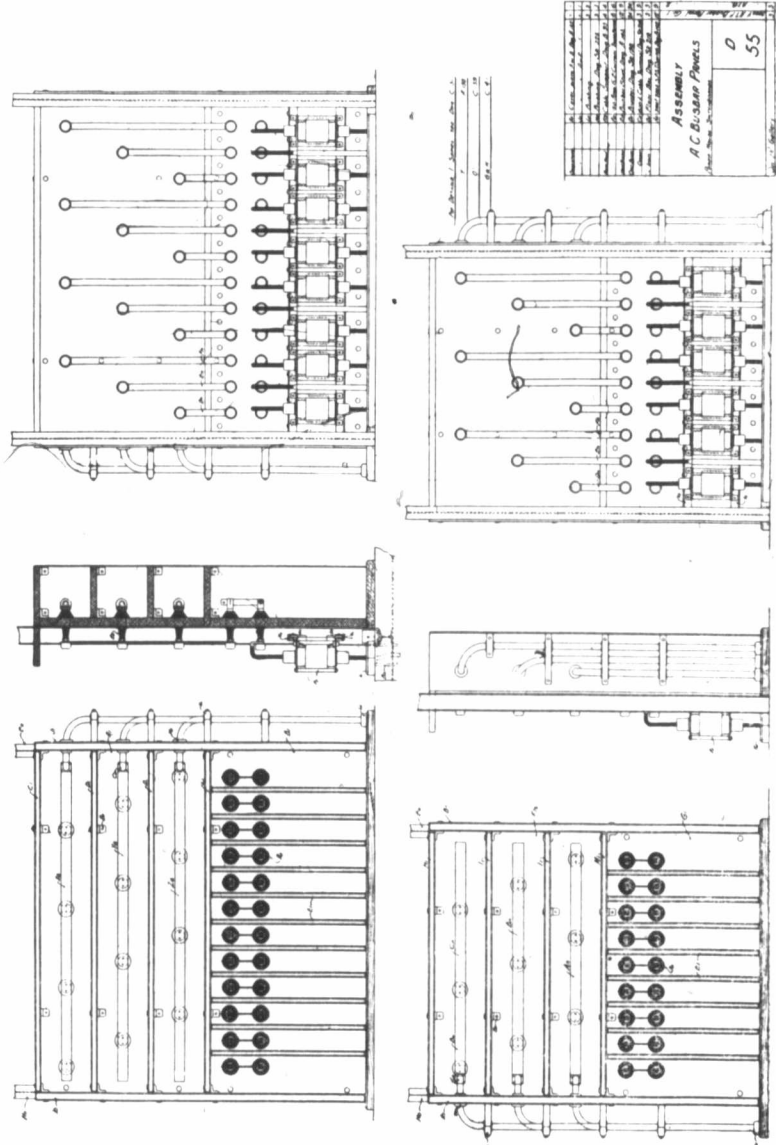

Fig. 15.

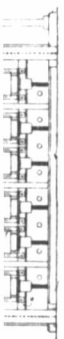

Fig. 15.

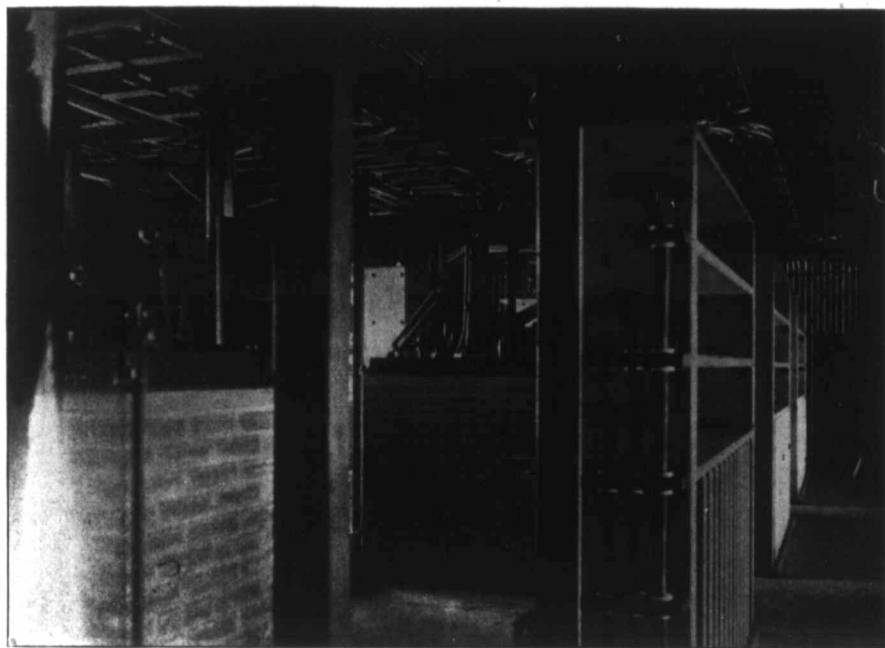
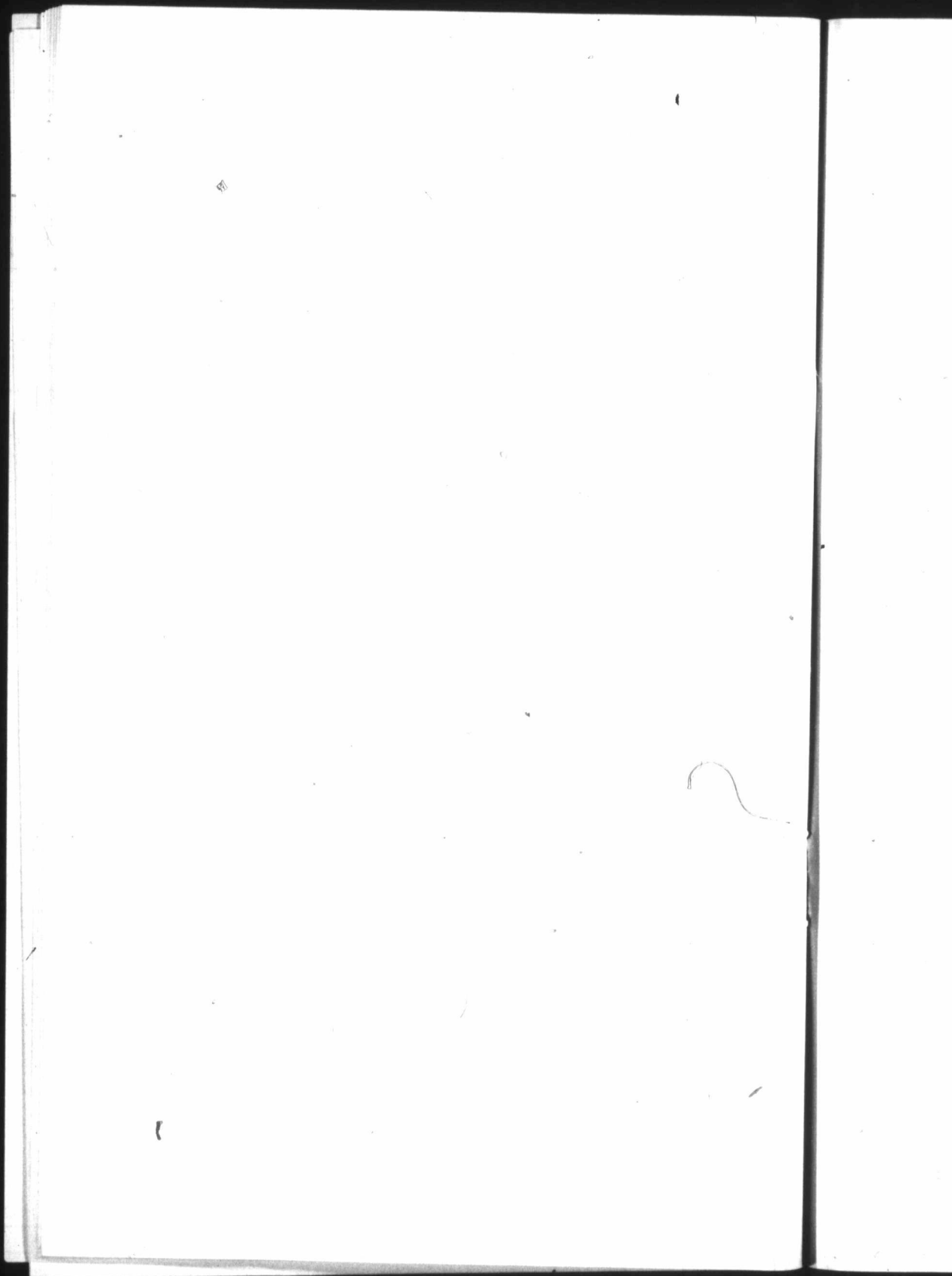

Fig. 15a.





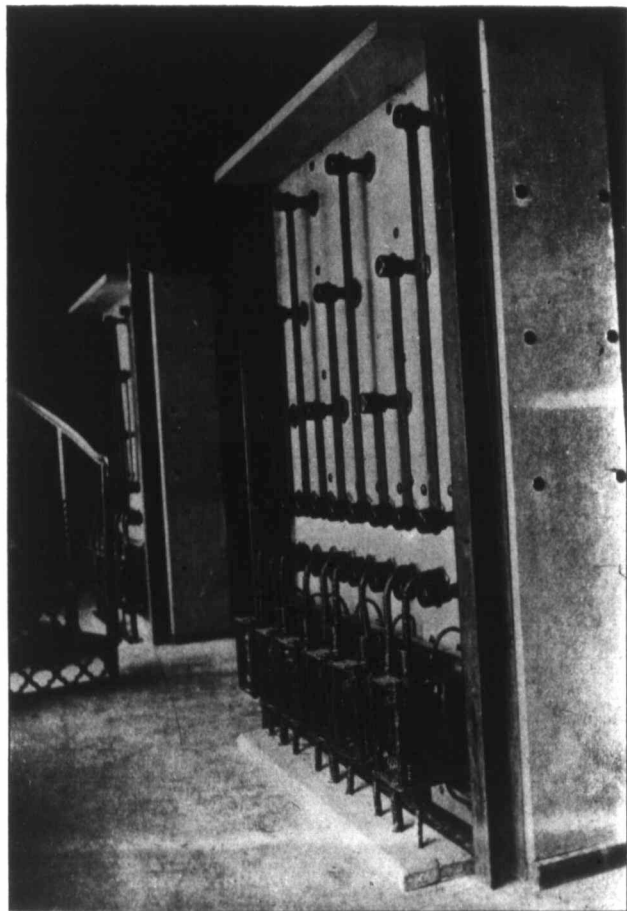

Fig. 15b.

fasten  
outside  
nolds.  
a crat  
above  
On  
partm  
they l  
and of  
G. I. s

On  
device  
speed  
contro  
attach  
the go  
reason

It  
much  
gener  
or his  
gates  
dama  
start  
bring  
speed  
man  
imate  
such

chror  
T  
spind  
valve  
as to  
rache

T  
one  
ation  
has  
need

F  
oper

fastened to a wooden rod and the three rods are connected together outside of the switch compartment by an iron cross bar. The solenoids, one for opening and the other for closing the switch, operate a crank and connecting rod movement, to which is attached the above cross bar. There are two 14" breaks in each phase.

On the first gallery for the three tying switches are three compartment type switches, furnished by the General Electric Company, they being the well-known G. E. Company's Compartment Switch and operated by a direct current motor, and are quite similar to the G. I. switches in general construction.

#### GOVERNING CONTROLLERS.—(Fig. 16.)

One of the interesting features of the plant is the controlling device for the Lombard Water Wheel Governors, by which the speed of the water wheels driving the generators is electrically controlled from the operating table. It was at first the intention to attach to the governor a D. C. motor for changing the adjustment of the governor, but this plan was finally abandoned for the following reasons:

It was found undesirable to give the switch-board attendant too much control over the wheels, especially as he could not see the generators or water wheels, and it might occur that by inattention or his inability to see the generators and wheels, he would open the gates too rapidly or too far at no load, which might do considerable damage. Inasmuch as the wheelman in any case is required to start the wheels and to open the valves on the governor, and to bring the water wheels and generator up to approximately normal speed, it was decided that the best plan would be to let the wheelman start up each unit and after bringing the generator to approximately the right speed, to give the switch-board attendant only such control as may be necessary to get the generator in synchronism.

Two solenoids operate the ratchet wheels which are fixed to the spindle or rod which connects the fly ball with governor regulating valve. One of these solenoids operates a ratchet in one direction so as to raise the speed, and the other solenoid operates another ratchet in the opposite direction, which lowers the speed.

This device was designed by the Engineering Department and one was constructed for experimental purposes and put into operation in June, 1900, and this device, employed on all of the governors, has been in continual use over three years, and, as yet, has not needed any repairs, nor caused any trouble of any kind.

Fig. 17 shows the diagram of electrical connections. On the operating table there is a single pole double throw cam switch

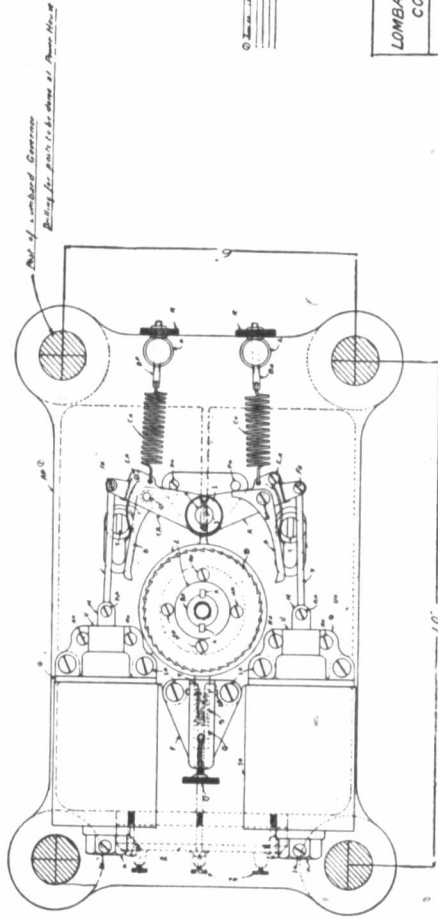
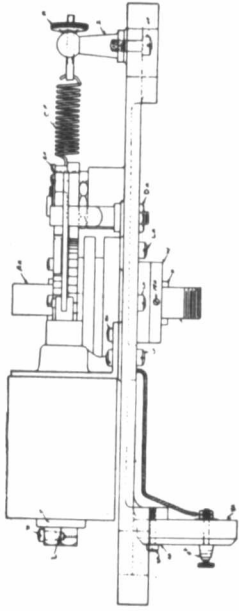

*Part of Lombard Governor  
Being for parts in case of Power House*

© 1914  
Lombard, Green, & Co., Inc.  
Chicago, Ill., U.S.A.

LOMBARD GOVERNOR CONTROLLER	
B	108

For detail drawings see Drawings C61 and D49.

Fig. 16.

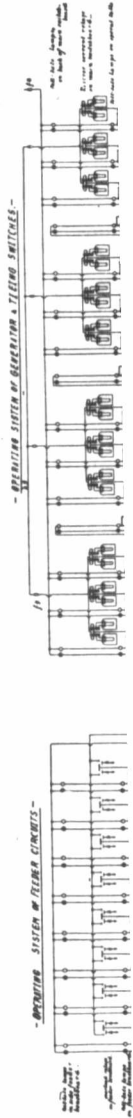
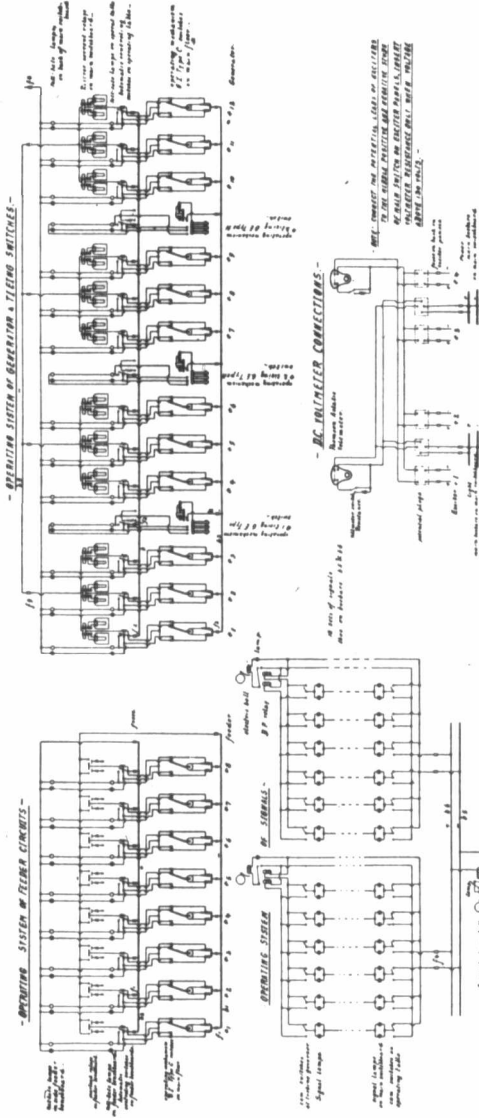
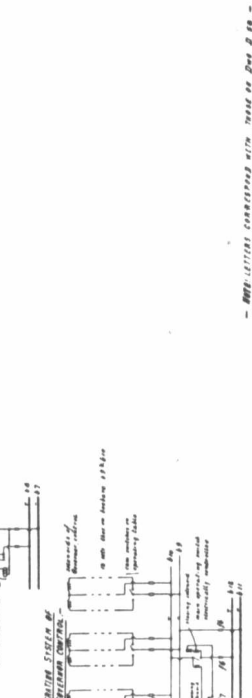

Fig. 16.



GENERAL D.C. BREAKERS CONNECTIONS P. A. BUSHBANK	C
	80.

Fig. 17.



OPERATING SYSTEM OF STEAM CONTROL WITH TIGHTENING COILS

which controls simultaneously or singly all the governors in the power house.

THE SIGNAL SYSTEM.—(Fig. 18.)

From the above, it will be seen, that on the generator and exciter panels, annunciators are mounted. Each annunciator has six compartments with ground glass covers, back of which are two five candle power 75 volt lamps, connected in multiple, and on each piece of ground glass is printed certain signals. These lamps are operated from single pole double throw cam switches mounted on the operating table.

Similar annunciators and switches are mounted at each turbine governor, and the lamps here are in series with those on the main switch-board. Thus it is possible for the wheelman and the switch-board attendant to interchange with each other, six different kinds of signals, which are lettered on the ground glass. The lamps and signals are not visible except when they light up. Fig. 17 shows the diagram of connections and it will be seen that at each end relays operate electric bells, thus calling attention to the signals. The switches must at all times be closed on to one of the clips, and they are so designed that they cannot be kept or left open. The switch as shown in Fig. 18 has a short steel arm, with a knife like edge in the centre. A steel ball presses by means of a spring against this edge and this forces the switch one way or the other. The 75 volt lamps, being in series and burning on the 125 volt circuit, are thus ensured a very long life and giving sufficient illumination for the purpose. There are at all times two lamps in multiple, so that if one lamp burns out, there will be no failure in the signal system. The method of signalling is as follows:

The switches at both ends are on the same, say the positive pole, and the lamps are out. The switch-board attendant, wishing to signal, switches over the cam switch corresponding to the signal to be given, to the negative pole and the lamps at both ends are lighted. The bells on both ends ring and wheelman sees the signal and to answer it, throws his switch also to the negative pole and the lamps are extinguished, the bell ceases to ring, and the switch-board attendant is therefore notified that the signal has been seen and attended to. It is impossible to leave the switch, so that the signals are inoperative.

THE SYNCHRONIZING DEVICE.

Another interesting feature is the synchronizing device, in which the system of connection is novel, making it almost impossible for a mistake on the part of the operator. Where two or more sets of

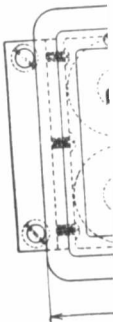
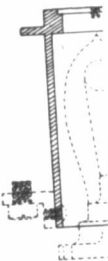
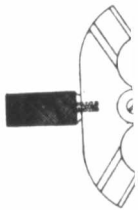

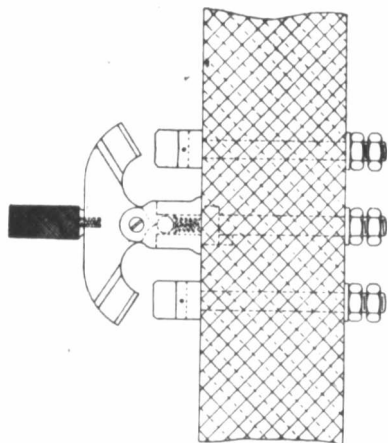

ANNUNCIATOR DETAIL  
REVISED  
B  
J.P. Allen '89

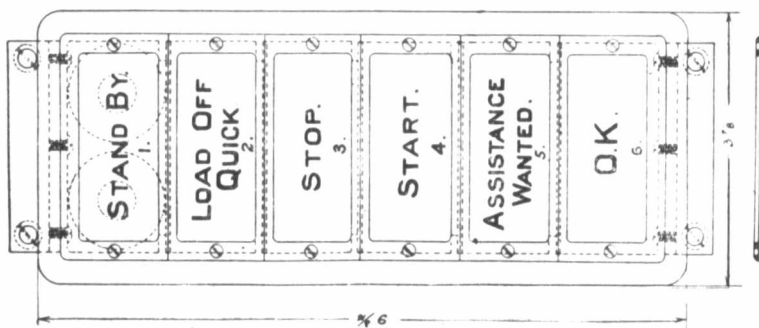
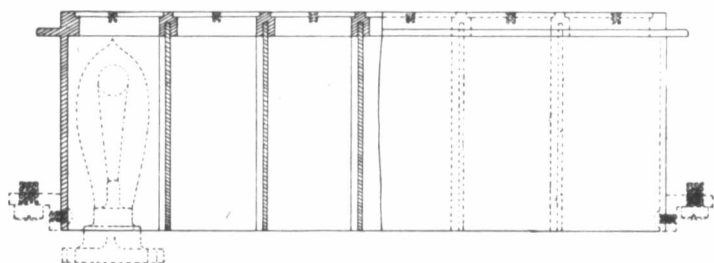

FIG. 18.

bus bars are used, with only one synchronizer, it is necessary to switch the latter over to the bus bar it is intended to synchronize with. This is the usual custom and it might happen that the switch-board attendant, thinking that he was synchronizing his generator with a particular set of bus bars, was actually synchronizing with another set, having through carelessness switched the synchronizer on to the wrong bus. Figure 19 shows the synchronizing connections. There is only one Lincoln synchronizer used and there are four different sets of bus bars for each generator, and for each bus bar tying switch there is one four hole receptacle on the operating table.

If the operator wishes to synchronize two sets of bus bars he inserts the four point plug on the corresponding tying panel. If he wishes to synchronize a generator with the bus bars, the plug is inserted in the corresponding four hole receptacle.

There are no other switches or plugging devices. The operator need not see that the Lincoln synchronizer is on the right bus, as the four point plug takes care of that and there is no interference between the potential transformer of one set of bus bars, and that of any other set. It is obvious, therefore, that a mistake on the part of the operator is absolutely impossible.

GENERAL

The various diagrams clearly show the methods of operation for the A. C. and D. C. systems. It remains to be said, that the overload relays for the feeders and reverse current relays for the generators, when subjected to the abnormal conditions they are set to operate at, close a D. C. circuit through the trip coil of the corresponding automatic controlling switches, on the feeder bench boards or operating table as the case may be, which in its turn actuates the solenoids on the oil switches and opens the latter. With the overload relays for the tying switches, the operation is different. In this case, the trip coil of the controlling switch is under normal conditions short circuited through the relay contacts. When the overload occurs the contacts are open circuited, which sends the current from the series transformer through the trip coil and thus opens the main switch. All the current and potential transformers have in either case the secondary wiring grounded, so there is no chance of injury in case the insulation breaks down.

As the secondary leads of the current transformers run up to the instrument switch-board, on the floor above, are consequently rather long, the leads are twisted to avoid any inductive effect which might affect the accuracy of the instruments.

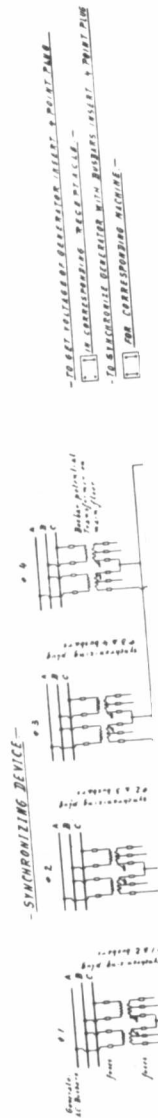



**- SYNCHRONIZING DEVICE -**

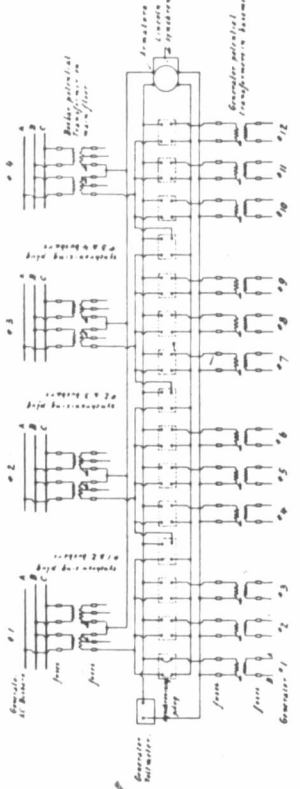

**- INSTRUMENT - CONNECTIONS -**

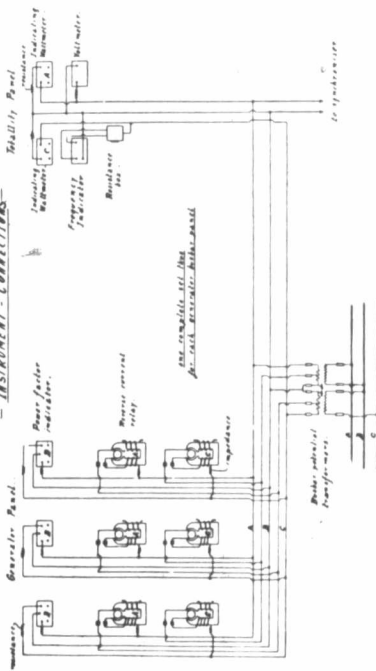

- DIRECT TABLET - GENERATOR WIRE IN POINT PANEL -
- IN CORRESPONDING WIRE CIRCLES -
- IN STRUCTURAL BLOCKS WITH RUBBER GASKET IN POINT PANEL -
- IN CORRESPONDING WIRE -
- TRANSFORMER THE SET IS BEARING LABEL IN POINT PANEL -
- IN CORRESPONDING WIRE PANEL -
- SAME POSITIONAL TRANSFORMER IN SET IS BEARING LABEL BEHIND RUBBER GASKET WITH RUBBER WIRE IN POINT PANEL -
- BEHIND POINT PANEL -
- BEHIND RUBBER WIRE IN POINT PANEL -
- BEHIND RUBBER WIRE IN POINT PANEL -
- BEHIND RUBBER WIRE IN POINT PANEL -
- BEHIND RUBBER WIRE IN POINT PANEL -
- BEHIND RUBBER WIRE IN POINT PANEL -
- BEHIND RUBBER WIRE IN POINT PANEL -
- BEHIND RUBBER WIRE IN POINT PANEL -
- BEHIND RUBBER WIRE IN POINT PANEL -
- BEHIND RUBBER WIRE IN POINT PANEL -
- BEHIND RUBBER WIRE IN POINT PANEL -
- BEHIND RUBBER WIRE IN POINT PANEL -
- BEHIND RUBBER WIRE IN POINT PANEL -
- BEHIND RUBBER WIRE IN POINT PANEL -

<b>POTENTIAL TRANSFORMERS</b> <b>DIAGRAMS OF CONNECTIONS</b> P. N. 5-440	
<b>B</b> Pot. Trans. No. 123.	

- SEE FOR CURRENT TRANSFORMER CONNECTIONS, SEE THE B.M.E. DIAGRAMS INDICATE THE PHASES -

Fig. 19.

It may be noted that all the wiring throughout the system, except the secondary leads from the current transformers, consist of lead covered paper insulated conductors. The instruments used on the main switch-board, are the well-known G. E. horizontal edgewise type.

The material for all of this work was purchased from various manufacturers. The switch board and all work connected with same was designed and built by the Lachine Company.

Fig. 20 is a view from main floor and Fig. 21 shows half of the power house and the relative position of new switch-board.



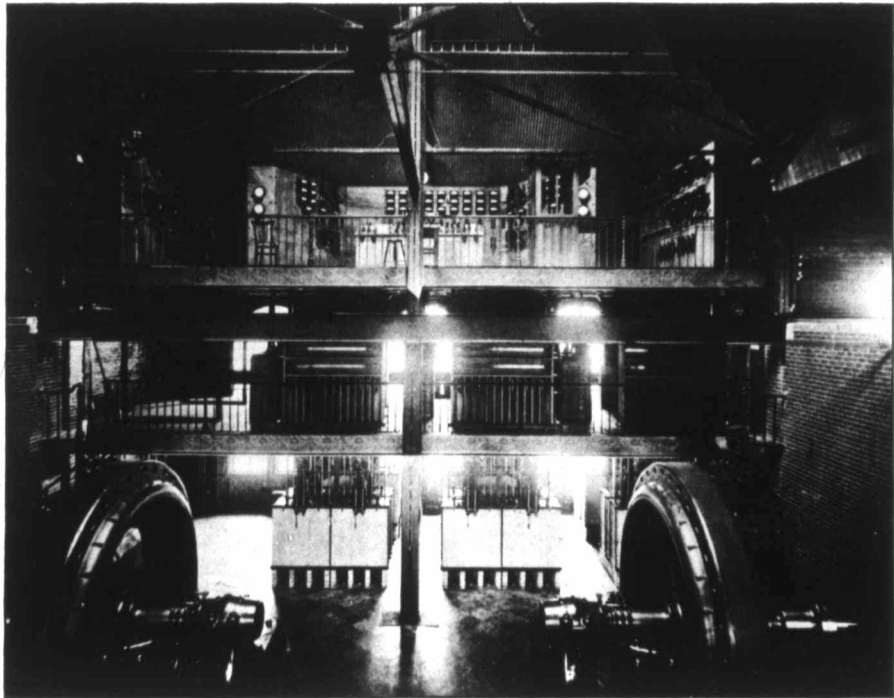
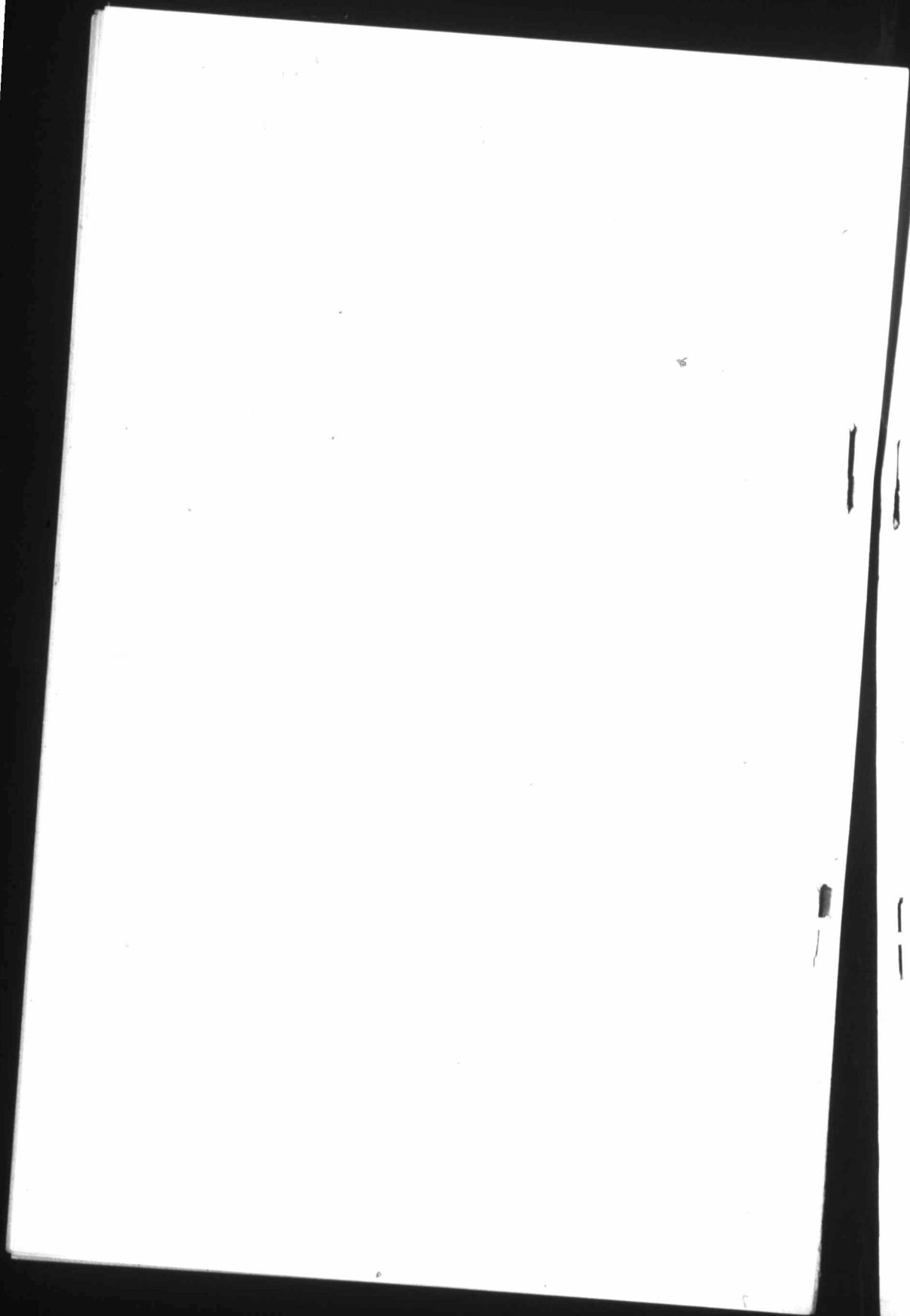

Fig. 20.



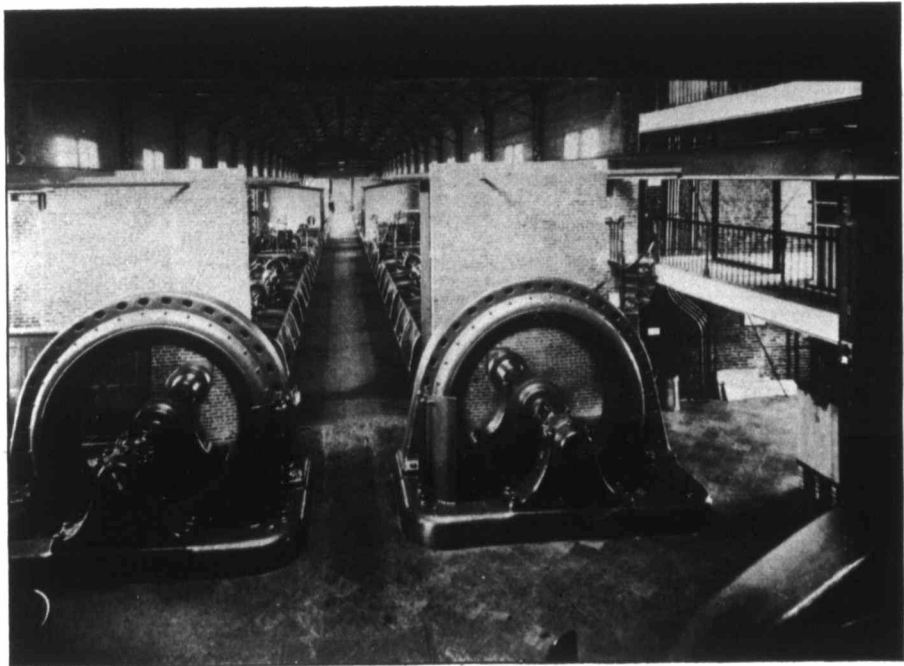

Fig. 21.