

Technical and Bibliographic Notes / Notes techniques et bibliographiques

The Institute has attempted to obtain the best original copy available for filming. Features of this copy which may be bibliographically unique, which may alter any of the images in the reproduction, or which may significantly change the usual method of filming, are checked below.

L'Institut a microfilmé le meilleur exemplaire qu'il lui a été possible de se procurer. Les détails de cet exemplaire qui sont peut-être uniques du point de vue bibliographique, qui peuvent modifier une image reproduite, ou qui peuvent exiger une modification dans la méthode normale de filmage sont indiqués ci-dessous.

Coloured covers/
Couverture de couleur

Coloured pages/
Pages de couleur

Covers damaged/
Couverture endommagée

Pages damaged/
Pages endommagées

Covers restored and/or laminated/
Couverture restaurée et/ou pelliculée

Pages restored and/or laminated/
Pages restaurées et/ou pelliculées

Cover title missing/
Le titre de couverture manque

Pages discoloured, stained or foxed/
Pages décolorées, tachetées ou piquées

Coloured maps/
Cartes géographiques en couleur

Pages detached/
Pages détachées

Coloured ink (i.e. other than blue or black)/
Encre de couleur (i.e. autre que bleue ou noire)

Showthrough/
Transparence

Coloured plates and/or illustrations/
Planches et/ou illustrations en couleur

Quality of print varies/
Qualité inégale de l'impression

Bound with other material/
Relié avec d'autres documents

Continuous pagination/
Pagination continue

Tight binding may cause shadows or distortion along interior margin/
La reliure serrée peut causer de l'ombre ou de la distorsion le long de la marge intérieure

Includes index(es)/
Comprend un (des) index

Blank leaves added during restoration may appear within the text. Whenever possible, these have been omitted from filming/
Il se peut que certaines pages blanches ajoutées lors d'une restauration apparaissent dans le texte, mais, lorsque cela était possible, ces pages n'ont pas été filmées.

Title on header taken from:/
Le titre de l'en-tête provient:

Title page of issue/
Page de titre de la livraison

Caption of issue/
Titre de départ de la livraison

Masthead/
Générique (périodiques) de la livraison

Additional comments:/
Commentaires supplémentaires:

This item is filmed at the reduction ratio checked below/
Ce document est filmé au taux de réduction indiqué ci-dessous.

10X	12X	14X	16X	18X	20X	22X	24X	26X	28X	30X	32X
								✓			

THE
CANADIAN PATENT OFFICE
RECORD.

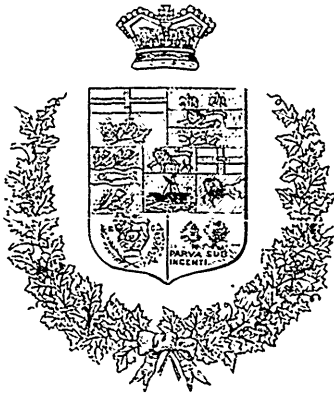

VOLUME VIII.

OTTAWA:

PUBLISHED BY AUTHORITY.

1880.



VOLUME VIII, 1880.-INDEX.

INDEX OF INVENTIONS.

Advertising device, C. F. Collat et al.....	11,008
“ “ E. W. Taylor.....	11,433
Air from cans, exhausting, T. G. F. Dolby.....	11,268
Airlag machine, J. Reid.....	11,925
Alarm bells, ringing, H. Brown et al.....	10,746
Albums, photographic, E. S. Glover.....	11,401
Alumina, purifying sulphate of, W. Chadwick et al.....	10,888
Amalgamating machine, ore, J. H. Wilhelm.....	10,981
Anchor, H. Martin.....	11,641
Animal substances, preserving, J. M. Reid.....	10,060
Archery, G. L. Thorne.....	10,892
Arms, fire, J. Lee.....	11,038
Atmosphere, moistening, J. G. Garland.....	11,541
Audiphones, R. S. Rhodes.....	10,857
“ “ T. W. Graydon.....	11,041
Augers, earth, R. B. Palmer.....	11,257
Axle, carriage, S. W. Ludlow.....	11,361
“ lubricator, car, W. G. Mitchell.....	10,987
“ vehicle, E. A. Wibbe.....	11,331
Bag holder and truck, B. Witt.....	11,868
“ mail, C. J. Beckett et al.....	11,845
“ “ J. H. Bartlett et al.....	11,569
Barbing fences, machine for, A. Cary.....	11,525
Bark extracts, purifying, E. Bradley.....	10,949
“ reducing machine, W. Shaw.....	10,968
Barrel stand, L. D. West.....	10,800
“ swing, P. W. Nelson.....	11,189
Baths, shower, D. Deshon.....	10,713
Battery, electric, G. M. Mowbray.....	11,239
“ galvanic, H. E. Hunter.....	10,965
“ medical, T. H. Hicks.....	11,802
Beams, plough, H. Ward.....	11,465
Bean pickers, T. Barnes.....	10,732
Bearings and journals, J. H. McLean et al.....	10,770
“ from heating, preventing, J. Dempsey et al.....	11,546
“ journal, H. G. Farr et al.....	11,720
“ lubricating, J. W. Batty et al.....	11,782
Bed and cabinet, J. W. Andrews et al.....	11,026
“ bottom, D. Knowlton.....	11,516
“ “ L. Wildermuth.....	11,867
“ “ and mattress, I. Mills.....	11,318
“ cot, H. Whiteside.....	11,810
“ fracture, I. M. Rhodes.....	10,777
“ spring, D. R. Nichols.....	11,122
“ “ E. Julien.....	11,745
“ “ H. B. Clark.....	11,758
“ “ H. H. Hull.....	11,334
Bedstead, cabinet, T. A. Covey.....	11,904
Bellows, &c., operating, C. Hammelmann.....	11,057
Bells, ringing alarm, H. Brown et al.....	10,746
Melting machine, G. S. Long.....	11,703
Belts, canvas, M. Gaudy.....	11,334
Belts, hooks, C. Kinney et al.....	11,281
Bending and shaping machine, J. B. Armstrong.....	10,883
“ machine, C. Wright et al.....	11,082
Berths for vessels, The Huston Ship's Berth Co.....	10,932
Beverages, aerated, D. Johnson.....	10,818
Bicycles, E. C. F. Otto.....	10,745
Blinder, grain, A. Kay.....	11,656
“ “ B. Chamberlain.....	11,162

Blinder, grain, C. J. Travis.....	10,814
“ “ C. W. Levalley.....	11,313
“ “ D. Williamson.....	11,418
“ “ G. F. Green.....	11,714
“ “ M. G. Hubbard.....	11,495
“ “ O. O. Storie.....	11,936
“ “ P. C. Evans et al.....	11,140
“ “ W. N. Whiteley.....	11,190
Binding, book, F. Hadley.....	10,821
“ “ L. Finger.....	12,001
“ machine, grain, M. A. Keller.....	10,799
“ “ “ W. A. Kirby.....	11,502
Bit braces, O. Peck et al.....	10,933
“ stock, “ “.....	11,793
Blind fastener, H. M. Wells.....	11,633
Block for wing rails, C. A. Post.....	11,091
“ saw-mill head, B. E. Sorganant.....	10,728
“ “ “ L. W. Pond.....	11,959
Board, bosom, F. M. Wright.....	11,975
“ cooling plough mould, H. Ward et al.....	11,483
“ dash, J. B. Armstrong.....	11,053
“ mould, G. Ward.....	11,893
“ or paper, J. O. Gregg.....	11,012
Boat, paper, P. A. Gendron.....	11,732
“ seat, A. McFarren et al.....	11,837
“ “ O. L. Hicks.....	11,066
Bobbin, O. E. Watt.....	10,781
“ winder, C. Raymond.....	11,212
Bodies, preserving organic, J. Wiekbersheimer.....	11,130
Boller cleaner, J. D. McEachern.....	11,123
“ cleaning, steam, F. Henderson.....	11,783
“ explosion, preventing, D. T. Lawson.....	11,687
“ feed water for steam, D. McMillan et al.....	11,807
“ feeding apparatus, S. G. Cohnfield.....	11,847
“ portable, J. Hall et al.....	10,890
“ scale, removing, A. S. Vinet et al.....	11,961
“ steam, G. H. Babcock et al.....	11,705
“ “ G. B. Dixwell.....	11,052
“ “ G. J. Scott.....	11,135
“ “ J. Livingston et al.....	11,982
“ “ J. Wavish.....	11,228
“ “ O. D. Orvis.....	11,089
“ “ W. Johnstone.....	11,280
“ tube cleaner, S. C. Taft et al.....	11,079
“ securing, W. Tully.....	11,322
Bolt and nut locks, H. M. Grubb.....	11,759
“ door, I. D. Bush.....	10,900
“ fastening, E. Leslie.....	11,004
“ flour, J. Webster.....	11,727
“ heading machine, J. A. Pellow et al.....	10,766
Bolting cloth cleaning, A. Graham.....	10,786
“ machine, C. J. Shuttleworth et al.....	11,142
“ “ flour, L. Baxter.....	11,784
Book cases, F. G. Johnson.....	10,954
“ copy, J. W. Wakeman.....	10,919
“ memorandum, A. Gardner.....	10,804
Boot and shoe heels, B. F. Locke.....	11,425
“ “ F. Richardson.....	10,807
“ “ hook, M. Bray.....	11,530
“ “ sole napper, F. Winslow.....	11,129
“ manufacture, J. F. Sharp et al.....	11,225
Boots, E. Parent et al.....	11,210
“ E. Roos.....	11,064

Boots, M. C. Mullarky et al.....	10,759	Calendering paper, M. Newton.....	11,501
" M. M. Clark.....	11,077	Camera, stereoscope, W. Harris.....	10,096
" and shoes, A. Gessmell et al.....	11,031	Can, exhausting air from, T. G. F. Dolly.....	11,268
" " D. A. McDonald et al.....	11,211	" filling apparatus, J. West et al.....	11,767
" " G. Desforages St. Maurice.....	10,939	" milk, F. J. Lee.....	11,461
" " H. G. Farr et al.....	11,329	" " J. G. Cherry.....	11,045
" " P. P. Veir.....	11,573	" oil, E. R. Deverall.....	11,038
" " J. C. Daggett.....	11,343	" " H. C. Bradley.....	11,385
" " J. Fogarty.....	11,651	" " H. Sangster.....	11,132
" " J. Fogarty et al.....	11,831	Candlestick, R. H. E. Siebert.....	10,979
" " J. Langlois et al.....	11,690	Cane shaving machine, G. S. Colborn.....	11,985
" " J. Lintoff.....	11,229	Car, cattle, W. S. Hunter et al.....	11,042
" " J. Popham.....	10,780	" door for grain, D. F. Van Liew.....	10,846
" " L. Derozler et al.....	11,182	" drawbars, D. Holt et al.....	11,475
" " L. Goddard.....	11,291	" earth, J. Andrews.....	11,721
" " M. A. C. Holmes.....	10,723	" freight, E. D. Shaffer.....	10,771
" " M. Bray.....	11,835	" grain, W. S. Hanson.....	11,529
" " S. Fortin et al.....	11,474	" hand, G. S. Shetfield.....	10,806
" " W. H. Hannaford.....	11,541	" link, railway, A. Middleton.....	11,665
" long leg, R. Church.....	10,700	" " " J. M. Foss et al.....	10,769
" top, E. Hoos.....	11,275	" live stock, E. D. Shaffer.....	10,934
Borer, hub, E. Caswell.....	11,221	" " " T. Clark.....	10,773
Bottle and stopper, H. Harrett.....	11,723	" mail, C. R. Harrison et al.....	11,000
" glass, L. E. Keeley.....	11,818	" palace and sleeping, T. Clarke.....	11,713
Bows, bending, C. Wright et al.....	11,081	" platform, R. A. Cowell.....	11,863
" Maltus.....	11,317	" railway, W. Stapley.....	10,943
Boxes, car fare, L. Wood et al.....	11,677	" truck, J. J. Thomas et al.....	10,074
" match, A. B. Wood et al.....	10,959	Carburetter, gas, J. Livesey et al.....	10,964
" paper, C. M. Arthur.....	10,721	" " " W. M. Jackson.....	11,795
" " J. R. Smith et al.....	10,829	Card holder, F. G. Hunter.....	11,369
" stallings, J. Kennedy.....	10,822	Carding machine feeder, W. C. Bramwell.....	11,213
" tobacco packing, T. Balmer.....	11,729	Carpet cleaner, T. Ferry.....	11,592
" wood venter, J. Cross Jr., et al.....	11,153	" exhibitor, A. Peterson.....	12,004
Braces, shoulder and back, R. W. Gray et al.....	11,156	" fastening, W. Bray.....	10,859
Brake, air, The Standard Empire Vacuum Brake Coy.....	11,610	" pad, H. M. Suall.....	10,764
" car, G. Smith.....	11,314	" sweeper, W. Orr et al.....	11,224
" " " J. F. Curtice.....	11,620	Carriage, O. B. Thompson et al.....	11,582
" " " J. Melssner et al.....	11,104	" and chair, J. W. Kenna et al.....	11,877
" " " P. Lorr.....	11,094	" pole, T. P. Banker.....	11,145
" " The Card Automatic Brake Coy.....	10,940	" sent lock, C. Roblouson.....	11,279
" " W. P. Widdfield.....	11,909	" step, F. A. Sawyer.....	11,147
" locomotive, C. W. Lampar.....	11,266	" top, G. A. Rudd.....	11,999
" pump, W. H. Cloud et al.....	11,362	" " The Guelph Carriage Goods Coy.....	11,909
" railway, C. F. Sinn et al.....	10,765	" wheel, G. N. French.....	11,133
" " S. P. Tallman.....	10,760	Cartridge capping device, A. Warden.....	11,741
" " T. W. Stanford et al.....	11,382	Cases, ammunition, O. K. Buckhout.....	10,756
" " G. W. Miles.....	11,103	" axe, A. Crosby.....	11,603
" steam, The Card Automatic Brake Coy.....	10,942	" book, F. G. Johnson.....	10,954
" vehicle, W. P. Widdfield.....	11,880	" thread, E. L. Fitch.....	11,944
" waggon, J. Carpenter.....	11,300	Castor, J. M. Harper.....	10,871
Bran cleaning machine, J. Mills.....	11,386	" barrel, J. R. McCall et al.....	11,956
" packing, W. L. Williams.....	11,919	" furniture, C. T. Soeben et al.....	11,636
Brick and tile " A. Whalen.....	11,020	Catarrh compound, A. T. Mitchell.....	10,913
" burning, B. Walton.....	11,429	Chain, drive, W. D. Ewart.....	11,719
Bridge, W. McLary.....	11,952	" for transmitting power, W. N. Whiteley.....	10,738
" and roof truss, E. Wassell.....	10,706	" stopper, D. N. B. Coffin et al.....	11,873
" trusses, S. R. Holt.....	11,370	Chair and carriage, J. W. Kenna et al.....	11,877
Broiler, J. M. Dierck.....	11,125	" dentist, E. Burritt.....	11,640
Broom, S. F. Fraley.....	11,365	" oscillating, A. H. Ordry.....	10,828
" corn, J. C. Reed.....	12,012	" rocking, W. H. Bartelo.....	11,831
" handle, D. A. Scott.....	10,873	" seats, hollowing, J. F. Master.....	11,138
Brush, C. Becke.....	11,792	Checks for horses, J. A. Lakin.....	10,991
" blacking, E. J. Wood et al.....	11,963	Cheese manufacturing, A. H. Brintnell.....	10,866
" " handle, P. Platt.....	11,167	Chimney sweeping machine, J. B. Rouillard.....	11,092
" " " Russell.....	11,377	China grass decoloring, J. J. Sachs.....	11,500
" painting, C. W. Meakins.....	10,609	Chuck, R. Mitchell.....	11,826
Buckle, J. H. Huntress.....	11,146	Churn, A. Coway.....	11,349
" harness, J. A. Gavitt et al.....	11,987	" " D. D. Ferguson et al.....	10,779
" harness, draw-bar, for car, T. Hibbert.....	11,854	" " E. Hamilton et al.....	11,119
Buggy tops, E. N. Henry.....	11,290	" " F. Idred.....	11,498
" " T. Smith.....	10,722	" " F. D. Tessier.....	11,100
Burner, gas, J. Livesey et al.....	10,964	" " G. S. Ward.....	11,281
" " J. N. Chamberlain.....	10,914	" " H. Calcult.....	11,891
" " hydro-carbon, W. D. Diney.....	12,011	" " J. Campbell.....	10,736
" " liquid fuel, H. A. Bradley.....	11,467	" " J. Shaw.....	10,687
Bush, bung, G. B. Cornell.....	11,524	" " J. E. Sprague.....	11,320
Butter, colouring, F. Lavaek et al.....	11,984	" " W. H. Baldwin.....	11,646
" preservation, J. Harger.....	11,471	" " and washer, C. D. Van Allen.....	11,548
" preserving, T. F. Wilkins.....	10,783	" " dasher, A. Holmes.....	11,900
Buttons, T. L. Snyder.....	11,593	" " " H. W. White.....	11,918
" manufacturer, M. W. Simonds.....	11,111	" " rotary, L. W. Murch.....	11,603
" shirt, C. Robinson et al.....	11,326	" " " P. A. Ryckman.....	11,806
Cabinet and bed, J. W. Andrews et al.....	11,028	Cider press, D. W. Witmer.....	10,755
" bedstead, T. A. Covey.....	11,904	Cigar holder, E. S. May.....	11,939
" oil, A. Foley.....	11,222	Cigarette machine, J. A. Bonsack.....	11,812
" paper, S. Weyer.....	11,144	Clamp, pistol, J. Kenney.....	11,046
Cable, telegraph, M. M. Manly et al.....	11,664	Clamping machine, sash, W. Abercrombie.....	11,634
Calculator for interests, W. J. Gard.....	11,511	Clasp, glove and shoe, H. O. and F. B. Lothrop.....	11,682
Calendar and pen holder, G. M. McCready.....	11,083		

Clasp, suspender, C. E. Johnson et al.....	11,353	Cultivator, and seeder, H. Springer.....	11,804
Cleaner, boiler, J. D. McEachren.....	11,123	“ sulky, W. Munn.....	11,762
“ “ tube, S. C. Taft et al.....	11,079	Cup, oil, H. R. A. Boys.....	11,943
Clip, whistletree, J. H. Harford.....	11,871	Curtain fixture, W. H. Gilman et al.....	11,227
Clocks, striking mechanism for, W. Lindon.....	10,929	Cushion, millstone, S. Keith et al.....	11,733
Closet, A. Mallory.....	10,707	Cutlery, hawking, E. Blaydes et al.....	11,157
“ J. Turner.....	11,579	Cutter head, G. J. Shimer.....	11,698
“ W. White.....	11,354	Cutting machine, grain.....	11,296
“ earth, J. W. Sprunt.....	10,855	Damper, stove, W. M. Gartshore.....	11,101
“ valve, water, T. Hennessy.....	11,969	Dash board, J. B. Armstrong.....	11,053
“ water, W. B. Malcolm.....	11,168	Dasher, churn, A. Holmes.....	11,000
Clothing, children's, N. C. Elliott.....	11,163	“ “ H. W. White.....	11,018
Coal scuttle, O. Eisenhuth.....	10,963	Decorating wood, S. K. Devereux.....	11,929
“ sifter, W. W. Whitaker.....	10,950	Dental compound, H. F. Bennett.....	11,805
Cock and valve, steam, J. Mallinson.....	11,848	Dials, sun, J. Thurston et al.....	10,846
“ compression, T. Campbell.....	10,811	Die for heel counters, J. Kiefler.....	11,076
“ or faucet, C. A. Blessing.....	11,357	“ holder, screw cutting, R. Mitchell.....	11,825
“ water, H. Hough et al.....	11,717	Dist, paper, C. Ingersoll.....	10,737
Cockle separator, H. Stevens.....	11,926	Distributor for fertilizers, R. B. Sheldon et al.....	11,431
Coffee, milk, S. Marrotte.....	10,910	Ditching machine, A. G. Peck.....	11,935
“ percolator, W. G. Petry.....	10,962	Dock, floating, J. L. Clark et al.....	11,951
Coffin, metallic, J. McMaster.....	11,289	Dog, saw-mill, H. McQuarry.....	11,113
Collar, horse, A. McCorvie.....	10,860	“ “ J. M. Stovoll.....	11,772
“ “ E. Fisher et al.....	11,426	Door and gate, G. W. Simons.....	11,853
“ “ S. J. Rowers.....	10,709	“ fastener, W. H. Garloch.....	11,704
“ “ S. Peters.....	11,829	“ for grain cars, D. F. Van Liew.....	10,845
“ “ V. Forester.....	10,782	“ for lock, mortising, H. A. Holt et al.....	11,258
Commodore, J. W. Sprunt.....	10,855	“ framing, J. Gresby et al.....	11,739
Compass for ellipses, C. McBean.....	10,824	“ grain car, J. Miller et al.....	12,017
Condenser, W. McIntyre.....	11,601	“ “ T. Hibbert.....	11,850
“ and injector, G. Mazza.....	11,463	“ guard, J. P. Ellicott.....	11,350
Conductor of electricity, T. A. Edison.....	11,997	“ hanger, E. Prescott et al.....	10,727
“ water, G. K. Reber.....	11,211	“ shutter, A. Wright.....	11,297
Conveying machine, A. E. Brown.....	11,937	“ sliding, M. Roberts.....	11,421
Cooking apparatus, J. K. Boswell.....	10,927	Draw-bar for ear buffers, T. Hibbert.....	11,851
“ range, G. R. Prowse.....	11,841	“ railway, D. Holt et al.....	11,475
Cooler, milk, F. N. Blais.....	11,941	“ plate, C. D. Rogers.....	11,152
“ “ L. B. Austin.....	11,059	“ “ hammering, C. D. Rogers.....	11,421
“ “ N. D. Martin et al.....	11,691	Drawing apparatus, G. Rosquist.....	11,819
Cooling liquids, Z. N. Gellins.....	11,402	“ machine, wire, C. D. Rogers.....	11,612
“ plough mould boards, H. Ward et al.....	11,483	“ reproducing, A. Ungerer.....	10,719
Copying apparatus, M. Allison.....	11,299	Dress, millstone, W. C. Hale.....	11,697
“ “ W. Wallace.....	10,708	Drier and evaporator, J. S. Bowen et al.....	11,875
Corset, E. W. Bigelow.....	11,307	“ roaster, H. W. Booth.....	11,100
“ H. A. Schandeyol.....	11,581	“ shelf, The Hamilton Industrial Works Co.....	11,921
“ M. K. Bortree.....	11,699	“ clothes, F. W. Andrews.....	11,223
Cotton yarn, T. H. Dunham.....	11,430	“ lumber, P. G. Finn.....	11,910
Coulter, plough, J. Lane.....	10,818	Drill, steam, A. C. Rand.....	11,627
Counter form, heel, J. Kiefler.....	11,076	Drilling apparatus, H. Richman et al.....	11,780
“ machine, heel, J. Kiefler.....	11,438	Drum heating, W. C. Doddridge.....	11,148
Coupler, car, A. Cron.....	11,989	Drying apparatus, H. Scholfield.....	11,809
“ “ A. M. Bechard et al.....	11,352	“ “ J. K. Boswell.....	10,927
“ “ F. White.....	10,957	“ “ paper, N. Kaiser.....	11,683
“ “ G. N. Chailoner.....	11,120	“ stand, C. Wright et al.....	11,080
“ “ J. G. Scott.....	10,743	Dust receiver, N. Pyles et al.....	11,361
“ “ J. R. Forsyth.....	10,712	Duster, feather, L. A. Watson.....	11,510
“ “ J. T. Rice.....	11,378	Dyeing cotton, E. Posselt et al.....	11,794
“ “ J. W. Scott, sr.....	11,131	“ process, “ “.....	11,757
“ “ T. A. Trudelle et al.....	11,361	Dynamo-electric machine, C. A. Hussey et al.....	11,961
“ “ W. C. Perry.....	11,560	Elevator, R. Dunbar.....	11,696
“ “ W. J. Stethem.....	11,155	“ S. A. Bates.....	10,795
Coupling, axle, C. Embeck.....	11,926	“ grate, J. B. Stoner.....	11,461
“ car, A. Bartlett.....	11,515	“ safety, B. Slusser.....	10,894
“ “ C. E. Laroque et al.....	11,761	Electric battery, G. M. Mowbray.....	11,230
“ “ J. H. Ames et al.....	11,899	“ machine, dynamo, C. A. Hussey et al.....	11,964
“ “ H. Cooley et al.....	11,140	Electricity, conductor of, T. A. Edison.....	11,967
“ “ M. E. Morningstar et al.....	11,406	“ generating, C. F. Brush.....	11,621
“ “ M. W. McCann.....	11,838	“ utilization of, T. A. Edison.....	11,527
“ “ N. F. Brent et al.....	11,788	Embossing, printing and stamping, J. J. Sachs.....	11,409
“ “ N. F. Wynkoop.....	10,967	Emery wheel, J. T. Bernard.....	11,248
“ “ W. L. Fisher.....	11,805	Engle air, F. E. B. Beaumont.....	11,801
“ “ W. P. Cutter.....	11,332	“ gas and air, C. W. King et al.....	11,840
“ “ W. V. Perry.....	11,595	“ hot air, J. H. McNain.....	11,693
“ hose, J. Amor.....	11,660	“ pipes, oil injector for, J. V. and J. J. Renchard.....	11,927
“ joint, J. Walker.....	12,015	“ portable, J. Hall et al.....	10,889
“ pipe, W. J. Stevens.....	10,875	“ rotary, G. Murray, jr.....	11,967
“ screw threading, I. S. Schuyler.....	11,476	“ “ H. Thibaut et al.....	11,645
“ shaft, J. Walker.....	11,916	“ “ L. J. Baker.....	11,217
Cover, refrigerating, A. North.....	11,269	“ “ W. N. Degroot et al.....	10,935
Crayon holder, J. Reckendorfer.....	10,772	“ steam, A. B. Wood et al.....	11,880
Cream collector, P. G. Feltzer.....	10,977	“ “ G. B. Dixwell.....	11,828
“ obtaining apparatus, W. E. Lincoln.....	11,778	“ “ G. H. Babcock et al.....	11,712
Creamer, milk, F. H. McIntosh.....	11,830	“ “ H. Fairgrieve et al.....	11,734
Crimping machine, pipe, F. F. Packham.....	11,662	“ “ J. Haggert et al.....	11,828
Crusher, ore, F. A. Huntington.....	11,920	“ traction, C. F. Cooper.....	11,207
Cultivator, B. B. Small.....	11,187	“ treble cylinder, F. A. Gardner et al.....	11,417
“ E. Appleton.....	11,799	Envelope, E. O. Blecknell.....	11,555
“ J. Forbes.....	11,168	“ machine, D. M. Lester.....	11,176

Evaporator, E. R. Witney et al.....	11,195	Furnace, for extracting metals, A. C. Tichenor.....	10,917
“ and drier, J. S. Bowen et al.....	11,785	“ hydrocarbon, W. D. Dickey.....	12,011
“ “ ssp, D. McLehau.....	11,118	“ puddling, W. Stubbiebin et al.....	10,999
Excavating apparatus, R. Stone.....	11,183	“ regulator, C. H. White et al.....	10,856
Excavator, earth, J. F. Parlow.....	11,911	“ smoke consuming, W. Gray.....	11,090
Exhibitors, carpet, A. Peterson.....	12,001	Garments, A. N. Horner.....	11,589
Expander, tube, P. Fitzgibbon.....	11,905	“ cutting, S. J. Smith.....	11,388
Explosion, preventing boiler, D. T. Lawson.....	11,687	Gas apparatus, G. Ransdell.....	11,528
Explosive compound, A. Monnier.....	11,815	“ “ H. Lange.....	11,216
“ “ G. M. Mowbray.....	11,298	“ carburetter, W. M. Jackson.....	11,795
“ “ J. Pattison.....	11,193	“ burner, C. J. Livesey et al.....	10,561
“ “ M. Tscherner.....	11,872	“ burner, J. N. Chamberlain.....	10,911
“ “ W. H. Stanley.....	11,049	“ governors, P. Birch.....	11,236
Extinguisher, fire, A. Stoner.....	10,986	“ illuminating, C. W. Isbell.....	11,694
“ “ C. Barnes.....	11,531	“ machine, F. Pincus.....	11,844
Extractor, stump, J. Whitfield.....	11,998	“ manufacture, H. Y. Attill et al.....	10,906
“ “ W. Armstrong.....	11,295	“ process, J. Stoneman et al.....	11,949
Eye glass, A. C. Blethen.....	10,925	“ “ O. Lugo et al.....	10,865
Fabric, textile, D. C. Sumner.....	11,241	“ regulators, A. Parsons.....	10,923
Fanning mill, G. Brooks.....	11,846	“ “ G. S. Woodruff.....	11,808
“ “ J. Herson.....	11,559	“ “ J. E. Birch.....	11,002
“ “ J. R. Mitchell.....	10,801	“ “ W. B. Malcolm.....	10,802
“ “ W. McKenzie.....	11,876	“ retorts, charging coal, A. Q. Ross.....	10,997
Fastener, blind, H. M. Wells.....	11,633	“ “ discharging, “ “.....	11,403
“ glove, A. Riddell et al.....	11,442	Gate, C. Kennedy.....	11,021
“ “ R. R. Rae.....	11,962	“ G. J. Alford.....	10,781
“ “ W. H. Storey.....	11,191	“ J. H. Smyth et al.....	11,240
“ sash, J. Harley et al.....	11,105	“ J. S. Henshaw.....	10,881
“ “ J. Warren.....	11,292	“ W. G. Alexander.....	11,172
“ “ W. G. and J. L. Rawbone.....	11,373	“ W. J. Watson.....	10,868
“ bolt, E. Leslie.....	11,662	“ and door, G. W. Simons.....	11,853
“ carriage spring, R. McLaughlin.....	11,771	“ farm, F. J. Lee.....	11,003
“ for garments, C. E. Brush.....	10,819	“ “ W. Brown.....	11,201
“ seythe, G. W. Pressley.....	11,765	“ “ W. Claypool.....	11,250
“ window, J. Grant.....	11,695	“ fence, S. F. Fenn.....	10,726
Fatty matters, refining, L. G. Bertram.....	11,743	“ hanglogs, A. D. Cox.....	11,588
Faucet, T. F. Conklin.....	11,606	“ lock, T. Millette.....	11,535
“ W. M. Sack.....	11,009	“ shutter, A. Wright.....	11,297
“ beer, C. C. Redmond et al.....	11,276	“ yard or garden, R. H. Hudgins.....	11,690
“ or cock, C. A. Blessing.....	11,357	Gauge, marking and sifting, C. Kinney et al.....	11,285
Feather renovator, J. W. Batchler, jr.....	11,455	“ plane bevelling, C. Kinney et al.....	11,537
Feed water heating, D. McMillan et al.....	11,807	“ saw filing, D. Hozer.....	11,447
Feeder, carding machine, W. C. Bramwell.....	11,243	“ water, The Extension Water Gauge Co.....	12,018
Feeding apparatus, boiler, S. G. Colnfield.....	11,847	Generating electricity, C. F. Brush.....	11,631
“ device, L. A. Dodge.....	11,470	Generator, electric, W. W. Griscom.....	11,583
Felting apparatus, hat, J. T. Waring.....	11,317	“ steam, F. A. Gardner et al.....	11,658
“ hats, J. T. Waring.....	11,371	“ “ S. T. Hyde.....	11,025
“ hat bodies, J. T. Waring.....	11,376	“ “ W. A. Green.....	11,255
“ machine, hat, J. T. Waring.....	11,411	Gilding process, L. Lawrence.....	11,617
Fence, J. Brown.....	10,945	Glove fasteners, A. Riddell et al.....	11,442
“ J. Elliott.....	11,246	“ “ R. R. Rae.....	11,962
“ barbed, E. M. Crandall.....	11,079	“ “ W. H. Storey.....	11,191
“ barbing machine, D. Cary.....	11,525	Gluten, Indian corn, I. J. Bennett et al.....	11,686
“ field, G. Merritt.....	11,803	Gold depositing, E. N. Dickerson, jr.....	11,618
“ post, P. Coughlin.....	11,507	“ extraction from ore, P. G. L. G. Desgnolles.....	11,600
“ wire, J. Westgarth.....	11,879	Goods waterproof, rendering, D. M. Lamb.....	11,127
“ “ The Washburn and Moen Manufacturing Company.....	11,453 11,451	Governors, gas, P. Birch.....	11,236
Fence, wire, T. Wright.....	11,598	“ horse power, J. D. Hubner et al.....	11,663
Ferrule, tool, J. McMurphy.....	11,771	Grain conveying machine, H. D. Stover.....	11,396
Fertilizer, distributor for, R. B. Sheldon et al.....	11,431	“ pulverizing apparatus, L. S. Chichester.....	11,811
Fibre, cleaning, F. Threlfall.....	11,505	“ preparing process, J. Cornwall.....	11,855
“ decoloring, J. J. Sachs.....	11,900	“ scorers, S. T. and W. D. Elliott.....	11,462
Fibrous substances, treating, W. Courtney.....	11,570	“ scoring, D. M. Richardson.....	11,930
Files, W. F. Dini et al.....	10,831	“ separators, F. M. Bissell.....	10,715
“ paper, D. W. Lapham.....	11,209	“ “ J. Bennett.....	11,341
“ “ J. S. Shannon.....	11,657	Grate, Daniel Richmond.....	11,010
Filtering machine, G. H. Moore.....	11,259	“ Edward Card.....	11,522
Flannan saddles, canning, E. W. Potter et al.....	10,785	Grinders, R. B. Ashley et al.....	11,415
Fire engine, N. Jarvie et al.....	10,971	Grinding and purifying grain, G. Millbank.....	11,312
“ escape, C. Harlow.....	10,836	“ grain, J. Stevens.....	11,668
“ “ C. Granville et al.....	11,939	“ hollow-ware, W. W. Lake et al.....	11,218
“ extinguisher, A. Stoner.....	10,986	“ machine, knife, J. D. McEachren.....	11,098
“ “ C. Barnes.....	11,531	“ “ wood, A. Fickett.....	11,379
“ place and furnace, R. Muller.....	11,151	“ “ J. Jones et al.....	11,746
Fish way, W. H. Rodgers.....	11,271	“ mill, G. and A. Raymond.....	11,691
“ preserving, T. F. Wilkins.....	10,991	“ “ J. Dreisgaker.....	10,747
Flax scutching machine, S. S. Fuller.....	11,430	“ “ J. Rae.....	11,890
Floeces, removing, F. Breyer.....	11,191	“ “ J. Stevens.....	11,539 11,543
Flog horn, A. Jaeger.....	10,880	“ wood, S. M. Allen.....	11,629
Foot rot in sheep, curing, J. Meyers.....	10,975	Gulch, finger, A. M. Dacosta.....	11,480
Forges, &c., operating, C. Hummelmann.....	11,057	Gum refining, L. G. Bertram.....	11,743
Form for heel counters, J. Kleifer.....	11,076	Hair and skins protecting, J. Wickersheimer.....	11,987
Fountain, ornamental, R. Mylius.....	11,553	Handles, broom, D. A. Scott.....	10,873
Freezer and refrigerator, C. A. Clark et al.....	11,721	“ brush, P. Platt.....	11,167
Frog, railway, B. R. Starratt et al.....	10,982	“ cross cut saw, J. C. Dietrich.....	11,708
Fuel, combustion of, R. Muller.....	11,154	“ tool, L. H. Roberts.....	11,251
Furnace and fire place, R. Muller.....	11,151	Harness, C. S. Piersons et al.....	10,780
		“ tugs, G. K. Sutngley.....	11,613

Manure, spreading, J. S. Kemp et al.	11,119	Nut lock, D. Halpin	11,192
Marble or stone, W. H. Hoopes	10,948	" " F. J. Talbot	11,033
Mats, table, T. Mitchell	11,242	" " G. E. Facts et al.	11,200
Mattress and bed bottom, I. Mills	11,318	" " H. W. Stanton	10,840
" " spring, E. P. Fowler	11,062	" " J. Beam, et al.	11,027
" " " O. I. Bergeron	10,874	" " J. B. Robertson	11,197
Measure, dry goods, A. M. Guyton	11,940	" " J. Ford	11,243
" " grain, W. M. Dight	11,287	" " J. L. de Wolfe	11,407
" " tailor's, R. G. McLellan	11,750	Oatmeal machine, J. Quayle	10,840
Medical compound, W. Dyalpimpie	11,309	" " cooling, J. B. Armstrong	10,710
Metal bars, reducing, G. J. Capewell	11,474	" " lubricating, T. J. Gordon	11,549
" " extraction from ore, P. G. L. G. Desgignolles	11,600	" " treating, D. B. Cattamach	10,797
Meter, water, J. Lewis	10,804	Oiler, car axle, W. G. Mitchell	10,987
Microphone, A. M. Roseburgh	11,738	" " journal self, H. Gillmore	10,733
" " E. Berliner et al.	11,777	Ore - chlorinating, J. H. Mears	10,834
Middlings purifier, A. R. Gulkler	10,905	" " " The Mears' Chlorination Co.	11,012
" " " J. H. Redfield	11,340	" " metal extraction from, P. L. G. Desgignolles	11,600
" " " J. Russell et al.	10,883	" " pulverising apparatus, L. S. Chichester	11,484
" " " T. B. O-borne et al.	10,983	" " separator, J. H. Pallock	11,742
" " separator, J. W. Pyne	10,703	" " smelling iron, D. Adams	10,844
Milk cooler, L. B. Austin	10,979	" " treating process, W. Henderson	12,007
" " cream from, W. E. Lincoln	11,778	" " treatment, G. Durycce	11,100
" " creamer P. H. McEntee	11,830	" " washing machine, J. H. Wilhelm	10,984
Millstone bearing, J. W. Batty et al.	11,782	Organ, reed, G. Piggott	10,810
" " cushion, S. Keltch et al.	11,733	" " " J. E. Treat	11,974
" " dress, W. C. Hale	11,697	" " " W. Bell et al.	11,048
Mining machine, G. D. Whitcomb	11,111	Oven, bakern, G. Brnke	11,308
Moccasin ties, P. Vincent	11,070	" " " T. Hunter	10,702
Moistening atmosphere, J. G. Garland	11,511	" " " smelting, R. P. Wilson	11,375
Motion, lever rotary, H. B. L. B. & I. M. Kelper	11,180	Ozone machine, F. W. Bartlett	11,022
" " shuttle, The N. Y. Silk Manuf'g Co.	11,007	" " apparatus, F. W. and G. F. H. Bartlett	10,717
" " transmitting, C. L. French	10,051	Package, fruit, H. J. Doyle	11,791
Motor, T. Mayhew	11,128	Packing machine, brau, W. L. Williams	11,919
" " W. S. Colwell	10,809	" " piston, J. A. Osgood, et al.	11,532
" " and apparatus, W. S. Colwell	10,820	Pad for carpets, H. M. Small	10,784
" " electric, W. W. Griscom	11,583	" " " horses' hoofs, A. J. Lockie et al.	11,519
" " for locomotives, W. S. Colwell	10,815	" " " " D. C. Baker	11,173
" " machinery, J. Williams et al.	11,236	" " medicated, H. E. Hunter	10,905
" " magneto-electric, T. A. Edlson	11,857	" " sweat, F. Benoit	11,856
" " meters applicable to, J. Lewis	10,805	Padlock, W. H. McDonald et al.	11,773
Mould boards, cooling plough, H. W. Ford et al.	11,183	Pail, paper, J. A. Wood	11,979
" " car wheel, Z. S. & L. W. Washburne	11,760	Paint, enamel, H. Baines	11,900
" " casting, G. Ward	11,803	" " roof proof, H. Hall	11,004
" " for making steel, G. Cowling	11,022	" " sira, J. Butler	11,076
" " turbine, J. C. Wilson et al.	11,690	Painting roofs, P. Butler	11,043
Moulding machine, J. Ballantine et al.	11,494	Pan, bake, C. Jackson	11,704
" " " sugar, C. H. Hersey	11,159	" " dust, G. Pierce	11,640
" " in sand, W. Alkin et al.	10,952	" " " W. H. Munson	10,902
" " whitening gilt, W. E. Eastman	10,698	" " milk, C. C. Fairbank	11,288
Movement, mechanical, C. E. Patric	10,941	Paper, cabinet, B. Wheeler	11,144
" " " C. Hammelmann	11,957	" " calendaring, M. Newton	11,591
" " " D. Abrey	11,602	" " drying apparatus, N. Kaiser	11,683
" " " R. C. Barton, Jr., et al.	11,180	" " holder, S. Wheeler	11,010
" " " T. W. Easton	11,034	" " " sand, C. M. Lothrop	11,170
Mower and reaper, E. Smith	11,993	" " manufacture, A. Fickett	11,370
" " " F. J. Hayard et al.	11,094	" " or board, J. O. Gregg	11,012
" " " J. Amstutz	11,112	" " postal, W. E. Cornell	11,571
" " knives, grinding, J. W. Elliott	10,868	" " pulp, J. Foley	11,446
" " sharpening, P. Williams	11,058	" " " from wood, C. B. Carter	11,130
" " lawn, A. Jones	11,050	" " " " S. M. Allen	11,456
Mowing machine, A. Harris et al.	10,893	" " repulping, C. Coon et al.	11,089
" " " C. Taylor et al.	11,383	" " ruling, D. Mortimer	10,731
" " " D. B. Campbell	10,869	Paper-maché, imitation of, R. Cunningham	11,137
" " " E. R. Whitney	10,951	Pavement, concrete, H. Couillard et al.	11,380
" " " G. Sweet et al.	11,708	" " wood, W. H. Stow	11,859
" " " J. E. Thomas	11,345	Pens, separator for, N. Hebert et al.	11,372
" " " M. Garvin	10,820	Pent machine, F. Dodge et al.	11,650
" " " R. Eickmeyer	10,798	Pegging machine, G. W. Copeland	11,624
Musical instruments, E. P. Needham	10,981	Pen, D. Mackinnon	12,201
" " " G. H. Chinook et al.	11,219	" " and ink holder, The Mackinnon Pen Co.	11,205
" " " P. Fowler	11,509	" " holder and calender, G. W. McCready	11,083
" " " The American Automatic Organ Co	11,085	" " marking, J. W. Stokess	11,095
Nail cutter, finger, A. McDonald	11,874	" " portable, F. Green	11,003
" " cutting machine, W. Wickersham	11,722	Pencil sharpener, M. C. Stone	11,240
" " feeding apparatus, W. Briggs	11,887	Percolator, coffee, W. G. Peary	10,062
" " " device, L. A. Dodge	11,170	Petroleum, deodorising, M. J. Woodward	11,726
" " finishing, horseshoe, C. S. Watson	11,688 11,689	Photographic album, E. S. Glover	11,704
" " horseshoe, C. M. Talcott et al.	11,202	" " apparatus, T. H. Blair	11,106
" " machine, H. Moeller	11,072	" " " J. R. Mote	11,405
" " " J. G. Shaw, et al.	10,911	Photography, J. A. Fraser, Jr.	11,485
" " " feeding, W. Briggs	10,741	" " plates for, G. Eastman	10,903
" " plate, iron, T. Miller	11,885	Piano forte, C. Carothers	11,032
" " napper, boot and shoe sole, F. Winslow	11,420	" " sham holder, J. R. Adams	11,274
" " navigation, aerial, A. L. Blackman	11,065	Pier structure, C. B. Hill	11,023
" " newspaper holder, W. G. Fitch, et al.	11,874	Pile, iron box, T. Miller	11,888
" " nut and bolt lock, M. H. Grubb	11,750	Pipe, asphaltum, T. H. Walsh	11,634
" " lock, D. Duprat	11,814	" " coupling, W. J. Stevens	10,876

Pipe covering, H. Burgess	10,701	Punching machine, J. T. Bedford	11,416
" crimping machine, F. R. Packham	11,082	Purifying and grinding grain, G. Milbank	11,312
" grooving C. B. Troubridge et al	11,054	Pyroxilin, treating, O. P. Whitcomb et al	11,073
" " machine, G. P. Roseboom et al	11,672	Rack, wuggon, J. Katz	11,863
" hose, J. Bestwick	11,827	" " " S. Day	11,514
" oil injector for, J. V. and J. J. Heuchard	11,027	Radiator, R. Holly	11,233
" screw threading, J. A. Schuyler	11,170	" " steam, T. P. Hardy	11,179
" tile, &c, clay, N. L. Walker	11,034	Rail, block forming, C. A. Post	11,091
" water station stand, G. B. Van Vorst et al	10,973	" " joint, H. Williams	10,926
Pistol clamp, I. Kinney	11,040	" " " I. B. Tyng	10,920
Piston packing, G. C. Phillips	11,400	" " making, H. H. C. Slinzenich	11,025
Pitman connections, W. and A. Young	11,054	" " railway, S. W. Baldwin	11,340
Plane bevelling gages, C. Kinney et al	11,537	Raking bodies, W. Kaydt	10,878
" " metalite, W. Steers et al	11,318	Rake, hay, C. E. Henderson	11,052
Planing machine, wood, J. Ballantine et al	11,193	" " " G. H. Preston	11,071
" " wheel cogs, G. M. Holmes	10,832	" " " J. M. Oddy	11,308
Planter, seed, J. Custer	11,080	" " " J. S. Oberholtzer	11,007
Plate, enlk, J. B. Weir	11,573	" " horse, A. C. Kaiser et al	10,735
" " hammering draw, C. D. Rogers	11,121	" " " A. S. Walbridge	11,185
" " lifter, R. Hogg	10,901	" " " C. I. Corlin	11,011
Plough, H. Sanford	11,598	" " " D. Maxwell	11,787
" " H. Sanford et al	11,247	" " " J. Haggart et al	11,000
" " H. Ward, et al	11,468	" " " S. H. Bushnell	11,492
" " R. W. Phillips, et al	11,079	" " " lawn, T. D. Davis	10,811
" " T. Richardson	10,916	Range, cooking, G. R. Prowse	11,894
" " beam, H. Ward	11,165	Rattan scraping machine, G. S. Colborn	11,086
" " counter, J. Lano	10,848	Reaper and mower, E. Smith	11,093
" " gang, B. Waggoner	10,959	" " " F. J. Hazard et al	11,004
" " " J. Chapman	11,017	" " " J. Amstutz	11,112
" " " T. Govey	11,478	Reaping machine, A. C. Scarr	11,391
" " mould board, coaling, H. Ward	11,493	" " " C. Taylor et al	11,383
" " point, L. W. Hall	11,450	" " " D. B. Campbell	10,869
" " snow, F. W. and D. Hawley	11,707	" " " F. J. Craig	10,767
" " " I. L. Rosenfeld	10,009	" " " J. F. Mahon	11,198
Plunger and valve, J. Matthews	11,180	" " " J. Johnson	11,270
Pocket, safety, J. M. Hunter	11,578	" " " J. Watson	11,637
Pole, carriage, T. P. Banker	11,145	" " " N. Green	10,930
Pulling hollow wire, W. W. Lake, et al	11,218	" " " S. Crawford	11,412
Post, fence, H. M. Beecher	11,218	" " " W. Heston	11,296
" " " P. Coughlin	11,507	Reel, hose, W. Neracher	11,017
" " marking, letter, T. Leavitt	10,833	Reflector, lamp, The American Street Light Reflector Company	10,714
Potash, separating, J. Woodrum	11,308	Refrigerating Apparatus, A. J. Chase	11,671
Potato-digger, R. W. Gates et al	11,355	" " " G. F. Swift	11,536
" " picking machine, L. Lavole	11,615	Refrigerator, J. Alexander	11,269
Pot, flower, J. P. Wagner	11,718	" " " J. Sissons	11,639
Powder, blasting, C. Feltham	11,513	" " and freezer, C. A. Clark et al	11,685
" " washing, H. H. Vansickle	11,567	Registering and weighing grain, W. H. Allen	11,724
Power agent, electricity as a motive, T. A. Edison	11,097	Regulator, current, W. W. Griscom	10,882
" " electric, " " "	11,627	" " " furnace, C. H. White et al	11,583
" " manual, J. Bates	11,181	" " " gas, A. Parsons	10,856
" " trend, P. K. Dederick	11,088	" " " E. Salomon et al	10,923
Preserving organic bodies, J. Wickershelmer	11,130	" " " G. S. Woodruff	11,095
Press, elder, D. W. Wittmer	11,755	" " " J. E. Birch	11,809
" " lny, A. Montpetit	12,010	" " " W. B. Malcom	11,002
" " " F. Berrhanime	11,273	Regulus treating process, W. Henderson	10,802
" " " J. "	11,272	Reins, H. B. Powell	12,007
" " " P. K. Dederick	11,551	Resin, refining, L. G. Bertram	10,892
" " tincture, J. G. Baker	11,181	Rest, head, H. McConnell	11,713
Printing machine, E. Hely	11,521	Retorts, churning gas, A. Q. Ross	10,907
" " " R. M. Ho et al	11,044	Rigging and sails, J. H. Bloomfield	11,403
" " " chromatic, G. M. Wright	11,000	Rivet, I. E. Packard	11,496
" " stamping and embossing, J. J. Sachs	11,409	" " setting machine, M. Bray	10,775
Propelling machinery, G. E. Burt	11,508	" " tubular, G. W. Tucker	11,306
Pruning implement, C. Cole et al	11,596	" " " M. and M. N. Bray	11,499
" " " J. W. Cogswell	11,422	Roaster and drier, H. W. Booth	11,100
Pulp, bleaching, N. Kaiser	11,699	Rock drilling apparatus, H. Richmann et al	11,780
" " grinding, R. B. McPherson	10,886	Rocker and swing, B. Baker	11,725
" " wood, A. McDonald	11,172	Roller, curtain, W. B. Noyes	11,627
Pump, A. Toelner	11,566	" " gate, W. Schwendler et al	10,701
" " C. Powell	11,018	" " land, H. and J. W. Follott	11,029
" " G. W. McKenzie	11,436	" " " J. A. Kuppelhm	10,718
" " J. Shupe	11,466	" " matting, G. H. Longmore	11,395
" " J. A. McMartin	11,066	" " printing, J. J. Sachs	11,077
" " J. Hoover et al	11,761	" " wledow curtain, N. H. Shaw	11,488
" " J. Morlock	11,084	Rolling machine, J. H. Whitney	11,177
" " L. C. Abbott	11,407	Roofing, iron, G. B. Thomas	11,512
" " M. W. McCortney	11,055	Roof, car, J. C. Wands	10,700
" " S. Buschlen	11,305	" " painting, P. Butler	11,043
" " W. M. Wilcox	11,046	Roofs, trusses for bridges and, E. Wasell	11,786
" " W. S. McLeod	11,800	Safe, kitchen, G. W. Read	10,956
" " beer, J. A. Gaudron	11,747	Sails and rigging, J. H. Bloomfield	11,413
" " brake, W. H. Cloud et al	11,362	Salve for sores, J. Myers	10,864
" " combination, F. Crocker, sr	11,917	Sand-paper holder, C. M. Lotthrop	11,170
" " diaphragm, J. Edson	11,678	Sap spout, Z. S. and H. A. Lawrence	11,924
" " force, A. Barrow	11,302	Sash clamping machine, W. Abercrombie	11,934
" " lifting, E. Barnes	10,955	" " cord guides, E. H. N. Clarkson	10,837
" " plunger, J. Matthews	11,489		
Punches, metal, D. Kennedy et al	10,928		

Sash, fastener, J. Harley, et al.....	11,405	Sickles, holder for, A. B. Dowell.....	11,102
" " J. Warren.....	11,292	Sifter, coal, W. W. Whitaker.....	10,950
" " W. G. and J. L. Rawbone.....	11,373	Sign, street, E. J. Hardy.....	11,822
" holder, J. Payne.....	11,078	" transparent, H. Child.....	11,085
" support, A. Richardson.....	10,870	Signal electric, F. Blake, Jr.....	10,792
" supporter, W. W. Sweetland.....	11,037	" railway, A. F. Martel.....	11,093
Saw, W. L. Earling.....	11,191	" " J. I. Conklin.....	10,725
" cross-cut, A. Wilkins.....	11,304	Signalling apparatus, G. L. Anders.....	11,230
" filing gauges, D. Horner.....	11,447	" " F. L. Pope.....	11,518
" guide, G. W. Rolebaugh.....	11,912	" " W. Robinson.....	11,617
" gummer, S. H. Stepp.....	11,226	" instrument, T. T. Eckert et al.....	11,906
" hand drag, S. Annett.....	11,972	Skates, G. McCord.....	10,817
" handle, cross-cut, J. C. Dietrich.....	11,715	Skelping machine, iron, J. Howen.....	11,081
" mill, D. C. Prescott.....	11,311	Skin and hair, protecting, J. Wickersheimer.....	11,587
" " J. H. Watson, et al.....	11,409	Skylights, F. M. Campbell et al.....	11,716
" " D. Cilley.....	11,811	Slat, school, W. Bryce.....	11,101
" " dog, H. McQuarry.....	11,113	Sleds, J. H. Dennis.....	10,742
" " J. M. Stowell.....	11,772	" " L. R. Dexter et al.....	11,072
" " head block, B. E. Sargent.....	10,728	Sleigh, A. B. Webster.....	12,002
" " " " L. W. Pond.....	11,959	" " T. Buckingham.....	11,935
" tempering process, R. H. Smith.....	11,855	" clutches, J. Boydell.....	10,909
Sawing machine, A. H. Shipman.....	12,008	Slicing machine, T. & M. M. Witmer.....	10,901
" " D. P. Proctor.....	11,263	Soap, fluid, C. J. Geier et al.....	11,291
" " D. S. Van Wyck.....	11,278	" manufacture, S. Strunz.....	11,718
" " W. W. Bostwick.....	11,010	Sock supporter, C. E. Brush.....	10,768
Scale, removing boiler, A. S. Vliet et al.....	11,901	Sole machine, Inner, M. A. C. Holmes.....	10,723
" spring, C. C. and S. B. Parker.....	11,081	" napper, boot and shoe, F. Win.....	11,129
" weighing, H. H. Ham, Jr, et al.....	10,744	Soup compound, J. F. Tyrrel.....	11,912
Scorer, grain, S. T. and W. D. Elliott.....	11,462	Sower, broad cast, W. Smith.....	11,965
Scores for excavating, R. Stone.....	11,183	" grain, J. S. Bogie.....	10,847
Scraper, road, F. W. Schultz.....	11,558	" seed, J. A. Allison.....	10,921
Screens, revolving, L. J. Bennett.....	10,899	" " J. W. Mann.....	10,922
" window, G. Hartig.....	10,879	" salt, J. Harrison et al.....	11,671
Screw, A. C. ...ings.....	11,184	Spade and shovel, H. M. Whitney.....	10,995
" cutting die holder, R. Mitchell.....	11,925	Spark arrester, E. F. E. & C. W. Leonard.....	10,703
" machine, C. M. Spencer.....	11,126	Spavins, instrument for, J. H. Ellis.....	10,918
" threads, cutting, I. S. Schuyler.....	11,476	Spikes, cant hand, A. Hunter.....	11,397
Scrubber, hand, H. A. Ste Marie.....	10,823	" railway, J. P. Perkins et al.....	11,902
Scutching machine, C. Ethier.....	11,005	Spinning machine, S. Vigeant et al.....	11,728
" flax, S. S. Fuller.....	11,391 11,490	Spittoon, C. E. Pearson.....	12,005
Scuttle, coal, O. Eisenhuth.....	10,963	Splash board, J. B. Armstrong.....	11,128
Seythe fastening, G. W. Pressey.....	11,765	Spool manufacture, C. E. Burns.....	11,410
" snathe fixtures, S. Hayward.....	10,785	Spring and wheel, car, J. Findlay.....	11,932
Seat, boat, A. McFarren et al.....	11,837	" bed, W. Jones.....	10,750
" " O. L. Hicks.....	11,666	" car, A. B. Davis et al.....	10,771
" car, N. B. Sherwood.....	11,013	" " A. Middleton.....	11,617
" vehicle, J. B. Armstrong.....	11,030	" carriage, A. B. Webster.....	12,003
Secretary and sewing machine, H. E. Caulfield et al.....	11,158	" " C. F. Shoemaker.....	10,966
Sectors, cross, G. J. O'Doherty.....	10,936	" " S. W. Ludlow.....	11,364
Seed planter, J. Custer.....	11,086	" colling, . Anderson.....	11,822
Seeder and cultivator, H. Springer.....	11,804	" fastening, carriage, R. McLaughlin.....	11,774
Seeding machine, J. W. Mann.....	10,922	" locomotive, C. C. Hearle.....	11,597
Semaphores, railway, J. Nesbitt.....	11,202	" vehicle, G. B. Hamlin.....	11,753
Separator, cockle, H. Stevens.....	11,626	" " H. M. Keith et al.....	11,459
" for peas, N. Hébert et al.....	11,372	" " J. J. Cobb.....	10,872
" grain, J. A. Krake.....	12,013	" wagon, W. G. Hughes.....	11,830
" " J. Bennett.....	11,544	" wire, N. Jenkins.....	11,311
" " J. W. Morrison et al.....	11,097	Stamp affixing machine, W. Rushmer.....	11,2-7
" " N. Smith.....	11,955	Stamping machine, J. T. Bedford.....	11,416
" ore, J. H. Paddock.....	11,742	" printing and embossing, J. J. Sachs.....	11,499
" " W. L. Imlay.....	11,913	Stand, barrel, L. D. West.....	10,890
Sewer trap, E. B. Ward.....	11,918	" drying, C. Wright et al.....	11,050
Sewing machine, C. F. Bosworth.....	11,161	Starch, Indian corn, L. J. Bennett et al.....	11,686
" " C. L. Kellogg.....	11,958	Stave bevelling machine, J. Clancy.....	11,201
" " F. Jacob.....	11,696	" dressing " H. H. Miller.....	11,196
" " J. C. Blackett.....	10,767	Steamer, feed, M. B. Mills et al.....	11,292
" " J. Heberling et al.....	11,414	Steel tempering, J. B. Armstrong.....	10,710
" " J. Keith.....	11,973	St. p, carriage, F. A. Sawyer.....	11,147
" " J. McAlistier.....	11,855	" ladder J. N. Vallery.....	11,169
" " J. M. Fair.....	11,411	Stereocopy camera, W. Harris.....	10,996
" " R. M. Wanzer.....	10,778	Strapp, saddle, D. B. Couboy.....	11,861
" " S. Y. Love.....	10,690	Stock, bit, O. Peck.....	11,793
" " W. M. Smith.....	10,988	Stone cutting machine, S. B. Frank et al.....	11,750
" and secretary, H. E. Caulfield et al.....	11,151	" or marble, W. H. Hoopes.....	10,945
" thread, L. F. rug.....	11,775	Stopper and bottle, H. Barrett.....	11,723
Shaft bearer, G. R. Swingley.....	11,613	" bottle, J. C. Schaffer.....	11,504
Shaping and bending machine, J. B. Armstrong.....	10,883	" " M. W. Patten.....	11,213
Sharpening pencil, M. C. Stone.....	11,219	" chain, D. N. B. Coffin et al.....	11,873
Shearing machine, J. T. Bedford.....	11,414	Stove, F. & J. Moses.....	11,421
Sheep, curling foot rot in, J. Meyers.....	10,975	" P. L. Jole.....	10,896
Shelf and drier, The Hamilton Industrial Works Co'.....	11,021	" and utensils, G. Robinson.....	11,075
Shingle edging machine, F. J. Drake.....	11,473	" cooking, C. Carpenter et al.....	11,171
Ships' bottom protecting, R. H. Seaton et al.....	11,321	" dumb, W. C. DeWidge.....	11,148
Shoe, C. M. Lee.....	11,327	" heating, A. Bettes.....	11,798
" " G. Botwin.....	11,389	" " O. W. Noble et al.....	12,010
" stay, C. E. Whittlesy et al.....	11,659	" " W. & J. W. Buck.....	11,316
Shovel and spade, H. M. Whitney.....	10,995	" oil, D. E. Baugs.....	11,851
Shuttle motion, The N. Y. Silk Manufg Co'.....	11,067	" " R. F. Carter et al.....	11,957

Stove pipe, H. M. Wells et al	11,584	Trusses, bridge, S. R. Holt	11,370
“ “ elbow, H. S. & C. Hoeler	10,904	“ “ and roof, E. Wasell	10,798
“ “ stone, H. Wandby	11,752	Tube expander, P. Fitzgibbons	11,905
“ “ thimble, N. D. Morey	11,262	Tunnelling, rock, H. N. Penrice	11,623
Straw cutter, D. Maxwell	11,810	Turbine, J. H. Staples	11,692
“ “ H. S. Havill	11,843	“ “ mould, J. C. Wilson et al	11,699
Strips, weather, G. W. Bell	11,673	“ “ water, J. C. Wilson	11,700
Structure, wharf, etc., C. E. Hill	11,923	Turning machines, wood, F. Hanson et al	11,143
Stud, lacing, M. Bray	10,835	“ “ tools, wood, F. Hanson et al	10,972
Stump extractor, J. E. Trotter	10,908	Twisting machine, yarn, J. Coltham	10,985
“ “ machine, B. H. Davis	11,106	Type setting and distributing apparatus, F. Wicks	11,881
“ “ puller, T. Naramore	11,070	“ “ “ “ machine, J. Thorne	11,824
Sugar, malt, J. H. Nottorf	11,001	“ “ writers, A. M. DaCosta	11, 80
“ “ moulding machine, C. H. Hersey	11,159	Upspitting machine, iron, F. R. Duoue et al	11,781
“ “ washing process, J. W. Boornen	11,755	“ “ tire, D. Feindel	11,776
Suspenders, pantalon, H. & W. Turner	10,830	Utensils and stoves, G. Robinson	11,075
Sweeper, carpet, H. S. Wing	11,515	Valise, W. C. Croford et al	11,342
Sweeping machine, chimney, J. B. Rouillard	11,092	Valves, B. N. Stuart et al	10,887
Swings, A. B. Harmon	11,215	“ “ M. Morton	10,949
“ “ and rockers, B. Baker	11,725	“ “ W. White	11,420
“ “ barrel, P. W. Nelson	11,189	“ “ W. Wilson	11,437
“ “ pleasure, W. F. Phillips	10,861	“ “ and cocks, steam, J. Mathison	11,848
Switch, railway, C. E. Laroque et al	11,730	“ “ plungers, J. Matthews	11,489
“ “ C. S. Bastright	10,858	“ “ balance, J. Livingstone et al	11,649
“ “ J. B. Carey	11,141	“ “ slide, E. Robinson et al	11,381
Tables, extension, J. D. Bras-ington	10,897	“ “ cylindrical, F. Winters, jr	11,356
“ “ O. S. Garratton	11,928	“ “ for water closets, T. Henney	11,969
“ “ for vessels, dining, J. H. Laskey et al	11,833	“ “ rod support, J. A. Osgood et al	11,368
Tank for fluids, A. W. Schulerberz	10,993	“ “ rotary, C. J. McCallum	11,786
“ “ oil, S. Webster	11,797	“ “ safely, F. B. Seovell	11,166
“ “ railway, J. D. Craig	10,812	“ “ H. G. Ashton	11,789
Tanning hides and skins, F. G. Vedova	11,790	“ “ steam, J. Morrison	11,870
“ “ “ “ J. Foley	10,711	Vegetable substances, preserving, J. M. Reid	10,990
“ “ process, H. Trenk et al	11,586	Vehicles, D. Conboy	10,751
“ “ “ “ S. Ullmo	10,958	“ “ M. Schmidt et al	11,209
Target, ball, C. V. Boughton	11,115	“ “ P. Herdie	11,212
Telegraph and telephoue, T. A. Watson et al	11,330	“ “ fifth wheels for, C. G. Wells	10,752
“ “ cable, M. M. Manly et al	11,161	“ “ spring, G. White	11,946
“ “ multiple, A. Muirhead et al	11,152	Velocpede, A. Vick	11,651
Telegraphic conductor, C. E. Chinnock	10,974	“ “ G. W. Pressey et al	11,852
Telegraphy duplex, A. Muirhead et al	10,921 11,150	Ventilating apparatus, D. Groesbeck	11,866
Telephone, A. M. Roseburgh	11,738	Ventilators, car, W. P. Williamson	10,720
“ “ C. Williams, jr	11,251	“ “ house, W. S. Sayers	11,036
“ “ F. A. Klemm et al	11,234	Vessel, nerlin, A. L. Blackman	11,065
“ “ F. Shaw	10,876	“ “ steam, A. Olsen	11,894
“ “ G. H. Biss	11,253	Vice, F. C. Zanetti	11,869
“ “ G. L. Anders et al	11,277	Violins, etc., P. Fowler	11,509
“ “ M. D. Donnelly et al	11,751	Wagon gears, B. C. Shaw et al	10,881
“ “ R. M. Lockwood et al	11,576	“ “ road, J. L. Phillips	11,492
“ “ T. A. Watson	11,575	Wardrobe cabinet, E. E. Goyer	11,736
“ “ W. A. Childs	11,580	Ware, polishing hollow, W. W. Lake et al	11,218
“ “ and telegraph, T. A. Watson et al	11,330	Washboards, E. A. Kitzmiller	11,114
“ “ electric, A. M. Bell et al	10,705	“ “ F. B. Howard	11,873
“ “ “ “ W. F. Cook	11,574	Washer and churn, C. D. Van Allen	11,548
Telephonic conductor, C. E. Chinnock	10,974	“ “ “ “ vringer, A. Atkinson	11,741
Thill couplings, J. Jacoby	10,953	“ “ “ “ A. W. & A. L. Burke	11,755
Thimbles, stove pipe, N. D. Morey	11,262	“ “ clothes, W. N. Wylie	10,976
Thrusting machine, F. Kitten	10,694	“ “ dish, B. J. Howe	11,914
“ “ “ “ G. Culham	11,282	“ “ spring, J. W. Grover	11,594
“ “ “ “ G. S. Tuompson	11,833	Wa hing machine, C. N. White	11,366
“ “ “ “ J. Golden	11,096	“ “ “ “ H. Mounsey	11,574
“ “ “ “ J. Paradis et al	11,360	“ “ “ “ J. C. Smith	11,777
“ “ “ “ R. H. Montelth et al	10,729	“ “ “ “ J. G. Walker	11,381
“ “ “ “ T. Armstrong	11,078	“ “ “ “ J. H. Connor	11,901
“ “ “ “ T. Venuling	11,092	“ “ “ “ J. Mason	11,003
Thread, sewing, L. Flagg	11,775	“ “ “ “ S. T. Address	11,758
Tie, moccasin, P. Vincent	11,670	“ “ “ “ W. Church	11,760
Tile and brick machine, A. Whalen	11,020	“ “ “ “ ore, J. H. Wilhelm	11,984
“ “ pipe, etc., clay, N. U. Walker	11,934	Watch, stop, H. A. Lugin et al	12,009
Timber preserving, W. Thillmay	11,621	Water closets, W. B. Malcolm	11,168
Tire upspitting machine, D. Feindel	11,776	“ “ raising, G. H. Bennett	11,136
“ “ wheel, L. Bredannaz	11,652	“ “ supply system, N. W. Green	11,770
Tongs, pipe, C. H. Lovrien	11,709	Waterproof, rendering goods, D. M. Lamb	11,124
Tool-holders, L. Young et al	11,479	Wax refining, L. G. Berran	11,743
“ “ wood turning, F. Hanson et al	10,972	Weather strips, G. W. Bell	11,673
Top, carriage, G. A. Rudd	11,999	Weighing and registering grain, W. H. Allcu	10,882
“ “ “ “ The Guelph Carriage Goods Co	11,009	“ “ “ “ machines, J. B. Stoner	11,261
Traces, making cock eyes of, J. Brayley et al	10,761	“ “ “ “ J. W. Hill	11,293
Traps, animal, O. Carss	10,818	Well draining, T. Gervais	11,892
Trap, plumbers, C. S. Watson et al	11,896	Wharf structure, C. E. Hill	11,923
“ “ sewer, E. B. Vard	11,948	Wheat reducing machine, J. Mills	11,387
Treadmill wove machine, J. Lennerton	10,776	Wheels and springs, car, J. Findlay	11,932
Tricycles, E. C. F. Otto	11,023	“ “ car, F. A. Fouts et al	10,892
Truck and bag-holder, B. Wilt	11,868	“ “ “ “ G. W. Sweet	10,838
“ “ car, J. J. Thomas et al	11,074	“ “ carriage, J. Biall et al	10,917
“ “ “ “ S. Keeler et al	11,393	“ “ emery, J. T. Bernard	11,245
“ “ hand, M. Johnson	10,695	“ “ fly, H. Baldwin	11,363
Trusses, L. T. J. Lubin	11,220	“ “ for vehicles, fifth, C. G. Wells	10,752

Wheels manufacture, W. Newlin.....	11,835	Argall, J., feed water heaters.....	11,947
“ mould, car, Z. S. & L. W. Washburn.....	11,769	Armstrong, J. B., oil cooling.....	10,710
“ planing the cogs of, G. M. Holmes.....	10,832	“ splash-board.....	11,016
“ spinning, F. Vézina.....	10,087	“ vehicle seats.....	11,030
“ water, C. H. Parker.....	10,843	“ T, thrashing machine.....	11,978
“ J. A. Davis.....	11,719	“ W, stump extractors.....	11,295
Whippletrees, D. Foley.....	11,252	Arno, O. H., musical instruments.....	11,685
“ T. T. Pearson et al.....	11,031	Arnold, U. K., et al, rock drilling apparatus.....	11,780
“ clip, J. H. Harford.....	11,871	Arthur, C. M., paper boxes.....	10,950
Whiskey aging, G. Gouwey et al.....	11,680	“ C. M., et al, paper boxes.....	11,721
“ process, M. J. Allen et al.....	11,533	Ariz, J., et al, cabinet and bed.....	11,026
Whitewash composition, J. G. McHenry.....	11,585	Ashby, R. B., et al, grind rs.....	11,415
Windmills, H. Helmla et al.....	11,821	Ashton, H. G., safety valve.....	11,789
“ J. Roy-Desjardins.....	11,980	Atkinson, A., washer and wringer.....	11,731
“ N. Prince.....	11,616	Atrill, H. Y., et al, gas manufacture.....	10,906
“ T. Dewees.....	11,199	Austlin, L. B., milk coolers.....	11,059
“ W. Forbes.....	10,753	Axford, H. W., incubators.....	11,877
Winding machine, yarn, J. Coltham.....	10,985	Babcock, G. H., et al, steam boiler.....	11,705
Window fastening, J. Grant.....	11,695	“ steam engine.....	11,712
Wire drawing machine, C. D. Rogers.....	11,612	Bacon, D. H., et al, wood turning tools.....	10,972
Wood decorating, S. K. Devereux.....	11,929	“ D. M., et al, “ machines.....	11,143
“ grinding, S. M. Allen.....	11,107	Baines, H., elastic paint.....	10,906
“ machines, A. Fickett.....	11,379	Baker, D. C., pads for horses' hoofs.....	11,173
“ paper pulp from, C. B. Carter.....	11,139	“ B., swings and rockers.....	11,725
“ planing machines, J. Ballantine et al.....	11,193	“ F. P., whitening gilt moulding.....	10,678
“ poling machines, A. Bridgeman et al.....	11,399	“ J. G., tincture press.....	11,481
“ turning machines, F. Hanson et al.....	11,143	“ L. J., rotary engines.....	11,217
“ tools, F. Hanson et al.....	10,972	Baldwin, H., fly wheel.....	11,363
“ working machine, A. Laling.....	11,015	“ S. N., railway rail.....	11,310
Wringer, J. Lottridge et al.....	11,983	“ W. H., churn.....	11,040
“ and washer, A. Atkinson.....	11,781	Ballantine, J., et al, moulding machines.....	11,491
“ “ A. W. & A. L. Burke.....	11,755	“ wood planing machines.....	11,493
“ clothes, B. Hershey.....	11,536	Ballard, C. T., et al, grinding machine.....	11,746
“ “ J. W. Catef et al.....	10,854	Ballatschno, J. & C., et al, tanning process.....	11,586
“ “ R. Dudley et al.....	11,561	Ballon, F. D., inner sole machine.....	10,723
“ mop, A. L. Burik et al.....	11,710	Balmer, T., tobacco packing box.....	11,729
Wringing machine, J. Reidy.....	11,925	Bangs, D. E., oil stoves.....	11,851
Writers, type, A. M. DaCosta.....	11,480	Banker, T. P., carriage poles.....	11,145
Writing reproducing, A. Ungerer.....	10,719	Baragwanath, W., feed water heaters.....	10,807
Wrenches, C. Saiter.....	10,912	Barclay, P., lubricators.....	11,175
“ F. S. Gilbert.....	11,517	Barlow, C., fire escapes.....	10,836
Yarn, cotton, T. H. Dunham.....	11,430	Barnard, J. T., emery wheels.....	11,248
“ winding machine, J. Coltham.....	10,985	Barnes, C., fire extn gulsher.....	11,531
Yoke, neck, C. C. Keene.....	11,817	“ E., lifting pumps.....	10,955
“ “ F. Jacques.....	12,000	“ T., bean pickers.....	10,732

INDEX OF PATENTEES.

Abbott, L. C., pump.....	11,497	Barrett, H., bottles and stoppers.....	11,723
Abel, W. H., et al, knitting machines.....	11,203	“ W., straw cutters.....	11,843
Abercrombie, W., sash clamping machine.....	11,631	Barrie, R. C., jr., et al, mechanical movements.....	11,180
Abrov, D., mechanical movement.....	11,602	Barrow, A., force pumps.....	11,393
Adams, D., smelting iron ores.....	10,841	Bartelo, W. H., rocking chair.....	11,831
Adams, J. H., pillow holders.....	11,274	Bartlett, A., car couplings.....	11,515
“ L. B., et al, repaling process.....	11,069	“ E. A., et al, heating stoves.....	12,010
Aikin, W., et al, moulding in sand.....	10,952	“ F. W., ozone machine.....	11,922
Aidred, F., churn.....	11,198	“ “ & O. F. H., ozone apparatus.....	10,717
Alexander, J., refrigerator.....	11,639	“ J., turnip harvesters.....	10,740
“ W. G., gates.....	11,472	“ J. H., et al, mail bags.....	11,560
Alford, G. J.,	10,781	“ S. H., et al, telephone.....	11,590
Algar, I. F., horse hitchers.....	11,977	Bastright, C. S., railway switches.....	10,818
Allsopp, M., copying apparatus.....	11,299	Batchelder, F. B., leather finishing machines.....	11,325
Allen, H. H., fence gates.....	10,726	Bates, D. H., et al, electric signalling.....	11,966
“ M. J., et al, whiskey process.....	11,533	“ J., manual powers.....	11,181
“ S. M., paper pulp from wood.....	11,456	“ S. A., elevators.....	10,795
“ wood grinding.....	11,107	Batty, J. W., et al, lubricating bearing.....	11,782
“ W. H., weighing and registering grain.....	10,882	Baxter, L., flour bolting machine.....	11,784
Allis, A. G., et al, oil stove.....	11,957	Beann, J., et al, nut locks.....	11,027
Allison, J. A., seed sowers.....	10,921	“ milk cooler.....	11,694
American Automatic Organ, The, musical instrument.....	11,685	Beaumont, F. E. B., air engine.....	11,801
American Street Light Reflector Co'y, The, lamp reflectors.....	10,714	Béhard, A. M., et al, car coupler.....	11,352
Ames, G. H., et al, car coupling.....	11,897	Becktel, C. J., et al, mail bags.....	11,845
Amor, J., hose coupling.....	11,669	Bedford, J. T., shearing machines.....	11,416
Amstutz, J., reapers and mowers.....	11,112	Becher, H. M., fence posts.....	10,716
Anders, G. L., signalling apparatus.....	11,230	Béanger, N., et al, removing boiler scale.....	11,961
“ telephones.....	10,853 11,254	Bell, A. G., electric telephones.....	10,705
Anderson, C. E., lay rake.....	11,277	“ A. M., et al, electric telephones.....	10,705
“ J., spring colling machine.....	11,623	“ G. W., weather strips.....	11,673
Andrews, S. T., washing machines.....	11,753	“ W., et al, wax refining.....	743
Andrews, F. W., clothes dryers.....	11,223	“ W. R. W., Reed organs.....	11,048
“ J., earth car.....	11,721	Bennett, G. H., water raising.....	11,136
“ J. W., cabinet and bed.....	11,026	“ J., grain separator.....	11,344
Annett, S., hand drag saw.....	11,972	“ L. J., revolving screens.....	10,899
Angus, R., spark arresters.....	10,703	“ et al, Indian corn starch.....	11,686
Appleton, E., cultivator.....	11,709	“ W. W., et al, musical instruments.....	11,219
		Benoit, F., sweat pad.....	11,856
		Bergeron, O. J., spring mattresses.....	10,895
		Berliner, E., et al, microphones.....	11,737
		Berthlaume, F., bay presses.....	11,273
		“ J., “.....	11,272
		Bertram, L. G., wax refining.....	11,743

Best, J., iron harrows.....	11,110	Brooks, J. W., heel machine.....	11,337
“ “ wrenches.....	10,912	“ “ “ “.....	11,338
Bestwick, J., hose pipe.....	11,827	“ “ “ “.....	11,339
Bettes, A., heating stove.....	11,798	Broome, L. H., lathes.....	11,619
Beyster, H. B., et al., slide valves.....	11,384	Brown, A. E., hoisting machines.....	11,937
Bleckham, Y., et al., binding machine.....	11,081	“ A. J., et al., horse shoes.....	10,754
“ “ drying stands.....	11,080	“ E. A., et al., pillow sham holders.....	11,574
Bleknell, E. O., envelopes.....	11,555	“ H. et al., ringing alarm bells.....	10,740
Blotlow, E. W., corset.....	11,307	“ H. H., sad iron heating machine.....	11,526
Billings, J. D., horse shoe.....	11,265	“ J., fences.....	10,915
Blrch, J. E., gas regulator.....	11,002	“ W., farm gates.....	11,204
“ P., gas governors.....	11,236	Brush, C. E., fastening for garments.....	10,819
Birs, N. A., et al., thrashing machine.....	11,360	“ “ sock supporter.....	10,768
Biscell, F. M., grain separators.....	10,715	“ C. F., generating electricity.....	11,631
Bisackhall, E. W., hydraulic machinery.....	10,916	Bryce, W., school shales.....	11,101
Blackett, J. C., sewing machines.....	10,767	Bryden, G., horse shoes.....	10,839
Blackman, A. L., aerial vessel.....	11,065	Buck, W., and J. W., heating stove.....	11,316
Blain, T. H., photographic apparatus.....	11,105	Buckingham, T., sleigh.....	11,935
Blais, F. X., milk cooler.....	11,941	Buckhout, W. K., ammunition cases.....	10,756
“ J., et al., carriage wheels.....	10,917	Bullock, W. R., et al., cooling plough mould boards.....	11,483
Blake, F. Jr., electric signals.....	10,792	“ “ ploughs.....	11,448
Blaydes, E. & J. A., et al., hafting cutlery.....	11,157	Bumpus, D. H., et al., lubricating oil.....	11,549
Blesing, C. A., tucet or cock.....	11,357	Bunger, M. E., et al., harrows.....	11,235
Blithen, A. C., eye glasses.....	10,925	Burgess, E. W., et al., nut lock.....	11,027
Bliss, G. H., telephones.....	11,253	“ H., pipe covering.....	10,794
Block, W. T., et al., iron manufacture.....	11,988	Burke, A. W. and A. L., washer and wringer.....	11,755
Bloomfield, J. H., flagging and sails.....	11,442	Borns, C. E., spool manufacture.....	11,410
Bloord, T., et al., glove fasteners.....	11,203	Burpee, W. M., et al., manure spreading.....	11,149
Boardman, H. W., et al., knitting machine.....	11,792	Burritt, E., dentist's chair.....	11,640
Boeckh, C., brush.....	10,847	Burl, G. E., propelling machinery.....	11,568
Bog'e, J. S., grain sowers.....	11,389	“ R. F., et al., slide valves.....	11,710
Bolvin, G., shoes.....	11,915	Burris, A. L., et al., mop wringers.....	11,805
Bonner, F. J., et al., artificial manure.....	11,676	Buschlen, S., pumps.....	11,071
Bonner, J. J., et al., bolting machine.....	11,512	“ S., et al., lock latches.....	10,900
Bonsack, J. A., cigarette machine.....	11,963	Bush, J. D., door bolts.....	11,482
Boone, D., et al., blacking brush.....	11,785	Bushnell, S. H., horse rakes.....	11,435
Booraem, J. W., sugar washing process.....	11,100	Butcher, J. W., Jr., feather renovators.....	11,976
Booth, H. W., driers and roasters.....	11,457	Butler, J., roof paint.....	11,043
Bortree, M. K., corset.....	10,927	“ P., “ painting.....	10,854
Boswell, J. K., heating apparatus.....	11,404	Cable, A. D., et al., clothes wringers.....	11,671
Bo-twick, W. W., sewing machines.....	11,161	Caister, C., et al., salt sower.....	11,890
Bo-worth, C. F., “ “.....	11,115	Calcutt, H., churn.....	11,823
Boughton, C. V., ball targets.....	11,788	Calof, J. W., et al., clothes wringers.....	10,854
Bowen, E. R., et al., car coupling.....	11,875	Cameron, D., moulding machine.....	11,494
“ J. S., et al., evaporators and driers.....	10,709	“ “ wood planing machines.....	11,493
Bowers, S. J., horse collars.....	11,072	“ “ B. et al., gates.....	11,210
Bowker, B. A., et al., sleds.....	11,931	Campbell, D., mowing machines.....	10,869
Boyd, A., et al., boots and shoes.....	11,735	“ F. M., et al., skylights.....	11,718
“ W. A., fruit ladder.....	11,943	“ J., churns.....	10,736
Boys, H. R. A., oil cup.....	11,507	“ J. L., incubators.....	10,808
“ “ et al., feed water for steam boilers.....	11,217	“ T., compression cocks.....	10,811
“ “ ploughs.....	10,900	Capewell, G. J., reducing metal bars.....	11,434
Boydell, J., sleigh clutches.....	11,031	“ et al., horse shoe nails.....	11,820
Boyer, R., et al., whiffletrees.....	11,460	Card Automatic Brake Co., The, car brakes.....	11,099
Bradley, C. C., harvesters.....	10,960	“ “ “ “ “ steam brakes.....	10,942
“ E., purifying bark extracts.....	11,167	“ E., grates.....	11,522
“ H. A., liquid fuel burners.....	11,385	“ W. L., car brakes.....	10,909
“ H. C., oil cans.....	11,577	“ “ steam brakes.....	10,942
“ J., et al., knitting machines.....	11,533	Carey, J. B., railway switches.....	11,367
“ W. E., et al., whisky process.....	11,303	Carndichael, D. Jr., horse powers.....	10,825
Brake, G., bykers' ovens.....	11,213	Caruthers, C., piano forte.....	11,632
Bramwell, W. C., carding machine feeder.....	10,897	Carpenter, C., et al., cooking stove.....	11,171
Braxington, J. D., extension tables.....	11,443	“ J., wagon brakes.....	11,300
Bray, M., boots and shoes.....	11,575	Carson, H. A., hoisting apparatus.....	11,186
“ “ boot and shoe hook.....	10,835	Cars, O., animal traps.....	10,813
“ “ lacing stud.....	10,775	Carte, C. B., paper pulp from wood.....	11,130
“ “ machine for setting rivets.....	11,836	“ R. F., et al., oil stove.....	11,957
“ “ shoe lace hook.....	11,440	Carey, A., fence barbing machine.....	11,525
“ M. & M. N., tubular rivets.....	10,850	Castle, S. B., hay loading machine.....	10,874
“ W., fastening carpets.....	10,761	Caswell, E., hub borers.....	11,221
Brayley, J., et al., cock eyes of traces.....	11,632	Cattanach, D. D., oil treating.....	10,797
Brednanz, L., wheel tire.....	11,785	Caulfield, H. E., et al., secretary and sewing machine.....	11,153
Brent, N. F., et al., car coupling.....	10,734	Chadwick, W. T. and J., et al., sulphate of alumina.....	10,858
Brewer, R., anti-friction journal boxes.....	11,040	Challoner, G. N., car couplers.....	11,120
“ W. S., sawing machines.....	11,564	Chamberlain, B., grain binders.....	10,914
Breyer, F., removing feces.....	11,399	“ J. N., gas burners.....	11,094
Bridge-man, A., et al., wood polishing machine.....	11,151	Chapleau, S. E. St. O., et al., car brakes.....	11,047
Briggs, J. A., et al., duplex telegraphy.....	11,152	Chapman, J., gang ploughs.....	11,909
“ “ multiplex telegraphs.....	10,741	“ J. A., carriage top.....	11,571
“ W., nail feeding machine.....	11,886	Chase, A. J., refrigerating apparatus.....	11,826
Brin, Q. L., light and heat production.....	10,866	Chatwin, A., chuck.....	11,825
Brimme'l, A. H., cheese manufacturing.....	11,624	“ “ screw cutting die holder.....	11,961
Brock, M., et al., pegging machine.....	11,846	Chevassé, A., et al., removing boiler scale.....	11,045
Brooks, G., fanning mills.....	11,334	Cherry, J. G., milk cans.....	11,180
“ “ “ “.....	11,335	Chesnut, J. H. W., et al., mechanical movement.....	11,484
“ “ “ “.....	11,336	Chichester, L. S., ore pulverizing apparatus.....	11,619
“ “ “ “.....		Childster, F. B., et al., lathes.....	

Child, H., transparent signs.....	11,085	Culham, F., buggy hubs.....	11,028
Childs, W. A., telephone.....	11,550	" G., thrashing machine.....	11,282
Chinook, C. E., telegraphic electrical conductor 10,971	10,978	" F., vehicle hubs.....	11,823
" G. H., et al., musical instruments.....	11,219	Cummings, A., screws.....	11,181
Chubb, F. J., line kiln.....	11,908	Cunningham, A., saw mill cog.....	11,772
Church, H. A., hatching hook.....	11,655	" R., imitation of papier maché.....	11,157
" R., long leg boots.....	10,708	Curlice, J. F., car brake.....	11,620
" W., washing machines.....	11,760	Custer, J., seed planters.....	11,088
Cilly, D., saw mills.....	11,811	Cutler, W. P., car-coupling.....	11,332
Clancey, J. and C. M., stave bevelling machine.....	11,201	DaCosta, A. M., finger guides.....	11,480
Clark, C. A., et al., refrigerator and freezer.....	11,721	Daggett, J. C., boots and shoes.....	11,343
" H. B., spring bed.....	11,333	Dalymphe, W., medical compound.....	11,309
" J. B. and L. C., bit heading machines.....	10,766	Darling, F., et al., boiler tube cleaner.....	11,679
" J. L., et al., wind mills.....	11,821	" G. S., et al., saw mills.....	11,400
" J. L., et al., floating docks.....	11,351	Darozler, L., et al., heel rand slabs.....	11,182
" M. M., boots.....	11,077	Davis, A., et al., nail machine.....	10,911
" T., live stock cars.....	10,773	" A. B., et al., car springs.....	10,771
" " palace and sleeping car.....	11,713	" B. H., stump machine.....	11,106
Clarkson, E. H. N., sash cord guides.....	10,837	" J. A., water wheel.....	11,749
Clypool, W., farm gates.....	11,250	" J., et al., lathes.....	11,619
Clement, B., et al., water cock.....	11,717	" L., et al., telephones.....	11,231
Clementin, J. W., et al., electric signalling.....	11,963	" M., et al., mortling doors.....	11,253
Cliff, A., et al., gas and air engine.....	11,810	" T. D., lawn rakes.....	10,891
Cloud, W. H., et al., pump brake.....	11,362	" W. M., gold depositing.....	11,618
Crough, F. M., et al., water gauge.....	12,018	Davison, G. H., et al., lubricating bearing.....	11,782
Cobb, J. J., vehicle springs.....	10,872	Day, C., et al., newspaper holder.....	11,374
O'Connell, R. et al., horse rake.....	10,900	" S., wagon rack.....	11,514
" " steam engine.....	11,393	Dayton, M. A., et al., paper re-pulping.....	11,069
Cock-hunt, J. G., horse hoes.....	12,000	Denkin, T. J., et al., iron manufacture.....	11,988
Collin, D. N. R., et al., chain stopper.....	11,573	Dederick, P. K., hay press.....	11,551
Cogswell, J. W., pruning implements.....	11,422	" " trend power.....	11,088
Cohen, J. J., advertising devices.....	11,008	De Groat, W. N., et al., rotary engines.....	10,935
Cohndald, L. G., hoiler feeding apparatus.....	11,846	Dempster, C. H., et al., cock eyes of traces.....	10,761
Co born, G. S., engine shaving machine.....	11,065	Denmet, H. E., dental compounds.....	11,895
" " rattan scraping.....	11,806	Dennis, J. H., sleds.....	10,742
Cole, C., et al., pruning implements.....	11,906	Denton, B. J., et al., peat machine.....	11,550
Collet, C. F., et al., advertising devices.....	11,008	Desforges St. Maurice, G., boots and shoes.....	10,939
Coltham, J., yarn winding and twisting.....	10,985	Deshon, D., shower baths.....	10,713
Colwell, W. S., motor and apparatus.....	10,890	De-ignolles, P. G. L. G., metal extraction.....	11,600
" " " " motors.....	10,809	De-marets, P., et al., spinning machine.....	11,728
" " " " for locomotives.....	10,815	Des Trois Maisons G., et al., heel trimming machine.....	11,640
Comly, D. B., saddle stirrups.....	11,861	Deverall, E. R., oil can.....	11,638
Cowboy, D., vehicles.....	10,751	Deveraux, S. K., wood decrating.....	11,929
Conklin, T. F., faucets.....	11,006	De Warr, L. E., boots and shoes.....	11,374
" J. L., railway signals.....	10,795	Desrees, T., wind mills.....	11,193
Connellce, C. U., et al., blacking brush.....	11,063	De Wolfe, J. L., nut locks.....	11,107
Connor, J. H., washing machine.....	11,901	Dexter, L. R., et al., sleds.....	11,072
Contani, A., et al., boots and shoes.....	11,474	Dhl, W. F., et al., files.....	10,831
Cook, J. V., et al., wagon gears.....	10,684	Dick, J. M., bolters.....	11,125
" W. F., electric telephone.....	11,754	Dickerson, E. N., jr., gold depositing.....	11,618
Cooley, H., et al., car couplings.....	11,140	Diekay, W. D., hydro-carbon furnace.....	12,011
Coon, C., et al., repulping process.....	11,060	Dietrich, J. C., cross-cut saw bundle.....	11,715
Cooper, C. F., traction engine.....	11,207	Dight, W. M., grain measures.....	11,283
Copeland, G. W., pegging machine.....	11,624	Dion, L., et al., heel rand slabs.....	11,182
" H. C., et al., heel lifters.....	11,329	Dixwell, G. B., engines and bolters.....	11,052
" " " " et al., journal bearing.....	11,720	" " " " steam engine.....	11,823
Corbin, C. I., horse rake.....	11,011	Dobbins, J., hoop machines.....	11,438
Cornell, G. B., bung bushes.....	11,524	Dohson, I. F., et al., dunting tables for ves-els.....	11,933
" W. E., postal paper.....	11,572	Dobyns, S. T., catarrh compound.....	10,913
Cornwell, J., grain preparing process.....	11,955	Dodd, A. L., et al., dynamo-electric machine.....	11,964
Costello, C., thrashing machines.....	10,790	Doddridge, W. C., heating arms.....	11,148
Coughlin, P., fence posts.....	11,507	Dodge, F., et al., peat machine.....	11,550
Coultard, H., et al., concrete pavement.....	11,380	" L. A., nail feeding device.....	11,470
Coupmand, L. B., et al., potato diggers.....	11,255	Dolty, T. G. F., exhausting air from cans.....	11,263
Courtney, W., treating fibrous substances.....	11,570	Donnelly, M. D. and T. A., et al., telephone.....	11,751
Covey, T. A., cabinet bedstead.....	11,904	Dorey, R. S., et al., harrows.....	11,235
Cowan, T., et al., moulding machines.....	11,494	Doyle, R. J., fruit package.....	11,791
" " " " wood planing machines.....	11,403	Dowell, A. B., holders for sickles.....	11,102
Cowell, R. A., car platforms.....	11,863	Downey, S. W., et al., shirt buttons.....	11,326
Cowing, G., moulds for making steel.....	11,022	Drake, F. J., shingle edging machine.....	11,473
Cowley, A., churn.....	11,340	Drehssegler, J., grinding mills.....	10,747
Cox, A. D., gate hangings.....	11,588	Drummond, W. W., et al., moulding in sand.....	10,952
" R. L., et al., butter colouring.....	11,984	Dubuc, F. R., et al., iron upsetting machine.....	11,781
Coyte, R. J., et al., water cock.....	11,717	Dudley, R., et al., clothes wringers.....	11,561
Craig, F. J., reaping machines.....	10,787	Dumsey, J., et al., preventing bearings from heating.....	11,546
" J. D., railway tanks.....	10,842	Dunbar, R., elevator.....	11,696
Crandal, E. M., barbed fences.....	11,079	" R. and G. H., et al., steam generators.....	11,658
Crane, T., gate blinge.....	11,653	" " " " trouble cylinder engines.....	11,417
Crawford, S., reaping machines.....	11,412	Duncan, H. E., et al., barrel castors.....	11,956
Crites, G. A. and B., earth augers.....	11,237	Dunham, T. H., cotton yarn.....	11,430
Crocker, F., et al., journal lubricator.....	11,091	Dunlevy, A. C., et al., skylight.....	11,716
" F., sr., combination pump.....	11,017	Dunn, C. H., et al., hubs.....	11,114
Crofford, W. C., et al., valves.....	11,312	Dunning, A., et al., potato diggers.....	11,355
Cron, A., car-coupler.....	11,088	Dunrat, D., nut lock.....	11,814
Crosby, A., axe case.....	11,503	Durrien, A. H. J. M., electric lamp.....	11,769
Cross, C., loom.....	11,323	Duryee, G., treatment of ores.....	11,160
" J., jr., et al., wood veneer boxes.....	11,155	Duwells, C. H., pumps.....	11,497
Crowell, E. L., velocipedes.....	11,852	Dyger, H. M., grain measures.....	11,283

Shmons, G. W., gates and doors.....	11,853	Taft, F. W., locks.....	11,074
Simmons, S. A., et al., heel machine....	11,336 11,337	" S. C., et al., boiler tube cleaner.....	11,070
	11,338	Talbot, F. J., nut locks.....	11,033
Simpson, C. G. C., hay press.....	11,551	Talcoat, C. M., et al., horse shoe nails.....	11,820
Sinn, C. F., railway brakes.....	10,765	" W. A., et al., knitting machines.....	11,178
Smitzenich, H. II C. roll making.....	11,625	Tallman, S. P., railway brakes.....	10,700
Sissons, J., refrigerator.....	11,635	Taylor, C., et al., mowing machines.....	11,383
Skinner, J., harvesters.....	10,944	" E. W., advertising devices.....	11,433
Slehter, J. B., elastic paint.....	11,906	" W. B., head rest.....	10,782
Sloan, W. M., et al., wax refining.....	11,743	Tessler, F. D., churns.....	11,109
Slusser, B., safety elevators.....	10,894	Thayer, W. H., kitchen implement.....	11,736
Small, B. B., cultivators.....	11,187	Thibault, H., et al., rotary engines.....	11,015
" H. M., pads for carpets.....	10,764	Thilmany, W., timber preserving.....	11,621
Smalley, J. & W. W., journal bearing.....	11,720	Thomas, G. B., iron roofing.....	11,512
Smart, A. & E., et al., paper boxes.....	10,724	" J. E., mowing machines.....	11,345
Smith, A. B., et al., lever rotary motion.....	11,486	" J. J., et al., car trucks.....	11,074
" G., mowers and reapers.....	11,993	Thompson, G. S., thrashing machine.....	11,833
" F. G., et al., railway frogs.....	10,982	" O. B., et al., carriage.....	11,583
" G., car brake.....	10,652 11,314	Thorne, G. L., archery.....	11,892
" J. C., washing machine.....	11,777	" J., type setting and distributing machines.....	11,022
" J. R., lawn rakes.....	10,991	Threlfall, T., fibre cleaning.....	11,824
" J. R., et al., paper boxes.....	10,829	Thurston, L., et al., sun dials.....	11,505
" K., et al., middlings purifier.....	10,983	Tichenor, A. C., furnace for extracting metals.....	10,816
" N., grain separator.....	11,955	Titus, T. H., et al., pads for horses' hoofs.....	11,947
" R. H., saw tempering process.....	11,885	Toelner, A., pumps.....	11,519
" S. J., cutting garments.....	11,788	Tolles, J. H., et al., mortising machine.....	11,566
" T., buggy tops.....	10,722	Tolton, B. & A., harvester for pease.....	11,258
" W., broad cast sowers.....	11,965	Travis, C. L., grain binders.....	11,257
" W. M., sewing machine.....	10,988	Treat, J. C., reed organ.....	10,814
Smyth, J. H., et al., gates.....	11,240	Trenk, H., et al., tanning process.....	11,974
Snyder, T. L., buttons.....	11,563	Trotter, J. E., stamp extractors.....	11,586
Soare, W. E., cross sectors.....	10,936	Trowbridge, C. S., et al., pipe grooving machines.....	11,054
Spaulding, A. H., et al., millstone cushion.....	11,733	Troy, R., blind hinges.....	11,672
Spencer, C. F., lamp.....	10,851	Trudelle, T. A., et al., car-couplers.....	11,938
" C. M., screw cutting machine.....	11,126	Tschirner, M., explosive compounds.....	11,301
Sprague, J. L., churn.....	11,320	Tucker, G. W., tubular rivets.....	11,872
Springer, H., cultivators and seeders.....	11,894	" S. D., et al., printing machines.....	11,306
Spunt, J. W., commodities.....	10,855	Tully, N., securing boiler tubes.....	11,014
Standard Empr. Vacuum Brake Co., The, a r brake.....	11,610	Turner, H. & W., pantaloons suspenders.....	11,322
Standley, R., gate latch.....	11,853	" J., closets.....	10,830
Stanfield, J., et al., floating dock.....	11,751	" R. L., hand hoe.....	11,579
Stanford, T. H., et al., railway brakes.....	11,822	Tyng, L. B., rail joints.....	11,538
Stanguard II. H., et al., horse rakes.....	10,735	Tyrol, J. F., soup compound.....	10,920
Staley, W. H., explosive compounds.....	11,049	Uilmo, S., tanning process.....	11,912
Stanton, H. W., nut locks.....	10,810	Unger, A., writing reproducing.....	10,958
Staples, J., turbine.....	11,692	Ujdegren, H., saddle stirrups.....	11,719
Stapley, W., railway ems.....	10,943	Valley, W. jr., harrows.....	11,611
Starratt, B. R., et al., railway frogs.....	10,882	Valley, J. N., step ladders.....	11,319
Steers, M. A., et al., pillow sham holders.....	11,547	Van Allen, C. D., churn and washer.....	11,169
" W., et al., metallic planes.....	11,348	Van Eggen, J., et al., horse shoes.....	11,548
Steger, J., air brake.....	11,610	Vandenburgh, J., et al., sun dials.....	10,734
St-Pr, S. H., saw gimmers.....	11,226	Van Dyke, J. W., et al., valve.....	10,816
Stethem, W. J., car-coupler.....	11,445	Van Horn, G., boot and shoe hook.....	11,442
Stevens, H., corkle separators.....	11,626	Van Horn, J. M., et al., cabinet and bed.....	11,530
" J., grain grinding.....	11,668	Van Horn, D. F., door "or grain cars.....	11,026
" grinding mills.....	11,539 11,543	Van Liew, D. F., washing powder.....	10,815
" S. A., et al., shoe stay.....	11,629	Van Slekke, H. H., washing powder.....	11,567
" W. J., pipe couplings.....	11,659	" I. N., et al., pump.....	11,764
Stewart, D. N., bings.....	10,875	Van Vorst, G. B., et al., stand pipe.....	10,973
Stokes, J. W., marking pen.....	11,832	Van Wyck, D. S., sawing machines.....	11,278
Stone, M. C., pencil sharpeners.....	11,995	Vedova, F. G., tanning skins and hides.....	11,790
" R., excavating apparatus.....	11,249	Venning, T., thrashing machines.....	11,992
Stoneman, J., et al., gas process.....	11,183	Vézina, F., spinning wheels.....	11,087
Stoner, A., fire extinguisher.....	11,919	Vick, A., velocipede.....	11,654
" J. B., grain elevators.....	10,986	Vicent, S., et al., spinning machine.....	11,728
" weighing machines.....	11,461	Vlger, X., lock.....	11,611
Storey, W. H., glove fasteners.....	11,261	Vincent, P., moccasins.....	11,670
Storie, O. O., grain binder.....	11,194	Vinet, A. S. & J. B., et al., removing boiler scale.....	11,991
Stouffer, J. O., pumps.....	11,950	Volney, C. W., explosive compounds.....	11,049
Stover, H. D., grain conveying machine.....	11,466	Wagener, F. W. & G. A., et al., ringing alarm bells.....	10,740
Stow, W. H., wood pavement.....	11,396	Waggoner, B., gang ploughs.....	10,956
Stowell, J. M., saw mill dog.....	11,859	Wagner, J. P., flower pot.....	11,748
Strong, P. W., et al., paper boxes.....	11,772	Walt, O. E., bobbins.....	10,784
Street, R. P., et al., wringer.....	10,829	Wapeman, J. W., copy books.....	10,784
Strung, S., soap manufacture.....	11,982	Walbridge, A. S., horse rake.....	10,919
Stuart, B. N., et al., valves.....	11,718	Walker, J., joint coupling.....	11,185
Stubblebine, N., et al., puddling furnace.....	10,887	" shaft.....	12,015
Studer, W., et al., railway brakes.....	10,999	" J. G., washing machines.....	11,916
Stunley, G. R., shaft heater.....	10,765	" N. W., clay pipe, tile, etc.....	11,381
Summer, D. C., textile fabrics.....	11,613	Wallach, W., copying apparatus.....	11,921
Susmith, F. C., et al., paper boxes.....	11,241	Walsh, T. H., asphaltum pipes.....	10,708
Swalt, J. C., et al., grain car door.....	12,017	Walton, B., brick burning.....	11,534
Sweeney, G., electric light.....	11,140	Wadby, H., stove pipe stone.....	11,752
Sweet, G., et al., mowing machine.....	12,016	Wands, J. C., car roofs.....	10,700
" J., steam engine.....	11,706	Wanklyn, J. A., et al., artificial manure.....	11,915
Sweetland, W. W., sash supporters.....	11,328	Wanzer, R. M., sewing machines.....	10,778
Swot, G. W., car wheels.....	11,037	" " & T. D., sewing machines.....	10,763
Swift, G. F., refrigerating apparatus.....	10,838	Ward, E. B., sewer traps.....	11,948
	11,536	" G. S., churns.....	11,281

Ward, J. A., et al, stone cutting machine.....	11,750	Ward, H., et al, ploughs.....	11,448	11,456
Warling, J. T., felting hat bodies.....	11,378	Wible, E. A., vehicle axle.....		11,331
" " " hat felting.....	11,371	Whitakersham, W., nail cutting machine.....		11,722
" " " " apparatus.....	11,347	" " " " et al, nail machine.....		10,911
" " " " machines.....	11,411	Wickershelmer, J., preserving organic bodies.....		11,130
Warren, J. T., and the Warren Manufacturing Co., horse power.....	11,978	" " " " protecting hair and skin.....		11,587
" " " " J., sash fasteners.....	11,292	Wicks, F., type setting and distributing apparatus.....		11,881
" " " " W., et al, harness.....	10,730	Wildfield, W. P., car brakes.....		11,907
Wasell, E., trusses for bridges.....	10,796	" " " " vehicle brake.....		11,830
Washburn and Moen Manufg Co'y, The, wire fence.....		Wilcox, S., et al, steam boiler.....		11,705
" " " " 11,452 11,454	11,455	" " " " engine.....		11,712
" " " " Z., S. & L. W., car wheel mould.....	11,769	" " " " W. M. & J. S. M., pumps.....		11,915
Watson, C. S., horse shoe nail finishing.. 11,688 11,689	11,702	Wildermuth, L., bed bottoms.....		11,807
" " " " et al, plumbers' traps.....	11,896	Wilhelm, E., et al, bolting machines.....	11,142	11,676
" " " " J., reaping machine.....	11,637	" " " " J. H., ore washing and amalgamating.....		10,984
" " " " et al, horse collars.....	10,898	Wilkins, A., cross cut saws.....		11,301
" " " " mowing machine.....	11,706	" " " " T. F., butter preserving.....		10,783
" " " " J. H., et al, saw mills.....	11,490	" " " " fish preserving.....		10,994
" " " " L. A., feather dusters.....	11,510	Williams, A. W. C., et al, horse shoe nails.....		11,820
" " " " T. A., telephone.....	11,575	" " " " C., et al, telegraph and telephone.....		11,330
" " " " et al, telegraph and telephone.....	11,330	" " " " Jr., telephones.....		11,251
" " " " telephones.....	11,277	" " " " et al, electric telephones.....		10,705
" " " " W. J., gates.....	10,868	" " " " " " microphones.....		11,737
" " " " et al, car trucks.....	11,393	" " " " H., rail joints.....		10,920
" " " " link for railway cars.....	10,769	" " " " J., et al, motor for machinery.....		11,256
Wavel, T., shelf and drier.....	11,921	" " " " W., sharpening mower knives.....		11,038
Wavish, J., steam boiler.....	11,228	" " " " W. L., bran packing machine.....		11,919
Wearer, G. W., et al, mop wringers.....	11,710	Williamson, D., grain binders.....		11,418
Webb, N., et al, car trucks.....	11,074	" " " " W. P., car ventilators.....		10,720
Webster, A. B., carriage springs.....	12,003	Williston, H. M., car locks.....		11,419
" " " " sleighs.....	12,002	Wilson, J. C., water turbine.....		11,700
" " " " J., flour bolt.....	11,727	" " " " et al, turbine mould.....		11,699
" " " " S., oil tank.....	11,797	" " " " M., shelf and drier.....		11,921
Weed, J. A., paper mill.....	11,979	" " " " R. P., smelting oven.....		11,375
Weir, J. B., calk plates.....	11,573	" " " " W., valves.....		11,437
Weller, M. E., et al, polishing hol ow ware.....	11,218	Wilt, B., truck and bag holder.....		11,863
Wells, C. G., fifth wheels for vehicles.....	10,752	Wigg, H. S., carpet sweepers.....		11,545
" " " " H. M., blind fastener.....	11,633	Wigard, E. V., brick burning.....		11,429
" " " " et al, stove pipes.....	11,584	Winstow, F., boot and shoe sole napper.....		11,129
West, J., et al, can filling apparatus.....	11,767	Winter, G. K., et al, duplex telegraphy.. 11,150 11,151		11,921
" " " " L. D., barrel stands.....	10,800	" " " " " " multiplex telegraphs.....	11,152	11,152
Westgarth, J., wire fence.....	11,879	Winters, F. Jr., cylindrical valves.....		11,356
Whalen, A., brick and tile machine.....	11,020	Wiser, C., et al, vehicles.....		11,208
Wheeler, N. E., et al, grain separators.....	11,097	Wisner, J. E., horse rake.....		10,990
" " " " S., paper cabinets.....	11,144	Wiswell, F. A., curtain fix-tures.....		11,227
" " " " holder.....	11,019	Witmer, D. W., cider presses.....		10,755
Wheelock, C. B., et al, stone cutting machine.....	11,750	" " " " T. & M. M., slicing machine.....		10,901
Whitaker, W. V., coal sifters.....	10,950	Wood, A. B., et al, match boxes.....		11,677
Whitcomb, G. D., mining machines.....	11,414	" " " " et al, steam engines.....		11,860
" " " " O. P., et al, treating pyroxilin.....	11,073	" " " " A. L., purifying liquors.....		11,554
White, A. W., et al, beer faucets.....	11,276	" " " " E. L., et al, blacking brush.....		11,903
" " " " C. H., et al, furnace regulators.....	10,856	Woodford, C. W., horse shoe nail finishing..... 11,688		11,702
" " " " C. N., washing machine.....	11,366		11,689	11,701
" " " " F., car-couplers.....	10,957	Woodruff, G. S., gas regulator.....		11,808
" " " " G., spring vehicles.....	11,946	Woodrum, J., separating potash.....		11,308
" " " " G. A., knitting machine.....	11,878	Woodward, B., et al, chain stopper.....		11,873
" " " " G. B., horse shoes.....	10,839	" " " " " " furnace regulators.....		10,856
" " " " H. W., churu dasher.....	11,918	" " " " E., " pegging machine.....		11,624
" " " " W., closet.....	11,354	" " " " J. R., et al, car-couplers.....		11,352
" " " " valves.....	11,420	" " " " M. J., petroleum decolorizing.....		11,726
Whiteley, W. N., chains for transmitting power.....	10,738	Worden, A., cartridge capping device.....		11,741
" " " " grain binders.....	11,190	Wragg, J., et al, huffing cutlery.....		11,157
" " " " harvesting machines.. 10,841 11,116	11,117	Wright, A., door shutter.....		11,297
Whiteside, H., cot bed.....	11,810	" " " " C., et al, bending machine.....	11,081	11,082
Whitefield, J., stump extractor.....	11,998	" " " " " " drying stands.....		11,080
Whitney, E. R., mowing machines.....	10,951	" " " " F. M., bosom board.....		11,975
" " " " et al, evaporators.....	11,195	" " " " G. M., chromatic printing machine.....		11,660
" " " " H. M., spade and shovel.....	10,995	" " " " J., et al, steam boiler.....	11,931	11,932
" " " " J. H., rolling machines.....	11,177	" " " " T., wire fences.....		11,508
" " " " W. B., et al, car springs.....	10,771	" " " " W. H., archery.....		10,892
Whittington, W. R., et al, arvesters.....	10,937	Wylie, W. N., clothes washer.....		10,976
Whittesey, C. E., et al, shoe stay.....	11,659	Wynkoop, M. F., car-couplings.....		10,907
Wiard, G., casting mould.....	11,593	Yagu, N., hoiler feeding apparatus.....		11,847
" " " " H., plough beams.....	11,465	Yates, H. G., horse shoes.....		11,739
" " " " et al, cooling plough mould boards.....	11,483	Young, L., et al, tool-holders.....		11,479
		" " " " W. & A., pitman connections.....		11,954
		Zanetti, F. C., vice.....		11,809



Vol. VIII.—No. 1.

JANUARY, 1880.

Price in Canada \$2.00 per An.
United States - \$2.50

CONTENTS.

INVENTIONS PATENTED.....	I
INDEX OF INVENTIONS.....	VII
INDEX OF PATENTEES.....	VII
ILLUSTRATIONS.....	9

INVENTIONS PATENTED.

No. 10,694. Improvements in Threshing Machines. (*Perfectionnements aux machines à battre.*)

Florens Kitten, Ferdinand, Ind., U. S., 22nd November, 1879, for 5 years.

Claim.—1st. A straw conveyer composed of successive sections, each section vibrating from a pivotal line located above its front on receiving end, thereby serving the double capacity of straw conveyer or shaker; 2nd. The combination of a straw conveyer composed of successive sections, each section vibrating from a pivotal line located above its front or receiving end and mechanism, whereby the sections are simultaneously operated for conveying the straw from one section to another; 3rd. The combination of a straw conveyer composed of successive sections, each section vibrating from a pivotal line located above its front or receiving end, a carrier suspended under said conveyer and intermediate connecting mechanism, whereby said straw conveyer and carrier are simultaneously moved in opposite directions; 4th. The combination of the shakers E suspended by the rocking shaft C, at their front ends, and connected to the rod U with the carrier H, connecting rods R S and double crank shaft P; 5th. The combination, with the rear shaker E, of the series of the vibrating and pivoted shouldered prongs and fingers O, for discharging or ejecting the straw from the machine; 6th. The carrier H, provided with transverse inclined recesses or grooves and lattice work and having the pivoted shouldered prongs or fingers O, in its rear end, just beyond the lattice work, so as to discharge or eject the straw; 7th. The shakers and straw conveyers E, arranged in successive sections and suspended, at their front ends, by the rocking shafts C and connecting to the rods U, in combination with the operating mechanism, whereby they are adapted to receive simultaneous upward tilting and vibrating movements.

No. 10,695. Improvements on Hand Trucks. (*Perfectionnements aux camion à bras.*)

Moses Johnson, Lockport, N. Y., U. S., 27th November, 1879, for 5 years.

Claim.—1st. The longitudinal base or support A, slotted standards C and clutch B; 2nd. The base or support A, shouldered standard e, slotted standard C and clutch B; 3rd. The slotted standards C C for reception of clutch bar *cc*, for adjusting the length of the clutch; 4th. The combination of clutching points *cc*, lugs *cc* and handles or standards F F; 5th. The clutch B having lugs *cc*, orifices *dd* and longitudinal pieces A A with orifices *dd*, and lugs *a* supported on standards *e*, united by the adjustable bolts *aa*, for regulating the leverage; 6th. The longitudinal pieces A A, supported by standards *e* and handle standards F F of clutch B, by means of transverse adjustable bolts *aa*.

No. 10,696. Improvements on Sewing Machines. (*Perfectionnements aux machines à coudre.*)

Samuel Y. Love, Philadelphia, Pa., U. S., 27th November, 1879, for 5 years.

Claim.—The combination of the needle bar having a frame D, needle carrying slide *a*, pivoted dog M and arm or lever F having finger *f*.

No. 10,697. Improvements in Churns. (*Perfectionnements aux barattes.*)

John Shaw, Toronto, Ont., 27th November, 1879, for 5 years.

Claim.—1st. The swinging dasher E in combination with the box A forming a churn; 2nd. The rocking shaft C pivoted upon the standards B, in combination with the perforated dash boards E, arms F, and bars *e* forming a swinging churn dash; 3rd. The rack H supported from the cover G by the bridges I J, in combination with the swinging dash E.

No. 10,698. Machine for Whitening Gilt Mouldings. (*Machine à blanchir les moulures dorées.*)

William E. Eastman, (Assignee of Frank P. Baker,) Boston, Mass., U. S., 27th November, 1879, for 5 years.

Claim.—1st. In a machine for whitening and coating mouldings, the endless friction band C composed of rubber, or rubber and other material combined, in combination with two or more pulleys B; 2nd. The yielding pressure rolls A, composed wholly or partly of rubber or other soft material, in combination with the springs F for pressing the mouldings upon the friction feed band C; 3rd. The combination of the pressure rolls A with the endless friction band C; 4th. The combination, with two or more pressure rolls A and two or more feed pulleys B, of the drum E enclosed by and operating the said pulleys B, by means of the endless band C and belts *cc*; 5th. The combination, with the parts A B C, of the tightener G.

No. 10,699. Improvements in Painting Brushes. (*Perfectionnements aux pinceaux.*)

Charles W. Meakins, Hamilton, Ont., 27th November, 1879, for 5 years.

Claim.—1st. A brush tool constructed with the hole B, in the end of the handle A, and the plug D to be inserted in the said opening in the handle; 2nd. The combination of the handle A, opening B in handle, pin or plug D, ferrule C and hair or bristles E.

No. 10,700. Improvements on Car Roofs. (*Perfectionnements aux toits des wagons.*)

John C. Wands, Louisville, Ky., U. S., 27th November, 1879, for 5 years.

Claim.—The combination, in a wooden roof, of adjoining boards, tongued and grooved into each other, having a recess under their joint, in their under sides, and an angular drip point extending downward into said recess, and a trough or gutter fitting into said recess under the drip point out of contact therewith.

No. 10,701. Improvements on Gate Rollers. (*Perfectionnements aux roulettes des barrières.*)

William Schwendler and Daniel Frerice, Appleton, Wis., U. S., 27th November, 1879, for 5 years.

Claim.—1st. The flanged discs *a b* united together upon a ball that is carried by a supporting pin or screw, and having a washer G clamped between the two parts of the roller; 2nd. The combination of the flanged roller A, ball *a* and pin or screw *e*, the ball being placed loosely upon the pin and retained in place.

No. 10,702. Improvements in Bakers' Ovens. (*Perfectionnements aux fourneaux de boulangerie.*)

Thomas Hunter, Toronto, Ont., 27th November, 1879, for 5 years.

Claim.—In combination with a baker's oven, a furnace D set within the oven, but below the sole A

No. 10,703. Improvements in Spark Arresters. (*Perfectionnements aux arrêtés-flamme-chs.*)

Elijah Leonard, (Co-inventor with Robert Angus,) and Frank E. Leonard and Charles W. Leonard (Assignees), London, Ont., 27th November, 1879, for 5 years.

Claim.—1st. The hood D, in combination with the smoke box of a horizontal boiler; 2nd. The partition plate G and slats I, in combination with deflectors F H and hood D, arranged within the smoke box of a horizontal boiler.

No. 10,704. Improvements in Door Fasteners. (*Perfectionnements aux fermatures des portes.*)

William H. Garlock, Denison, Texas, U. S., 27th November, 1879, for 5 years.

Claim.—The combination, with the rear edge of the door and the bolt *b* and stud *d* below the lower edge of said door, of the slotted endwise movable

rotating wedge plate C adapted, when turned in one direction on the bolt, to engage the door edge and stud and, when turned in the other, to swing below the lower edge of the door, so that the latter can pass above it freely.

No. 10,705. Improvements on Electric Telephones. (*Perfectionnements aux téléphones électriques.*)

Alexander M. Bell, Brantford, Ont., and Charles Williams, jr., Boston, (Assignees of Alexander G. Bell, Cambridge,) Mass., U. S., 27th November, 1879, for 5 years.

Claim.—1st. The method of producing currents of varying intensity in a circuit, the same consisting in altering the electric resistance of said circuit by the movement in frictional contact of electric conductors; 2nd. The method of transmitting speech, the same consisting in throwing upon a line electric undulations, by increasing and diminishing the resistance of the circuit by the movement in frictional contact of electric conductors, in accordance with the vibrations of a diaphragm responding to atmospheric vibrations; 3rd. The combination, with an elastic vibration diaphragm, of a vibrating conductor attached thereto, and a conductor in frictional contact with said vibrating conductor; 4th. The combination, with two or more conductors in frictional contact with each other, of an elastic vibratory plate or diaphragm, arranged to cause a movement past each other of said conductors, in accordance with the vibrations of the diaphragm; 5th. The combination, with an electric circuit, of two or more conductors resting in contact and forming part of said circuit, so that the current passes through the point or points of contact of a vibratory plate or plates, for effecting a movement past each other of said conductors; 6th. The combination, with an electric circuit, a source of electricity and a receiving instrument for reproducing sounds from the currents passing through said receiving instrument, of a transmitting instrument, composed of an elastic vibratory plate or diaphragm, and two or more conductors, resting in frictional or sliding contact with each other and forming part of aforesaid circuit, one or more of said conductors being attached to, and vibrating with said diaphragm; 7th. In a magnet, one or more coils surrounding its pole or poles, an elastic inductive plate or diaphragm located in front of said poles, a vibrating conductor attached to said plate and a separate conductor in contact with said vibratory conductor; 8th. The combination, in an electric circuit in which a receiving instrument of ordinary or suitable construction is placed, of a magnet and associated coils, an electric inductive plate or diaphragm in front of said poles, a vibrating conductor attached to said diaphragm, a conductor fixed with reference to said vibratory conductor and in contact therewith, and electrical connections for forming an electric circuit through said coils and through said conductors from one to the other, through their point of contact; 9th. A transmitting instrument or telephone composed of an elastic vibratory diaphragm secured in a frame, a perforated conductor fixed to said frame, a conductor attached to said diaphragm and free to move in the aperture in said perforated conductor, and devices or means for connecting the said instrument with an electric circuit, so as to form a part thereof; 10th. The method of producing undulatory currents of electricity by the friction of conductors placed in an electric circuit.

No. 10,706. Improvements in Long-Legged Boots. (*Perfectionnements aux bottes à longes tiges.*)

Robert Church, St. Lambert, Que., 27th November, 1879, (Re-issue of Patent No. 10,371).

Claim.—1st. A long-legged tongue boot, having the leg made of a single piece with the seam immediately in front; 2nd. The leg piece A, having its lower edge cut concave and its upper side cut down at the meeting edges; 3rd. The leg piece A, with concave lower and cut-away upper edges and having projections for side linings; 4th. The single leg piece A cut up the back, as at b, in combination with the outside counter; 5th. The combination with a long-legged boot, of the separated top piece D having its ends concealed by the straps E E.

No. 10,707. Improvements on Closets. (*Perfectionnements aux cabinets.*)

Amos Mallory, Mystic Bridge, Ct., U. S., 29th November, 1879, for 5 years.

Claim.—1st. The combination, with the seat B, of the guide frame E E; E₂, slide F, connecting rod G, crank H and knob or button I.

No. 10,708. Improvements on Copying Apparatus. (*Perfectionnements aux appareils à copier.*)

Willy Wallach, New York, U. S., 29th November, 1879, for 5 years.

Claim.—1st. A jelly roller with flanges; 2nd. A jelly roller with flange and index; 3rd. A jelly roller with flanges and a raised support.

No. 10,709. Improvements in Horse Collars. (*Perfectionnement aux colliers de cheval.*)

Sylvester J. Bowers, Canandaigua, N. Y., U. S., 29th November, 1879, for 5 years.

Claim.—1st. The two portions adapted to fit upon the free ends of a collar, one of which is provided with a groove A, the other having a tenon B of such size and shape as to fit neatly into the said groove A; 2nd. The groove A and tenon B tapered and dove-tailed so as to fit and lock tightly together; 3d. The two portions, each of which is riveted to the collar by a single rivet; 4th. The groove A having one end splayed or widened out; 5th. The combination of the tongue B with the stop cap C; 6th. The arrangement and combination of the groove A and pocket b with the tongue B, stop cap C and spring latch D having the catch a and knob c.

No. 10,710. Process and Apparatus for Cooling Oil in Tempering Steel. (*Procédé et appareil pour refroidir l'huile en recuisant l'acier.*)

John B. Armstrong, Guelph, Ont., 29th November, 1879, for 5 years.

Claim.—1st. Drawing the heated oil from the bath and forcing it through a coil of pipin, or through a chamber or chambers exposed to the cooling

action of water, and returning it to the bath again; 2nd. In combination with the oil bath, the pump B, pipes B₁ B₂ B₃ B₄ B₅, water tank D and coil C; 3rd. The combination, with the oil bath, of the pipes B₄ B₅ perforated as described.

No. 10,711. Art of Preparing and Tanning Hides and Skins. (*Art de préparer et tanner les peaux.*)

James Foley, Montreal, Que., 29th November, 1879, for 5 years.

Claim.—In the process of preparing hides and skins for tanning, sulphide of barium, alkali waste and sulphide of sodium, for unhairing and removing the hair, wool and epidermis from hides and skins and for soaking them, washing hides and skins after the hair is removed by centrifugal force, plumping hides and skins with an aqueous solution of sulphurous acid, bi-sulphite of lime or potash, softening flint and dry salted hides and skins with sulphate or carbonate of soda, bating or paring hides and skins with chloride of magnesium and calcium or carbonate of ammonia, and, in tanning the prepared hides and skins, the addition of ground fustic or a solution of fustic to tanning ooze or liquor as an assistant in the process of tanning, and to modify the color given to leather; also in combination with the above process, the extracting of the tanning liquor from sunnec infusions by centrifugal force, and removing the spent or impoverished liquid from the pores of hides and skins by centrifugal force or expression.

No. 10,712. Improvements on Car-Couplers. (*Perfectionnements aux attelages des wagons.*)

John R. Forsyth, Brussels, Ont., 29th November, 1879, for 5 years.

Claim.—1st. In connection with a railway car, the metal box B with an open bottom and groove for lever of latch; 2nd. In connection with a railway car and in combination with the box B, the latch and lever passing through said box; 3rd. In combination with said latch C and connected thereto by the links D, the short lever E, supported from the body of the car by the arm F and connected, by the rod H, to the chains D D, which also connect same to the main lever K and the supporting arm J, and the draw rod M with the handle N; 4th. In combination with the box B, the latch C connected by the links D₁ to the main lever E, the supporting arm F attached to block on end of truck car, the resting arm G which keeps said lever E in position when the cars are coupled; 5th. The latch A, with its long lever arm C carrying the weighting ball D, to keep the latch in firm position, and the pinion B, passing horizontally through the latch and securing it in the metal connecting box, and having a slight projection at each side to obviate friction through the length of the lever against the sides and groove of the box B; 6th. The guide bar A L with projecting shoulders or catches C C, on the inside, to keep the lever K in position, when elevated or depressed, and also the spring B to keep said lever locked on said shoulders or catches C C; 7th. In combination with the aforesaid, the improved form of coupling link, the same being made with straight sides, rounded ends and bevelled edges on the ends.

No. 10,713. Improvements on Shower Baths. (*Perfectionnements aux appareils à douches.*)

Daniel Deshon, Bucyrus, Ohio, U. S., 29th November, 1879, for 5 years.

Claim.—1st. The water tank A, divided into compartments, by means of partitions a b provided with openings o o, in combination with the tilting platform E provided with cleats i i whereby the bather can re-use the water or not, at will.

No. 10,714. Improvements on Lamp Reflectors. (*Perfectionnements aux réflecteurs des lampes.*)

The American Street Light Reflector Co'y., Boston, (Assignees of Charles Robinson, Cambridgeport), Mass., U. S., 29th November, 1879, for 5 years.

Claim.—1st. A lamp or gaslight reflector composed of a series of individual concave reflectors B B arranged around and below the burner A; 2nd. In combination with the burner A and reflectors B B, the coiled spring D by which the said reflector is suspended from the said burner.

No. 10,715. Improvements on Grain Separators. (*Perfectionnements aux séparateurs des grains.*)

Francis M. Bissell, Coldwater, Mich., U. S., 29th Nov., 1879, for 5 years.

Claim.—1st. In combination with the hopper, the fluted feed roller M; 2nd. The shoe C hung upon hangers a and capable of receiving a vibratory side-shaking motion its entire length; 3rd. The shoe C and hangers a, in combination with the bell crank lever F and shaker rod E, operated by the fan shaft; 4th. The lower shoe G resting upon brackets and friction rollers, and capable of receiving a shaking motion, in the direction of its length, and also a vertical shaking motion; 5th. The shoe G in the lower end of which is formed the opening o and spout n, together with discharge openings in the bottom thereof, and capable of separating and discharging grain into separate compartments; 6th. In combination with the lower screen c, the friction wheels d, brackets g J, laterally projecting arms h and shaker rods H H, operated by the fan shaft; 7th. The uneven surface of the face of the metal plates, on the lower end of the lower shoe, passing over friction rollers and causing a vertical and jarring shake to agitate the grain and prevent the screws from clogging.

No. 10,716. Improvements on Fence Posts. (*Perfectionnements aux pieux des clôtures.*)

Henry M. Beecher, New Haven, Ct., U. S., 29th November, 1879, for 5 years.

Claim.—1st. A fence post, the feet of which are formed of angle iron and curved in opposite directions; 2nd. The feet formed of curved angle iron and having a portion of one of its flanges turned over into the same plane as its fellow flange; 3rd. The two curved feet, placed side by side, crossing each other, pivoted together and adapted for driving into the ground; 4th. An upright and curved foot, formed rigidly thereon, and a shorter foot crossing the same and pivoted to one side thereof, and having its upper end adapted

to receive the first blows in the act of driving the planks into the ground; 5th. The eyes formed in side projections at the edge of the post, said projections being of a reduced thickness and of one and the same piece with the post.

No. 10,717. Improvements on Ozone Apparatus. (*Perfectionnements aux appareils à ozone.*)

Frederick W. Bartlett and George F. H. Bartlett, Buffalo, N. Y., U. S., 29th November, 1879, for 5 years.

Claim.—1st. The platform *d*, attached wooden rod *D*, and glass rod *D*, the two joints *e* or hinged in any suitable manner; 2nd. The glass-holder *E* having the circular wall *f* and radial arms or wings *e e e*, from which or between which the phosphorus may be suspended or attached in any suitable manner; 3rd. In combination with the dome *C* and rod *D*, the hollow stopper *b* closed at the top, the collar *a* at and metal clasps *c c c*; 4th. In combination with a base *A* and eliminating chamber *B*, the top or dome *C*, when its walls or outer circumference deviate from the vertical, from the top downward and outward, thereby preventing acid and other accumulation; 5th. In combination with a water-containing vessel, and provisions for slow admission of air and the discharge of ozone, the yielding supports *g g*, each adapted to immerse its quantity of phosphorus on the generation of any considerable heat; 6th. The ring or rings *F*, of fusible metal or chemically treated yarn or twine, acting as phosphorus supports or as frames on which to hang or attach phosphorus; 7th. The phosphorus sticks moulded upon or otherwise attached to the yielding supports *g g*; 8th. In combination with the fusible metal rings supports *F g*, a coating of varnish or lacquer, for the purpose of preserving them from the effects of ozone or acids; 9th. A glass-holder *E* constructed in sections or parts, each with wings, arms or partitions, so as to give greater generating capacity to large machines.

No. 10,718. Improvements on Land Rollers. (*Perfectionnements aux rouleaux d'agriculture.*)

John A. Kappheim, Dundas, Ont., 29th November, 1879, for 5 years.

Claim.—The combination of the angular faced rollers *R* and shafts *S S*; 2nd. The combination of frame *A*, shafts *S S*.

No. 10,719. Method of, and Apparatus for, Reproducing Writing, Drawings, &c., in one or more Colors. (*Méthode et appareil pour reproduire l'écriture, les dessins, etc., en une ou plusieurs couleurs.*)

Albert Ungerer, Vienna, Austria, 29th November, 1879, for 5 years.

Claim.—1st. The apparatus consisting of substances specified under the head 1 to 6 and *a* to *f*, formed into masses or blocks together with the inks and colors for reproducing writings, drawings and the like, in any number of colors at once on any substance, by a dry method; 2nd. The method and materials described for the manufacture of colored paper, leather and the like; 3rd. The use of polychromes and the colors specified, either singly or mixed or combined in the manner and for the purposes specified.

No. 10,720. Improvements in Car Ventilators. (*Perfectionnements aux ventilateurs des wagons.*)

William P. Williamson, Quincy, Ill., U. S., 29th November, 1879, for 5 years.

Claim.—1st. A device for ventilating and cooling cars composed of an air admitting pipe, a tank *B* and a deflector *C* located in rear of the tank *B* and of an inclined deflector beneath the tank, the deflectors having surfaces of cloth, or equivalent material and being provided with spraying pipes; 2nd. The combination of the pipe *A*, the tank *B* and the deflector *C D F*; 3rd. In combination with the evaporating surfaces of the deflectors, the spray pipes and their water supplying connections.

No. 10,721. Improvements in the Manufacture of Boots and Shoes. (*Perfectionnements dans la fabrication des chaussures.*)

Joseph Hogue, St. Jean, Que., 29th November, 1879, for 5 years.

Résumé.—1o. La manière d'ajouter à la chausure la partie formant la languette *C*; 2o. La méthode de cambier le devant et la derrière d'une chausure d'un seul morceau et par une seule opération 3o. La substitution de boutons *d d* au lieu de la languette bouclée.

No. 10,722. Improvements in Buggy Tops. (*Perfectionnements aux couvertures des voitures.*)

Thomas Smith, Westminster, Ont., 29th November, 1879, for 5 years.

Claim.—1st. The lever *E*; 2nd. The combination of the flanged plate *A* having foot *B*, inner plate *C*, lever *E* with jaws *D*, extension piece or wings *G*, spring *I* and bows *H H J J*.

No. 10,723. Machine for Making the Inner Soles of Boots and Shoes. (*Machine à faire les semelles intérieures des chaussures.*)

Mary A. C. Holmes, Boston, (Assignee of Francis D. Ballou, Marlboro'), Mass., U. S., 5th December, 1879, for 5 years.

Claim.—1st. The combination of a stationary and a rotating cutter and an intermittently rotating feed; 2nd. The combination of a stationary and a rotating cutter, a vibrating awl carrying arm and an intermittently rotating feed; 3rd. The combination of a vibrating awl carrying arm, and an intermittently rotating feed; 4th. The combination of a rotating and stationary cutter, an intermittently rotating feed and the adjustable work support.

No. 10,724. Improvements on Paper Boxes.

(*Perfectionnements aux boîtes en papier.*)

Charles M. Arthur, Albert Smart, Ellsworth Smart and Benj. C. Shepherd, Brockville, Ont., 5th December, 1879, for 5 years.

Claim.—1st. The sides *A B C D* with their respective projections to form the ends, the ends of one side cut *t* to form a notch, as at *a*, on each edge, the ends of the opposite sides constructed with a diagonal cut *H*, the bottom of said cut corresponding to the notched parts of the other end; 2nd. A paper box blank cut so as to be folded into a complete box combined with a thin paper lining, to form a lining for the box when complete.

No. 10,725. Improvements on Electric Signals for Railways. (*Perfectionnements aux signaux électriques pour les chemins de fer.*)

Joseph J. Conklin, New York, U. S., 5th December, 1879, for 5 years.

Claim.—1st. In combination with the electro-magnet signal and shaft *e*, the armature lever *d*, arms *i b r*, segment *o* and latch lever *l*; 2nd. The combination of the electro magnet, armature *a*, lever *d*, latch *l*, pusher *k*, shaft *e* and signal; 3rd. The combination, with the signalling instruments, of the circuit closers and circuit wires; 4th. The circuit closing lever *w* pivoted to the rail, in combination with the clip *x* and spring circuit closer, resting upon the flange of the rail.

No. 10,726. Improvements on Fence Gates. (*Perfectionnements aux barrières.*)

Silas T. Fenn (Assignee of Henry H. Allen), Oxford, Mich., U. S., 5th December, 1879, for 5 years.

Claim.—The loop or strap *A B* in connection with any fence gate.

No. 10,727. Improvements on Door Hangers. (*Perfectionnements aux pentures des portes.*)

Edwin Prescott, Hampton Falls, N. H., and George W. Gregory, Boston, Mass., U. S., 5th December, 1879, for 5 years.

Claim.—1st. A post lever and door lever connected as described, whereby the opposite ends of each lever are made to move past opposite sides of the other lever; 2nd. The post and door levers pivoted together at a point, one side of the centre of their length, and adapted to move one lever beyond the other, at opposite ends upon opposite sides; 3rd. A lever *a* and truss-shaped lever composed of parts 23 and fulcrum piece 4, the lever *a* passing through an opening or recess in lever *e*.

No. 10,728. Improvements on Saw Mill Head Blocks. (*Perfectionnements aux poupées des scieries.*)

Benjamin E. Sergeant, Greensboro, N. C., U. S., 9th December, 1879, for 5 years.

Claim.—1st. The combination, with the head block slide *B* having rack bar *C*, of the shaft *F*, loose pinion *D*, spring *d*, clutch *G* feathered on the shaft, and the lever *H*; 2nd. The lever rod *L*, with movable set *h*, in combination with the setting lever *J*; 3rd. The combination of the ratchet wheel *I*, lever *J*, weighted double acting dog *K* and sliding counter balance *O*; 4th. The combination of the adjustable pin *e* having set nut *e¹* with the frame having slot *e²*, and with the lever rod *L* and slotted set *h*.

No. 10,729. Improvements on Threshing Machines. (*Perfectionnements aux machines à battre.*)

Robert R. Monteith and John Hunner, Eau Claire, Wis., U. S., 9th December, 1879, for 5 years.

Claim.—1st. The combined straw carrier and screen composed of the rectangular frame *c*, longitudinal toothed bars *e h*, transverse bars *f*, wire screen *g* and transverse rods *i* arranged in front of said screen *g*; 2nd. The combination, with the straw carrier and screen *E*, suspended at its rear end by its operating crank shaft *l*, and the shoe *H*, suspended at its rear end by the link *l*, of the walking beams *m* pivoted to the sides of the machine, and connecting and suspending the straw carrier and screen and the shoe near their front ends, whereby the straw carrier or screen is adapted to receive an upward, backward, downward and forward motion, and the shoe a free swinging motion in an opposite direction, by the motion imparted to said carrier and screen; 3rd. The combination, with the straw carrier and screen *E*, the shoe *H* and the suspended spouts *o q*, of intermediate connecting mechanism, whereby said straw carrier and screen, the shoe and spouts are simultaneously vibrated in different directions through the medium of the mechanism for operating the straw carrier and screen; 4th. The combination, with a vibrating shoe, of transverse spouts *o q* loosely suspended from the frame of the machine, and connecting mechanism between said shoe and spouts, whereby the spouts are vibrated transversely by the motion of the shoe without moving with it; 5th. The combination, with the vibrating straw carrier and screen *E*, the thrashing cylinder and concave *C* and vibrating shoe provided with grain board *L*, of the inclined grate or riddle *F*, extending over the forward end of carrier or screen and under the concave; 6th. The combination, with the vibrating shoe *H* having the spout *q*, riddle or riddles *n* and transversely grooved grain floor *I*, of the longitudinal rods or wires *S* connected to the rear end of said grain floor and projecting or extending backward up over the riddle or riddles *n*; 7th. The tailings elevator having a V-shaped floor or trough *R* in cross sections, and correspondingly V-shaped buckets *S* mounted on an endless chain *St*, whereby the inclination of the sides of the floor or trough prevents the tailings from adhering thereto, and thus obviating choking or clogging of the elevator.

No. 10,730. Improvements on Harness. (*Perfectionnements aux harnais.*)

Charles S. Piersons, Charles Ferris and William Warren, Sandy Hill, N. Y., U. S., 9th December, 1879 (Re-issue of Patent, No. 9627).

Claim.—1st. The combination, with a metallic plate provided with a recess on one side, of a strap fitted in the recess, a clamping plate which

secures the strap therein, and a fastening device which maintains said clamping plate in position; 2nd. The combination, with a metallic plate provided with a longitudinal groove and two adjacent straps fitting in the latter, of a clamping plate which secures said straps in position, and studs which project from the plates through the straps; 3rd. The combination, with a metallic plate secured longitudinally to a collar and provided with a trace fastening device, of a shoulder strap fitting in a loop formed in the forward upper portion of said plate; 4th. The combination, with a breeching and a hold-back strap, of a metallic plate secured longitudinally to the outer side of the breeching, and provided with a fastening device, at its forward end, which connects with said hold-back strap; 5th. The combination, with a rigid thill carrier whose annular groove is formed with transverse recesses, respectively in its top and side, of a buckle and loop which fit respectively in said recesses and a carrier strap which secures them therein; 6th. The combination, with a metallic plate secured to a strap and provided with a transverse recess having a central hole, of a buckle whose tongue bar fits in the recess and whose tongue projects through the hole, said plate being further provided with an imperforate transverse recess within which a strap loop fits.

No. 10,731. Art of Ruling Paper. (*Art de régler le papier.*)

Daniel Mortimer, Ottawa, Ont., 9th December, 1879, (Extension of Patent No. 4,140), for 5 years.

No. 10,732. Improvements on Bean Pickers. (*Perfectionnements aux trieurs de fèves.*)

Thomas Barnes, Harwich, Ont., 9th December, 1879, for 5 years.
Claim.—The tapered tube A having a portion of its sides split into sections or springs A', terminating in an orifice, with turned-up ends D and maintained in place by smaller tube E attached internally thereto.

No. 10,733. Improvements on Self-Oilers for the Journals of Railway Cars. (*Perfectionnements aux graisseurs automatiques pour les essieux des wagons de chemins de fer.*)

Harmon Gilmore, Simcoe, Ont., 9th December, 1879, for 5 years.
Claim.—The combination and arrangement of roller C, hung or supported by springs D D, in the oil box or reservoir attached to railway car trucks, and revolved through the oil in oil box by friction with the car journal, for the purpose of supplying the journal with oil for lubricating it.

No. 10,734. Improvements in Anti-Friction Journal Boxes. (*Perfectionnements aux boîtes des tourillons à anti-friction.*)

Russell Brewer, New York, U. S., 10th December, 1879, for 5 years.
Claim.—The guide wheels D D, formed with the grooves *d* and flanges *d'* of unequal diameter, in combination with the journal C having disc or flange *a* on its end.

No. 10,735. Improvements in Horse Rakes. (*Perfectionnements aux râteliers à cheval.*)

Augustus C. Kaiser and Hans H. Stangard, St. Charles, Ill., U. S., 10th December, 1879, for 5 years.
Claim.—The bisected axle box C C, bolted to the support D, with the bolt extending in an upwardly inclined position, with or without the flange C'; 2nd. The rake head hinge consisting of the clip *e* having an axis *e*, passing through an eye-bolt *e'*, secured in place by jam nuts *e''*; 3rd. The clutch K K' on the driving or transporting wheel axle, the part K' having an adjustable cam and a lever L, and the part K provided with a projection and a lever J, in combination with the jointed, pivoted and locking levers and the rake head; 4th. The combination, with the lever J on the axle A, of the adjustable cam M, to limit the throw of the rake head.

No. 10,736. Improvements on Churns. (*Perfectionnements aux barattes.*)

John Campbell, Almonte, Ont., 11th December, 1879, (Extension of Patent No. 4,177), for 5 years.

No. 10,737. Improvements in the Manufacture of Paper Dishes. (*Perfectionnements dans la fabrication des plats en papier.*)

Chalmers Ingersoll, Bellot, Wis., U. S., 13th December, 1879, for 5 years.
Claim.—1st. A dish made of a single sheet of paper with the edges turned up to form sides with corrugations decreasing in depth towards, and vanishing at the periphery of the bottom; 2nd. The dies for the manufacture of dishes of paper and like unmaluable materials, the same having at the sides corrugations vanishing at the periphery at the bottom; 3rd. The mode of forming flanged articles of unmaluable material, the same consisting in softening a sheet of the material by moisture, then turning up the edges to form the sides and simultaneously bending said sides to form corrugations, vanishing at or near the periphery of the bottom.

No. 10,738. Improvements on Chains for Transmitting Power. (*Perfectionnements aux chaînes pour la transmission du mouvement.*)

William N. Whitoley, Springfield, Ohio, U. S., 13th December, 1879, for 15 years.
Claim.—1st. A chain composed of a series of links formed so that each link is an exact counterpart of the others; 2nd. The chain link composed of the plates or bars A A connected together, at one end, by the ferrule B and opened, at the other end, to clasp the closed end of the next succeeding link, to which it is attached by the bolt C; 3rd. A chain composed of a series of

links formed and connected together so that the joints constitute a continuous weaver bearing the full length of the chain; 4th. A chain composed of interchangeable links connected together by bolts or rivets C, so that one or more links may be removed or inserted when the chain is taut.

No. 10,739. Method of, and Machine for Framing Doors, &c. (*Méthode d'assemblage des portes, &c., et machine pour cet objet.*)

Jonathan Griesby and John Mills, Lancaster, England, 13th December, 1879, for 5 years.

Claim.—1st. The borer spindles revolving in adjustable carriages, and the table to receive the work arranged to traverse towards the borer spindles; 2nd. The revolving borers, arranged in two parallel lines or sets, and the carriage to receive the work, arranged to traverse to and fro so as to submit the work to the action of the two sets of borers successively; 3rd. The borer spindles arranged in sets in movable carriages which are adjustable, at various distances apart to suit the work; 4th. The table formed in two parts arranged to slide towards and from each other by parallel movements, in order to clamp the work and to tighten the joints; 5th. The table carrying the work, arranged to be lowered and traversed to force in the pins or dowels; 6th. The combination of a table, to receive and clamp together the parts of a door, window frame or other framed wooden article, with a number of borers arranged to bore holes for the wood pins or dowels employed to secure together the said parts.

No. 10,740. Improvements on Turnip Harvesters. (*Perfectionnements aux moissonneuses à navets.*)

John Bartlett, Oshawa, Ont., 13th December, 1879, for 5 years.
Claim.—1st. The topping knife B with the threaded arms C C, with their nuts D D, in combination with the hinged slats B B, and the upright pieces E E; 2nd. The tailing and lifting knife L; 3rd. The frame A with the wheels I I, the topping knife B, the tailing knife L, combined for the purpose of topping, tailing and taking up turnips by horse-power.

No. 10,741. Improvements on Apparatus for Feeding Nail Machines. (*Perfectionnements aux appareils à alimenter les machines à clou.*)

William Briggs, Montreal, Que., 13th December, 1879, for 5 years.
Claim.—1st. In combination with the barrel L, a rack or similar device for revolving said barrel operated by a crank *i* which is, in turn, operated by a crank *d* arranged to have the dead centres of said cranks set as described; 2nd. The combination of the crank *d*, connecting rod *e*, rack *f*, pinion and axle *h*, crank *i*, connecting rod *k* and barrel *L*; 3rd. The combination of the barrel *L* with jaws *m* provided with plate *a*.

No. 10,742. Improvements on Sleds. (*Perfectionnements aux traîneaux.*)

James H. Dennis, Newark, N. J., U. S., 13th December, 1879, for 5 years.
Claim.—The combination of the sled frame A, the sweeps E, arranged in row-locks on the rails *d*, and the hand wheel device F G at the rear.

No. 10,743. Improvements on Car-Couplers. (*Perfectionnements aux attelages des wagons.*)

James G. Scott, Chicoutimi, Que., 13th December, 1879, for 5 years.
Claim.—1st. A draw bar A, constructed with an upward projection *a*, having a flat face in line with the pin hole; 2nd. A coupling pin constructed with a head having a groove *g* and a flat side *b*; 3rd. A coupling pin, having a projection *d* on the shank, in combination with a recess in the draw bar, whereby the pin is prevented from rising; 4th. The draw bar A, having projection *a* and draw pin having a flat face *b* in contact therewith, in combination with shackle B engaging with the pin head; 5th. The combination, with the draw bar A, of the shackle B having arms *e*, and shafts *g* having slotted arms *f* engaging with the arms *e*, for uncoupling from either side of the car.

No. 10,744. Improvements on Weighing Scales. (*Perfectionnements aux balances.*)

Henry H. Ham, jr., and Elbridge G. Pierce, jr., Portsmouth, N. H., U. S., 13th December, 1879, for 5 years.
Claim.—1st. The combination, with the rearward slotted extension A' of the bed A, of the supplementary bed B, screws *b* *b*, longitudinally adjustable and slotted cylindrical case F, shaft *d* carrying the scale-pan cylinder G, said shaft having its bearings in projections attached to the bed F, scale beam B and sliding weight H having a pointer *t*; 2nd. The combination, with a weighing scale, of a scale-pan cylinder having no tangible connection with any of the balancing levers of the scale.

No. 10,745. Improvements on Bicycles. (*Perfectionnements aux velocipèdes.*)

Edward C. F. Otto, Peckham, Eng., 16th December, 1879, for 5 years.
Claim.—1st. The improved construction of bicycle; 2nd. The improved position and arrangement of the seat, in combination with the treadle straps whereby perfect equilibrium is maintained and great facilities afforded for travelling over roads and surmounting obstacles hitherto impracticable for bicycles; 3rd. The improved arrangements of steering gear whereby the driving wheels are instantaneously converted into steering wheels and vice versa; 4th. The improved arrangement for shortening and lengthening the steering rods; 5th. The improved arrangements for the application of brake power whereby perfect control over the bicycle is maintained.

No. 10,746. Improvements in Apparatus for Ringing Alarm Bells on Buoys.*(Perfectionnements aux appareils à sonner les cloches d'alarme sur les bouées.)*

Henry Brown, Frederick W. Wagener and George A. Wagener, Charleston, S. C., U.S., 16th December, 1879, for 15 years.

Claim.—1st. The combination, with the bell, of a grooved disk carrying a ball for striking the bell; 2nd. The combination of the rigidly suspended bell, the grooved disk, the ball and the ball retracting springs.**No. 10,747. Improvements in Grinding Mills.***(Perfectionnements aux moulins à blé.)*

Jacob Dreisigaker, (Assignee of Ezra Rhodes,) Erie, Penn., U.S., 16th December, 1879, for 5 years.

Claim.—1st. The plates H provided with flanges J and hubs I, in combination with cylinder A, shaft F, burr E and nuts G; 2nd. The cylinder A provided with hopper M, spout C, concave plate D hung as described, in combination with plates H provided with flanges J and hubs I, and with shaft F provided with burr E, wheel K and a crank for turning the shaft.**No. 10,748. Self-binding Harvester.** *(Moissonneuse-lieuse.)*

James F. Gordon, Rochester, N. Y., U. S., 18th December, 1879, (Extension of Patent No. 4,193,) for 5 years.

No. 10,749. Self-binding Harvester. *(Moissonneuse-lieuse.)*

James F. Gordon, Rochester, N. Y., U. S., 19th December, 1879, (Extension of Patent No. 4,193,) for 5 years.

No. 10,750. Bed Spring. *(Resort de lit.)*

William Jones, Philadelphia, Pa., U. S., 22nd December, 1879, (Extension of Patent No. 4,202,) for 5 years.

No. 10,751. Improvements in Vehicles. *(Perfectionnements aux voitures.)*

Daniel Conboy, Uxbridge, Ont., 24th December, 1879, (Extension of Patent No. 4,260,) for 5 years.

No. 10,752. Improvements on Fifth Wheels for Vehicles. *(Perfectionnements aux rouls d'avant-train des voitures.)*

Charles G. Wells, Hartford, Ct., U. S., 24th December, 1879, for 5 years.

Claim.—The axle plate *a* attached to the axle, the head block plate *b* extending into the strap *f* and attached to the head block, and the annulus *c* and annular flange *e* under, and attached to the head block plate.**No. 10,753. Improvements on Windmills.***(Perfectionnements aux moulins à vent.)*

William Forbes, Plainwell, Mich., U. S., 24th December, 1879, for 5 years.

Claim.—1st. The combination of the weights F, rods E *e* *e* and slotted plates G *g* with the ropes K and sails I; 2nd. In a windmill having radial arms D provided with pulleys *d* *d* and stops J *j*, the combination of the weights P, rods E *e* having hooks *e* *e*, with the slotted plates G *g* adapted tobe disconnected therefrom, and the ropes K and sails I, so that any one of the sails may be detached from its weight; 3rd. The frame B having recess *b* and friction rollers *b* *b* *b* *b*, in combination with shaft C, disc C, arms D, sails I and weights G; 4th. The masts H serving the double function of supporting the sail and acting as a shaft for the pulley *d*, in combination with the sails I *i* and weights F.**No. 10,754. Improvements on Horseshoes.***(Perfectionnements aux fers à cheval.)*

John Vandegrift and Andrew J. Brown, Langhorne, Penn., U. S., 24th December, 1879, for 5 years.

Claim.—1st. In combination with a horseshoe having the screw bar B, the guide and protecting plate C welded to one of the heel calks and having the other heel calk bearing thereon; 2nd. The horseshoe made in one piece and having the calks *a* *a*, screw bar B, plate C and projection *c* *c*.**No. 10,755. Improvements on Cider Presses.***(Perfectionnements aux pressoirs à cidre.)*

David W. Witmer, Plattsville, Ont., 24th December, 1879, for 5 years.

Claim.—The combination of the blocks E E and F together with the screw A and nut B.**No. 10,756. Improvements on Ammunition Cases.** *(Perfectionnements aux caisses à munitions.)*

Oscar K. Buckhout, Kalamazoo, Mich., U. S., 24th December, 1879, for 5 years.

Claim.—A rectangular case containing shot compartments L L provided with powder-flask receptacle T, powder flask C and metallic-lined drawers D having lids or covers *e*.**No. 10,757. Improvements on Reaping Machines.** *(Perfectionnements aux moissonneuses.)*

Francis J. Craig, Strathroy, Ont., 24th December, 1879, for 5 years.

Claim.—The shive wheel C, when fastened to the side of the reaper frame B B and placed between the reaper table E *e* and the lifting lever A; the combination of the shive wheel C C with the lifting lever and short arm A, with the chain passing over the shive wheel and attached to the reaper table, at H, and the lifting lever, at the point G.**No. 10,758. Improvements on Spring Beds.***(Perfectionnements aux lits à ressorts.)*

Henry B. Clark, Ingersoll, Ont., 24th December, 1879, for 5 years.

Claim.—The long bar A with the braces B B B, properly formed, in combination with the attachment of the braces B B B, and of the spiral springs to the long bar A.**No. 10,759. Improvements in Boots.** *(Perfectionnements dans les bottes.)*

Michael C. Mullarky and Edmond Parent, Montreal, Que., 24th December, 1879, for 5 years.

Claim.—The blank A B comprising the leg and vamp of a boot, arranged in the manner, and cut of the outline shown.

List of Patents issued up to 18th January, 1880, but not yet Officially published in the Patent Office Record.

- No. 10,767. J. C. Blackett, Glace Bay, N. S., "Sewing Machine Spinning and Twisting Attachment," 31st December, 1879.
- No. 10,768. C. E. Brush, Toronto, Ont. (Assignee of C. C. Shelby, New York, U. S. A.), "Sack Supporter," 31st December, 1879.
- No. 10,769. J. M. Foss, St. Albans, Vt., and W. J. Watson, Chicago, Ill., U. S. A., "Safety Car Link," 31st December, 1879.
- No. 10,770. J. H. McLean and T. Hostetter, St. Louis, Miss., U. S. A., "Self-Lubricating Journals and Bearings," 31st December, 1879.
- No. 10,771. A. B. Davis and W. B. Whitney, Philadelphia, Penn., U. S. A., "Reversible Car Spring," 31st December, 1879.
- No. 10,772. J. Reckendarfer, (Assignee of J. Hoffman, New York, U. S. A.), "Lead and Crayon Holder," 31st December, 1879.
- No. 10,773. T. Clark, Truro, N. S., "Live Stock Freight Car," 31st December, 1879.
- No. 10,774. E. D. Shaffer, Moncton, N. B., "Freight Car," 31st December, 1879.
- No. 10,775. M. Bray, Newton, Mass., U. S. A., "Rivet Setting Machine," 31st December, 1879.
- No. 10,776. J. Lennerton, Princeport, N. S., "Treenail Wedge Machine," (Extension of Patent No. 4,222), 31st December, 1879.
- No. 10,777. J. M. Rhodes, Hancock, Mich., U. S. A., "Fracture Bed and Apparatus," (Extension of Patent No. 4,281), 2nd January, 1880.
- No. 10,778. R. M. Wanzer (Assignee of J. Jamieson, Hamilton, Ont.), (Extension of Patent No. 4,231), "Sewing Machine," 2nd January, 1880.
- No. 10,779. D. D. Ferguson and J. S. Loughin, Alvinston, Ont., "Churn," 5th January, 1880.
- No. 10,780. J. Popham and J. Linton, Montreal, Que., "Riveted Seam for Boots and Shoes," 10th January, 1880.
- No. 10,781. G. J. Atford, Bastard, Ont., "Lever Gate," 10th January, 1880.
- No. 10,782. V. Forester, Cranbrook, Ont. (Assignee of S. C. Welty, Ligouier, Ind., U. S. A.), "Horse Collar Facing," 10th January, 1880.
- No. 10,783. T. F. Wilkins, London, England, "Butter Preserving Process," 10th January, 1880.
- No. 10,784. A. E. Wait, Woonsocket, R. I., U. S. A., "Improvements on Bobbins," 10th January, 1880.
- No. 10,785. S. Hayward, St. John, (Assignee of W. A. Pitt, Kingston, N. B.), "Snaths Pictures," 10th January, 1880.
- No. 10,786. A. Graham, (Assignee of W. H. Moses, Shawsville, Va., U. S. A.), "Process of Cleaning Bolting Cloth," 10th January, 1880.
- No. 10,787. E. W. Potter, Smith's Cove, and Hon. E. R. Oakes, Digby, N. S., "Process for Curing and Preparing Finnan Haddies for Canning," 10th January, 1880.
- No. 10,788. T. T. Johnston, Molesworth, Ont., "Sick Room Lamp," 10th January, 1880.
- No. 10,789. G. M. Patten, Holbrook, Mass., U. S. A., "Seal Lock," 10th January, 1880.
- No. 10,790. C. Costello, Beverly, Ont., "Threshing Machine Tooth," 10th January, 1880.
- No. 10,791. T. A. Edison, Menlo Park, N. J., U. S. A., "Electric Lamp," 10th January, 1880.
- No. 10,792. F. Blake, jr., Weston, Mass., U. S. A., "Electric Signals," 10th January, 1880.
- No. 10,793. J. W. Pyne, Cincinnati, Ohio, U. S. A., "Middlings Separators," 10th January, 1880.
- No. 10,794. H. Burgess, Royer's Ford, Penn., U. S. A., "Pipe Covering and Machine for Making Same," 10th January, 1880.
- No. 10,795. S. A. Bates, Pittsburg, Penn., U. S. A., "Elevator," 10th January, 1880.
- No. 10,796. E. Wasell, Loudon, Ont., "Rail Trusses," (Extension of Patent No. 4,379), 10th January, 1880.
- No. 10,797. D. D. Cattanaeh, Providence, R. I., U. S. A., "Oil Process," (Extension of Patent No. 4,297), 10th January, 1880.
- No. 10,798. R. Eickemeyer, Yonkers, N. Y., U. S. A., "Mowing Machine," 11th January, 1880.
- No. 10,799. M. A. Keller, Brockport, N. Y., U. S. A., "Gleaner and Binder," 11th January, 1880.
- No. 10,800. L. D. West, West Valley, N. Y., U. S. A., "Barrel Stand," 11th January, 1880.
- No. 10,801. J. R. Mitchell, Melton, Ont., "Fanning Mill," 11th January, 1880.
- No. 10,802. W. B. Malcolm, Toronto, Ont., "Equalizing Gas Jet Regulator," 11th January, 1880.
- No. 10,803. E. S. Mauny, Beauharnois, Que., "Horse Power," 11th January, 1880.
- No. 10,804. A. Gardener, Hamilton, Ont., "Memorandum Book," 11th January, 1880.
- No. 10,805. J. Lewis, Manchester, England, "Water Meter and Motor," (Extension of Patent No. 4,328), 11th January, 1880.
- No. 10,806. G. S. Sheffield, Three Rivers, Mich., U. S. A., "Hand Car," 11th January, 1880.
- No. 10,807. F. Richardson, Providence, R. I., U. S. A., "Boot and Shoe Heels," 16th January, 1880.
- No. 10,808. J. L. Campbell, West Elizabeth, Penn., U. S. A., "Incubator," 16th January, 1880.
- No. 10,809. W. S. Colwell, Pittsburg, Penn., U. S. A., "Motor and Apparatus for Utilizing it," 16th January, 1880.
- No. 10,810. G. Piggott, Bowanville, O., "Reed Organ," 16th January, 1880.
- No. 10,811. T. Campbell, St. John, N. B., "Compression Cock for Water Basins," 16th January, 1880.
- No. 10,812. J. Z. C. Miquelon, St. Camille, Q., "Permutation Locks," 16th January, 1880.
- No. 10,813. D. Johnson, Wrexham, Wales, "Manufacture of Aerated and other Beverages," 16th January, 1880.
- No. 10,814. C. L. Travis, Minneapolis, Min., U. S. A., "Grain Binding Machine," 16th January, 1880.
- No. 10,815. W. S. Colwell, Pittsburg, Penn., U. S. A., "Motor for Locomotives, &c.," 16th January, 1880.
- No. 10,816. L. Thurston and Jay Vandenburg, Findlay, O., U. S. A., "Sun Dial," 17th January, 1880.
- No. 10,817. G. McCord, New York, U. S. A., "Skate," 17th January, 1880.
- No. 10,818. Ogle Carss, Smith's Falls, O., "Animal Trap," 17th January, 1880.
- No. 10,819. C. E. Brush, Toronto, Ont. (Assignee of C. C. Shelby, New York, U. S. A.), "Metallic Fastening for Under Garments, &c.," 17th January, 1880.
- No. 10,820. W. S. Colwell, Pittsburg, Penn., U. S. A., "Motor and Apparatus for Utilizing it," 17th January, 1880.
- No. 10,821. F. Hadley, Toronto, O., "Book Binding," 17th January, 1880.
- No. 10,822. J. Kennedy, Toronto, O., "Packing Boxes for Valve Spindles, &c.," 17th January, 1880.
- No. 10,823. H. A. Ste. Marie, Montreal, Q., "Hand Scrubber," 17th January, 1880.
- No. 10,824. C. McBean, Toronto, O., "Compass for Scribing Ovals and Ellipses," 17th January, 1880.
- No. 10,825. D. Carmichael, jr., Mariposa, O., "Anti-Friction Pitts Power," 17th January, 1880.
- No. 10,826. M. Garvin, Newcastle, O., "Mowing Machine," 17th January, 1880.
- No. 10,827. M. Johnson, Lockport, N. Y., U. S. A., "Hand Trucks," 17th January, 1880.
- No. 10,828. A. H. Ordway, Haverhill, Mass., U. S. A., "Oscillating Chair," 17th January, 1880.
- No. 10,829. C. J. Shirreff, (Assignee of J. R. Smith and P. W. Strong,) Brockville, O., "Paper Box," 17th January, 1880.
- No. 10,830. H. and W. Turner, Montreal, Q., "Pantaloons Suspensers," 18th January, 1880.
- No. 10,831. W. F. Dial and L. H. Pacard, Montreal, Q., "Files," 18th January, 1880.

INDEX OF INVENTIONS.

Alarm bells, ringing, H. Brown et al.....	10,746
Baths, shower, D. Deshon.....	10,713
Bean pickers, T. Barnes.....	10,782
Beds, spring, H. B. Clark.....	10,758
Bells, ringing alarm, H. Brown et al.....	10,746
Bicycles, E. C. F. Otto.....	10,745
Blocks, sawmill head, B. E. Sergeant.....	10,728
Boots, M. C. Mullarky et al.....	10,759
" and shoes, J. Hogue.....	10,721
" " M. A. C. Holmes.....	10,723
" long leg, R. Church.....	10,706
Boxes, paper, C. M. Arthur.....	10,724
Brushes, painting, C. W. Meakins.....	10,699
Buggy tops, T. Smith.....	10,722
Car coupling, J. G. Scott.....	10,743
" " J. R. Forsyth.....	10,712
Cases, ammunition, O. K. Buckhout.....	10,756
Chains for transmitting power, W. N. Whiteley.....	10,738
Churns, J. Campbell.....	10,736
" " J. Shaw.....	10,697
Cider presses, D. W. Witmer.....	10,755
Closets, A. Mallory.....	10,707
Collars, horse, S. J. Bowers.....	10,709
Copying apparatus, W. Wallach.....	10,708
Dishes, paper, C. Ingersoll.....	10,737
Door fastener, W. H. Garloch.....	10,704
" framing, J. Gresby et al.....	10,739
" hangers, E. Prescott et al.....	10,727
Drawing, reproducing, A. Ungerer.....	10,719
Gates, fence, S. F. Fenn.....	10,726
Grain separator, F. M. Bissell.....	10,715
Grinding mills, J. Dreisigaker.....	10,747
Harness, C. S. Piersons et al.....	10,730
Harvester, self-binding, J. F. Gordon.....	10,748
" turnip, J. Bartlett.....	10,740
Horse collar, S. J. Bowers.....	10,709
" shoes, J. Vandegrift et al.....	10,754
Journal boxes, anti-friction, R. Brewer.....	10,734
" self-ollers, H. Gillmore.....	10,733
Mouldings, whitening gilt, W. E. Eastman.....	10,698
Nail machine, feeding, W. Briggs.....	10,741
Oil cooling, J. B. Armstrong.....	10,710
Oilers, journal self, H. Gillmore.....	10,733
Ovens, bakers, T. Hunter.....	10,702
Ozone, apparatus, F. W. & G. F. H. Bartlett.....	10,717
Paper ruling, D. Mortimer.....	10,731
Posts, fence, H. M. Beecher.....	10,716
Presses, cider, D. W. Witmer.....	10,755
Rakes, horse, A. C. Kaiser et al.....	10,735
Reaping machines, F. J. Craig.....	10,757
Reflectors, lamp, The American Street Light Reflector Co.....	10,714
Rollers, gate, W. Schwendler.....	10,701
" land, J. A. Kapphelm.....	10,718
Roofs, car, J. C. Wands.....	10,700
Saw-mill head blocks, B. E. Sergeant.....	10,728
Scales, weighing, H. H. Ham, Jr., et al.....	10,744
Sewing machines, S. Y. Love.....	10,696
Signals, railway, J. I. Conklin.....	10,725
Sleds, J. H. Dennis.....	10,742
Sole machine, inner, M. A. C. Holmes.....	10,723
Spark arresters, E. F. E. and C. W. Leonard.....	10,703
Spring, bed, W. Jones.....	10,750
Steel tempering, J. B. Armstrong.....	10,710
Tanning hides and skins, J. Foley.....	10,711
Telephones, electric, A. M. Bell et al.....	10,705
Thrashing machines, F. Kitten.....	10,694
" " R. H. Monteith et al.....	10,729
Trucks, hand, M. Johnson.....	10,695
Vehicles, fifth wheels for, C. G. Wells.....	10,752
" " D. Conboy.....	10,751
Ventilators, car, W. P. Williamson.....	10,720
Wheels for vehicles, fifth, C. G. Wells.....	10,752
Windmills, W. Forbes.....	10,753
Writing, reproducing, A. Ungerer.....	10,719

INDEX TO PATENTEES.

Allen, H. H., fence gates.....	10,726
American Street Light Reflector Co., The, lamp reflectors.....	10,714
Angus, R., spark arresters.....	10,703
Armstrong, J. B., oil cooling.....	10,710
Arthur, C. M., et al., paper boxes.....	10,724
Baker, F. P., whitening gilt mouldings.....	10,698
Ballou, F. D., inner sole machine.....	10,723
Barnes, T., bean pickers.....	10,732
Bartlett, F. W. and G. F. H., ozone apparatus.....	10,717
" " J., turnip harvesters.....	10,740
Beecher, H. M., fence posts.....	10,716
Bell, A. G., electric telephones.....	10,705
" " A. M., et al., ".....	"
Bissell, F. M., grain separators.....	10,715
Bowers, S. J., horse collars.....	10,709
Brewer, R., anti-friction journal boxes.....	10,734
Briggs, W., nail machine, feeding.....	10,741
Brown, A. J., et al., horseshoes.....	10,754
" " H., et al., ringing alarm bells.....	10,746
Buckhout, O. K., ammunition cases.....	10,756
Campbell, J., churns.....	10,736
Church, R., long legged boots.....	10,706
Clark, H. B., spring beds.....	10,758
Conboy, D., vehicles.....	10,751
Conklin, J. I., railway signals.....	10,725
Craig, F. J., reaping machines.....	10,757
Dennis, J. H., sleds.....	10,742
Deshon, D., shower baths.....	10,713
Dreisigaker, J., grinding mills.....	10,747
Eastman, W. E., whitening gilt mouldings.....	10,698
Fenn, S. T., fence gates.....	10,726
Ferris, C., et al., harness.....	10,730
Forbes, W., windmills.....	10,753
Forsyth, J. R., car couplers.....	10,712
Frerice, D., et al., gate rollers.....	10,701
Garloch, W. H., door fasteners.....	10,704
Gillmore, H., journal self ollers.....	10,733
Gordon, J. F., self-binding harvester.....	10,748
Gregory, G. W., et al., door hangers.....	10,727
Gresby, J., et al., door framing.....	10,739
Ham, H. H., Jr., et al., weighing scales.....	10,744
Hogue, J., boots and shoes.....	10,721
Holmes, M. A. C., inner sole machine.....	10,723
Hunner, J., et al., thrashing machines.....	10,729
Hunter, T., bakers' ovens.....	10,702
Ingersoll, C., paper dishes.....	10,737
Johnson, M., hand trucks.....	10,695
Jones, W., bed spring.....	10,750
Kaiser, A. C., et al., horse rakes.....	10,735
Kapphelm, J. A., land rollers.....	10,718
Kitten, F., thrashing machines.....	10,694
Leonard, E. F. E. and C. W., spark arrester.....	10,703
Love, S. Y., sewing machines.....	10,696
Mallory, A., closets.....	10,707
Meakins, C. W., painting brushes.....	10,699
Mill, J., et al., door framing.....	10,739
Monteith, R. H., et al., thrashing machines.....	10,720
Mortimer, D., paper ruling.....	10,731
Mullarky, M. C., et al., boots.....	10,759
Otto, E. C. F., bicycles.....	10,745
Pierce, E. B., Jr., et al., weighing scales.....	10,744
Piersons, C. S., et al., harness.....	10,730
Prescott, E., et al., door hangers.....	10,727
Rhodes, E., grinding mills.....	10,747
Robinson, C., lamp reflectors.....	10,714
Schwendler, W., et al., gate rollers.....	10,701
Scott, J. G., car couplers.....	10,743
Sergeant, B. E., saw mill head blocks.....	10,728
Shaw, J., churns.....	10,697
Shepherd, B. C., et al., paper boxes.....	10,724
Smart, A. and E., et al., ".....	"
Smith, T., buggy tops.....	10,722
Stangaard, H. H., et al., horse rakes.....	10,735
Ungerer, A., writing reproducing.....	10,719
Vandegrift, J., et al., horseshoes.....	10,754
Wagener, F. W. and G. A., et al., ringing alarm bells.....	10,746
Wallach, W., copying apparatus.....	10,708
Wands, J. C., car roofs.....	10,700
Warren, W., et al., harness.....	10,730
Wells, C. G., fifth wheels for vehicles.....	10,752
Whiteley, W. N., chains for transmitting power.....	10,738
Williams, C., Jr., et al., electric telephones.....	10,705
Williamson, W. P., car ventilators.....	10,720
Witmer, D. W., cider presses.....	10,755

CANADIAN PATENT OFFICE RECORD.

ILLUSTRATIONS.

Vol. VIII.

JANUARY, 1880.

No. 1.

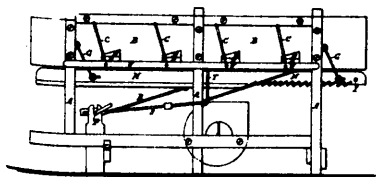

10684 Kitten's Improvements in Threshing Machines.

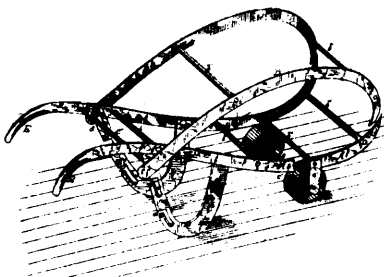

10695 Johnson's Improvements on Hand Trucks.

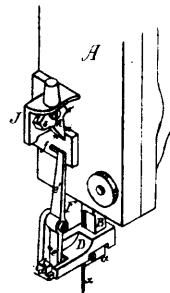

10696 Love's Improvements on Sewing-Machines.

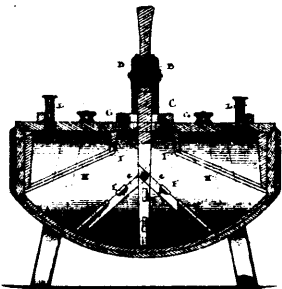

10697 Shaw's Improvements in Churns.

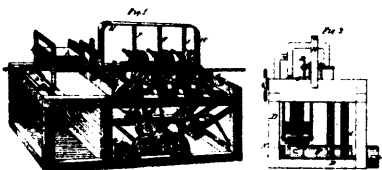

10698 Baker's Machine for Whitening Gill Mouldings.

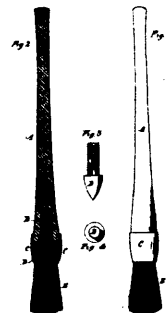

10699 Meakins' Improvements in Paint Brushes.

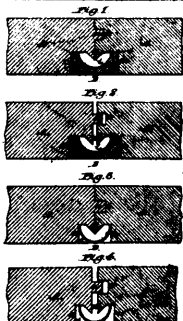

10700 Wands' Improvements on Car Roofs.

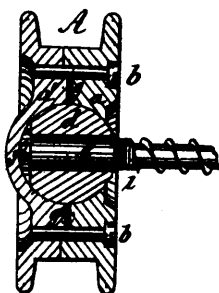

10701 Schwendler & Frerice's Improvements on Gate Rollers.

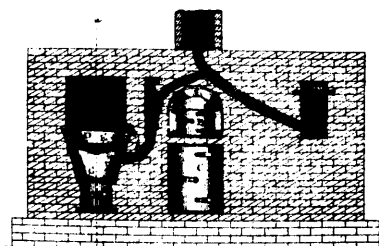

10702 Hunter's Improvements in Bakers' Ovens.

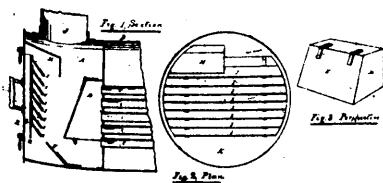

10703 Leonard & Angus' Improvements in Spark Arresters.

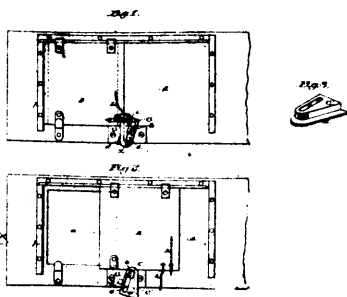

10704 Garlock's Improvements in Door Fasteners.

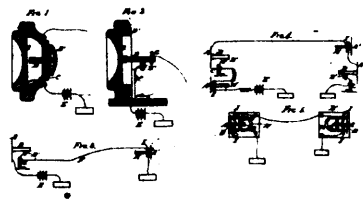

10705 Bell's Improvements on Electric Telephones.

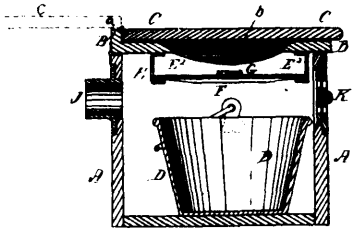

10707 Mallory's Improvements on Closets.

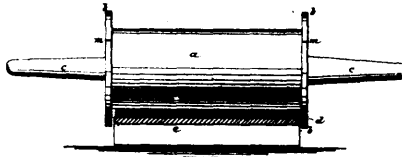

10708 Wallach's Improvements on Copying Apparatus.

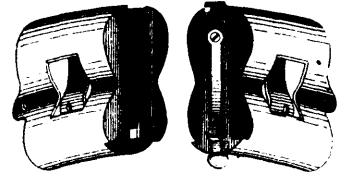

10709 Bowers' Improvements in Horse Collars.

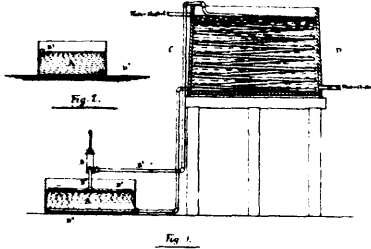

10710 Armstrong's Process and Apparatus for Cooling Oil in Tempering Steel.

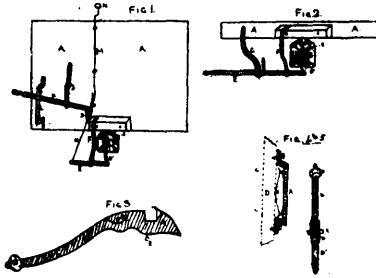

10712 Forsyth's Improvements on Car-Couplers.

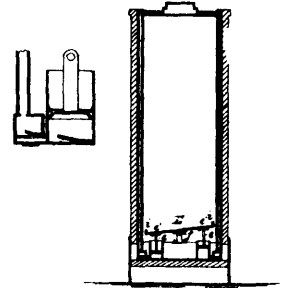

10713 Deshon's Improvements on Shower Baths

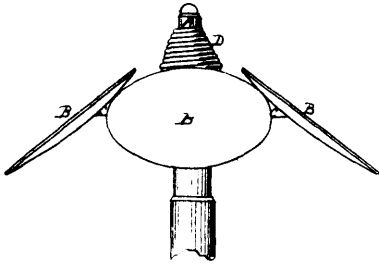

10714 Robinson's Improvements on Lamp Reflectors.

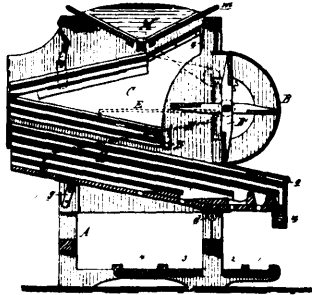

10715 Bissell's Improvement on Grain Separators.

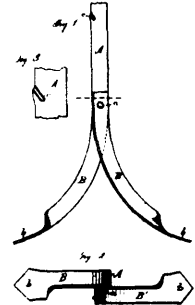

10716 Beecher's Improvements on Fence Posts.

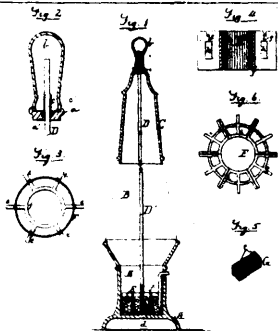

10717 Bartlett's Improvements on Ozone Apparatus

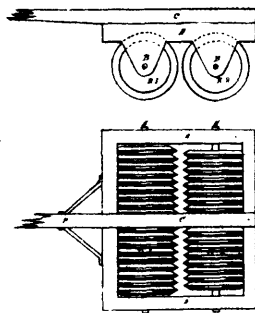

10718 Kaybach's Improvements on Land Rollers.

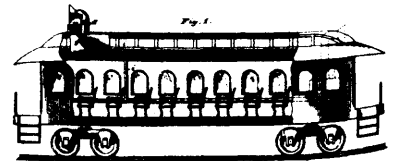

10720 Williamson's Improvement in Car Ventilators.



10721 Hogue's Improvements in the Manufacture of Boots and Shoes.



10722 Smith's Improvements on Buggy Tops.

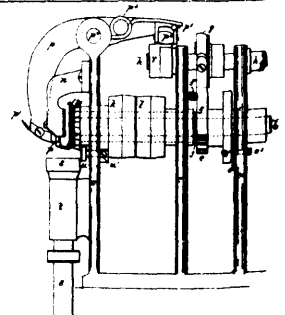

10723 Ballou's Machine for Making the Inner Soles of Boots and Shoes.

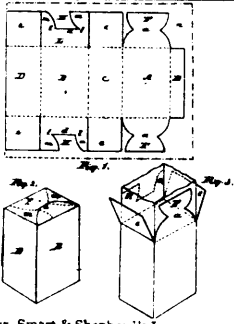

10724 Arthur, Smart & Shepherd's Improvements on Paper Boxes.

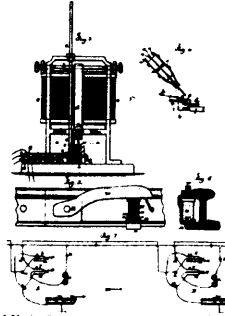

10725 Conklin's Improvements on Electric Signals for Railways.

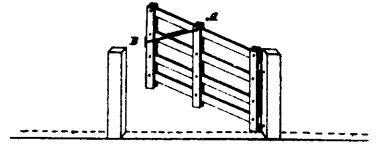

10726 Allen's Improvements on Fence Gates.

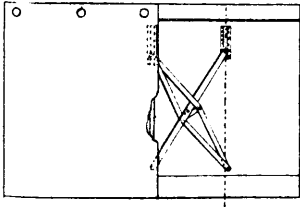

10727 Prescott & Gregory's Improvements on Door Hangers.

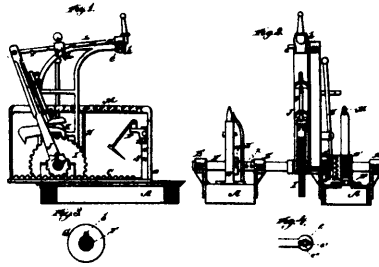

10728 Sergeant's Improvements on Saw Mill Head Blocks.

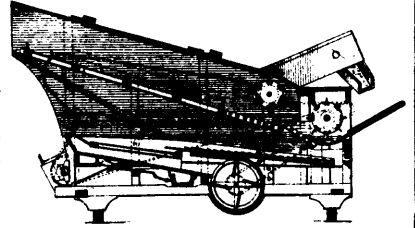

10729 Monteith & Hunner's Improvements on Threshing Machines.



10730 Pierson, Ferris & Warren's Improvements on Harness.

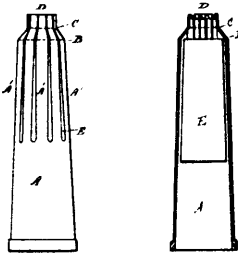

10732 Barnes' Improvements on Bean Pickers.

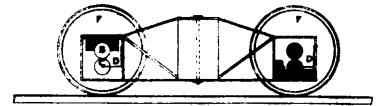

10733 Gilmore's Improvements on Self Oilers for the Journals of Railway Cars.

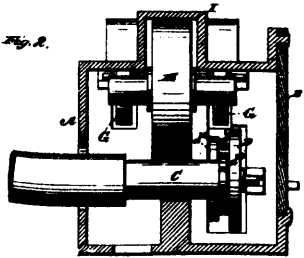

10734 Brewer's Improvements in Anti-Friction Journal Boxes.

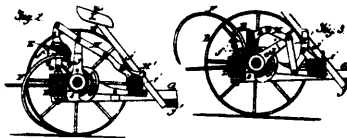

10735 Kaiser & Stangaard's Improvements in Horse Rakes

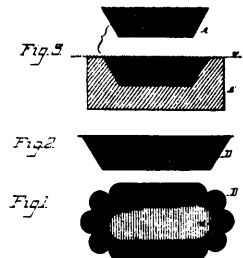

10737 Ingersoll's Improvements in the Manufacture of Paper Dishes.

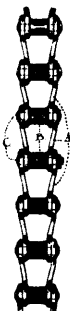

10738 Whiteley's Improvements on Chains for Transmitting Power.

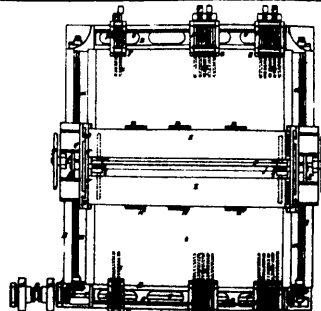

10739 Gresby & Mills' Method of, and Machine for Framing Doors, &c.

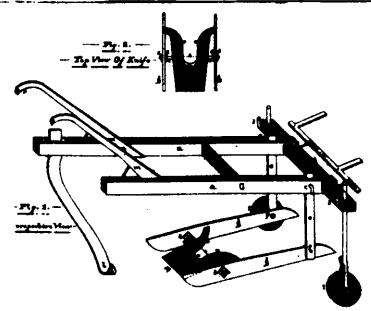

10740 Bartlett's Improvements on Turnip Harvesters.

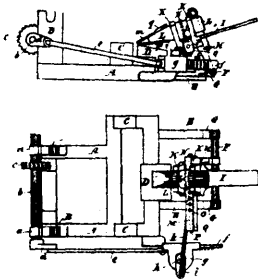

10741 Briggs' Improvements on Apparatus for Feeding Nail Machines.

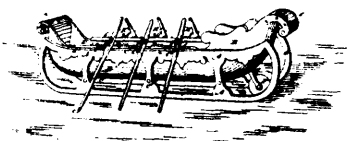

10742 Dennis' Improvements on Sleds.

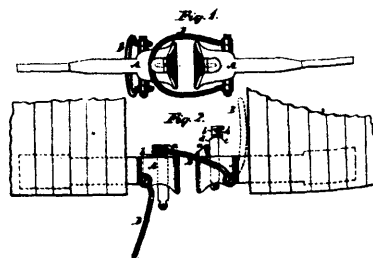

10743 Scott's Improvements on Car-Couplers.

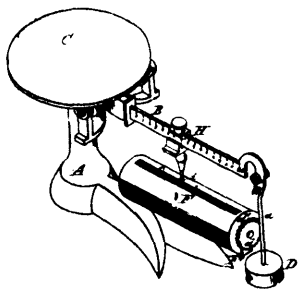

10744 Ham & Pierce's Improvements on Weighing Scales.

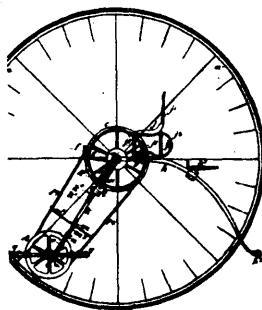

10745 Otto's Improvements on Bicycles.

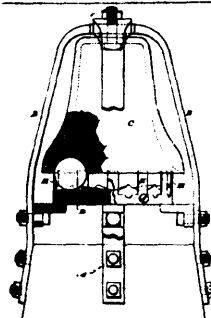

10746 Brown & Wagener's Improvements in Apparatus for Ringing Alarm Bells on Buoys.

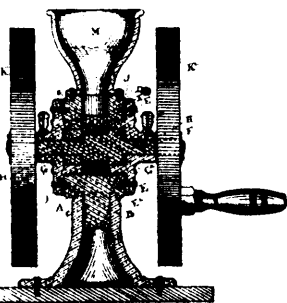

10747 Rhodes' Improvements in Grinding Mills.

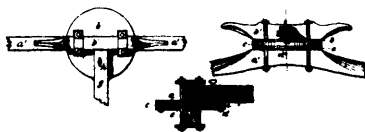

10752 Wells' Improvements on Fifth Wheels for Vehicles.

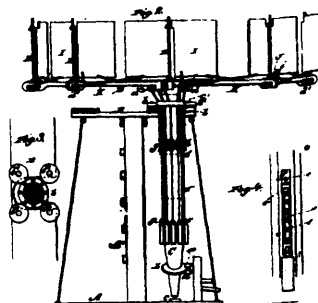

10753 Forbes' Improvements on Windmills

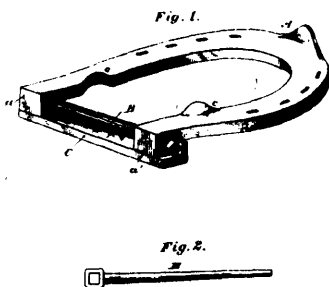

10754 Vandegrift's Improvements on Horse shoes.

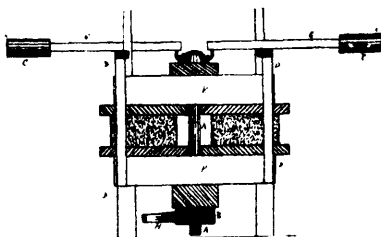

10755 Witmer's Improvements on Cider Presses.

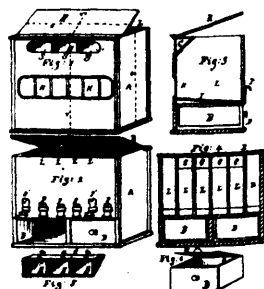

10756 Buckhout's Improvements on Ammunition Cases.

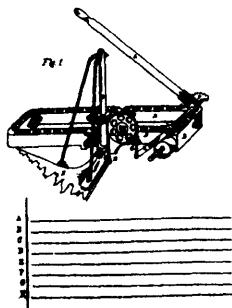

10757 Craig's Improvements on Reaping Machines.

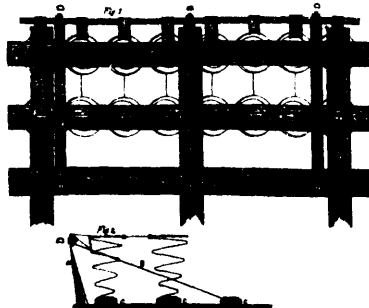

10758 Clark's Improvements on Spring Beds.

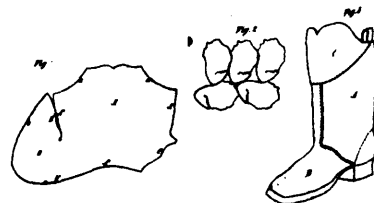

10759 Mullarky & Parent's Improvements in Boots.