

# BULLETINS

OF THE

## Aerial Experiment Association

Bulletin No. XXXIV Issued MONDAY, MARCH 1 1908

MR. McCURDY'S COPY.

BEINN BHREAGH, NEAR BADDECK, NOVA SCOTIA

BULLETIN STAFF.

ALEXANDER GRAHAM BELL.....Editor  
GARDINER H. BELL.....Assistant Editor  
CHARLES R. COX.....Typewriter  
MABEL B. McCURDY.....Stenographer

Bulletins of the Aerial Experiment Association.

-----000-----

BULLETIN NO. XXXIV ISSUED MONDAY MARCH 1, 1909.

-----000-----

Printed at the Press of the University of Toronto, Toronto, Ontario.

TABLE OF CONTENTS.

1. Editorial Notes and Comments:-.....1-15

Feb.16, A Combination Front Control.....1-1  
 Feb.19, Russian Propeller.....1-2  
 Feb.19, Drome No.5, Bell's Cygnet II.....2-7  
 Feb.19, The Plans of the A.E.A.....7-8  
 Feb.20, Suggested Plan for converting the  
 Association into a Joint-Stock Co.....9-13  
 Feb.22, First Trial of Cygnet II.....14-14  
 Feb.23, First flight of Silver-Dart in  
 Canada.....15-15  
 Feb.24, Second Flight of Silver-Dart.....15-15  
 Feb.26, Departures from Beinn Bhreagh.....15-15

2. Work of the A.E.A:-

Experiments Reported by the Editor.....16-32  
 Feb.13, Kite Model of Drome No.6.....16-19  
 Feb.13, Kite Model of Drome No.5.....19-21  
 Feb.16, Hydrodrome Toy.....22-22  
 Feb.19, Flying Toy.....22-23  
 Feb.22, First Trial of Cygnet II.....24-26  
 Feb.23, First Trial of Silver-Dart.....27-30  
 Feb.24, Second Trial of Silver-Dart.....30-31  
 Feb.24, Second Trial of Cygnet II.....31-32

Original Papers:-.....33-49

Feb.12, Concerning Propellers: Their rel-  
 ative position to the aeroplanes:-  
 By Gardiner H. Bell.....33-36  
 Feb.13, Front Controls:-  
 By V. W. Baldwin.....37-39  
 Feb.15, Flying-Machines Commercially:-  
 By G.H. Curtiss.....40-41  
 Feb.16, Struts, Chords, and Trussed Ribs:  
 By J.A.D. McCurdy.....42-44  
 Feb.24, A new game with flying-toy:-  
 By Gardiner H. Bell.....45-45  
 Feb.25, Aerodrome Motors:-  
 By G. H. Curtiss.....46-49  
 Feb.26, A Combination Front Control:-  
 By Gardiner H. Bell.....50-51

Illustrations of the Work of the A.E.A.....52-60

3. Miscellaneous Communications:-

4. The Outlook on Aviation:-

(Continued on next page).

ILLUSTRATIONS.

1. The Silver-Dart at Hammondsport. Three photos. Upper picture reading from left to right, Mr. Kimbal, Sec. Aeronautical Soc., N.Y., Dr. Bell, Mr. McCurdy, Mr. Jones, Editor of Aeronautics, Mr. Curtiss, and Mr. James Means, Editor of the Aeronautical Annual standing in front of the Silver-Dart at Hammondsport, Dec. 20, 1908. Middle picture, shed for the Silver-Dart at Hammondsport in process of construction. Lower picture, flight of the Silver-Dart at Hammondsport, Dec. 17, 1908. McCurdy Aviator.....52
2. Blue print showing brake attached to the ice-boat to prevent a repetition of the accident in which Curtiss was injured.....53
3. Blue print illustrating McCurdy's paper on struts, chords, and trussed ribs.....54
4. Drone No. 5, Bell's Cygnet II on the ice at Baddeck Bay, Feb. 22, 1909. Upper picture, front view showing McCurdy in the aviator's seat. Lower picture, rear view showing the propeller and power plant.....55
5. The power plant of Drone No. 5, Bell's Cygnet II Feb. 22, 1909. Upper picture, power plant from the rear. Lower picture, front view showing McCurdy at the steering wheel.....56
6. First Trial of Drone No. 5, Bell's Cygnet II on the ice on Baddeck Bay, Feb. 22, 1909. The beginning and the end. Upper picture shows beginning with members of Laboratory staff skating after the drone while it is moving forwards over the ice. Lower picture, shows Cygnet II after accident to propeller. The pieces of the propeller were collected together and placed upon the ice near the machine so as to come into the photograph.....57

(Continued on next page).

ILLUSTRATIONS (CONTINUED).

7. First flight in Canada of Drome No. 4, McCurdy's Silver-Dart, Feb. 23, 1909. Upper picture taken by Mr. J. G. Davidson shows the Silver-Dart in the air (Feb. 23) against the sky with Washabuck in the background. The lower picture taken by Mr. Benner (Feb. 23) shows the Silver-Dart just as she was about to alight after her flight, with a portion of Beimn Bthrough in the background.....58
  
8. Second flight of the Silver-Dart over the ice on Baddeck Bay Feb. 24, 1909. McCurdy Aviator. Three photos. Upper picture, gives a near view of the Silver-Dart in the air (Feb. 24) with McCurdy as aviator. Middle picture, shows the Silver-Dart (Feb. 24) at a little greater distance away, off the Baddeck side of the bay opposite the McCurdy Homestead. Lower picture, gives a distant view of the Silver-Dart (Feb. 24) against the Beimn Bthrough shore. The sleigh on the shore contains Mrs. Bell and her party.....59
  
9. Second flight of the Silver-Dart on Baddeck Bay Feb. 24, 1909, the beginning and the end. Upper picture, the beginning. This shows the Silver-Dart with McCurdy on board on its way to the starting place. It will be noticed that Mr. Curtiss, having no skates, has stolen a ride on the machine. Lower picture illustrates the end of the experiment (Feb. 24), showing the condition of the Silver-Dart after landing. The damage is not as great as one would think from the photograph, and at the present date (Feb. 26) the repairs have practically been completed.....60
  
10. Blue print illustrating Mr. Curtiss' Paper on Aerodrome Motors.....61

EDITORIAL NOTES AND COMMENTS.A Combination Front Control.

Feb. 16, 1909:- Gardiner Bell showed us to-day a crude model, which he had made with his own hands, of a front control operated by two levers combining the functions of front control, steering rudder, and balancing rudders. The apparatus was ingenious and suggestive, and I have asked him to give an account of it in this Bulletin. A.G.B.

Russian Propeller.

Feb. 19, 1909:- Mr. Chanute has directed our attention to a new propeller constructed by Col. Gchtchevny of Russia which is stated to have twenty times the efficiency of a perfect screw propeller of equal diameter (see Bulletin XX p.42). The description unfortunately is insufficient to enable us to reproduce the propeller here so as to test the truth of the rather startling statement. Mr. Chanute has been kind enough to write to Russia for further descriptions (see Bulletin XXIX p.4) but with rather poor results, but he now sends us a cutting from a Russian newspaper which purports to give a full description of the propeller; but, as the article is written in the Russian language and is not accompanied by an illustration we can make nothing of it. We hope however, that we may obtain a useful translation from Mr. George Kennan, or from the Russian Embassy in Washington. At present we only know that each blade is shaped

-2-

somewhat like a bird's wing; wide near the hub and narrow at the tip; of concave-convex form; and with the front edge stiff and the rear edge elastic.

The very startling differences observed in Baldwin's experiments between the effects produced by a hydro-curve and a hydroplane (which were hardly distinguishable from one another by eye) have led me to think that there may be some truth in the claim put forth for the Russian bird-wing propeller, and that we should therefore make some experiments with concave-convex propellers stiff at the front edge and elastic at the rear.

I brought the matter up at one of our recent conferences and it was decided to have such a propeller constructed. Mr. Baldwin to-day (Feb. 19) showed us the completed propeller. It is ten feet in diameter and though it does not taper at the end like the Russian propeller it possesses the other features described. We can compare its efficiency comparatively with the 10 ft. propeller to be used on Drome No. 5. I have asked Mr. Baldwin to give us some description of it for this Bulletin. A.G.B.

Drome No. 5 - Bell's Gyro II.

Feb. 19, 1909:- The new Curtiss engine has been installed on Drome No. 5, and the ten-foot propeller is ready for attachment.

A large number of young people from the Baddeck Academy visited the Laboratory to-day and were shown the machine.



-3-

I took advantage of their presence to give the aerodrome a specific name, and called it Cygnet the Second. It will now be known officially as "Drome No.5, Bell's Cygnet II".

Mr. Brenner, a Hammondsport photographer, arrived at Beinn Bhreagh to-day in time to take a photograph of the assemblage. A.G.B.

#### The Plans of the A.E.A.

Feb. 19, 1909:- The time for concluding the Experimental work of the Association has very nearly come, and it is obvious that we will have no more than time to complete the experiments already planned out, if indeed we have time enough for that.

(1) We must try Drome No.5, Bell's Cygnet II, as soon as possible so as to get some idea of what we can do with an aerodrome of pure tetrahedral construction without any horizontal surfaces. The conditions unfortunately are very different from those originally contemplated. The structure itself is much heavier than would be necessary if we were to fly it as a kite. Without any engine or man it now weighs 400 lbs. What it will weigh with engine and man and all the accessories is problematical, probably more than twice as much. It is obvious that the structure, with man and engine, will be altogether too heavy to be flown as a kite in the way Cygnet No.I was flown. Besides the season is not suitable for such an experiment as we would have to depend upon natural wind unaided by the pulling power of a

-4-

steamer, for the Blue Hill is frozen in for the winter. The only thing to do therefore, if we are to make the experiment at all, is to try Drome No. 5 on the ice as the "Red Wing" was tried on Lake Keuka. Even here it becomes obvious that the machine is too heavy to afford much hope of success. All we can do however is to try it and see what will result.

(2) Immediately after the trial we should push our Drome No. 6 to completion as far as possible by constructing the aerial part of the apparatus on the basis of the Oionos Kite. It will take some time to make this structure and, while it is being made, we can make experiments on the ice with McCurdy's "Silver-Dart".

We can try the Oionos structure quite independently of the boat part, if desired, upon the ice. If the ice leaves us before we are ready, the open water will be left and we can try it upon the "Query". This is really all the experimental work that we can contemplate, but we can utilize our time by sandwiching in experiments upon propellers upon the ice-boat, in testing various other points, and in trying toys.

The original object of the Association was simply "To get into the air". This object has been fully accomplished even though we should meet with no further success with Nos. 5 and 6. We have made four aerodromes, each of which has successfully flown, propelled by its own motive power and carrying a man. Without any further experiments therefore we are prepared to construct flying-machines that

we know will fly. We have applied for patents upon these machines and upon our success in obtaining patents will depend the possibility of our getting outside capital to put our machines into commercial use.

It is obvious, however, that we could at once begin to obtain pecuniary returns by exhibitions of the two successful machines we possess, Curtiss' "Jane Bug" and McCurdy's "Silver-Dart". The only difficulty in doing so is the fact that is very obvious to my mind that the moment we begin to make money by the construction or exhibition of aerodromes we will find ourselves involved in litigation with the Wright Brothers and others, and it would not be wise upon our part to attempt anything of the kind without having sufficient capital at command to protect us should litigation arise. I am very much averse to attempting to make money under our present organization, or under any organization that would throw the financial responsibility upon me alone, for I am the only member of the Association that could be touched in the matter. If we are to do anything immediately in a commercial way we shall have to begin without the protection of patents for it will take a long time for the Patent Office to pass finally upon our pending applications. We have no funds, as an Association, even to pay the cost of applying for patents, and without a patent, or the assured prospect of obtaining one, it is extremely unlikely that we can get outside capital into the enterprise.

I think that we better consider some proposition to submit to Mr. Charles J. Bell, our Trustee, upon this matter. It would not take any large amount of money to start exhibitions of the "June Bug" and "Silver-Dart", and to begin the building of another aerodrome, but such work must necessarily be done under the auspices of an organized Company.

The questions then arise,

(1) Shall we go ahead and organize a Company ourselves bringing into it a sufficient amount of capital to begin the work contemplated with the prospect of increasing the capital from outside sources when patents have been secured?

(2) Shall we attempt to have a special Company organized by outside parties and sell out to that Company our interests in the work of the Association for a certain number of fully paid up shares? I doubt the practicability of this so long as we have no patent.

(3) Shall we sell out our interests in the work of the Association to some Company already organized for shares or cash? This also seems to me to be impracticable until we have secured patents. Without patents we have nothing to sell. When we do sell anything it will be a patent.

Looking the whole matter therefore squarely in the face it seems to me we are confronted by the following conditions. We can do nothing on plans 2 and 3 until we have obtained patents; that is, upon these plans, we must wait months before beginning any commercial exploitation.

On the other hand if we decided to make an immediate commercial exploitation we are reduced to plan 1. That is we

must organize a Company ourselves. In other words, we, the members of the Aerial Experiment Association, including the representative of the Late Lieut. Selfridge, would constitute the Company, and we would have to sell shares to outside parties to obtain the necessary initial capital, which need not be large. It would be necessary, however, to have a large number of shares in the Treasury of the Company to be sold from time to time as capital might be required.

We must face the condition that it will be very difficult to get outside capital to come in excepting in small amounts until after we have obtained patents. In the meantime we would have to risk the possibility and probability of being involved in litigation against our will, and this litigation if it arose would prevent the influx of capital from outside sources by shaking the confidence of would-be inventors.

I see no other way of doing anything practical without delay excepting through a Company organized by ourselves. Whether this is practicable or not depends upon what amount of money would be needed for commercial exploitation during the first year; what amount of money we could have taken up by ourselves and our friends; and upon what amount of money would afford a reasonable assurance against the costs of litigation during the first year.

The idea that is vaguely growing in my mind is that we should organize "The American Aerodrome Company" to exploit the aerodromes evolved by the Aerial Experiment Association and have Mr. Curtiss manage the business end of the

matter.

I would therefore ask Mr. Curtiss what he thinks would be the minimum amount of money required for the first year considering the fact that we have already two aerodromes completed that can be used for exploitation purposes. He should also include in the estimate the manufacture of at least one other aerodrome at Hammondsport. Then let us consider how far it would be possible to raise this amount of money and a sufficient amount more to pay the expenses of a moderate amount of litigation.

Should we find any reasonable prospect of raising this amount it would be worth while formulating a scheme to be presented to Mr. Charles J. Bell (for I very much fear that the initiative in this matter will have to come from us). Mr. C. J. Bell is a busy man, fully occupied with important business matters, and we should not rely too much upon his good will and interest to initiate a plan for us. We should decide first what we want to do; and then submit our plan to him for criticism. If, as a business man, he does not approve, our proposition may stir him up to suggest an alternative plan.

This is the best I can think of at the present time, and I do not think we can occupy the short time remaining to us as an Association to better advantage, than by discussing the question of our entrance into the commercial field.

A.G.B.

Suggested Plan for Converting the Association into  
a Joint-Stock Company.

Feb. 20, 1909:- At a conference held Feb. 19 the foregoing notes concerning "The Plans of the A.K.A" were read and discussed. The idea of converting the Association into a joint-stock company seemed to be received with favor and it was decided to formulate some plans for accomplishing this result to be considered at a subsequent conference. I would therefore suggest the following tentative plan as a basis for discussion:-

Let us proceed to form a company to be known as "The American Aerodrome Company", to be organized under the laws of the State of New York with its headquarters at Hammondsport and with a nominal capital of \$100,000, divided into 1000 shares of the par value of one hundred dollars, or 10,000 shares of the par value of ten dollars - the latter plan might possibly be preferable.

To this Company let the Aerial Experiment Association transfer all its property, and inventions relating to Aerodromics, receiving in return the amount of money it has expended upon experiments, in the form of fully paid up shares, at par and non-assessable. The expenses of patenting the aforesaid inventions to be assumed by the Company.

This would dispose finally of the Association. It would go out of existence and the Company would take its place.

The fully paid up shares of the Company received by the Association would be distributed as follows:-

FIRST. To Mrs. Bell would be given one per cent of the shares received for every \$1000 dollars she had contributed to the support of the Association; and the remainder of the shares received would be divided equally between A.G. Bell, J.A.D. McCurdy, F.W. Baldwin, G. H. Curtiss, and Mr. Selfridge (the representative of the heirs of our late member Lieut. Selfridge). The fully paid up shares of the Company would belong to the above named persons individually and they would be the first and only stockholders of the new Company. The remainder of the nominal capital of \$100,000 in the form of undistributed shares, would be placed in the Treasury of the Company subject to their disposal.

At this stage the Company would exist without any working capital in the form of cash and it would be necessary to raise money by the sale of some of the undistributed shares in the Treasury. The Company (that is, the above named individuals) could then order some of the shares in the Treasury to be sold; the stockholders (that is, the above named individuals) to have the right to subscribe for the stock at par in proportion to their several holdings. Should any shareholder decline to take up his full pro rata share, then the stock not so taken up should be sold to the highest bidder, but not for less than par. The same method should be adopted in any subsequent issue of stock.

The estimate of running expenses made by Mr. Curtiss seems to indicate that we could support the Company for a year if we could raise the sum of ten thousand dollars as



working capital. Then, when we have some income from any source, a portion of the earnings could be laid aside to form a sinking fund, and the remainder distributed among the shareholders as dividend.

Now let us see how this would work out in practice.

Mrs. Bell has agreed to contribute a sum, not exceeding in the aggregate \$30,000. She has done this, but our Treasurer reports that more will be needed to support the Association to the end of March. He estimates that total at \$34,000, and this is probably a conservative estimate. Mrs. Bell has set her heart upon the success of the Association and will do her best to support it to the end of its allotted term, which will probably involve her in a total expenditure of (say) \$35,000. She can do no more than this so there is no use considering a further extension of time. No other means of support has presented itself and the Association will have to come to an end on the 31st of March.

Now let us assume that the actual cost of our experiments has been \$15,000 (contributed by Mrs. Bell). We organize the Aerodrome Company on a basis of \$100,000, and set aside \$35,000 in fully paid up shares to be given for the property and inventions of the Association. The balance of \$65,000 to remain in the Treasury of the Company to be sold for cash as required.

The Association gets \$35,000 in fully paid up shares, which would be distributed as follows:-

Mrs. Bell would receive 35 per cent of this amount, and the remaining 65 per cent would be divided equally among the five members of the Association giving 13 per cent of this amount a piece.

Distribution.

Mrs. Bell	35%	par value	\$12,250
A. G. Bell	13%	par value	4,550
McCurdy	13%	par value	4,550
Baldwin	13%	par value	4,550
Curtiss	13%	par value	4,550
Selfridge	13%	par value	4,550
<b>Total</b>	<b>100%</b>	<b>par value</b>	<b>\$35,000</b>

We would own these shares individually in the proportion shown above and could sell them or dispose of them as we think best.

In addition to this we would own collectively, as "The Company", the property and inventions of the A.E.A., and have in our Treasury \$65,000 in the form of undistributed shares.

It would be necessary to sell some of these Treasury shares to raise cash for working capital say \$10,000, and we would have the right to buy them ourselves at par in proportion to our holdings of stock.

If we can personally, or through our friends, take up the shares we are entitled to buy the following would be the amount to be subscribed by each shareholder.

Amounts to be Subscribed.

Mrs. Bell	(35%)	\$3500
A.G. Bell	(13%)	1300
McCurdy	(13%)	1300
Baldwin	(13%)	1300
Curtiss	(13%)	1300
Selfridge	(13%)	1300
Total	100%	\$10000

This would require \$4800 to be subscribed by Mr. and Mrs. Bell or their friends, and \$5200 to be provided by the friends of McCurdy, Baldwin, Curtiss, and Selfridge. Mrs. Bell and I can undertake to find purchasers for our porportion (\$4800) if the others can dispose of the remainder (\$5200).

If McCurdy, Baldwin, Curtiss and Selfridge and their friends are not able to subscribe \$5200 in all, it is hardly worth our while considering the formation of a Company at the present time. We cannot go to the public until we have patents, and Mrs. Bell and I do not care to go into the matter alone. A.G.B.

-----000-----

FIRST TRIAL OF CYGNET II

Feb. 22, 1909:- We have waited long for the arrival of the new Curtiss engine to try an experiment with Drome No. 5, Bell's Cygnet II. At last it came and was duly installed last Friday (Feb. 19); but the smooth slippery ice upon which we depended had disappeared under about a foot of snow, so that the outlook for a successful experiment was disappointing.

We were considering plans for clearing off a track when a rain-storm on Saturday (Feb. 20) saved us the trouble. Heavy rain and a comparatively high temperature began to melt the snow. On Sunday evening (Feb. 21) the rain was succeeded by frost; so that to-day (Feb. 22) ideal conditions were presented for an experiment:- Glassy ice, no wind, and a beautifully sunshiny day.

We therefore determined to make an experiment without waiting to test the ten-foot propeller that had been prepared, and ascertain the proper gearing for the engine. Their-avoidable fussing over minor details that always occurs at the last moment took up the whole forenoon, so that it was afternoon before all was ready. The results are recorded among the experiments noted in this Bulletin.

It was hardly expected, on account of the great weight of the machine (over 950 lbs), that it would rise from the ice, and in this we were not disappointed! It is obvious however that the engine was overloaded with the ten-foot propeller at a gear ratio of 1-2 so that it did not give us its

FIRST FLIGHT OF THE SILVER-DART IN CANADA.

Feb. 23, 1909:- This is a red letter day at Seinn Bhreagh. McCurdy flew over Baddeck Bay in the Silver-Dart about half a mile. This marks a clearly historical event:- The first flight of a flying-machine in Canada. A.G.B.

SECOND FLIGHT OF THE SILVER-DART.

Feb. 24, 1909:- McCurdy made a magnificent flight of four and a half miles to-day in the Silver-Dart, circumnavigating or rather circumdroming Baddeck Bay. Our only regret is that Mr. Baldwin and his wife were not present to witness this great flight. Official congratulations have been received from the town of Baddeck. A.G.B.

DEPARTURES FROM SEINN BHRAGH.

Feb. 26, 1909:- Mrs. Bell, Miss Cadell, Mrs. Curtiss, Mr. Curtiss and Mr. Gardiner Bell left Seinn Bhreagh to-day. Mr. and Mrs. Baldwin left sometime ago so that Douglas McCurdy and I remain as the sole representatives of the A.M.A.

A.G.B.

-----000-----

EXPERIMENTS:- Reported by the Editor.

Kite Model of Drome No.6.

Feb. 13, 1909:- The white Oionos Kite shown in Bulletin XXX p.13 has been repaired. It was tried this afternoon flown by a Manila rope 100 m long from a point 50 cm in front of the center of the kite. The kite had been strengthened with beading where the strain of the line came (see Bulletin XXX p.19). Weight of kite 17825 gms or 39.26 lbs. Weight of flying-line 5328 gms or 11.74 lbs.

Exp.1		Exp.2		Exp.3	
Wind 13.20 mph		Wind 14.25 mph		Wind 16.00 mph	
Pull	Alt	Pull	Alt	Pull	Alt
25	32°	60	44°	70	46°
30	33°	70	43°	40	48°
50	34°	60	38°	60	47°
60	46°	40	48°	40	49°
50	43°	50	45°	60	45°
30	44°	80	50°	40	43°
20	46°	30	52°	60	48°
15	38°	80	48°	40	43°
40	36°	30	58°	60	44°
50	43°	50	50°	30	38°
<u>370</u>	<u>397°</u>	<u>550</u>	<u>476°</u>	<u>500</u>	<u>451°</u>

Exp.4		Exp.5		Exp.6	
Wind 13.50 mph		Wind 13.40 mph		Wind 12.25 mph	
Pull	Alt	Pull	Alt	Pull	Alt
40	38°	20	44°	40	40°
50	40°	30	43°	20	33°
10	45°	40	40°	50	35°
40	35°	40	41°	30	37°
50	37°	30	42°	20	37°
20	38°	40	40°	10	33°
40	40°	30	38°	30	33°
30	45°	30	40°	30	38°
50	43°	50	38°	50	40°
60	45°	20	40°	50	33°
<u>390</u>	<u>408°</u>	<u>330</u>	<u>406°</u>	<u>330</u>	<u>359°</u>

Exp. 7		Exp. 8	
Wind 13.20 mph		Wind 13.00 mph	
Pull	Alt	Pull	Alt
20	38°	40	40°
40	35°	30	41°
80	40°	50	40°
40	40°	40	39°
70	39°	50	40°
80	45°	60	45°
60	42°	60	48°
70	44°	70	37°
60	45°	60	47°
60	42°	60	46°
<u>580</u>	<u>410°</u>	<u>520</u>	<u>425°</u>

Exp. 9		Exp. 10	
Wind 14.40 mph		Wind 14.50 mph	
Pull	Alt	Pull	Alt
30	48°	70	42°
60	44°	30	50°
30	48°	60	49°
70	43°	60	43°
60	49°	60	45°
60	46°	70	47°
60	45°	30	50°
70	43°	60	47°
60	47°	60	50°
60	46°	70	50°
<u>580</u>	<u>461°</u>	<u>570</u>	<u>475°</u>

On the following page I give in a summary table the aggregate readings and the general averages; and also a calculation of the efficiency of the kite:-

-3-

SUMMARY TABLE.

Exp.	Pull		Altitude		Wind	
	Obs	lbs	Obs	Angle	Obs	mph
Exp. 1	10	370	10	397	1	13.20
Exp. 2	10	350	10	476	1	14.25
Exp. 3	10	500	10	451	1	16.00
Exp. 4	10	390	10	406	1	13.50
Exp. 5	10	330	10	406	1	13.40
Exp. 6	10	330	10	359	1	12.25
Exp. 7	10	580	10	410	1	13.20
Exp. 8	10	520	10	423	1	13.00
Exp. 9	10	560	10	461	1	14.40
Exp. 10	10	570	10	473	1	14.50
Summation	100	4700	100	4262	10	137.70
Average		47.00 lbs		42°.6		13.77 mph

If the angular altitude be taken as  $42^{\circ} 30'$  then the sine is .676 and the cosine is .737.

Therefore with a total pull of 47 lbs. the vertical pull is 31.77 lbs and the horizontal pull 34.64 lbs. The horizontal pull expresses the drift.

The lift includes the weight of the kite 39.26 lbs, the weight of the flying-rope 11.74 lbs, and the vertical pull 31.77 lbs. Total lift 82.77 lbs.

$$\text{Efficiency} = \frac{\text{Lift}}{\text{drift}}$$

$$\text{Efficiency} = \frac{82.77}{34.66} = 2.4$$

That is the lift is 2.4 times the drift.

-----000-----



-4-

Remarks:- The Kite flew quite steadily during the above experiments 1-10, although I thought I detected a slight tendency to longitudinal oscillation.

It went off the wing occasionally tipping down one wing; but the motions were deliberate, there was no tendency to slide down the hill sideways as with structures of the Hammondsport type, and there was a graceful and deliberate recovery of position.

The attempt was then made to increase the length of the flying-rope to 200 meters. A squall came, and the kite went to one side off the wind and began to come down slowly by the head. The line was released in time to prevent a bad smash, but failed to save the kite from damage altogether.

It is proposed to remodel this kite so as to convert its aeroplanes into aero-curves, and test its efficiency under the new condition.

We next tried a half-sized model of Drone No. 5, in order to make a direct comparison with the preceding experiments with the model of Drone No. 6.

#### Kite Model of Drone No. 5

Feb. 13, 1909:- Flying-rope 100 m long attached 100 cm from center of kite. This kite is composed of 736 tetrahedral winged-cells: Surface 39.9442 sq. m (say 40 sq. m). Weight of kite 19295 gms or 42.5 lbs. Weight of rope 5328 gms or 11.74 lbs.

-6-

(Model of No. 5)

Exp. 11

Wind 15.40 mph

Pull	Alt
70	28°
80	29°
100	33°
130	32°
80	31°
80	29°
70	30°
140	27°
100	30°
140	30°
<hr/>	
10 Obs	990 29°
Aver. 99.0 lbs 29°.3	

Remarks: The kite was beautifully steady in the air inspite of the gusty wind.

The flying-rope was then let out until it was 200 m long. Weight of rope 10,645 gms or 23.45 lbs.

Exp. 12

Wind 13.45 mph

Pull	Alt
90	29°
80	28°
90	28°
120	29°
90	28°
100	26°
110	28°
80	29°
90	28°
90	28°
<hr/>	
10 Obs	940 28°
Aver. 94.0 lbs 28°.1	

Remarks: The kite seemed to be perfectly steady in the air. In both experiments 11 and 12 the stability was

manifestly superior to that of the Oionos model used in experiments 1-10.

The kite made a bad landing and was somewhat damaged, but this was due to a mistake in handling it. The rope was caught on the cleat, so that a continuous steady pull on the line could not be made while the kite line was being over-run, and no bow-line was used to reduce the strain on the handling line. One end of the wing piece struck the ground, and the cells at that end were crushed in. The damage will be repaired. A.G.B.



Hydrodrome Toy.

Feb. 16, 1909:- As suggested Mr. Bedwin has had made another hydrodrome toy, keeping the nicely finished tin hydrodrome (Bulletin XXXII) as a model of the <sup>"Query"</sup> ~~Cygnet~~. The present one is a small toy boat of wood decked in, and provided with four sets of tin hydrodromes, one on either side near the bow, and one on either side near the stern. The surfaces looked very small although having an area more than twice as great as those used on the model of the "Query".

This baby hydrodrome was to-day floated in a bathtub and towed by a string when it at once rose out of the water on the hydro-surfaces, but the result did not seem to be sufficiently striking to be of much interest to a child. For this purpose we need exaggerated effects.

The model has been sent back to the Laboratory to have larger surfaces attached. The area will be increased four-fold and simple hydroplanes will be employed which will be twice as deeply submerged so as to permit the boat to lift twice as high out of the water when towed by a string. A.G.B.

Flying Toy.

Feb. 19, 1909:- Gardiner Bell to-day submitted a new flying toy which he thinks might form the basis of a new game for children. It is an attempt to utilize the principle of the ordinary paper dart formed by folding a piece of paper so as to make a dart offering an acute angle to the line of advance. The model shown to-day was made of aluminum but was too heavy for the surface involved. A launching apparatus was

placed on the floor and released by pulling a trigger when the dart was projected by the reaction of a coiled spring. Gardiner Bell proposes to suspend a ring as a target and have children try to shoot their darts through the ring. The present dart proves to be too heavy for the purpose and another lighter one has been ordered which will be of silk over a framework of wood. A.G.B.

-----00-----

Drome No. 5, Bell's Cygnet II

Feb. 22, 1909:- Experiments were made this afternoon with Drome No. 5, Bell's Cygnet II. Before starting for the ice I read to the men at the Laboratory the following note concerning the plan of the experiment:-

The object of the experiment to be tried this afternoon with Aerodrome No. 5, Bell's Cygnet II is first, to test whether it will rise into the air, and second, whether while it is in the air it has the lateral stability displayed by kites of pure tetrahedral construction.

On account of the great weight of the machine, exceeding 950 lbs. with man and engine and all, it is extremely doubtful whether the machine will leave the ice. We want to test this point and not to make a flight.

Mr. McCurdy is requested when he lifts the front control to get into the air, to make only a short flight if the machine rises; and to go at no great elevation above the ice. A horizontal flight of from 1 to 200 hundred feet will be sufficient to let us judge of the capabilities of the machine in her present condition.

Mr. McCurdy will tell Mr. Bedwin exactly what he proposes to do, before he starts; and Mr. Bedwin will scatter a few men at points near the proposed landing place so as to be at hand when the aerodrome alights.

Mr. McCurdy will be careful to come down soon enough to allow the machine to have clear ice ahead of it for at least a quarter of a mile so that she may come to rest without striking against the shore, and so avoid any accident like that we had recently with the ice-boat.

The photographers should be scattered to one side of the line of flight so as to increase the chances of getting a good picture.

The Cygnet the II was then taken out upon the ice of Baddeck Bay which must have been very thick for half the

-2-

people of Baddeck seemed to be there, well concentrated upon the ice near the machine:- People on foot and people in teams.

A breeze had by this time sprung up of not less than six miles an hour from the southwest, so the machine was taken over the Bay, near Carruth's place. Mc. Curdy took the aviator's seat and the machine was turned round to face the wind, and the engine started.

Although the motor was evidently not developing its full power the push of the propeller must have been considerable for the men were unable to hold the machine on the slippery ice and were obliged to let go. The machine did not however acquire much speed for the skaters upon the ice easily kept up with it.

After gliding for about 100 meters upon the ice the engine stopped, or perhaps was purposely stopped by McCurdy. After some delay the machine was started again with the same result.

I understand that on one of these trials, probably the last the pipe leading from the gasoline tank broke, so that the engine had to be stopped.

A third trial was then made, and it was obvious from my distant point of view that the engine was working better than before. The machine began to gather speed, but just as we were hoping she would take the air, a noise like an explosion was heard and the experiment came to an end.

The noise was due, not to an explosion, but to the sudden snapping of the propeller shaft following which the

propeller was thrown violently on the ice and broke in three pieces.

Further experiments are postponed until another propeller can be made. While this is being done the engine will be transferred to the "Silver-Dart", which will be tried upon the ice.

As a general conclusion we find that the engine is overloaded with a ten-foot propeller having a gear ratio of 1-2. We propose therefore to make two propellers, one of 9 feet diameter to be used with the present gear ratio of 1-2, and another of 10-foot diameter employing a gearing of 1-3.

While the results to-day were not unexpected, we are encouraged to think that with arrangements which will permit of the engine developing her full power we may be able to raise the machine into the air so as to observe its stability. One point that has been demonstrated to-day is, that a vertical rudder placed in front instead of behind controls the horizontal steering of the machine. The action of the wind upon it tended to turn the machine to port or starboard, but even with the small velocity attained and with the resistance of the long sledge-runners, McCurdy was easily able to steer the machine into the wind's eye.

A.G.B.



FIRST TRIAL OF THE SILVER-DART.

Feb. 23, 1909:- The Curtiss engine was transferred from Cygnet II yesterday to the Silver-Dart, and this morning propeller experiments were made on the ice-beat machine to test which of the propellers we have would be most suitable for the experiment. A propeller 7 feet 8 inches in diameter was chosen which had been used upon the Silver-Dart in Hammondport.

In the afternoon the Silver-Dart was taken out on the ice of Baddeck Bay; and a large concourse of people from Baddeck were present.

The congregation of people and teams upon the ice yesterday near the Cygnet II had shown the advisability of policing the crowd and keeping them scattered, and at a distance from the machine. Mr. Charles R. Cox, Mr. P.L. McFarlan, Mr. Fred McLennan, and Mr. John Arsenault were provided with the following notice, which they displayed to visitors wherever necessary.

N O T I C E

In order to avoid the possibility of any accident visitors are requested to keep at a distance from the flying-machine Silver-Dart, and not congregate together on the ice. They should remain behind the machine, or well off to one side, and leave a clear field for the Laboratory Assistants. They should not on any account place themselves in the path of the machine in front. It would be dangerous to be struck by it.

Beinn Bhreagh, C.B.  
Feb. 23, 1909.

(Signed) Alexander Graham Bell  
Chairman Aerial Experiment Assoc.

This served its purpose, and the visitors kept well scattered.

I give below some notes of the experiments made to-day by Mr. McCurdy and by Mr. Curtiss; and it will be unnecessary for me to add any further description as my telegrams to the Press, which will be given in the next Bulletin, describe sufficiently the details of this the first flight of a flying-machine in Canada.

McCurdy's Account:- The morning of to-day (Feb. 23) was spent in getting the Silver-Dart ready for a trial flight. The transmission was changed from the four V-belt drive to a single chain drive which, it was anticipated, would not only give greater efficiency but would be of less weight. The gearing used was 18-24 (or 3-4), the engine turning over 24 revolutions to the propellers 18 revolutions.

We had three propellers; and to decide which one was to be used a series of tests was made on the ice-boat, although the ice-boat was not allowed to advance during any of the tests.

The propeller finally decided upon was one having a diameter of seven feet 6 inches, and a pitch at the tip of 20°-22°. This propeller was not one of constant pitch speed.

The Silver-Dart was finally taken across the Bay on the ice, and a start made at a spot just off Fraser's Pond.

In the first trial a gasoline pipe broke after the machine had traveled about 100 feet.

Upon fixing this a second start was made which was very successful. The machine rose from the ice after traveling about 100 feet; and flew at an elevation of about ten-thirty feet directly east for a distance of about half a mile. Landed without any jar whatsoever. The speed I should judge to be about 40+ miles per hour. The machine was operated by J.A.D. McCurdy. McC.

Curtiss' Account:- In choosing a propeller for the Dart to-day (Feb. 23) we tried the three which were available on the ice-boat, to determine which would be best suited for the purpose, the desired speed being about 600. The results were as follows:-

Propeller	Speed	Pull
No. 1	650	200 lbs.
No. 2	550	112 lbs.
No. 3	450	50 lbs.

We chose No. 1, a remodeled Hammondsport propeller. By speeding the engine we got 625 (about) revolutions with this propeller, which proved plenty for the requirements.

No. 1 propeller was seven feet 8 inches in diameter, about seven inches wide and 20° at the tip, pitch decreasing towards hub (not perfect screw), and had a curved face of about 1 in 16.

No. 2 propeller was seven feet four inches in diameter, about 8 1/2 inches maximum width, and 22° 1/2 at tip, pitch decreasing towards hub, and had a curved face of about 1 in 12.

No. 3 propeller was eight feet in diameter, 8 inches wide and  $22^{\circ} 1/2$  at the tip and a perfect screw. This propeller only had a flat face.

The Silver-Dart was given a most satisfactory trial to-day (Feb. 23). The speed was, I should judge, over 40 miles an hour; certainly more than we have had in any previous flights either with this or the other machines. The velocity of the wind was also greater than any in which we have attempted to fly before. G.H.C.

#### SECOND TRIAL OF SILVER-DART.

Feb. 24, 1909:- All the records of the Association have been eclipsed by McCurdy's magnificent flight of this morning of  $4 1/2$  miles in the Silver-Dart. I have not time to write details as we are to try the Cygnet II again this afternoon with the Silver-Dart propeller. My press dispatches, and the following notes by McCurdy and Curtiss tell the tale.  
A.G.B.

McCurdy's Account:- The second flight of a flying-machine in Canada took place this morning (Feb. 24) at Baddeck, when the A.E.A. Drome No. 4, McCurdy's Silver-Dart, flew a distance of  $4 1/2$  miles.

Started off Fraser's Pond, and headed up the Bay towards the Log Cabin. The turn to port was started there, making the circle as large as possible. Ran #### down Beinn Bhreagh where crossed the sand beach at the plaster dump, and attempted a turn again to port just off William Taylors.

The space was however found to be too small in which to completely negotiate the turn, and so a landing was attempted.

The machine, however, struck her starboard wing on the ice, and spinning round smashed a few struts and chords. One wheel also was broken.

Curtiss No. 3 engine worked beautifully, not a skip all through the flight. The balance was about perfect, all the controls working well.

The power developed was sufficient not only to drive the machine against a 5-6 mile wind, but also with it. The feel of the machine was the same both with and against the wind. McC.

Curtiss' Account:- The flight of the Silver-Dart to-day (Feb. 24) was the best ever made by the members of the A.E.A. Everything worked perfectly. The machine raised quickly but steadily, and covered a distance, around the Bay, of perhaps 4 1/2 miles at the rate of about 40 miles an hour.

McCurdy handled the machine perfectly, and the accident was caused more by a combination of circumstances, than by any fault of the aviator. G.H.C.

#### SECOND TRIAL OF CYGNET II.

Feb. 24, 1909:- Unwilling to lose the opportunity of the ideal weather conditions prevailing to-day we transferred the engine and propeller from the damaged Silver-Dart to Cygnet II without awaiting the completion of the new nine foot propeller being made for her. Tried her on the ice just at dusk.

Three starts were made, but she did not rise into the air. During the third trial McCurdy (the aviator) shut off power on hearing something in the machine snap suddenly. This turned out to be one of the guy wires attached to the engine-bed and running up to the ridge-pole.

Why should this have snapped unless under tensional strain? And why should it have been under tensional strain unless the machine was beginning to lift the load of the engine off the ice? I look upon the snapping of the wire as an evidence that the machine had begun to reach a supporting speed.

It might be well, before making further experiments, to test the tensional strength of the parts supporting the engine and man, by supporting the machine so as to allow the engine etc. to hang without touching the floor. In all our tests the engine part has been supported from below, whereas in actual flight it will be supported from above. A.G.B.

-----oo-----

CONCERNING PROPELLERS. THEIR RELATIVE POSITION TO  
THE AEROPLANE: By Gardiner H. Bell

Feb. 12, 1909:- In a letter which appears in Bulletin XIX p.23, Mr. Curtiss makes the suggestion that the application of power, parallel to the line of advance and well above the center of gravity, would insure safety in case of accident. His reason for this statement is as follows:- As long as the propeller is imparting forward motion to the machine it is exerting a downward pressure by virtue of its high line of thrust. In order to counteract this downward tendency it is necessary for the aviator to keep the front control continually at an elevated angle. Now suppose the engine stops during flight, the downward component goes out of play and the front control, being normally elevated, tends to lift the machine by the head as long as momentum continues. The point then is this, that immediately following the stopping of the engine the head of the machine is thrown up. We are dealing here with conditions immediately following a break down of the engine, or a disabled propeller. Obviously such action would practically eliminate the chances of an immediate fore-downward plunge. However there are other things to be considered.

If the line of thrust be above or below the center of gravity, immediately this thrust is discontinued, the balance of the machine will be changed. Indeed this is a necessary feature in the case of the high line of thrust. We have then different conditions with which to deal. The center of gravity is altered and the balance of the aeroplane

is upset. Headway has been checked because the machine is working against the force of gravity and it (the machine) being elevated at the bow is in a position to take a rear downward plunge when headway is lost.

Up to this point we have been dealing with conditions taking place after propulsion has failed. Let us now take the conditions existing before thrust has been discontinued.

A high line of thrust being applied continually is exerting a tendency to depress the front of the machine. It is not increasing the load on the main surfaces because the line of thrust is parallel to the line of advance. But it is necessarily bringing into play continuous resistance of the front control in its efforts to keep the machine in the required direction. Speed has been sacrificed by loading the engine with unnecessary resistance and taking it all in all has safety been promoted?

I was under the impression that during the conference the other day Dr. Bell made the statement that in case of accident it would be safer to have revolving propeller in the rear of an aeroplane rather than in front as there would be great danger of the aviator being thrown into the propeller were it in front at the time of impact of the machine with the ground. Let us consider the two cases first from the standpoint of safety and let us assume that in each case the propeller is revolving under power at the time of impact with the ground.

First consider the case in which our propeller is in front. The propeller, placed as it is, will be the first part of the machine to come in contact with the ground. The



-3-

revolving blades will be snapped off at the axis and through the action of centrifugal force will be hurled wide of the machine thus rendering the propeller harmless to the aviator even if he is thrown into its immediate vicinity.

Then too, the propeller being in front, it stands to reason that the engine would also be in front, and to my line of reasoning it would be an infinitely more pleasant sensation to land on top of an engine, whose propeller was embedded in the ground, than in the other case to run the chances of having an engine with the propeller, which we have every reason to believe, would continue rotating until it struck the ground, land on top of me.

A revolving propeller in front of a machine which it is sustaining in flight is throwing a constant current of air back upon its supporting surfaces. Now it is interesting to note just how this current of air, thrown back from the propeller, acts in connection with the machine. It does three things; and in order to make it clear let us consider these things as separate and apart from one another.

1. A portion of it acts upon free air imparting and maintaining a certain velocity of the machine.

2. A portion of it acts upon the under surfaces of the supporting surfaces of the machine thereby imparting an added lift.

3. Also a portion of it acts upon struts and such goes into head resistance.

In the above three cases we are considering the propeller as being in front of the machine, now let us consider

-4-

it in the rear. In both cases the relative lift imparted to the machine by the air is the same. It is the application of this lift that is different. In the case of the propeller in the rear the machine would speed up until there is the same pressure of air as in the former case. The velocity of the machine in the latter case will keep accelerating until the pressure of air in the two cases is exactly the same. In the first case, where the propeller is in front the speed of the air has been increased to support the machine. In the second case the speed of the machine has been increased until the pressure of the air is sufficient to support it in flight. This reasoning would seem to lead to the fact that in both cases we have the same lift, for the pressure of the air is the same. It is the velocity of the machine that is changed, not the lift. In the case of the propeller being in the rear there is as much power lost in dead resistance as there is in the case where the propeller is in front, because the pressure of the air in both cases is the same. The dead resistance remains the same, the lift is the same, but velocity is gained by having the propeller at the rear.

G.H.B.

-----00-----

FRONT CONTROLS: BY F.W. Baldwin.

Feb. 13, 1909:- There is a radical difference between a supporting surface and a control, which, it would seem, we overlook in the design of our machines.

It does not follow that the best shape for a supporting surface should be adopted in a surface which normally presents no angle of attack. A rudder of any kind is only called into action occasionally.

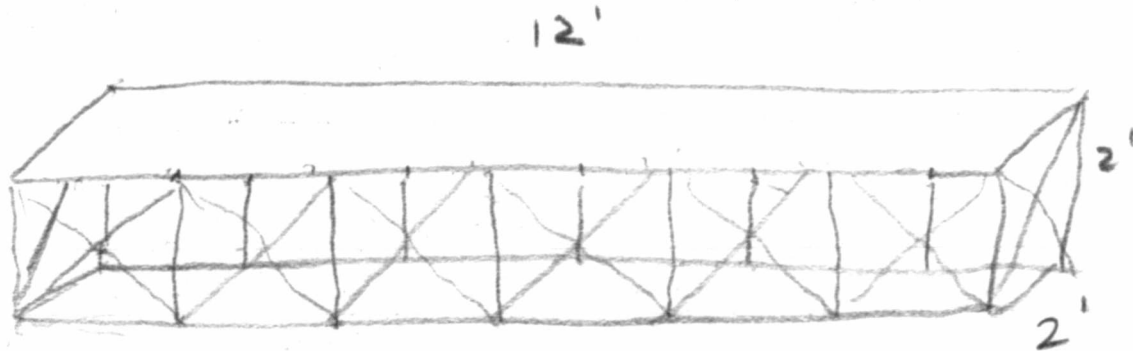
While it is true that sustaining surfaces, narrow in the line of advance, seem to be more efficient than ones which are as deep as they are wide, it by no means follows that this is the best form for a rudder surface of any kind.

Is it not reasonable to suppose that we are paying too much in head resistance for the increased efficiency of the controlling surfaces.

There is another point in favor of controls deep from fore to aft. It is well known that skin friction per square foot decreases with the length from fore to aft of the surface; and while the quantitative value of experiments on skin friction in the air may vary considerably, we know that in the water, where it is a large and measureable quantity it does decrease per square foot with the length of the surface.

Prof. Zahn's results, which are almost identical bear out Froude's experiments on water; and, for the sake of getting a comparison, let us accept them, and see how much we are paying in head resistance for our more efficient controls.

Take a double-deck bow-control 12 feet by 2 feet giving a surface of 48 square feet, and compare it to a square 5 feet by 5 which would have a surface of 50 square feet.



Cutting edge  
struts

24' chords  
~~24~~  
52' @ 1/2"

52 + 24 = 2.1 sq. ft.  
@ coef. of 1/6 = .35

Wire

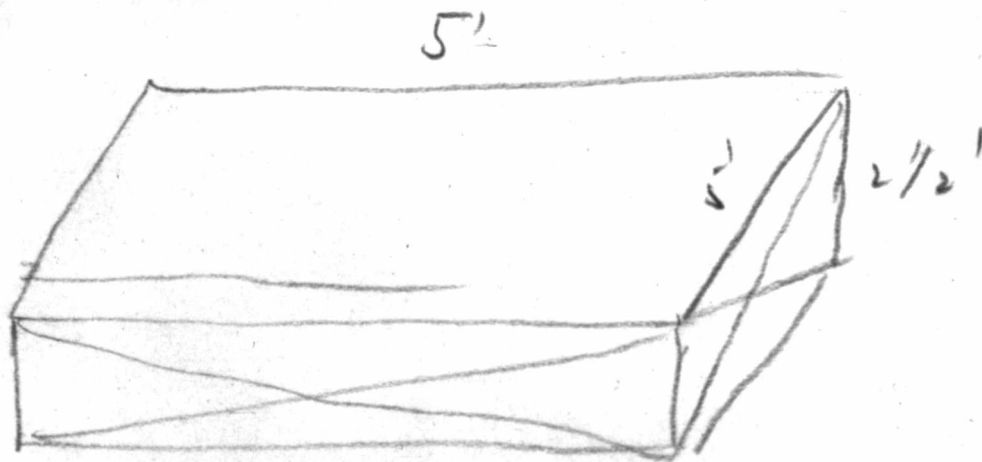
106  
@ 1/16" = .55 sq. ft.  
@ coef. of 1/2 = .245

Total

.60 sq. ft.

@ 40 miles per hr. pressure = 8 lbs.  
Therefore head resistance = 4.80

Skin friction = 24 x .0138  
@ 40 miles = .3312  
Total 5.13 lbs.



Cutting edge	10'
Struts	10'
	<u>20'</u>
③ 1" material	1.66 sq. ft.
③ coef. 1/6 =	.28
Wire	45'
③ 1/8 =	.465 sq. ft.
③ coef. of 1/2 =	.232
Total	.28
	<u>.23</u>
	<u>.51</u>

③ 40 miles per hour = 4.08  
8 lbs. pressure

Skin friction @ 40 miles per hr. = .0132 x 25 = .3300  
Total = 4.4 lbs. Resistance less resistance about 15%.

Now it is obvious that the square surface control need not have material twice as much in cross section as the other one.

Instead of the 1" stock referred to 1/2 steel tubing could be substituted to advantage - the size of the struts being sufficient to warrant it.

But even with 1" stock and wire 1/8" thick it has less resistance than the narrow control.

It must be taken into account that with a surface nearly square the bending strains are materially reduced.

After working this out I am of the opinion that a large single surface control almost square is perhaps better than superposed arranged as we have them. At any rate the difference between a supporting surface and a rudder is worth thinking about. F.W.B.

-----00-----

**FLYING-MACHINES, COMMERCIALY: By G. H. Curtiss.**

Feb. 15, 1909:- Practically every flying-machine in existence has been built by experimenters and for experimental purposes. Little or no revenue has been derived from their use except perhaps the winning of a few prizes. Farman made one unsuccessful attempt at exhibition work and the United States Government have let two contracts which, as yet, have not been filled. Government contracts and exhibition work seem to be the two most promising sources of revenue. There are no prospects of the United States Government placing further orders for some time to come and when they do the Wrights will no doubt be in on the "ground floor".

The Canadian Government might be induced to invest in an aerodrome or two especially if they were built in Canada, and I think this prospect should be diligently followed up.

Exhibitions may and may not prove profitable according to the way in which the undertaking is handled. Farman's exploit was certainly discouraging. An experienced man would be most likely to be successful in this field, that is one who knows how to get contracts and how to get the money after the contracts are fulfilled. There are now several cash prizes offered in America and still more abroad. But when you play for these big stakes you play against big odds and "there is many a slip etc". However these cash prizes look very alluring. I think prize chasing and exhibition work should go hand in hand.

-2-

Of the score or more machines likely to be built the coming year there will be nearly as many different models and the manufacturer to get the business must, like the Voisin Brothers build anything that is wanted. Probably by another year the machines will become more standardized and a certain amount of business may be expected from private parties for machines for sport. Perhaps an Aerial Development Company could be formed to look after Government contracts, prizes etc. and get in shape to handle the large volume of business which is bound to come later.

G.H.C.

-----00-----

## STRUTS, CHORDS, AND TRUSSED RIBS: By J.A.D. McCurdy.

Feb. 16, 1909:- In reading through Sir Hiram Maxim's book on "Artificial and Natural Flight" one is struck by the fact that the work is pregnant with many practical ideas and valuable theoretical information which might be of the greatest importance to flying-machine experimenters, designers, or constructors.

The suggestions and hints are greatly strengthened on account of having been subjected to experimental tests and the results obtained seem to thoroughly warrant their consideration.

His reference in Chapter I to the amount of horse power consumed in driving his machine through the air with no aeroplanes attached is very significant and points out the enormous waste of energy resulting from improper design of struts, wires, etc. etc., and in fact all members which are exposed so as to produce a resistance to motion along the line of thrust.

He very thoroughly and systematically conducted a series of tests with the idea in view of determining the cross-sectional form of strut, or chord, which would not only consume the least power in being pushed through the air, but which might at the same time produce an economical lift and so add to the efficiency of your machine. The best form arrived at was not the fish-shaped cross-sectional form in use on some of our machines, but a form having, both fore and aft, a rather sharp tapering, of equal design. The drift of such a strut was very much less than in the case of the fish-shaped, and the efficiency of this form of cross-section when



-2-

used as a lateral member was, at a low angle, about 6.

He is a strong advocate of the use of trussed ribs covered over with fabric on both top and bottom and in this connection he suggests a very important point. The efficiency of an aero curve when under way depends upon the surface holding its predetermined curve. Now with cloth applied in the ordinary manner this essential would be absent owing to distortion under pressure.

He not only criticizes this fault but goes further and suggests a remedy. Cover the top of your ribs with a material such as rubber cloth which is absolutely air-tight and, as an underneath surface, use a cloth which is to a degree porous. Now the air is pressed through the under surface but cannot be forced through the upper surface therefore an air cushion is formed between the two cloths. This means that there is an equal atmospheric pressure on both sides of the under surface, hence no distortion will result.

In an actual experiment conducted by Maxim the efficiency of such a constructed aeroplane was about the same as that of an aeroplane formed up of rigid material.

We should, I think, take advantage of this important suggestion in the construction of aero curves. The front and back lateral chords to which the ribs abut could be made in two pieces the section being made laterally.

Now the top and bottom silks could be laced together at the front and rear with the outside section of the chords removed when they are replaced, the lacing of the silks would be completely hidden and so the curve would not only look well

-3-

but be very much "cleaned".

It is very unfortunate that Mr. Maxim omitted to print the results of his experiments with propellers in detail as such a series of results, would, at the present time, be very valuable. He however states as a general result that the thrust is always constant whether advancing or not. This we have yet to find out for ourselves on the ice-beat.

J.A.D. McC.

-----00-----

This paper is illustrated by blue print p. 54.

NATIONAL RESEARCH COUNCIL

MEMORANDUM

FILE NO.....

TO:-

DATE .....

WESTHNE  
GAS  
ENGINE OIL

N  
WESTHNE  
GAS  
ENGINE  
OIL

FORM NRC 47B (REVISED 24.2.49)

A NEW GAME: By Gardiner H. Bell.

Feb. 24, 1909:- The following is a description of a flying toy. This toy consists of two parts, a launchway and a dart with a keel-stick which fits into a groove in the launchway. The dart is forced along the launchway by a spring which acts on the recoil.

The dimensions of the launchway are as follows:- 8 inches long by 2 inches wide and 1 inch deep. This launchway is set at an inclined angle so as to give projective force at a suitable angle for a glide.

The Dart is of triangular form 12 inches long and 6 inches at its face or rear edge.

In connection with the dart and launchway, a ring large enough to permit the dart to be shot through it might be used, and an interesting game might be played by trying to shoot the dart through the ring. G.H.B.

-----00-----

AERODROME MOTORS: By G. H. Curtiss.

Feb. 25, 1909:- The internal combustion or gas engine is without doubt the best power for heavier-than-air flying-machines, and it remains only to choose what type or style of gas engine is best adapted to the work. Of course there are possibilities in other forms of motive power but we consider only those which are now in practical use. If, as some people predict, flying-machines are to be as common as automobiles then motors should be as simple as automobile motors, and if possible even more reliable.

It is now conceded that very light motors are unnecessary and, may be, undesirable if by their lightness their endurance and reliability is sacrificed.

Suppose we want an engine of 25 H.P. This should be sufficient for a flier to carry two men an hour or one man four or five hours (assuming that the engine will consume 30 lbs. of fuel per hour). What type of motor should we adopt? There is a choice of the two or four cycle type, air or water-cooled, double cylinder opposed, three, four or six cylinder vertical, 5 or 7 cylinder star and seven or eight cylinder staggered and others besides innumerable systems of ignition, lubrication, and valve action. With such an assortment it would seem difficult to make a choice but when we consider that simplicity and reliability are the most important requirements, I believe it is safe to eliminate all the types which can be considered in the experimental state and choose an engine which has been built by the

## Bulletin No. XXXIV

thousand, and is in constant daily use in automobiles, motor boats etc:- This is the four cylinder vertical.

The reason that this number of cylinders and type of engine is so popular is, that it give almost perfect balance, even torque, and in 25 H.P. size, can be built much lighter than an engine of one two or three cylinders.

Such an engine, with all accessories, including the cooling system, built of best materials and with all unnecessary weight eliminated, will weigh about 6 lbs. per H.P. The engines which are described as developing a H.P. to every 2 1/2 to 3 1/2 lbs. weight, will, 9 times out of 10, in actual practice weigh 5 or 6 lbs. as the catalogues or descriptions make no allowance for cooling, lubrication, balance-wheel etc.

Assuming that we are right in adopting this type of engine on account of its simplicity, reliability, and the fact that this is so universally used and understood, let us consider if there is a way of improving the engine aside from the use of better materials and careful workmanship. I am satisfied that there is nothing more to be sought in the general system of lubrication, ignition, and carburation, but there is a chance for improvement in the valve action.

Valve ports or any unevenness of the interior of the combustion chamber are to be avoided. Valves on the side of the cylinder, which is a common construction, is bad because the explosion space is divided. The more compact this explosion space can be designed, the more perfect is the ignition and the combustion of the gases. Any protruding

edges or corners are also objectionable as they become red hot and cause pre-ignition of the incoming charge of gas which either decreases the efficiency of the engine or requires much more cooling than would be necessary with the best design.

In the new engine being built by the Curtiss Mfg. Co. the following design has been adopted. (See fig. I).

The advantage can readily be seen when it is compared with Fig. 2, which is a common construction. The placing of the valves at an angle in the cylinder head not only makes a more perfect shape combustion chamber but also allows of the use of very large valves, which is generally known to be a most desirable point.

The two-cycle engine has its advantages, but does not equal the four-cycle when H.P. per lb. weight and fuel consumption are considered. One of the points of advantage claimed by the two-cycle school is the absence of valves which are a possible source of trouble in the four-cycle engine, especially the exhaust valves leaking from the becoming pitted by the excessive heat of the burnt gas passing out. This fault can however be entirely overcome by the use of cast-iron rims homogeneously welded to the valves. Cast-iron does not pit from heat and this type of valve can be run for years without regrinding. This overcomes the principal disadvantage of the four cycle as compared with the two.

Theoretically an explosion each revolution, as secured by the two cycle system, would give more power for the same size cylinder than an explosion every other revolution

as in the four cycle. But a part of the burnt gas always remains in the cylinder in the two cycle type, and cuts down the mean effective pressure besides making the engine much more difficult to cool properly, not only from the fact that there is an explosion every revolution, but because of the imperfect combustion caused by the burnt gas mixing with the incoming charge; whereas in the four cycle the burnt gases are almost completely ejected by the exhaust stroke and the cylinder is given an opportunity to cool on the suction stroke.

The two cycle engine however has undergone great improvement in the last few years and there is a possibility of its yet equalling the four cycle in efficiency.

To sum up, I would recommend for flying-machines requiring 20-35 H.P. a four cylinder vertical water-cooled four cycle engine with a single float feed carburetor mechanically operated intake and exhaust valves in the head, force feed and splash lubrication and magneto ignition. For greater power an 8 cylinder with two sets of four cylinders set at an angle of  $90^\circ$  and with one of each set of connecting rods attached to the same crank, fitted with two carburetors, one for each set of cylinders, lubrication by both gear pump direct to bearings and splash, cylinders copper-jacketed, water-cooled, mechanically operated valves in the head actuated by single push rod and fitted with both magneto and battery ignition. G.H.C.

-----00-----  
(See blue print p. 61)



COMBINATION FRONT CONTROL: By Gardiner H. Bell.

Feb. 26, 1909:- Two levers running in a fore and aft direction and parallel to each other attached at or near their center to a strut or bar running perpendicular to said levers and on which they may turn freely with said bar or strut as an axis. Means for allowing said parallel levers to turn from right to left as well as to elevate and depress. These two levers support at their forward end a front control. Their opposite ends being grasped by the hand of the operator. As these levers are pivoted at or near their centers on above mentioned transverse strut or bar running perpendicular to said levers and in a lateral direction, in connection with the machine, this combination allows the operator to move said levers up or down elevating or depressing the front control. It also allows of a movement of the levers from right to left (the levers always keeping parallel to one another), and it also allows one lever to move up and the other down.

The three above mentioned combinations have the following effects:- (1) To elevate or depress the front control.

The parallel levers are moved up or down simultaneously and to the same extent. This action steers the machine up or down as desired.

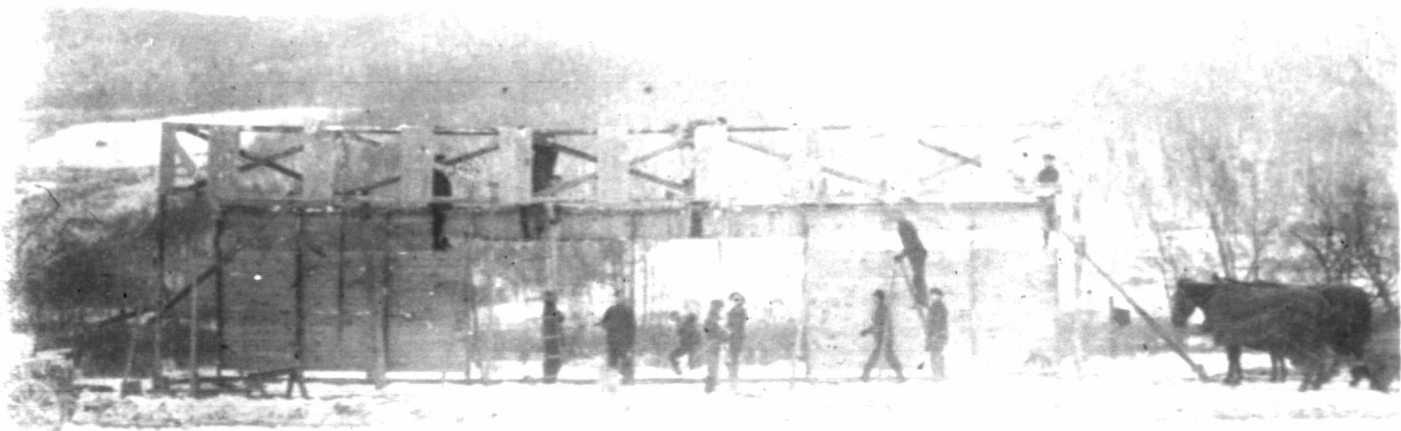
(2) Lateral stability is brought about by warping of the front control elevating one side and depressing the other, by moving one lever up and the other down.

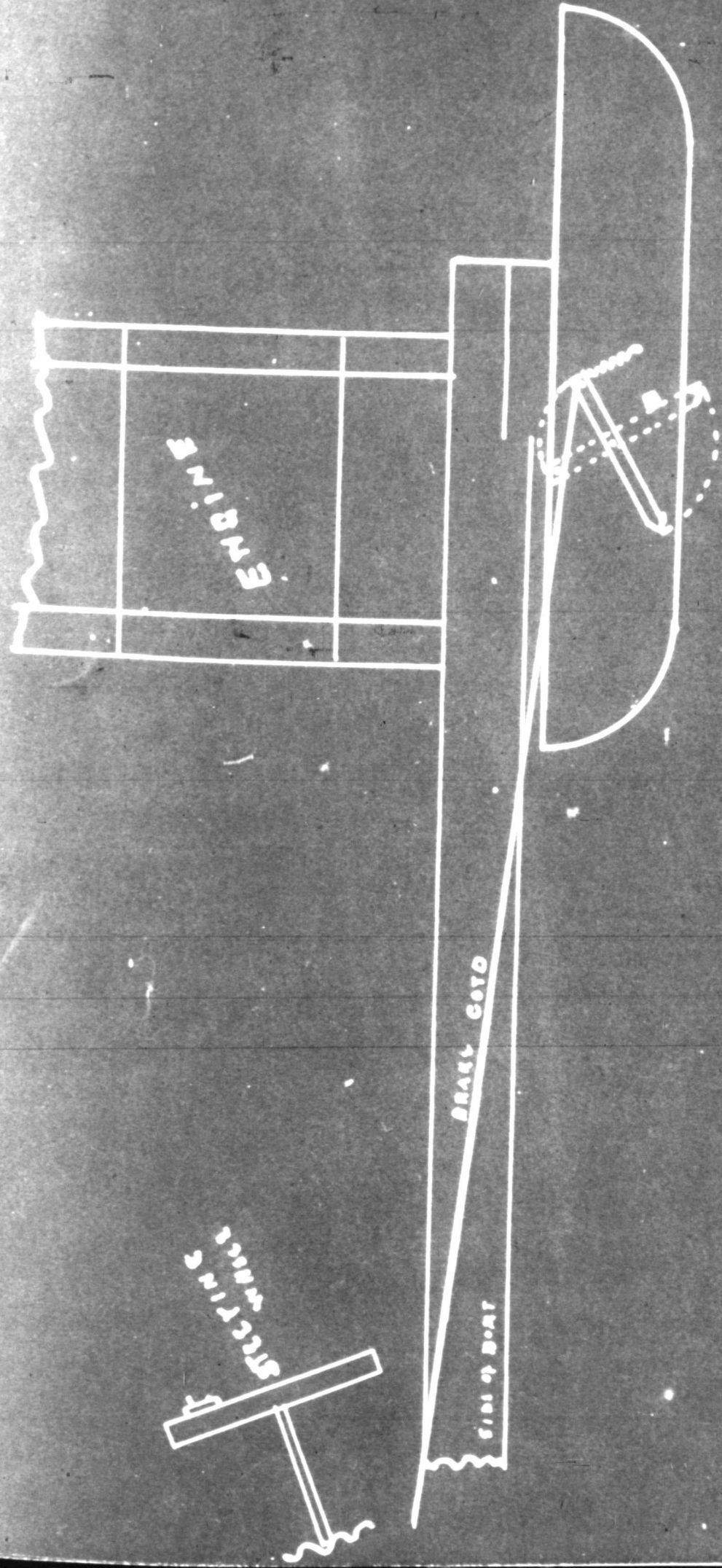
The following case may explain more clearly the action brought about. Suppose the operator wishes to depress his machine on the port side and elevate it on the starboard side, he therefore depresses his right lever and elevates his left. At the control the action will be just the opposite, the right portion will be elevated, left portion depressed. Acting on the wind of advance the advancing angles displayed in this way should bring about the desired effect.

(3 ) How horizontal steering to right or left by front control is brought about in this way:- In connection with the horizontal front control there is a vertical control pivoted to the horizontal control at the forward edges of both. The rear edge of the vertical rudder is fastened by means of two wires to the body so that it cannot be moved. Now by moving the levers from right to left the horizontal front control is moved in its own plane from left to right. The front margin of the vertical rudder being fastened to the front margin of the horizontal control is necessarily moved also. The rear margin being held stationary to the body of the machine does not move. In this way the wind of advance may be made to act on either side of the vertical control steering the machine to right or left at will.

G.H.B.

-----00-----



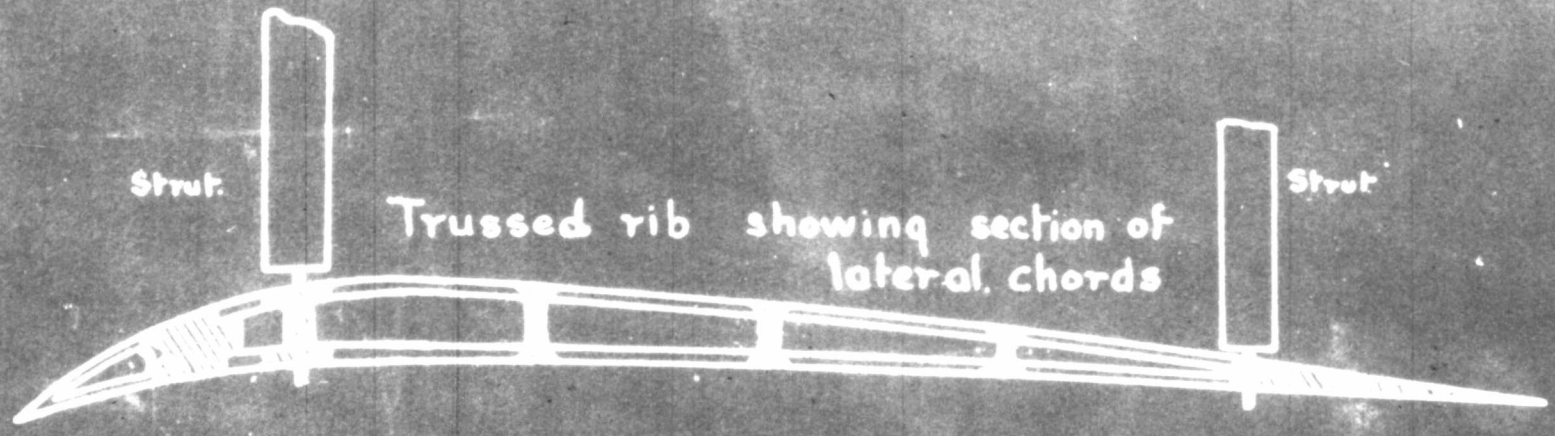


BRAKE on Ice Boat

Showing on Runner only

Wm. T. Brown Feb 23 1909





Strut.

Trussed rib showing section of lateral chords

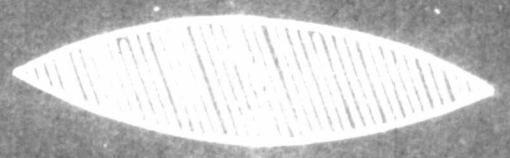
Strut



Cross-section of lateral chord.

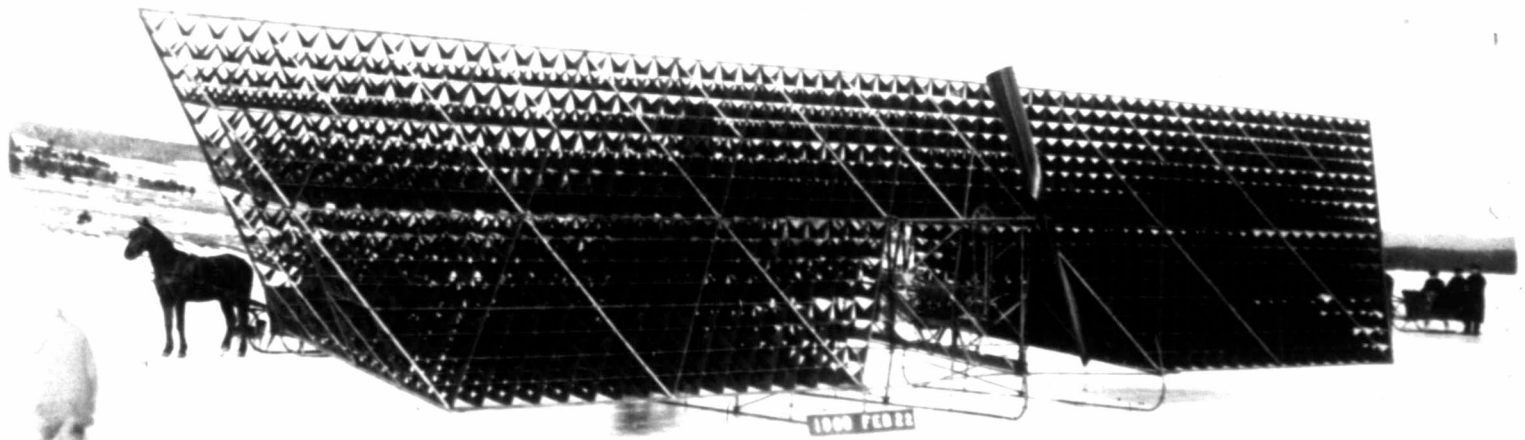
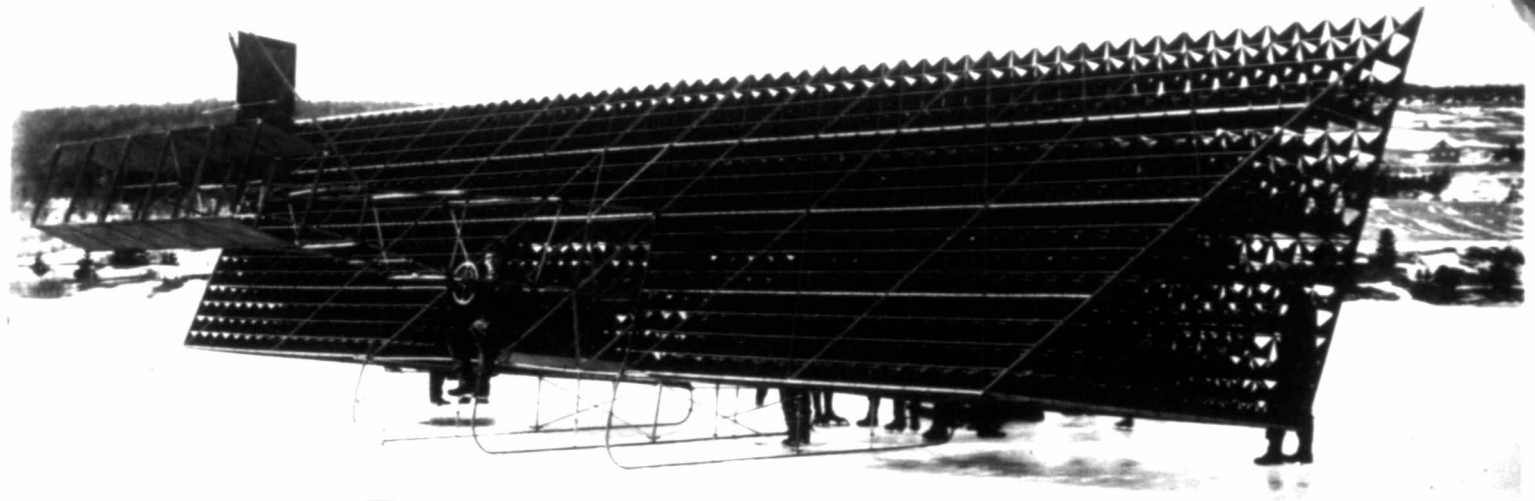


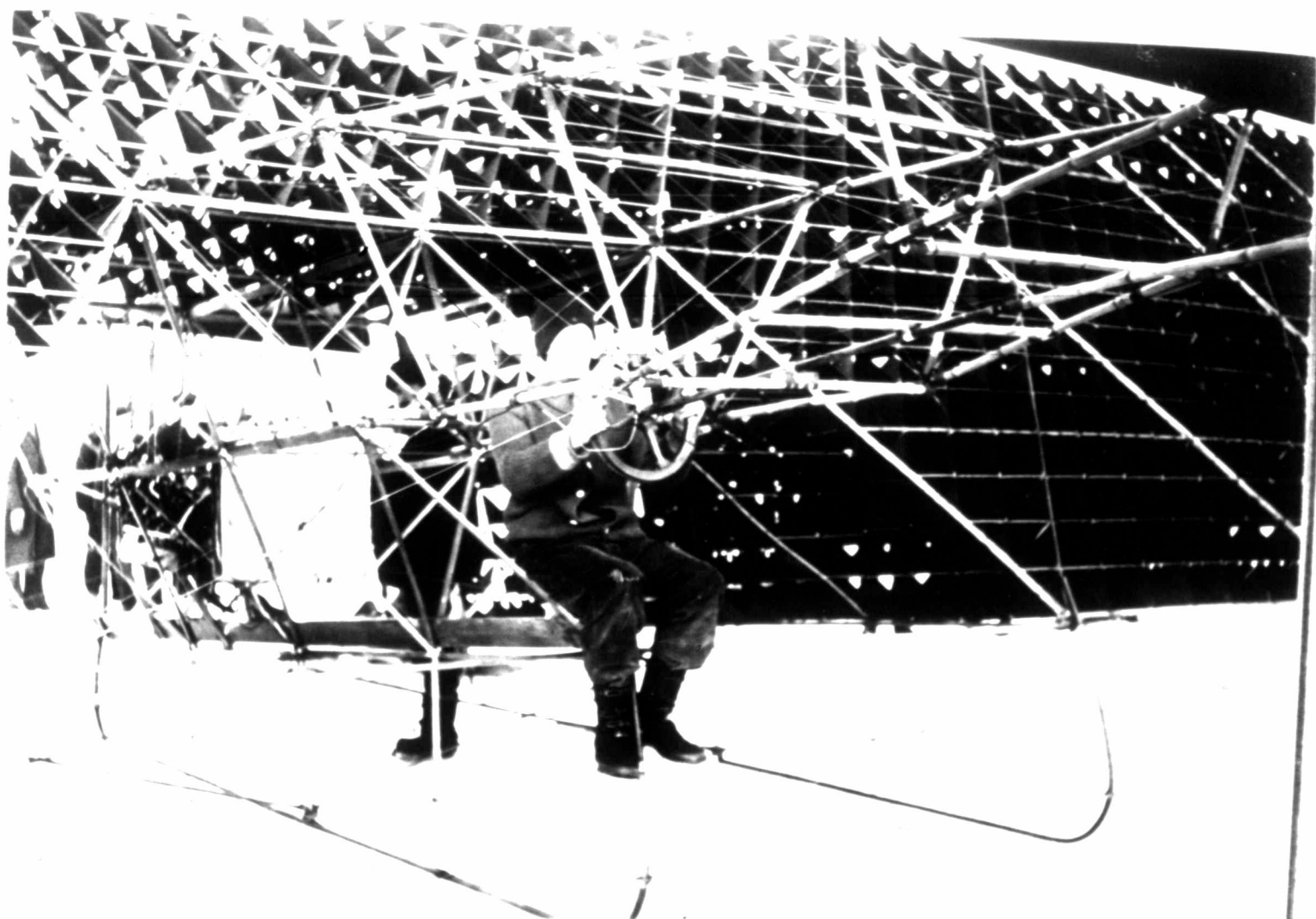
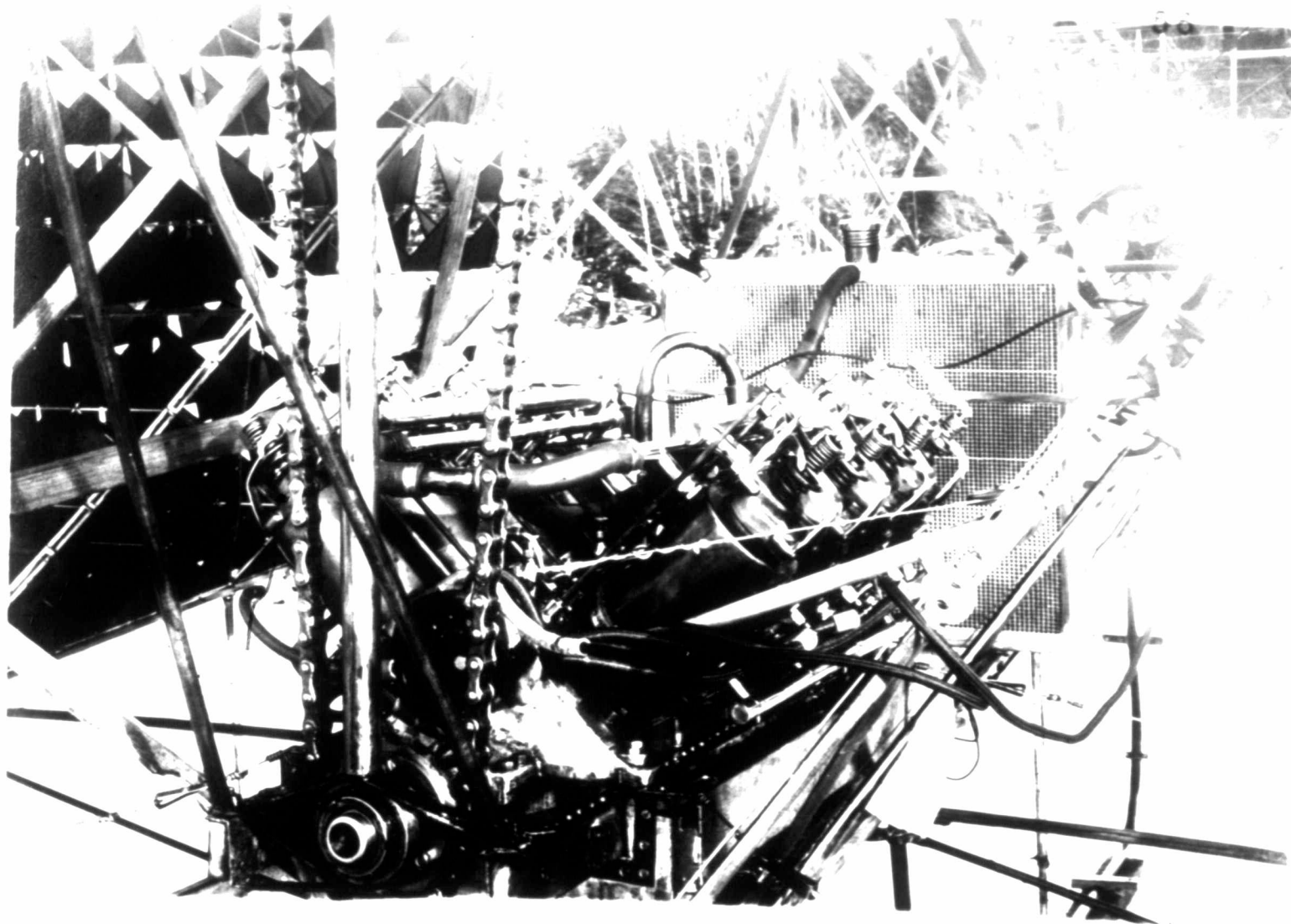
Fish-shaped.

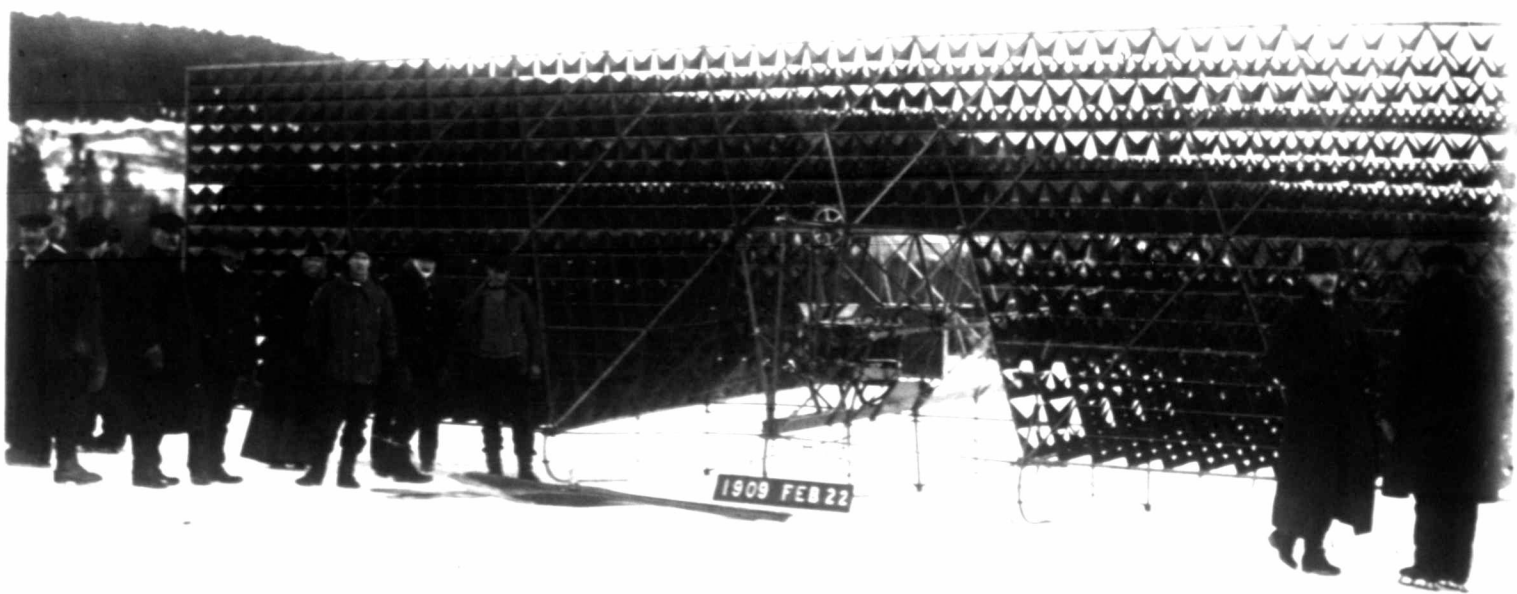
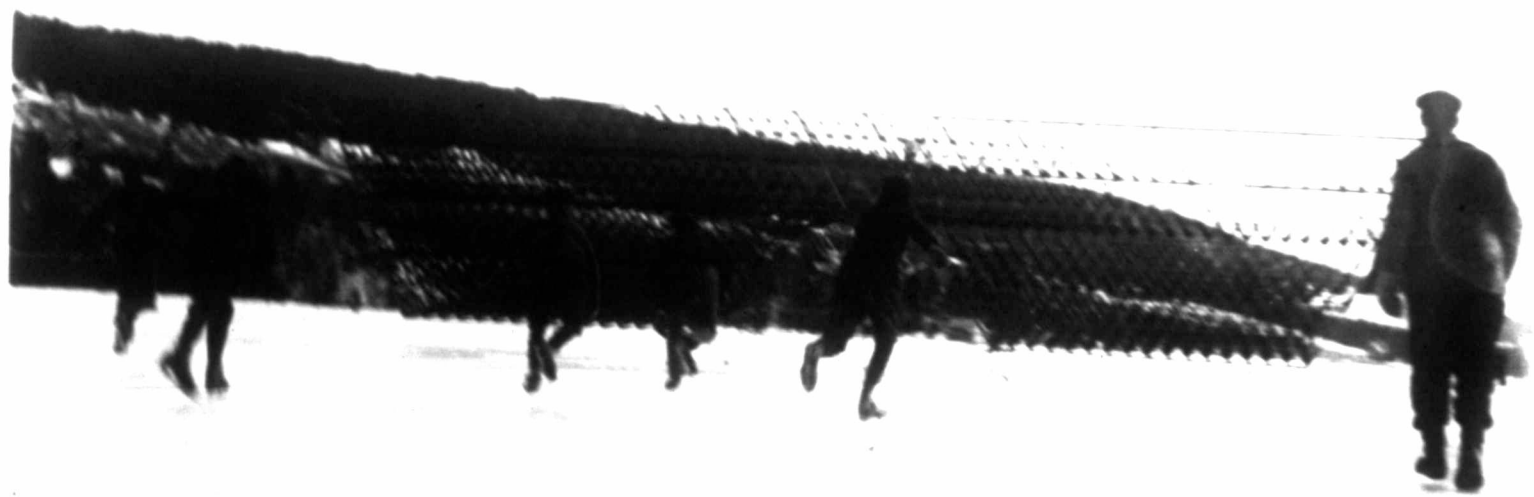


Maxim's Best.

Patented by J. M. B. 1908

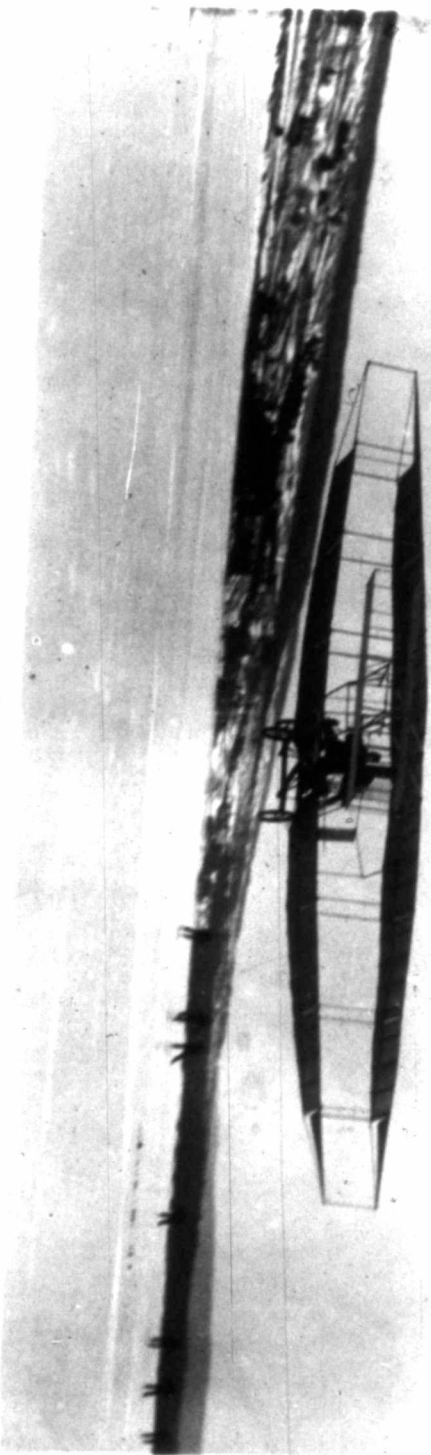
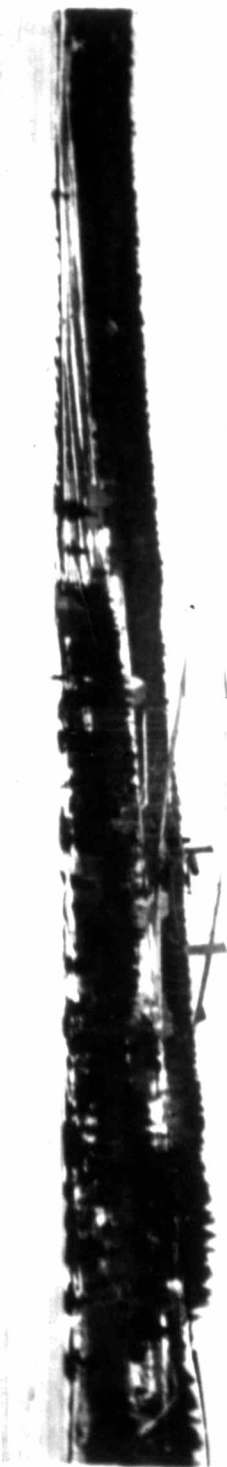
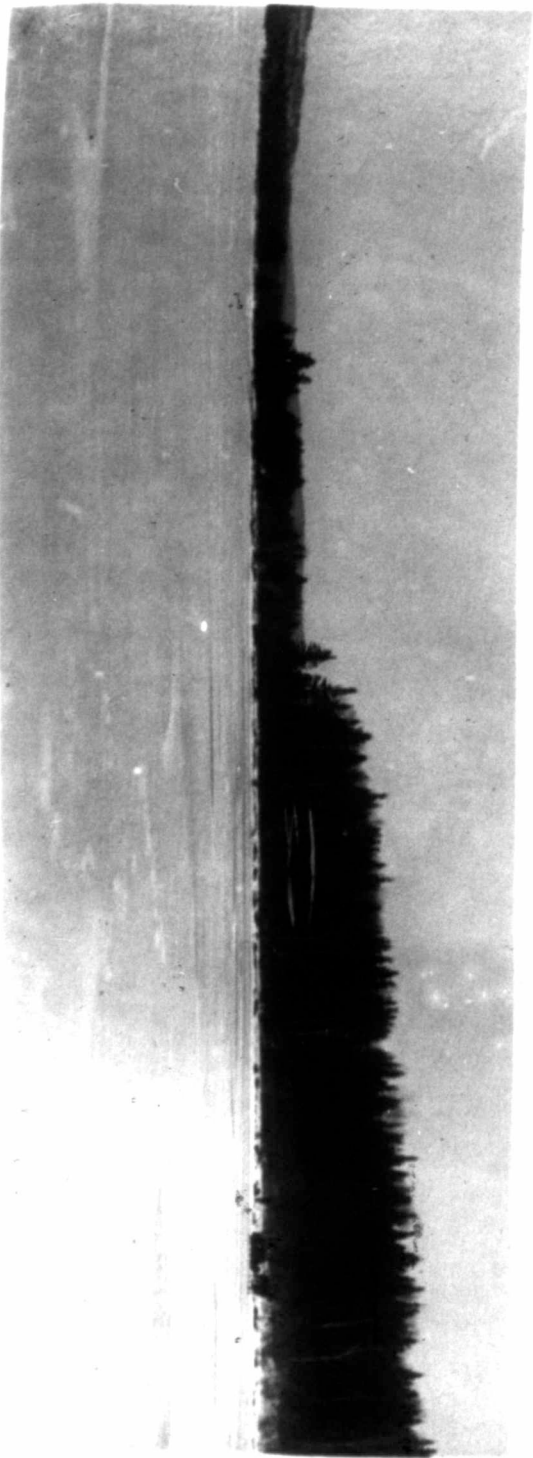












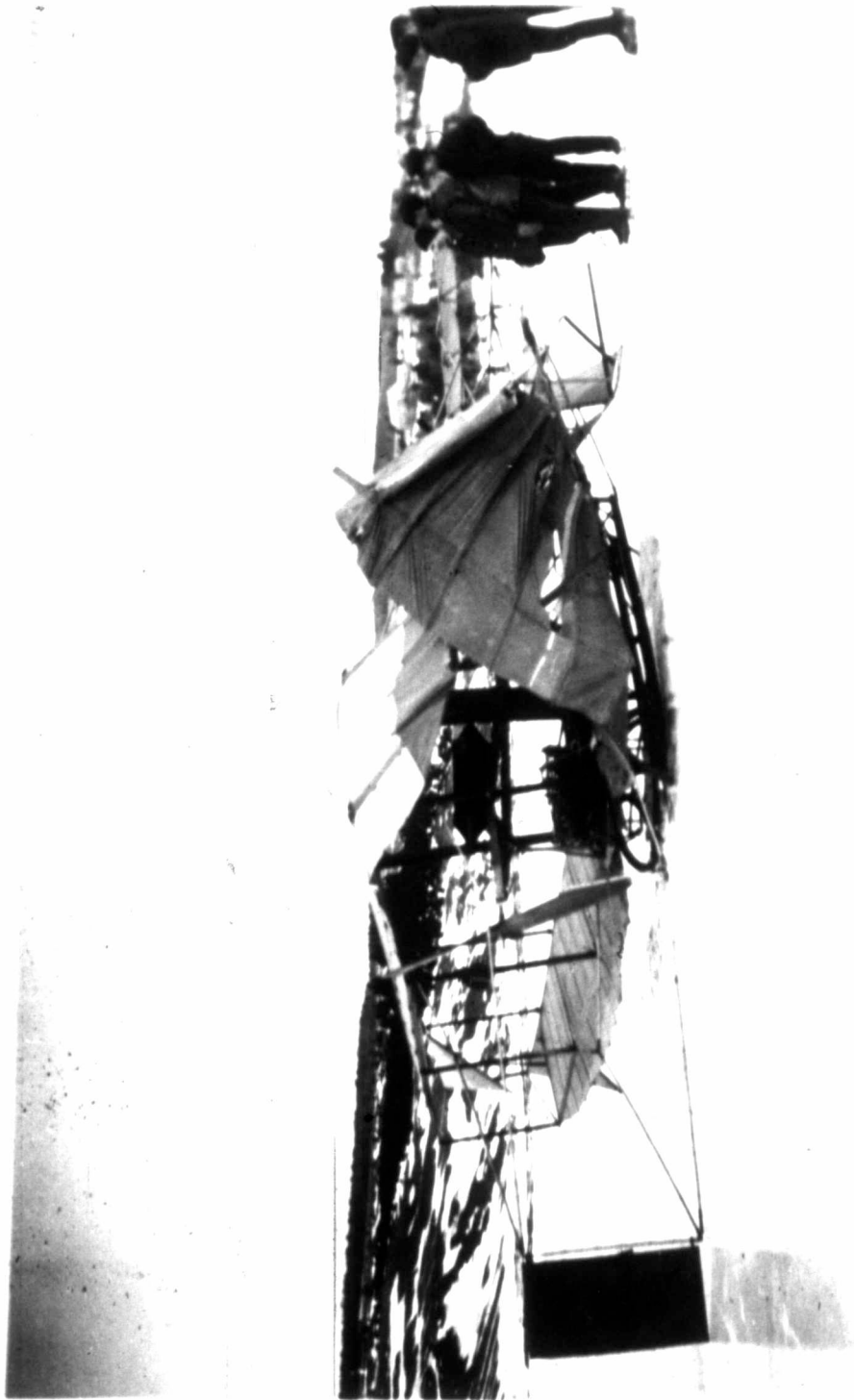


Fig 1.

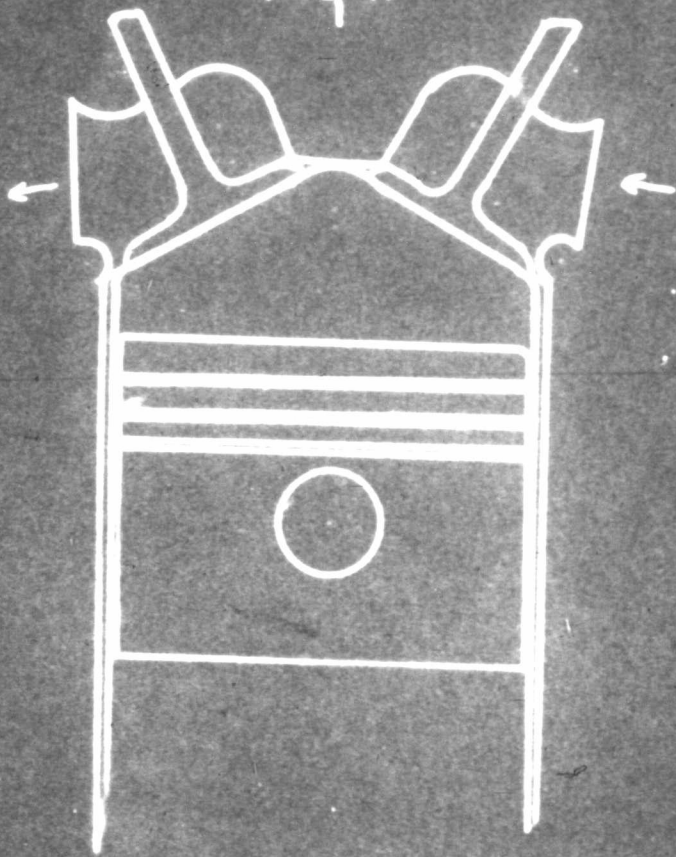
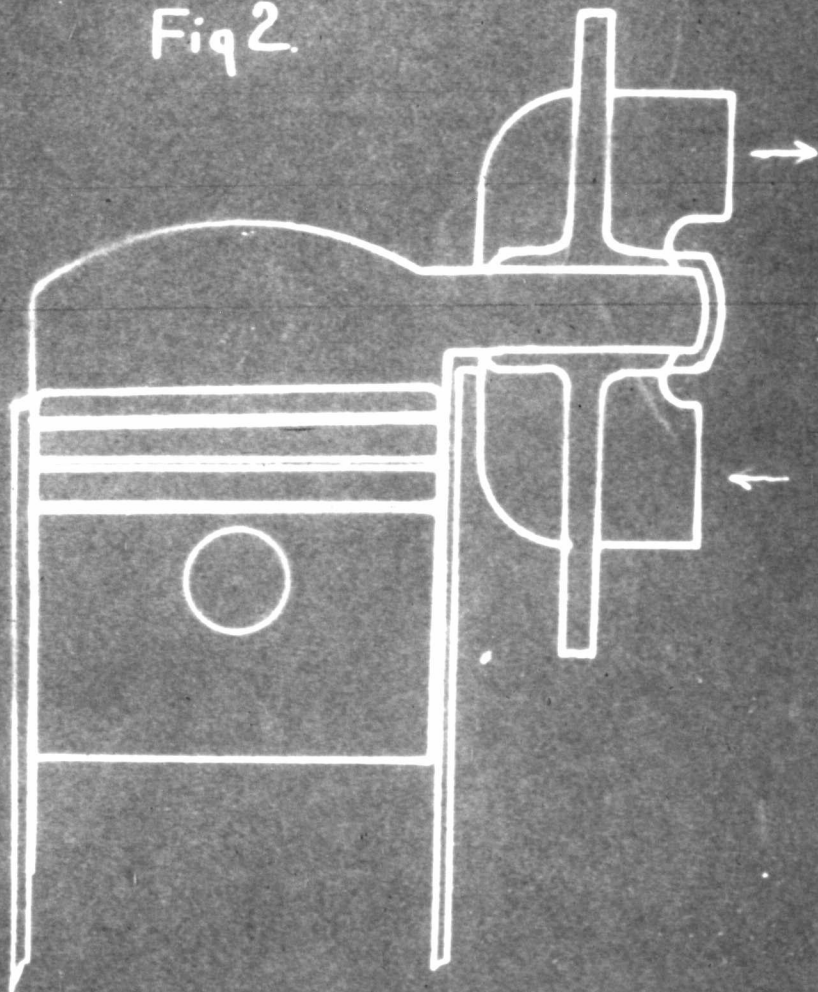


Fig 2.



GHC. Feb 27 '09