

18197 Dettmarr's Tool for Expanding Tubes.

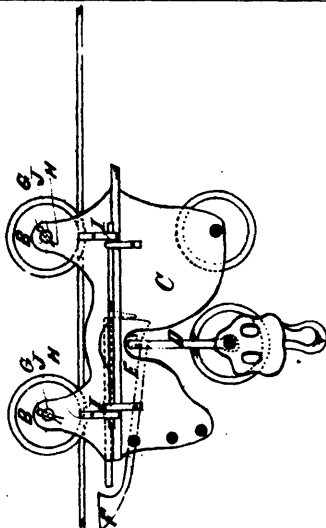

18198 Hall's Machine for Unloading Hay in Barns

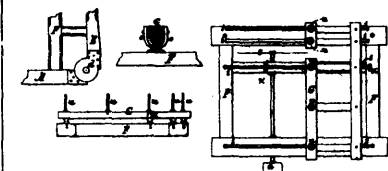
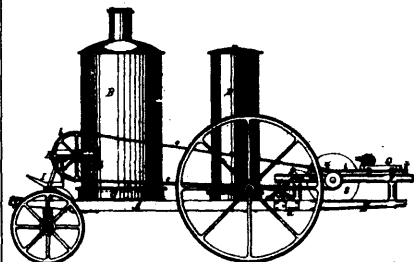

18199 Dunckel's Portable Steam Sawing Machine.

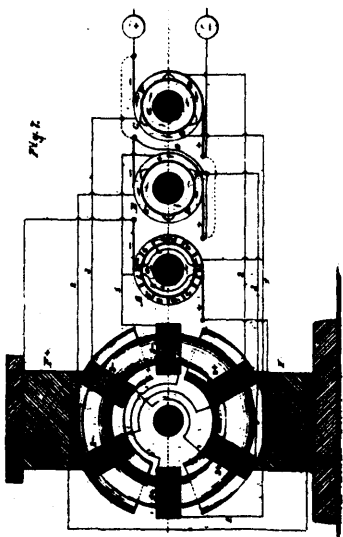

18200 Bain's Improvements in Electric Generators.

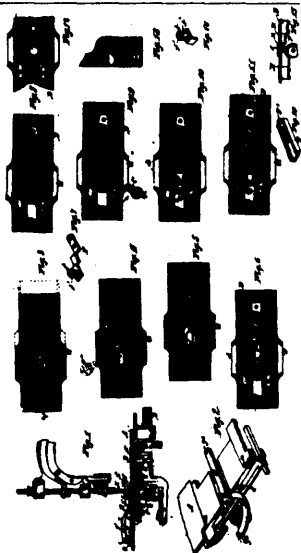

18201. Banks' Button Hole Sewing Machine.

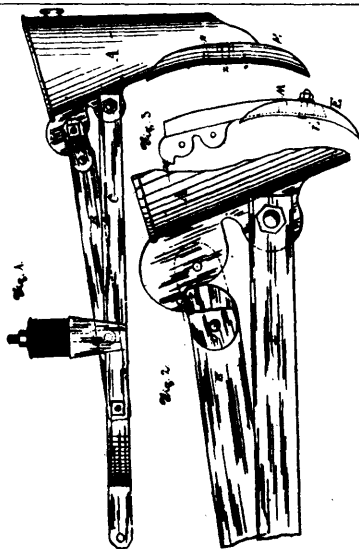

18202 Keller's Improvements in Flexible Hoses.

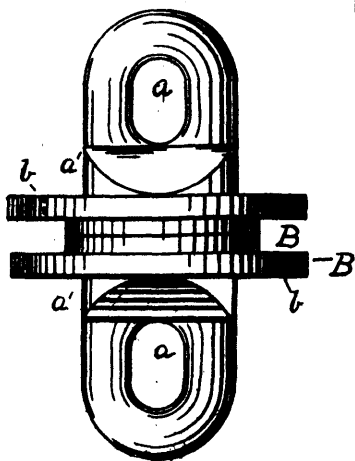

18203 Wadham's Chain Pump Bucket.

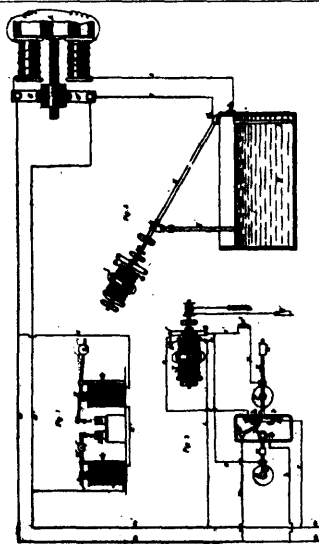

18204 Beeman, Taylor & King's Electric Current Governor.

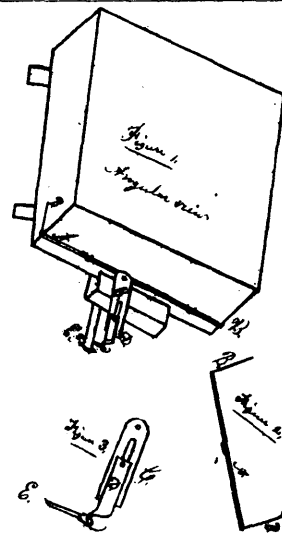

18205 Marr's Improvements in Car-Couplers.