

40160 Decrow's Electric Signal Box.

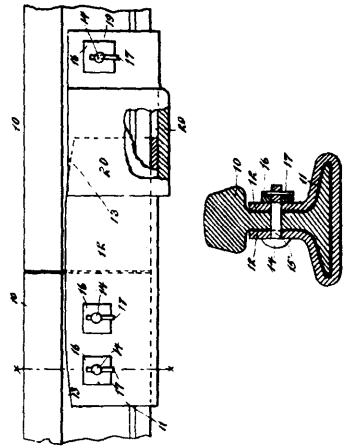

40161 Davis' Grain Conveyor for Harvesters.



40162 Roxby's Rail Joint

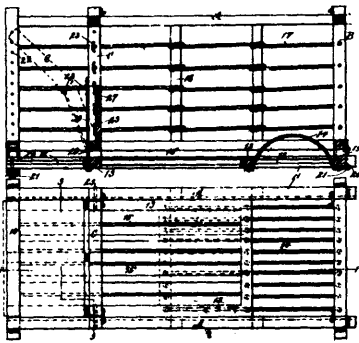

40163 Wallace's Hay Rack.

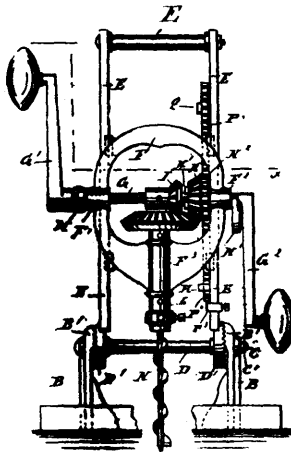

40164 Irwin, Mill and Hitch's Boring Machine.

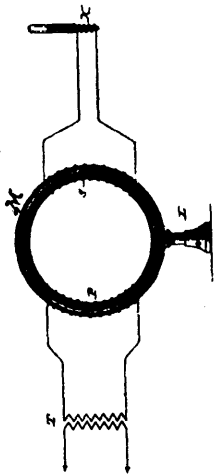

40165 Acheson's Calelectric Generator.

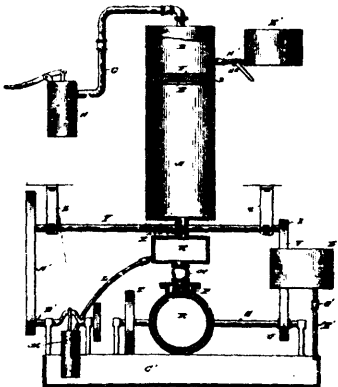

40166 MacLaughlin's Motor.

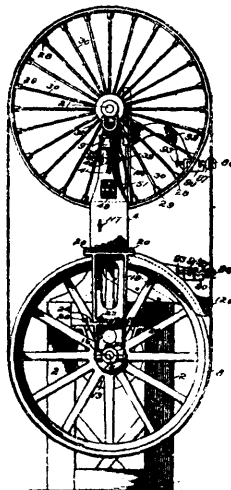

40167 Emerson's Band Saw Mill.

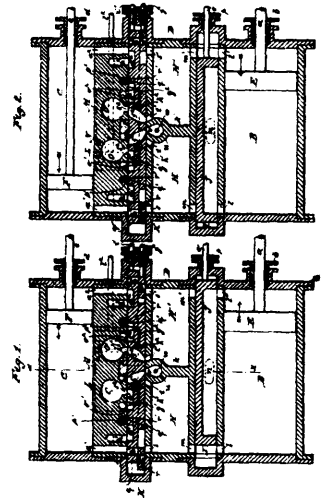

40169 Hoelljes' Method of Operating Gas Engines.