

7915 Schmitz's Improvement on Stench Traps.

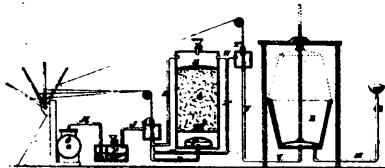

7916 Needles' Apparatus for Manufacturing Illuminating Gas.

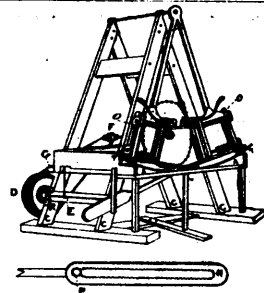

7917 Mumford's Improvements in Shingle Machines.

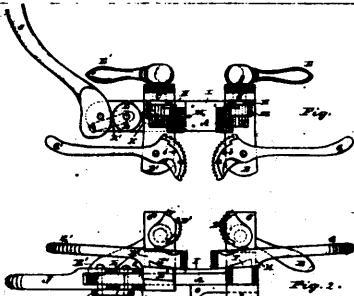

7918 Ross' Machine for Upsetting and Welding Tires.

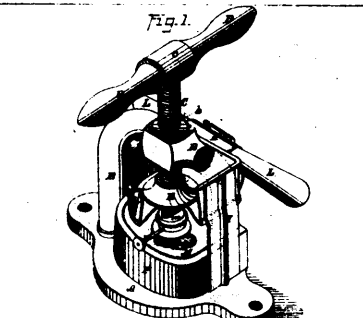

7919 Barnard's Art of, and Mechanism for, Constructing Dental Plates.

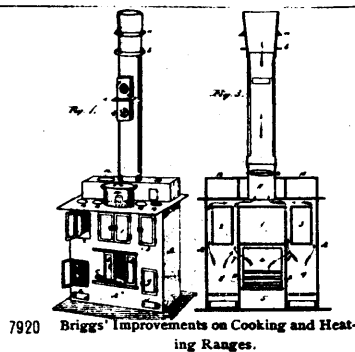

7920 Briggs' Improvements on Cooking and Heating Ranges.

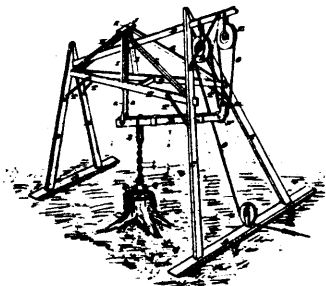

7921 Bruce's Improvements on Stump Extractors.

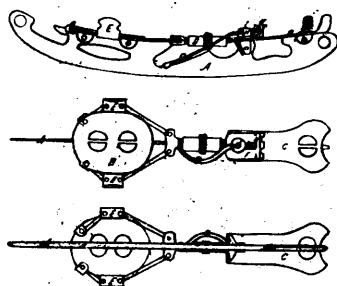

7922 Horsford's Improvements on Skates.

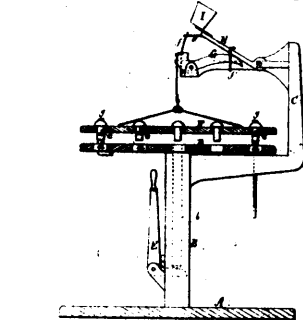

7923 Ethridge's Anemometer.

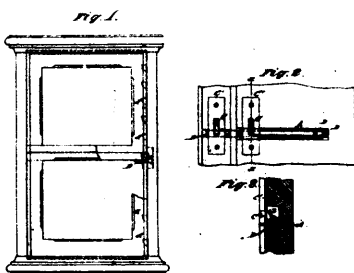

7924 Gerrish's Improvements on Sash Fasteners.

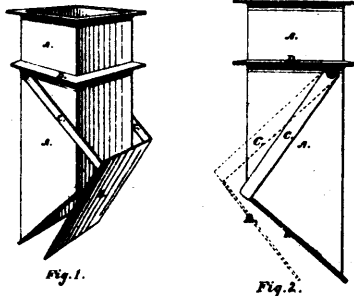

7925 Rice's Improvement in Stench Traps.

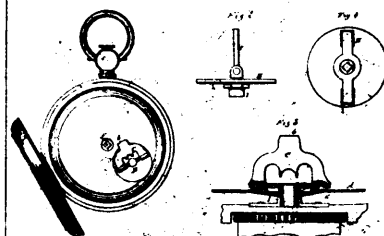

7926 Bracy, Kyle & Wormell's Improvement on Watch Winding Devices.

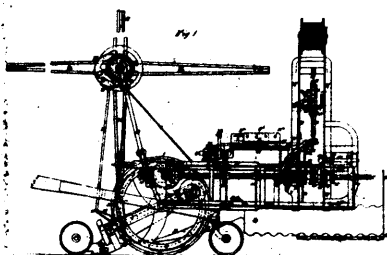

7927 Neale's Improvements on Harvesting Machines.

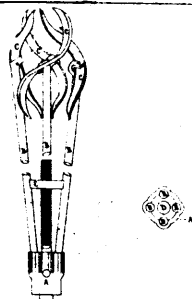

7928 Godfrey's Boiler Flue and Watch Pipe Cleaner.

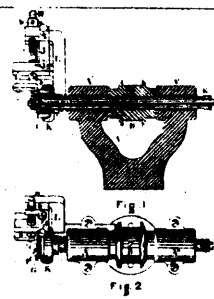

7929 Busell's Machine for Preparing the Edges of Soles.