

35673 Fauteux's Clothes Line Pulley.

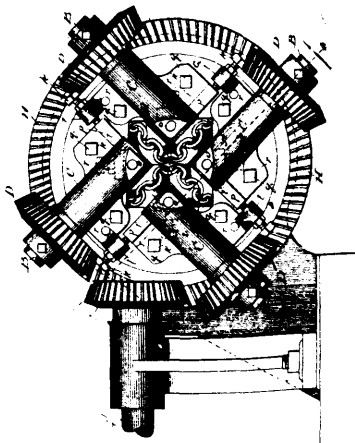

35674 Jacker's Candy Chain.

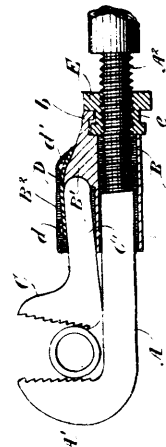

35675 Stanley's Wrench.

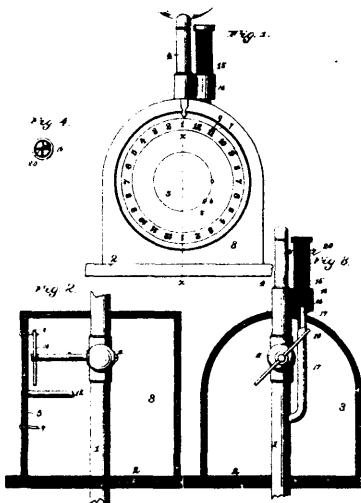

35676 Sanders and Willett's Automatic Gas Lighter and Extinguisher.

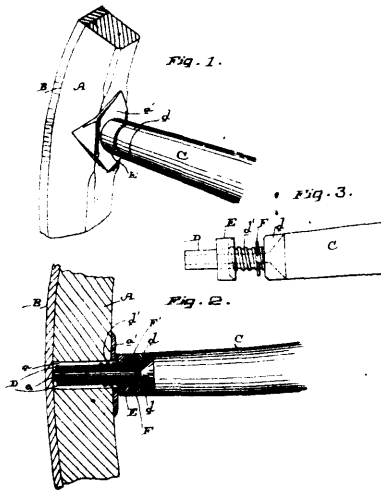

35677 Richards' Spoke and Tire Tightener.

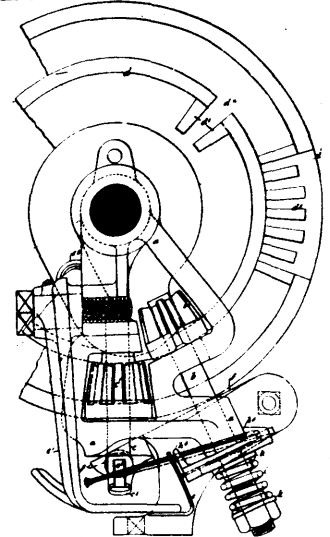

35678 Hornsby, Innocent, Trolley and Smith's Knotting Mechanism for Grain Binders.

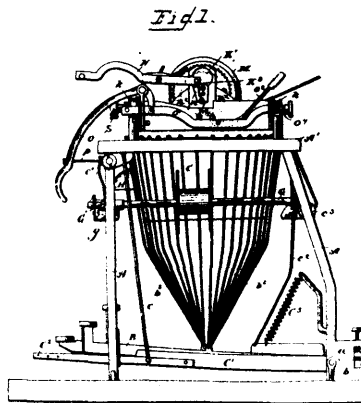

35679 Burn's Type Writing Machine.

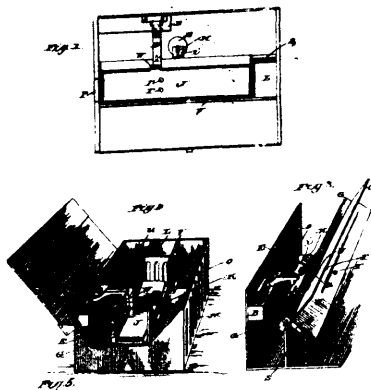

35680 Brawn's Vermin Trap.

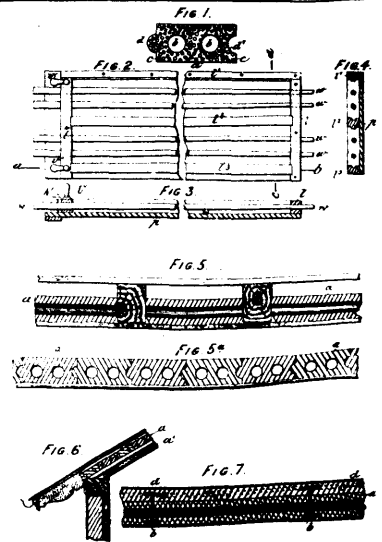

35681 Mack's Boards of Composite Material.