

4143 Skinner's Drum Heater.

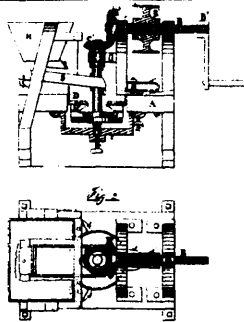

4144 Kaiser's Grain or Corn Crusher and Spice Mill.

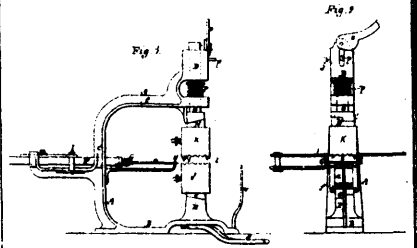

4145 Osmer's Darning Machine.

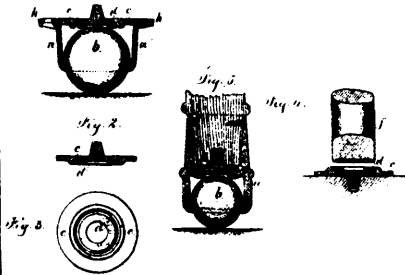

4146 Johnson's Improvements on Ball Castors.

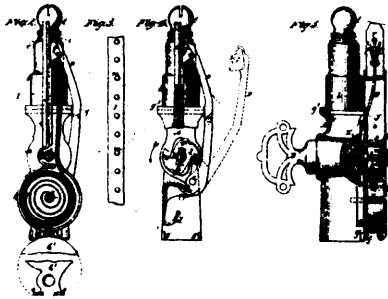

4147 Stockwell and Megill's Self-lighting Gas Burners.

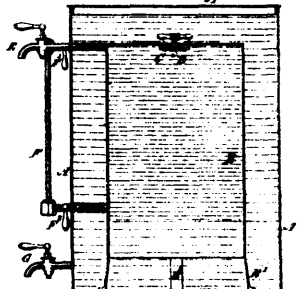

4148 Desgeorges' Apparatus for the Storage and Transportation of Petroleum.

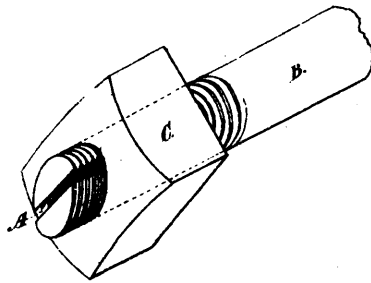

4149 Galbraith's Lock-nut Bolt.

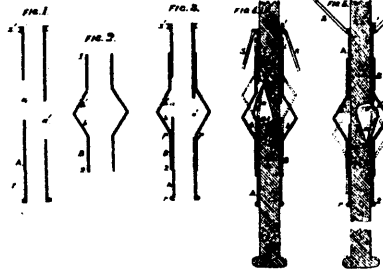

4151 Higgins' Automatic Umbrella Runner.

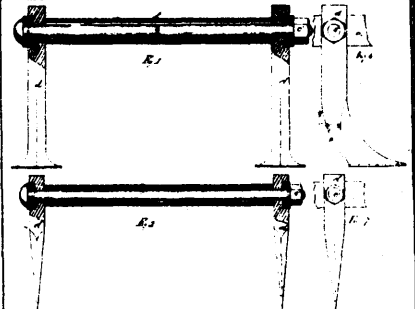

4152 Stafford's Harrow and Cultivator.

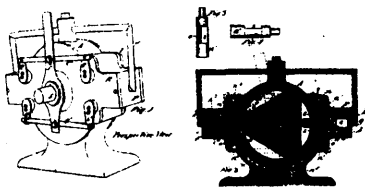

4153 Marsh's Rotary Steam Engine.

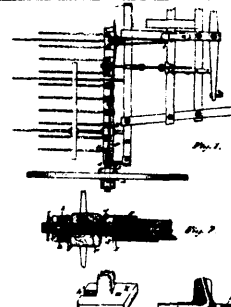

4154 Barclay and Kennedy's Improvements on Horse Rakes.

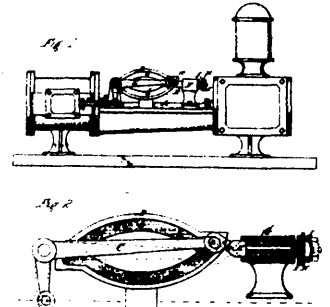

4155 Tesseyman & Smith's Valve Gear.

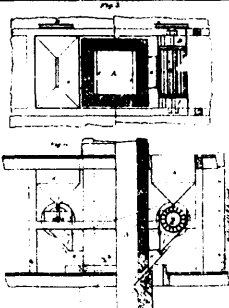

4156 Wheeler's Process and Apparatus for the Reducing of Iron and other Ores.

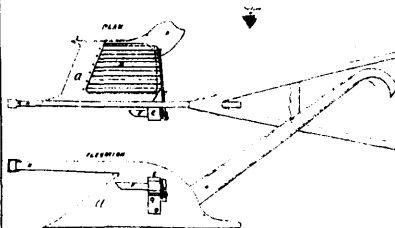

4157 Head's Potato-digger.

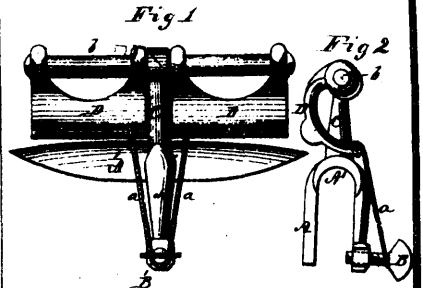

4158 Reed & Andrus' Rein-holder.