

25641 Herard's Hay Press.

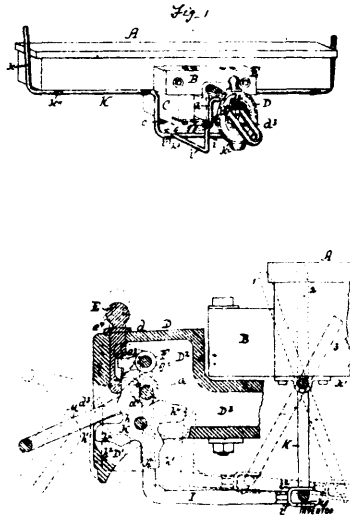

25642 Powell's Car Coupling

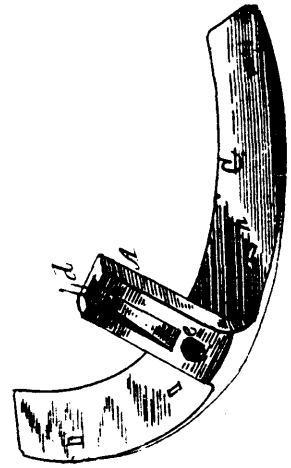

25643 Wilcox's Toe-Weight.

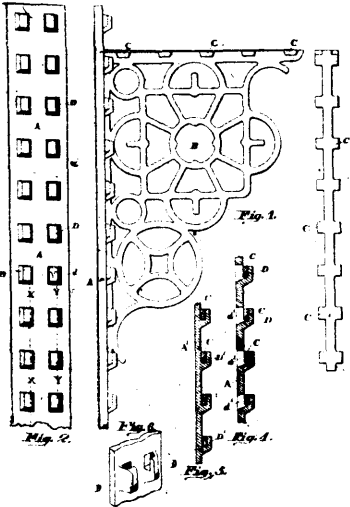

25644 Koch's Bracket.

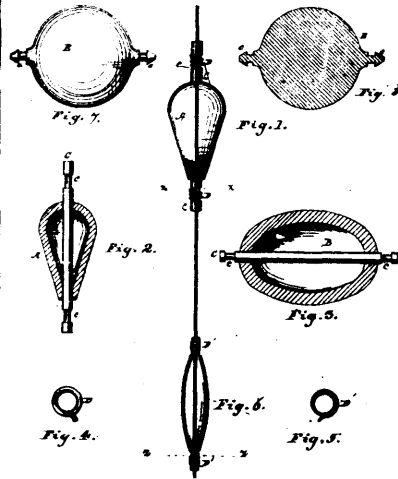

25645 Pflueger's Fishing Float and Line.

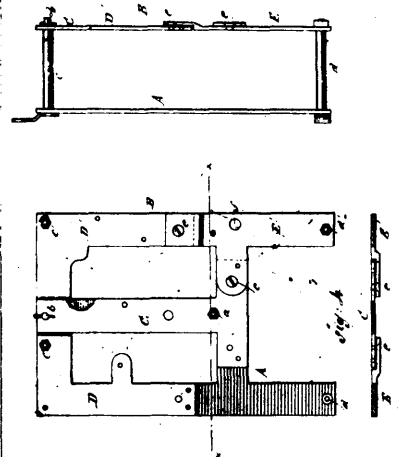

25646 Sandmark's Clock Movement Frame.

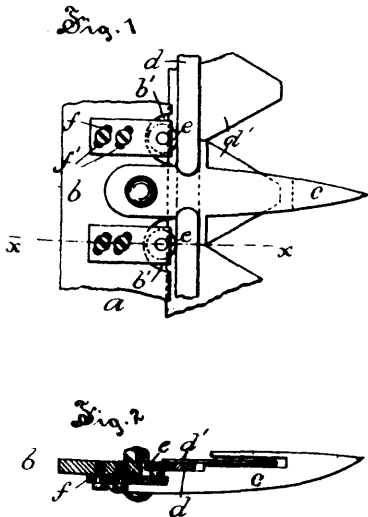

25647 Weaver's Finger Bar for Mowing Machines.

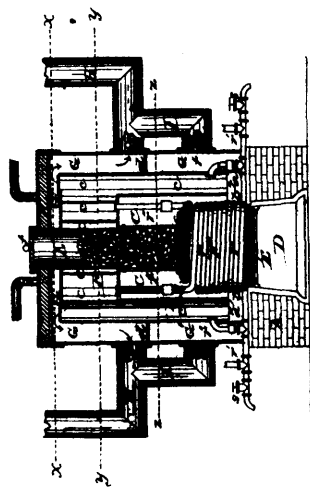

25648 Peace's Steam Boiler.

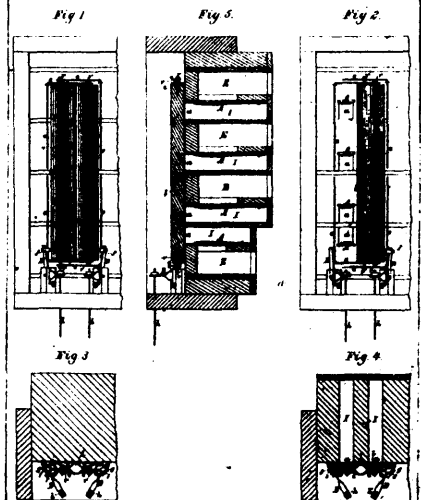

25649 Hamilton's Reed Organ.