

14511 Reach's Improvements on Water Closets.

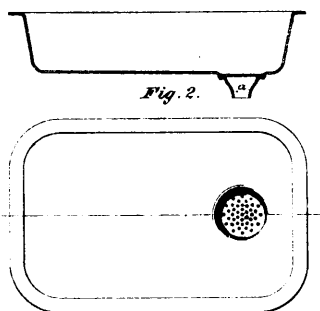

14512 Kilbourne's Improvements in Sinks.

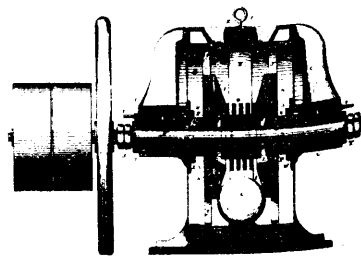

14513 Feldmann's Improvements in Pulverizing Machines.

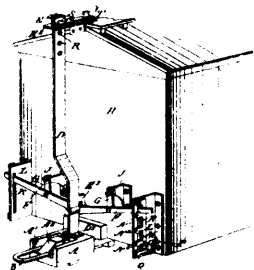

14514 Barrett's Improvements on Car-Couplings.

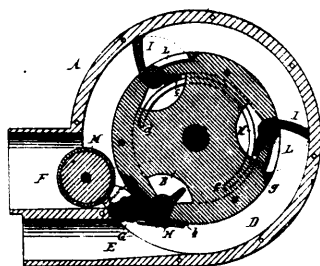

14515 Gurd's Improvements on Rotary Motors.

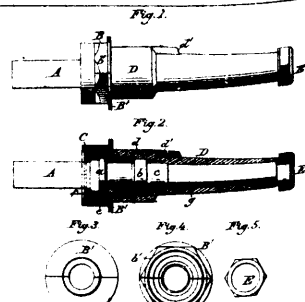

14516 Provancher's Improvements in Carriage Axles.

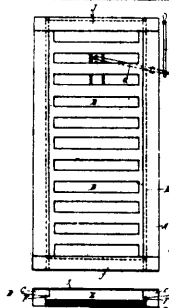

14517 Symonds's Fire Bottom for Stoves, Grates and Furnaces.

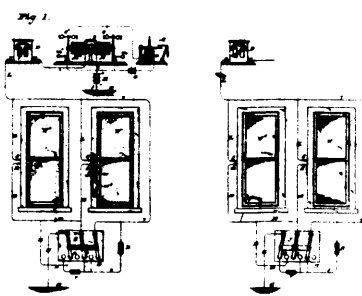

14518 Kerner's Improvements on Electric Burglar Alarms.

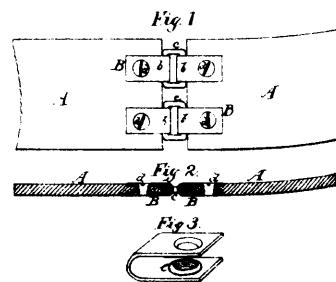

14519 Rice's Improvements on Belt Couplings.

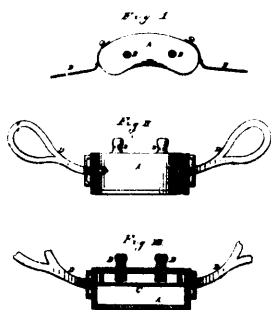

14520 Leslie's Improvements on Inhaling Apparatus.

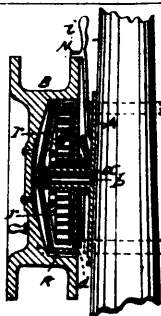

14521 Smith's Improvements on Fishermen's Reels.

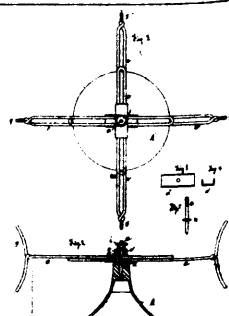

14522 Burrowes's Improvements on Yarn Reels.

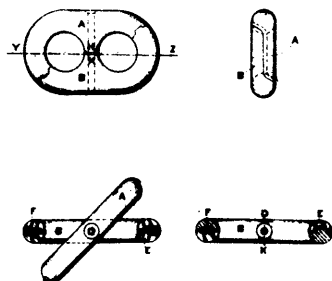

14523 Walker's Improvements on Connecting and Disconnecting Links.

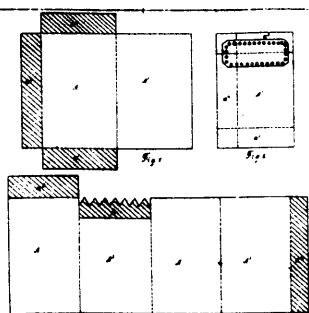

14524 Cox's Improvements on Envelopes.

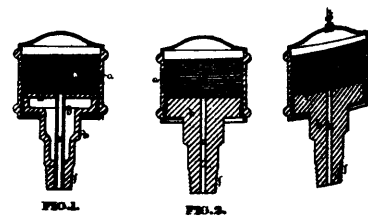

14525 Rhodes's Improvements on Lubricators.