

5247 Aldred's Rail-Road Track Lifting Machine.

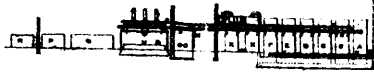

5248 Smith & Simpson's Improvements on Production and Manufacture of Iron, Steel, and other Metals, and on the Apparatus and Compounds employed therein.

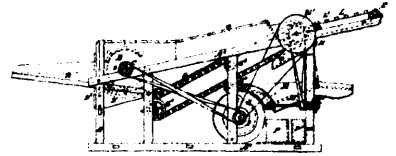

5249 Bellefeuille's Grain Threshing Machine.

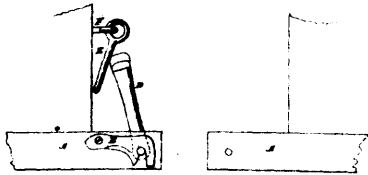

5250 Dill's Car-Coupling.

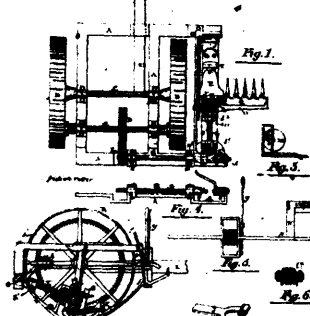

5251 Robbins' Improvements in Mowing and Reaping Machines.

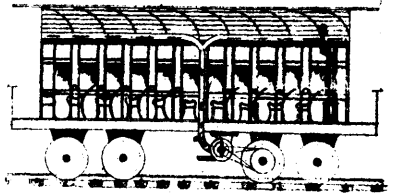

5252 Hargreaves' Railway Car Ventilator.

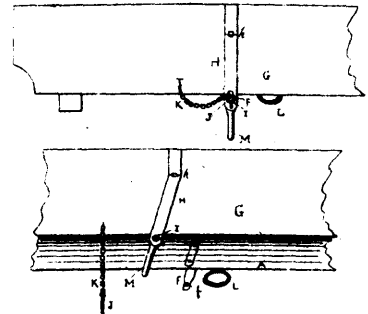

5253 Harvey's Dumping Waggon.

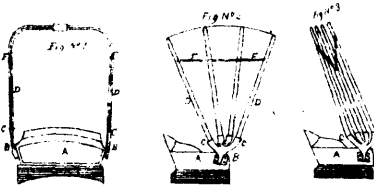

5254 Ayres' Portable Buggy Top.

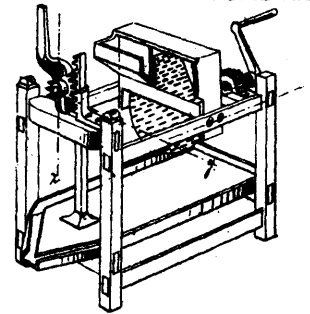

5255 Sells' Cider Mill.

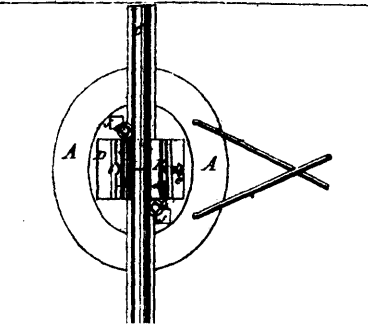

5256 Porter & Peck's Railway Rail Support.

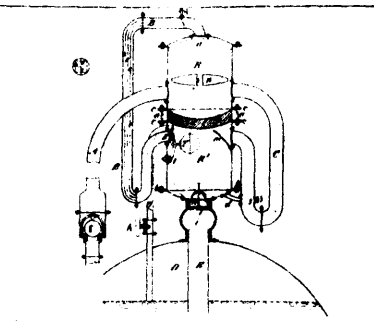

5257 Yaga's Improvements on Feeding Apparatus of Steam Boilers.

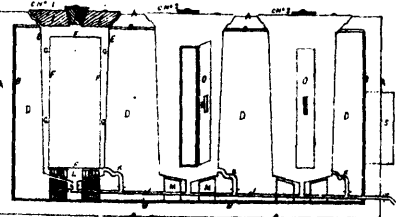

5258 Shirreff's Improvements on Freezing and Refrigerating Machines.

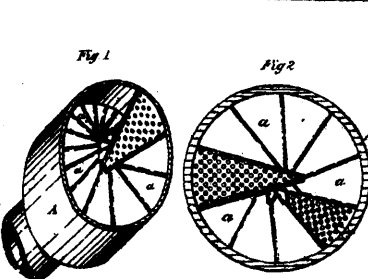

5260 Hawkesworth's Spark Arrester.

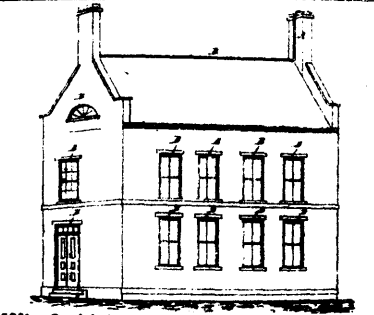

5261 Steele's Improvement on Apparatus for Extinguishing Fires.

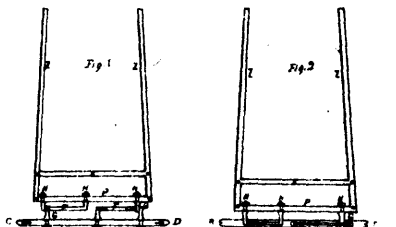

5262 Wood's shaft-coupling for Cutters.