

Fig. 2

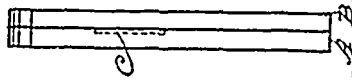

Fig. 1

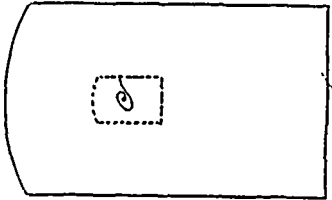
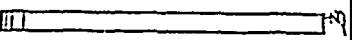
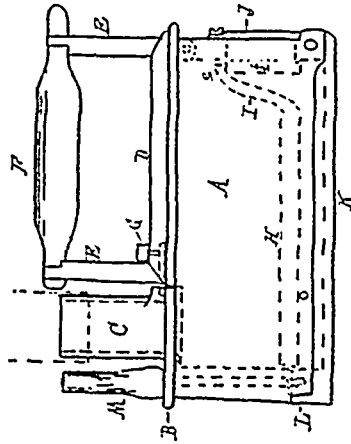

Fig. 3



29011 Mills' Memorial Tablet.



29012 Eisenberg's Tailor's Iron.

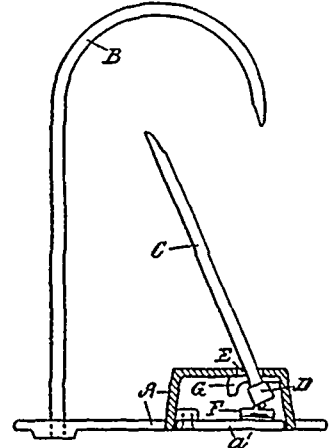

29013 Balcom's Letter and Bill File.

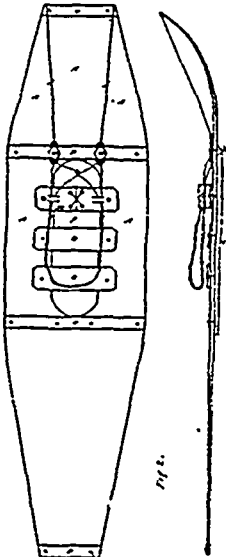

29014 Watson's Snow Shoe.



29015 Katz's Steam Ploughing.

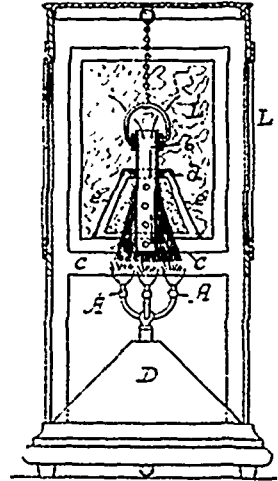

29016 Leeds' Apparatus for Heating or Cooking.

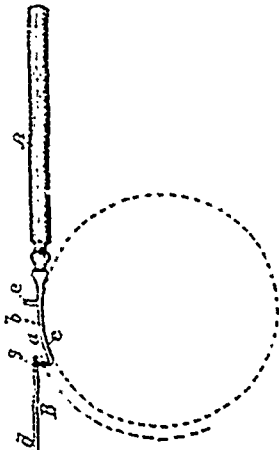

29017 McNeal's Fruit Knife.

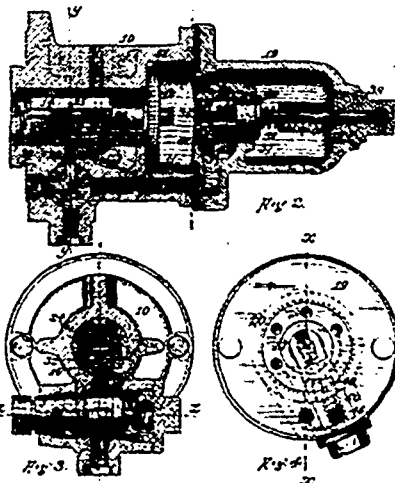

29018 Westinghouse's Fluid Pressure Brake Mechanism.

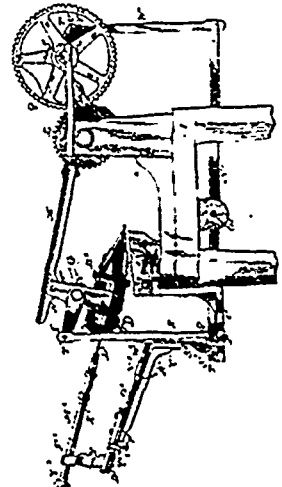

29019 McKim's Nail Plate Feeding Machine.