

6583 Frank's Improvements on Sulky Harrows and Hay Rakes.

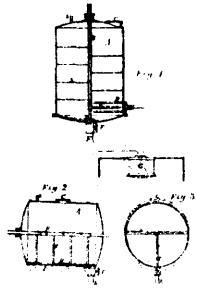

6584 D'Heureux's Process for Treating Grain.

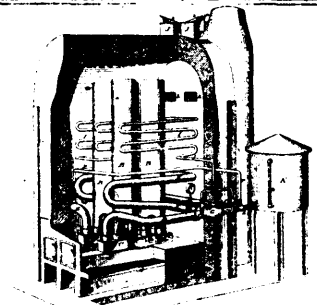

6585 Salisbury's Manufacture of Gas from Liquid Hydrocarbons and Apparatus for the same.

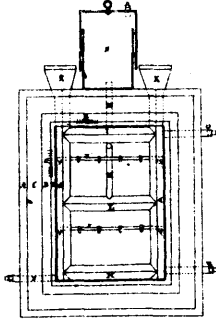

6586 Ayer's Improvements on Freezing Apparatus.

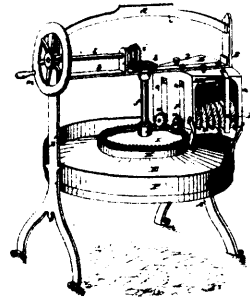

6587 Willi and Hunerwadel's Meat Machine.

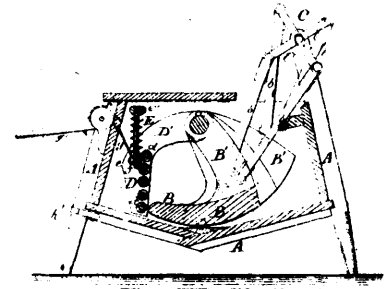

6588 Shotwell's Washing Machine.

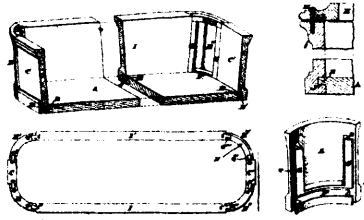

6589 Richey and McDougall's Improvements on Coffins.

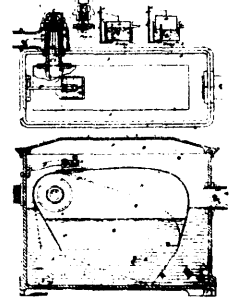

6590 Royle's Improvement in Steam Traps.

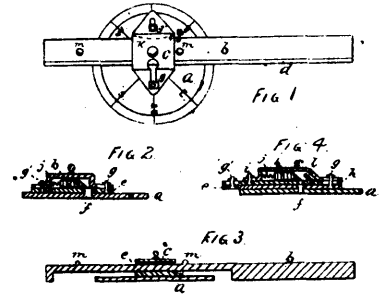

6591 Leach's Navigator's Protractor.

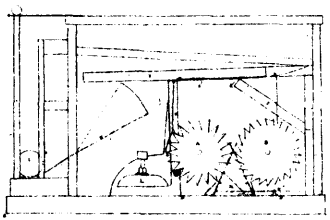

6592 Nicolls' Ballot Box.

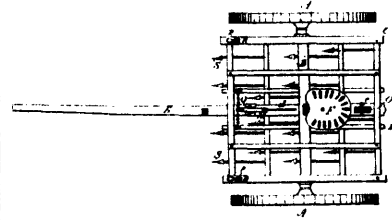

6593 Richardson's Improvements in Fallow Cultivators.

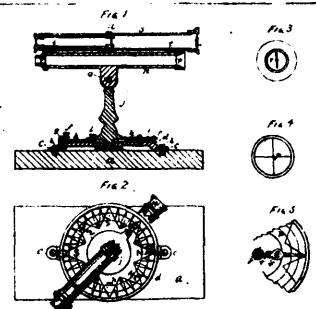

6594 Leach's Navigator's Bearing Indicator.

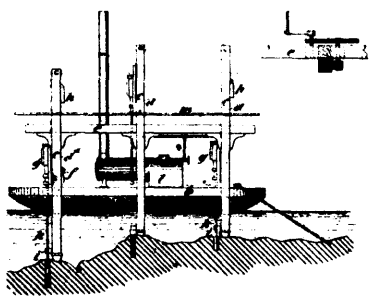

6595 Gilbert's Sub-Aqueous Drilling Apparatus.

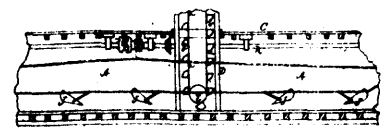

6596 Milsom's Device for Elevating and Weighing on Board of Vessels.



6597 Holmes' Improvements on Atomizers.