

41424 Turner. Brown and Van Beek's Electric Elevated Railway.

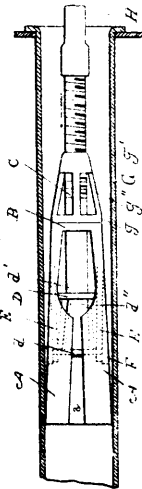

41425 Dunn's Boiler Tube Cleaner.

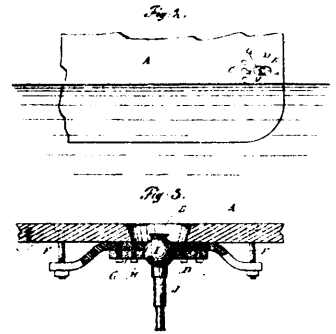

41426 Nelson's Means for Distinguishing Vessels in Fogs.

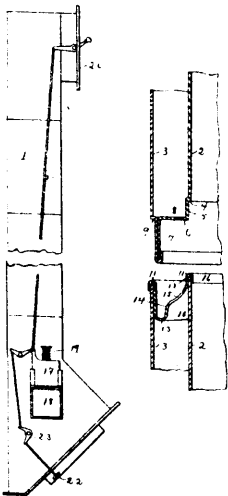

41429 Eversman and Wagner's Hot Air Pipe and Air Flue.

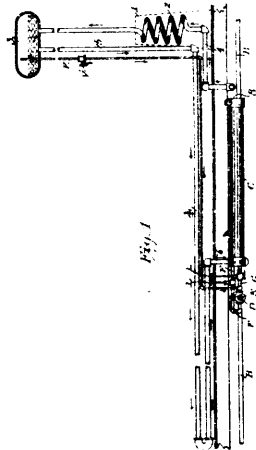

41430 McElroy's Heating Apparatus for Railway Cars.

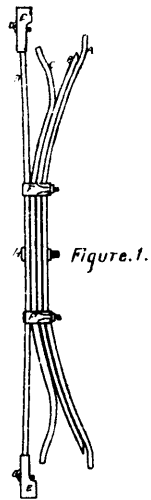

41431 Smale's Waggon Spring.

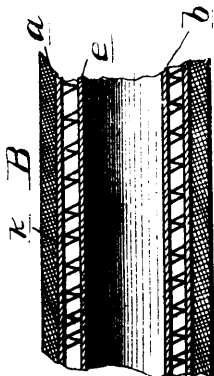

41432 Gendron's Elastic Tyre.

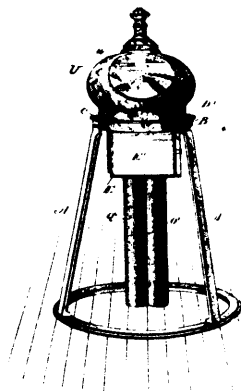

41433 Townsend's Recording Compass.

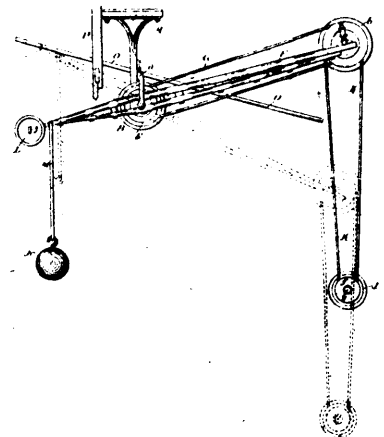

41434 Frost's Polishing Machine.