

38574 Glass' System of Cutting Garments.

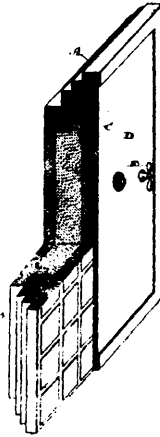

38575 Martin's Burglar Protection Device for Safes.

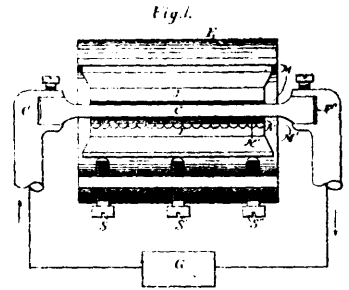

38576 Thomson's Method of Electric Soldering and Cementing.

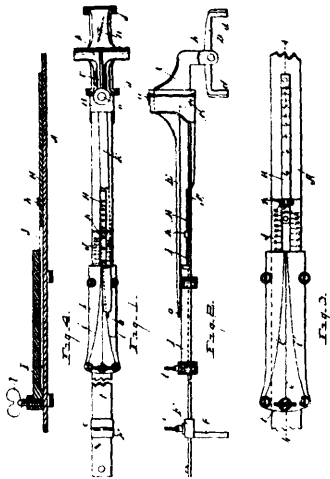

38577 McQuarry's Axle Gage.

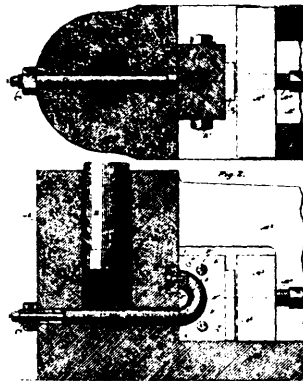

38578 Rosenfield's Apparatus for Making Lead Pipe S-Traps.

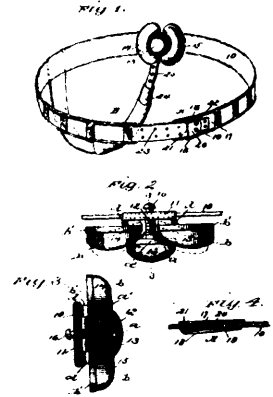

38579 Brownlow and Warner's Truss.

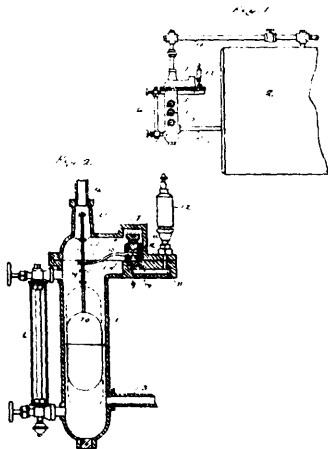

38580 Williams' High and Low Water Alarm.

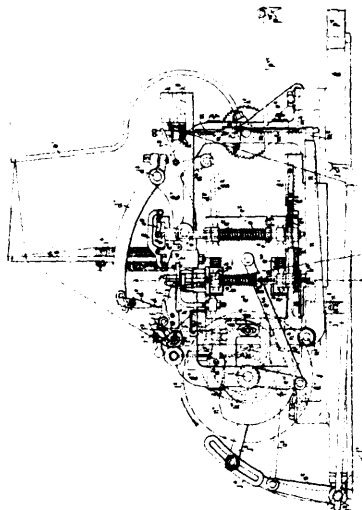

38581 Saurer and Kobler's Machine for Threading Needles of Embroidering Machines.

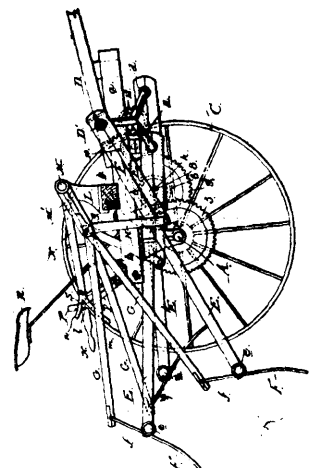

38582 Reynolds' Hay Tedder.