

FIG. 1.

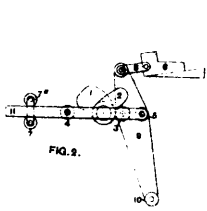

FIG. 2.



FIG. 3.

FIG. 4.

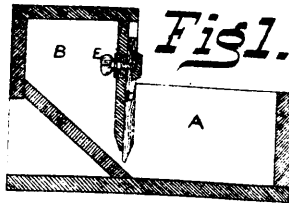

FIG. 1.

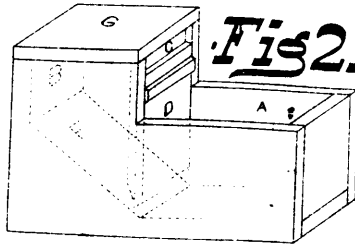

FIG. 2.

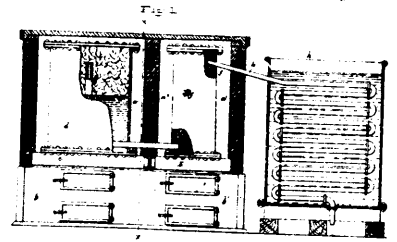

FIG. 1.

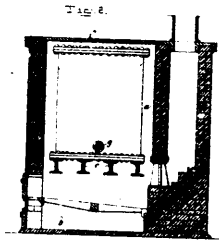

FIG. 2.

33519 Greening's Loom for Wire Weaving.

33520 Sander's Feed Box for Horses, etc.

33521 Pitt's Apparatus for Distilling and Deodorizing Petroleum.

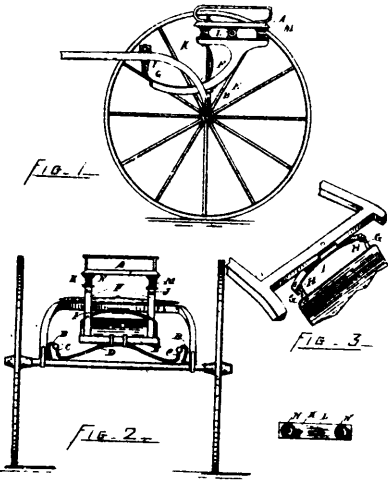
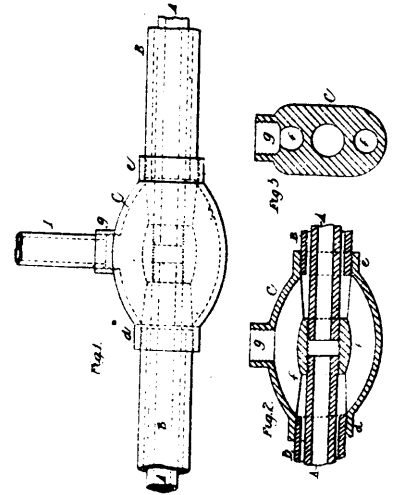
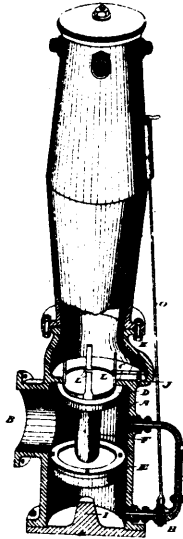

FIG. 1.

FIG. 2.



33522 Brownell's Road Vehicle.

33523 McNeill's Valve, etc.

33524 Hattery's Coupling for Pipes.

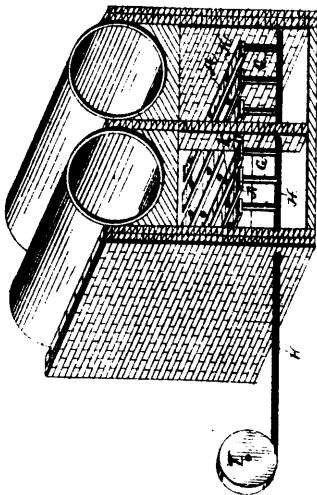

33525 Gordon's Grate.

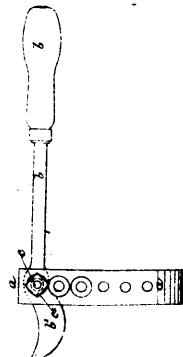
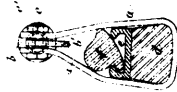

33526 Unevin's Tool or Apparatus for Inserting Rubber, etc.

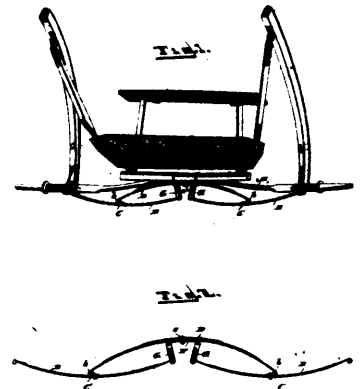

33527 Barrett's Vehicle Spring.