

5283 Haha's Hydraulic Crane.

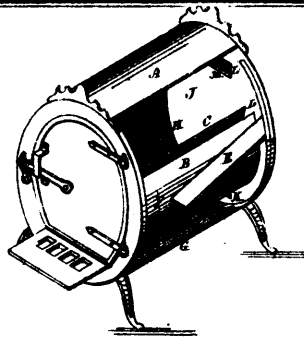

5284 Bettes' Heating Stoves.

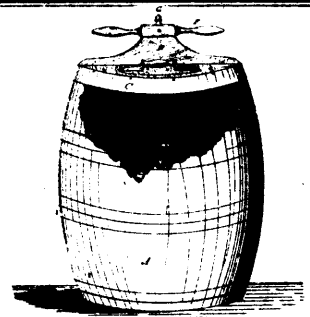

5285 Kane's Coal Ash Sifter.

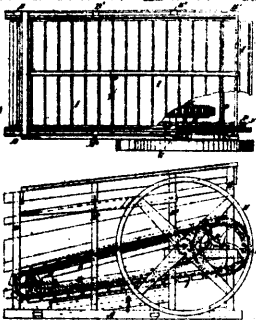

5286 Bellefeuille's Horse-power.

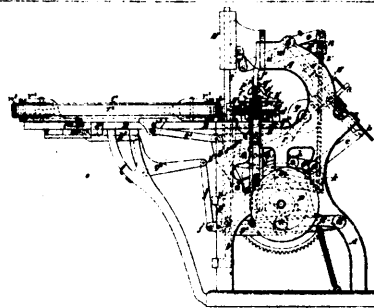

5287 Clarke's Paper Match Box Machine.

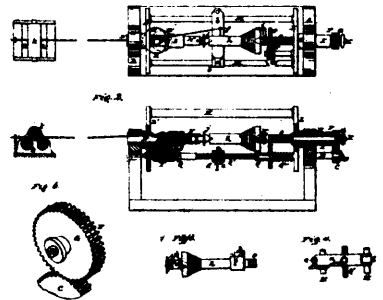

5288 Mattison & Shaw's Spinning Machine.

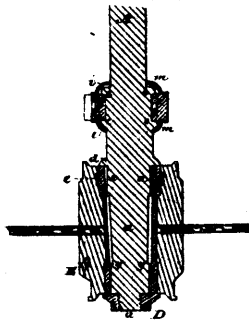

5289 Balkema & Beumer's Waggon Axle.

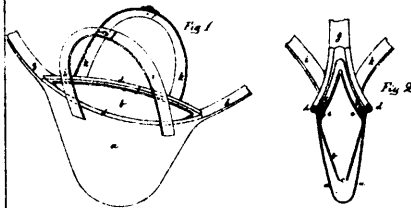

5270 Meacon's Catamential Sack.

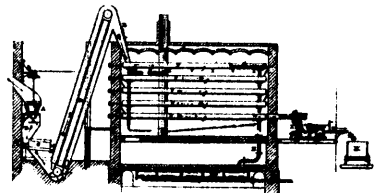

5271 Barthel & Smith's Peat Machine.

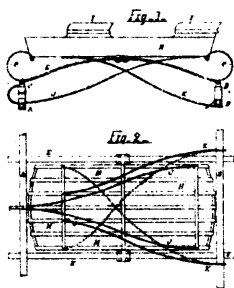

5272 Fisher's Improvements in Side-spring Vehicles.

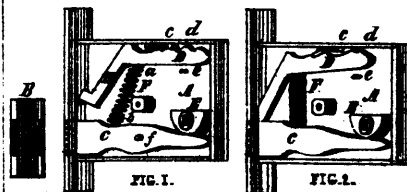

5273 Worster's Locking Latch.

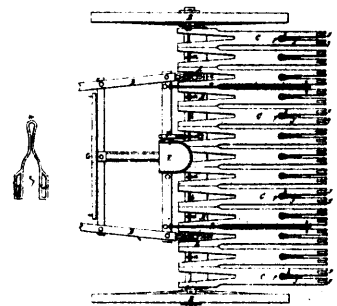

5274 Neal's Horse Hay Rake.

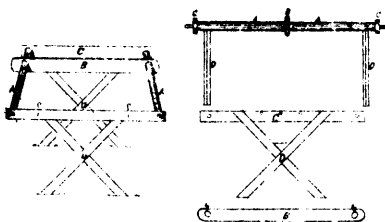

5275 Cornell's Quilting-frame.

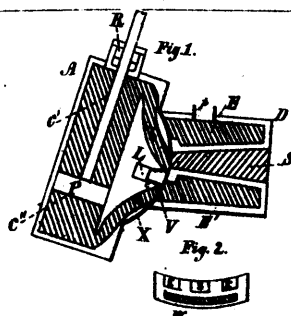

5276 Thurber's Oscillating Steam Engine.

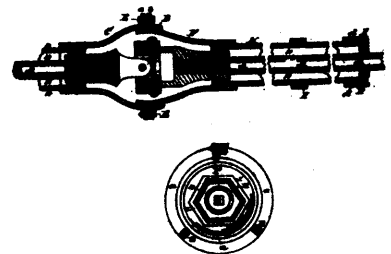

5277 Harriman's Tumbling Rod and Coupling Joint Covering.