

6739 Ferris Washing Machine.

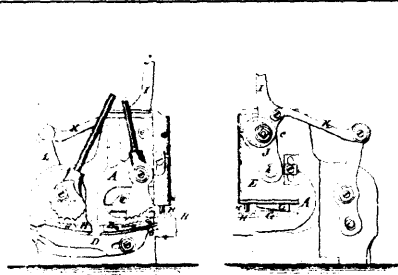

6740 Wheeler's Compound Metal Working Machine.

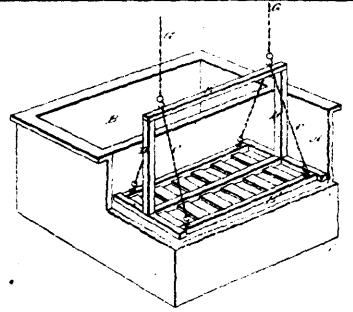

6741 Beate's Improvements in Drying Machines.

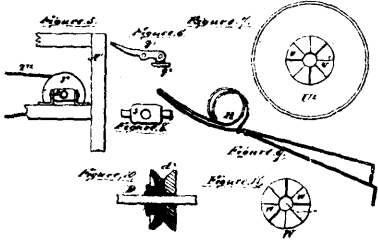

6742 Walrath and Bronson's Improvements on Broom Machines.

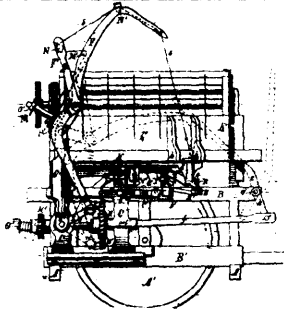

6743 Gordon's Improvements on Self-binding Harvesters.

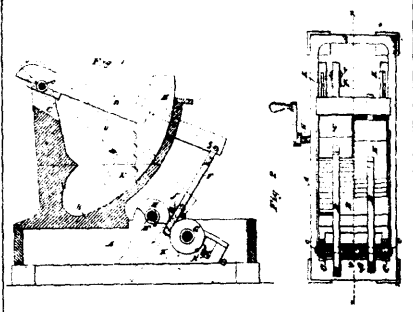

6744 Mase and Terwiliger's Fulling Mill.

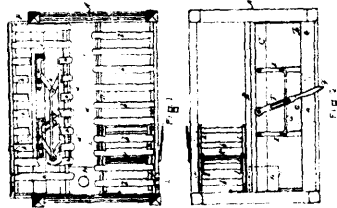

6745 Goodwin's Improvements on Iron and Bedsteads.

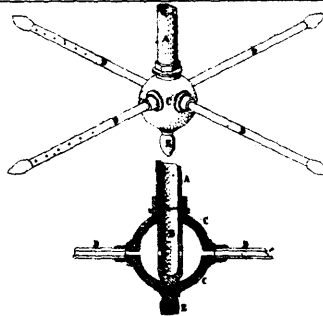

6746 Minhnick's Machine for Washing, Cooling and Purifying Petroleum.

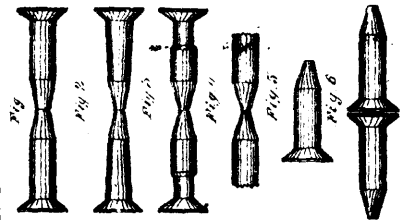

6747 Vanstone and Hoar's Improvements on Blanks of Screws and Bolts.

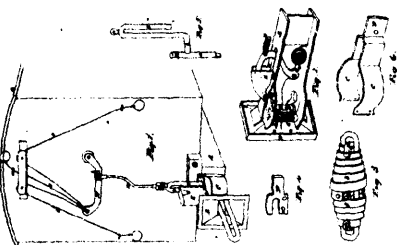

6748 Dolsen's Improvements on Car couplings.

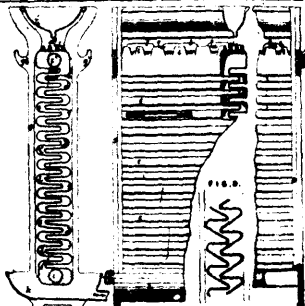

6749 Lawrence's Method of Heating and Refrigerating Liquids, and Apparatus therefor.

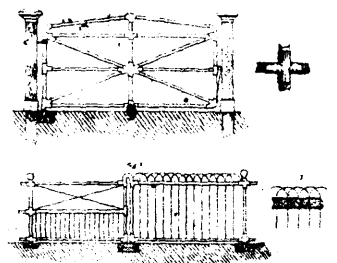

6750 Cleveland's Construction of Gates, Fences, and Railings.

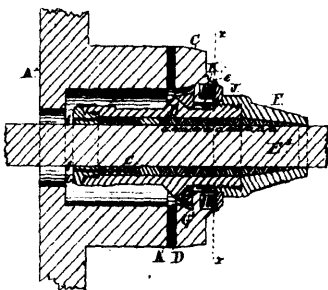

6751 Sleeper, Jerome and Hill's Improvements on Stuffing Boxes for Steam Engines.

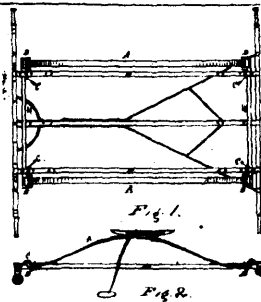

6752 McBride's Buggy Spring Coupling and Support.

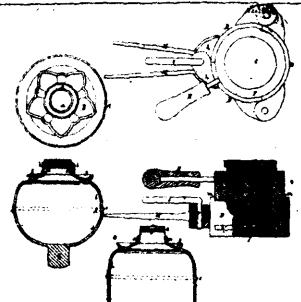

6753 Dillaway's Improvement in the Moulds and Manufacture of Glass Lamps.