

4202 Jones' Bed Spring.

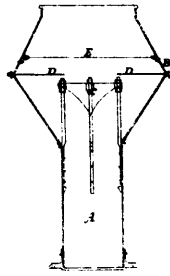

4204 Chrystie & Galt's Spark Arrester.

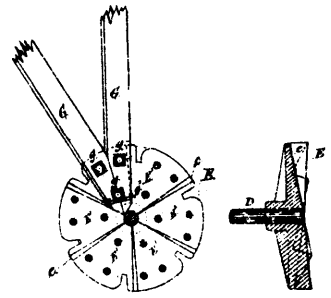

4205 Smith's Wind Wheel.

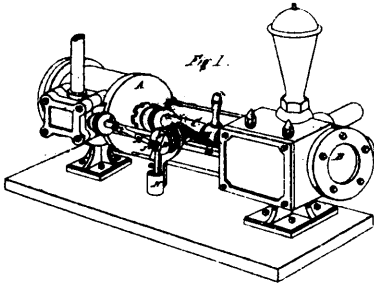

4206 Tesseyman & Smith's Improvements on Valve Gear.

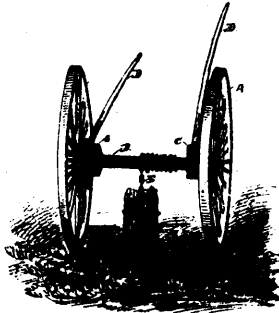

4207 Mackelcan's Machine for Pulling Stumps.

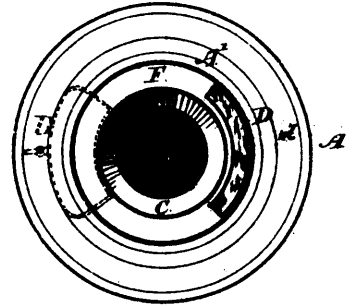

4208 Cassels' Improvements in Stoves.

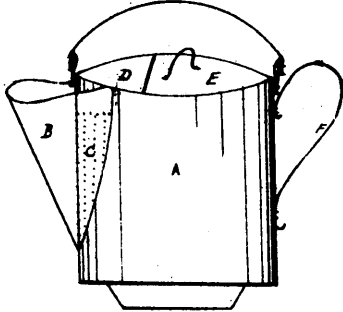

4209 Wilson's Vegetable Boiler.

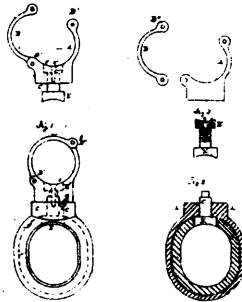

4210 Gibbs' Device for Connecting the Neck Yoke with the Draft Poles of Vehicles.

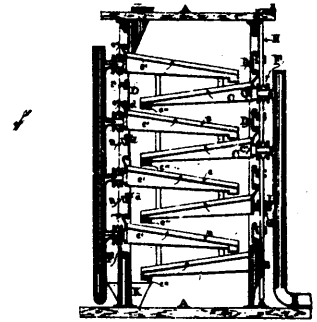

4211 May's Grain and Malt Drier.

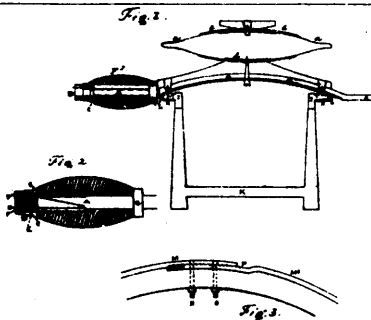

4212 White's Improvements on Carriages.

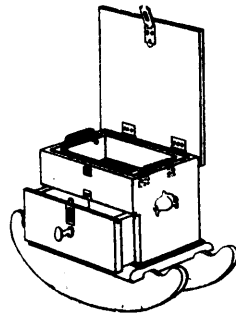

4213 Gavin's Screen for Coal Cinders.

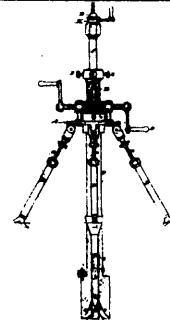

4214 Siprell's Rock Reamer.

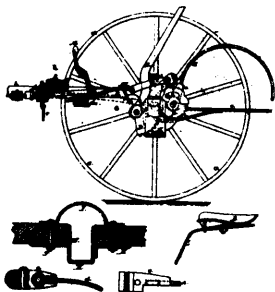

4216 Clinton, Mood & Gregg's Horse Rake.

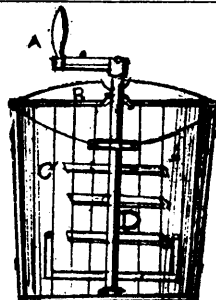

4217 Wattles' Vegetable Washer.

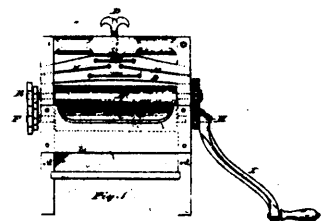

4218 Smith's Clothes Wringer.