

25659 Salomon's Friction Clutch

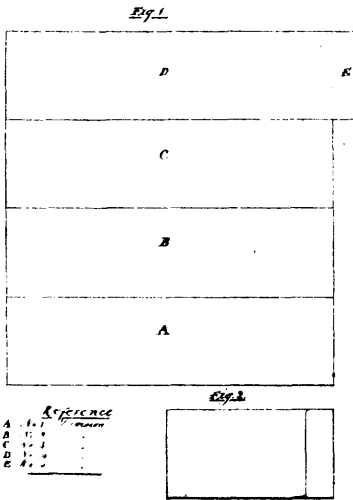

25660 Ames' Combined Envelope and Letter Sheet.

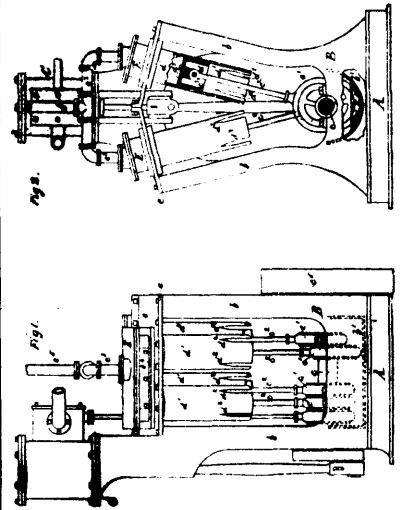

25661 Depp's Air Compressor.

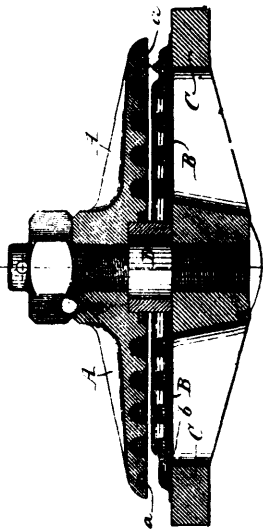

25662 Beldain's Pump Valve.

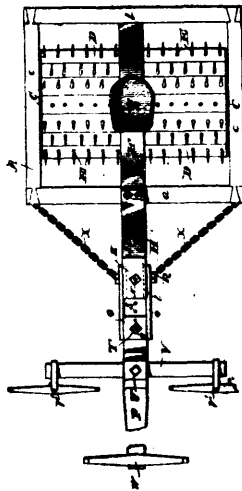

25663 Jett's Clod Crusher.

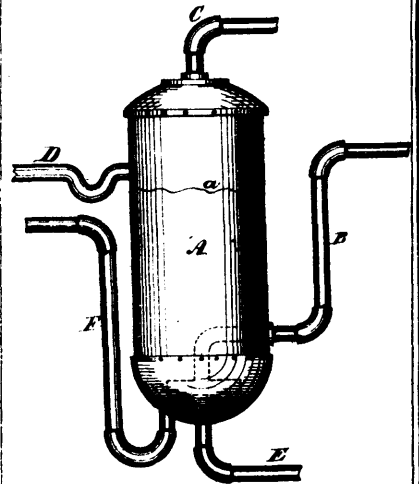

25664 Woodward's Apparatus for Increasing the Vapor Test of and Partially Purifying Petroleum Distillates.

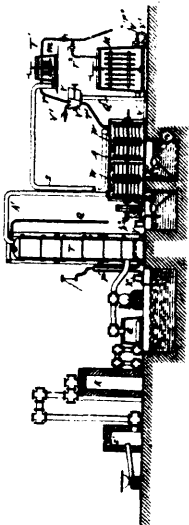

25665 Kitter's Apparatus for the Continuous Production of Sulphite of Lime, etc.

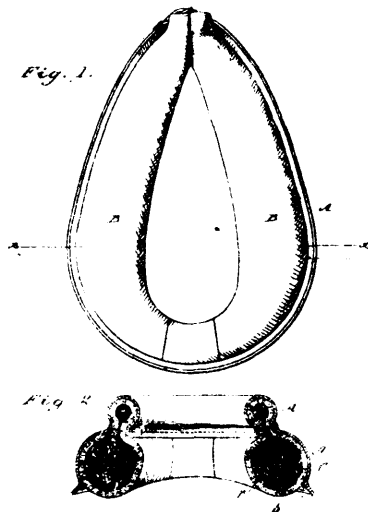

25666 Brook's Horse Collar.

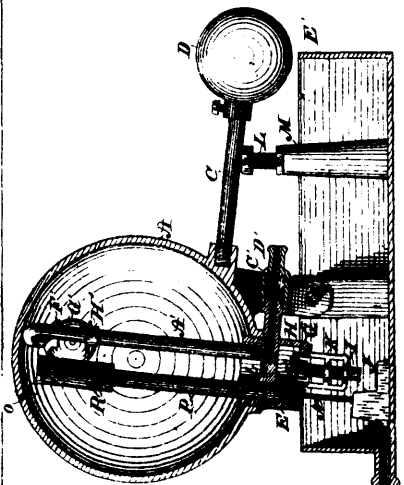

25667 Irwin's Hydraulic Air Compressor.