

6992 Clifford's Improvements on Grain Separators and Scourers.

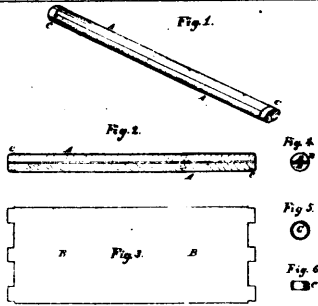

6993 McElbinney's Improvement in Blotting Rulers.

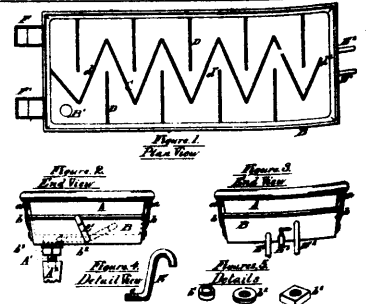

6994 Pierce's Improvements on Milk Pans and Coolers.

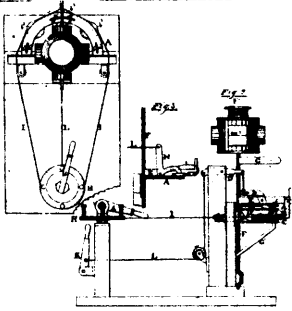

6995 Golden's Improvements in Railway Switches.

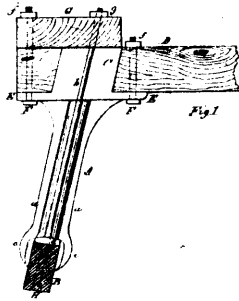

6996 Filuan's Improvements in Sleigh Knees.

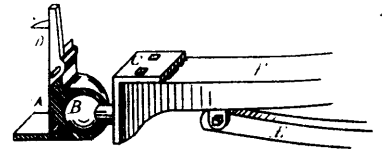

6997 Wilber's Improvements in Car Movers.

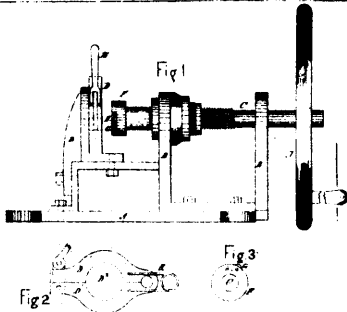

6998 Tarbox's Machine for Making Metal Screw Rings for Jars.

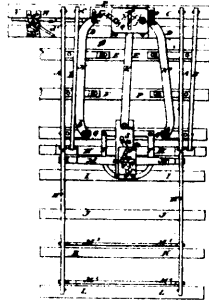

6999 Quimby's Improvements on Railway Switches.

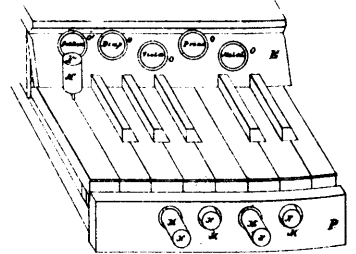

7000 Smith's Improvements on Organs.

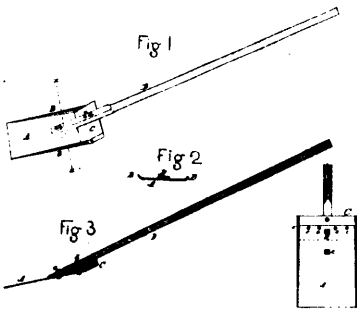

7001 Searle's Improvement in Snow Shovels.

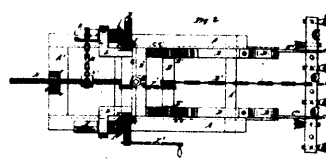

7002 Lechner & Jeffrey's Improvements on Mining Machines.

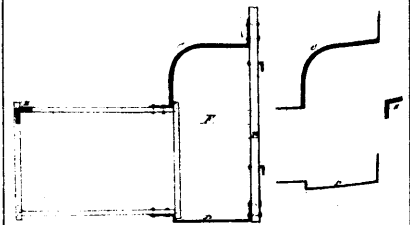

7003 Stephens' Improvements on Gates.

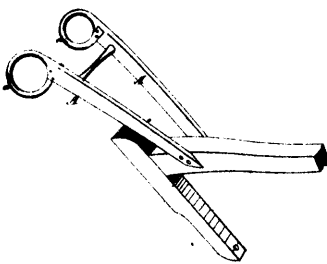

7004 Babcock's Improvements on Handles for Ploughs, &c.

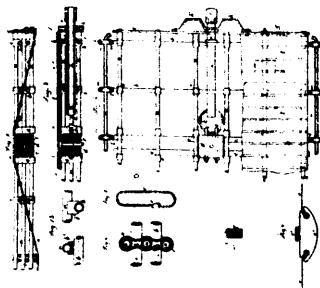

7005 LaMothe's Improvements on Railway Cars, &c.

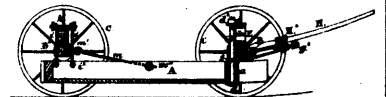

7006 Fish's Improvements on Milk Waggons.