

27074 Raymond's Button.

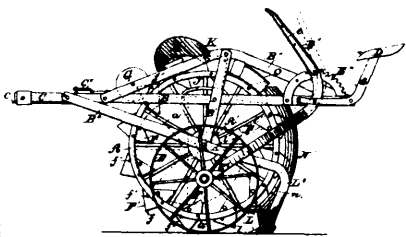

27075 Carter's Ditching and Excavating Machine.

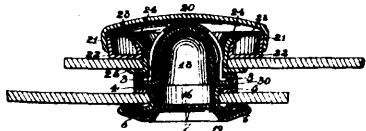
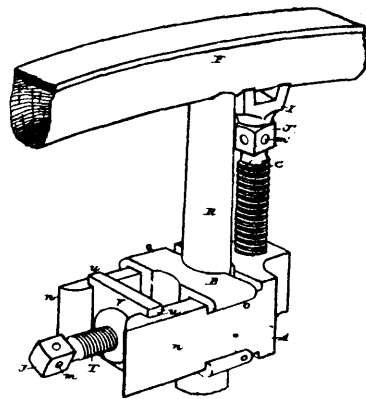
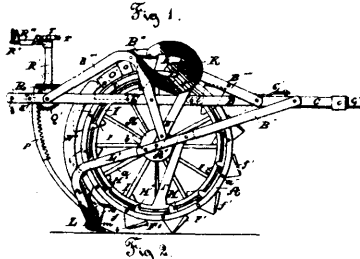

27077 Hammond's Machine for Tightening Wheels.

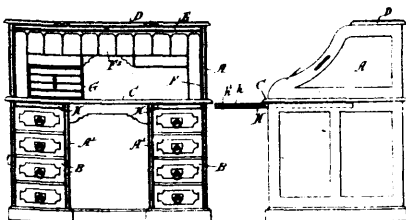

27078 Tees & Calder's Desk.

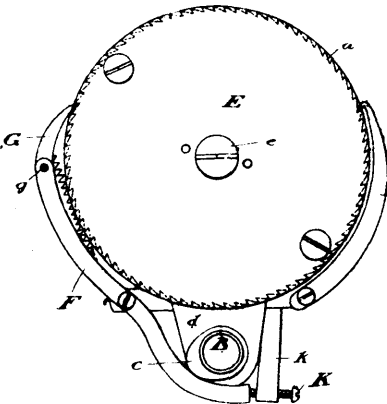
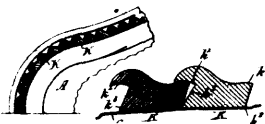

27079 Kitson's Counter to Register Shaft Revolutions.

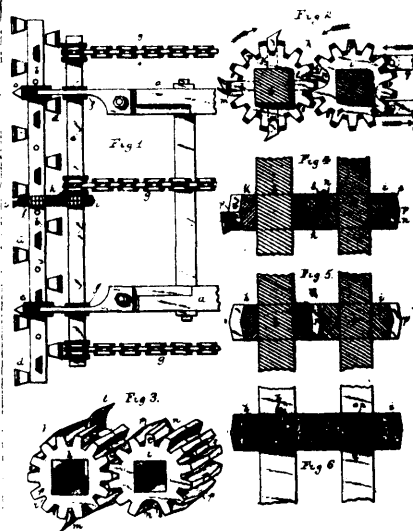

27080 Stine's Mining Machine.

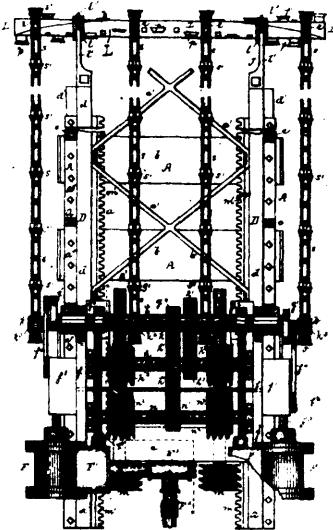

27081 Stine & Smith's mining Machine

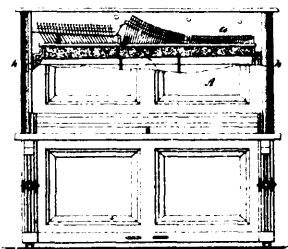

27082 Gmehlin's Mute Bar Damper for Upright Flaros.

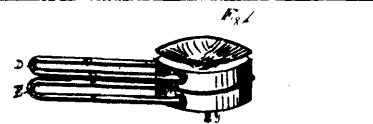
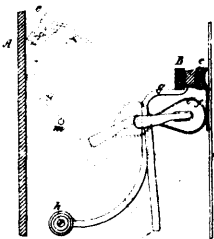

27083 Trueman & Bliss' Art of Telephony.

