

9788 Shepard's Improvements in Metallic Shingles.

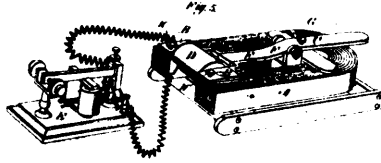

9739 Gary's Improvements on Telegraphic Transmitters.

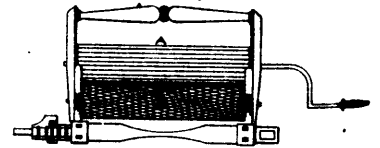

9791 Schoonmaker's Improvements in Washing Machines.

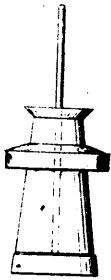

9792 Denman's Improvements on Churns.

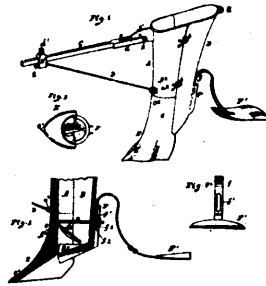

9793 Springer's Improvements on Seed Drills.

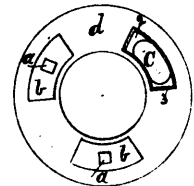

9794 Hayward's Improvements on Nut Locks.

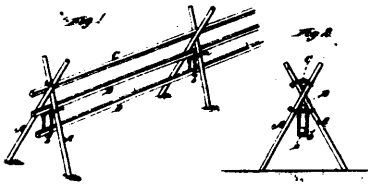

9795 Westcott & Gurley's Improvements on Fences.

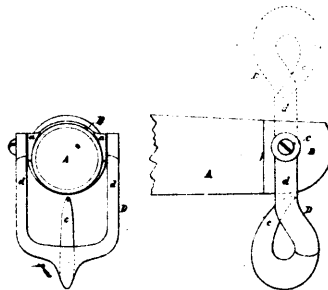

9796 Jackman's Improvements in Whiffletrees.

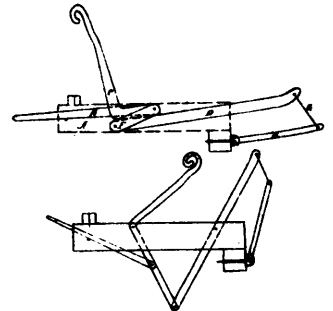

9797 Redden's Improvements on Horse Rakes.

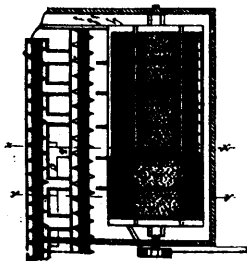

9798 Cranson's Improvements on Middlings Purifiers.

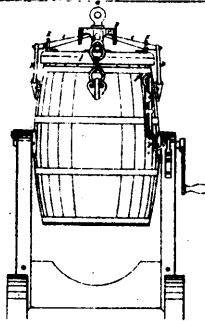

9799 Chadwick & Trumper's Improvements on Churns.

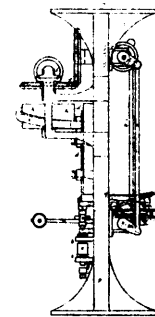

9800 Loeper's Apparatus for the Manufacture of Buttons.

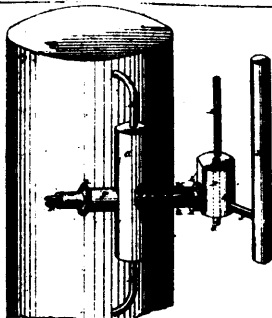

9801 Pool & Costner's Improvements in Steam Boilers.

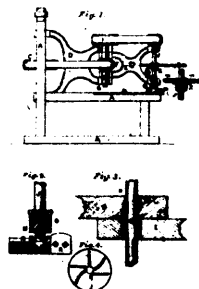

9802 Holcomb's Improvements on Machines for Fleshing Hides.

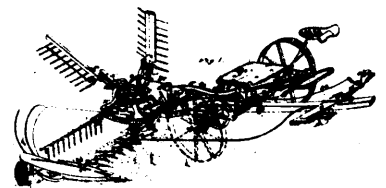

9803 Wheeler's Improvements on Reaping Machines.