

3665 Pew's Improvements on Peat Machine.

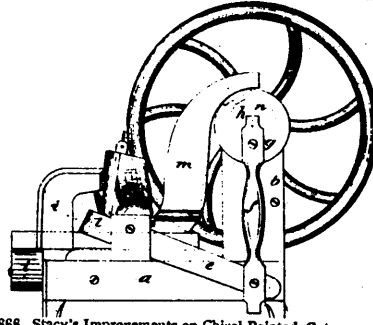

3666 Stacy's Improvements on Chisel Pointed Cut Nails and Machine for Making the same.

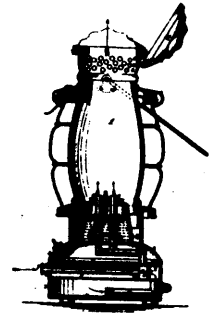

3667 Shaler's Signal Lantern.

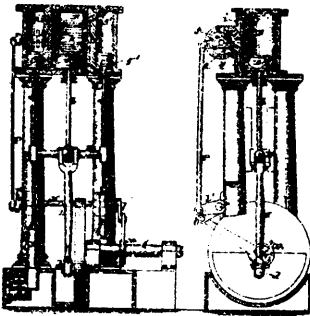

3668 Baxter's Improvements on Compound Engines.

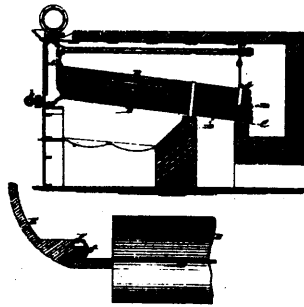

3669 Kelly's Improvements on Steam Generators.

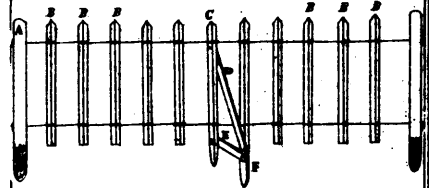

3670 Forsyth's Wire Fence.

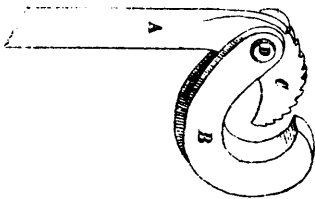

3671 Dunlop's Steam and Gas-fitting Wrench.

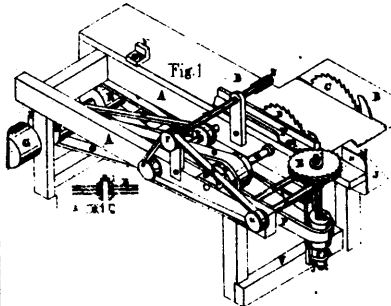

3672 Norton's Lath Machine.

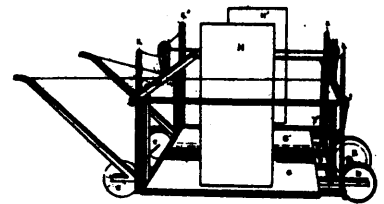

3673 Palmer's Machine for Destroying Potato Bugs.

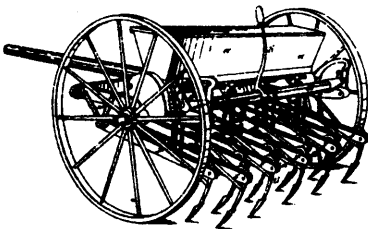

3674 Patric's Broad Cast Sowing Machine.



3675 Benner's Process of Veneering.

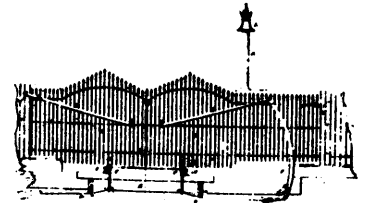

3676 McConnell's Self-opening Gate for Railway Crossings.

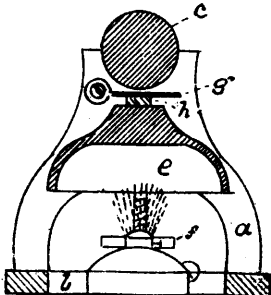

3677 Cantin's Photograph Burnisher.

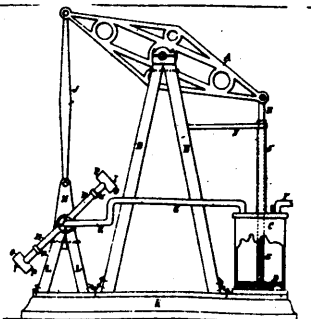

3678 Rourke's Automatic Atmospheric Engine.

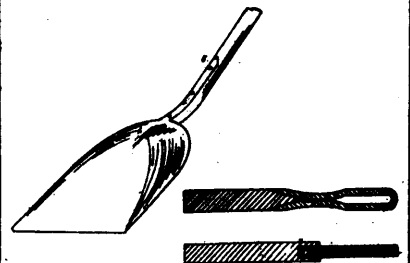

3680 Blake's Smooth Back Shovel.