

42430 Dodd's Setting Device for Saw Mill Carriages.

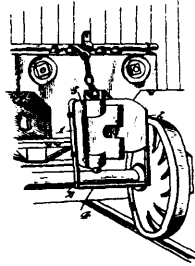

42431 Trammell's Car Coupler.

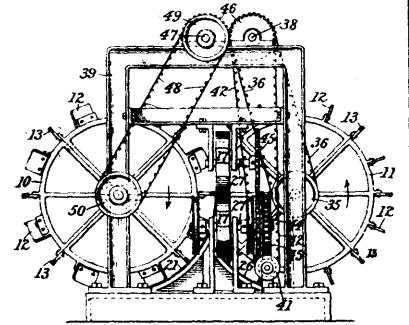

42432 Acosta's Fibre Preparing Machine.

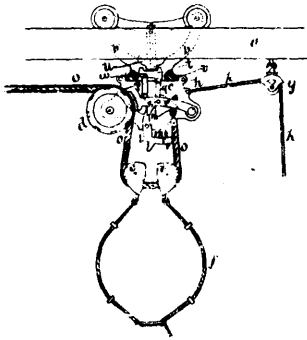

42433 Emerson and Campbell's Sling Carrier.

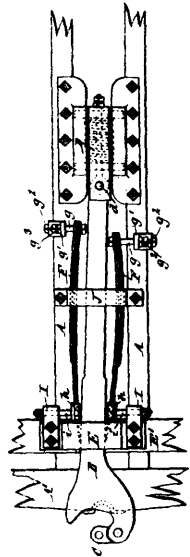

42434 Bissell's Draw Gear for Railway Cars.

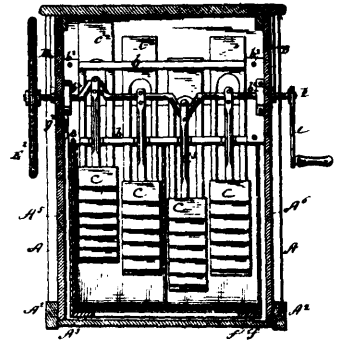

42435 Grondahl's Washing Machine.

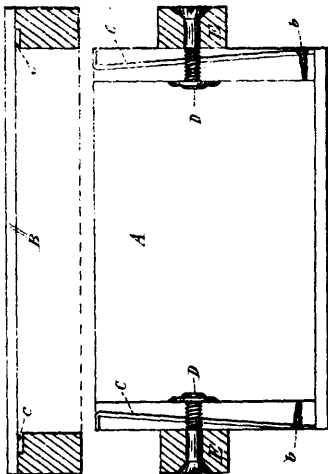

42436 Murley and Ritchie's Egg Case Fastener.

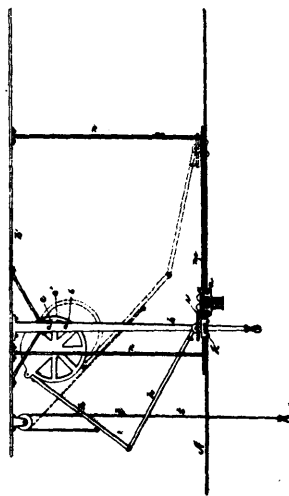

42437 Dillenbeck's Cash Carrier.

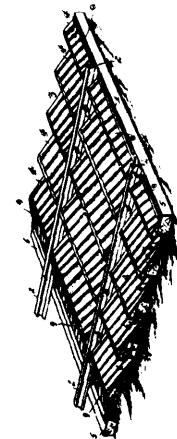

42438 Callaghan and Horn's Cattle Guard.