

27084 Woodward's Electric Belt.

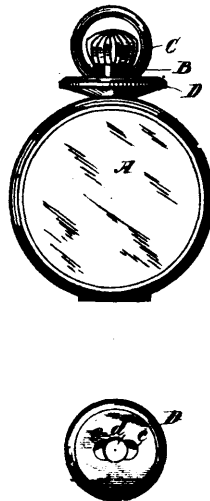

27085 Watts' Safe Guard for Watches.

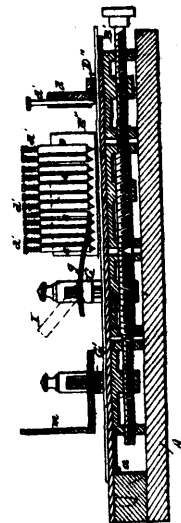

27086 Adler's Apparatus for Grading Shoe Soles and Uppers, etc.

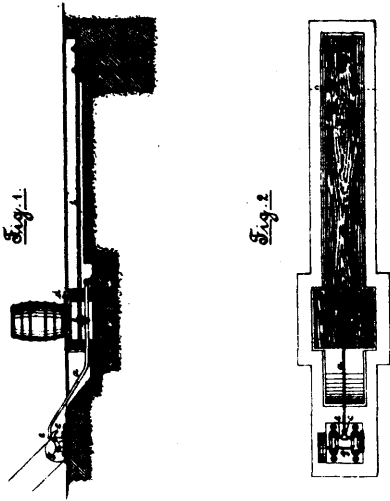

27087 Heylgenstaedt's Machine for Packing Tubs, Casks and Barrels.

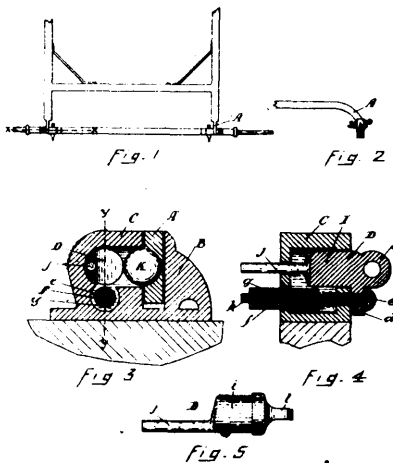

27088 Hanson's Carriage Shaft Coupling.

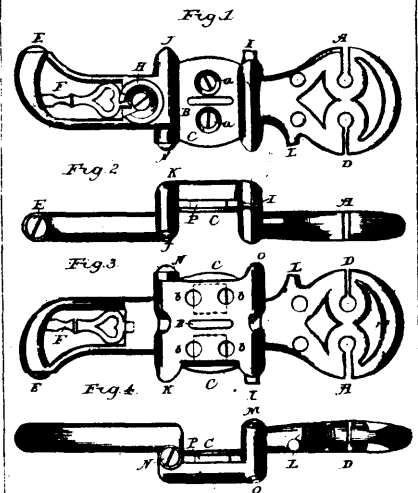

27089 Lalonde's Saw Set, Gauge and Baker Guide.

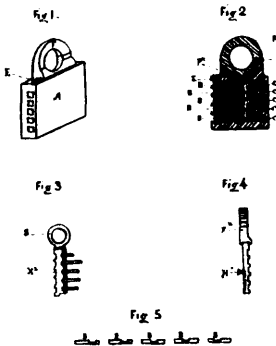

27090 Jenks' Padlock.

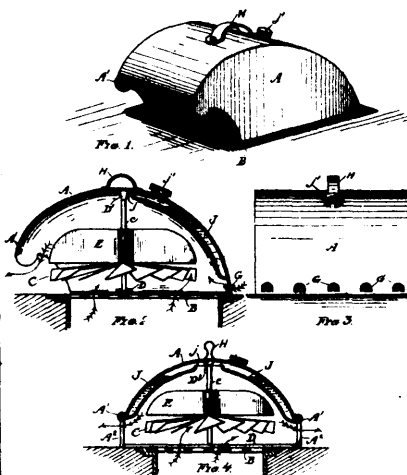

27091 Klein's Heat Deflector for Registers

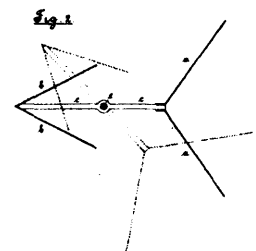
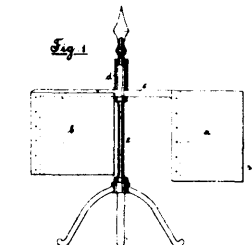

27092 Schaufuss' Double Flys for Weathercocks, etc.