

7879 Jones' Improvements on Blind Hinges.

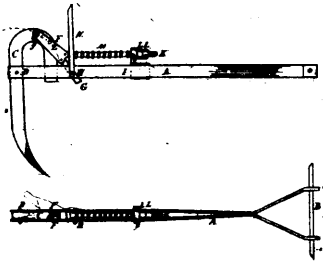

7880 Sheldon's Improvements on Cultivators and Sowers.

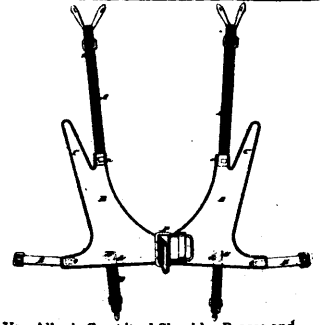

7881 Van Allen's Combined Shoulder Braces and Suspenders.

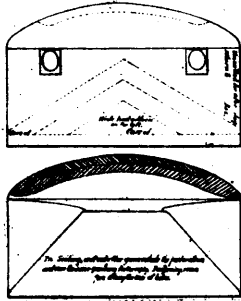

7882 Marshall's Improvements on a Letter Envelope.

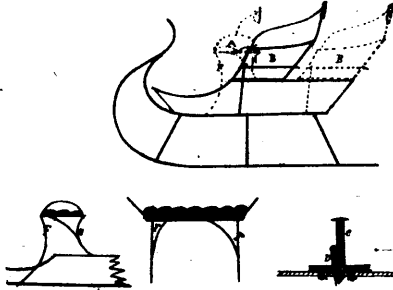

7883 Bristol's Improvements on Vehicle Seats.

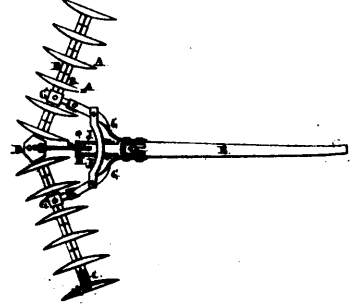

7884 La Dow's Improvements in Harrow Cultivators.

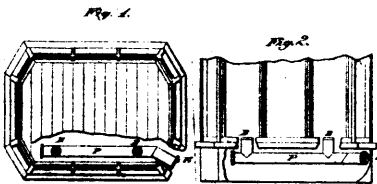

7885 Anthony & Manheim's Devices for Preventing the Accumulation of Frost and Steam upon Store Windows.

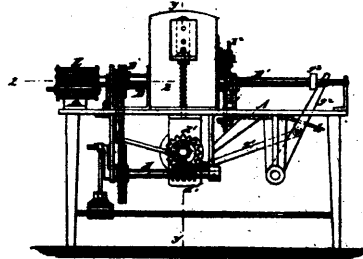

7886 Roberts' Improvements on Cigar Machines.

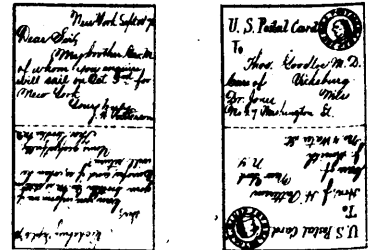

7887 Marshall's Improvements on a Postal Card.

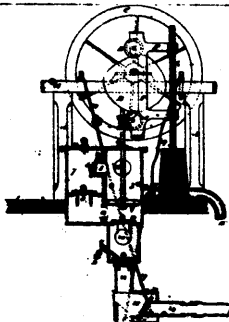

7888 Senders' Improvements on Ships' Pumps.

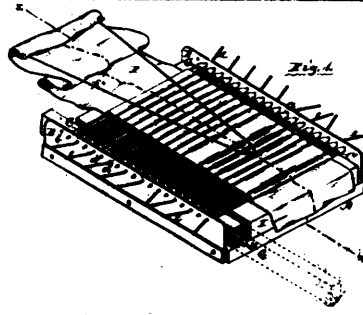

7889 Borriera's Improvements in Plating Machines.

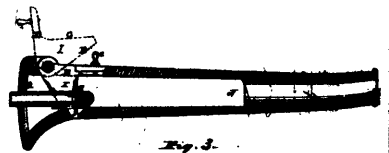

7890 Edwards' Improvements on Car-Couplings.

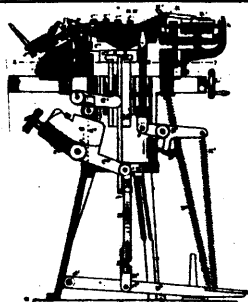

7891 Woodward & Brock's Lasting Machine for Boots and Shoes.

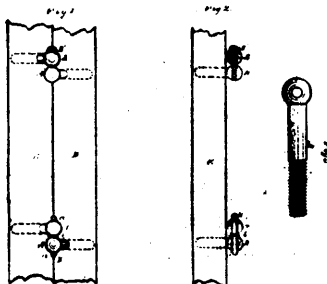

7892 Beaudet's Improvement on Hinges.

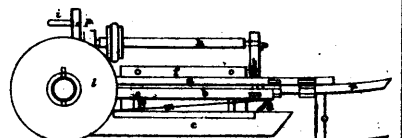

7893 Labelle's Machine for Gathering Potato Bugs.