

25055 Douglass's Vapour Generator.

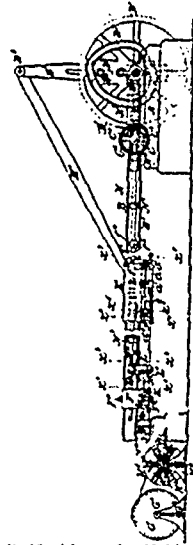

25066 Capel's Machinery for Making Bale Ties, etc.

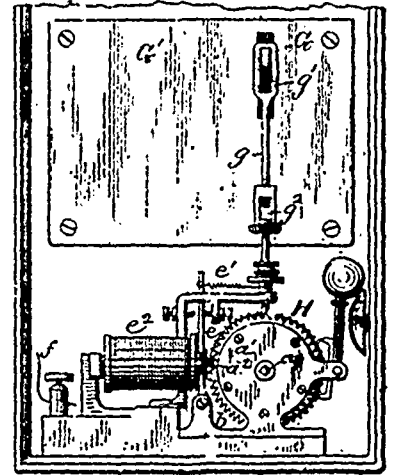

25067 Rogers's Fire Alarm Apparatus.

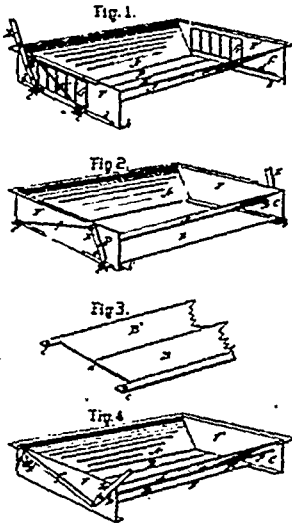

25058 Graham's Locomotive Ash Pan.

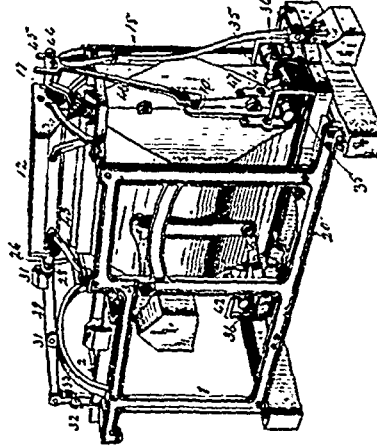

25069 Kuhlman's Automatic Grain Weighing Machine.

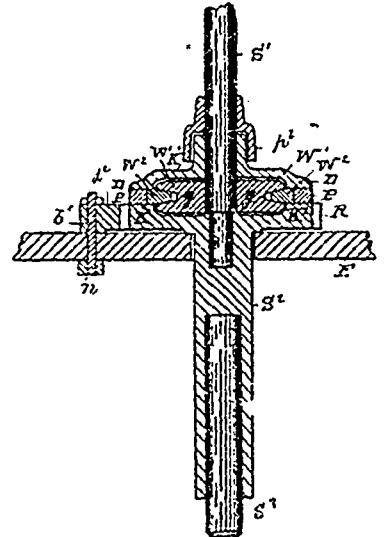

25070 Willson's Clutching Mechanism for Car Brakes.

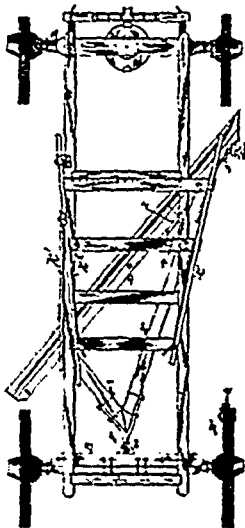

25071 Lathrop's Road Scraper.

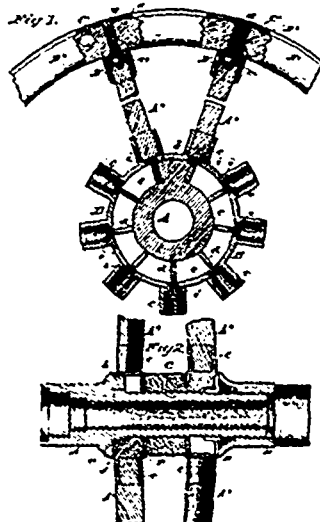

25072 Johnston's Vehicle Wheels.

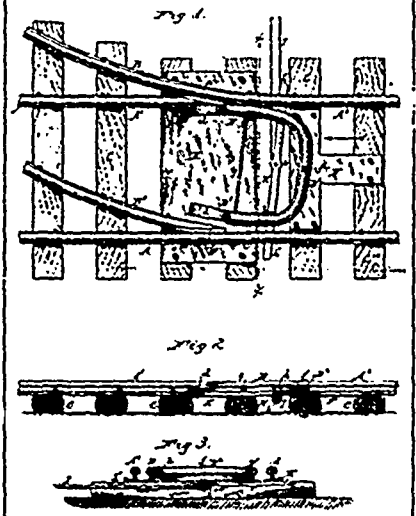

25073 Batt's Railway Switch.